

AiBOT Robotic Vacuum Cleaner

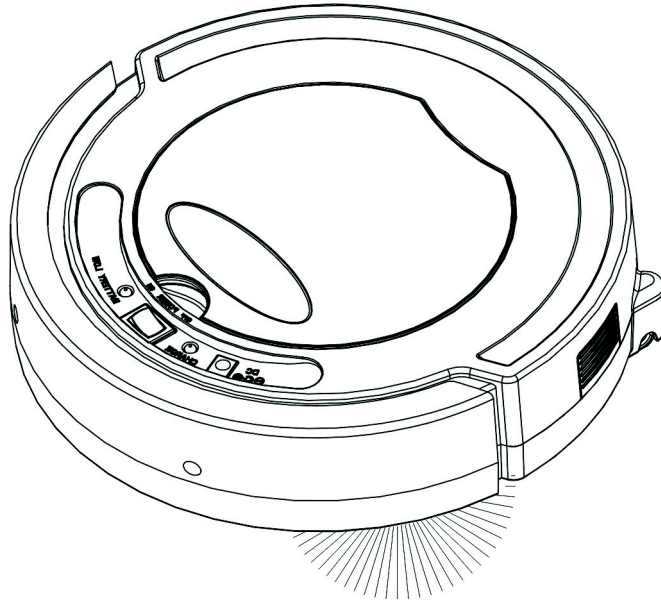

RC 310A User's Manual

TABLE OF CONTENTS

SAFETY ADVISORY	2
* Safety Precautions	
* Battery and Recharge Precautions	
SPECIAL FEATURES	4
MAJOR COMPONENTS AND ATTACHMENTS.....	4
RC 310A SERIES OVERVIEW	5
INSTALLATION GUIDE	6
* Installation of Side Brush	
* Using Dusting Paper	
* Battery Installation and Removal	
RECHARGING BATTERY	8
GENERAL OPERATION	8
* Preparation for Operation	
* Starting Operation	
MAINTENANCE AND CLEANING.....	9
* Maintenance	
* Cleaning The Dust Bin	
* Cleaning New Filter	
* Cleaning The Intake Valve	
* Cleaning The Side Brush	
TROUBLESHOOTING.....	13

SAFETY ADVISORY

Read the safety instructions in this User Manual before operating RC 310A SERIES (the robot') and keep this manual handy for your future reference.

Observe the basic safety rules to prevent any occurrence of fire, electric shock and personal injury.

Safety Precautions

1. Read the User Manual before operating the robot.
2. Do not operate the robot outdoors.
3. Do not operate the robot on wet floor or in moist environments, e.g. bathroom.
Water and moisture could damage the circuit board in the robot.
4. Prior to operation, remove any loose articles on the floor such as clothes, paper, loose cables and extension cords as well as making sure to lift curtains and drapes off the floor to avoid any possible accidents. In case of a loose cable is tangled with the robot, the cable might move around with the robot as it works and topple down the table, chairs, or cabinet and cause property damage.
5. Never stand or sit on the robot. Beware of children or pets while the robot is in operation.
6. Before starting the robot, make sure to install its dust bin and filter properly. If the robot is operated without its dust bin and filter properly installed, dust and dirt may be sucked into the chassis and cause damage to the robot.
7. Never use the robot to clean up almost lit cigarette butts or burning ashes from a fireplace.
8. Never use the robot to clean up combustible or highly volatile liquids such as gasoline.
9. While the robot is in operation, make sure all doors leading outside are closed.
10. During operation, the heat vent should never be clogged or covered up. Otherwise, the robot could be damaged due to overheating.
11. If the robot is malfunctioned or damaged by force, never operate again regardless the cause. Call your local dealer for advice.
12. Turn off the power and remove the battery from the robot if the unit will not be in use for a long period of time.

Battery and Recharge Precautions

1. Use the voltage and current specified on the packing. If you are not sure of the voltage and current of your house, contact your local power company or a licensed electrician.
2. An adaptor of d.c. 9V 300mA is required for the robot. Different voltage or current of the adaptor used may cause the unit malfunctioning.
3. Eight NI-MH AA size batteries (1200mAh or above) are required and NI-MH rechargeable batteries of the same brand and same series number are recommended. Do not mix batteries with different brands or different series numbers or it might cause damage to the robot.
4. Never use dry cell battery.
5. The charging adaptor is to be used indoors only.
6. Use only the charging adaptor supplied with your RC 310A.
7. Do not recharge the battery if the cable or plug of the battery is damaged.
8. Never touch the charger, plug or cable with damp hands.
9. If the robot requires cleaning, unplug the adaptor, switch off the power, and take out the batteries beforehand.
10. Take out the batteries before disposing of the unit.
11. Switch off the robot before taking out the batteries.
12. Recycle and dispose of the waste battery according to the law.

SPECIAL FEATURES

Thank you for purchasing the RC 310A Mini Vacuum Robot. This revolutionary mini vacuum robot is fully automatic and helps you take care of the vacuuming routine. It keeps your floor dust free, hair free and dirt free every day. The robot is suitable for cleaning floor surfaces such as wood, tile or linoleum. Easy to use, quiet and safe, this robot is definitely your best household helper!

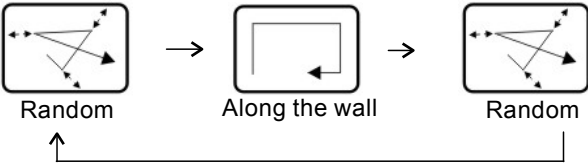

MAJOR COMPONENTS AND ATTACHMENTS

- 1.RC 310A Mini Vacuum Robot
- 2.Dust Bin Filter
- 3.Side Brush
- 4.Dust Holder
- 5.Adaptor DC9V, 300mA
- 6.Rechargeable “AA” Size Battery (8pcs)
- 7.Dust Paper x 3
- 8.Multi-languages User Manual (CD-ROM)
- 9.Multi-language Quick Guide

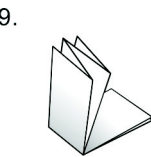
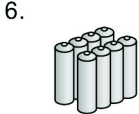
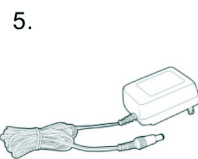
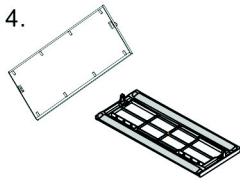
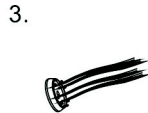
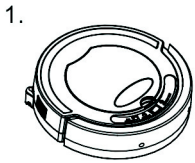

RC 310A OVER VIEW

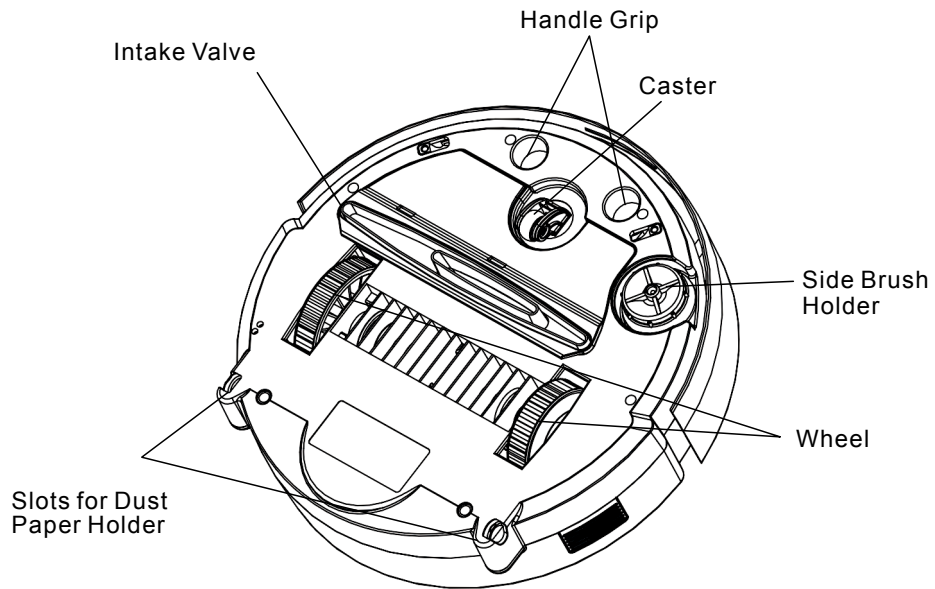
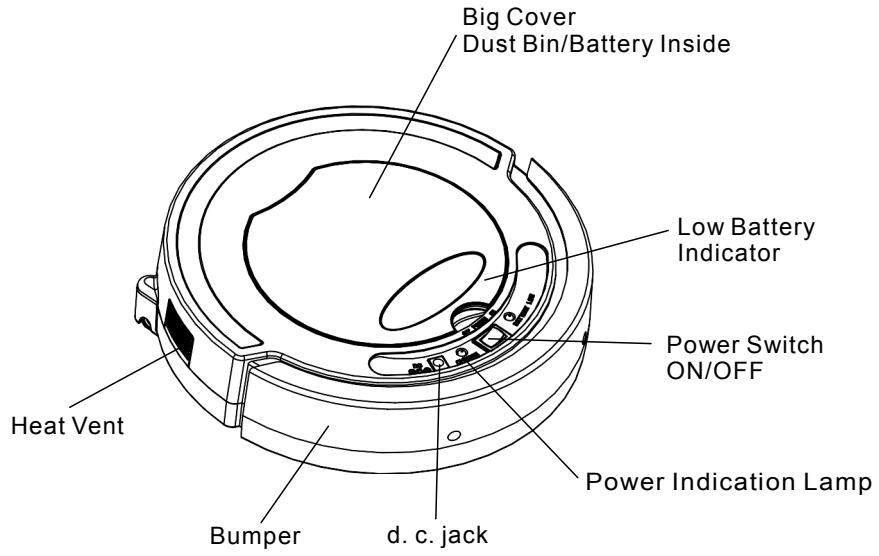

INSTALLATION GUIDE

Installation of Side Brush

1. Put the brushes in the holders then mount the brush as shown in Fig.

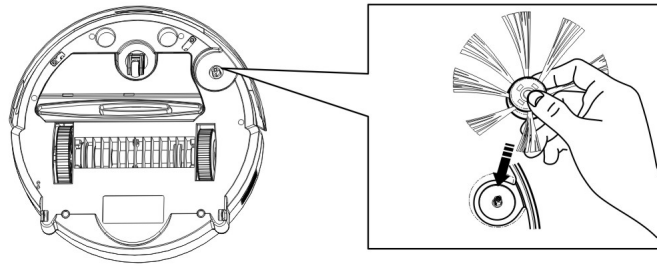

Using Dust Paper

1. Remove the Paper Holder

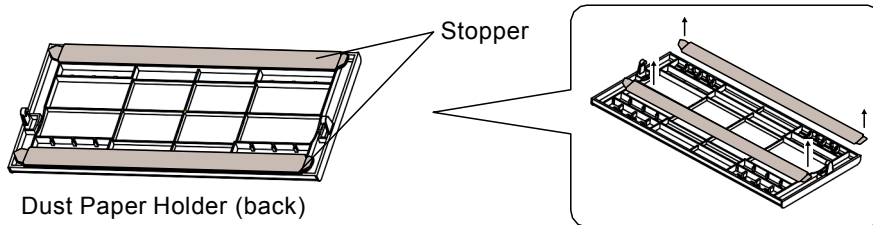

2. Make sure the dust paper is flat and place it in the holder, then fold the border of the dust paper and press it with the stopper into the dust paper holder.

