

PLEASE THINK BEFORE YOU PRINT

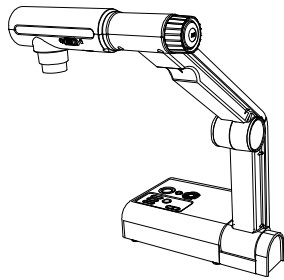

SMART Document Camera 330

User's Guide

Extraordinary made simple™



Product registration

If you register your SMART product, we'll notify you of new features and software upgrades.

Register online at smarttech.com/Product+Registration.

Keep the following information available in case you need to contact SMART Technical Support.

Serial Number: _____

Date of Purchase: _____

FCC warning

This equipment has been tested and found to comply with the limits for a Class B digital device, pursuant to Part 15 of the FCC Rules. These limits are designed to provide reasonable protection against harmful interference in a residential installation. This equipment generates, uses, and can radiate radio frequency energy and, if not installed and used in accordance with the instructions, may cause harmful interference to radio or television reception. However, there is no guarantee that interference will not occur in a particular installation. If this equipment does cause interference to radio and television reception, which can be determined by turning the equipment off and on, the user is encouraged to try to correct the interference by one or more of the following measures.

- Reorient or relocate the receiving antenna.
- Increase the separation between the equipment and receiver.
- Connect the equipment into an outlet on a circuit different from that to which the receiver is connected.
- Consult the dealer or an experienced radio/TV technician for help.

User installer caution

Your authority to operate this FCC verified equipment could be voided if you make changes or modifications not expressly approved by the party responsible for compliance to Part 15 of the FCC rules.

Trademark notice

The SMART logo, SMART Board, SMART Notebook and smarttech are trademarks or registered trademarks of SMART Technologies ULC in the U.S. and/or other countries. All third-party product and company names may be trademarks of their respective owners.

Copyright notice

©2010 SMART Technologies ULC. All rights reserved. No part of this publication may be reproduced, transmitted, transcribed, stored in a retrieval system or translated into any language in any form by any means without the prior written consent of SMART Technologies ULC. Information in this manual is subject to change without notice and does not represent a commitment on the part of SMART.

Patent notice

Patents pending.

Important information

WARNING

- Failure to follow the installation instructions shipped with your SMART product can result in personal injury and damage to the product.
- Ensure that any cables extending across the floor to your SMART product are properly bundled and marked to avoid a trip hazard.
- Do not push foreign objects into the openings on your document camera.
- Do not open or disassemble your SMART product. You risk electrical shock from high voltage. Opening the casing also voids your warranty.
- The camera arm on your SMART product has joints that present a pinch hazard when you move the camera arm. Keep clear of the pinch points.
- Do not stare into the lamp or shine the lamp directly into someone's eyes. Turn off the lamp when displaying or capturing images of people.
- Do not overload power outlets or extension cords as this can result in a fire or electric shock.
- Turn off and disconnect your SMART product before a thunderstorm. During a thunderstorm, do not touch your SMART product or the power plug because there is a risk of electrical shock.
- To reduce the risk of fire or electric shock, do not expose your SMART product to rain or moisture.

CAUTION

- Place your SMART product on a solid surface to prevent it from falling.
- If you have a security cable attached to your SMART product, do not carry or swing your SMART product by the security cable.
- Do not connect non-shielded interface cables to your SMART product and do not leave cables connected to unused connectors because this can cause interference levels that exceed FCC regulations.
- Do not set up and use your SMART product in an area with excessive levels of dust, humidity or smoke or near heat sources.
- Do not block or cover the openings or slots on your SMART product. These slots provide ventilation, ensure reliable operation and protect your SMART product from overheating.

- Do not carry your SMART product by the camera arm. Carry it by the base of the unit.
- Disconnect your SMART product from the power outlet before cleaning it. Use a clean damp cloth and do not use liquid or aerosol cleaners or solvents when cleaning your SMART product.
- Only use your SMART product with the type of power source that is written on the power supply and do not modify the plug.
- Do not aim the camera lens at the sun.
- When replacing parts in your document camera, ensure your service technician uses only replacement parts specified by the manufacturer or parts with the same characteristics as the original part. Unauthorized substitutions may result in fire, electric shock or other hazards.

Contents

	Important information.....	i
1	Overview	1
	About your SMART Document Camera 330.....	1
	Parts of the document camera.....	3
	Document camera software.....	6
2	Setting up your document camera	7
	Document camera basic connection.....	8
	Setup configurations for Camera view and SD Card view.....	9
	Connecting your document camera to an external display.....	10
	Downloading software	12
3	Using your document camera	13
	Understanding Computer, Camera and SD Card views	14
	Performing basic operations	16
	Using your document camera with SMART Notebook software.....	19
4	Using your document camera in Computer view	21
	About Computer view	21
5	Using your document camera in Camera view	23
	About Camera view	23
	Setting Camera view.....	24
	Using the Camera view's on-screen display menu.....	25
	Saving images to an SD or SDHC memory card.....	35
6	Using your document camera in SD Card view	37
	Using the SD Card view display	38

	Using the SD Card view on-screen display menu	38
7	Troubleshooting	45
A	Hardware environmental compliance	47
	Waste Electrical and Electronic Equipment regulations (WEEE directive)....	47
	Restriction of Certain Hazardous Substances (RoHS directive)	47
	Packaging	48
	China’s Electronic Information Products Regulations (EIP)	48
	U.S. Consumer Product Safety Improvement Act	48
B	Customer support	49
	Online information and support	49
	Training	49
	Technical support	49
	Shipping and repair status	49
	General inquiries	50
	Warranty	50
	Registration	50

Chapter 1

Overview

About your SMART Document Camera 330

Your SMART Document Camera 330 allows you to display 3D objects, printed documents and microscope slides on your computer, projector or television. You can capture images and save them to a SMART Notebook™ collaborative learning software file or to an SD or SDHC memory card.

Your document camera integrates with SMART Notebook software and SMART Board™ interactive whiteboards, creating an interactive presentation environment.

Topics in this chapter include:

- *Document camera features* on page 2
- *Document camera views* on page 2
- *Parts of the document camera* on page 3
 - *Adjustable camera arm and camera head* on page 3
 - *Control panel* on page 4
 - *Rear connection panel* on page 4
 - *Side connection panel* on page 5
 - *NTSC/PAL switch* on page 5
 - *Power supply* on page 5
 - *USB cable* on page 5
 - *VGA cable* on page 5
 - *Anti-glare sheet* on page 6
- *Document camera software* on page 6
 - *SMART Notebook software and SMART Product Drivers* on page 6
 - *Image Mate Software* on page 6

Document camera features

Camera

- High resolution 1.3 MP CMOS sensor
- 5.2x optical zoom, 8.0x digital zoom
- Up to 30 frames per second
- Automatic or manual focus
- Microscope mode that doesn't require adapters

Output

- SXGA, WXGA, 720p or XGA resolution
- DVI-D output

Physical construction

- Security lock slot
- Collapsible design for easy transport and storage
- Bright LED camera lamp

Software

- SMART Notebook software
- SMART Board Product Drivers
- Image Mate® Software

Image storage

- Supports SD or SDHC memory cards with a built-in SD slot
- Supports USB memory sticks with a built in USB hub
- Supports image storage on connected computer

Document camera views

Your document camera has three views you can use to control how it sends data to a computer, projector or television.

- Computer view displays images from your document camera only in a SMART Notebook file on your computer.
- Camera view controls your document camera from the camera's control panel and displays images on a projector or television. You can also view images through SMART Notebook.

- SD Card view controls your document camera from the camera's control panel and displays images from an SD or SDHC memory card on a connected projector or television.

See *Understanding Computer, Camera and SD Card views* on page 14 for more information on these views.

Parts of the document camera

Adjustable camera arm and camera head

You can unfold and adjust the camera arm. You can also rotate the camera head to display objects at range of angles. The camera head has a zoom dial, auto focus button and an LED camera light with a light switch.

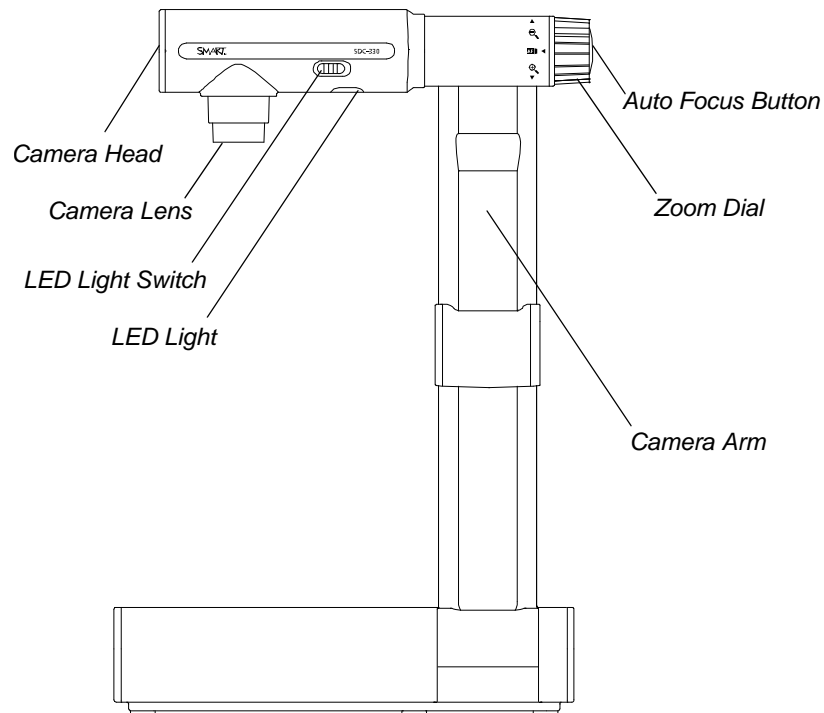

Control panel

You can use the control panel to switch between Computer, Camera and SD Card view, capture an image to an SD or SDHC memory card and adjust brightness settings. You can also use it to control features and settings in the Camera view or the SD Card view's on-screen display menu.

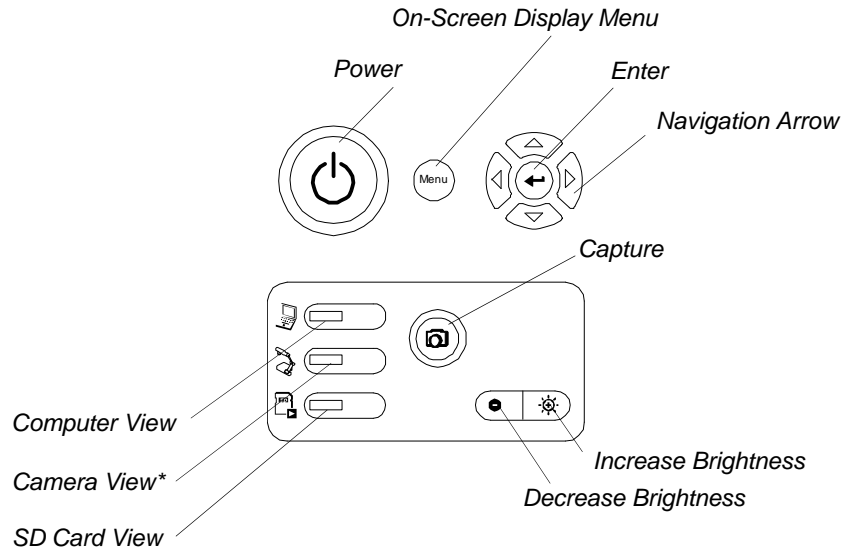

*On some cameras, Camera View is represented by a  symbol.

Use the control panel to select Computer, Camera or SD Card view. For information on views, see *Understanding Computer, Camera and SD Card views* on page 14.

Rear connection panel

The rear connection panel has 12V DC, DVI-D Out, VGA Out, VGA In, Composite video out and USB-B connectors.

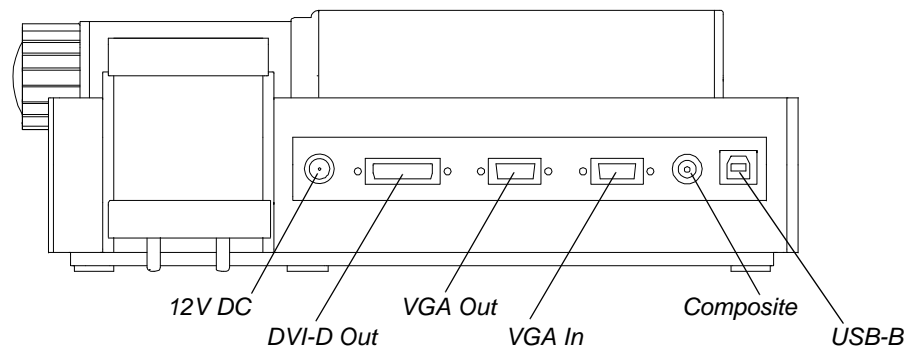

Side connection panel

The side connection panel has a security lock slot, an SD or SDHC memory card slot, a USB-A connector, a switch for selecting VGA, DVI-D or composite video output, and a switch to select either SXGA, WXGA, 720p or XGA resolution.

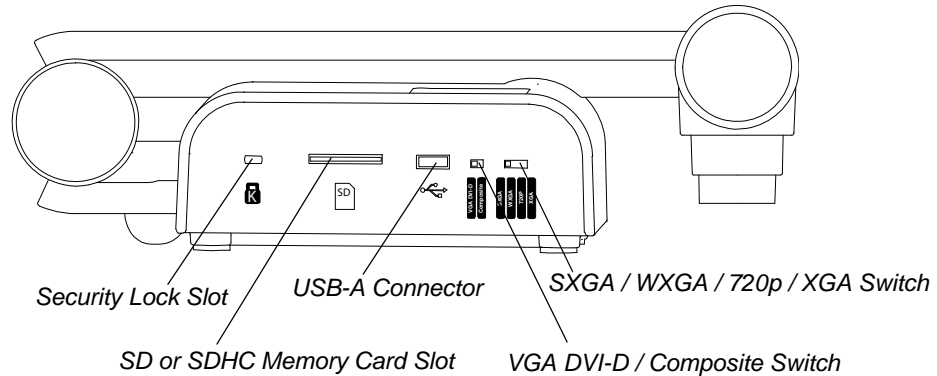

NTSC/PAL switch

The NTSC/PAL switch is located on the bottom of your document camera. This switch enables you to change the format of composite video output for your television. See *Switching between NTSC and PAL* on page 11.

Power supply

Your document camera comes with a power supply and a country-specific power cable.

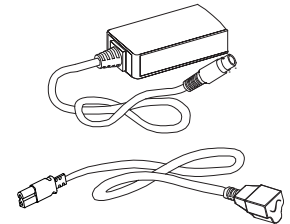

USB cable

Use the USB cable to connect your document camera to your computer. You can display objects, capture images to SMART Notebook files and control your document camera from SMART Notebook software.

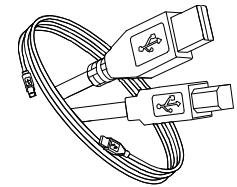

VGA cable

Use the VGA cable to connect your document camera to a projector or display. You can display objects, capture images to an SD or SDHC memory card and use the features in the on-screen display menus.

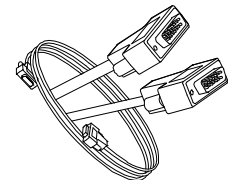

Anti-glare sheet

Place the anti-glare sheet over printed documents to reduce glare.



Document camera software

Your document camera includes software downloads that will help you present images from your document camera.

SMART Notebook software and SMART Product Drivers

Your document camera uses SMART Notebook collaborative learning software and SMART Product Drivers. SMART Notebook is presentation software designed to work with SMART Document Cameras and the touch features of SMART Board interactive whiteboards.

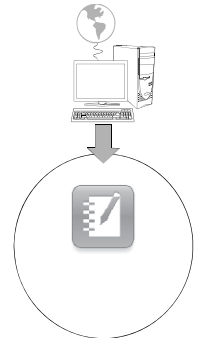

You can download SMART Notebook and SMART Product Drivers at smarttech.com/us/Support/Browse+Support/Download+Software.

You can find system requirements for your computer in the SMART Notebook 10 release notes www2.smarttech.com/kbdoc/126571.

Image Mate Software

You can use your document camera with Image Mate® software. Visit SMART's download page at smarttech.com/us/Support/Browse+Support/Download+Software to download Image Mate software.

Chapter 2

Setting up your document camera

This chapter describes the following set up tasks for your document camera:

- *Document camera basic connection* on page 8
- *Setup configurations for Camera view and SD Card view* on page 9
 - *The document camera and computer use different displays* on page 9
 - *The document camera and computer share a display* on page 9
- *Connecting your document camera to an external display* on page 10
 - *Connecting to a projector or flat-panel display* on page 10
 - *Connecting your document camera to a television* on page 11
 - *Connecting to a digital projector or HD display with DVI-D* on page 11
 - *Setting output resolution* on page 12
- *Downloading software* on page 12
 - *Installing SMART Notebook software and SMART Product Drivers* on page 12
 - *Installing Image Mate software* on page 12

Document camera basic connection

Connect your document camera to a power supply and your computer to use your document camera with SMART Notebook software.

IMPORTANT

This configuration requires SMART Notebook to use your document camera. Connect your document camera directly to an external display to use Camera view or SD Card view.

To connect the power supply

1. Connect the power supply cable to the **12V DC** receptacle on the rear connection panel.

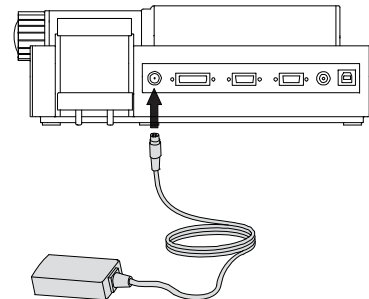

2. Connect a country-specific power cable to the power supply, and then connect the plug to a power outlet.

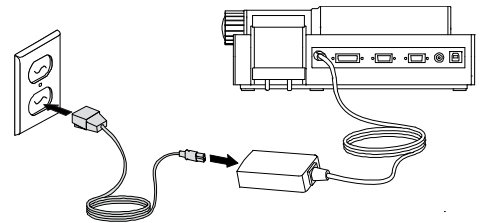

CAUTION

Ensure you connect the power cable to the power supply before connecting the power plug to a power outlet.

To connect your document camera to your computer

Connect the USB-B plug of your USB cable to your document camera, and then connect the USB-A plug to your computer.

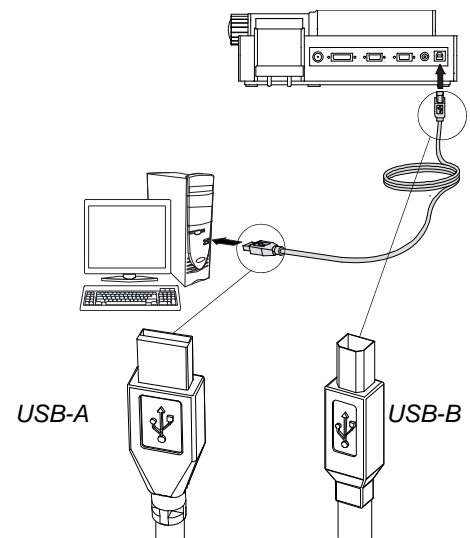

Setup configurations for Camera view and SD Card view

After you complete the basic connection procedure (see page 8), you can connect your document camera to an external display. This enables you to use the document camera in Camera view and SD Card view. See page 14.

You can connect your computer and your document camera to different displays or they can share a display.

The document camera and computer use different displays

In this configuration your document camera images appear on one display, and your computer's desktop appears on the other display. You can also access document camera images through SMART Notebook on your computer.

To connect your document camera and computer to different displays

1. Complete the basic connection steps (see page 8).
2. Connect your computer or laptop to the projector of an interactive display.



NOTE

This is the normal configuration for using interactive whiteboards.

3. Connect your document camera to another external display. See page 10.

The document camera and computer share a display

In this configuration your document camera is connected to your computer with both a USB and a VGA cable. Your document camera is connected to an external display.

To connect your document camera and computer to a shared display

1. Complete the basic connection steps (see page 8).
2. Connect your computer's VGA Out port to your document camera's VGA In port with a VGA cable.
3. Connect your document camera to an external display with a VGA cable. See page 10.



NOTE

DVI-D or composite video displays will not display your computer view. A VGA display is required.

This configuration will permit easy transition from Computer view to Camera view or SD Card view, using the same projector or display for all three views.

Connecting your document camera to an external display

You can connect your document camera directly to an external display to enable the following functions:

- Use Camera view to view the camera image in full-screen on the external display.
- Use SD Card view to view a full-screen slide show on the external display.
- Access the Camera view's or SD Card view's on-screen display menus.

Connecting to a projector or flat-panel display

You can connect your document camera to a projector or display with the VGA cable.

To connect to a projector or display

1. Connect the VGA cable to the **VGA Out** connector on the back of your document camera.
2. Connect the other end of the VGA cable to the **VGA In** connector on your projector or display.



CAUTION

Ensure your projector or display is not connected to a power outlet when connecting it to your document camera.

Switching between VGA - DVI-D and Composite output

If you're using a projector or computer display with a VGA or DVI-D cable, switch your document camera to VGA DVI-D mode. If you're using a television with the Composite video cable, switch your document camera to Composite mode.

To switch to DVI-D-VGA mode

Switch the **VGA DVI-D/Composite** switch on the side panel to **VGA DVI-D**.

To switch to composite mode

Switch the **VGA DVI-D/Composite** switch on the side panel to **Composite**.

Connecting to a digital projector or HD display with DVI-D

You can connect your document camera to a digital projector or high-definition display using a DVI-D single link cable.

NOTE

- Do not use a DVI-I or DVI-A cable.
- You can use a DVI-D dual link cable, but it will function as a single link DVI-D.
- If you connect your document camera directly to a projector or high definition display with a DVI-D cable, you will display only the camera image, and not your computer desktop or SMART Notebook presentation.

To connect to a digital projector or display

1. Connect a DVI cable from the **DVI-D Out** connector on your document camera, to the **DVI-D In** connector of your digital projector or high-definition display.
2. Switch to VGA-DVI-D mode. See page 10.

CAUTION

Ensure your digital projector or display is not connected to a power outlet when connecting it to your document camera.

Connecting your document camera to a television

You can connect your document camera to a television with a Composite video cable.

To connect to a television

1. Connect a Composite video cable from the **Composite Out** connector on your document camera to the **Video In** connector on your television.
2. Switch to Composite mode. See page 10.

CAUTION

Ensure your television is not connected to a power outlet when connecting it to your document camera.

Switching between NTSC and PAL

When you connect your document camera to a television, switch it to your television's encoding system, either NTSC or PAL.

To switch between NTSC and PAL

Switch the **NTSC/PAL** switch on the bottom of your document camera to **NTSC** if your television uses NTSC encoding, or to **PAL** if your television uses PAL encoding.

Setting output resolution

You can set your document camera's output resolution to match the projector or display you're using.

To set the output resolution

Set the **SXGA/WXGA/720p/XGA** switch to match the resolution of your display. Refer to the chart below to determine the output resolution you need.

Setting	Resolution
SXGA	1280 × 1024
WXGA	1280 × 800
720p	1280 × 720
XGA	1024 × 768

Downloading software

Your document camera includes software downloads that you can use to create more effective presentations.

Installing SMART Notebook software and SMART Product Drivers

To install SMART Notebook software and SMART Product Drivers

1. Visit SMART's download page at smarttech.com/us/Support/Browse+Support/Download+Software.
2. Scroll to SMART Notebook collaborative learning software.
3. Under *Choose a product*, click **SMART Notebook for Windows**, and then follow the on-screen instructions.

Installing Image Mate software

To download and install Image Mate software

1. Visit SMART's download page at smarttech.com/us/Support/Browse+Support/Download+Software.
2. Scroll to Image Mate software.
3. Under *Choose a product*, click **Image Mate software for Windows**, and then follow the on-screen instructions.

Chapter 3

Using your document camera

This chapter describes how to use your document camera and perform the following tasks:

- *Understanding Computer, Camera and SD Card views* on page 14
 - *Identifying view features* on page 15
 - *Setting document camera views* on page 16
- *Performing basic operations* on page 16
 - *Positioning your document camera* on page 16
 - *Turning your document camera on and off* on page 16
 - *Using the LED light* on page 17
 - *Using your document camera with SMART Notebook software* on page 19
 - *Displaying printed documents* on page 17
 - *Inserting and removing an SD or SDHC memory card* on page 18

Understanding Computer, Camera and SD Card views

You can use your document camera in Computer, Camera and SD Card views. Each view allows you do different things and requires a specific connection to either a display, projector or computer.

Computer view

Connect your document camera to your computer with the included USB 2.0 cable, and then set your document camera to Computer view to view document camera images only in SMART Notebook collaborative learning software.

You can then save images to your SMART Notebook file for later presentation, or if your computer is connected to an interactive whiteboard, projector or television, you can deliver your SMART Notebook presentation with live images from your document camera.

See *Using your document camera in Computer view* on page 21.

Camera view

Connect your document camera to a projector or television, and then set your document camera to Camera view. You can then view full-screen images from your document camera using a projector or high-definition display, even without a computer. You can still view images through SMART Notebook software.

You can use the Camera view on-screen display menu for greater control of the image, using Microscope mode, highlight boxes, screen masks and more.

See *Using your document camera in Camera view* on page 23

SD Card view



Connect your document camera to a projector or television, place an SD or SDHC memory card in your document camera, and then set your document camera to SD Card view. You can then view full-screen images and slide shows from the SD or SDHC memory card directly to a projector or high definition display, even without a computer.

You can use the SD Card view's on-screen display menu for greater control of the image, using highlight boxes, screen masks and more.



See *Using your document camera in SD Card view* on page 37.

Identifying view features

The following table describes the differences between each view:

Feature Description	Computer view 	Camera view 	SD Card view 
View computer input (VGA In)	Yes (VGA Out only)	No	No
View document camera image	Yes (DVI-D Out only)	Yes	No
View pictures from an SD or SDHC card	No	No	Yes
Access SD or SDHC memory card from computer with a USB cable	Yes ²	Yes ²	Yes ²
Control document camera from computer	Yes ¹	Yes ¹	No
Capture to SMART Notebook or Image Mate software	Yes ¹	Yes ¹	No
Capture to an SD or SDHC memory card	Yes ¹	Yes ¹	No
Access related on-screen display menu	No	Yes	Yes

Outputs when your document camera is connected to a display with VGA DVI-D or Composite Video Out

Feature Description	Computer view 	Camera view 	SD Card view 
Connect to projector or display (VGA Out)	VGA In	Camera image	Memory card images
Connect to high-definition projector or display (DVI-D Out)	Camera image	Camera image	Memory card images
Connect to television (Composite Video Out)	N/A	Camera image	Memory card images

1. Only when USB-B mode is set to Application. See page 34.
2. Only when USB-B mode is set to SD Storage. See page 35.

Setting document camera views

To set Computer view Press the Computer view  button on the control panel. For more information, see page 21.

To set Camera view Press the Camera view  button on the control panel. For more information, see page 24.

To set SD Card view Press the SD Card view  button on the control panel. For more information, see page 37.

Performing basic operations

Use the following operations when your document camera is in any view.

Positioning your document camera

The camera arm unfolds and the camera head rotates so you can position your document camera to display objects.

- To unfold and position your document camera**
1. Place a hand on the base to stabilize it, and then pull the camera arm upward and forward.
 2. Rotate the camera head and aim the lens at your subject.
-

Turning your document camera on and off

To turn your document camera on Press the power  button on the control panel.

The power light turns from amber to flashing green. When the light becomes solid green, your document camera will be operational.

To turn your document camera off Press the power  button on the control panel.

The power light turns from green to amber.

Using the LED light

You can use the LED light on the camera head to illuminate your subject.

To turn the LED light on

Switch the LED light switch to the left. See page 3.

WARNING

Do not stare into the lamp or shine the lamp directly into someone's eyes. Turn the light off when displaying or capturing images of people.

Displaying printed documents

When you set your document camera to Computer view or Camera view, you can display printed documents, use the anti-glare sheet to reduce glare, optimize the image for text documents with Text modes and optimize the image for documents with graphics with Graphics modes.



To display printed documents

1. Place your documents on the table.
2. Adjust the document camera and aim the camera lens at your documents.
3. Rotate the zoom dial to adjust the zoom magnification.
4. Press the auto focus  button to adjust the focus.

To reduce glare with the anti-glare sheet



If glare makes it difficult for you to read printed documents that you're displaying, place the anti-glare sheet on top of the printed materials.

To optimize the image for text documents

1. When your document camera is in Camera view, press **Menu** on the control panel.
The on-screen display menu appears.
2. Select **Image Setting**, and then press Enter .
3. Select **Image mode**, and then press Enter .
4. Select either **Text 1**, **Text 2** or **Text 3**, and then press Enter . See page 28 for an explanation of the settings.

To optimize the image for documents with graphics

1. When your document camera is in Camera view, press **Menu** on the control panel.
The on-screen display menu appears.

2. Select **Image Setting**, and then press Enter .
 3. Select **Image mode**, and then press Enter .
 4. Select either **Graphics 1** or **Graphics 2**, and then press Enter . See page 28 for an explanation of the settings.
-

Inserting and removing an SD or SDHC memory card

Your document camera has an SD or SDHC memory card slot allowing you to save document camera images (when your document camera is in Computer view or Camera view) or display previously captured images (when your document camera is in SD Card view).

CAUTION

Avoid static electricity near an SD or SDHC memory card because it can damage the card.

To insert an SD or SDHC memory card

1. Press the Camera view  button on the control panel.
2. Insert an SD or SDHC memory card into the card slot on the side panel.

IMPORTANT

- Set your document camera to Application mode (see page 34) if you want to capture images to the SD or SDHC card.
 - Ensure the label on the SD or SDHC memory card is facing up.
-

To remove an SD or SDHC memory card

1. Press the Camera view  button on the control panel and wait until your document camera displays a live image.
2. Push the SD or SDHC memory card in to eject it, and then remove the card.



CAUTION

To prevent SD or SDHC memory card damage, do not remove the SD or SDHC memory card when capturing or deleting images.

Using your document camera with SMART Notebook software

Your document camera integrates with SMART Notebook software, allowing you to control your document camera from your computer or a SMART Board interactive whiteboard. You can display objects, capture an image and your annotations on an image to a SMART Notebook page, zoom, focus and adjust brightness settings.

To display objects

1. Press the power  button on the control panel.
2. Set your document camera to Computer view (see page 21) or Camera view (see page 24).
3. Start SMART Notebook software.
4. Place the object you want to display under your document camera.
5. Rotate the camera head and aim the lens at your subject.
6. In SMART Notebook software, press the document camera  icon.

OR

Select **Insert > Picture From SMART Document Camera** from the menu.

The *SMART Document Camera* object appears displaying your subject.

IMPORTANT

If you can't control your document camera from SMART Notebook, ensure that your document camera is set to Application mode. See page 34.



To adjust the zoom magnification

Press the zoom  plus or minus buttons in SMART Notebook software to increase or decrease the zoom magnification.

OR

Use the zoom dial on your document camera.

To adjust the focus

1. Press the auto focus   button in SMART Notebook to focus automatically.
2. If necessary, press the focus  plus or minus buttons to adjust the focus.

To adjust the brightness

Press the brightness  plus or minus buttons to either increase or decrease subject brightness.

**To capture to the current
SMART Notebook page**

In the *SMART Document Camera* window, press **Capture and close**.

OR

Press the capture  button on the control panel.

The image in the *SMART Document Camera* window and any annotations you make on the image become separate objects on your current SMART Notebook page.

 NOTE

If you have an SD or SDHC memory card in your document camera, the capture button on the control panel will save the image there also. See page 18.

**To capture to a new
SMART Notebook page**

In the *SMART Document Camera* window, press **Capture to new page**.

The image in the SMART Document Camera window becomes an object on a new page.

Chapter 4

Using your document camera in Computer view

Topics in this chapter include:

- *About Computer view* on page 21
- *Setting Computer view* on page 21
- *Using Computer view* on page 22

About Computer view

This view is for presenting images from your document camera through your SMART Notebook software or Image Mate software. Connect your computer to both your document camera and your projector, and then set your document camera to Computer view.

The interactive whiteboard or projector will display your computer desktop or SMART Notebook file, and you can view or capture images from the camera.

Computer view is accessible in all computer, projector, and document camera setup configurations.

Setting Computer view

To set Computer view

1. Ensure your document camera is connected to your computer with the included USB 2.0 cable.
2. Ensure your computer is connected to a projector or display.

3. Press the Computer view icon on the control panel.



IMPORTANT

Your document camera must be in Application mode. See *Setting USB-B Application mode* on page 34.

Using Computer view

Computer view allows you to bring images from your document camera into SMART Notebook.

To use computer view

Refer to *Using your document camera with SMART Notebook software* on page 19.

Chapter 5

Using your document camera in Camera view

This chapter contains the following information on Camera view.

- *About Camera view* on page 23
- *Setting Camera view* on page 24
- *Using Microscope mode* on page 25
- *Using the Camera view's on-screen display menu* on page 25
 - *Camera view Image Settings on-screen display menu* on page 27
 - *Camera view Special Tools on-screen display menu* on page 29
 - *Camera view Function Settings on-screen display menu* on page 33
- *Saving images to an SD or SDHC memory card* on page 35
 - *Capturing images to an SD or SDHC memory card* on page 35
 - *Transferring images from a memory card to your computer* on page 36

About Camera view

Connect your document camera to an external display to see a full-screen image from your document camera.

You can use your document camera in Camera view to perform the following tasks:

- Display objects
- Capture images to an SD or SDHC memory card
- Capture images to SMART Notebook or Image Mate software
- Use the features and settings in the on-screen display menu
- Use Microscope mode to use your document camera with a standard microscope eyepiece without additional adapters

Setting Camera view

Switch your document camera to Camera view to display images on a projector, flat-panel display or television.



IMPORTANT

Your document camera must be connected directly to an external display. See *Connecting your document camera to an external display* on page 10.

To switch to Camera view

1. Connect your document camera to a projector or flat-panel display with the appropriate cable (see page 10).
2. Press the Camera view  button on the control panel.



To display objects

1. Press the power  button on the control panel.
2. Press the Camera view  button on the control panel.
3. Place the object you want to display under the camera.
4. Rotate the camera head to aim the lens at your subject.

To adjust the zoom magnification

Rotate the zoom dial on the camera head to increase or decrease the zoom magnification.

To automatically adjust the focus

Press the auto focus   button on the camera head to automatically focus the image.

To adjust brightness settings

On the control panel, press the brighten  or the darken  buttons.

Using Microscope mode



The SMART Document Camera allows you to view the microscope stage through the document camera without additional attachments.

To display a microscope slide

1. Place a slide or object on the stage of the microscope.
2. Focus the microscope so that the subject is in sharp focus.
3. Position the microscope under your document camera so the camera lens is aligned with the microscope eyepiece.

CAUTION

Ensure you do not hit your document camera lens with the microscope. This could damage your document camera's lens.



4. Press the Camera button on the control panel.
5. Press **Menu** on the control panel.
6. Select the **Image Setting** menu.
7. Use the up or down arrow buttons to select **Microscope mode**, and then press Enter .
8. Use the up or down arrow buttons to select **On**, and then press Enter .

Using the Camera view's on-screen display menu

You use the on-screen display menu to adjust several settings for your document camera.

To open the Camera view's on-screen display menu

1. Set your document camera to Camera view.
2. Press the **Menu** button on the control panel.
The on-screen display menu appears.
3. Press the up and down arrows on the control panel to navigate to a menu item.
4. Press the left and right arrow keys to navigate forward or backward through menu items.
5. Press Enter  to select a menu item.

6. To return to the previous menu level, use the down arrow button to navigate to **Back** , and then press Enter .

OR

To exit the menu, press **Menu**.

The following on-screen display menu options are available when your document camera is in Camera view:

Menu	Options
Image Settings	Brightness, Reset Brightness, Auto focus, Focus, Shutter Speed, White Balance, R/B-Gain, Image Mode, Edge Effect, Gamma, Image Rotation, Microscope mode, Color/B&W and Positive/Negative. See page 27.
Special Tools	Highlight, Mask, Scroll and Picture in Picture. See page 29.
Function Settings	USB-B mode, Frequency, Save Settings, Load Settings, Menu Display and Language. See page 33.

Camera view Image Settings on-screen display menu

To access the Image Settings menu

Select **Camera view**  > **Menu** > **Image Settings** .

























Image Setting menu options		Description
Brightness 	Auto	Adjusts image brightness automatically.
	Manual	Allows you to manually adjust image brightness.
Reset Brightness 	Yes	Resets image brightness
	No	Cancels resetting
(Only visible when Brightness is set to Auto)		
AF Mode 	Push	Sets the focus when you press the auto focus  ◀ button
	Zoom Sync	Automatically sets the focus when you adjust the zoom
Focus 		Allows you to manually adjust focus
Shutter Speed 	Slow	Sets a slow shutter speed, resulting in a brighter image, but with more blur.
	Fast	Sets a fast shutter speed, resulting in a darker image, but with less blur.
White Balance 	Auto	Sets white balance automatically
	One-Push	Sets white balance when you press the auto focus  ◀ button.
	Manual	Allows you to manually set the White Balance, using <i>Red Grain</i> and <i>Blue grain</i> .
R-Grain 		Manually sets red grain
(Only visible when White Balance is set to Manual)		
B-Grain 		Manually sets blue grain
(Only visible when White Balance is set to Manual)		

Image Setting menu options		Description
Image Mode 	Text 1	Optimizes image for displaying text documents by emphasizing contrast. Setting is low at Text 1 and high at Text 3 .
	Text 2	
	Text 3	
	Graphics 1	Optimizes image for displaying graphics. Displays Edge Effect  and Gamma  icons.
	Graphics 2	Optimizes image from DLP projector.
Edge Effect 		Emphasizes image outlines. Set to Low, Middle or High.
(Only visible when Image Mode is set to Graphics 1)		
Gamma 		Sets Gamma for the image. Set to Low, Middle or High.
(Only visible when Image Mode is set to Graphics 1)		
Image Rotation 	Off	Displays normal image rotation
	On	Rotates image 180°
Microscope mode 	On	Turns on Microscope mode
	Off	Turns off Microscope mode
Color/ B&W 	Color	Displays color images
	B&W	Displays black and white images
Positive/ Negative 	Positive	Displays normal image
	Negative	Displays film negative image

Camera view Special Tools on-screen display menu

To access the Special Tools menu

Select **Camera view**  > **Menu** > **Special Tools** .

Special Tools menu options	Description
Highlight 	Highlights a center square on the displayed image. Settings include: <ul style="list-style-type: none"> • Highlight On • Adjust Transparency • Adjust Size
Mask 	Covers the displayed image with an adjustable screen mask. Settings include: <ul style="list-style-type: none"> • Mask On • Adjust Transparency
Scroll 	Zooms in on the displayed images and allows you to move the zoomed area with the up, down, left and right buttons on the control panel. Settings include: <ul style="list-style-type: none"> • Scroll on • x2 • x3 • x4
PiP 	Takes a picture, and then displays that picture in a corner of the screen while you move or zoom the camera.



Using the Highlight setting

When you use the Highlight setting, a square in the center of the displayed image highlights your subject. You can change the size, transparency and position of the highlight box.

NOTE

The Highlight feature is display only. If you capture an image while the highlight box is on, the image doesn't include the highlight.





To use the Highlight setting

1. Display an object in Camera view, and then press **Menu** on the control panel.
The on-screen display menu appears.
 2. Press the up and down arrow buttons to select **Special Tools** , and then press Enter .
 3. Use the up and down arrow keys to select **Highlight > Highlight On**, and then press Enter .
- Your document camera highlights a square in the center of the image and obscures the edges of the image.
-





To move the highlight square

Use the up, down, right and left arrows to move the highlight square.

To change Highlight transparency

1. Press **Menu**.
The on-screen display menu appears.
 2. Press the up and down arrow buttons to select **Special Tools** , and then press Enter .
 3. Press the up and down arrow buttons to select **Highlight On**, and then press Enter .
 4. Press the up and down arrows to select **Highlight transparency**.
 5. Press Enter  to save your settings.
-

To change the highlight area size

1. Press the **Menu** button on the control panel.
The on-screen display menu appears.
 2. Press the up and down arrow buttons to select **Special Tools** , and then press Enter .
 3. Press the up and down arrow buttons to select **Highlight**, and then press Enter .
 4. Select **Adjust size**, and then press Enter .
 5. Press the up, down, left and right arrow buttons to change the Highlight area size.
 6. Press Enter  to save your settings.
-

To turn off the Highlight setting

Press Enter .



Using Image Masks

Image Masks obscure most of the image. You can resize or move the mask to reveal more of the image.

i NOTE

The Image Mask feature is display only. If you capture an image while the Image Mask is on, the image doesn't include the Image Mask.





To use an image mask

1. Display an object in Camera view, and then press **Menu** on the control panel.
The on-screen display menu appears.
 2. Press the up and down arrow buttons to select **Special Tools** , and then press Enter .
 3. Use the up and down arrow buttons to select **Mask on**, and then press Enter .
- An image mask appears on the image.

To move the image mask

Press the up, down, right and left arrow buttons to move the mask area.

To change image mask transparency

1. Press **Menu**.
The on-screen display menu appears.
2. Press the up and down arrow buttons to select **Special Tools** , and then press Enter .
3. Press the up and down arrow buttons to select **Image Mask Transparency**, and then press Enter .
4. Press the up and down arrows to select **Adjust transparency**.
5. Press Enter  to save your settings.

To turn off an Image Mask

Press Enter .

Using the Scroll setting

The Scroll setting zooms in on the image and allows you to move the zoomed area with the arrow buttons.

i NOTE

The Scroll feature is display only. If you capture an image while the scroll is on, the image is the unscrolled image.

To display the Scroll setting

1. Display an object in Camera view, and then press **Menu** on the control panel.
The on-screen display menu appears.
2. Press the up and down arrow buttons to select **Special Tools**, and then press Enter **↵**.
3. Press the up and down arrow buttons to select **Scroll**, and then press Enter **↵**.
4. Press the up and down arrow buttons to select **Scroll On**, and then press Enter **↵**.

Your document camera displays a zoomed area of the image.

To move the zoomed Scroll area

Use the up, down, right and left arrows to move the zoomed scroll area.

To change the scroll area magnification

When setting the Scroll function, Select either **x2**, **x3** or **x4**, and then press Enter **↵**.

Using the Picture in Picture (PiP) feature

The Picture in Picture (PiP) feature captures a temporary image from your document camera, and then displays it in one corner of the display. You can then change what is under the camera without the temporary image changing.

 NOTE

The PiP feature is display only. If you capture an image while the PiP is on, the image doesn't include the PiP.

To display the PiP image

1. Display an object in Camera view, and then press **Menu** on the control panel.
The on-screen display menu appears.
2. Press the up and down arrow buttons to select **Special Tools**, and then press Enter **↵**.
3. Press the up and down arrow buttons to select **PiP**, and then press Enter **↵**.

Your document camera displays a picture in picture image.

To move the PiP image

When displaying the PiP image, press the up, down, left and right arrow buttons on the control panel to move the image.





To turn off the PiP setting

Press Enter  on the control panel.

Camera view Function Settings on-screen display menu

To access the Functions Settings menu

Select **Camera view**  > **Menu** > **Function Settings** .

Function Settings menu options		Description
USB-B mode 	SD Storage	Allows you to copy or view your SD or SDHC memory card from your computer. See page 34.
	Application	Use SMART Notebook to control your document camera, and more. See page 34.
Frequency 	60 Hz	Sets frequency at 60 Hz
	50 Hz	Sets frequency at 50 Hz
Save Setting 	1	Saves presets for setting 1
	2	Saves presets for setting 2
	3	Saves presets for setting 3
	4 [Power On]	Saves presets for when you turn your document camera on
	Cancel	Cancels preset save
Load Setting 	1	Loads preset 1
	2	Loads preset 2
	3	Loads preset 3
	Default	Loads default settings
	4 [Power On]	Loads preset for when you turn your document camera on
	Cancel	Cancels load setting
Menu Display 	On	Turns on menu display
	Off	Turns off menu display

Function Settings menu options	Description	
Language 	English	Sets language to English
	Français	Sets language to French
	Deutsch	Sets language to German
	Español	Sets language to Spanish

Setting USB-B mode

USB-B mode sets how your document camera, your computer and an SD or SDHC card interact.

To access the USB-B mode setting

Select **Camera view**  > **Menu** > **Function Settings**  > **USB-B mode** .

USB-B mode settings overview

Action	SD Storage mode	Application Mode
See the SD or SDHC card from your computer	Yes	No
View and use your document camera from SMART Notebook or Image Mate software	No	Yes
Capture image to the SD or SDHC memory card in both Computer view and Camera view	No	Yes
SD Card view menu includes SD Settings	No	Yes

Setting USB-B Application mode

To use your document camera with your computer, you must set it to Application mode in the Camera view on-screen display menu.

IMPORTANT

Your document camera must be in Camera view to set it to Application mode. It can't be in Computer view or SD Card view.

To set your document camera to Application mode

1. Connect your document camera to a projector or flat-panel display with the VGA cable (see page 10).
2. Turn on your computer, and set it to Camera view.
3. Press **Menu** on the control panel.

The on-screen display menu appears.

4. Press the up and down arrows on the control panel to select **Function Setting**, and then press Enter **↵**.
 5. Select **USB-B mode**, and then press Enter **↵**.
 6. Select **Application** and then press Enter **↵**.
-

Setting USB-B SD Storage mode

This mode allows you to see the contents of your SD or SDHC memory card from your computer.

To set SD Storage mode

1. Connect your document camera to a projector, flat-panel display or television. See page 10.
 2. Press **Menu** on the control panel.
The on-screen display menu appears.
 3. Press the up and down arrows on the control panel to select **Function Setting**, and then press Enter **↵**.
 4. Select **USB-B mode**, and then press Enter **↵**.
 5. Select **SD Storage** and then press Enter **↵**.
-

Saving images to an SD or SDHC memory card

You can capture images to an SD or SDHC memory card when your document camera is in Camera view.

Capturing images to an SD or SDHC memory card

To capture images to an SD or SDHC memory card

1. Set your document camera to Camera view. See page 24.
2. Position your document camera.
3. Make any camera settings you require using the Camera view's on-screen display menu.
4. Press the Capture  button on the document camera control panel.
The camera capture icon appears, indicating a photo is being taken.

**IMPORTANT**

If you do not see the camera capture icon, ensure your document camera's USB-B mode is set to Application. See page 34.

Transferring images from a memory card to your computer

You can transfer images from an SD or SDHC memory card to your computer.

To transfer images to your computer

1. Set your document camera to SD Storage mode. See page 35.
2. Connect your document camera to your computer with the USB cable (see page 8).

Your computer recognizes your document camera and SD or SDHC memory card as a removable disk.

3. Navigate to the removable disk on your computer, and then transfer the images to your computer.
-

Chapter 6

Using your document camera in SD Card view

Topics in this chapter include the following:

- *Setting your document camera to SD Card view* on page 37
- *Using the SD Card view display* on page 38
- *Using the SD Card view on-screen display menu* on page 38
 - *SD Card view's on-screen display menu settings* on page 38
 - *SD Settings on-screen display menu* on page 38
 - *Special Tools on-screen display menu* on page 41
 - *Slideshow Settings on-screen display menu* on page 42

When you set your document camera to SD Card view, your document camera acts as an SD or SDHC memory card reader, displaying previously captured images either individually or as a slide show. Your computer is not used in an SD Card presentation.

Setting your document camera to SD Card view

To set SD Card view



1. Ensure your document camera is connected directly to a projector or another display. For connection information, see page 9.
 2. Place an SD or SDHC memory card in your document camera.
 3. Press the SD Card view  button on the control panel.
-

Using the SD Card view display

To display images

1. Press the SD Card view  button on the control panel.
2. Use the left and right arrows on the control panel to scroll through images on the SD or SDHC memory card.

To display and select thumbnail images

1. Press the SD Card view  button on the control panel.
2. Press Enter  to display up to 16 thumbnail-sized images.

To return to displaying single images

Press Enter  to display a single image.



Using the SD Card view on-screen display menu

The SD Card view's on-screen display's menu allows you to use the document camera as an SD or SDHC memory card reader.

SD Card view's on-screen display menu settings

You can use the following settings when your document camera is in SD Card view:

SD Card view on-screen display menu summary

SD Settings 	Delete, Lock, Unlock and Format Media, See page 38. Your document camera's USB-B mode must be set to Application to see this menu. See page 34.
Special Tools 	Highlight, Mask and Scroll. See page 41.
Slide Show 	Start Slideshow, Interval, Select, Repeat and Order. See page 42.





SD Settings on-screen display menu

To access the SD Settings menu

Select **SD Card view**  > **Menu** > **SD Settings** .

IMPORTANT

The SD Settings are only available if you have your document camera set to Application mode in the Camera view on-screen display menu. See page 34.

SD Settings menu Options		Description
Delete 	Current	Deletes current image
	All	Deletes all images in the current folder
	Cancel	Cancels image delete
Lock 	Current	Locks current image
	All	Locks all images
	Cancel	Cancels image lock
Unlock 	Current	Unlocks current image
	All	Unlocks all images
	Cancel	Exits Unlock settings
Format Media 	No	Cancels SD or SDHC memory card formatting
	Yes	Formats SD or SDHC memory card



Deleting images from an SD or SDHC memory card

You can delete images from an SD or SDHC memory card in your document camera using the on-screen display menu.

IMPORTANT

- Your document camera must be set to Application mode. See page 34.
- You can't delete images from your computer, only the from document camera's SD or SDHC card.

To delete images

1. Press the SD Card view  button on the control panel.
You see the current saved image from the SD or SDHC card.
2. Use the left and right arrow buttons on the control panel to select the image you want to delete.
3. Press **Menu** on the control panel.
The on-screen display menu appears.
4. Select **SD**, and then press Enter .
5. Select **Delete**, and then press Enter .

6. Select **Current**, and then press Enter  to delete the current image.

Or

Select **All**, and then press Enter  to delete all images in the viewed folder.

The deleting image icon displays briefly while your document camera deletes images.

Locking and Unlocking images

You can lock images to include them in slideshows set to **Select > Lock** in the Slideshow menu.





IMPORTANT

If you can't access the SD Menu, you must set your document camera's USB-B mode to Application mode. This is a Camera view menu setting. See page 34.

To lock images for a slideshow

1. Press the SD Card view button, and then press Menu.
2. Use the arrow buttons on the control panel to select the image you want to lock, and press the **Menu** button.

The on-screen display menu appears.

3. Select **SD > Lock**, and then press Enter .
4. Select **Current**, and then press Enter .

OR



Select **All** to lock all images.

Repeat steps one to three to lock other images for your slideshow.

To unlock images for a slideshow

1. In SD Card view, use the arrow buttons on the control panel to select the image you want to unlock, and press the **Menu** button.

The on-screen display menu appears.

2. Select **SD > Unlock**, and then press Enter .
3. Select **Current**, and then press Enter .



OR



Select **All** to unlock all images.

4. Repeat steps one to three to unlock other images for your slideshow.

Special Tools on-screen display menu

To access the Special Tools menu

Select **SD Card view**  > **Menu** > **Special Tools** .

Special Tools menu options	Description
Highlight 	Highlights a center square on the displayed image. Settings include: <ul style="list-style-type: none"> • Highlight On • Adjust Transparency • Adjust Size
Mask 	Covers the displayed image with an adjustable screen mask. Settings include: <ul style="list-style-type: none"> • Mask On • Adjust Transparency
Scroll 	Zooms in on the displayed images and allows you to move the zoomed area with the up, down, left and right buttons on the control panel. Settings include: <ul style="list-style-type: none"> • Scroll on • x2 • x3 • x4





The SD Card view's Special Tools menu includes the same tools as the Camera view's Special Tools menu, except that the SD Card view does not have the Picture in Picture (PiP) feature.

- For information on how to use the Highlight feature, see page 29.
- For information on how to use the Mask feature, see page 31.
- For information on how to use the Scroll feature, see page 31.

Slideshow Settings on-screen display menu



To access the Slideshow Settings menu

Select **SD Card view**  > **Menu** > **Slideshow** .

Slideshow menu Options		Description
Start Slideshow 		Starts a slideshow of images
Interval 	5 sec	Sets image interval to 5 seconds
	10 sec	Sets image interval to 10 seconds
	15 sec	Sets image interval to 15 seconds
	30 sec	Sets image interval to 30 seconds
Select 	All	Selects all images for slideshow
	Lock	Sets so only locked images display in a slideshow
Repeat 	Off	Turns off slideshow repeat
	On	Turns on slideshow repeat
Order 	Forward	Sets slideshow order to forward
	Backward	Sets slideshow order to backward

Showing slideshows

To start a slideshow

1. Access the Slideshow menu.
2. Select **Slideshow**, and then press Enter .
3. Select **Start Slideshow**, and press Enter .

Your document camera displays a slideshow of images on the SD or SDHC memory card.

To stop a slideshow

Press Enter  or any of the arrow buttons on the control panel.

The image slideshow stops and the on-screen display menu appears.

Displaying specific images in a Slideshow

You can set your document camera to display only images that you select.

To set SD settings to display selected images only

1. In SD Card view, press **Menu** on the control panel.
The on-screen display menu appears.
2. Select **Slideshow > Select**, and then press Enter **↵**.
3. Select **Lock**, and then press Enter **↵** so that only locked images display in a slideshow.



IMPORTANT

When you set the slideshow to Lock, it will include only images that are locked. You will lock images in the SD Card view, SD menu, not the Slideshow menu.

To lock images

See *Locking and Unlocking images* on page 40.

To unlock images

See *Locking and Unlocking images* on page 40.

Chapter 7

Troubleshooting

Document camera issues

Use the following table to troubleshoot issues with your document camera.

Issue	Solution
No image displays or appears.	<ul style="list-style-type: none">• Turn off your document camera (see page 16). Securely connect all cables and connect the camera's AC adapter to a power outlet. Turn on your document camera.• Adjust the zoom dial. The camera may be on a blank section of your document.• Ensure the output switches on the side panel are set to the proper image output:<ul style="list-style-type: none">– VGA DVI-D or Composite on the side panel– NTSC or PAL on the bottom of your document camera
No image displays after you restart your computer. Document camera is connected through a USB hub.	<ol style="list-style-type: none">1. Turn off your document camera, and then wait several seconds.2. Turn on your document camera again.
The image is out of focus.	<ul style="list-style-type: none">• Press the auto focus  button.• Use the manual focus.• Move the camera further away from the object.
The image is scrambled or black and white when a television is the display device.	Ensure the NTSC/PAL switch beneath the projector is set correctly.

Issue	Solution
The image is too dark.	<ul style="list-style-type: none"> Press the brightness buttons on your document camera. If the object is not well lit, turn on your document camera LED. Adjust the shutter speed. See page 27.
The image is broken apart by lines.	<ul style="list-style-type: none"> Adjust the distance between the object and the camera. Adjust your projector settings

SD Card view issues

Issue	Solution
No image appears when you press the SD Card view button	<ul style="list-style-type: none"> Check the connection between your Document camera and the projector, television or display. See <i>Setup configurations for Camera view and SD Card view</i> on page 9. Ensure your document camera, projector or television is turned on.
A crossed out, red SD Card icon appears when you press the SD Card view button.	<p>Place an SD or SDHC memory card in your document camera SD Card slot.</p> <p>OR</p> <p>There are no images on the SD or SDHC memory card.</p>
The SD Card view menu does not include SD Settings  .	In Camera view, set USB-B mode to Application. See <i>Setting USB-B Application mode</i> on page 34.
Slideshow doesn't start, and there are images in the SD or SDHC memory card.	<p>Your slideshow is set to Lock, and you don't have any locked images.</p> <p>Set the slideshow to All. See page 43.</p> <p>OR</p> <p>Lock some or all of the images in the SD or SDHC memory card. See page 40.</p>

Appendix A

Hardware environmental compliance

SMART Technologies supports global efforts to ensure that electronic equipment is manufactured, sold and disposed of in a safe and environmentally friendly manner.

Waste Electrical and Electronic Equipment regulations (WEEE directive)

Waste Electrical and Electronic Equipment regulations apply to all electrical and electronic equipment sold within the European Union.

When you dispose of any electrical or electronic equipment, including SMART Technologies products, we strongly encourage you to properly recycle the electronic product when it has reached end of its life. If you require further information, please contact your reseller or SMART Technologies for information on which recycling agency to contact.

Restriction of Certain Hazardous Substances (RoHS directive)

This product meets the requirements of the European Union's Restriction of Certain Hazardous Substances (RoHS) Directive 2002/95/EC.

Consequently, this product also complies with other regulations that have arisen in various geographical areas, and that reference the European Union's RoHS directive.

Packaging

Many countries have regulations restricting the use of certain heavy metals in product packaging. The packaging used by SMART Technologies to ship products complies with applicable packaging laws.

China's Electronic Information Products Regulations (EIP)

China regulates products that are classified as EIP (Electronic Information Products). SMART Technologies products fall under this classification and meet the requirements for China's EIP regulations.

U.S. Consumer Product Safety Improvement Act

The United States has enacted the Consumer Product Safety Improvement Act which limits the lead (Pb) content in products used by children. SMART Technologies is committed to complying with this initiative.

Appendix B

Customer support

Online information and support

Visit www.smarttech.com/support to view and download user's guides, how-to and troubleshooting articles, software and more.

Training

Visit www.smarttech.com/trainingcenter for training materials and information about our training services.

Technical support

If you experience difficulty with your SMART product, please contact your local reseller before contacting SMART Technical Support. Your local reseller can resolve most issues without delay.

NOTE

To locate your local reseller, visit www.smarttech.com/where+to+buy.

All SMART products include online, telephone, fax and e-mail support:

Online	smarttech.com/contactsupport
Telephone	+1.403.228.5940 or Toll Free 1.866.518.6791 (U.S./Canada) (Monday to Friday, 5 a.m. – 6 p.m. Mountain Time)
Fax	+1.403.806.1256
E-mail	support@smarttech.com

Shipping and repair status

Contact SMART's Return of Merchandise Authorization (RMA) group, Option 4, +1.866.518.6791, for shipping damage, missing part and repair status issues.

General inquiries

Address SMART Technologies
3636 Research Road NW
Calgary, AB T2L 1Y1
CANADA

Switchboard +1.403.228.5940 or
Toll Free 1.866.518.6791 (U.S./Canada)

Fax +1.403.228.2500

E-mail info@smarttech.com

Warranty

Product warranty is governed by the terms and conditions of SMART's "Limited Equipment Warranty" that shipped with the SMART product at the time of purchase.

Registration

To help us serve you, register online at smarttech.com/Product+Registration.

SMARTTM

Toll Free 1.866.518.6791 (U.S./Canada)
or +1.403.228.5940
www.smarttech.com