

© Copyright 2013, TL elektronik  
Non TSO approved

# INTEGRA EMS TL-6760 USER MANUAL



**TL ELEKTRONIC** Inc.

**TL elektronik**  
Airport, Building 125  
503 41 Hradec Kralove  
Czech Republic

© Copyright 2013  
TL elektronik  
All Rights Reserved

Except as expressly provided below, no part of this manual may be downloaded, transmitted, copied, reproduced, disseminated or stored in any storage medium, for any purpose without the express prior written consent of the TL elektronik company. Address your questions about the technical information to TL elektronik. Other information about sale, distribution should be directed to our exclusive distributors (see World Distributor list on our website).

Producer's address:  
TL elektronik Inc.  
Airport, Building 125,  
503 41 Hradec Kralove, Czech Republic  
Fax: +420 49 548 23 94 E-mail: [info@tl-elektronik.com](mailto:info@tl-elektronik.com)  
Web Site Address: [www.tl-elektronik.com](http://www.tl-elektronik.com)

Please, send your e-mail address to [customer@tl-elektronik.com](mailto:customer@tl-elektronik.com) to receive the latest information about software upgrade.

Send your ideas to [innovation@tl-elektronik.com](mailto:innovation@tl-elektronik.com)  
We will evaluate your suggestion and provide an update.

Windows is registered trademark of Microsoft Corporation.  
All trademarks and registered trademarks are acknowledged.  
SchecK® is registered trademark of TL elektronik.  
iFamily® is registered trademark of TL elektronik.  
sModern® is registered trademark of TL elektronik.

All information in this User's manual is subject to change without prior notice.

**Table of Contents**

Table of Contents ..... 2

Record of revision ..... 4

Accessories and Packing List ..... 7

Limited warranty ..... 8

General description ..... 9

- About this Guide ..... 10
- Integra iFamily® Connection ..... 10
- Compatibility of Integra Glass Cockpits ..... 11
- Explanation of Possible Connections ..... 11
- Back up System Recommendation ..... 12
- Explanation of Priority setting for Data Sharing ..... 13
- The INTEGRA Glass Cockpit Instrument System ..... 14
- Capabilities ..... 15
- Power ..... 15
- Theory of Operation ..... 16

BASIC OPERATION ..... 17







- Operation terminology ..... 17
- Turning the INTEGRA ON ..... 17
- Turning the INTEGRA OFF ..... 17
- The INTEGRA Control Panel ..... 18
- Knobs ..... 19
- Buttons and Labels ..... 19
- Data Port ..... 20
- Battery Installation ..... 25
- SD card Installation ..... 27
- Brightness ..... 28
- Information about Battery ..... 29
- Warning Signals ..... 30

INTEGRA Operation ..... 31

- Description of complete EMS ..... 32

- Description of function – EMS ..... 34
- Integra Menu ..... 35
  - Brightness..... 35
  - Checklist..... 36
  - Statistics for EMS ..... 37
- Configuration of Integra..... 39
  - Enter to setup ..... 39
  - Power Off..... 40
  - About..... 40
- Menu Entertainment..... 41
  - Option Movie ..... 43
  - Option Music..... 45
  - Option Flight Data ..... 46
  - Option Exit..... 46
- Abbreviations ..... 47
- Technical Parameters ..... 49



-  **WARNING:** This product is not TSO approved as a flight instrument, therefore, the manufacturer will not be held responsible for any damage caused by its use.
-  **WARNING:** The altitude calculated by the INTEGRA is geometric height above mean sea level and could vary significantly from altitude displayed by pressure altimeters in aircraft.
-  **CAUTION:** The 3D Terrain Map supplied with INTEGRA relies on GPS data, this system is subject to changes which could affect the accuracy and performance of the INTEGRA's 3D Terrain map. The electronic chart is an aid to navigation and is designed to facilitate the use of authorized government charts, not replace them. Land and water data is provided only as a general reference to your surroundings. The positional accuracy of the land and water data is not of a precision suitable for use in navigation and it should not be used for navigation. Only official government charts and notices contain all information needed for safe navigation – and, as always, the user is responsible for their prudent use.
-  **CAUTION:** The Terrain feature is for supplemental awareness only. The pilot/crew is responsible for all terrain and obstacle avoidance using information not provided by the INTEGRA 3DTerrain feature.
-  **CAUTION:** Although the INTEGRA series are precision electronic Navigation AIDs (NAVAID), any NAVAID can be misused or misinterpreted and therefore become unsafe.
-  **CAUTION:** Use the INTEGRA at your own risk. To reduce the risk of unsafe operation, carefully review and understand all aspects of this Owner's Manual and the Flight Manual Supplement, and thoroughly practice basic operation prior to actual use. When in actual use, carefully compare indications from the INTEGRA to all available navigation sources, including the information from other NAVAIDS, visual sightings, charts, etc. For safety, always resolve any discrepancies before continuing navigation.
-  **CAUTION:** The INTEGRA -series does not contain any user-serviceable parts. Repairs should only be made by an authorized TL-elektronik service center. Unauthorized repairs or modifications could void your warranty and authority to operate this device under FCC Part 15 regulations.

- i NOTE:** It is the pilot's responsibility for initial missed approach guidance in accordance with published procedure. The unit may not provide correct guidance until established on a defined leg.
- i NOTE:** This device complies with Part 15 of the FCC limits for Class B digital devices. This equipment generates, uses, and can radiate radio frequency energy and, if not installed and used in accordance with the instructions, may cause harmful interference to radio communications. Furthermore, there is no guarantee that interference will not occur in a particular installation.

If this equipment does cause harmful interference, the user is encouraged to try to correct the interference by relocating the equipment or connecting the equipment to a different circuit than the affected equipment. Consult an authorized dealer or other qualified avionics technician for additional help if these remedies do not correct the problem. Operation of this device is subject to the following conditions:

- (1) This device may not cause harmful interference, and this device must accept any interference received, including interference that may cause undesired operation..
- (2) The INTEGRA display lenses are coated with a special antireflective coating which is very sensitive to skin oils, waxes and abrasive cleaners. It is very important to clean the screen using an eyeglass lens cleaner which is specified as safe for anti-reflective coatings and a clean, lint-free cloth.

To obtain accessories for your INTEGRA, please contact your TL-elektronic dealer. Help us better support you by completing our on-line registration form today! Registration ensures that you will be notified of product updates and new products and provides lost or stolen unit tracking. Please, have the serial number of your unit handy, connect to our web site ([www.tl-elektronic.com](http://www.tl-elektronic.com)) and look for our Product Registration link on the home page TL elektronik is fully committed to your satisfaction as a customer. If you have any questions regarding the INTEGRA, please contact our customer service department.

## Accessories and Packing List

The INTEGRA represents TL electronics' continued commitment to providing you with the most advanced technology available today — in an accurate, easy-to-use design suitable for all of your flying needs. Unless otherwise specified within this manual, the term “INTEGRA” applies to the TL-6524, TL-6724, TL-6624, TL-6824, TL-6560, TL-6760, TL-6660 and TL-6860.

Before installing and getting started with your new system, please ensure that your package includes the following items. If any parts are missing or are damaged, please contact your TL-elektronic dealer.

### Standard Package:

- INTEGRA Unit
- Installation Rack
- Accessories
- User and Configuration manual
- CD with software and Installation Manual
- Warranty Card

### Optional Accessories:

- Internal back-up Battery
- SD card with 3D Terrain

Your aviation maintenance specialist should perform the installation and configuration of your new INTEGRA unit. The INTEGRA should be secured in the installation rack with the proper wiring connections. Be ready to answer any questions that your maintenance specialist could have about the installation such as location of antennas or any connections to other equipment in the panel.



## Limited warranty

The TL elektronik company warrants this product to be free from defects in materials and manufacture for three years from the date of purchase. TL elektronik will, at its sole option, repair or replace any components that fail in normal use. Such repairs or replacement will be made at no charge to the customer for parts or labour. The customer is, however, responsible for any transportation costs. This warranty does not cover failures due to abuse, misuse, accident or unauthorized alteration or repairs.

THE WARRANTIES AND REMEDIES CONTAINED HEREIN ARE EXCLUSIVE AND IN LIEU OF ALL OTHER WARRANTIES EXPRESS OR IMPLIED OR STATUTORY, INCLUDING ANY LIABILITY ARISING UNDER ANY WARRANTY OF MERCHANTABILITY OR FITNESS FOR A PARTICULAR PURPOSE, STATUTORY OR OTHERWISE. THIS WARRANTY GIVES YOU SPECIFIC LEGAL RIGHTS, WHICH MAY VARY FROM STATE TO STATE.

IN NO EVENT SHALL TL ELEKTRONIC BE LIABLE FOR ANY INCIDENTAL, SPECIAL, INDIRECT OR CONSEQUENTIAL DAMAGES, WHETHER RESULTING FROM THE USE, MISUSE, OR INABILITY TO USE THIS PRODUCT OR FROM DEFECTS IN THE PRODUCT. SOME STATES DO NOT ALLOW THE EXCLUSION OF INCIDENTAL OR CONSEQUENTIAL DAMAGES, SO THE ABOVE LIMITATIONS MAY NOT APPLY TO YOU.

To obtain warranty service, call the TL elektronik Customer Service (+420 49 548 23 92) for a returned merchandise tracking number. The unit should be securely packaged with the tracking number clearly marked on the outside of the package and sent freight prepaid and insured to a TL elektronik warranty service station. A copy of the original sales receipt is required as the proof of purchase for warranty repairs. TL elektronik retains the exclusive right to repair or replace the unit or software or offer a full refund of the purchase price at its sole discretion. SUCH REMEDY SHALL BE YOUR SOLE AND EXCLUSIVE REMEDY FOR ANY BREACH OF WARRANTY.

## General description

**Thank you for purchasing the TL-elektronic INTEGRA. This section provides some important cautionary information and general usage instructions for this manual.**

### Before You Fly

We strongly recommended that you read this entire guide before attempting to use the INTEGRA in an actual flying situation. Additionally, we encourage you to spend time on the ground familiarizing yourself with the operation of the product. While first learning to use the instrument in the air, we recommend you have a backup pilot with you in the aircraft. Finally, we encourage you to keep this manual in the aircraft with you at all times. This document is designed to give you quick access to information that might be needed in flight.

 **CAUTION:** In a flying situation, it is the pilot's responsibility to use the product and the guide prudently.

### OEM Installations

If your INTEGRA is installed by an OEM aircraft producer, you may find that you are unable to access some menus and settings. Some TL-elektronic distributors customize various areas of the INTEGRA firmware to maintain a consistent pilot experience and minimize INTEGRA information issues across a large number of installations. Currently, OEMs can customize access levels to the following settings on TL-elektronic systems: EMS SENSOR setup menu, fuel calibration, trim calibration, flaps calibration, GPS/NAV setup menu, screen configurations, data logging, and checklists/data panels. OEM distributors have the option of customizing some or all of these areas. Please contact your aircraft's manufacturer if you have any questions about how your unit has been customized.

 **WARNING:** TL-elektronic Avionics' products incorporate a variety of precise, calibrated electronics. Except for replacing the optional internal backup battery in INTEGRA -based products per the installation guide, our products do not contain any field/user-serviceable parts. Units that have been found to have been taken apart may not be eligible for repair under warranty. Additionally, once a TL-elektronic unit is opened up, it will require calibration and verification at our factory before it can be considered airworthy.

**⚡ WARNING:** The INTEGRA is permanently supplied by the aircraft's power supply. Therefore, it is necessary to install a fuse to act as protection against a power surge. This will protect against the risk of fire and resulting damage to the INTEGRA and/or aircraft.

### About this Guide

This guide serves two purposes. The first is to help you configure and get acquainted with the INTEGRA's many functions. The second is to give you quick access to vital information. For detailed technical and installation information, please refer to the INTEGRA Installation Guide. In the electronic (.PDF) version of this manual, page and section references in the **Table of Contents** and elsewhere act as hyperlinks taking you to the relevant location in the manual. The latest version of this manual may be downloaded from our website at [www.tl-elektronic.com](http://www.tl-elektronic.com).

### Integra iFamily® Connection

#### The TL elektronik iFamily® BUS

If you have multiple TL elektronik products in your aircraft, they can be networked together via the TL elektronik **iFamily®** BUS. Units networked via **iFamily®** have the ability to share information with each other. Any product's data can then be viewed on any other screen in the **iFamily®** network. For example, an EFIS has the ability to display engine monitor information if it is connected to an EMS TL-6724. The **iFamily®** systems allows you to connect autopilot servos and remote compass.

**ⓘ NOTE:** That the failure of a unit in an iFamily® network may cause the loss of some or all data shared between units. In the example below, if the connected EMS TL-6724 were to fail, the EFIS/EMS would no longer be able to behave as an engine monitor.

### Compatibility of Integra Glass Cockpits

New Integra Glass Cockpits with 9” displays have same software architecture as Integra Glass Cockpits with 7” displays. This means that functionality is identical for both mentioned product lines. The product lines are fully compatible with each other. Practically this means that for example EFIS TL-6524 can be connected to TL-6760 via **iFamily®** BUS. Also HW solution for connection is identical for both product lines; the connectors are identical; so for example you can easily replace your TL-6624 with TL-6660 without any modification of harness.

Here is table describing part numbers for Integra Glass Cockpits:

Functionality	Part Number for Integra with 7" display	Part Number for Integra with 9" display
EFIS & EMS	TL-6624	TL-6660
EFIS	TL-6524	TL-6560
EMS	TL-6724	TL-6760
Remote Display	TL-6824	TL-6860

### Explanation of Possible Connections

**i** **NOTE:** This section does not contain all possible connections. Introduction of new Integra Glass Cockpits with 9” displays to market bring many new possible connections.

Here are a few Instrument connection possibilities:

If you connect TL-6524 with TL-6724 you will be able to share the screen data between the two instruments

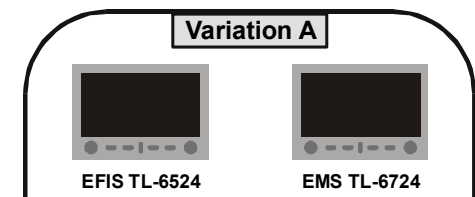

If you connect TL-6524 with TL-6824 you will be able to read the same data on TL-6824 as you have on TL-6524

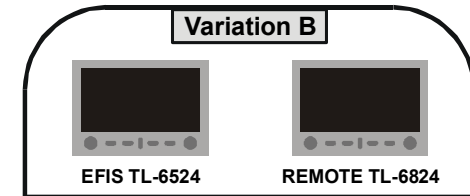

If you connect TL-6724 with TL-6824 you will be able to read the same data on TL-6824 as you have on TL-6724

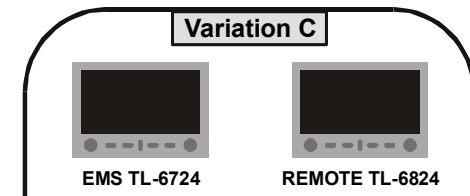

If you connect TL-6624 with TL-6824 you will be able to read the same data on TL-6824 as you have on TL-6624

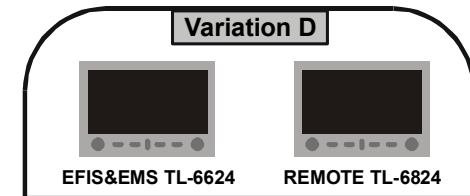

### Back up System Recommendation

We recommend this configuration for safe panel system redundancy: **TL 6524 and 6624**

In the case of instrument failure flight information will be available on the second instrument

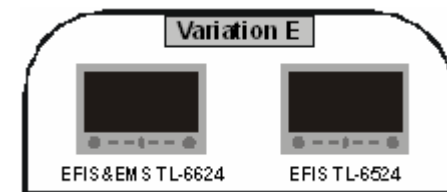

### Explanation of Priority setting for Data Sharing

The priority for Data Sharing is set in Setup Mode, separately for EMS data (in EMS Setup Mode) and for EFIS data (in EFIS Setup Mode). Although Setup Mode is subject of Configuration Manual, we explain priority setting of Data Sharing here to make you understand whole Data Sharing function at once.

EFIS Data Sharing:  
Low Priority set  
EMS Data Sharing:  
Low  
or  
High Priority set

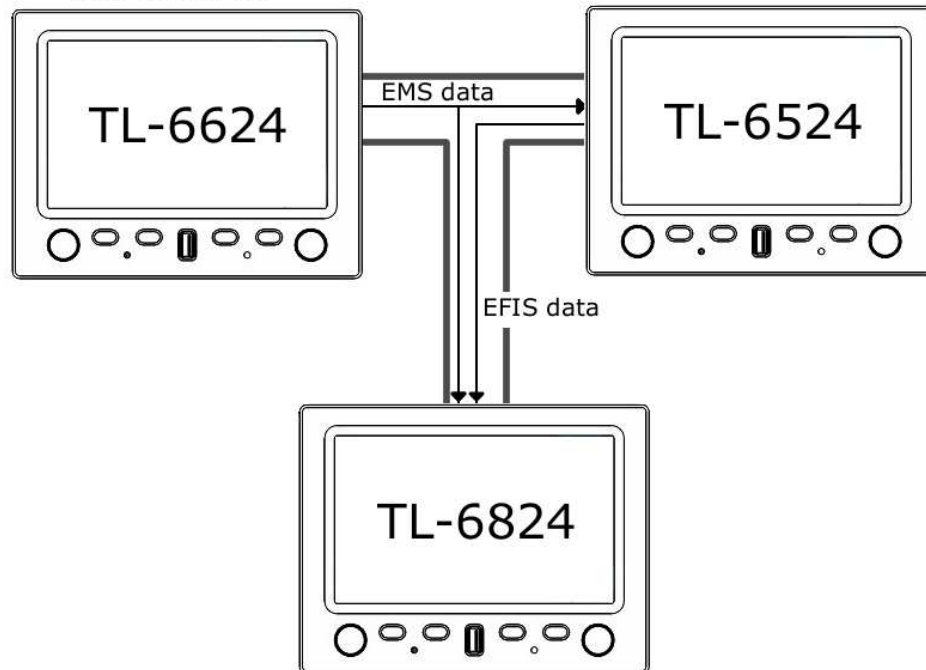

Data Sharing “Priority” means importance of specific data (EFIS or EMS data), which the Integra is sending to bus.

For example:

The picture on right side shows three Integra units connected by bus. Arrows linking the units express actual flow of information. Connection of TL-6624 and TL-6524 creates EFIS data redundancy, because both units have internal sensors for measuring EFIS data. The both units sends EFIS data to the bus, because their EFIS Data Sharing is On (EFIS Data Sharing is not set to Off). EFIS data from TL-6524 takes priority over EFIS data from TL-6624 on the bus, because TL-6524 is set to higher EFIS Data Priority than TL-6624. Therefore TL-6824 receives EFIS data from TL-6524. But TL-6624 and TL-6524 displays their own EFIS data. Own data of the Integra always takes priority over data from the bus.





Because TL-6524 has no inputs for measurement of EMS data, the only way to display EMS data on the unit is to receive EMS data from TL-6624 via the bus. Therefore priority for TL-6624 EMS Data Sharing could be set to Low or High. There is no difference because this unit is only EMS data source.

TL-6824 hasn't got Data Sharing Setting. It only receives data available on the bus according to priority setting of data sources previously described. The only way to disable receiving and displaying data in standard screen is to unplug the bus from TL-6824.

**NOTE:** Explanation of priority setting is also applicable for Integra units with 9” displays, please see section Compatibility of Integra Glass Cockpits on page 11.

### The INTEGRA Glass Cockpit Instrument System

Before operation the INTEGRA, please check to see if there are any parts missing or damaged. If you have not received all the necessary components or if there are damaged components please contact TL-elektronic or your TLe dealer immediately. The INTEGRA requires a Remote Compass and GPS Receiver to provide a full range of functions.

-  **WARNING:** Obstacle clearance is not assured in 3D Terrain or Highway in the Sky (HITS) approach mode
-  **CAUTION:** If any display unit in the chain is inoperable, the display units will not be able to share information. The pilot must account for this down-graded mode of operation and expect data will not transfer between displays.
-  **NOTE:** It is highly desirable to provide each display unit with its own connection to each source of data if possible. This increases the redundancy of the system, and reduces the amount of lost function in the event a display unit becomes inoperative.
-  **NOTE:** Most, but **not all** data contained within this manual is accurate. Some differences may be observed when comparing the information in this manual to other instrument generation models.

### Before You Fly

We strongly recommended that you read this entire guide before attempting to use the INTEGRA in an actual in-flight situation. Additionally, we encourage you to spend time on the ground familiarizing yourself with the operation of the product. While first learning to use the instrument in the air, we recommend you have a backup pilot with you in the aircraft. Finally, we encourage you to keep this manual in the aircraft with you at all times. This document is designed to give you quick access to information that might be needed in flight.

-  **NOTE:** While in-flight, it is the pilot's responsibility to use this product and this guide prudently.

### Capabilities

The INTEGRA's robust design enables the use of a wide range of engines and sensors. You may configure the INTEGRA system to meet your monitoring requirements. The INTEGRA visual and audio warning systems give you immediate notification of any potential problem that might otherwise go unnoticed. The accurate and reliable solid-state sensors of the INTEGRA provide essential information with a user-friendly interface.

### Power

The INTEGRA requires between 10 and 30 volts DC for operation and should be connected to an external backup power supply with keep-alive voltage. The INTEGRA can be turned on during engine start.

The INTEGRA can be ordered with an optional internal Li-poly backup battery which allows the instrument to continue to operate in the event of an external power failure. This lithium-polymer battery is rechargeable and its charge is maintained by the INTEGRA.

If the always-on circuit is connected, the INTEGRA continues to charge its internal battery even if the instrument is turned off. This ensures a full charge for your internal emergency battery.

Under normal conditions, the internal battery should have a voltage between 11.1 and 12.6 volts. A new fully charged internal battery is rated for a minimum 30 minute of normal operation with the INTEGRA. If the INTEGRA has switched to its internal back up battery due to external power loss, it is advisable that you land your aircraft as soon as possible.

**i NOTE:** Battery life is dependent on for example, the brightness of the display and number of sensors which are battery-powered etc.



### Theory of Operation

The primary flight instruments on your EFIS display are generated using a group of calibrated sensors. All of them are solid state – that is, there are no moving parts. These sensors include accelerometers, which measure forces in three directions; rotational rate sensors, which sense rotation of all three axis; pressure transducers for measuring air data; and magnetometers on all three axis for measuring magnetic heading.

**i** **NOTE:** This product is intended for experimental and Light Sport Aircraft categories and is not approved for installation in Certified Aircraft.

## BASIC OPERATION

### Operation terminology

Term “select” in the context of Integra operation in this manual means this sequence of operation steps:

1. Highlight described menu option by rotating the knob.
2. Press the knob.

When the manual says e.g. “Press button “Yes”, it means press the button with label “Yes” displayed on screen above the button.

### Turning the INTEGRA ON

Press the right-hand knob to turn the Integra on and wait until the green backlight goes out.

 **NOTE:** The other knob and buttons are disabled when the INTEGRA is Shut Down.

### Turning the INTEGRA OFF

To turn off the INTEGRA and place it in Shut down Mode

3. Press the right-hand knob.
4. Select **Power Off**

 **NOTE:** All settings and calibrations will be stored when the INTEGRA is Powered Off.

### The INTEGRA Control Panel

The picture below shows Integra Control Panel. Integra Control Panel includes 2 knobs, 6 buttons and USB Data Port.

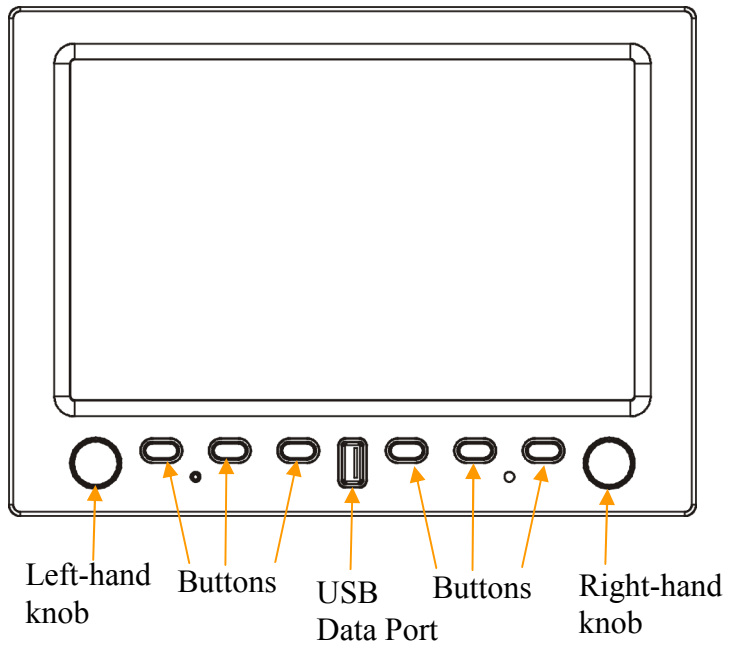

### Knobs

Control of all menus is really easy and simple. The two knobs have two interfaces - **press** and **rotate**. These provide particular menu options on different pages, and are used to

- scroll through menus
- adjust instrument parameters and settings

### Buttons and Labels

The **Button** and **Knob Labels** will appear as white on black writing in the default mode.

The **Labels** will be highlighted once the control panel is engaged by pressing a button or turning a knob.

The **Prompt Labels** turn red to match any urgent notice appearing on the screen.

### Data Port

The INTEGRA allows the pilot to enter checklists, flight plans, general information and update firmware through the USB port. This data must be verified for accuracy by the pilot prior to flight.

#### Access to Data Port function

If you want to work with data from an external source, plug USB flash drive into the USB port. Allow 10 seconds for the Integra to read the drive. Press the right-hand knob to enter the menu and select Enter Setup. When prompt “Are you sure you want to enter to setup?” appears, press button “Yes”. Now the Integra is in Setup Mode. Button label “Data Port” is displayed. Press that button. Menu Data Port will appear containing the following:

- **Menu DATA PORT**
  - *Import Checklist*
  - *Import Configuration*
  - *Export Configuration*
  - *Export Flight Data*
  - *Export Service Log*
  - *Update Firmware*

**i** **NOTE:** If you can't see “Data Port” button label in Setup Mode, check correct USB flash drive connection.

Import Checklist	You can create your checklist on your computer and you can transfer this data into the Integra.
Import Configuration	You can create your configuration on your computer and you can copy these settings to the Integra.
Export Configuration	You can export your configuration from the Integra to your USB flash drive.
Export Flight Data	You can export your flight data from the Integra to your USB flash drive.
Export Service Log	You can export your service log from the Integra to your USB flash drive.
Update Firmware	You can update the firmware of Integra.

### Import Checklist

#### The first step: Integra Demo PC application

##### To create or edit checklist:

Installed Integra Demo PC application is required. You can obtain Integra Demo from TL-elektronic web site. (Products->LSA->category EFIS&EMS Integra->TL-6x24\*->Downloads-> Demo PC application.)

- 1) Connect USB flash drive to your personal computer. Run Integra Demo, press right mouse button over Integra buttons area. The context menu will appear:

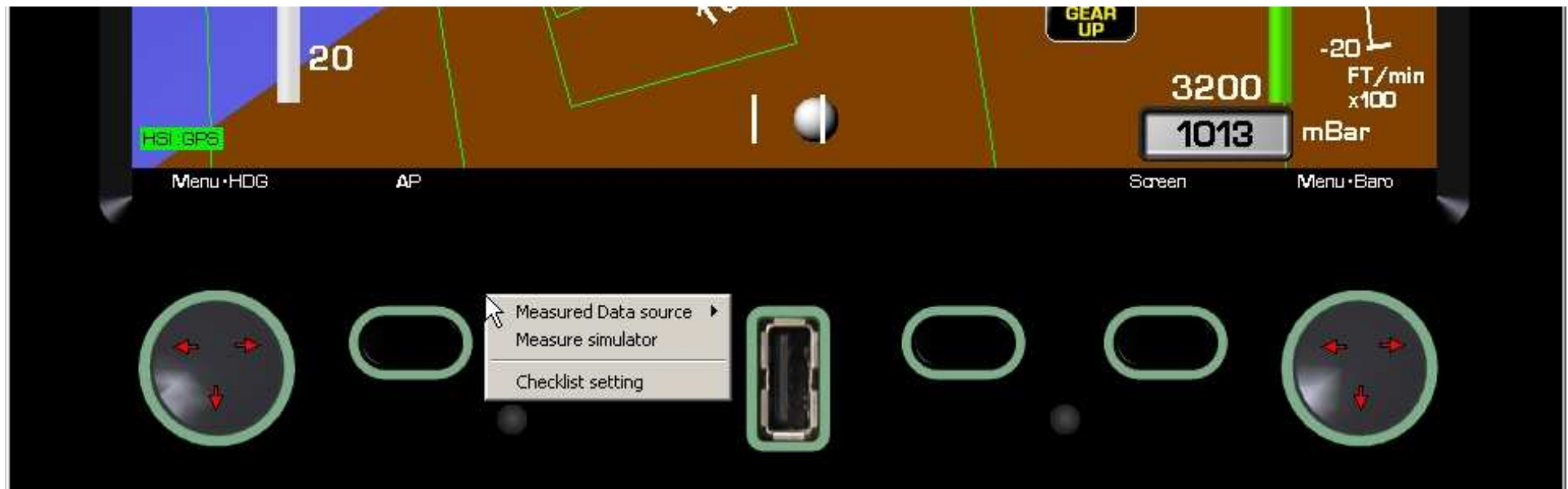

\*Demo PC application is same for all versions of the Integra

2) Select Checklist setting from context menu. The Checklist setting window will appear:

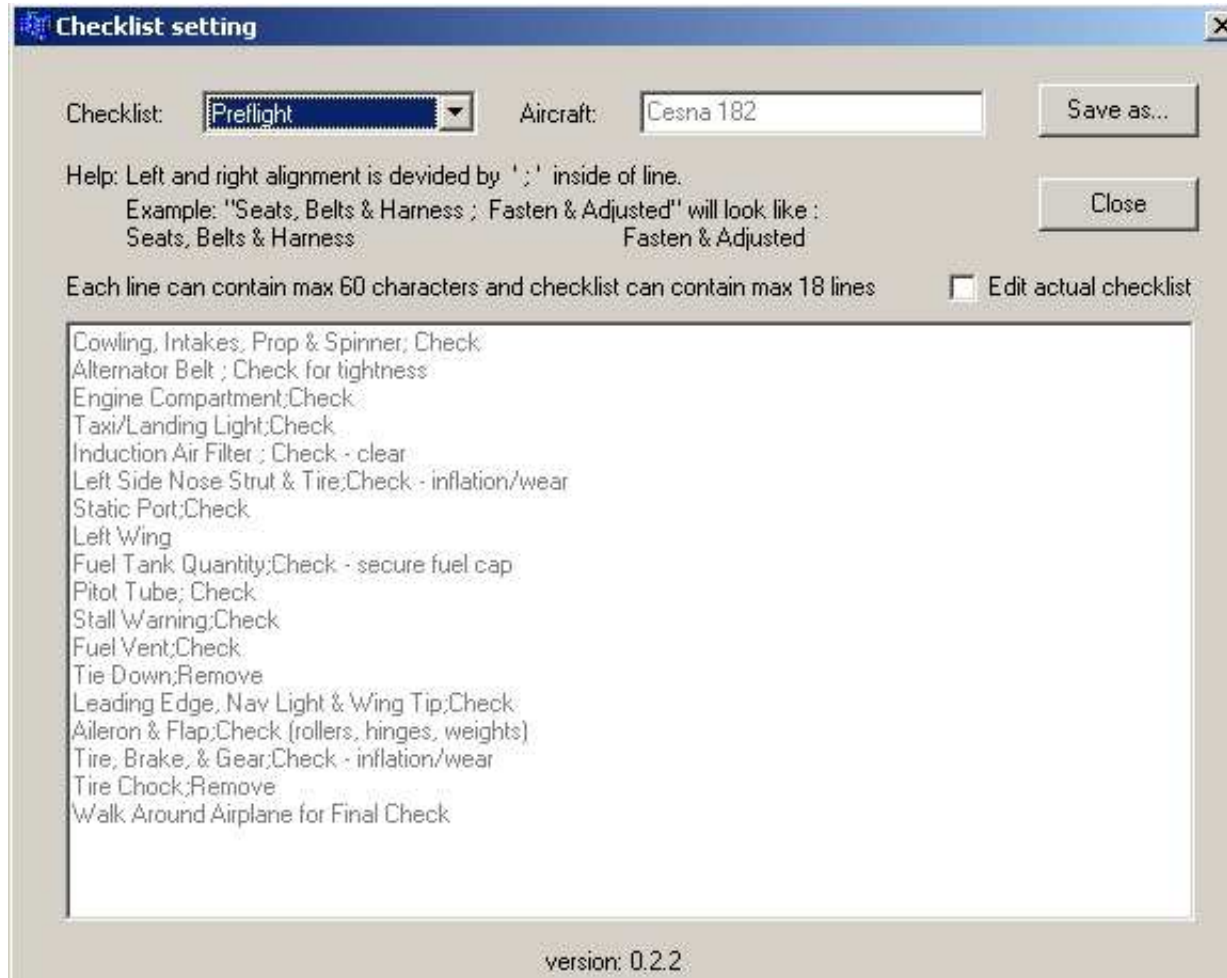

- 3) From drop-down list “Checklist” choose desired checklist for editing. Select check box “Edit actual checklist” to edit chosen checklist. Now text of appropriate checklist changed from gray to black and you can edit it. After you’ll be satisfied with content of all checklists, select button “Save as...” to save complete set of checklists at once. In “Save as” window choose root directory of your USB flash drive.

#### **The second step: Uploading checklists to the Integra**

- 4) Plug a USB flash drive into the USB port of the Integra. Allow 10 seconds for the Integra to read the drive. Press the right-hand knob to enter the menu and select Enter Setup. When prompt “Are you sure you want to enter to setup?” appears, press button “Yes”. Now the Integra is in Setup Mode. Button label “Data Port” is displayed. Press that button. In menu Data Port select Import Checklist.





### Update Firmware

#### The first step: PC operation

- 1) Create the “tle” directory and then create the “update” directory inside the “tle” on your USB flash drive. So the path will be: X:\tle\update
- 2) Copy the file “fwu.tls” to the “update” directory (on your USB flash drive).

#### The second step: Uploading firmware to the Integra

- 3) Plug USB flash drive into the USB port of the Integra. Allow 10 seconds for the Integra to read the drive. Press the right-hand knob to enter the menu and select Enter Setup. When prompt “Are you sure you want to enter to setup?” appears, press button “Yes”. Now the Integra is in Setup Mode. Button label “Data Port” is displayed. Press that button. In menu Data Port select Update Firmware.
- 4) Integra will display: "Are you sure you want to update firmware?" Press “yes”. There will be another warning message: "During operation do not power off instrument!!!" Press “OK”. The display shows you “Firmware update – Please wait while download is finished” while the firmware is loading. Do not touch any button or knob while the firmware is loading. The time for loading the firmware differs with every next firmware. The firmware loading time varies from each software upgrade package.

-  **CAUTION:** Ensure sustaining voltage during updating - if during updating fails the electric power supply, the Integra can be damaged.
-  **CAUTION:** Keep the USB flash drive connected with the Integra during updating.
-  **CAUTION:** This data port is intended only to be used with USB flash drive. Do not try to connect it to another USB device.

### Battery Installation

**⚡ WARNING:** Before installing battery turn off INTEGRA.

- Remove INTEGRA from mounting rack.
- Unscrew the battery cover located on the right side of the unit.
- After screw out carefully take off a sheet metal cover.
- The cable is attached to a holder of the battery with the baling wire – this wire must be removed.

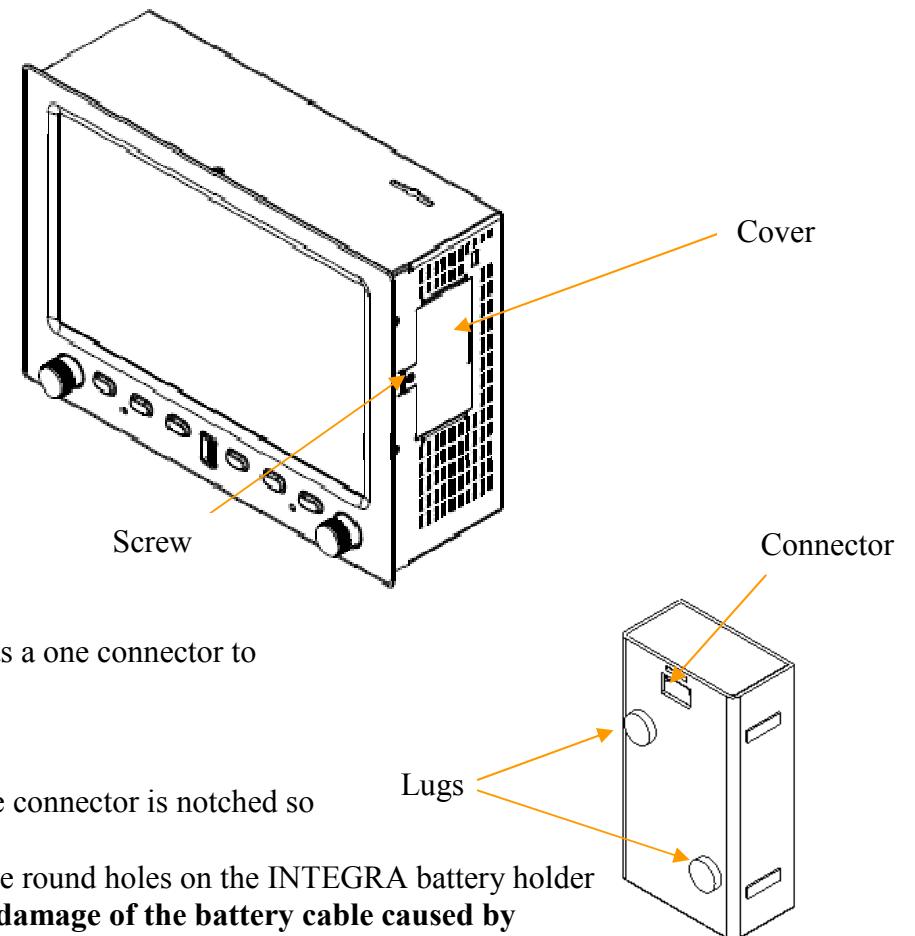

- The battery is intended to be used only with the INTEGRA. The Battery has a one connector to link it to INTEGRA and two lugs which nicely lock it to the battery holder.
- Connect the cables located in the battery holder to the Back-up battery. The connector is notched so you cannot connect this cable incorrectly to the battery.
- Put the battery in to the INTEGRA battery holder so that the lugs fit into the round holes on the INTEGRA battery holder and **the connector must be on the top. You should obey this to prevent damage of the battery cable caused by sharp edges of the battery holder.**



Cable for connecting INTEGRA with battery

Before screwing the cover on make sure that the battery is not protruding and is properly placed in the INTEGRA battery holder. Then screw battery cover back on to INTEGRA.

**⚡ WARNING:** To not apply pressure to the battery while re-installing the cover.

Correct battery installation in Integra

Incorrect battery installation in Integra

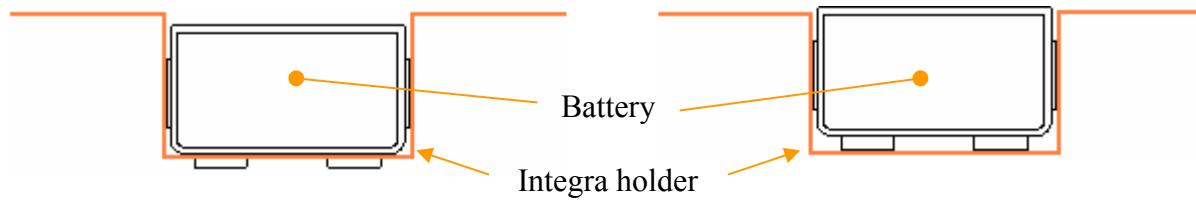

### SD card Installation

- Turn off INTEGRA.
- Remove INTEGRA from mounting rack.
- The slot for the SD card is situated on the top right side of INTEGRA.
- Now insert SD card into the slot so that the front SD card label is facing you.
- Carefully press the card down until you feel it click.
- The SD is now installed in the INTEGRA.
  
- If you want to remove the SD card, first carefully press down and the card will eject. You can then safely remove the card from the INTEGRA.

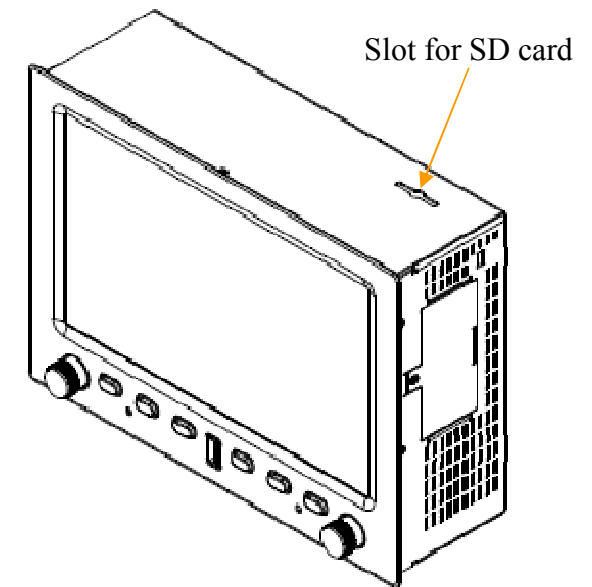

### Brightness

This controls the brightness of the LCD.

Press the right-hand knob and select Brightness. Rotate the knob to choose the level of brightness.

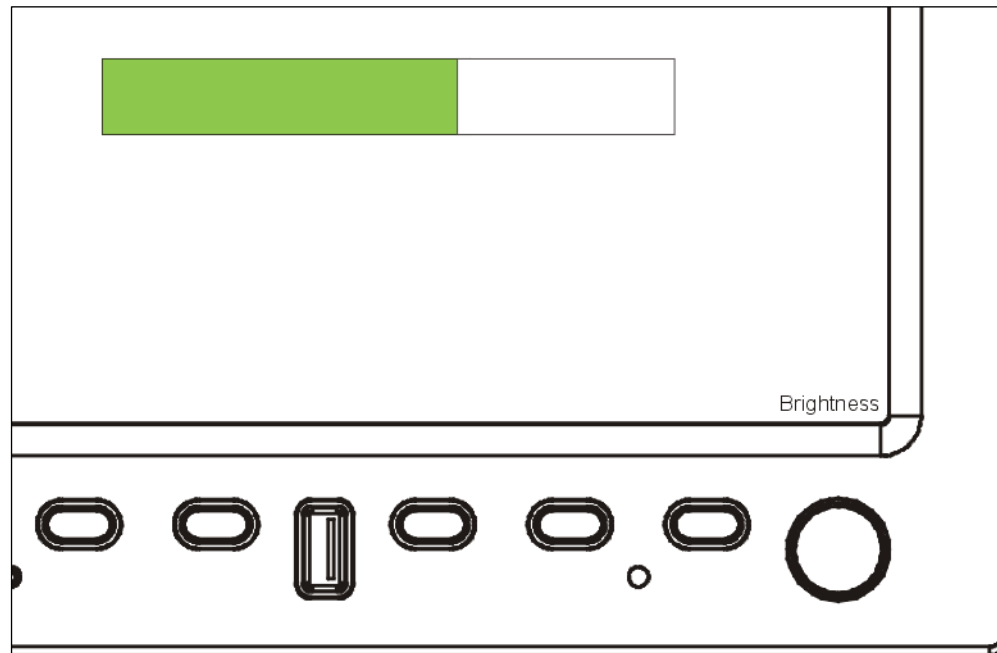

The green strip specifies level of brightness

- i NOTE:** This function is available only if DIMMER SOURCE CONTROL is set to MANUAL (Press the right-hand knob, select Enter Setup. When prompt “Are you sure you want to enter to setup?” appears, press button “Yes”. Now the Integra is in Setup Mode. Press the right-hand knob, select Other Setting & Calibration. New menu will appear. There select Backlight Control, then select Dimmer Source Control. Finally select Manual. Now manual setting of display brightness is enabled.

**Information about Battery**

**The INTEGRA utilizes a Lithium Polymer battery with the following characteristics:**

<b>Storage Temperature</b>	-20° C to 60° C (-4° F to 140° F)
<b>Recharge Life</b>	300 - 400 cycles

A Lithium Polymer battery operates without a memory effect, meaning it can be recharged before it is completely discharged without affecting the energy capacity.

- ⚠ CAUTION:** Keep the Battery Pack connector away from metallic objects.  
Any tampering of the cell within the INTEGRA Battery Pack is strictly forbidden in any circumstances.  
Do not immerse in water.  
Do not place near a heat source.  
Never heat the battery nor throw into a fire.  
Do not expose the battery pack to temperatures in excess of 60°C (140°F).

- ⚠ CAUTION:** The Integra Battery Pack is intended for use only with Integra Products.

**Disposal Procedures:**

For Ecological and Environmental reasons it is advisable to consult with local authorities for disposal regulations.

### Warning Signals

<b>GEAR UP</b>	Gear is safety engaged
<b>GEAR DOWN</b>	Gear is safety protuberant
<b>GEAR TRANSIT</b>	Gear is pushing up or pushing in or there is any problem with gear
<b>CNPY</b>	Canopy is open
<b>CO<sub>2</sub></b>	A dangerous quantity of CO <sub>2</sub> is in the cockpit
<b>ERR</b>	The information on measured quantity is not available
<b>EXTERNAL POWER</b>	INTEGRA is connected to an external power supply
<b>BATTERY POWER: --- min</b>	INTEGRA is power supply from battery

**i NOTE:** Landing gear position is shown by status indicators. Indicator should be used only as a backup. It is provided to give the pilot a single location to view the aircraft configuration. The Gear Lights located on the aircraft instrument panel should be viewed before landing. The INTEGRA can provide a gear up voice warning if the following functions are monitored: Gear Position and Airspeed. If Airspeed drops below a programmed level (set for your aircraft) and the Landing Gear is not down you will get a voice warning.

**INTEGRA Operation**



# Integra Operation

Description of complete EMS

\* and \*\* Further description on next page

## Description of complete EMS

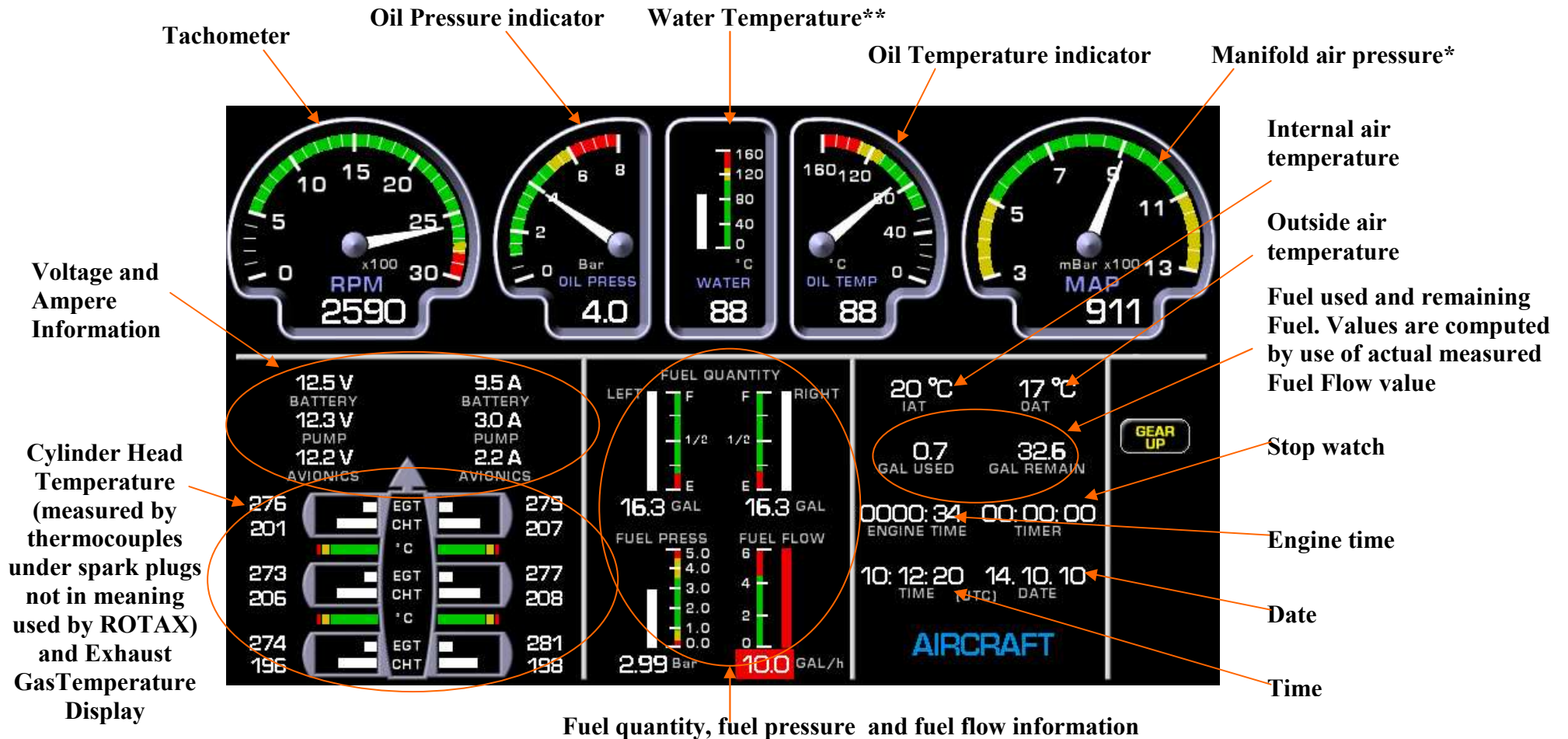

### Comment on specific EMS indicators

\* MAP (manifold air pressure) can be switched to ROTOR RPM for helicopters and other rotor aircraft



Indicator of ROTOR RPM



Indicator of MAP

#### The switch between the ROTOR RPM and MAP:

Press the right Menu-Baro knob and select Enter Setup. Press button with label “Yes”.

Press the knob and select Configuration & Sensors.

Now you can choose MAP and Rotor RPM and you can choose in each menu of this sensor, if you want to connect or not connect this sensor.

\*\*Water Temperature can be switched to CHT Temperature



Water Temperature

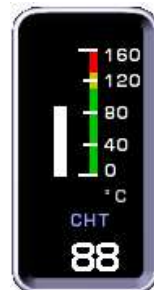

Cylinder Head Temperature  
(in meaning used by ROTAX,  
technically the sensor is  
placed on engine block)

#### The switch between Water Temperature and CHT Temperature:

Press the right Menu-Baro knob and select Enter Setup. Press button with label “Yes”.

Press the knob and select Other Setting & Calibration and then

Water CHT Temperature Label. Then you can choose option “Water” (for Water Temperature) or “CHT”.

### Description of function – EMS

---

<b>RPM</b>	Engine Revolutions Per Minute
<b>Rotor RPM</b>	If you use INTEGRA in helicopter, you can connect rotor RPM sensor to INTEGRA and this information will be displayed
<b>Oil press</b>	Indicator shows you actual oil pressure
<b>Left and Right</b>	Indicator quantity of fuel in left and right tank
<b>Oil Temp</b>	Indicator oil temperature

---

## Integra Menu

To enter the menu just press the right-hand knob with the Menu Label. Turn the knob to scroll through the menu titles then press the knob when the title is highlighted. Select the **Back Arrow** symbol to return to the previous menu or screen. Each Menu has an **EXIT MENU** title at the bottom. Press to select and exit the menu.

- **MENU·BARO**
  - *Brightness*
  - *Checklist*
  - *Statistic*
  - *Entertainment*
  - *Other Setting*
  - *Enter to Setup*
  - *Power Off*
  - *About*
  - *Exit Menu*

## Brightness

Instruction is therein before (page 28).

### Checklist

The Checklist is your most valuable tool to insure a safe flight. It is easy to miss a critical step in any phase of the flight (latch the canopy drop the landing gear, select the mains, etc.). Each checklist is determined by your aircraft make and model and is installed into the INTEGRA to be easily recalled by the pilot at a moment's notice.

You can edit this checklist on your computer and then you can copy via USB port on INTEGRA. Follow instructions in section Data Port (page 20).

- **Menu CHECKLIST**

- *Preflight check*
- *Before start engine*
- *Starting engine*
- *Engine runup*
- *Before take off*
- *Landing*
- *After landing*
- *Shut down*

Preflight check	instructions for a preflight check
Before start engine	instructions on what is needed to check before starting your engine
Starting engine	the procedures to start the engine
Engine run-up	a list of what is required during engine run-up
Before takeoff	a list of what needs to be checked before a takeoff
Landing	instruction about what is necessary before landing
After landing	a list of what must be done after landing
Shut down	instructions on what is needed to be done before shutting down

Cesna 152	
Preflight Checklist	
Cowling, Intakes, Prop & Spinner	Check
Alternator Belt	Check for tightness
Engine Compartment	Check
Taxi/Landing Light	Check
Induction Air Filter	Check - clear
Left Side Nose Strut & Tire	Check - inflation/wear
Static Port	Check
Left Wing	
Fuel Tank Quantity	Check - secure fuel cap
Pitot Tube	Check
Stall Warning	Check
Fuel Vent	Check
Tie Down	Remove
Leading Edge, Nav Light & Wing Tip	Check
Aileron & Flap	Check (rollers, hinges, weights)
Tire, Brake, & Gear	Check - inflation/wear
Tire Chock	Remove
Walk Around Airplane for Final Check	

For example: Checklist of Preflight  
check for Cesna 152

**Statistics for EMS**

Statistics provides a summary of Engine Information.

**EMS Statistics**

<b>RPM MIN</b>	Minimum rotations per minute
<b>RPM MAX</b>	Maximum rotations per minute
<b>OIL PRESS MIN</b>	Minimum oil pressure
<b>OIL PRESS MAX</b>	Maximum oil pressure
<b>OIL TEMP MIN</b>	Minimum oil temperature
<b>OIL TEMP MAX</b>	Maximum oil temperature
<b>ROTOR RPM MIN</b>	Minimum rotor rotations per minute
<b>ROTOR RPM MAX</b>	Maximum rotor rotations per minute
<b>FUEL PRESS MIN</b>	Minimum fuel pressure
<b>FUEL PRESS MAX</b>	Maximum fuel pressure
<b>FUEL FLOW MIN</b>	Minimum fuel flow
<b>FUEL FLOW MAX</b>	Maximum fuel flow
<b>IAT MIN</b>	Minimum inside air temperature
<b>IAT MAX</b>	Maximum inside temperature
<b>OAT MIN</b>	Minimum outside air temperature
<b>OAT MAX</b>	Maximum outside air temperature
<b>EGT1 MAX</b>	Maximum exhaust temperature of cylinder 1
<b>EGT2 MAX</b>	Maximum exhaust temperature of cylinder 2
<b>EGT3 MAX</b>	Maximum exhaust temperature of cylinder 3
<b>EGT4 MAX</b>	Maximum exhaust temperature of cylinder 4
<b>CHT1 MAX</b>	Maximum temperature on cylinder 1(measured by thermocouple under spark plug)
<b>CHT2 MAX</b>	Maximum temperature on cylinder 2(measured by thermocouple under spark plug)
<b>CHT3 MAX</b>	Maximum temperature on cylinder 3(measured by thermocouple under spark plug)
<b>CHT4 MAX</b>	Maximum temperature on cylinder 4(measured by thermocouple under spark plug)

IIN = 0 °C	IAT MAX = 20 °C
MIN = 0 °C	OAT MAX = 17 °C
MAX = 280 °C	CHT1 MAX = 282 °C
MAX = 277 °C	CHT2 MAX = 275 °C
MAX = 278 °C	CHT3 MAX = 214 °C
MAX = 274 °C	CHT4 MAX = 208 °C

Delete values Hide



If Statistics are displayed, the basic menu is changed.

HIDE – statistic screen is closed

DELETE VALUES – you can erase statistic values

If you press Delete values, INTEGRA ask you, if “Are you sure you want to delete statistic?” If you press “Yes” the statistic will be deleted. If you press “No” the statistic will be conserved.

### Configuration of Integra

#### Enter to setup

In setup you can edit many parameters as you wish such as units, configuration & sensors, limits, other setting & calibration and external devices. Press the right-hand knob and select Enter Setup. When prompt “Are you sure you want to enter to setup” appears, press button “Yes”.

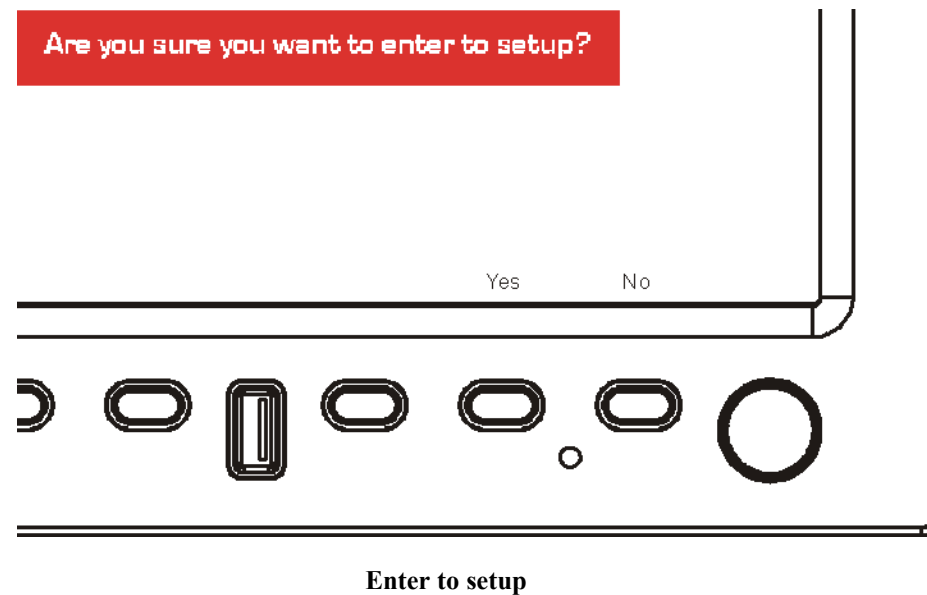

**i** **NOTE:** More about SETUP menu you can find in CONFIGURATION MANUAL.



## Power Off

You can turn the Integra off by pressing the Power Off button. You have 20 seconds to cancel this operation. Just press any knob or button.

**i NOTE:** When you power up the Integra and the Integra starts to shut off, press any button and it is necessary to disconnect the Main Switch Signal. (Menu Setup– Other Setting & Calibration – Main Switch Control).

## About

There you can find the information about your Integra.

HW version	Information about the hardware version
GUI version	Information about the graphics interface
Release	Information about the firmware version

**Menu Entertainment**

Menu Entertainment serves for access to multimedia functions of the Integra. You can listen to your favourite music or watch movies. These multimedia possibilities of the Integra enrich passengers' experience from flight.

**To enter Entertainment Menu:**

Press the right-hand knob, select option Entertainment from menu. When prompt "Do you want to enter to Entertainment?" appears, press button Yes.

Now the Integra is displaying Entertainment Screen:



### Handling the menu

Rotate the right-hand knob for scrolling through menu. Select desired function by pressing the right-hand knob.

**i NOTE:** If you want to open multimedia file on plugged SD card, you won't be able to have connected USB flash drive. That's because the Integra will check primarily for connected USB flash drive. Then if USB flash drive isn't found, the Integra will check for SD card. And if SD card is not either plugged, then the Integra will load files from internal memory.

### Option Movie

Probably you want to watch some movie on your USB flash drive or SD card. To do this, follow these instructions:

Press the left-hand knob "Open". Window will appear for selecting video file. There you can scroll through currently viewed directory by rotating the left-hand knob. Names of displayed subdirectories are closed in square brackets [ ]. Playable files are displayed with postfix ".3gp".

If you want to move down to some subdirectory, choose desired subdirectory and press the left-hand knob.

If you want to move up to the parent directory, choose item [..] and press the left-hand knob.

For replaying desired video file, just choose appropriate item and press the left-hand knob. The Integra should be replaying your video now.

For maximizing video presentation to full screen press button "Maximize". For returning to previous screen, press any button.

**i NOTE:** The Integra only supports .3gp video format. Other files-video of different format or any other data aren't displayed in Select video file window.

elapsed time of video

remaining time of video

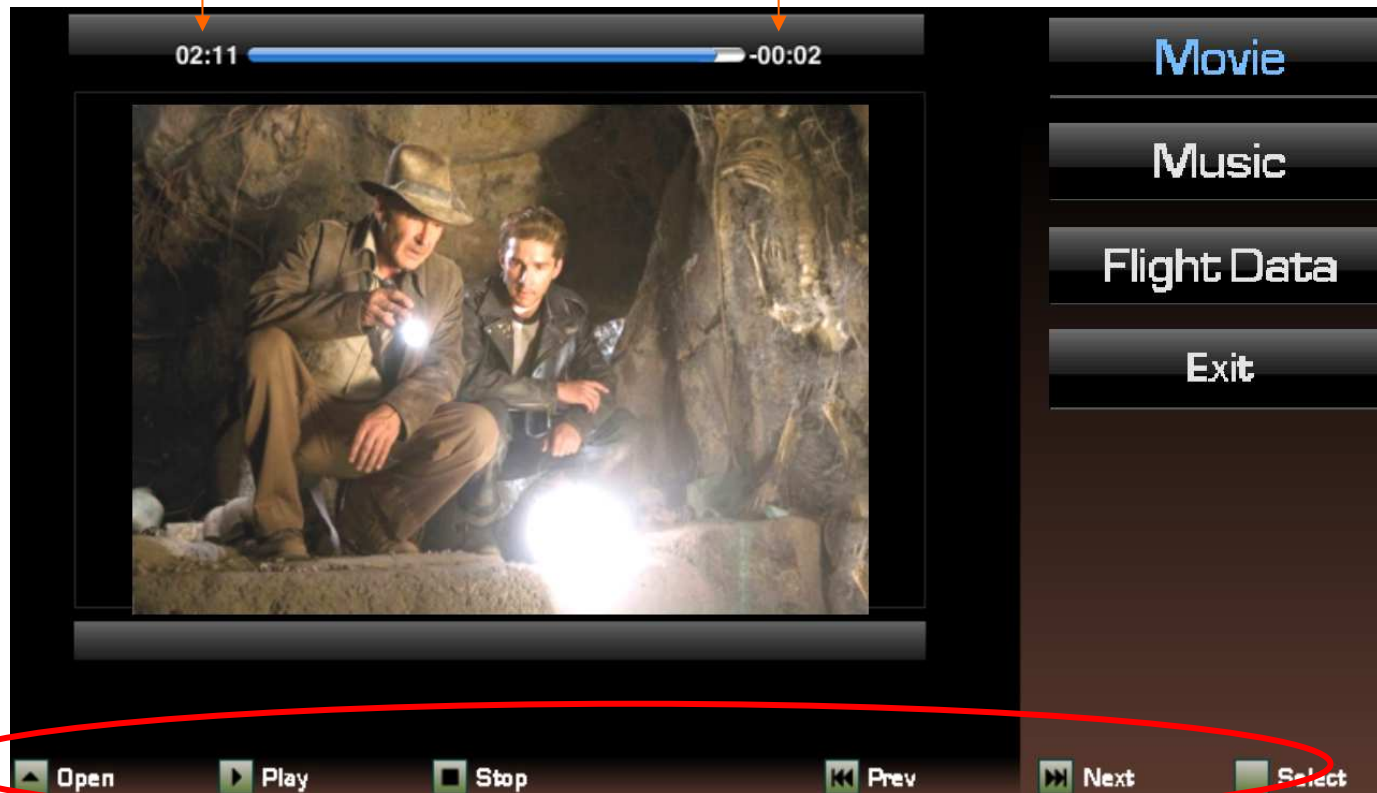

**buttons' labels**

Opens window for selecting desired video file or folder

Plays currently stopped video

Stops currently played video

Plays previous track

Plays next track

**Option Music**

**NOTE:** The Integra only supports MP3 audio files.

The screenshot shows a music player interface. At the top, the track name "Bye Bye Love" is displayed. Below it is a progress bar showing "0:21" elapsed time and "3:29" remaining time. A "1 of 4" indicator is shown below the progress bar. There are icons for loop playing mode (a circular arrow) and shuffle playing mode (two crossed arrows). On the right side, there are menu options: "Movie", "Music" (highlighted in blue), "Flight Data", and "Exit". At the bottom, there is a row of control buttons: "Open", "Play", "Stop", "Prev", "Next", and "Select". A red oval highlights these buttons. Arrows point from text labels to various elements in the interface.

elapsed time of track

name of currently played track

remaining time of track

loop playing mode

number of currently played track in list and total number of tracks in list

shuffle playing mode

**buttons' labels**

Opens window for selecting desired track or folder

Plays currently stopped track

Stops currently played track

Plays previous track

Plays next track

**Option Flight Data**

This option soothes desire for flight info of impatient and curious passengers. It displays Airspeed, Altitude and Time to arrival.

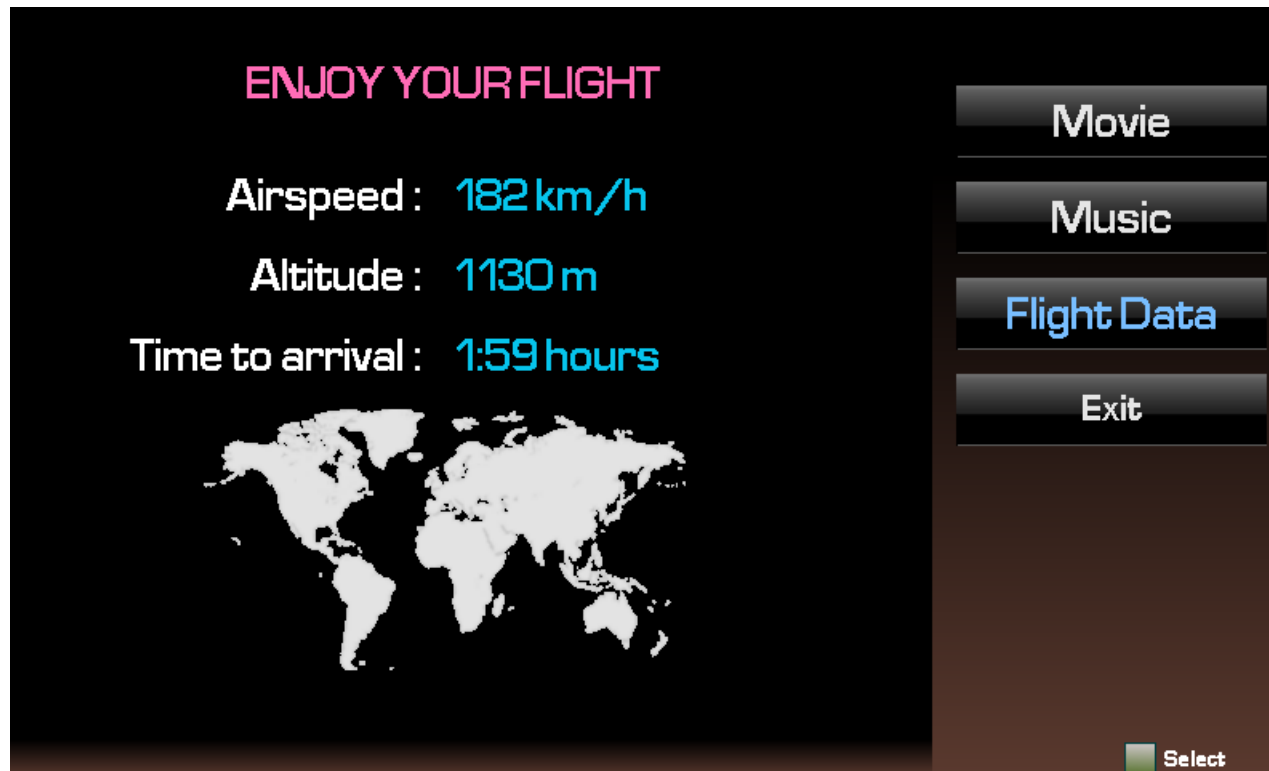

**Option Exit**

The option exits Entertainment Screen.

## Abbreviations

**ACTV**— Active  
**ALT**— Altitude  
**APR**— Approach  
**APT**— Airport  
**ARSPC**— Airspace  
**ARTCC**— Air Route Traffic Control Center  
**ARVL**— Arrival  
**AUX**— Auxiliary  
**AVGAS**— Aviation-grade Gasoline  
**AVTN**— Aviation  
**BARO**— Barometric setting  
**BRG**— Bearing To  
**°C**— Degree Celsius  
**C/V**— COM/VLOC  
**CAS**— Calibrated Airspeed  
**CDI**— Course Deviation Indicator  
**CLR**— Clear  
**COM**— Communications Transceiver  
**CRSR**— Cursor  
**CTA**— ICAO Control Area  
**CTAF**— Common Traffic Advisory Frequency  
**CTR**— Center (see ARTCC)  
**CUM**— Cumulative  
**DB**— Database  
**DEN**— Density  
**DEP**— Departure  
**DEPT**— Departure guidance  
**DIS**— Distance

**DME**— Distance Measuring Equipment  
**DTK**— Desired Track  
**EFF**— Efficiency  
**ELEV**— Elevation  
**ENDUR**—Endurance  
**ENR**— En Route  
**ENT**— Enter  
**EPU**— Estimated Position Uncertainty  
**ESA**— En Route Safe Altitude  
**ETA**— Estimated Time of Arrival  
**ETE**— Estimated Time En Route  
**°F**— Degrees Fahrenheit  
**FAF**— Final Approach Fix  
**FF**— Fuel Flow  
**FIR**— Flight Information Region  
**FLTA**— Forward Looking Terrain Avoidance  
**FOB**— Fuel On Board  
**FPL**— Flight Plan  
**fpm**— Feet Per Minute  
**FREQ**— Frequency  
**FSS**— Flight Service Station  
**ft**— Feet  
**G/S**— Glideslope  
**gal**— gallons  
**GPS**— Global Positioning System  
**GS**— Ground Speed  
**HAL**— Horizontal Alarm Limit  
**HDG**— Heading

**HFOM**— Horizontal Figure of Merit  
**hg**— Inches of Mercury  
**HPL**— Horizontal Protection Level  
**HITS**— Highway in the Sky  
**HWY**— Highway  
**IAF**— Intermediate Approach Fix  
**ID**— Identifier  
**ig**— Imperial Gallons  
**ILS**— Instrument Landing System  
**IND**— Indicated  
**INT**— Intersection  
**INTEG**— Integrity  
**ITI**— Imminent Terrain Impact  
**kg**— Kilograms  
**kHz**— Kilohertz  
**km**— Kilometers  
**kph**— Kilometers Per Hour  
**kt**— Knots  
**L/VNAV** — Lateral and vertical navigation guidance, LNAV/VNAV service level  
**LAT/LON**—Latitude/Longitude  
**lb**— Pounds  
**LCL**— Local  
**LFOB**— Left-over Fuel On Board  
**LNAV** — Lateral Navigation only  
**LNAV+V** — Lateral Navigation with advisory vertical guidance  
**LOC**— Localizer



**LPV** — Lateral Precision Performance with Vertical Guidance  
**LRES**— Left-over Fuel Reserve Time  
**Lrg**— Large  
**lt**— Liters  
**°M**— Degrees Magnetic  
**m**— Meters  
**MAP**— Missed Approach Point  
**MAHP**— Missed Approach Hold Point  
**MAPR**— Missed Approach guidance  
**mb**— Millibars of Pressure  
**Med**— Medium  
**MGRS**— Military Grid Reference System  
**MHz**— Megahertz  
**mi**— Statute Miles  
**MOA**— Military Operations Area  
**mph**— Statute Miles Per Hour  
**mpm**— Meters Per Minute  
**mps**— Meters Per Second  
**MSA**— Minimum Safe Altitude  
**MSG**— Message  
**MSL**— Mean Sea Level  
**mul**— Multicom  
**NATNL**— National  
**NAV**— Navigation  
**NAVAID**— Navigational Aid  
**NDB**— Non-Directional Radio Beacon  
**NM**— Nautical Miles  
**NRST**— Nearest  
**NUM**— Number

**OBS**— Omnibearing Selector  
**OCN**— Oceanic  
**PDA**— Premature Descent Alert  
**P.POS**— Present Position  
**PROC**— Procedure(s)  
**PROV**— Province  
**PTK**— Parallel Track  
**PWR**— Power  
**RAD**— Radial  
**RAIM**— Receiver Autonomous Integrity Monitoring  
**REF**— Reference  
**REQ**— Required / Requirements  
**RESTRICTD**— Restricted  
**RNG**— Range  
**RTC**— Required Terrain Clearance  
**RX**— Receive  
**SBAS**— Space-Based Augmentation System  
**SID**— Standard Instrument Departure  
**Sml**— Small  
**SPD**— Speed  
**SQ**— Squelch  
**SRFC**— Surface  
**STAR**— Standard Terminal Arrival Route  
**SUA**— Special Use Airspace  
**SUSP**— Waypoint sequencing suspended  
**°T**— Degree True  
**TACAN**— Tactical Air Navigation  
**TAS**— True Airspeed  
**TAT**— Total Air Temperature

**TEMP**— Temperature  
**TER**— Terrain  
**TERM**— Terminal  
**TKE**— Track Angle Error  
**TMA**— ICAO Terminal Control Area  
**TRANS**— Transition  
**TRFC**— Traffic  
**TRK**— Track (also Ground Track) Angle  
**TRSA**— Terminal Radar Service Area  
**TWR**— Tower  
**TX**— Transmit  
**UTC**— Coordinated Universal Time (also GMT or “zulu”)  
**UTM/UPS**— Universal Transverse Mercator / Universal Polar Stereographic grids  
**VAL**— Vertical Alarm Limit  
**VAR**— Variation  
**VER**— Version  
**VFOM**— Vertical Figure of Merit  
**VFR**— Visual Flight Rules  
**VLOC**— VOR/Localizer Receiver  
**VNAV**— Vertical Navigation  
**VOL**— Volume  
**VOR**— VHF Omnidirectional Radio Range  
**VPL**— Vertical Protection Level  
**VS**— Vertical Speed  
**VSR**— Vertical Speed Required  
**WAAS**— Wide Area Augmentation System  
**WPT**— Waypoint  
**WX**— Weather  
**XTK**— Crosstrack Error

## Technical Parameters

### Physical characteristic

Width	240.8 mm	9.480"
Height	178 mm	7.008"
Depth	75.5 mm	2.972"
Panel rectangle hole	233.8x172 mm	9.205"x6.772"
Weight without battery	1533 g	3.38 lb
Weight with battery	1633 g	3.60 lb

### General Specifications

Operating Temperature Range	- 20°C to +60°C
Humidity	95% non-condensing
Altitude Range	10000 meters max (32808 feet max)
Power Range	10.0 to 32.0 Volts
Max. Signalization	30 Volts, 1 Ampere
Power Consumption	1.15 Ampere @ 14VDC without ext. sensors 1.83 Ampere when battery is charging
Vibration	5 to 500 Hz
Show Rate (LCD Refresh)	15 fps depends on volume of information displayed

### Long-term Memory and communication

Storing Rate	0.1 to 60 seconds user selectable
Memory Capacity	Scheck®method
Data Saved Endurance	30 years
Rolling Memory life-time	100 000 hours @ 1 second storing rate

## Communication

RS-232c	up to 115 200 bps
USB 1.1	12 Mb/s
USB 2.0	480 Mb/s
CAN BUS	1 Mb/s

## Display parameters

Resolution	800x480
Brightness	800 cd/m <sup>2</sup>

<b>Memory card</b>	Integra support SD and SDHC memory card
--------------------	---





© 2013 TL elektronik  
or its subsidiaries

# INTEGRA EMS TL-6760 USER MANUAL



Part Number

**TLX-6760X-DU-001-PrA**

## Europe

TL elektronik Inc.  
Airport, Building 125  
50341 Hradec Kralove  
Czech Republic  
E-mail: [info@tl-elektronic.com](mailto:info@tl-elektronic.com)  
[www.tl-elektronic.com](http://www.tl-elektronic.com)