

**EGS**

Electrical Group

**SOLA/  
HEVI-DUTY**

**POWER AVAILABILITY**

# **S4K4U6000 USER MANUAL**



*On-Line UPS*  
**120/208V**  
**120/240V**



---

# TABLE OF CONTENTS

|  |           |
|--|-----------|
| <b>IMPORTANT SAFETY INSTRUCTIONS</b> .....                                     | <b>1</b>  |
| <b>1.0 GLOSSARY OF SYMBOLS</b> .....   | <b>3</b>  |
| <b>2.0 INTRODUCTION AND SYSTEM DESCRIPTION</b> .....                           | <b>4</b>  |
| <b>3.0 SYSTEM DESCRIPTION</b> .....  | <b>5</b>  |
| 3.1 Transient Voltage Surge Suppression (TVSS) and EMI/RFI Filters.....        | 5         |
| 3.2 Rectifier/Power Factor Correction (PFC) Circuit .....                      | 5         |
| 3.3 Inverter .....   | 5         |
| 3.4 Battery Charger .....  | 5         |
| 3.5 DC to DC Converter .....   | 6         |
| 3.6 Battery .....  | 6         |
| 3.7 Dynamic Bypass .....   | 6         |
| <b>4.0 MAJOR COMPONENTS</b> .....  | <b>7</b>  |
| 4.1 Main Frame and Electronics .....   | 7         |
| 4.2 Internal Battery Pack .....  | 7         |
| 4.3 Removable Power Distribution Box.....                                      | 8         |
| <b>5.0 WHAT'S INCLUDED</b> .....   | <b>9</b>  |
| <b>6.0 INSTALLATION AND CONFIGURATION</b> .....                                | <b>10</b> |
| 6.1 Install the Main Cabinet .....   | 10        |
| 6.1.1 Tower UPS Installation .....   | 10        |
| 6.1.2 Installing the Adjustable Rack-Mount Kit—Sold Separately .....           | 11        |
| 6.2 External Battery Cabinet Installation .....                                | 13        |
| 6.3 Connect Input/Output Power.....  | 14        |
| 6.3.1 Replacing a power distribution box.....                                  | 14        |
| 6.3.2 Distribution Box Electrical Connections .....                            | 14        |
| 6.3.3 S4KPAD-HDWR and S4KPAD-HDWR-MBS Terminal Block Connections .....         | 15        |
| 6.3.4 S4KPAD-001 Power Distribution Box.....                                   | 15        |
| 6.4 Install the Grounding Electrode Conductor .....                            | 16        |
| 6.5 Install the Internal Battery Pack .....                                    | 16        |
| <b>7.0 INITIAL STARTUP AND ELECTRICAL CHECKS</b> .....                         | <b>17</b> |
| 7.1 L14-30P Plug-in Connections—Including the S4KPAD-001 Distribution Box..... | 18        |

---

|            |  |           |
|------------|--|-----------|
| <b>8.0</b> | <b>CONFIGURATION PROGRAM</b>   | <b>19</b> |
| 8.1        | S4K4U6000 Configuration Program Features                                 | 19        |
| 8.1.1      | What You Will Need   | 19        |
| 8.2        | Configuration Program—Installation                                       | 20        |
| 8.3        | Establishing Communication Link with the UPS                             | 21        |
| 8.4        | Configuration Program—Operation  | 22        |
| 8.4.1      | Read/Confirm UPS Configuration Settings                                  | 22        |
| 8.4.2      | Changing UPS Settings  | 22        |
| 8.4.3      | Programming Rejected?  | 22        |
| 8.4.4      | Exit Without Changing UPS Settings                                       | 22        |
| 8.5        | UPS Tab  | 23        |
| 8.5.1      | Output Voltage   | 23        |
| 8.5.2      | Auto Restart   | 23        |
| 8.5.3      | L-N Reverse Detection (120V UPS Models Only)                             | 23        |
| 8.5.4      | Frequency Selection  | 24        |
| 8.6        | Options Tab  | 24        |
| 8.7        | Options Tab Used With Earlier S4K Models                                 | 25        |
| 8.8        | Battery Tab  | 26        |
| 8.8.1      | Low Battery Time Warning   | 26        |
| 8.8.2      | Auto Battery Test Time   | 26        |
| 8.8.3      | Battery Cabinets Number  | 26        |
| 8.8.4      | Auto Battery Test  | 26        |
| 8.9        | About Tab  | 27        |
| <b>9.0</b> | <b>CONTROLS AND INDICATORS</b>   | <b>28</b> |
| 9.1        | ON/Alarm Silence/Battery Test Button                                     | 28        |
| 9.2        | OFF/Bypass Button  | 28        |
| 9.3        | L1 & L2 Load Level Indicators (Two Rows of Indicators: 4 Green, 1 Amber) | 29        |
| 9.4        | Battery Level Indicators (5 Green)                                       | 29        |
| 9.5        | Fault Indicator (Red)  | 29        |
| 9.6        | Bypass Indicator (Amber)   | 29        |
| 9.7        | UPS ON Indicator (Green)   | 29        |
| 9.8        | Battery Indicator (Amber)  | 29        |
| 9.9        | AC Input Indicator (Green)   | 29        |

---

|             |   |           |
|-------------|---|-----------|
| <b>10.0</b> | <b>MODES OF OPERATION</b> .....                   | <b>30</b> |
| 10.1        | Normal Mode Operation .....                       | 30        |
| 10.2        | Battery Mode Operation .....                      | 30        |
| 10.3        | Battery Recharge Operation .....                  | 30        |
| <b>11.0</b> | <b>COMMUNICATIONS</b> .....                       | <b>31</b> |
| 11.1        | Communications Interface Port .....               | 31        |
| 11.1.1      | DB-9 Interface Port .....                         | 31        |
| 11.1.2      | Communications SNMP Adapter - SNMP WEB CARD ..... | 31        |
| 11.2        | Pin 4 - Remote Shutdown on Battery .....          | 32        |
| 11.3        | UPS Intelligent Communications .....              | 32        |
| 11.4        | Remote Emergency Power Off .....                  | 33        |
| <b>12.0</b> | <b>MAINTENANCE</b> .....                          | <b>34</b> |
| 12.1        | Battery Replacement .....                         | 34        |
| 12.1.1      | Internal Battery Replacement Procedures .....     | 34        |
| 12.2        | UPS Replacement .....                             | 35        |
| <b>13.0</b> | <b>TROUBLESHOOTING</b> .....                      | <b>36</b> |
| 13.1        | Auto-Learning Battery Run Times .....             | 40        |
| <b>14.0</b> | <b>SPECIFICATIONS</b> .....                       | <b>41</b> |
| 14.1        | Product Warranty Registration .....               | 43        |

---

## FIGURES

|          |  |    |
|----------|--|----|
| Figure 1 | 6 kVA Dual Inverter S4K (front and rear views) . . . . . | 7  |
| Figure 2 | Support base and spacers . . . . .                       | 10 |
| Figure 3 | 30A branch circuit breaker connection diagram . . . . .  | 14 |
| Figure 4 | Factory default settings for 120VAC UPS . . . . .        | 23 |
| Figure 5 | REPO switch connections . . . . .                        | 33 |

## TABLES

|          |   |    |
|----------|---|----|
| Table 1  | Electrical requirements—S4KPAD-HDWR and S4KPAD-HDWR-MBS . . . . . | 15 |
| Table 2  | Electrical requirements—S4KPAD-001 . . . . .                      | 15 |
| Table 3  | DB-9 pin assignment . . . . .                                     | 31 |
| Table 4  | Fault indicators . . . . .  | 36 |
| Table 5  | Alarm conditions . . . . .  | 37 |
| Table 6  | Troubleshooting guide . . . . .                                   | 37 |
| Table 7  | Battery run times . . . . .                                       | 39 |
| Table 8  | UPS specifications . . . . .                                      | 41 |
| Table 9  | Battery specifications . . . . .                                  | 42 |
| Table 10 | Power distribution box specifications . . . . .                   | 42 |
| Table 11 | External battery cabinet specifications . . . . .                 | 43 |

---

## IMPORTANT SAFETY INSTRUCTIONS

---



### WARNING

Opening or removing the cover may expose you to lethal voltages within this unit even when it is apparently not operating and the input wiring is disconnected from the electrical source. Observe all cautions and warnings in this manual. Failure to do so may result in serious injury or death. Refer all UPS and battery service to qualified service personnel. Do not attempt to service this product yourself. Never work alone.

## SAVE THESE INSTRUCTIONS

This manual contains important safety instructions. Read all safety, installation and operating instructions before operating the Uninterruptible Power System (UPS). Adhere to all warnings on the unit and in this manual. Follow all operating and user instructions. Individuals without previous training can install and operate this equipment.

It is not intended for use with life support and other designated critical devices. Maximum load must not exceed that shown on the UPS rating label. The UPS is designed for data processing equipment. If uncertain, consult your local dealer or Sola/Hevi-Duty representative.

This UPS is designed for use on a properly grounded (earthed), 100/200, 110/220, 115/230, 120/208, 120/240 or 127/220 VAC, 50 Hz or 60 Hz supply. The factory default setting is 120/208 VAC, 60 Hz. Installation instructions and warning notices are located in this manual.

This UPS is only for use with a four-wire input (L1, L2, N, G).

This UPS MAY NOT be used with a three-wire, single-phase utility source (L1, N, G).

**ELECTROMAGNETIC COMPATIBILITY**—The S4K4U6000 Series complies with the limits for a CLASS A DIGITAL DEVICE, PURSUANT TO Part 15 of FCC rules. Operation is subject to the following two conditions: (1) This device may not cause harmful interference and (2) this device must accept any interference received, including interference that may cause undesired operation. Operating this device in a residential area is likely to cause harmful interference that users must correct at their own expense.

Operate the UPS in an indoor environment only in an ambient temperature range of 32°F to +104°F (0°C to +40°C). Install it in a clean environment, free from conductive contaminants, moisture, flammable liquids, gases and corrosive substances.

This UPS contains no user serviceable parts except the internal battery pack. The Off/Bypass push button does not electrically isolate internal parts. Under no circumstances attempt to gain access internally other than to replace the batteries due to risk of electric shock or burn. Do not continue to use the UPS if the front panel indications are not in accordance with these operating instructions or if the UPS performance alters in use. Refer all faults to your local dealer, Sola/Hevi-Duty representative or Sola/Hevi-Duty Technical Services.

Servicing of batteries should be performed or supervised by personnel knowledgeable of batteries and the required precautions. Keep unauthorized personnel away from the batteries. **PROPER DISPOSAL OF BATTERIES IS REQUIRED. REFER TO YOUR LOCAL LAWS AND REGULATIONS FOR BATTERY DISPOSAL REQUIREMENTS.**

Never block or insert any object into the ventilation holes or other openings of the UPS.

DO NOT CONNECT equipment that could overload the UPS or demand half-wave rectification from the UPS, for example: electric drills, vacuum cleaners, laser printers, hair dryers or any other appliance using half-wave rectification.

Storing magnetic media on top of the UPS may result in data loss or corruption.

Turn the UPS off and isolate the UPS before cleaning; use only a soft cloth, never liquid or aerosol cleaners. Keep the front and rear vents free of dust accumulation that could restrict airflow.

---

When replacing batteries, replace with the same Sola/Hevi-Duty authorized replacement battery kits.



## CAUTION

Do not dispose of battery or batteries in a fire. The battery may explode.  
Do not open or mutilate the battery or batteries. Released electrolyte is harmful to skin and eyes. It may be toxic.



## CAUTION

A battery can present a risk of electrical shock and high short circuit current. The following precautions should be observed when working on batteries:













- Remove watches, rings and other metal objects.
- Use tools with insulated handles.
- Wear rubber gloves and boots.
- Do not lay tools or metal parts on top of batteries.
- Disconnect charging source prior to connecting or disconnecting battery terminals.
- Determine if the battery is inadvertently grounded. If inadvertently grounded, remove source of ground. Contact with any part of a grounded battery can result in electrical shock. The likelihood of such shock will be reduced if such grounds are removed during installation and maintenance (applicable to a UPS and a remote battery supply not having a grounded supply circuit).

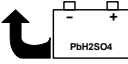

---

## 1.0 GLOSSARY OF SYMBOLS

---

|   |  |
|---|--|
|    | <b>Risk of electrical shock</b>  |
|    | <b>Indicates caution followed by important instructions</b>            |
|    | <b>AC input</b>  |
|    | <b>AC output</b>   |
|    | <b>Requests the user to consult the manual</b>                         |
|    | <b>Indicates the unit contains a valve-regulated lead acid battery</b> |
|    | <b>Recycle</b>   |
|  | <b>DC voltage</b>  |
|  | <b>Equipment grounding conductor</b>                                   |
|  | <b>Bonded to ground</b>  |
|  | <b>AC voltage</b>  |
|  | <b>ON/Alarm Silence/Battery Test</b>                                   |
|  | <b>OFF/Bypass</b>  |

## **2.0 INTRODUCTION AND SYSTEM DESCRIPTION**

---

Congratulations on your choice of the Sola/Hevi-Duty S4K4U Uninterruptible Power Supply (UPS). It provides conditioned power to microcomputers and other sensitive electronic equipment.

Upon generation, AC power is clean and stable. However, during transmission and distribution it is subject to voltage sags, spikes or complete power failure that may interrupt computer operations, cause data loss or even damage equipment. The S4K4U6000 protects equipment from these disturbances.

The S4K4U6000 is a compact, on-line UPS. An on-line UPS continuously conditions and regulates its output voltage whether utility power is present or not. It supplies connected equipment with clean sinewave power. Sensitive electronic equipment operates best from sinewave power.

For ease of use, the S4K4U6000 features a light-emitting diode (LED) display to indicate both load percentage and battery capacity. It also provides self-diagnostic tests, a combination ON/Alarm Silence/Battery Test button, a Standby button, user configurable program and two levels of alarms when the unit is operating on battery.

The S4K4U6000 has an interface port for communication between the UPS and a network server or other computer systems. This port provides detailed operating information including voltages, currents and alarm status to the host system when used in conjunction with Sola/Hevi-Duty's Multi-Link™ software. MultiLink software can also control UPS operation remotely.

### 3.0 SYSTEM DESCRIPTION

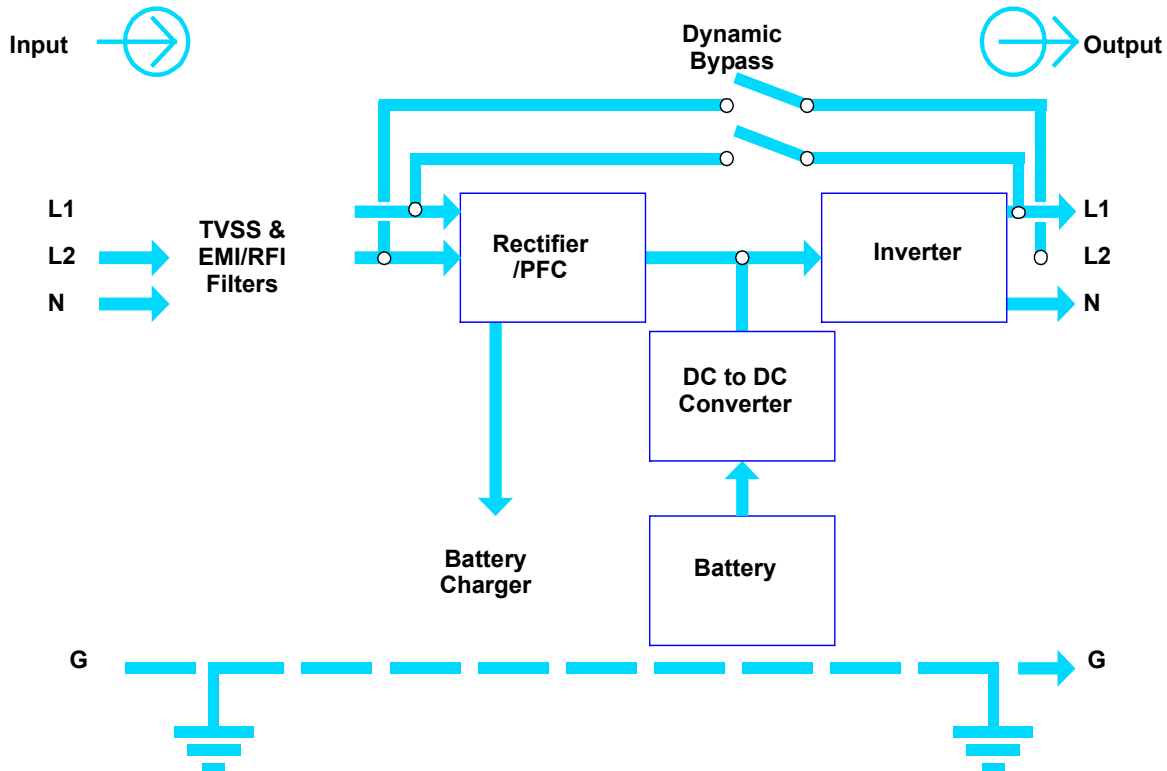

#### 3.1 Transient Voltage Surge Suppression (TVSS) and EMI/RFI Filters

These UPS components provide surge protection and filter both electromagnetic interference (EMI) and radio frequency interference (RFI). They minimize any surges or interference present in the utility line and keep the sensitive equipment protected.

#### 3.2 Rectifier/Power Factor Correction (PFC) Circuit

In normal operation, the rectifier/power factor correction (PFC) circuit converts utility AC power to regulated DC power for use by the inverter while ensuring that the waveshape of the input current used by the UPS is near ideal. Extracting this sinewave input current achieves two objectives:

- The utility power is used as efficiently as possible by the UPS.
- The amount of distortion reflected on the utility is reduced.

This results in cleaner power being available to other devices in the building not being protected by the S4K4U6000.

#### 3.3 Inverter

In normal operation, the inverter utilizes the DC output of the power factor correction circuit and inverts it into precise, regulated sinewave AC power. Upon a utility power failure, the inverter receives energy from the battery through the DC to DC converter. In both modes of operation, the UPS inverter is on-line and continuously generating clean, precise, regulated AC output power.

#### 3.4 Battery Charger

The battery charger utilizes energy from the utility power and precisely regulates it to continuously float charge the batteries. The batteries are being charged whenever the S4K4U6000 is plugged in, even when the UPS is not turned on.

### 3.5 DC to DC Converter

The DC to DC converter utilizes energy from the battery system and raises the DC voltage to the optimum operating voltage for the inverter. This allows the inverter to operate continuously at its optimum efficiency and voltage, thus increasing reliability.

### 3.6 Battery

The S4K4U6000 utilizes valve-regulated, nonspillable, flame retardant, lead acid batteries. To maintain battery design life, operate the UPS in an ambient temperature of 68°F to 77°F (20°C to 25°C). Optional external battery cabinets are available to extend battery run times.

### 3.7 Dynamic Bypass

The S4K4U6000 provides an alternate path for utility power to the connected load in the unlikely event of a UPS malfunction. Should the UPS have an overload, overtemperature or UPS failure condition, the UPS automatically transfers the connected load to bypass. Bypass operation is indicated by an audible alarm and illuminated amber Bypass indicator (other indicators may be illuminated to indicate the diagnosed problem).

The user may manually transfer the connected load from the inverter to bypass by pressing the Standby button once.

**NOTE**

*The bypass power path does NOT protect the connected equipment from disturbances on the utility supply.*

## 4.0 MAJOR COMPONENTS

The S4K4U6000 is composed of three major assemblies to provide easier handling, installation and versatility.

### 4.1 Main Frame and Electronics

This 4U cabinet arrives without internal batteries to lighten the UPS for easier installation. Once the cabinet has been placed in its final floor or rack position, the internal batteries may be installed. The UPS is shipped with a hardwire distribution box with manual bypass switch.

Figure 1 6 kVA Dual Inverter S4K4U (front and rear views)

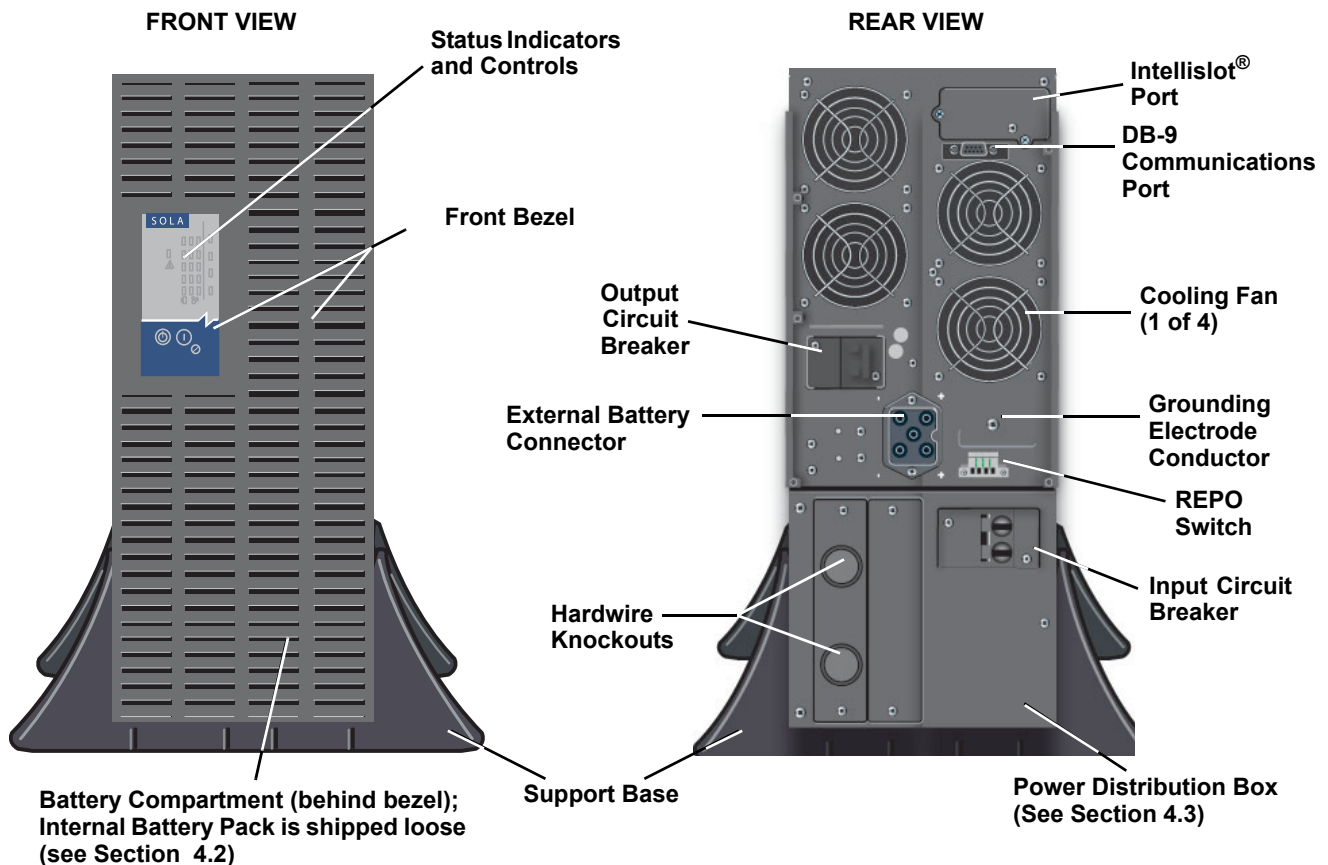

### 4.2 Internal Battery Pack

The front bezels may be pulled forward and removed to reveal the battery access door. The internal battery pack is a compact assembly ready to slide into the battery compartment after the front battery access door has been opened. Electrical connection is automatic upon insertion.



### 4.3 Removable Power Distribution Box

The UPS is shipped with a bypass hardwire power distribution pack installed. For maximum flexibility, this may be easily replaced with either of two optional power distribution boxes that provide the benefits of hardwire input and output plus manual bypass switch or plug/receptacle convenience with manual bypass switch.

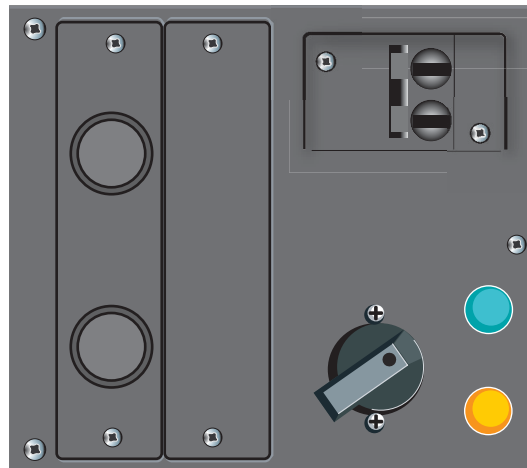

**S4KPAD-HDWR-MBS**  
Power Distribution Box With  
Hardwire Connections and  
Manual Bypass Switch

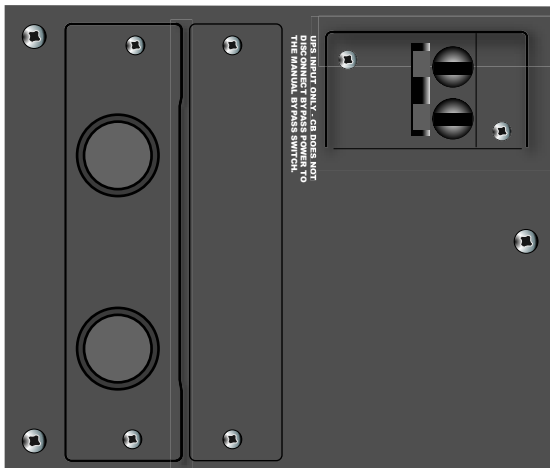

**S4KPAD-HDWR**  
Power Distribution Box  
With Hardwire Connections  
(Optional)

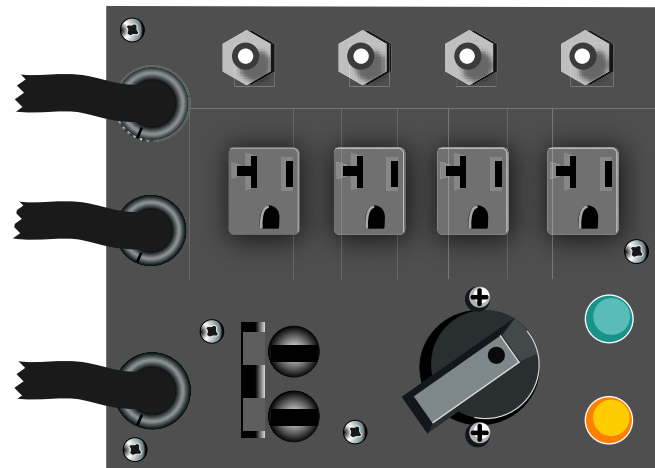

**S4KPAD-001**  
Power Distribution Box  
With Wired Connections  
and Manual Bypass Switch  
(Optional)

## 5.0 WHAT'S INCLUDED

The S4K4U6000 is shipped with the following items:

- S4K4U6000 user manual
- Vertical display overlay
- Front bezel
- Battery cover grille
- MultiLink software CD
- MultiLink serial cable, 10 ft (3m)
- Rack mount handles
- Support base with spacers
- Support base - 2
- GEC ring connector
- Mounting hardware
- Configuration program disk
- Ferrite beads (2)

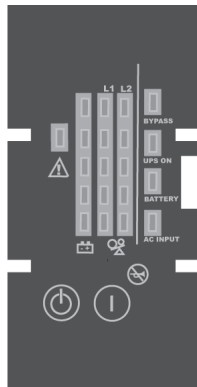

Vertical display overlay

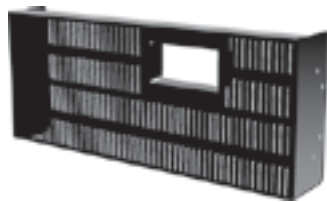

Front bezel



MultiLink software CD

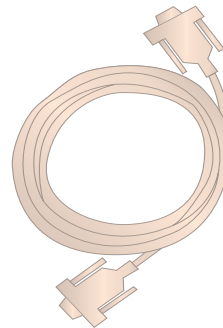

MultiLink serial cable 10 ft (3m)

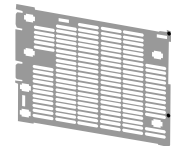

Battery cover grille

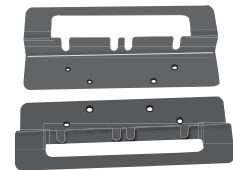

Rack mount handles

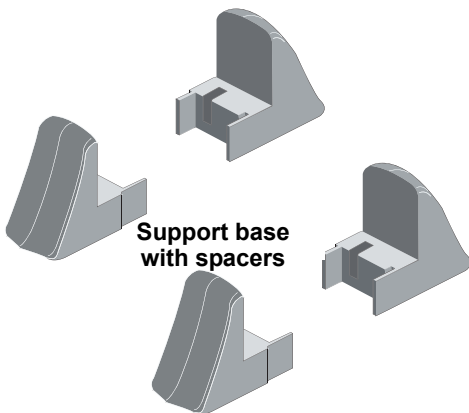

Support base with spacers



GEC connector

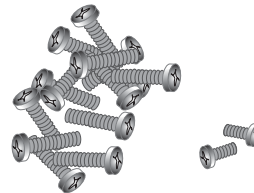

Mounting hardware

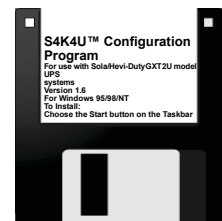

Configuration disk

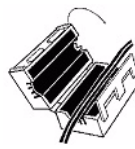

Ferrite beads (2)

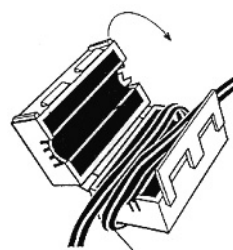

## 6.0 INSTALLATION AND CONFIGURATION

This section includes instructions on how to install, configure and perform initial electrical checks of your UPS installation.

DO NOT attempt to start the UPS, turn on any circuit breaker or energize the input power until instructed to do so in **7.0 - Initial Startup and Electrical Checks**.

Visually inspect the UPS for freight damage. Report damage to the carrier and your local dealer or Sola/Hevi-Duty representative.



### CAUTION

The UPS is heavy (see **14.0 - Specifications**). Take proper precautions when lifting or moving it.

Install the UPS indoors in a controlled environment, where it cannot be accidentally turned off. Place it in an area of unrestricted airflow around the unit, away from water, flammable liquids, gases, corrosives and other conductive contaminants. Maintain a minimum clearance of 4" (100mm) in the front and rear of the UPS. Maintain an ambient temperature range of 32°F to 104°F (0°C to 40°C).



### NOTE

*UPS operation in sustained temperatures above 77°F (25°C) reduces battery life.*

## 6.1 Install the Main Cabinet

The S4K4U6000 may be installed either as a tower unit or in a rack, depending on available space and use considerations. Determine the type of installation and follow the appropriate instructions in either **6.1.1 - Tower UPS Installation** or **6.1.2 - Installing the Adjustable Rack-Mount Kit—Sold Separately**.

### 6.1.1 Tower UPS Installation

When using the S4K4U6000 in a tower configuration, use the included support base (shown below, left) to stabilize the UPS.

If any external battery cabinets are added, they will include spacers to accommodate the additional cabinets (shown below, right).

**Figure 2 Support base and spacers**

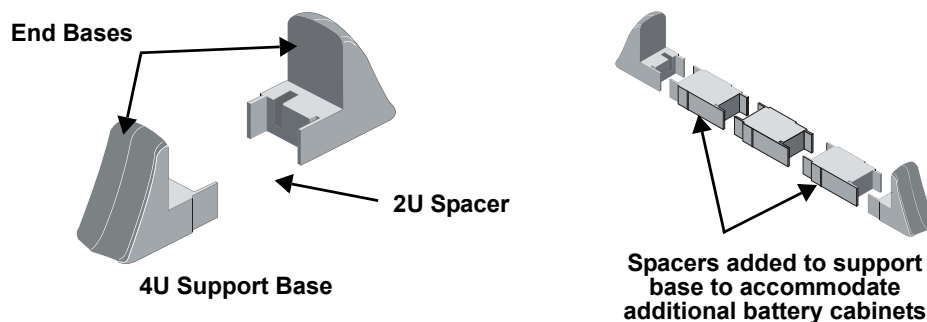



### 6.1.2 Installing the Adjustable Rack-Mount Kit—Sold Separately

This kit contains parts needed to mount several different models of UPS and external battery cabinets into EIA310-D standard four-post racks that are 18-32" deep (457-813mm). The weight limit per pair of adjustable rack-mounting brackets is 200 pounds (91 kg).

Parts included are:

| Item                      | Quantity |
|---------------------------|----------|
| Rear bracket members      | 2        |
| Front bracket members     | 2        |
| Inner bracket members     | 2        |
| M4 x 8mm machine screws   | 16       |
| M4 locking hex nuts       | 8        |
| M5 x 16 mm machine screws | 12       |
| Grease packet.            | 1        |

Tools needed for installation are:

- one Phillips screwdriver
- one 7mm wrench

The adjustable rack-mounting brackets feature retaining latches to prevent users from inadvertently sliding the UPS or battery cabinet out of the rack.

To install the rack mount brackets:

1. Unpack two (2) rack-mounting bracket assemblies and mounting hardware from this kit. Bracket assemblies are interchangeable between left-hand or right-hand. Remove inner member of each bracket assembly as shown in at right by extending it to its outermost position, depressing the retaining latch and then pulling the inner member out of the bracket assembly.
2. Determine the height position inside the rack enclosure where you want to mount the UPS or battery cabinet.

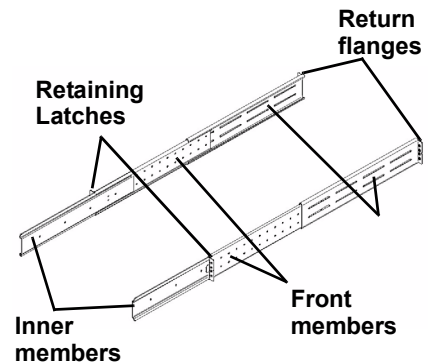

### CAUTION

Reduce the risk of tipping the rack enclosure by placing the UPS or battery cabinet in the lowest possible rack position.

3. Install the rear member of each bracket assembly into rack enclosure with two (2) M5 screws provided in this kit (see figure at right). The return flanges on the bracket assembly fit to the inside of rack mounting rails. Insert screws loosely (finger-tight) into the top and bottom holes of the return flange on the rear member. Extend the bracket assembly by sliding the front member forward until it touches the front rack mounting rail. Insert two (2) M5 screws loosely (finger-tight) into top and bottom holes of the return flange on each front member. Make sure bracket assemblies are at the same mounting height on all four (4) rack mounting rails.

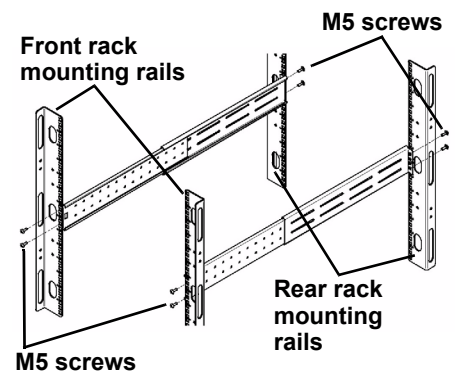

4. Get eight (8) M4 screws and eight (8) M4 nuts from the hardware pack in this kit. Each nut has a locking, nylon insert that begins gripping the screw when it is halfway tight. Make sure to tighten the nut and screw completely to ensure locking action. Fasten the rear member and the front member together using (4) screws and (4) nuts per bracket assembly as shown in at right. For maximum support, insert fasteners for each bracket assembly as far apart as possible, depending on rack depth, while still joining both members (see figures at right). Check alignment of bracket assemblies and **TIGHTEN ALL SCREWS FROM Steps 2 and 3.**
5. Prepare the UPS or battery cabinet (the “equipment”) for rack mounting by following instructions in the equipment’s user manual. The equipment may require additional parts to be added or parts to be removed for rack mounting. After it is prepared, lay the equipment in rack-mounting position. Fasten the inner members from **Step 1** to the equipment on both sides as shown at right with eight (8) M4 screws provided in the kit. Make sure retaining latch is near the rear of the equipment as shown (see figure at right).
6. Open the grease packet provided in the kit. Apply a 1" long bead of grease at four (4) places inside the bottom, curved tracks of the front members as shown below right. The grease will allow the equipment to slide into the bracket assemblies more easily.

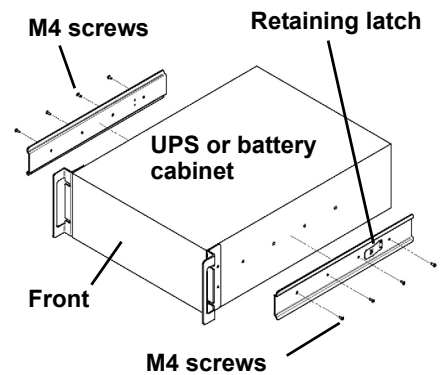
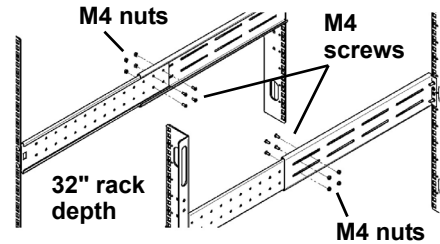
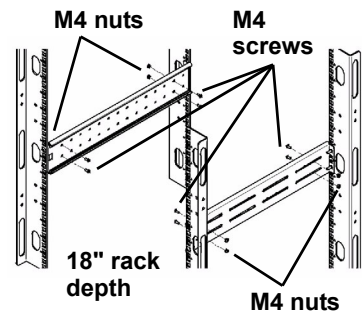

## CAUTION

Lifting equipment into the rack may be a two-person job, depending on the weight of the equipment. See equipment’s user manual.)

7. Insert the equipment, with inner members attached in **Step 5**, into the bracket assemblies by inserting the top and bottom edges of the inner members into the top and bottom curved tracks of the front members and sliding the equipment into the rack (see figure at right). Ends of inner members are tapered to allow the rear of the equipment to be angled upward before insertion, if space allows. Then the rear, bottom edges of the inner members can be placed into the front edge of the bottom tracks and the front of the equipment can be tipped up so they are level to insert the top edges of the inner members before sliding the equipment into the rack (see figure below right). The equipment should move smoothly into the bracket assemblies. If it does not, recheck the alignment of the front and rear members from **Steps 2 and 3.**
8. Secure the front of the equipment to the rack mounting rails to prevent the equipment from sliding out of position. If securing holes are provided on the front of the equipment that align with the center holes on the return flange of the front members, you can use the four (4) extra M5 screws provided in the kit to secure the equipment. Otherwise, the equipment should be secured to the front of the rack with four (4) customer-supplied fasteners.

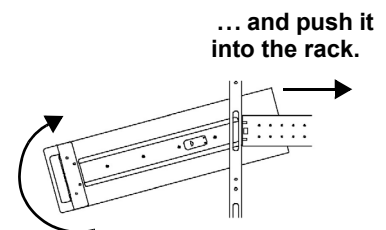
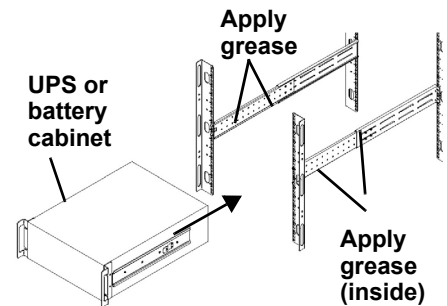

Insert the UPS into the front members, lift the front ...

## 6.2 External Battery Cabinet Installation

Optional Sola/Hevi-Duty external battery cabinets may be connected to the UPS to provide additional battery run time. External battery cabinets are designed to be placed on one side of the UPS or stacked beneath the UPS.



### CAUTION

The external battery cabinet(s) are heavy (see **14.0 - Specifications**). External battery cabinets can be used in rack-mount or tower configuration. Take proper precautions when lifting them.



### CAUTION

Verify that the battery cabinet circuit breaker is in the OFF position. Do not energize the battery cabinet at this time. When installation is complete, you will be instructed to turn on the circuit breaker.

When the external battery cabinet is received, it should be inspected for freight damage. Report damage to the carrier and your local dealer or Sola/Hevi-Duty representative.

To install an external battery cabinet:

1. For slide rail installations, first remove the top/side fin by sliding it forward and lifting it up. Optional rack-mount handles are shipped with the external battery cabinet and may be installed now. (Securing hardware and slide rails are sold separately. Please contact your local dealer or Sola/Hevi-Duty representative for these additional options and any assistance needed.)
2. Fasten the slides into position with the screws according to the instructions included with the slide rails.
3. Use the enclosed support bases for the tower option to prevent the assembly from tipping over. One additional set of support base extensions ships with each external battery cabinet.
4. Connect the supplied external battery cabinet cable to either of the connectors on the rear of the external battery cabinet, then to the rear of the UPS.
5. The UPS is now equipped with additional backup battery run time. For approximate battery run times, refer to **Table 7 - Battery run times** in this manual.
6. Do NOT turn on the battery cabinet circuit breaker at this time. Please complete the remainder of the installation first.



### NOTE

*After installation is complete, you must use the included configuration program to program the UPS for the number of external battery cabinets connected. Instructions for using the configuration program follow in **8.0 - Configuration Program**.*

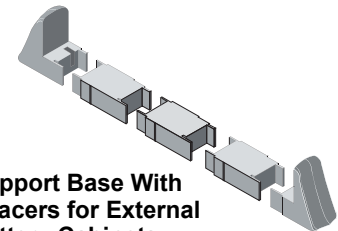

**Support Base With Spacers for External Battery Cabinets**

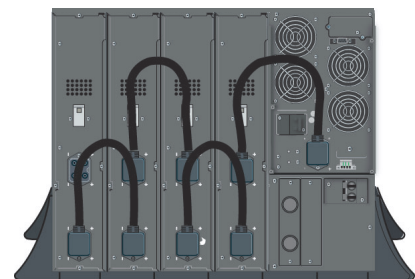

**UPS and Four External Battery Cabinets With Support Base**

### 6.3 Connect Input/Output Power

The UPS ships with the basic hardware box attached. If an optional model is to be used, remove the standard box and install the optional box using the three captive mounting screws marked in the illustration, below, right.

#### 6.3.1 Replacing a power distribution box

Whenever a power distribution box is not attached to a UPS, the cover must be slid over the electrical connectors to prevent damage or injury.

1. On the power distribution box **attached to the UPS**, locate the three captive mounting screws holding the box to the UPS (see illustration above, right).
2. Turn the screws until the box can be pulled away from the UPS. Exercise care to avoid removing screws from the hardware box.
3. On the replacement power distribution box **to be attached to the UPS**, loosen the cover over the electrical connectors by backing out the three screws one turn each.
4. Slide the cover open to expose the electrical connectors.
5. Gently retighten the three screws loosened in **Step 3**.
6. Align the connectors on the box and UPS.
7. Push the box into place.
8. Holding the box firmly against the UPS, tighten the three captive mounting screws until the box is secure. Do not overtighten.

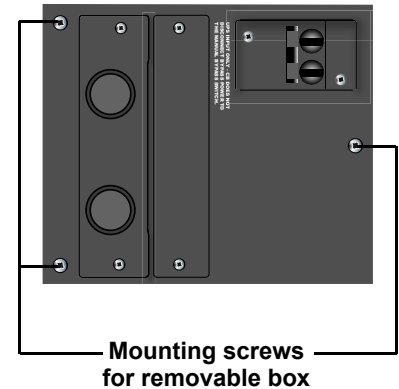
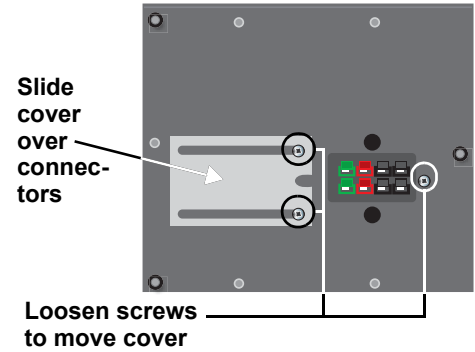

#### 6.3.2 Distribution Box Electrical Connections

Electrical connections are made through a removable power distribution box that attaches to the rear of the UPS.

The installer must provide a 30A branch circuit breaker. The input circuit breaker on the distribution box and the output circuit breaker on the rear fixed-panel of the UPS disconnect all power between the main cabinet and the distribution box.

Models equipped with a manual bypass switch pass utility power directly to the bypass switch from the input terminal block. The input circuit breaker on the distribution box does not disconnect power from the manual bypass switch.

Figure 3 30A branch circuit breaker connection diagram

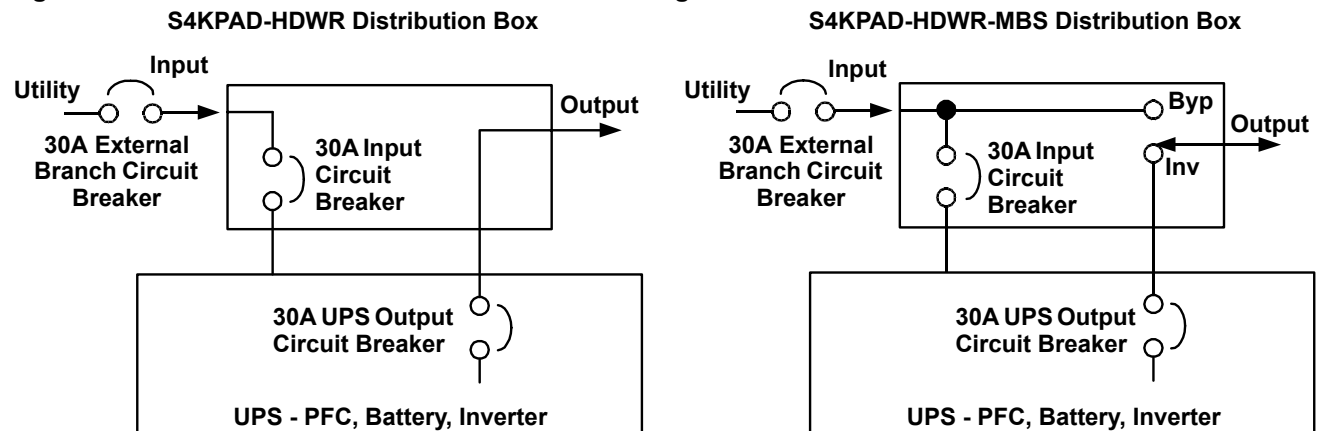

### 6.3.3 S4KPAD-HDWR and S4KPAD-HDWR-MBS Terminal Block Connections

Conduit entry holes are provided on the rear and side of the box. Input and output wiring should not share the same conduit.

**Table 1 Electrical requirements—S4KPAD-HDWR and S4KPAD-HDWR-MBS**

| Input Current Rating | Recommended (Max.) External Overcurrent Protection | Recommended Wire (including ground wire) (75°C copper wire) | Maximum Wire Accepted by Terminal Block | Terminal Tightening Torque |
|----------------------|--|---|---|----------------------------|
| 24A                  | 30A  | 10 AWG  | 8 AWG                                   | 20 in-lb                   |

The standard S4KPAD-HDWR comes installed on the UPS. The S4KPAD-HDWR-MBS with manual bypass switch is optionally available. Both have the same hardwire terminal connections.

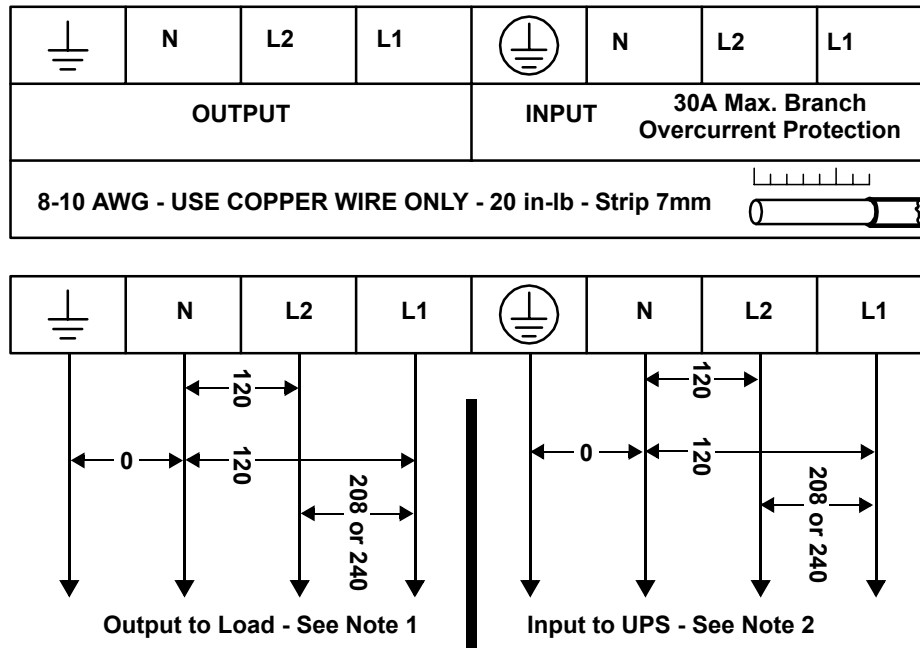

**NOTE**

1. The installer must provide circuit breaker protection according to local codes. The utility disconnect should be within sight of the UPS or have an appropriate lock-out. Maintain service space around the UPS or use flexible conduit.
2. The installer must provide output distribution panels, circuit breaker protection or emergency disconnects according to local codes. Output circuits must not share a common conduit with any other wiring.

For best performance, distribute all L-N loads evenly between L1 and L2.

### 6.3.4 S4KPAD-001 Power Distribution Box

An optional S4KPAD-001 is available to provide the convenience of an L14-30P input plug and output receptacles. To use this box, remove the original S4KPAD-HDWR hardwire box and install the S4KPAD-001.

**Table 2 Electrical requirements—S4KPAD-001**

| Input Current Rating | Recommended (Max.) External Overcurrent Protection | Required Utility Receptacle |
|----------------------|--|-----------------------------|
| 24A                  | 30A  | NEMA L14-30R                |

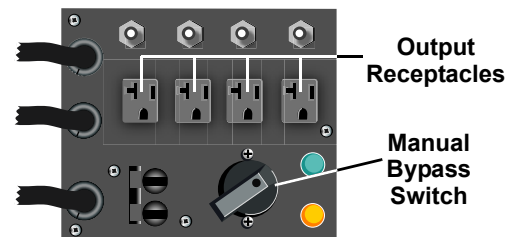

## 6.4 Install the Grounding Electrode Conductor

A Grounding Electrode Conductor must be attached to the rear panel using the M5x12 Phillips screw provided. This connection is required in addition to the power input ground connection to the removable power distribution box.

Install an 8 AWG (10 mm<sup>2</sup>) (75°C copper wire) (minimum size, see NEC 250-5d, 250-81, 250-83, table 250-94) grounding electrode conductor to the nearest effectively grounded metal structural member, nearest effectively grounded metal water pipe or other grounding electrode in the grounding electrode system. If the grounding electrode conductor must be protected, non-metal conduit is recommended. If metal conduit must be used, bond both ends of the conduit to the grounding electrode conductor. Conduit is not an acceptable grounding electrode conductor.

A 5mm ring lug for 8AWG wire lug is provided in the accessory box. Other suitable connectors may be used.

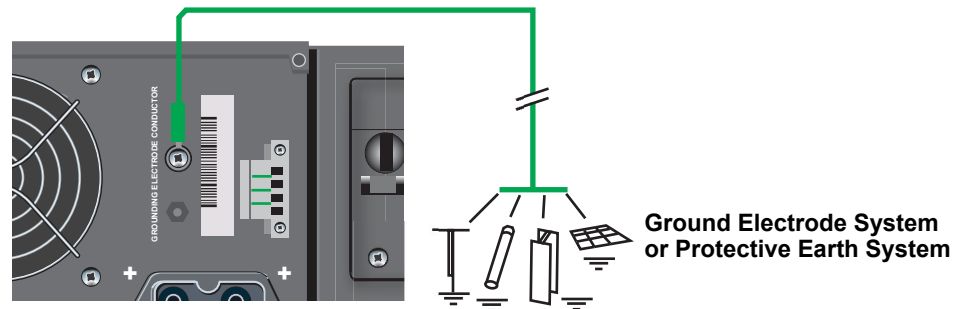

### NOTE

*IN BATTERY MODE ONLY, the UPS operates as a separately derived source and contains a neutral to ground bonding jumper. A grounding electrode conductor (GEC) must be installed in accordance with national and local wiring codes and regulations.*

## 6.5 Install the Internal Battery Pack

To facilitate shipping and installation, the S4K4U6000 ships without the internal battery installed. Once the UPS is installed in place, the internal battery pack must be installed.

1. Unpack the internal battery from its shipping container.
2. Lift the battery pack from its container, holding it in the center of the pack. Do NOT lift the battery pack by grasping the connector on the rear.
3. Align the battery pack so that the rear connector is nearest the control panel.
4. Slide in the battery pack until fully inserted.
5. Install the battery door, tightening the two captive screws, finger tight. The battery door will not install if the battery is not fully inserted.
6. For tower installation, place the horizontal overlay over the controls and indicators (see illustration at right).
7. Install the front bezel.

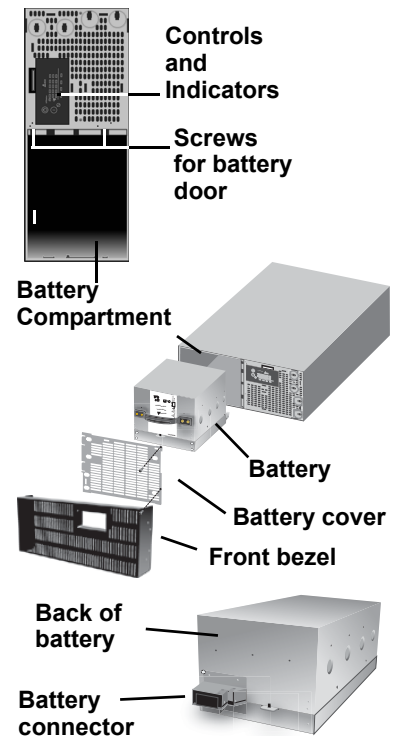



---

## 7.0 INITIAL STARTUP AND ELECTRICAL CHECKS

---

**Initial Startup and the Configuration Program**—The UPS ships with a default 120 VAC L-N setting. This is also the most robust setting in that it can operate with either input phase angle (120 or 180 degrees). Perform initial system checks first. If the UPS configuration needs to be modified for your application, then go to the next section to review use of the configuration program. Some configuration changes require that the UPS be in the OFF mode while powered from the utility. Therefore, the installer must confirm that the UPS input has been properly wired. After re-configuring your UPS, the UPS may be put into service with the intended loads.

Hardwire Input Connections (For L14-30P Plug-in Connections, skip to **7.1 - L14-30P Plug-in Connections—Including the S4KPAD-001 Distribution Box.**)



### WARNING

Miswiring power to the input terminal block (L1-L2-N-G) or connecting to single phase voltages (L-N-G only) may damage the UPS.

1. Verify that the Input and Output circuit breakers are off.
2. During initial system checks, disconnect all loads (open load disconnects).
3. Inspect all wiring, cables and connection.
4. If external battery cabinets are used, verify that the battery interconnect cables are fully inserted in the sockets. Turn on the battery cabinet circuit breaker now.
5. If you are using a distribution box that includes a manual bypass switch, place the switch in BYPASS position.
6. Turn on the branch circuit disconnect to apply voltage to the input terminal block.
7. Using a voltmeter, verify the expected L1-N, L2-N and L1-L2 voltages.
  - a. If no manual bypass switch is used, there will be no output voltage at this time. If a manual bypass switch is used, verify that the same voltages appear at the Output terminals. If a manual bypass switch is used, the Bypass lamp will light by the switch. If no manual bypass switch is used, there will be no output voltage at this time.
  - b. If the configuration program has been used to set the L-N voltage at 100, 110 or 115, then the input phase angle is required to be 180 degrees.
  - c. If the configuration program as been used to set the L-N voltage at 127 VAC, then the input phase angle is required to be 120 degrees (leading or lagging).
8. After verifying proper input voltage to the UPS terminal block, turn off the branch circuit power, close all access panels to the distribution box and reapply input power.
9. Close the Input circuit breaker located on the distribution box. The green AC Input indicator should illuminate on the front panel.
10. Press the On button for 1 second. The Bypass indicator will light for several seconds before the UPS ON indicator turns on continuously. If the batteries are determined to charged above 80%, an automatic battery test will run for about 15 seconds.
11. Close the Output circuit breaker on the rear of the UPS. If a manual bypass switch is used, the UPS Available indicator by the switch will light. If a manual bypass switch is used, transfer the switch to the UPS position. The output terminal block will be powered at this time.
12. Perform a Manual Battery Test - Press the On button for one (1) second. The front Battery indicator will light for about 15 seconds and then return to only the UPS ON and AC Input indicators being illuminated.
13. Review all setting option provided by the configuration program. Some changes require that the UPS be OFF. If this is the case, these should be programmed before powering the loads. The configuration program is described in the next section.
14. Connect all loads for normal operation.

## 7.1 L14-30P Plug-in Connections—Including the S4KPAD-001 Distribution Box



### WARNING

Miswiring power to the input (L1-L2-N-G) or connecting to single phase voltages (L-N-G only) may damage the UPS. A qualified electrician should verify that the L14-30R is properly wired before attaching the UPS.

If the configuration program has been used to set the L-N voltage at 100, 110 or 115, then the input phase angle is required to be 180 degrees.

If the configuration program as been used to set the L-N voltage at 127 VAC, then the input phase angle is required to be 120 degrees (leading or lagging).

1. Verify that the input and output circuit breakers are off.
2. During initial system checks, unplug all loads (or open load disconnects).
3. Inspect all wiring, cables and connection.
4. If external battery cabinets are used, verify that the battery interconnect cables are fully inserted in the sockets. Turn on the battery cabinet circuit breaker.
5. If you are using a distribution box that includes a manual bypass switch, place the switch in BYPASS position.
6. Plug in the UPS input plug.
7. Turn on the branch circuit disconnect to apply voltage to the UPS input.
8. If no manual bypass switch is used, there will be no output voltage at this time. If a manual bypass switch is used, the Bypass lamp will light by the switch
9. Close the input circuit breaker located on the distribution box. The green Line lamp should illuminate on the front panel.
10. Press the Start button for 1 second. The Bypass lamp will light for several seconds before the Inverter lamp turn on continuously. If the batteries are determined to charged above 80%, an automatic battery test will run for about 15 seconds.
11. Close the output circuit breaker on the rear of the UPS. If a manual bypass switch is used, the Inverter lamp by the switch will light. If a manual bypass switch is used, transfer the switch to the Inverter position. The output terminal block will be powered at this time.
12. Perform a Manual Battery Test by pressing the ON button for 1 second. The front Battery lamp will light for about 15 seconds and then extinguish, leaving only the Inverter and Line lamps illuminated.
13. Review all setting option provided by the configuration program. Some changes require that the UPS be OFF. If this is the case, these should be programmed before powering the loads. The configuration program is described in the next section.
14. Connect all loads for normal operation.



## 8.0 CONFIGURATION PROGRAM

The final step of installation may require custom configuration of your UPS using the enclosed configuration program. Some configuration settings may be changed only while the UPS is off. These should be set before the UPS is put into full time service powering the critical load.

For most users operating with 120 VAC L-N and with no external batteries, the factory default settings will be adequate. This manual illustrates the features available for modification, as well as the factory default setting.

The factory default L-N setting is 120 VAC. When first powered by the AC input, the UPS will auto-sense the utility phase angle between L1 and L2, setting the UPS to operate as either a 120/208 VAC system (120 degrees, leading or lagging) or a 120/240 VAC system (180 degrees).

If your application requires that the L1-N, L2-N voltages be set at 100, 110, 115 or 127 VAC, the corresponding phase angle between L1 and L2 is restricted. The VAC settings of 100, 110 and 115 may work only with a phase angle of 180 degrees. A VAC setting of 127 VAC will work only with a phase angle of 120 degrees (leading or lagging).

To confirm the phase angle of the utility input, measure the L1-N, L2-N and L1-L2 VAC of the utility input that is intended for the UPS. If the measured L1-L2 voltage is equal to the average L-N voltage times 2.0, then the phase angle is 180 degrees and the L-N VAC may be set at 100, 110, 115 or 120 VAC. The nominal L1-L2 voltages for these four settings will be 200, 220, 230 or 240 VAC, respectively.

If the measured L1-L2 voltage is equal to the average L-N voltage times 1.73, then the phase angle is 120 degrees and the L-N VAC may be set at either 120 or 127 VAC. The nominal L1-L2 voltages for these two settings will be 208 or 220 VAC, respectively.

Selecting a L-N nominal voltage that is not compatible with the L1-L2 phase angle detected by the UPS when AC input is applied will result in a fault alarm and the UPS will not operate from utility power.

### 8.1 S4K4U6000 Configuration Program Features

The configuration program enables the user to perform the following functions:

- Select one of five L-N output voltages to match local voltages
- Enable or disable Auto-Restart
- Select frequency converter operation with a fixed output frequency of 50 or 60 Hz
- Set the Low Battery Warning alarm time from 2 to 30 minutes
- Enable or disable the Auto-Battery test
- Set the Auto-Battery test to 7, 14, 21 or 28 days
- Specify the number of external battery cabinets connected to the UPS to adjust the remaining run time calculations reported by Sola/Hevi-Duty software products
- Modify the shutdown setting of DB-9 pin 6 (for information on pin assignments, see **11.0 - Communications**)

#### 8.1.1 What You Will Need

In addition to the S4K4U6000 UPS, you will need the configuration program diskette and serial cable (beige or tan, three-wire: GND, TX, RX; straight through 2-2, 3-3, 5-5) included in the UPS accessory box. A computer—desktop or laptop—running Windows 95<sup>®</sup> or later is also required to set up and run the configuration program.

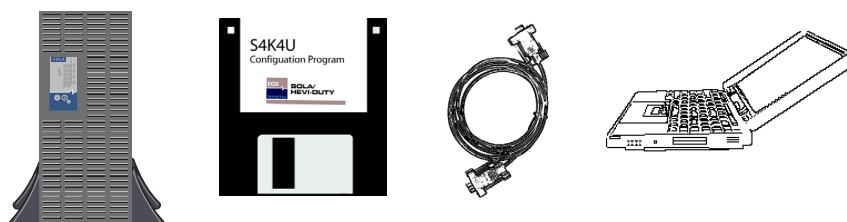

## 8.2 Configuration Program—Installation

An easy-to-use installation program will streamline the installation of the configuration program. If you have a previous version of this configuration program installed, it is recommended that it be uninstalled using its Uninstall program before installing this updated version.

1. Use the Windows Explorer to find and open the Lbt\_gxt2-1.6.exe installation program on the included software CD.
2. When you see this PreSetup window, select OK. This will open the main installation screen.

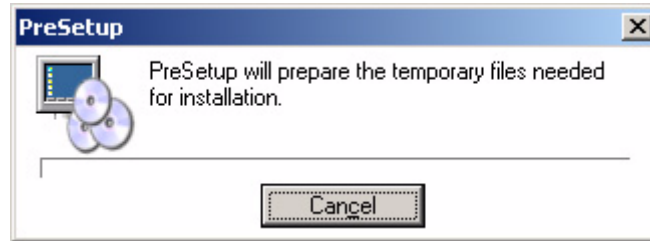

3. Click NEXT to continue installing the configuration program.

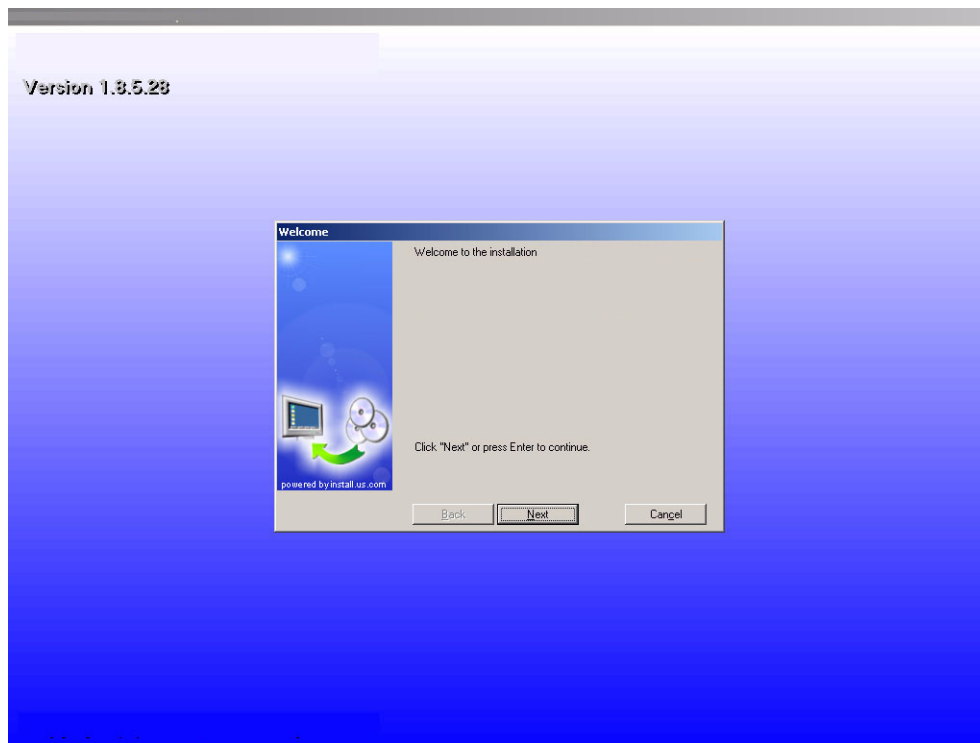

Sola/Hevi-Duty recommends using the default installation options, but you will be given the option to make modifications to the standard entries.

The installation program will also install an Uninstaller program along with the UPS configuration program.

### 8.3 Establishing Communication Link with the UPS

Use only the serial communication cable supplied with the configuration program. If an accessory communication card has been installed in the UPS's communication card slot, the option card must be removed while using the configuration program.

Use the serial communication cable to connect your computer's COM1 port to the DB-9 communication port on the rear of the UPS. COM2 may also be used. If the COM port of the host computer has only a DB-25 pin connector, a DB-25 to DB-9 adapter must be added.

The program may be used while the UPS is on to read and confirm the current settings. The UPS must be off and powered by the AC utility when using the configuration program to change any UPS setting. Any attempt to change a setting while the UPS is on will result in an error message.

Select **Lbt\_gxt2.exe** from the program group to start the configuration program. The program will search COM1 & COM2 for a properly connected S4K4U™ UPS. When the UPS is found, the opening program window will display the UPS model.

If the configuration program ever fails in its attempt to read data from a UPS, the error message below will be displayed. The program must communicate with the UPS when it first opens, when a new tab is opened and when the REFRESH, APPLY or OK buttons are pressed.

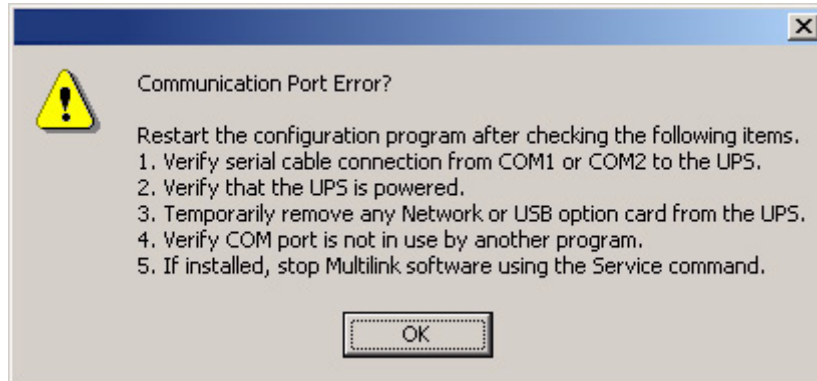

If this message is displayed, check the following items:

1. Verify that the serial communication cable is connected properly.
2. Verify that the COM port being used is designated COM1 or COM2.
3. Verify that the UPS is either in Inverter mode, Bypass mode, Battery mode or Off with AC power available at the input (AC Input indicator on). In all cases, the rear fan will be running.
4. Verify that the COM port is not in use by other UPS communication software (or non-UPS software). If MultiLink UPS software is installed on the computer, the MultiLink service must be stopped to free the COM port. MultiLink typically restarts automatically whenever the computer restarts.
5. The UPS serial port is in use by an internal, optional communication card in the UPS card slot. Remove the option card.
6. The program is connected to a UPS that was not designed for this program.

## 8.4 Configuration Program—Operation

### 8.4.1 Read/Confirm UPS Configuration Settings

The UPS settings may be monitored, but not changed, using the configuration program while the UPS is operating in any mode. If the program is only used to read the present UPS settings, close the program using the CANCEL button.

Mistakenly using the APPLY or OK button will attempt to write data to the UPS and will result in the error message shown at right if the UPS is not off.

If this message is displayed and you do not wish to change any settings, close this error message and close the configuration program using the CANCEL button.

If the UPS is off and you do not wish to risk changing any settings, close the program using the CANCEL button. Do not use the APPLY or OK buttons in the configuration program.

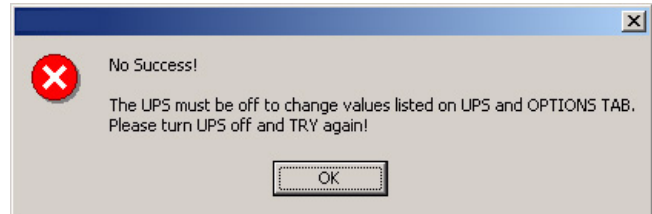

### 8.4.2 Changing UPS Settings

UPS SETTINGS MAY ONLY BE CHANGED USING THE CONFIGURATION PROGRAM WHEN THE UPS IS OFF AND NO POWER IS BEING DELIVERED TO THE LOAD. AC input power must be available to power the UPS logic during programming. Only the AC Line indicator will be on indicating utility input power.

To turn the UPS off to change configuration settings, press the UPS OFF/Bypass button twice within four seconds (hold the button one second each time). This will disconnect all power to the load.

Changing any value or selecting/deselecting any setting in the configuration window will not immediately change the settings in the UPS. You may modify the displayed settings until you are satisfied with the new proposed changes. Settings displayed by the configuration program can always be restored to the existing values stored in the UPS by selecting the REFRESH key.

Values displayed will be transmitted to the UPS only when either the APPLY or OK button is selected. The APPLY button sends the new settings to the UPS without closing the program. The OK button sends the new settings and closes the program.

Whenever data is successfully transmitted to the UPS, this message shown at right will be displayed.

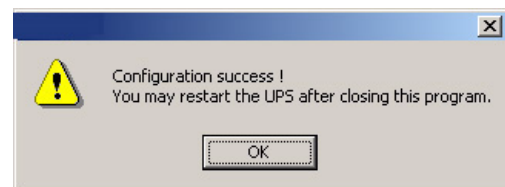

### 8.4.3 Programming Rejected?

If the UPS appears to be off but this error message is displayed when the APPLY or OK button is selected to transmit settings, the UPS may be in an intermediate standby condition.

To confirm that the UPS is fully off, repeat the turn off procedure. Press the UPS OFF/Bypass button twice within four seconds (hold the button one second each time).

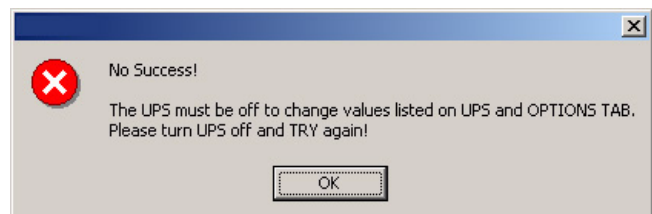

### 8.4.4 Exit Without Changing UPS Settings

If you decide not to change the UPS after modifying the displayed settings, close the configuration program using the Cancel button.

## 8.5 UPS Tab

When the program starts, the following window will open displaying the UPS model along with the current UPS settings. This information can be updated at any time using the REFRESH button.

**Figure 4 Factory default settings for 120VAC UPS**

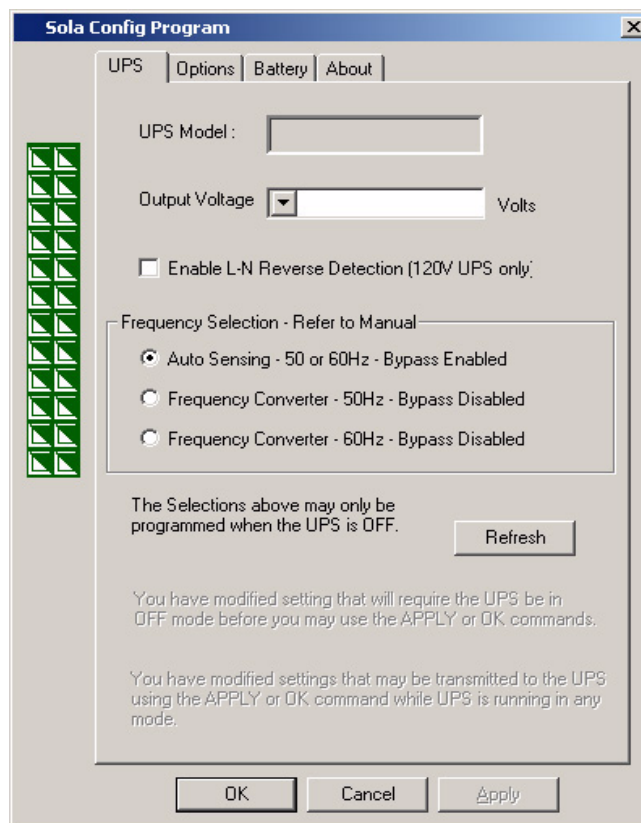

### 8.5.1 Output Voltage

The Output Voltage displayed is the nominal input/output voltage. This is not a voltmeter and will display the nominal voltage whether the UPS is on or off. The drop down box will show the alternate voltages available. Select the voltage that matches the nominal utility in your location.

### 8.5.2 Auto Restart

The UPS will provide computer grade power during power outages. If input power is unavailable for an extended time, the UPS will shut down when batteries are depleted or a shutdown signal is sent by the computer operating system to limit battery depletion (serial data or contact closure). If Auto Restart is enabled (check mark in box), the UPS will restart when input power is restored. If the UPS turns off power to the load for any other reason, manual restart is required (See 8.6 - Options Tab for exceptions). Click on the box to remove the check mark and disable Auto Restart.

### 8.5.3 L-N Reverse Detection (120V UPS Models Only)

Proper wiring of the receptacle powering the UPS is critical for safety, EMI suppression and surge suppression. The UPS checks the outlet when first plugged in. If the Line-Neutral is reversed or the ground is missing, the UPS will not start. If a problem is detected after the UPS is started, the UPS will continue to operate, but the AC Input indicator will flash. In some unique applications the user may wish to disable this alarm. Except for special situations, improperly wired receptacles should be immediately repaired before the UPS is put into service. Click on the box to remove the check mark and disable this alarm.

### 8.5.4 Frequency Selection

The UPS is normally designed for 50Hz or 60Hz operation. The factory default corresponds to the model. All models are capable of being used as 50Hz or 60Hz systems. The UPS will automatically sense the utility frequency when first plugged in and set the nominal frequency to match. Therefore, for all normal use the Auto Sense button should be selected.

Some special applications require that the UPS be used as a frequency converter. Frequency converter 50Hz or frequency converter 60Hz may be selected.

Note that frequency converter operation disables the Bypass. If, for any reason, the UPS inverter is unable to power the load, the alternate bypass to utility power will not be available and power will be removed from any load.

### 8.6 Options Tab

Computer users may choose to use versatile computer shutdown software that communicates with the UPS via a serial communications cable. The Options tab should not be used to modify the UPS functions for such applications.

For some industrial applications and special computer applications, the UPS may be monitored and controlled using external voltages and relay contact signals. The Options tab expands the UPS versatility for such applications.

Refer to your UPS manual for a description of the 9-pin communication connector on the rear of the UPS. Pin 6 of the 9-pin communication connector is used for “Any Mode Shutdown” of the UPS output. This control input may be used in special applications to disable the UPS output power - both Inverter and Bypass.

The Options tab allows the behavior of the Any Mode Shutdown feature to be modified.

When the program opens or the REFRESH button is pressed, the UPS setting is read by the configuration program and displayed.

Factory Default Setting Illustrated - This Options tab illustration shows the available function definitions using pin 6 and the factory default settings.

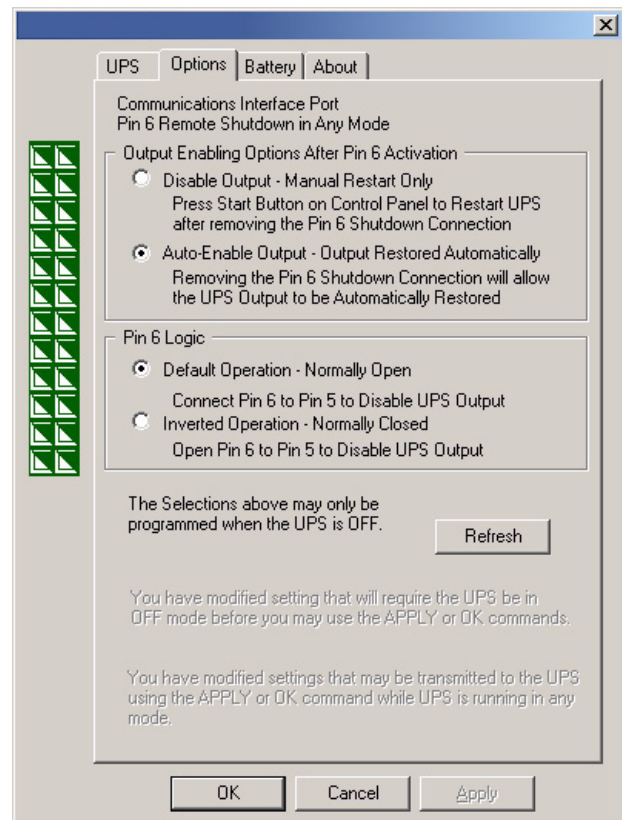

#### WARNING

##### Auto-Enable Output

Note that when this option is selected and the UPS output is disabled using Pin 6, the UPS output can turn on automatically and without warning if the Pin 6 connection is changed.



#### WARNING

##### Pin 6 Logic

DO NOT CHANGE THIS OPTION from the factory default setting unless you are ready to install a normally-closed connection between Pins 5 & 6. This connection must be maintained to use the UPS or to use the configuration program again, including the ability to change the UPS setting back to the default setting using the configuration program via a serial communication link.



## 8.7 Options Tab Used With Earlier S4K4U Models

This version of the configuration program will accompany S4K4U UPS models that support new programming features accessible using the Options tab.

If version 1.6 (or later) is used with an earlier S4K4U model (with an earlier UPS firmware version), the Any Mode Shutdown features cannot be changed.

If the configuration program is used with an earlier UPS model (with an earlier UPS firmware version) that does not support the modification of these settings, the Options tab will display a reminder of the factory default settings, as shown. These cannot be changed.

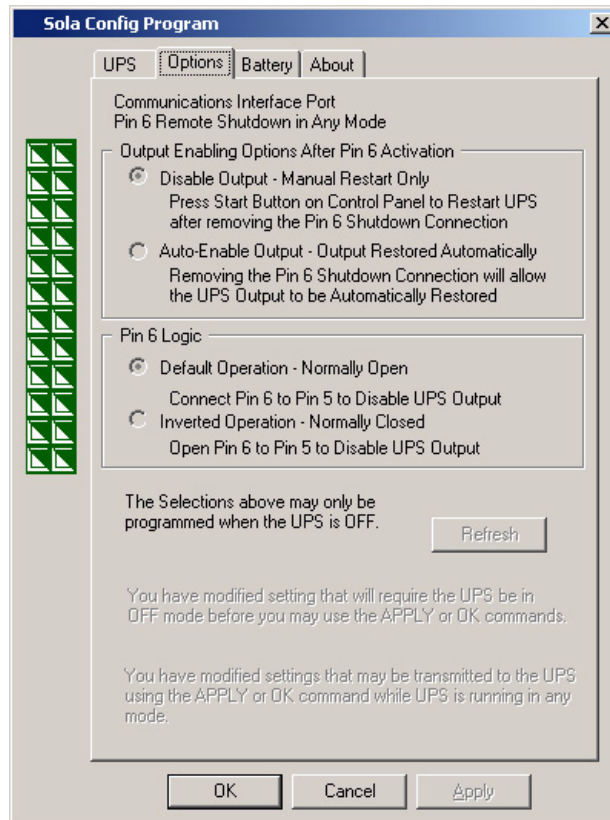

## 8.8 Battery Tab

Factory default settings illustrated.

The boxes on the right show the available options using the drop-down selection boxes.

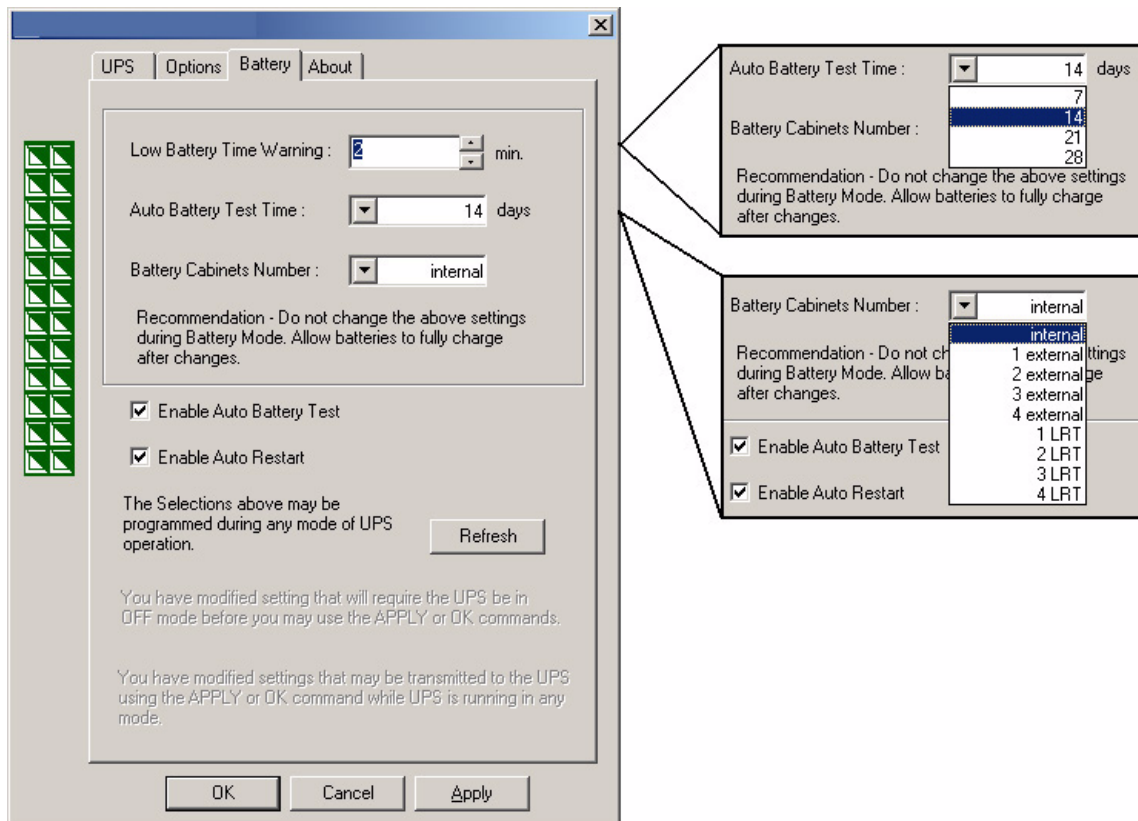

### 8.8.1 Low Battery Time Warning

The UPS will estimate remaining operating time when on batteries. A low battery alarm is activated if the estimated time reaches the Low Battery Time. This may be changed to any value from 2 to 30 minutes.

### 8.8.2 Auto Battery Test Time

The UPS performs an automated battery test periodically, if enabled. The user may also select time periods of 7, 14, 21 and 28 days.

### 8.8.3 Battery Cabinets Number

If additional batteries are attached to the UPS, accurate battery runtime estimates are possible if the battery number and type of batteries are entered here. The new UPS models are designed to operate with up to four external battery packs or four long runtime battery packs (not currently available).

### 8.8.4 Auto Battery Test

In some applications it may be preferable to disable the automated, periodic battery test. Click on the box to remove the check mark and disable the periodic battery test.



## 8.9 About Tab

The version number of the configuration program may be confirmed using the About Tab.

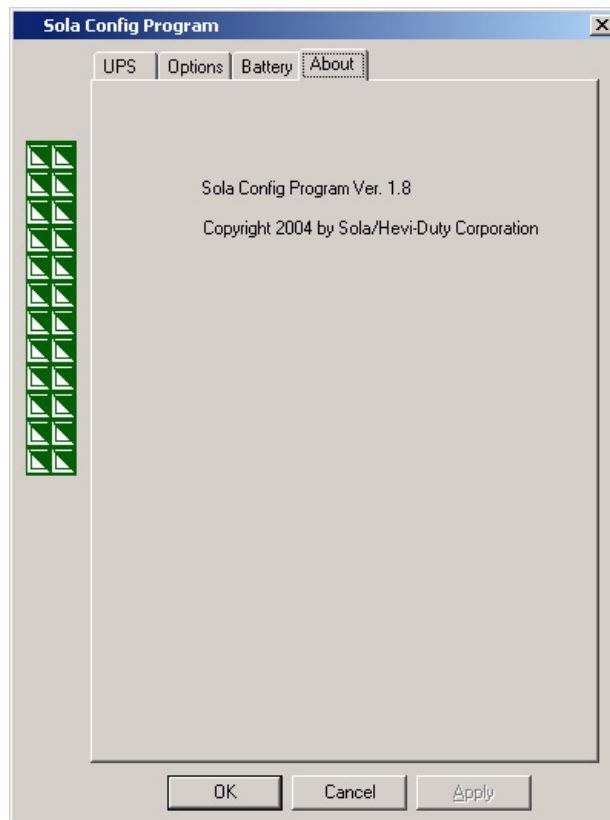

## 9.0 CONTROLS AND INDICATORS

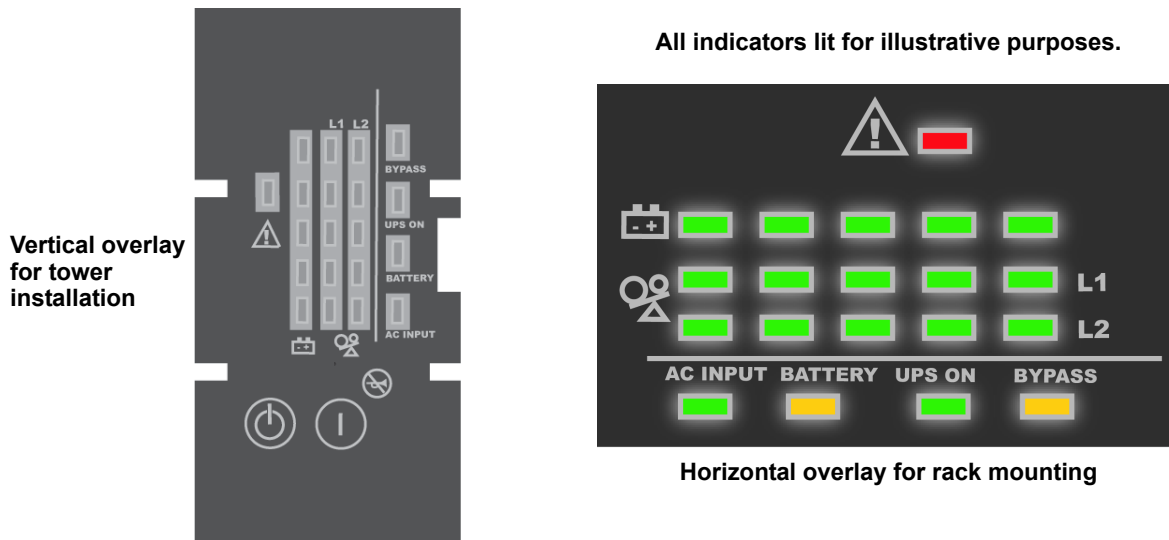

### 9.1 ON/Alarm Silence/Battery Test Button

This button controls output power to connected load(s) and has three functions:

- ON
- Alarm Silence
- Manual Battery Test

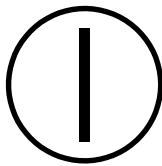

**ON** - Pressing this button will start up the UPS in order to provide conditioned and protected power.

**Alarm Silence** - To silence alarms, press this button for at least one Second. After the alarm is silenced, the S4K4U6000 will reactivate the alarm system to alert of additional problems.



#### NOTE

The **LOW BATTERY** and **BYPASS** reminder alarms **CANNOT** be silenced.

**Manual Battery Test** - To initiate a manual battery test, press the ON/Alarm Silence/Battery Test button for at least one second while operating from utility power with no alarm conditions present.

- If only three of the five Battery indicators illuminate, allow the UPS to recharge the batteries for 24 hours.
- After 24 hours, retest the batteries.
- After the batteries have been retested, if only three of the five Battery indicators illuminate, contact your local dealer, Sola/Hevi-Duty representative.

### 9.2 OFF/Bypass Button

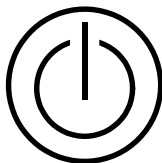

This button controls output power to connected load(s) and has dual functions: OFF and Bypass.



#### CAUTION

Pressing the OFF/Bypass button once will cause the load to be transferred to bypass power. Pressing the OFF/Bypass button three times within 4 seconds will change the unit from UPS ON to UPS off mode. This will result in a loss of power to the receptacles and connected loads, but the UPS's circuits remain live, charging the units battery. Perform all necessary shutdown procedures on connected loads before pressing this button three times or two times from bypass mode.

### 9.3 L1 & L2 Load Level Indicators (Two Rows of Indicators: 4 Green, 1 Amber)

The Load Level indicators display the approximate electrical load placed upon both output legs of the UPS at all times. Each indicator represents an approximate 25 percent increase in load. For optimum utilization of the UPS, distribute L-N loads to approximately balance the loads on L1 and L2.

### 9.4 Battery Level Indicators (5 Green)

The Battery Level indicators display approximate battery capacity at all times. Each indicator represents an approximate 20 percent increase in battery capacity.

The S4K4U6000 is equipped with automatic and remote battery test features. The automatic test occurs every 14 days (this option is user-configurable) if utility has not been interrupted. Should the battery fail this test, the red Fault indicator along with the A and C diagnostic indicators will illuminate and an alarm will sound (refer to **13.0 - Troubleshooting**). The remote test feature functions with MultiLink 3 software and can remotely initiate the battery test.

### 9.5 Fault Indicator (Red)

The Fault indicator is illuminated if the UPS has detected a problem. Also, one or more of the Battery Level indicators may be illuminated (refer to **13.0 - Troubleshooting** section).

### 9.6 Bypass Indicator (Amber)

The Bypass indicator is illuminated when the UPS is operating from bypass power. An alarm will sound indicating the UPS detected a problem or the manual bypass function has been activated.

### 9.7 UPS ON Indicator (Green)

The UPS ON indicator is illuminated when the UPS inverter is operating and supplying power to your connected loads.

### 9.8 Battery Indicator (Amber)

The Battery indicator is illuminated when the UPS is operating on battery.

### 9.9 AC Input Indicator (Green)

The AC Input indicator is illuminated when utility power is available and within the input specifications.

## 10.0 MODES OF OPERATION

### 10.1 Normal Mode Operation

During normal operation, utility power provides energy to the UPS. The filters, power factor correction circuit and the inverter process this power to provide computer grade power to connected loads. The UPS maintains the batteries in a fully charged state. The four green Load Level indicators display an approximate level of load in 25% increments. If the UPS becomes loaded beyond full rating, the fifth (amber) indicator will illuminate and the UPS will sound an audible alarm. The display template indicates the percentage of load (see example at right) on the UPS output.

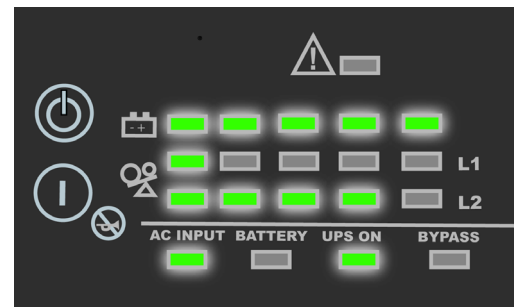

**Normal Mode Operation**  
**Batteries at 100% charge**  
**L1 Load at 10%, L2 Load at 90%**

### 10.2 Battery Mode Operation

Battery mode occurs in event of an extreme input voltage condition or complete utility failure. The battery system supplies power through the DC to DC converter to the inverter to generate power for the connected load. During battery mode an alarm sounds every 10 seconds. This will change to two beeps every 5 seconds when the battery runs low (approximately 2 minutes remaining, but this is user configurable). The AC Input indicator will extinguish and the Battery indicator will illuminate to warn that a utility problem has occurred. Each Battery Level indicator represents a 20% capacity level. As capacity decreases, fewer indicators remain illuminated. Refer to **13.0 - Troubleshooting**. For approximate battery run times, refer to **Table 7 - Battery run times**. These times are approximate based on resistive load and an ambient temperature of 77°F (25°C). To increase this time, turn off non-essential pieces of equipment (such as idle computers and monitors) or add the optional external battery cabinet.

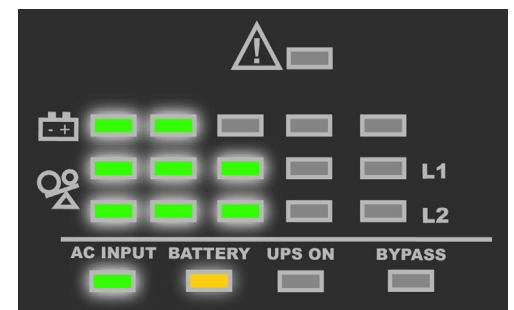

**Battery Mode Operation**  
**Batteries at 30% charge**  
**L1 Load at 60%, L2 Load at 60%**



## CAUTION

Turning OFF the UPS while in battery mode will result in loss of output power.

### 10.3 Battery Recharge Operation

Once utility power is restored, the UPS resumes normal operation. At this time, the Battery Charger begins recharging.

## 11.0 COMMUNICATIONS

### 11.1 Communications Interface Port

The S4K4U6000 UPS has a standard DB-9 serial port female connector located on the rear of the UPS unit. Several signals are provided on this port and are assigned as follows:

**Table 3 DB-9 pin assignment**

| DB-9 Pin | Assignment Description                                    |
|----------|---|
| 1        | Low Battery (open collector)                              |
| 2        | UPS TxD (typically RS-232 levels)                         |
| 3        | UPS RxD (typically RS-232 levels)                         |
| 4        | Remote Shutdown (5-12VDC, 10-24mA max; battery operation) |
| 5        | Common  |
| 6        | Remote Shutdown (short to pin 5); all modes of operation  |
| 7        | Low Battery (open emitter)                                |
| 8        | Utility Fail (open emitter)                               |
| 9        | Utility Fail (open collector)                             |

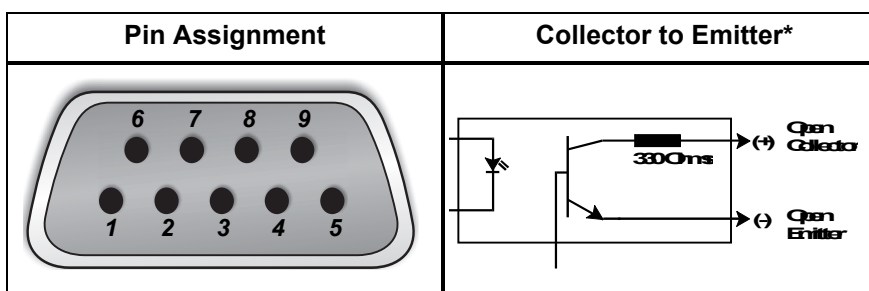

\* Maximum voltage and current on pins 1, 7, 8 and 9 are 60VDC and 10.0 mA

#### 11.1.1 DB-9 Interface Port

Using the following directions to attach the smaller enclosed ferrite bead clamp to the communication cable as shown at right:

1. Open the ferrite bead.
2. Place the communication cable inside the ferrite bead groove.
3. Position the ferrite bead as close as possible to the end of the cable that connects to the DB-9 connector of the UPS.
4. Close the ferrite bead so that the ferrite bead's case snaps closed with the cable routed through the ferrite bead's case.

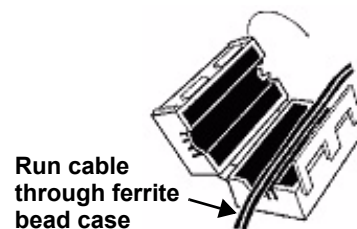

#### 11.1.2 Communications SNMP Adapter - SNMP WEB CARD

Attach the larger enclosed ferrite bead clamp to the network cable, see illustration at right, using the following directions:

1. Open the ferrite bead.
2. Place the network cable inside the ferrite bead groove.
3. Wrap the cable once around the ferrite bead.
4. Position the ferrite cable as close as possible to the end of the cable that connects to the UPS.
5. Close the ferrite bead so that the ferrite bead's case snaps closed with the cable routed through the ferrite bead's case.

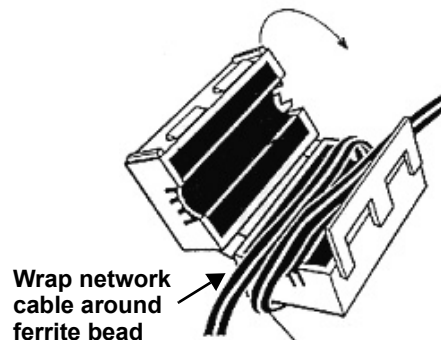

## 11.2 Pin 4 - Remote Shutdown on Battery

1. This pin is functional only when the UPS is in battery mode. If the UPS is being powered by the utility, Pin 4 will ignore any signal on this pin.
2. Pin 4 requires a 5-12 VDC signal to shutdown. This normally comes from the serial port using Sola/Hevi-Duty's contact closure cable. It cannot be used with just a contact closure unless the relay is used to switch a voltage source. A 5-12 VDC signal for 1.5 seconds or greater is required to signal a shutdown. Signals for less than 1.5 seconds will be ignored. After Pin 4 receives a shutdown signal for 1.5 seconds, the command cannot be canceled.
3. A battery shutdown signal on Pin 4 will NOT cause an immediate Shutdown. A shutdown signal will start a 2-minute shutdown timer. The timer cannot be stopped. After 2 minutes, the UPS will shut down.
4. If the utility returns during the 2-minute timer countdown, the shutdown timer will continue until the end of 2 minutes and the UPS will turn OFF. The UPS must remain OFF for at least 10 seconds even if AC input power Returns before the UPS turns OFF. This serves to reset and restart the server.

Whether the UPS turns back ON when power is restored depends on the auto-restart setting: enabled or disabled.

If the auto-restart is disabled, the UPS will not restart after performing the 2-minute shutdown delay.

## 11.3 UPS Intelligent Communications

The S4K4U6000 is equipped with an Intellislot<sup>®</sup> port to provide advanced communication and monitoring options.

Sola/Hevi-Duty's MultiLink software continually monitors the UPS and can shut down your computer or server in the event of an extended power failure.

MultiLink can also be configured for use without the serial cable when the Intellislot SNMP WEB CARD is installed in the UPS. Additionally, MultiLink can be configured to coordinate shutdown across the network with other computers running MultiLink when you purchase a MultiLink License Kit. For more information about the Intellislot SNMP WEB CARD and MultiLink License Kits, visit our Web site ([www.solaheviduty.com](http://www.solaheviduty.com)) or contact your local dealer, Sola/Hevi-Duty representative or Sola/Hevi-Duty Technical Services.

Several option cards are available for use in the Intellislot port of the S4K4U6000 The Intellislot SNMP WEB CARD provides SNMP and Web-based monitoring and control of the UPS across the network.

The Intellislot MULTIPORT4CARD allows you to install MultiLink software on four computers and coordinate shutdown in the event of a power failure.

The Intellislot RELAY CARD-INT provides dry contact relay outputs for custom wired applications and delivers support for built-in shutdown for AS/400 systems.



### CAUTION

To maintain safety (SELV) barriers and for electromagnetic compatibility, signal cables should be segregated and run separate from all other power cables, where applicable.

## 11.4 Remote Emergency Power Off

The UPS is equipped with a Remote Emergency Power Off (REPO) connector.

The user must supply a means of interfacing with the REPO circuit to allow disconnecting the UPS input feeder breaker to remove all sources of power to the UPS and connected equipment to comply with national and local wiring codes and regulations.

**Figure 5 REPO switch connections**

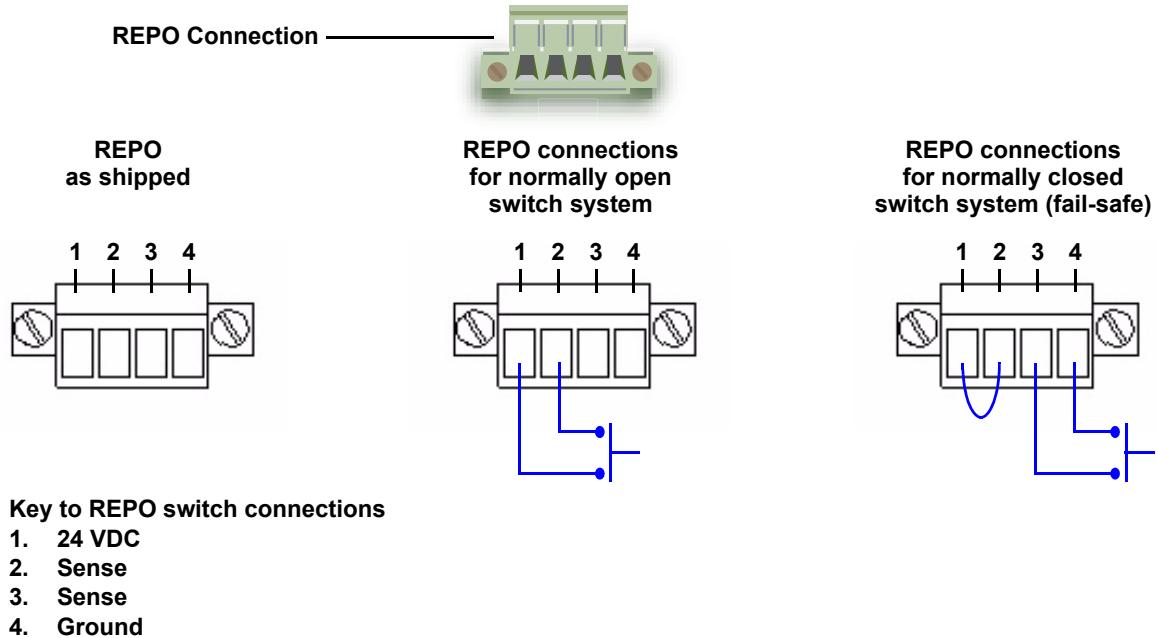

### CAUTION

To maintain safety (SELV) barriers and electromagnetic compatibility, signal cables should be segregated and run separately from power cables.

## 12.0 MAINTENANCE

The S4K4U6000 requires very little maintenance. The batteries are valve-regulated, non-spillable, flame retardant, lead acid and should be kept charged to obtain their design life. The UPS continuously charges the batteries when connected to the utility supply.

When storing the UPS for any length of time, it is essential to plug the UPS in for at least 24 hours every four to six months to ensure full recharge of the batteries. Failure to recharge the batteries periodically will permanently degrade battery capacity.

The S4K4U6000 is designed to allow the user to safely replace the internal batteries. Read the safety cautions before proceeding. Contact your local dealer or Sola/Hevi-Duty representative to obtain the appropriate replacement battery kit part number and pricing.

### 12.1 Battery Replacement



#### CAUTION

A battery can present a risk of electrical shock and high short circuit Current. The following precautions should be observed before replacing the batteries:

- Remove rings, watches and other metal objects.
- Use a Phillips (crosshead) screwdriver with insulated grips.
- Do not lay tools or other metal objects on top of the batteries.
- If the battery replacement kit is damaged in any way or shows signs of leakage, contact your local dealer or Sola/Hevi-Duty representative immediately.
- Do not dispose of batteries in a fire. The batteries may explode.

#### 12.1.1 Internal Battery Replacement Procedures

1. Gently remove the front metal bezel cover from the UPS by pulling forward.
2. Loosen the two captive screws on the front battery door. Lay the battery door aside for reassembly.
3. Grasp the battery pack assembly and pull it out of the front of the UPS. Be prepared to support the weight of the battery as it is withdrawn.
4. Unpack the new battery assembly taking care not to destroy the packing. Compare new and old battery assemblies to make sure they are the same. If so, proceed with **Step 6**; otherwise STOP and contact your local dealer or Sola/Hevi-Duty representative.
5. Line up and slide in the new replacement battery pack.
6. Reattach the front battery door, tightening the two captive screws finger tight.
7. Reattach the front plastic bezel to the UPS.

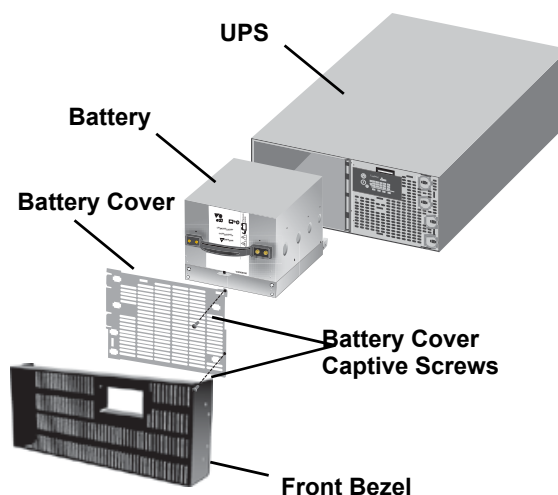

#### NOTE

*These are hot-swappable replacement batteries. However, caution should be exercised because during this procedure the load is unprotected from disturbances and power outages.*



## 12.2 UPS Replacement

When using a power distribution box with bypass, the UPS can be removed while powering the load through the Bypass Switch.



### NOTE

*During the procedure, the connected load will not be protected from power disturbances, such as spikes, sags and failure.*

To remove the UPS without shutting off power to the connected load:

1. Turn the Bypass Switch on the power distribution box to the Utility position.
2. Open the Output circuit breaker (on the UPS rear panel).
3. Open the Input circuit breaker (on the power distribution box).
4. Loosen the three captive mounting screws about 20 turns until the power distribution box can be pulled away from the UPS.
5. Loosen the electrical connector cover by backing out the two screws holding it one turn each. Also loosen the end screw one turn.
6. Slide the cover to reach the end screw and cover the electrical connectors; retighten the three screws gently to hold the cover in place.
7. Replace the UPS.
8. Loosen the three screws holding the electrical connector cover again—one turn each.
9. Slide the cover away from the electrical connectors; gently retighten the three screws.
10. Align the connectors on the power distribution box and the UPS.
11. Push the power distribution box into place.
12. Holding the power distribution box firmly against the UPS, tighten the three captive mounting screws until the box is secure. Do NOT overtighten the screws.
13. Close the Input circuit breaker (on the power distribution box).
14. Close the Output circuit breaker (on the UPS rear panel).
15. Turn the Bypass Switch on the power distribution box back to the UPS position.

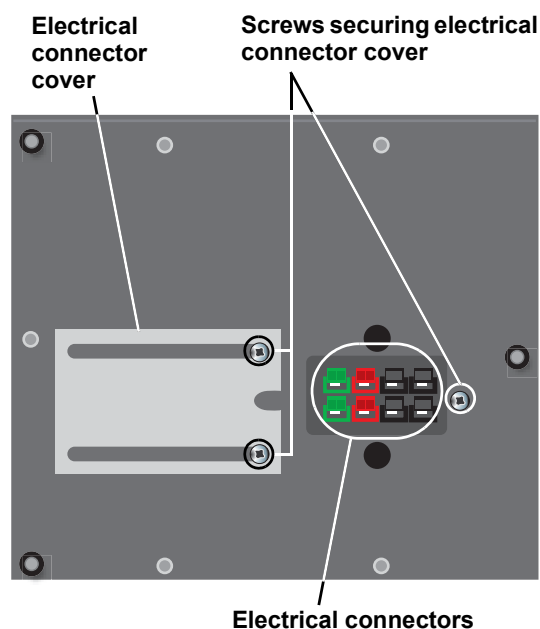
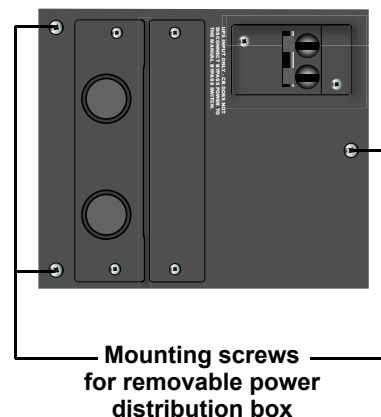

## 13.0 TROUBLESHOOTING

The information below indicates various symptoms a user may encounter in the event the S4K4U6000 develops a problem. Use this information to determine whether external factors caused the problem and how to remedy the situation.

1. The Fault indicator will illuminate, indicating the UPS has detected a problem.
2. An alarm will sound, alerting that the UPS requires attention.
3. One or more additional Load Level/Battery Level indicators will be illuminated to provide a diagnostic aid to the operator, as described below:

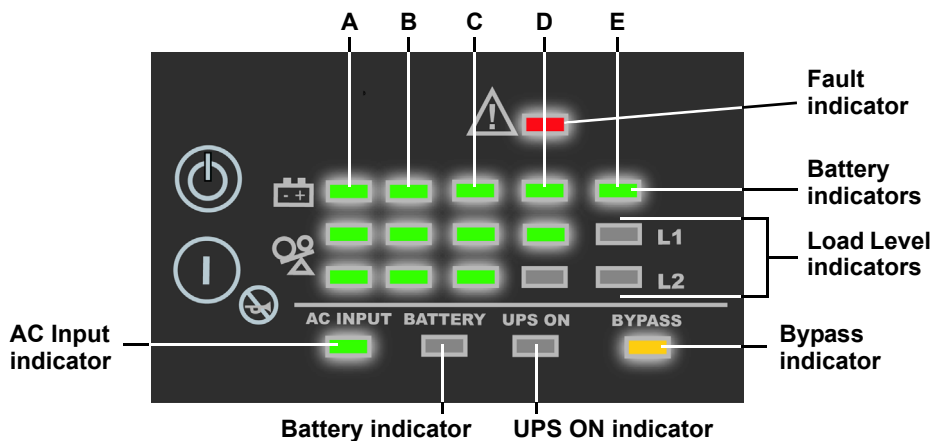

**Table 4** Fault indicators

| Indicator status                                   | Diagnosis/Audible alarm   |
|--|---|
| All indicators                                     | On bypass due to output overload; beep every half-second  |
| Indicator A  | On bypass due to overtemperature condition on L1; 1-second beep every 4 seconds<br>On bypass due to overtemperature condition on L2; 2-second beep every 4 seconds  |
| Indicator B  | On bypass due to DC bus overvoltage on L1; 1-second beep every 4 seconds<br>On bypass due to DC bus overvoltage on L2; 2-second beep every 4 seconds  |
| Indicator C  | On bypass due to control power supply failure on L1; 1-second beep every 4 seconds<br>On bypass due to control power supply failure on L2; 2-second beep every 4 seconds  |
| Indicator D  | On bypass due to PFC failure on L1; 1-second beep every 4 seconds<br>On bypass due to PFC failure on L2; 2-second beep every 4 seconds  |
| Indicator E  | On bypass due to inverter failure on L1; 1-second beep every 4 seconds<br>On bypass due to inverter failure on L2; 2-second beep every 4 seconds  |
| Indicators A&B                                     | Inverter-to-Inverter communications failure; half-second beep every 1 second  |
| Indicators A&C                                     | UPS failed battery test; 2-second beep every 60 seconds   |
| Indicators A&D                                     | L1 to L2 phase angle unacceptable   |
| Indicators B&C                                     | REPO is currently activated, UPS output cannot be started by any method   |
| Indicators B&D                                     | UPS is OFF due to previous REPO (REPO is no longer activated). Once utility power is restored, press the OFF button twice within four seconds (to clear the alarm), then press the ON button to start UPS (Auto-restart is NOT possible). |
| Indicators C&E                                     | UPS shutdown due to command from communications (RS232 or SNMP); no beep  |
| Indicators D&E                                     | UPS is OFF due to charger overvoltage; 1-second beep every 4 seconds  |
| AC Input indicator On & Battery indicator Flashing | AC input has been applied to start UPS but the batteries are either missing or below the minimal level to allow the UPS to start; continuous audible alarm  |
| Bypass indicator Flashing                          | Bypass voltage is present, but is disabled for use because the voltage or frequency is outside acceptable limits  |

Under fault conditions, the Fault indicators will be illuminated indefinitely while the battery charger is operational, or for a maximum of 5 minutes while the battery charger is not operational.

If a problem persists, consult your local dealer or Sola/Hevi-Duty representative. Please have the UPS model number and serial number available at the time of your inquiry.

All audible alarms can be silenced, with the exception of Low Battery, Bypass Reminder and Missing Batteries at Startup alarms. Once silenced, the alarm will not sound again until a new alarm condition is present.

**Table 5 Alarm conditions**

| Condition                                   | Alarm  |
|---|--|
| Battery Mode (utility failure)              | One short beep every 10 seconds; more than 2 minutes of run time remaining |
| Low Battery                                 | Two short beeps every 5 seconds; less than 2 minutes of run time remaining |
| On Bypass Reminder                          | A one-second beep every 2 minutes  |
| Output Overload (bypass)                    | One short beep every half second   |
| Overtemperature (bypass)                    | A one-second, or two-second, beep every 4 seconds                          |
| DC Bus Overvoltage (bypass)                 | A one-second, or two-second, beep every 4 seconds                          |
| Control Power Supply Failure (bypass)       | A one-second, or two-second, beep every 4 seconds                          |
| PFC Failure (bypass)                        | A one-second, or two-second, beep every 4 seconds                          |
| Inverter Failure                            | A one-second, or two-second, beep every 4 seconds                          |
| Inverter-to-Inverter Communications Failure | A one-half second beep every 1 second                                      |
| Battery Test Failure                        | A two-second beep every 1 minute   |
| REPO Activated                              | A one-quarter second beep every half second                                |

**Table 6 Troubleshooting guide**

| Problem  | Cause   | Solution  |
|--|---|---|
| UPS fails to start when the ON button is pressed.                          | UPS is short-circuited or overloaded.   | Ensure the UPS is OFF. Disconnect all loads and ensure nothing is lodged in output receptacles. Ensure the loads are not defective or shorted internally.   |
| Battery indicator is illuminated.  | UPS not plugged in.   | UPS is operating in Battery Mode, make certain UPS is securely plugged into the wall receptacle.  |
|  | UPS input protection fuse has blown/opened.   | UPS is operating in Battery Mode. Save data and close applications. Replace UPS input fuse, then restart UPS.   |
|  | Utility voltage out of UPS input range.   | UPS is operating in Battery Mode. Save data and close applications. Ensure utility supply voltage is within acceptable limits for UPS.  |
| UPS has reduced battery time.  | Batteries are not fully charged.  | Keep UPS plugged in continuously at least 24 hours to recharge batteries.   |
|  | UPS is overloaded.  | Check load level display and reduce the load on the UPS.  |
|  | Batteries may not be able to hold a full charge due to age.   | Replace batteries. Contact your local dealer, Sola/Hevi-Duty representative or Sola/Hevi-Duty Technical Support Services for replacement battery kit.   |
| Fault and Bypass indicators and all Load Level indicators are illuminated. | UPS overloaded or load equipment is faulty.   | Check load level display and remove non-essential loads. Recalculate the load and reduce number of loads connected to UPS. Check load equipment for faults.   |
| Fault and Bypass indicators and diagnostic indicator C are illuminated.    | UPS control power supply fault.   | UPS requires service. Contact your local dealer, Sola/Hevi-Duty representative or Sola/Hevi-Duty Technical Support Services.  |
| Fault and Bypass indicators and diagnostic indicator D are illuminated.    | UPS PFC (Power Factor Correction Circuit) fault.  | UPS requires service. Contact your local dealer, Sola/Hevi-Duty representative or Sola/Hevi-Duty Technical Support Services.  |
| Fault and Bypass indicators and diagnostic indicator A are illuminated.    | UPS internal fan has a problem or UPS shutdown due to temperature condition. Load is on bypass power. | Ensure the UPS is not overloaded, ventilation openings are not blocked and room ambient temperature is not excessive. Wait 30 minutes to allow UPS to cool, then restart UPS. If UPS does not restart, contact your local dealer, Sola/Hevi-Duty representative or Sola/Hevi-Duty Technical Support Services. |

**Table 6 Troubleshooting guide**

| <b>Problem</b>   | <b>Cause</b>  | <b>Solution</b>  |
|--|---|--|
| Fault and Bypass indicators and diagnostic indicator B are illuminated.        | UPS internal DC bus overvoltage.  | UPS requires service. Contact your local dealer, Sola/Hevi-Duty representative or Sola/Hevi-Duty Technical Support Services.   |
| Fault and Bypass indicators and diagnostic indicator E are illuminated.        | UPS inverter fault.   | UPS requires service. Contact your local dealer, Sola/Hevi-Duty Representative or Sola/Hevi-Duty Technical Support Services.   |
| Fault and Bypass indicators and diagnostic indicators A and B are illuminated. | Inverter-to-Inverter Communications Failure   | UPS requires service. Contact your local dealer, Sola/Hevi-Duty Representative or Sola/Hevi-Duty Technical Support Services.   |
| Fault indicator and diagnostic indicators A and C are illuminated.             | UPS failed the battery test.  | Replace batteries. Contact your local dealer, Sola/Hevi-Duty representative or Sola/Hevi-Duty Technical Support Services.  |
| Fault indicator and diagnostic indicators A and D are illuminated.             | L1 to L2 phase angle unacceptable.  | Only phase angles of 120, 180 or 240 degrees ( $\pm 10$ degrees) are permitted. These must be compatible with the selections in the configuration program.<br>Or the phase angle has changed while the UPS was running. The phase angle is detected at startup and cannot be changed to a different power source while running.<br>Turn the UPS Off and wait until the fans stop. Apply input AC power. The UPS will reprogram the phase angle to match the utility, if the utility is 120, 180 or 240 degrees between L1 and L2. If this does not resolve the issue, contact a qualified electrician to verify the site wiring. |
| Fault indicator and diagnostic indicators B and C are illuminated.             | REPO is currently activated.  | UPS has shut down due to the REPO (Remote Emergency Power Off). The output cannot be started by any method.  |
| Fault indicator and diagnostic indicators B and D are illuminated.             | UPS output is OFF from a previous REPO command. REPO is no longer activated.                                      | UPS is OFF due to previous REPO (REPO is no longer activated). Once utility power is restored, press the OFF button twice within four seconds (to clear the alarm), then press the ON button to start UPS (Auto-restart is NOT possible).  |
| Fault indicator and diagnostic indicators C and E are illuminated.             | UPS shutdown due to a command from the communications port(s).  | Your UPS has received a signal or command from the attached computer. If this was inadvertent, ensure the communication cable used is correct for your system. For assistance, contact your local dealer, Sola/Hevi-Duty representative or Sola/Hevi-Duty Technical Support Services.  |
| Fault indicator and diagnostic indicators D and E are illuminated.             | UPS charger fault.  | UPS requires service. Contact your local dealer, Sola/Hevi-Duty Representative or the Sola/Hevi-Duty Technical Support Services.   |
| AC Input indicator is On & Battery indicator is flashing.                      | Battery source is not available; continuous horn.   | Check battery connections, completely power down and restart UPS.<br>NOTE: If the battery circuit opens while the UPS is running, it will be detected when the next battery test is performed.   |
| Bypass indicator is flashing.  | Bypass voltage is present, but is disabled for use because the voltage or frequency is outside acceptable limits. | The AC input powers the PFC input and serves as the bypass source. If the AC is present but the voltage or frequency exceeds the acceptable range for safe operation with a load, the bypass will be disabled and this indicator will flash, indicating that the bypass is unavailable.  |

Using the configuration program, the user may specify the number of S4K4U6000 external battery cabinets attached to the UPS. The factory default is programmed for internal batteries only.

Table 7 shows estimated run times at different loads.

**Table 7 Battery run times**

| Battery/External Cabinets                      | Load% | 6000VA Run Time in Minutes |
|--|-------|----------------------------|
| Internal Battery                               | 10%   | 75                         |
|  | 20%   | 38                         |
|  | 30%   | 25                         |
|  | 40%   | 18                         |
|  | 50%   | 14                         |
|  | 60%   | 11                         |
|  | 70%   | 9                          |
|  | 80%   | 7                          |
|  | 90%   | 6                          |
|  | 100%  | 5                          |
| Internal Battery + 1 External Battery Cabinet  | 10%   | 156                        |
|  | 20%   | 90                         |
|  | 30%   | 62                         |
|  | 40%   | 44                         |
|  | 50%   | 34                         |
|  | 60%   | 28                         |
|  | 70%   | 23                         |
|  | 80%   | 19                         |
|  | 90%   | 16                         |
|  | 100%  | 14                         |
| Internal Battery + 2 External Battery Cabinets | 10%   | 235                        |
|  | 20%   | 137                        |
|  | 30%   | 99                         |
|  | 40%   | 74                         |
|  | 50%   | 58                         |
|  | 60%   | 47                         |
|  | 70%   | 39                         |
|  | 80%   | 33                         |
|  | 90%   | 28                         |
|  | 100%  | 25                         |
| Internal Battery + 3 External Battery Cabinets | 10%   | 313                        |
|  | 20%   | 183                        |
|  | 30%   | 133                        |
|  | 40%   | 103                        |
|  | 50%   | 82                         |
|  | 60%   | 67                         |
|  | 70%   | 55                         |
|  | 80%   | 47                         |
|  | 90%   | 41                         |
|  | 100%  | 36                         |
| Internal Battery + 4 External Battery Cabinets | 10%   | 391                        |
|  | 20%   | 229                        |
|  | 30%   | 166                        |
|  | 40%   | 129                        |
|  | 50%   | 105                        |
|  | 60%   | 87                         |
|  | 70%   | 73                         |
|  | 80%   | 63                         |
|  | 90%   | 54                         |
|  | 100%  | 47                         |

## **13.1 Auto-Learning Battery Run Times**

As batteries age, the estimated run times may become less accurate. The S4K4U6000 is programmed to “learn” from a full battery discharge and modify the estimated run time for the measured battery capacity. This can improve accuracy and compensate for aging batteries or batteries that operate at different ambient temperatures.

The UPS will update the anticipated run time calculation only under certain conditions.

- The UPS must have a steady load that is greater than 20%.
- The UPS must be at 100% charge at the start of a battery discharge.
- The battery discharge must continue uninterrupted until the batteries reach their end-of-discharge voltage.

If all conditions are not met, the run time calculation will not be modified.

If the configuration program is used to change the number of battery cabinets, then the values in the battery table on the right will be restored. This will override any value that is automatically learned.

## 14.0 SPECIFICATIONS

**Table 8 UPS specifications**

| Model Number  | S4K4U6000   |
|---|---|
| Model Rating  | 4200W/5200VA at 127/220 (120 or 240 degrees only)   |
|   | 4200W/5200VA at 120/208 (120 or 240 degrees)  |
|   | 4200W/6000VA at 120/240 (180 degrees)   |
|   | 4200W/6000VA at 115/230 (180 degrees only)  |
|   | 3780W/5400VA at 110/220 (180 degrees only)  |
|   | 3360W/4800VA at 100/200 (180 degrees only)  |
| <b>DIMENSIONS in (mm)</b>   |   |
| Unit W x D x H in. (mm)   | 6.9 x 24.2 x 16.9 (176 x 615 x 430)   |
| Shipping W x D x H in. (mm)   | 13.2 x 27.8 x 20.9 (335 x 705 x 530)  |
| <b>WEIGHT lbs (kg)</b>  |   |
| Unit  | 67 (30.3)   |
| Shipping  | 76.3 (34.6)   |
| <b>INPUT AC PARAMETERS</b>  |   |
| Nominal Operating Frequency   | 50 or 60 Hz (Factory Default = 60)  |
| Factory Default VAC   | 120/208 VAC at 120 degrees  |
| L1-L2 Factory Default Input Phase Angle   | 120 degrees   |
| Allowable Input Phase Angle   | 120, 180, 240 degrees, Auto-sensing on application of AC (Restrictions for L-N voltages other than 120 VAC) |
| Factory Default L1-N, L2-N VAC  | 120 VAC nominal   |
| User Configurable L1-N, L2-N VAC  | 100/110/115/120/127 VAC (May be modified using configuration program)                                       |
| <b>L1-N, L2-N, Operating Voltage Range Without Battery Operation (Except 100 VAC L-N Operation)</b> |   |
| 100% - 90% loading  | 90 VAC - 140 VAC  |
| 90% - 70% loading   | 80 VAC - 140 VAC  |
| 70% - 30% loading   | 70 VAC - 140 VAC  |
| 30% - 0% loading  | 60 VAC - 140 VAC  |
| <b>L1-N, L2-N, Operating Voltage Range Without Battery Operation (100 VAC L-N Operation)</b>        |   |
| 100% - 70% loading  | 80 VAC - 140 VAC  |
| 70% - 30% loading   | 70 VAC - 140 VAC  |
| 30% - 0% loading  | 60 VAC - 140 VAC  |
| L1-N, L2-N Max. Allowable VAC   | 150 VAC   |
| Input Frequency w/o Battery Operation   | 40 - 70 Hz  |
| Input Power Connection  | See Distribution Box Options  |
| <b>OUTPUT AC PARAMETERS</b>   |   |
| Factory Default VAC   | 120/208 VAC @ 120 degrees   |
| L1-L2 Factory Default Output Phase Angle  | 120 degrees   |
| Allowable Output Phase Angle  | 120, 180, 240 degrees Auto-sensing on initial application of input AC                                       |
| Factory Default L1-N, L2-N VAC  | 120 VAC nominal   |
| User Configurable L1-N, L2-N VAC  | 100/110/115/120/127 VAC, $\pm 3\%$  |
| Output Connections  | See Distribution Box Options  |
| Frequency   | 50 Hz or 60 Hz, Nominal   |
| Waveform  | Sinewave  |
| Main Mode Overload  | 200% for 8 cycles; 130% for 10 seconds with transfer to bypass  |
| <b>Bypass Protection Limits</b>   |   |
| Disable Bypass operation  | If input voltage exceeds $\pm 15\%$ of the nominal voltage  |
| Re-enable Bypass operation  | If input voltage returns to within $\pm 10\%$ of nominal output voltage                                     |
| Disable Bypass operation  | When the input frequency prevents synchronous operation   |

**Table 8 UPS specifications (continued)**

| Model Number         | S4K4U6000  |
|----------------------|--|
| <b>ENVIRONMENTAL</b> |  |
| Operating Temp       | +32°F to +104°F (0°C to +40°C)   |
| Storage Temp         | +5°F to +122°F (-15°C to +50°C)  |
| Relative Humidity    | 0% to 95%, non-condensing  |
| Operating Elevation  | Up to 10,000 ft. (3000m) at 104°F (40°C) without derating                        |
| Storage Elevation    | 50,000 ft. (15,000 m) maximum  |
| Audible Noise        | <55 dBA, at 1 meter from the rear<br><50 dBA, at 1 meter from the front or sides |
| <b>AGENCY</b>        |  |
| Safety               | UL 1778, c-UL Listed (Suitable for computer room applications)                   |
| RFI/EMI              | FCC Part 15, Subpart B, Class A  |
| Surge Immunity       | IEEE/ANSI C62.41 Category A & B  |
| Transportation       | ISTA Procedure 1A  |

**Table 9 Battery specifications**

| Model Number                | S4K144INTBAT  |
|-----------------------------|---|
| <b>DIMENSIONS in (mm)</b>   |   |
| Shipping W x D x H in. (mm) | 13.4 x 27.2 x 13.4 (340 x 690 x 340)                        |
| <b>WEIGHT lbs (kg)</b>      |   |
| Unit                        | 79 (35.8)   |
| Shipping                    | 84 (38.1)   |
| Type                        | Valve-regulated, non-spillable, flame retardant, lead acid  |
| Quantity x V x Rating       | 12 x 12V x 9.0 AH   |
| Battery Mfg / Part #        | Yuasa / REW 45-12 FR  |
| Back-Up Time                | See <b>Table 7 - Battery run times</b>                      |
| Recharge Time               | 6 Hours to 90% capacity after full discharge into 100% load |

**Table 10 Power distribution box specifications**

| Model Number                 | S4KPAD-HDWR   |
|------------------------------|---|
| Amp Rating                   | 24 Amps   |
| Input Power Connection       | 4-Wire Hardwired, 8-10AWG                                       |
| Output Power Connection      | 4-Wire Hardwired, 8-10AWG                                       |
| Input Branch Circuit Breaker | 30 Amp, Supplied by User  |
| Model Number                 | S4KPAD-HDWR-MBS   |
| Amp Rating                   | 24 Amps   |
| Input Power Connection       | 4-Wire Hardwired, 8-10AWG                                       |
| Output Power Connection      | 4-Wire Hardwired, 8-10AWG                                       |
| Includes:                    | Manual Bypass Switch with Indicator Lamps                       |
| Input Branch Circuit Breaker | 30 Amp, Supplied by User  |
| Model Number                 | S4KPAD-001  |
| Amp Rating                   | 24 Amps   |
| Input Power Connections      | L14-30P on 10 foot cord   |
| Output Power Connection      |   |
| L1-L2-G                      | (1) L6-30R on a 300mm cord                                      |
| L1-L2-N-G                    | (1) L14-30R on a 300mm cord                                     |
| L1-N-G                       | (2) 5-15/20R, T-type, receptacles with (2) 20A circuit breakers |
| L2-N-G                       | (2) 5-15/20R, T-type, receptacles with (2) 20A circuit breakers |
| Includes:                    | Manual Bypass Switch with Indicator Lamps                       |
| Input Branch Circuit Breaker | 30 Amp, Supplied by User  |



**Table 11 External battery cabinet specifications**

|                             |  |
|-----------------------------|--|
| <b>Model Number</b>         | <b>S4K144BAT</b>   |
| <b>Used w/ UPS Model</b>    | <b>S4K4U6000</b>   |
| <b>DIMENSIONS in (mm)</b>   |  |
| Unit (with bezel) W x D x H | 3.5 x 24.2 x 17 (87 x 618 x 430)                               |
| Shipping W x D x H          | 10.5 x 27.2 x 23 (268 x 692 x 585)                             |
| <b>WEIGHT lbs (kg)</b>      |  |
| Unit                        | 93.6 (42.5)  |
| Shipping                    | 105 (47.6)   |
| <b>BATTERY PARAMETERS</b>   |  |
| Type                        | Valve-regulated, non-spillable, flame retardant, lead acid     |
| Qty x V x Rating            | 12 x 12V x 9.0 AH  |
| Battery Mfg / Part #        | Yuasa / REW 45-12 FR   |
| Back-Up Time                | See <b>Table 7 - Battery run times</b>                         |
| <b>ENVIRONMENTAL</b>        |  |
| Operating Temp              | +32°F to +104°F (0°C to +40°C)                                 |
| Storage Temp                | +5°F to +122°F (-15°C to +50°C)                                |
| Relative Humidity           | 0% to 95%, non-condensing                                      |
| Operating Elevation         | Up to 10,000 ft. (3000m) at 104°F (40°C) without derating      |
| Storage Elevation           | 50,000 ft. (15,000m) maximum                                   |
| <b>AGENCY</b>               |  |
| Safety                      | UL 1778, c-UL Listed (Suitable for computer room applications) |
| RFI/EMI                     | FCC Part 15, Subpart B, Class A                                |
| Transportation              | ISTA Procedure 1A  |

## 14.1 Product Warranty Registration

To register for warranty protection:

- Visit the **Technical Support** section of our Web site at:  
<http://www.solaheviduty.com/support/index.htm>
- Click on the **Warranty** link and fill in the form. This will register your product with Sola/Hevi-Duty.

For UPS purchasers: The MultiLink software is available for download in the Products section of our website under UPS (<http://www.solaheviduty.com/products/UPS/software/index.htm>)

Contact us at (800) 377-4384 or via email at [tech@sola-hevi-duty.com](mailto:tech@sola-hevi-duty.com) with any questions.:







**POWER AVAILABILITY**

**S4K4U6000**

**USER MANUAL**

## **TECHNICAL SUPPORT**

U.S.A.....(800) 377-4384

International.....(847) 268-6000

[www.solaheviduty.com](http://www.solaheviduty.com)

While every precaution has been taken to ensure accuracy and completeness in this manual, Sola/Hevi-Duty assumes no responsibility, and disclaims all liability for damages resulting from use of this information or for any errors or omissions.

© 2005 Sola/Hevi-Duty. All rights reserved throughout the world.

Specifications subject to change without notice.

® Sola/Hevi-Duty name and logo are registered trademarks of EGS Electrical Group, LLC. Intellislot is a registered trademark of Emerson Network Power. Multilink is a trademark of Emerson Network Power. All names referred to are trademarks or registered trademarks of their respective owners.

Rev. 0 (2/05) S4K4U6000