

GSM/GPRS/GPS Vehicle Tracker USER MANUAL



Preface

Thank you for purchasing the tracker. This manual shows how to operate the device smoothly and correctly. Make sure to read this manual carefully before using this product. Please note that specification and information are subject to changes without prior notice in this manual. Any change will be integrated in the latest release. The manufacturer assumes no responsibility for any errors or omissions in this document.

Contents

1. FUNCTION INTRODUCTION.....	4
2. APPLICATIONS	4
3. HARDWARE DESCRIPTION.....	4
4. ACCESSORIES	5
5. SPECIFICATIONS	6
6. INSTALLATION	7
6.1 Installation instructions.....	7
6.2 Installation wiring diagram	7
6.3 SIM Installation	8
7. FUNCTION AND OPERATION.....	8
7.1 Turn on device.....	8
7.2 GSM/GPS LED Indicator	8
7.3 Alarming LED indicator	8
7.4 Initialization	9
7.5 Change Password.....	9
7.6 Authorization.....	9
7.7 Modes switch “track” , “monitor”& “call”	9
7.8 Single Locating.....	9
7.9 Auto track continuously.....	10
7.10 Get location in absolute street address	10
7.11 Location based service (LBS).....	10
7.12 View photos on cell phone.....	10
7.13 Storage	10
7.13.1 Auto Storage	11
7.13.2 Storage upon Times.....	11
7.13.3 Multi-Storage.....	11
7.13.4 Storage Clearance	11
7.14 Data Load	11
7.15 Dialer.....	11
7.15.1 Picture of Dialer	11
7.15.2 Dialer Learning Code.....	11
7.15.3 Dial a Phone	11
7.16 Remote Control Button Identification	11
7.17 Arm.....	12
7.17.1 Set up arm by SMS	12
7.17.2 Set up arm by Remote Control	12
7.18 Disarm	12
7.18.1 Disarm by SMS.....	12
7.18.2 Disarm by Remote Control.....	12
7.18.3 Alarm Pause.....	12
7.19 Find vehicle via remote control.....	12
7.20 sound and light Deterrence	12
7.21 Remote Trunk Release	13
7.22 Alerts Function.....	13
7.22.1 SOS Emergency Alarm	13
7.22.2 Geo-fence	13
7.22.3 Movement alarm	13

7.22.4 Over Speed Alarm.....	13
7.22.5 Fuel Checking Alerts.....	14
7.22.6 Temperature Checking Alerts	14
7.22.7 Low Battery Alert.....	14
7.22.8 Power off alarm	14
7.22.9 Door Open Alarm	15
7.22.10 Bonnet alerts	15
7.22.11 Footbrake Alerts	15
7.22.12 ACC alerts	15
7.22.13 Shock sensor alerts	15
7.23 Auto Photograph	15
7.24 Alerts Resend	15
7.25 Car Trigger Memory/informing.....	15
7.26 Cut off the Oil and Power System	15
7.27 Resume the Oil and Power System	16
7.28 Disarm and Arm Recover	16
7.29 auto-arming	16
7.30 Arm remind	16
7.31 Door closing remind	16
7.32 Automatic Central Locking System	16
7.33 Park warming	12
7.34 Silent Mode.....	16
7.34.1 Set up silent mode by SMS.....	16
7.34.2 Set up Silent Mode by Remote Controller	16
7.35 Check the Vehicle State	17
7.36 Reset by SMS	17
7.37 Check IMEI	17
7.38 Terminal (local) Time Setting	17
7.39 GPRS Setting	17
7.40 Setting up APN	17
7.41 GPRS User Name and password Setup.....	18
7.42 IP and Port Setup.....	18
7.43 Modes Switch between “SMS” and “GPRS”	18
8. CAUTIONS	18
9. FAULTS & THE SOLUTIONS	19

1. Function introduction

1.1 This tracker is a new product based on the GSM / GPRS network and GPS satellite positioning system, which set multiple functions of security, positioning, monitoring surveillance, emergency alarms and tracking in its entirety. It can track and monitor remote target by SMS or internet.

1.2 Features

- 1.2.1 GPS/LBS (location based service) double way tracking solution.
- 1.2.2 SMS/GPRS/Internet Network data transmission (GPRS/Internet instructions in CD enclosed).
- 1.2.3 GPRS on-line and GPRS re-connected automatically if GPRS drops.
- 1.2.4 SMS / GPRS dual-mode switching
- 1.2.5 Configure by remote terminal.
- 1.2.6 Remote control vehicle
- 1.2.7 Central locking system
- 1.2.8 Two way voice communication
- 1.2.9 Monitor
- 1.2.10 Photo Snapshot automatically upon alarm trigger and view photo by cell phone or web server.
- 1.2.11 Fuel level measurement, Oil leakage or theft alarm.
- 1.2.12 Temperature detection.
- 1.2.13 Support SD card to memorize positions.
- 1.2.14 Full-featured security function.
- 1.2.15 Support for point-to-point, point to group, group-to-group monitoring.

2. Applications

Used widely for positioning and tracking vehicle and other moving objects.

3. Hardware Description

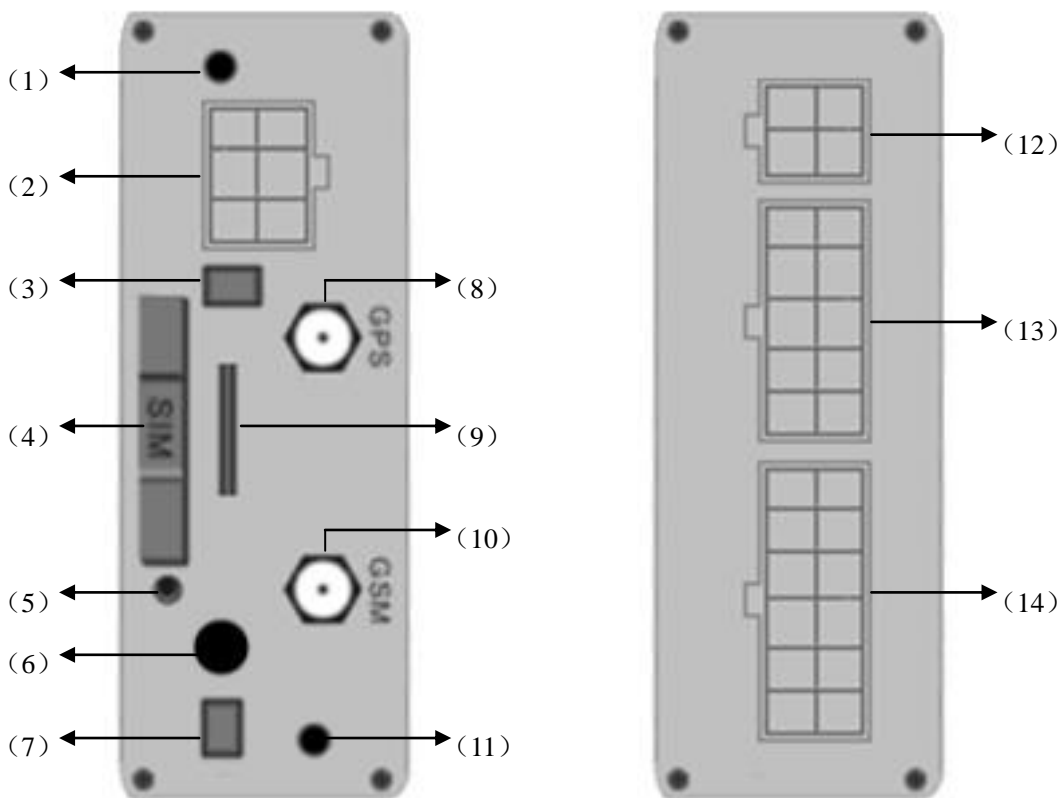

(1).LED Indicator

(2).6PIN harness port

(3). J1 / Electric lock & Air lock switch

(8). GSM antenna connector.

(9).SD card slot





(10).GSM antenna connector

- (4).SIM Card slot
 (5). SIM card slot Pop-up switch
 (6).Monitor MIC jack
 (7). Backup battery switch

- (11). Remote control receiver antenna
 (12).Camera port
 (13).10PIN harness port
 (14).12PINharness port

4. ACCESSORIES

NO.	PICTURES	NAME	SPECS
1		GPS antenna	3 meters
2		GSM antenna	3 meters
3		Micro phone	1.5 meters
4		Harness	12PIN
5		Harness	10PIN
6		Harness	6PIN
7		Relay	12V/40A
8		Shock sensor	
9		Alarm Siren	
10		Voice siren	

11		Remote controller	
12		Dialer	
13		Camera	Option
14		Temperature sensor	Option
15		Fuel sensor	Option

5.Specifications

Content	Specifications
DIM.	110*82*28mm
Weight	220g
Network	GSM/GPRS
Band	850/900/1800/1900Mhz
GSM/GPRS Module	Simcom900B
GPS Module	SIRF3 chip
GPS sensitivity	-159dBm
GPS Accuracy	5m
GPS Start Time	Cold status 45s Warm status 35s Hot status 1s
Applicable vehicle power	12 V
Backup battery	Chargeable changeable 3.7V 800mAh Li-ion battery
Storage Temp	-40 ℃ to +85 ℃
Operation Tem.	-20 ℃ to +65 ℃
Humidity	5%--95% non-condensing
Interface	15digital outputs; 8 digital inputs; 1 analog input; 1 single BUS; 1 serial port

6. Installation

6.1 Installation instructions

6.1.1 Please ask the qualified engineers to install.

6.1.2 Do not install it in an environment which is over GSM performance and please fix the antennas in an appropriate position with good reception.

6.1.3 Make sure installation position preventing water and dust.

6.1.4 Find the 6 PIN, 10 PIN and 12 PIN harness in package and insert it into the corresponding holes of the products, and connect the wires to the original car circuit as the installation diagram showing below:

6.1.5 Knowing about the type of the door trigger is positive or negative. Please connect the green wire to the door control circuit if it is positive, and connect blue wire if it is negative.

6.1.6 Electric/Air compressor lock switch:

Confirm vehicle central lock is electric or air compressor lock:

Electric lock: Plug J1, action time 0.5 second.

Air compressor lock: Unplug J1, action time 5 seconds.

6.1.7 Fuel sensor diagram instructions: Refer to the fuel sensor installation instructions.

6.1.8 Connect the GPS and GSM antenna to the right connector, and find an appropriate place to fix the antennas to make sure good reception.

6.2 Installation wiring diagram

6.2.1 Main unit installation wiring diagram

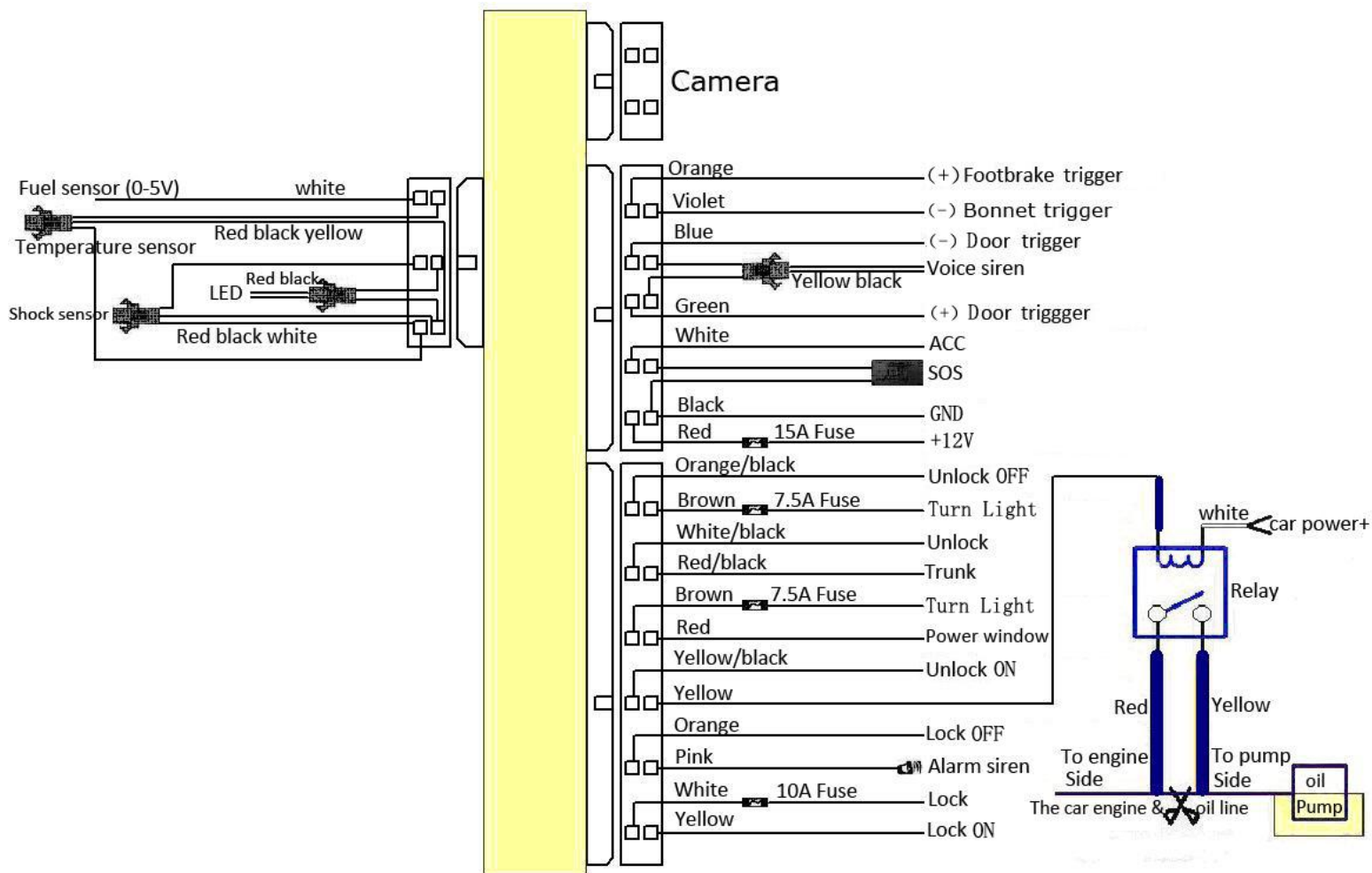

6.2.2 Central locking system wiring diagram

STRUCTURE OF CENTRAL LOCK

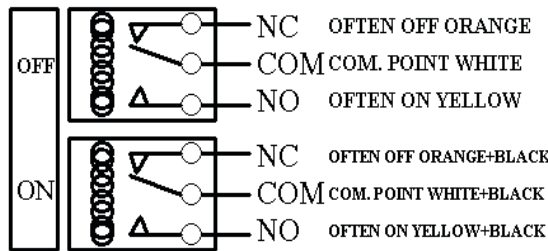

NEGATIVE TRIGGER

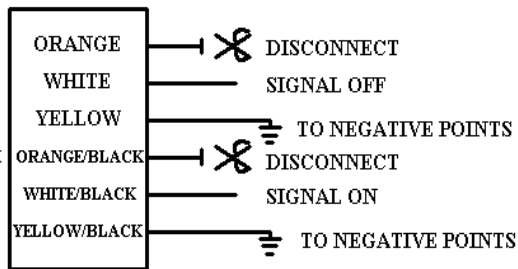

POSITIVE-NEGATIVE TRIGGER

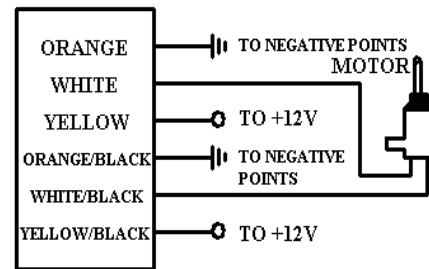

POSITIVE TRIGGER

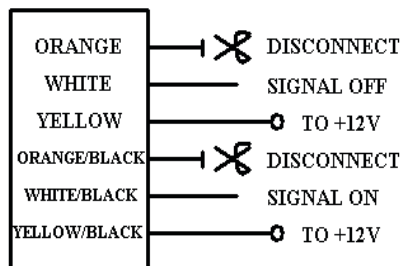

CIRCUIT FOR PETROLIC LOCK

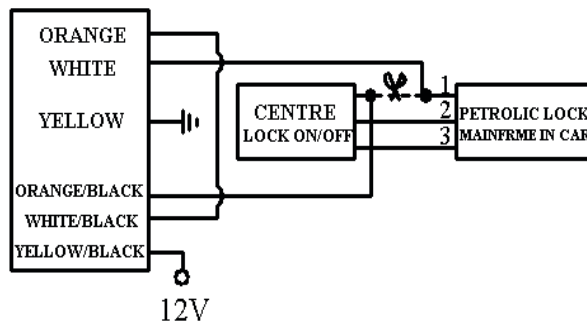

POSITIVE CIRCUIT TRIGGER

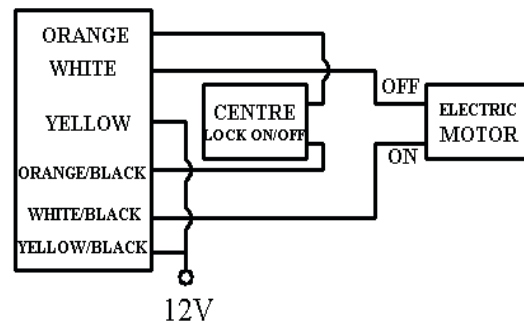

6.3 SIM Installation

6.3.1 Use a tweezers or a sharp thing to touch the SIM CARD popup switch, the SIM CARD slot will pop up, take out the SIM card slot to load the SIM card, and then put the SIM card slot back to its original position after confirm the SIM card in the right place.

6.3.2 Please make sure that the SIM card is GSM network and able to execute the function of incoming calls display, no calls can be diverted and the PIN code is locked. The SMS format must be TXT format, and can't recognize the PDU format.

6.3.3 If need to save historical positions or positions when GSM not available, please insert SD card to its slot.

7. Function and Operation

7.1 Turn on device

7.1.1 Connect the positive and negative wire, red and black ones, with 12V or 24V car power system, wait for 1 minute after connecting power to wait tracker works normal, and then turn on the backup battery switch.

7.2 GSM/GPS LED Indicator

7.2.1 Red LED indicator on: No GSM network signals.

7.2.2 Red LED indicator flashes fast (one time each second): GSM Network signal is normally, and tracker works under GSM mode.

7.2.3 Red LED indicator flashes slowly (one time each three seconds): Tracker works under GPRS mode.

7.2.4 Green LED flashes slowly: GPS signal is normal.

7.2.5 Green LED indicator off: No GPS signals.

7.2.6 The red and green indicator flashes three times alternately: it means tracker has been detected the SD card.

7.3 Alarming LED indicator

7.3.1 Non-armed state: LED blinks once, stop for 3 seconds.....

7.3.2 Armed state: LED blinks 2 times, stop for 1 second.....

7.3.3 After alarm being triggered: LED light for 2 seconds, stop for 2 seconds.....

7.3.4 Disarming after being triggered: LED light for 3 seconds.

7.3.5 After SOS being triggered: LED blinks 3 times in 5 seconds.

7.4 Initialization

Send SMS “begin+password” to the unit, it will reply “begin OK” and initialize all the settings to default factory settings. (default password: 123456)

For example: Send SMS “begin123456”, it will reply “begin ok”. (No quotation marks “”when sending all the SMS)

7.5 Change Password

7.5.1 Send SMS “ password+old password+space+new password” to the unit to change the password.

For example: send SMS “password123456 888888” to the unit. If succeeded, “Password ok” will reply to your cell phone.

7.5.2 Keep the new password in mind, the machine will not work properly if lost the password.

7.5.3 Note: The new password must be 6 digits of the Arabic numerals, or the device will not recognize.

7.5.4 Please don't type “+” character in all commands, space means press the space keyboard on cell phone.

7.6 Authorization

There are 5 numbers to be allowed to authorize in the tracker at most.

7.6.1 Call and track the tracker device for 10 times from cell phone in success, it will make the cell phone number as the authorized number automatically, and reply “add master ok”.

7.6.2 Authorization: Send SMS “admin+password+space+cell phone number” to set up an authorized number, the other authorized numbers should be set by the first authorized number, if the number is successfully authorized, the unit will reply “admin ok” by SMS.

7.6.3 Delete authorization: Send SMS“ noadmin+password+space+authorized number” to delete the authorized number.

7.6.4 If you want to track the target via tracker device when it enters into another country, you must add the country code before the cell phone number, for example, send SMS“admin123456 008613322221111” to the device. Note: 13322221111 will be set up as the authorized number.

7.7 Modes switch “track”, “monitor”& “call”

7.7.1 The default mode is “track” (track mode).

7.7.2 Send SMS command "monitor+password" to tracker device, it will reply " monitor ok!" and switch to monitor mode, and then call the number in device to monitor the voice.

7.7.3 Send SMS command "call+password" to tracker device, it will reply " call ok!" and switch to call mode, and then call the number in device, it will pick up automatically, press the end call button of dial panel to end the call.

7.7.4 Send SMS command "tracker+password" to tracker device, It will reply "tracker ok" and restore to track mode.

7.8 Single Locating

7.8.1 Any number calls the tracker device, it will reply a SMS including the position of latitude and longitude if authorized number has not been set yet. If authorized number has been set successfully, the device won't reply SMS including the positioning of latitude and longitude when the unauthorized number dials it up.

7.8.2 Dialing the tracker device from the authorized number, it will hang up your calling and respond to a real-time latitude and longitude information as following:



7.9 Auto track continuously

- 7.9.1 Send SMS command “fix030s005n+password” to the tracker device, it will report the Geo-info at 30s intervals for 5 times. (s:second, m:minute, h:hour). This command must be in 3 digits and the maximum value is 255.
- 7.9.2 Unlimited times track: Send SMS "fix030s***n+password" to the device.
- 7.9.3 Cancel: Send SMS “nofix+password” to the tracker device to cancel the “Auto track continuously”.
- Note: the interval must be not less than 20s.
- 7.9.4 When the GPS signal is not good, the latitude and longitude you received is the last position before going into GPS blind areas, if any bias with the location, pay attention to the time stamp in the message.。

7.10 Get location in absolute street address

- 7.10.1 You must set up the APN of your local GSM network for the SIM card in tracker first before using this function, if there is user name and password for GPRS login, Please refer to 7.40 and 7.41 to configure the APN, user name and password for GPRS login.
- 7.10.2 After configure the APN, send “address+password” to device, it will reply SMS including real street/address name. For example: No.8, Nantou Guankou 2nd Rd. Nanshan district, Shenzhen, Guangdong, china.

7.11 Location based service (LBS)

When the tracker device doesn't receive valid GPS signals, tracker will positioning by location based service(LBS), the messages includes the GPS coordinates of the last position in SMS mode, but the LAC in message is the current new position, you can also send command “address+password” to tracker to get the newest absolute address and GPS coordinates as well; tracker will automatically switch to track by location based service in GPRS mode, and actualized on the map of web server with LBS mark. And there may be some inaccuracy with actual location by LBS tracking; the bias depends on GSM reception.

7.12 View photos on cell phone

- 7.12.1 You must set up the APN of your local GSM network for the SIM card in tracker first before using this function, if there is user name and password for GPRS login, Please refer to 7.40 and 7.41 to configure the APN, user name and password for GPRS login.
- 7.12.2 After APN configuration, send “photo+password” to device, it will take photos and send a link SMS to authorized cell phone. Click the link, then photo can be viewed on cell phone via Internet

7.13 Storage

Storage Volume is depends on the capacity of the SD card inserted in the tracker device; it can be copied to computers through card reader.

7.13.1 Auto Storage

When the tracker device lost GSM signals or fall offline from GPRS, tracker will store the tracking position and alerts automatically in the SD card on the basis of the pre-set condition, when GSM signals get back, all the event alerts will be auto-sent to the authorized numbers or monitoring platform (server), but the stored tracking data should be loaded to the monitoring platform via SMS command.

7.13.2 Storage upon Times

Storage upon times: Send SMS: "save030s005n+password" to the tracker unit, it will reply "save ok", and will store the lat, long locations every 30 seconds for 5 times. (S: second, m: minute; h: hour).

7.13.3 Multi-Storage

Send sms:"save030s***n+password" to tracker device, it will reply "save ok".

7.13.4 Storage Clearance

Send SMS: "clear+password" to tracker device, it will reply "clear ok".

7.14 Data Load

7.14.1 Current date Load: Send SMS: "load+ password" to tracker device, it will reply: "load ok" if the device is working well under GPRS mode; if not, it will reply "load fail! Please check gprs" that means device does not work under GPRS mode.

7.14.2 Specified date Load: Send SMS: "load+ password+ space+ year month date" to tracker device, it will reply: "load ok" and load the tracking data to the monitoring platform upon the valid time you choose. For Example: send SMS: "load123456 20110425" to the tracker device, means to load the tracking data of 25th April 2011 to monitoring platform.

7.15 Dialer

7.15.1 Picture of Dialer

0—9 * # Phone button

YES Dial the phone

C Delete the last number

NO Delete exit number / Hang up

Press 0-9,the user can hear the number he dialed, with toot by press other buttons, also the indicator of dialer will blink one time.

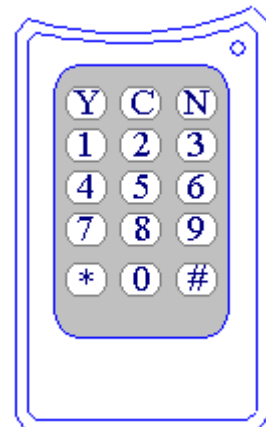

7.15.2 Dialer Learning Code

Close the door and step on foot brave, turn the key from OFF to ON for 3 times, when the turn light is on and enter to learning mode, press button "5",then press button"8",meanwhile the turn light will blink 3 times ,and siren beeps 3 times, dialer learned code successfully.

7.15.3 Dial a Phone

Enter the phone number which needs to dial, press "YES" to call out, press "NO" to hang up the phone.

7.16 Remote Control Button Identification

 Arm/lock
  Disarm/unlock
  Silent
  Deterrence

7.17 Arm

7.17.1 Set up arm by SMS

Send SMS command “arm+password” to the tracker device in the vehicle. It will reply “Tracker is activated” in both armed and disarmed state, and the SMS command will make the tracker device enter into armed state if the unit currently disarmed.

User must stop the engine, (that is ACC is lower voltage). Sending SMS “arm+password” when close the door and left. You will set up arm status fail if the engine is turned on (the ACC is high voltage), it will reply “set up fail! pls turn off ACC”

7.17.2 Set up arm by Remote Control

In disarm states, short-press remote control button , the door of the vehicle will lock, it enter sound and light arm states, siren beeps one time, turn light blink one time, no SMS message.

In arm states, short-press remote control silent button , the door of the vehicle will lock, it enter silent arm states, siren beeps one time, no SMS message. Then once the vehicle is trigger, the siren will not beeps, turn light blink meanwhile it will send SMS alarm message to the authorized cell phone number.

7.18 Disarm

7.18.1 Disarm by SMS



Send SMS command "disarm+password" to the tracker device in the vehicle, It will reply “Tracker is deactivated” in both armed and disarmed state, and the SMS command will make the tracker device enter into disarmed state if the unit currently armed.

It won't alarm if the door is open and sensor is vibrated and the engine is started when deactivated this arm function.

7.18.2 Disarm by Remote Control

Press button , the car enters into disarm state, and the siren will beep two times, no SMS reply.

7.18.3 Alarm Pause

When alarm is triggered, press button //, it will stop alarm and turn off the turn light, but the alarm system still in warning states.

7.19 Find vehicle via remote control

7.19.1 Finding car in Silent Mode: During arm mode, short-press  button 1 time, Siren will keep Silent with turn light flashing 15 seconds, press any button to stop..

7.19.2 Finding Car via Sound/Light: short-press  button 1 time, siren will beep 15 seconds with turn light flashing, press any button to stop.

7.20 sound and light Deterrence

Long-Press  button for 2 seconds, siren will beep 30 seconds continuously with turn light flashing to fright by sound and

Light, press any button to stop.

7.21 Remote Trunk Release

Long-press  button for 2 seconds in disarm mode, vehicle trunk will be open.

7.22 Alerts Function

7.22.1 SOS Emergency Alarm

7.22.1.1 SOS via Remote Control

Long-press  button for 2 seconds when driving; siren will beep 30 seconds continuously with turn light flashing to ask for help, no SMS goes out, press any button to stop it.

7.22.1.2 SOS via SOS Button

Long-press SOS button for 2 seconds, the device will send sms: “help me + lat/long” to every authorized no. without any action from siren or turn light. Alerts will stop after you reply sms: “help me!” to the device by any authorized no.

7.22.2 Geo-fence

Set up a geo-fence for the tracker device to restrict its movements within a district. The unit will send SMS to the authorized numbers when it goes out of this district.

Set up: When the tracker stays immobile in a place for 3-10 minutes, the user can send SMS “stockade+password+space+latitude,longitude;latitude,longitude” to tracker to set the restricted district. In case of breach, it will send SMS “stockade!+latitude/longitude.” to the authorized numbers.

Note: The first latitude & longitude is coordinate of the top left corner of the Geo-fence, while the second latitude & longitude is the coordinate of the bottom right corner, it will alarm SMS in 3 minutes interval.

Cancel: Send SMS “nostockade+password” to deactivate this function.

7.22.3 Movement alarm

Set up: when the tracker stays immobile in a place for 3-10 minutes, the user can send SMS “move+password” to the tracker device. It will reply “move ok!”. In case of such a movement (the default distance is 200 meters), it will send SMS “Move+latitude/longitude to the authorized numbers in 3 minutes interval. Cancel: Send SMS “nomove+password” to deactivate the movement alarm.

7.22.4 Over Speed Alarm

Set up: Send SMS “speed+password+space+080” to the tracker. (Suppose the speed is 80km/h), and it will reply “speed ok!” When the tracker moves exceeding 80km/h, the tracker will send SMS “speed+080!+latitude/longitude” to the authorized numbers in 3 minutes interval.

Cancel: Send SMS “nospeed+password” to deactivate the overspeed alarm.

Remark: The recommended speed should be not less than 30km/h. For below that rate, it will be effected the accuracy by GPS signals drift etc.

7.22.5 Fuel Checking Alerts

During driving process, when the Tracker Device detects the fuel decrease by 20% in 3 minutes, then it will send oil leak or theft alert “oil:XX%+Lat, Long” to authorized number in 3 minutes interval. Siren beeps 30 seconds continuously.

When Acc off and Car stop, the tracker device detects the fuel decrease 2% comparing with pervious fuel when car stop, It will send oil leak or theft alert “oil: XX%+ Lat, Long” to authorized number in 3 minutes interval. Siren beeps 30 seconds continuously with turn light flashing.

Cancel fuel alarm: Send SMS command “nooil+password” to tracker.

7.22.6 Temperature Checking Alerts

The available temperature range is from -050°C to $+125^{\circ}\text{C}$, the number should be 3 digits and temperature unit must be in upper case in SMS command

7.22.6.1 Temperature Alert Setting

Send SMS command “temperature+password+space+***C, ***C” to the tracker, it will reply “temperature ok”. When the temperature is beyond the limited range, the tracker will send SMS alarm to the authorized numbers in 3 minutes interval.

For example: Send SMS “temperature123456 -020C,060C”, when the temperature is below -20°C or above 60°C , the tracker will send SMS alarm to the authorized numbers in 3 minutes interval. With siren beeps 30 seconds with turn light flashing.

7.22.6.2 Temperature alerts canceling;

Send SMS command “notemperature+password” to tracker, it will reply “notemperature OK”

7.22.6.3 Celsius and Fahrenheit Switch

Switch between Celsius and Fahrenheit

The default temperature unit is Celsius, in the sms commend $C = ^{\circ}\text{C}$ $F = ^{\circ}\text{F}$

You can switch from “C” to “F” by sending SMS command “temperature+password+space***F, ***F” to the device, it will reply “temperature ok”.

7.22.7 Low Battery Alert

When the voltage of the tracker device is near 3.6V, it will send SMS “low battery+lat./long information” to the authorized numbers for two times.

7.22.8 Power off alarm

When the external power of tracker be cut off or the voltage is 0V, it will send SMS “power alarm+lat./long.” to the authorized numbers in 3 minutes interval.

7.22.9 Door Open Alarm

When the door open during arm mode, the device will send sms “door alarm +lat/long” to Authorized no. in 3 minutes interval; Siren beeps 30 seconds continuously with turn light flashing. Disarm the device to stop.

7.22.10 Bonnet alerts

When open bonnet during arm mode, the device will send “bonnet alarm+lat/long” to Authorized no. in 3 minutes interval; siren beeps 30 minutes continuously with turn light flashing. Disarm the device to stop.

7.22.11 Footbrake Alerts

When step footbrake during arm mode, device will send “footbrake alarm+lat/long” to authorized no. in 3 minutes interval; siren will beeps 30 seconds continuously with turn light flashing. Disarm the device to stop.

7.22.12 ACC alerts

when the key turn to ACC On position/ any ACC Action /Car Acc on during arm mode, the device will send SMS:”ACC alarm+lat/long” to authorized no in 3 minutes interval; siren beeps 30 seconds with turn light flashing. Disarm the device to stop.

7.22.13 Shock sensor alerts

When shock sensor be trigged during arm mode, device will send sms”sensor alarm+lat/long” to authorized no. in 3 minutes interval; Siren beeps for 5 seconds if shock sensor alarm is triggered one time in 15 seconds and beeps for 30 seconds if it is triggered two times in 15 seconds with turn light flashing at same time, Disarm the device to stop.

7.23 Auto Photograph

When the tracker terminal device detects DOOR/ ACC / SOS / alarm, the tracker device will be automatically ready for photo during sending the alarm and then shoot camera to upload the photo to the monitoring platform (web server).Meanwhile, the device will send link SMS to all authorized cell phone numbers, then photos can be viewed on cell phone . Meanwhile all these photos will be automatically saved in the SD card, and viewed after copied to computers through card reader,

7.24 Alerts Resend

Siren beeps in Non quite mode if DOOR/SHOCK SENSOR/ACC, OIL alarms are triggered during gsm blind areas, and these alarms will be stored and send to authorized numbers or web server after GSM signal recover.

7.25 Car Trigger Memory/informing

When open the door after door alert deactivated, siren beeps one time with 3seconds alarm indicator on that means the vehicle has been triggered.

7.26 Cut off the Oil and Power System

Send SMS command “stop+password” to the tracker device, it will reply “Stop engine Succeed” to your cell phone from the tracker device, and stop your car engine. At the same time, it will remain the immobile state until receiving the next SMS command of resuming the oil and power once receiving SMS command to cut off the oil and power system

(There is risk to stop engine, pls operate it carefully!)

7.27 Resume the Oil and Power System

Send SMS command “resume+password” to the unit, It will reply “Resume engine Succeed” and resume your car engine as well, at the same time. It will remain this state until receiving the next SMS command to cut off the oil and power system once receiving SMS command to resume the oil and gas system.

7.28 Disarm and Arm Recover

Short-Press  button, car door open during disarm mode without sms sending. But if door didn't open in 30 seconds, the anti-theft system will treat it as mistake action and recover to arm mode.

7.29 auto-arming

After stop the car and close the door, within one minute, if no arm action, anti-theft system automatically close the door and enter into silent & arm status

In default mode, auto-arming function is locked. Send SMS “auto arming+password” to activate. And re-send the same command to deactivate



7.30 Arm remind

When car is off, the owner do not arm the vehicle after the door closed for 10 seconds, the system will beep 3 times with turn light flashing to remind the owner to arm the vehicle.

7.31 Door closing remind

Door closed improperly during arm mode, siren beeps 3 times with turn light flashing to remind.

7.32 Automatic Central Locking System

When Vehicle is on (step on footbrake and then turn on ACC), step on the footbrake to lock the door automatically, during driving process, press  Button to lock or press  button to unlock the door.

7.33 Park warming

When ACC is off and door is open, turn light will flash, informing cars behind. Press any button to stop it

7.34 Silent Mode

7.34.1 Set up silent mode by SMS

Send SMS “silent+password” to tracker device, it will reply “silent ok!” .It means tracker device enters into silent mode, no action from siren after alarm is triggered, but tracker will send alarm SMS to authorized numbers with turn light flashing

Quit silent mode Send SMS “loud+password” to tracker device, it will reply “ loud ok!”. It means tracker quit from silent mode, siren will sound after alarm is triggered, and tracker will also send SMS alarm to authorized numbers.

7.34.2 Set up Silent Mode by Remote Controller

Silent mode In disarm status, Short- press  button in remote controller, car door will be locked, and the

system enter into silent alarm mode

No action from siren after alarm is triggered, but tracker will send alarm SMS to authorized numbers with turn light flashing

Quite silent mode In silent mode, Short- press  button, tracker quit from silent mode

7.35 Check the Vehicle State

Send SMS command “check+password” to the tracker device in the vehicle, It will reply the status of external power, battery, GPS reception, GPRS,ACC, door, GSM reception and oil consumption, temperature to the authorized numbers.

For example: Send SMS “check123456” to the tracker device in the vehicle, it will reply following SMS after executed the command.

Power: ON/OFF

Battery: 100%

GPRS: ON/OFF

GPS: OK/NO GPS

ACC: OFF/NO

Door: OFF/NO

GSM Signal: (1-32) the higher digit it shows; the stronger of GSM reception it receives.

Oil: 100.00%

Temperature: +28.0

7.36 Reset by SMS

Send SMS “reset+password” to tracker device to reset the GSM module and GPS module of the tracker device, it will reply “reset ok”.

7.37 Check IMEI

Send SMS command "imei+password" to the unit. E.g. Send SMS command "imei123456" to the tracker device, an IMEI number in 15 digits will reply to your cell phone.

7.38 Terminal (local) Time Setting

7.38.1 Send SMS command “time+space+zone+password+space+time” to the tracker unit, If succeed, It will reply “time OK”.

7.38.2 For example: Send SMS “time zone123456 8”, 8 is Chinese time zone, If your country time zone is minus, send SMS “time zone123456 -8”.

7.39 GPRS Setting

User must send SMS via cell phone to set up APN, IP and port before starting tracking by GPRS.

7.40 Setting up APN

7.40.1 APN is short for Access Point Name and differs from country to country. For more information about your local APN, please inquire with your local GPRS network operator.

7.40.2 Send SMS command “APN+password+Space+your local APN” to tracker via a cell phone and if succeeded, the tracker will reply “APN OK”.

7.40.3 E.g. Send SMS command “APN123456 CMNET”. If succeeded, “APN OK” is returned by the tracker in SMS.

Notes: 123456 refer to password of tracker and CMNET is the APN of one of china GPRS Network Operator (China mobile).

7.41 GPRS User Name and password Setup

7.41.1 In most countries, the user name and password involving GPRS login are not compulsorily necessary, therefore, the entry can be skipped. For those countries requiring user name and password, please configure as following:

7.41.2 Send SMS “up+password+space+user+space+password” If succeeded, “user, password ok!” is returned by the tracker in SMS.

7.41.3 For example, send SMS “up123456 jonnes 666666” to the tracker, and if succeeded, the tracker returns “user, password OK”

Note: 123456 is tracker device password, jonnes is the user name for GPRS login, 666666 is the password for GPRS login.

7.42 IP and Port Setup

7.42.1. Send SMS as below via a cell phone: “adminip+password+Space+IP Address+Space+Port Number”. If succeeded, “adminip ok” is returned by the device in SMS.

7.42.2 E.g. Send SMS command “adminip123456 202.104.150.75 9000” to the tracker device, If succeeded, “adminip ok” is returned by the device in SMS. (123456 is default password, 202.104.150.75 is IP, 9000 is port).

7.43 Modes Switch between “SMS” and “GPRS”

7.43.1 The default mode is “SMS”

7.43.2 Send SMS “GPRS+password” to the unit, and it will reply “GPRS ok!” it means tracker device has switched to “GPRS” mode.

7.43.3 Send SMS “SMS+password” to the unit, it will reply “SMS ok!” and restore to “SMS” mode.

8. Cautions

Please comply with the instructions to extend the unit life:

1. Keep the unit dry. Any liquid, i.e. rain, moisture, may destroy or damage the inside circuitry.
2. Don't use & store the unit in dusty places.
3. Don't put the unit in overheated or overcooled places.
4. Handle carefully. Don't vibrate or shake it violently.
5. Clear the unit with a piece of dry cloth. Don't clean in chemicals, detergent.
6. Don't paint the unit, this may cause some foreign materials left in between the parts.
7. Don't disassemble or refit the unit.
8. Please read the user manual carefully before installation and operation, learn something more about the voltage range. Otherwise, it won't work properly or destroy the product.

Web platform and PC installation tracking software included in the CD for detailed operation information.

9. Faults & the Solutions

Faults	Solution
Startup Fail	Please check out the power wiring in correct place.
Call Fail	Check the GSM antenna connected. Check whether the SIM card in place. Check whether the normal power supply voltage.
Hang up Fail	In existence of an authorized number, an unauthorized number dials up the unit. Please initialize the unit and re-set up the authorized numbers.
Monitor Fail	Check if the authorized number is setup
Temperature detection fail	Do install the temperature sensor first, then connect external battery and turn on the device, or tracker can't recognize
Fuel detection fail	Do install the fuel sensor first, then connect external battery and turn on the device, or tracker can't recognize
Dial panel fail	Remove external power ,turn off the device and check the dial panel's battery available or not
central lock fail	Check if the external cable is connected well according to Wiring diagram
Commands Fail	Reset the device