



User Manual
netTAP NT 100
Gateway Devices



Hilscher Gesellschaft für Systemautomation mbH

www.hilscher.com

DOC081001UM18EN | Revision 18 | English | 2015-01 | Released | Public

Table of Contents

1	INTRODUCTION.....	6
1.1	About the User Manual.....	6
1.1.1	Obligation to read and understand the Manual.....	6
1.1.2	List of Revisions.....	7
1.1.3	Conventions in this Manual.....	8
1.2	Reference to Hardware, Software, Driver and Firmware.....	9
1.3	Contents of the Product DVD.....	10
1.3.1	Directory Structure of the DVD.....	10
1.3.2	Device Description Files.....	11
1.3.3	Documentation for netTAP.....	12
1.4	Legal Notes.....	15
1.4.1	Copyright.....	15
1.4.2	Important Notes.....	15
1.4.3	Exclusion of Liability.....	16
1.4.4	Warranty.....	16
1.4.5	Export Regulations.....	17
1.4.6	Registered Trademarks.....	17
2	SAFETY.....	18
2.1	General Note.....	18
2.2	Intended Use.....	18
2.3	Personnel Qualification.....	18
2.4	References Safety.....	18
2.5	Safety Instructions to avoid Personal Injury.....	19
2.5.1	Danger of unsafe System Operation.....	19
2.6	Safety Instructions to avoid Property Damage.....	19
2.6.1	Device Destruction by exceeding allowed Supply Voltage.....	19
2.6.2	Danger of unsafe System Operation.....	19
2.7	Labeling of Safety Messages.....	20
3	DESCRIPTION AND REQUIREMENTS.....	21
3.1	Device Description.....	21
3.2	Device Versions and Usage Scenarios.....	22
3.2.1	Device Names.....	22
3.3	Protocol Conversions.....	24
3.3.1	Protocol Conversion 1: Ethernet to Ethernet.....	24
3.3.2	Protocol Conversion 2 - Ethernet to Fieldbus.....	25
3.3.3	Protocol Conversion 3 - Ethernet to Serial.....	27
3.3.4	Protocol Conversion 4 - Fieldbus to Fieldbus.....	28
3.3.5	Protocol Conversion 5 - Fieldbus to Serial.....	29
3.4	System Requirements.....	30

3.5	Configuration Requirements	30
3.6	Licenses.....	31
4	DEVICE DRAWINGS AND CONNECTIONS	32
4.1	Dimensioned Drawing.....	32
4.2	Device Label	32
4.3	LEDs and Control Elements	33
4.3.1	LEDs and Control Elements of the upper half of the Device.....	33
4.3.2	LEDs of the lower half of the Device	34
4.4	Device Drawings of the left Part (with Connector X2).....	35
4.5	Device Drawings of the right Part (with Connector X3)	36
4.6	Connections.....	37
4.6.1	X1 Power Supply.....	37
4.6.2	X2/X3 Front Connection	37
4.6.3	Diagnostic Interface (Mini-B USB).....	41
4.7	Schematic Diagram - Galvanic Isolation.....	42
4.7.1	Isolation in Case of NT 100-RE-EN Devices.....	42
4.7.2	Isolation in Case of NT 100-RE-XX Devices.....	43
4.7.3	Isolation in Case of NT 100-DP-XX/CO-XX/DN-XX Devices	45
5	NT 100 MOUNTING AND DISMOUNTING	47
5.1	Mounting Instructions.....	47
5.2	DIN Top Hat Rail Mounting of the NT 100	47
5.3	Removing the NT 100 from the DIN Top Hat Rail	48
6	INSTALLING DRIVER	49
7	COMMISSIONING	50
7.1	Load Firmware and Configuration	50
7.1.1	Download Configuration Files from the PC	50
7.1.2	Transfer Configuration from Memory Card	51
7.2	Start-up Behavior.....	52
7.2.1	Start-up without Memory Card	52
7.2.2	Start-up with Memory Card	52
7.2.3	Reset Device to Factory Settings with Memory Card.....	53
7.2.4	Boot up Behaviour on invalid Firmware.....	54
8	TROUBLESHOOTING	63
8.1	Failure in 10 MBit/s Half Duplex Mode and Workaround	64
9	LED	65
9.1	SYS LED.....	65
9.2	APL LED	66
9.3	LED Real Time Ethernet Systems	67
9.3.1	LED EtherCAT Master.....	67

9.3.2	LED EtherCAT Slave.....	68
9.3.3	LED EtherNet/IP Scanner (Master).....	70
9.3.4	LED EtherNet/IP Adapter (Slave).....	71
9.3.5	LED Open Modbus/TCP.....	73
9.3.6	LED POWERLINK Controlled Node/Slave.....	75
9.3.7	LED PROFINET IO RT Controller.....	77
9.3.8	LED PROFINET IO-RT-Device.....	78
9.3.9	LED sercos Master.....	79
9.3.10	LED sercos Slave.....	81
9.4	LED Fieldbus Systems.....	82
9.4.1	LED CANopen Master.....	82
9.4.2	LED CANopen Slave.....	83
9.4.3	LED CC-Link Slave.....	84
9.4.4	LED DeviceNet Master.....	85
9.4.5	LED DeviceNet Slave.....	85
9.4.6	LED PROFIBUS DP Master.....	86
9.4.7	LED PROFIBUS DP Slave.....	86
9.5	LEDs Serial.....	87
9.5.1	LED Modbus RTU.....	87
9.5.2	LED ASCII.....	87
9.5.3	LED Serial with netSCRIPT.....	88
9.5.4	LED 3964R.....	89
10	TECHNICAL DATA.....	90
10.1	Technical Data netTAP NT 100 Gateway.....	90
10.2	Technical Data of Real-Time Ethernet Communication Protocols.....	93
10.2.1	EtherCAT Master.....	93
10.2.2	EtherCAT Slave.....	93
10.2.3	EtherNet/IP Scanner (Master).....	94
10.2.4	EtherNet/IP Adapter (Slave).....	95
10.2.5	Open Modbus/TCP.....	96
10.2.6	POWERLINK Controlled Node (Slave).....	96
10.2.7	PROFINET IO-RT-Controller.....	97
10.2.8	PROFINET IO-RT-Device.....	98
10.2.9	Sercos Master.....	99
10.2.10	Sercos Slave.....	100
10.3	Technical Data Fieldbus Protocols.....	101
10.3.1	CANopen Master.....	101
10.3.2	CANopen Slave.....	102
10.3.3	CC-Link Slave.....	103
10.3.4	DeviceNet Master.....	104
10.3.5	DeviceNet Slave.....	105
10.3.6	PROFIBUS DP Master.....	106
10.3.7	PROFIBUS DP Slave.....	107
10.4	Technical Data Serial Protocols.....	108
10.4.1	ASCII.....	108
10.4.2	Modbus RTU Master/Slave.....	109
10.4.3	netSCRIPT (Serial).....	110

10.4.4	3964R.....	111
11	WIRING INSTRUCTIONS	112
11.1	Assembly of D-Sub Connectors.....	113
11.2	Ethernet	114
11.3	PROFIBUS	115
11.4	CANopen	117
11.5	DeviceNet	118
11.6	CC-Link.....	120
11.7	RS-232.....	123
11.8	RS-422.....	124
11.9	RS-485.....	126
12	DECOMMISSIONING/DISPOSAL.....	128
12.1	Put the Device out of Operation.....	128
12.2	Disposal of Waste Electronic Equipment.....	128
13	GLOSSARY.....	129
14	APPENDIX	131
14.1	List of Figures	131
14.2	List of Tables	132
14.3	Contacts.....	135

1 Introduction

1.1 About the User Manual

This user manual describes the hardware, installation, commissioning, and operation of the netTAP NT 100 series of gateways.

1.1.1 Obligation to read and understand the Manual



Important!

- To avoid personal injury and to avoid property damage to your system or to your device, you must read and understand all instructions in the manual and all accompanying texts to your device, before installing and operating your device.
 - First read the **Safety Instructions** in the safety chapter.
 - Obey to all **Safety Messages** in the manual.
 - Keep the product DVD providing the product manuals.
-

1.1.2 List of Revisions

Index	Date	Chapter	Revisions
12	2012-08-06	1.2 3.6 3.3 4.3.1	Firmware-Version 1.5.x.x Section <i>Reference to Hardware, Software, Driver and Firmware</i> updated Section <i>Licenses</i> : Note added, that the bas firmware is not sufficient to read out if the device has a master license. Section <i>Protocol Conversions</i> firmware versions updated. Section <i>LEDs and Control Elements of the upper half of the Device</i> address switch added.
13	2012-11-07	9.4.7 9.4.2 10.2.3 10.2.10 10.3.2 10.3.3 10.3.5 10.3.6 10.3.7	Section <i>LED PROFIBUS DP Slave</i> updated. Section <i>LED CANopen Slave</i> : State for baurate detection added. Section <i>EtherNet/IP Scanner (Master)</i> : - Maximum number of total cyclic input data of 5760 reduced to 5712 bytes, - Device Level Ring as Beacon based ‚Ring Node‘ supported, - Address Conflict Detection supported. Section <i>Sercos Slave</i> : - Maximum number of cyclic input data and output data reduced from 200 to 128 bytes each, - NRT channel supported: only forwarding and S/IP. Section <i>CANopen Slave</i> : - Event timer added, - Address switch added, - Auto baudrate detection added. Section <i>CC-Link Slave</i> : Address switch added Section <i>DeviceNet Slave</i> : Address switch added Section <i>PROFIBUS DP Master</i> : - Maximum number of total cyclic input data extended from 3584 to 5712 bytes, - Maximum number of total cyclic output data extended from 3584 to 5760 bytes. Section <i>PROFIBUS DP Slave</i> : - Maximum number of modules: Max. 4 input modules and max. 4 output modules, max. 24 modules when using manual setting - Address switch added
14	2013-02-04	1.3.3	Section <i>Documentation for netTAP</i> updated.
15	2013-06-26	6	Installation program of USB driver added.
16	2014-03-11	1.3.1	Section <i>Directory Structure of the DVD</i> updated.
17	2014-03-24	1.2 3.3.1 7.1 7.1.2.1 10.1 10.2.5 11.4	Section <i>Reference to Hardware, Software, Driver and Firmware</i> updated. Protocol conversion ‚PROFINET IO Device / EtherNet/IP Scanner‘ added. Section updated: Beside MMC cards any SD card can be used now. Section <i>Prerequisite for Memory Cards</i> added. Technical data about memory cards expanded. Section <i>Open Modbus/TCP</i> : Information added: ‚Maximum number of connections is 16‘. Maximum cable length for 1 MBit/s is 30 m.
18	2015-01-26	1.3.2 1.3.3	CC-Link Device Description Files updated. Section <i>Documentation for netTAP</i> : ASCII and 3964R document names updated.

Table 1: List of Revisions

1.1.3 Conventions in this Manual

Operation instructions, a result of an operation step or notes are marked as follows:

Operation Instructions:

➤ <instruction>

or

1. <instruction>

2. <instruction>

Results:

⇒ <result>

Notes:



Important: <important note>



Note: <note>



<note, where to find further information>

Positions in Figures

The *Positions* ①, ②, ③ ... or ①, ②, ③ ... or ①, ②, ③ ... refer to the figure used in that section. If the numbers reference to a section outside the current section then a cross reference to that section and figure is indicated.

1.2 Reference to Hardware, Software, Driver and Firmware

Hardware

Device Type	Part number	Revision	Port X2	Port X3
NT 100-RE-EN	1712.110	Revision 2	Ethernet	Ethernet
NT 100-RE-CC	1712.140	Revision 2	Ethernet	CC-Link
NT 100-RE-CO	1712.160	Revision 4	Ethernet	CANopen
NT 100-RE-DP	1712.180	Revision 4	Ethernet	PROFIBUS DP
NT 100-RE-DN	1712.170	Revision 4	Ethernet	DeviceNet
NT 100-RE-RS	1712.100	Revision 4	Ethernet	Serial
NT 100-DP-CC	1718.140	Revision 4	PROFIBUS DP	CC-Link
NT 100-DP-CO	1718.160	Revision 4	PROFIBUS DP	CANopen
NT 100-DP-DN	1718.170	Revision 4	PROFIBUS DP	DeviceNet
NT 100-DP-DP	1718.180	Revision 4	PROFIBUS DP	PROFIBUS DP
NT 100-DP-RS	1718.100	Revision 4	PROFIBUS DP	Serial
NT 100-CO-CC	1716.140	Revision 4	CANopen	CC-Link
NT 100-CO-CO	1716.160	Revision 3	CANopen	CANopen
NT 100-CO-DP	1716.180	Revision 1	CANopen	PROFIBUS DP
NT 100-CO-DN	1716.170	Revision 3	CANopen	DeviceNet
NT 100-CO-RS	1716.100	Revision 3	CANopen	Serial
NT 100-DN-CC	1717.140	Revision 4	DeviceNet	CC-Link
NT 100-DN-CO	1717.160	Revision 3	DeviceNet	CANopen
NT 100-DN-DP	1717.180	Revision 4	DeviceNet	PROFIBUS DP
NT 100-DN-DN	1717.170	Revision 3	DeviceNet	DeviceNet
NT 100-DN-RS	1717.100	Revision 4	DeviceNet	Serial

Table 2: Reference to Hardware

Software

Software	Software Version
SYCONnet netX setup.exe	1.351.x.x and higher

Table 3: Reference to Software

Driver

Driver	Software Version
USB Driver	USB Driver of Windows®

Table 4: Reference to Driver

Firmware

Firmware for the protocol conversions: see section *Protocol Conversions* on page 24.

1.3 Contents of the Product DVD

The product DVD for the netTAP NT 100 contains:

- Setup program for the configuration and diagnostic program SYCON.net
- USB Driver
- Documentation
- Firmware
- Device Description Files (EDS, GSD, GSDML, ...)
- Video-Audio Tutorials
- Presentation about netSCRIPT
- Tools

1.3.1 Directory Structure of the DVD

All manuals on this DVD are delivered in the Adobe Acrobat® Reader format (PDF).

Directory Name	Description
Documentation	Documentation in the Acrobat® Reader Format (PDF)
Electronic Data Sheets (e.g. EDS, GSD, GSDML)	Device Description File
Firmware	Loadable Firmware
fscommand	Files used during installation
Setups & Drivers	Configuration and diagnostic program SYCON.net USB Driver for netTAP NT 100 and netBRICK NB 100 Debugger software for netSCRIPT Lua for Windows
Supplements & Examples	Tool for recovery of netTAP 100 devices respectively netBRICK NB 100 devices Examples for SYCON.net Examples for netSCRIPT Links to websites about Modbus
Training & Podcasts	Videos about commissioning

Table 5: Directory Structure of the Gateway Solutions DVD

1.3.2 Device Description Files

The directory EDS on the DVD provides device description files for the netTAP NT 100 device.

netTAP NT 100 as	File name
CANopen Slave	NT100_CO_COS.EDS
CC-Link Slave	nt100-cc-ccs_1.csp (for one Remote Device Station), nt100-cc-ccs_2.csp (for two Remote Device Stations), nt100-cc-ccs_3.csp (for three Remote Device Stations), nt100-cc-ccs_4.csp (for four Remote Device Stations), nt100-cc-ccs_io_1.csp (for one Remote IO Station)
DeviceNet Slave	NT100_DN_DNS.EDS
EtherCAT Slave	Hilscher NT 100-ECS-XX V2.2.xml
EtherNet/IP Adapter	HILSCHER NT 100-RE EIS V1.1.EDS
POWERLINK Slave	00000044_NT100PLS-64O_64I.xdd 00000044_NT100PLS-512O_512I.xdd
PROFIBUS DP Slave	HIL_0C0E.GSD
PROFINET IO Device	GSDML-V2.2-HILSCHER-NT 100-RE PNS-20120806-143000.xml
sercos Slave	Hilscher NT100 RE S3S FixCFG FSPIO Default.xml only for default settings. Note: Use the SDDML export function in SYCON.net to create a suitable SDDML file.

Table 6: Device description files for netTAP NT 100 on the DVD

The device description files are for the configuration of the used master.

1.3.3 Documentation for netTAP

The following documentation overview gives information, for which items you can find further information in which manual.



Note: Further information: All manuals listed in the overview below can be found in the Documentation directory on the DVD delivered, in the Adobe Acrobat® Reader format (PDF).

Basic documentation for netTAP NT 100

You always need the following documents:

Manual	Contents	Document name
User Manual	netTAP NT 100 Installation, Operation and Hardware	netTAP NT 100 - Gateway Devices UM xx EN.pdf (this manual)
User Manual	Software Installation Gateway Solutions	Software Installation - Gateway Solutions UM xx EN.pdf
Operating Instruction Manual	Configuration of Gateway and Proxy Devices netTAP, netBRICK and netLINK Step by step description of the configuration of the netTAP NT 100. Configuration of the netTAP NT 100 as EtherCAT Slave, EtherNet/IP Adapter, Open Modbus/TCP, POWERLINK controlled Node, PROFINET IO Device, sercos Slave CANopen Slave, CC-Link Slave, DeviceNet Slave, PROFIBUS DP Slave, 3964R, ASCII, Modbus RTU Master or Slave respectively netSCRIPT.	Configuration of Gateway and Proxy Devices OI xx EN.pdf

Table 7: Basic Documentation for netTAP NT 100

netTAP NT 100 with EtherCAT Master

You need the following additional documents, if you use the protocol EtherCAT Master on the gateway device:

Manual	Contents	Document name
Operating Instruction Manual	DTM for EtherCAT Master devices	EtherCAT Master DTM OI xx EN.pdf
Operating Instruction Manual	Generic DTM for EtherCAT Slave devices	EtherCAT Generic Slave DTM OI xx EN.pdf

Table 8: Additional Documentation for netTAP NT 100 with EtherCAT Master

netTAP NT 100 with EtherNet/IP Scanner/Master

You need the following additional documents, if you use the protocol EtherNet/IP Scanner/Master on the gateway device:

Manual	Contents	Document name
Operating Instruction Manual	DTM for EtherNet/IP Scanner devices	EtherNetIP Scanner DTM OI xx EN.pdf
Operating Instruction Manual	Generic DTM from EDS File EtherNet/IP Adapter Devices	EtherNetIP Generic Adapter DTM EDS OI xx EN.pdf
Operating Instruction Manual	Generic DTM for EtherNet/IP Adapter devices	EtherNetIP Generic Adapter DTM OI xx EN.pdf

Table 9: Additional Documentation for netTAP NT 100 with EtherNet/IP Scanner/Master

netTAP NT 100 with PROFINET IO Controller

You need the following additional documents, if you use the protocol PROFINET IO Controller on the gateway device:

Manual	Contents	Document name
Operating Instruction Manual	DTM for PROFINET IO Controller devices	PROFINET IO Controller DTM OI xx EN.pdf
Operating Instruction Manual	Generic DTM for PROFINET IO Device devices	PROFINET IO Generic Device DTM IO xx EN.pdf

Table 10: Additional Documentation for netTAP NT 100 with PROFINET IO Controller

netTAP NT 100 with sercos Master

You need the following additional documents, if you use the protocol sercos Master on the gateway device:

Manual	Contents	Document name
Operating Instruction Manual	DTM for sercos Master devices	sercos Master DTM OI xx EN.pdf
Operating Instruction Manual	Generic DTM for sercos Slave devices	sercos Generic Slave DTM OI xx EN.pdf

Table 11: Additional Documentation for netTAP NT 100 with sercos Master

netTAP NT 100 with CANopen Master

You need the following additional documents, if you use the protocol CANopen Master on the gateway device:

Manual	Contents	Document name
Operating Instruction Manual	DTM for CANopen Master devices	CANopen Master DTM OI xx EN.pdf
Operating Instruction Manual	Generic DTM for CANopen Slave devices	CANopen Generic Slave DTM OI xx EN.pdf

Table 12: Additional Documentation for netTAP NT 100 with CANopen Master

netTAP NT 100 with DeviceNet Master

You need the following additional documents, if you use the protocol DeviceNet Master on the gateway device:

Manual	Contents	Document name
Operating Instruction Manual	DTM for DeviceNet Master devices	DeviceNet Master DTM OI xx EN.pdf
Operating Instruction Manual	Generic DTM for DeviceNet Slave devices	DeviceNet Generic Slave DTM OI xx EN.pdf

Table 13: Additional Documentation for netTAP NT 100 with DeviceNet Master

netTAP NT 100 with PROFIBUS DP Master

You need the following additional documents, if you use the protocol PROFIBUS DP Master on the gateway device:

Manual	Contents	Document name
Operating Instruction Manual	DTM for PROFIBUS DP Master devices	PROFIBUS DP Master DTM OI xx EN.pdf
Operating Instruction Manual	Generic DTM for PROFIBUS DP Slave devices	PROFIBUS DP Generic Slave DTM OI xx EN.pdf

Table 14: Additional Documentation for netTAP NT 100 with PROFIBUS DP Master

netTAP NT 100 with netSCRIPT

You need the following additional documents, if you use the protocol netSCRIPT on the gateway device:

Manual	Contents	Document name
User Manual	netSCRIPT Programming Language for serial communication	netSCRIPT Programming Language for Serial Communication UM xx EN.pdf

Table 15: Additional Documentation for netTAP NT 100 with netSCRIPT

netTAP NT 100 with ASCII

You need the following additional documents, if you use the protocol ASCII on the gateway device:

Manual	Contents	Document name
Application Note	ASCII Data Flow Control	ASCII Data Flow Control AN xx EN.pdf

Table 16: Additional Documentation for netTAP NT 100 with ASCII

netTAP NT 100 with 3964R

You need the following additional documents, if you use the protocol 3964R on the gateway device:

Manual	Contents	Document name
Application Note	3964R Data Flow Control	3964R Data Flow Control AN xx EN.pdf

Table 17: Additional Documentation for netTAP NT 100 with 3964R

1.4 Legal Notes

1.4.1 Copyright

© Hilscher, 2008-2015, Hilscher Gesellschaft für Systemautomation mbH

All rights reserved.

The images, photographs and texts in the accompanying material (user manual, accompanying texts, documentation, etc.) are protected by German and international copyright law as well as international trade and protection provisions. You are not authorized to duplicate these in whole or in part using technical or mechanical methods (printing, photocopying or other methods), to manipulate or transfer using electronic systems without prior written consent. You are not permitted to make changes to copyright notices, markings, trademarks or ownership declarations. The included diagrams do not take the patent situation into account. The company names and product descriptions included in this document may be trademarks or brands of the respective owners and may be trademarked or patented. Any form of further use requires the explicit consent of the respective rights owner.

1.4.2 Important Notes

The user manual, accompanying texts and the documentation were created for the use of the products by qualified experts, however, errors cannot be ruled out. For this reason, no guarantee can be made and neither juristic responsibility for erroneous information nor any liability can be assumed. Descriptions, accompanying texts and documentation included in the user manual do not present a guarantee nor any information about proper use as stipulated in the contract or a warranted feature. It cannot be ruled out that the user manual, the accompanying texts and the documentation do not correspond exactly to the described features, standards or other data of the delivered product. No warranty or guarantee regarding the correctness or accuracy of the information is assumed.

We reserve the right to change our products and their specification as well as related user manuals, accompanying texts and documentation at all times and without advance notice, without obligation to report the change. Changes will be included in future manuals and do not constitute any obligations. There is no entitlement to revisions of delivered documents. The manual delivered with the product applies.

Hilscher Gesellschaft für Systemautomation mbH is not liable under any circumstances for direct, indirect, incidental or follow-on damage or loss of earnings resulting from the use of the information contained in this publication.

1.4.3 Exclusion of Liability

The software was produced and tested with utmost care by Hilscher Gesellschaft für Systemautomation mbH and is made available as is. No warranty can be assumed for the performance and flawlessness of the software for all usage conditions and cases and for the results produced when utilized by the user. Liability for any damages that may result from the use of the hardware or software or related documents, is limited to cases of intent or grossly negligent violation of significant contractual obligations. Indemnity claims for the violation of significant contractual obligations are limited to damages that are foreseeable and typical for this type of contract.

It is strictly prohibited to use the software in the following areas:

- for military purposes or in weapon systems;
- for the design, construction, maintenance or operation of nuclear facilities;
- in air traffic control systems, air traffic or air traffic communication systems;
- in life support systems;
- in systems in which failures in the software could lead to personal injury or injuries leading to death.

We inform you that the software was not developed for use in dangerous environments requiring fail-proof control mechanisms. Use of the software in such an environment occurs at your own risk. No liability is assumed for damages or losses due to unauthorized use.

1.4.4 Warranty

Although the hardware and software was developed with utmost care and tested intensively, Hilscher Gesellschaft für Systemautomation mbH does not guarantee its suitability for any purpose not confirmed in writing. It cannot be guaranteed that the hardware and software will meet your requirements, that the use of the software operates without interruption and that the software is free of errors. No guarantee is made regarding infringements, violations of patents, rights of ownership or the freedom from interference by third parties. No additional guarantees or assurances are made regarding marketability, freedom of defect of title, integration or usability for certain purposes unless they are required in accordance with the law and cannot be limited. Warranty claims are limited to the right to claim rectification.

1.4.5 Export Regulations

The delivered product (including the technical data) is subject to export or import laws as well as the associated regulations of different countries, in particular those of Germany and the USA. The software may not be exported to countries where this is prohibited by the United States Export Administration Act and its additional provisions. You are obligated to comply with the regulations at your personal responsibility. We wish to inform you that you may require permission from state authorities to export, re-export or import the product.

1.4.6 Registered Trademarks

Windows® XP, Windows® Vista and Windows® 7 are registered trademarks of Microsoft Corporation.

Adobe-Acrobat® is a registered trademark of the Adobe Systems Incorporated.

CANopen® is a registered trademark of CAN in AUTOMATION - International Users and Manufacturers Group e.V (CiA), Nürnberg.

CC-Link® is a registered trademark of Mitsubishi Electric Corporation, Tokyo, Japan.

DeviceNet® and EtherNet/IP® are trademarks of ODVA (Open DeviceNet Vendor Association, Inc).

EtherCAT® is a registered trademark and a patented technology of Beckhoff Automation GmbH, Verl, Bundesrepublik Deutschland, formerly Elektro Beckhoff GmbH.

Modbus® is a registered trademark of Schneider Electric.

Powerlink is a registered trademark of B&R, Bernecker + Rainer Industrie-Elektronik Ges.m.b.H, Eggelsberg, Austria

PROFIBUS and PROFINET are registered trademarks of PROFIBUS International, Karlsruhe.

sercos interface® is a registered trademark of sercos International e. V., Suessen, Germany.

All other mentioned trademarks are property of their respective legal owners.

2 Safety

2.1 General Note

The user manual, the accompanying texts and the documentation are written for the use of the products by educated personnel. When using the products, all safety instructions and all valid legal regulations have to be obeyed. Technical knowledge is presumed. The user has to assure that all legal regulations are obeyed.

2.2 Intended Use

Devices described in this manual are devices for communication and connect two communication networks. The NT 100 devices work as a gateway between these two networks.

netTAP 100 Devices			
NT 100-RE-CC	NT 100-DP-CC	NT 100-CO-CC	NT 100-DN-CC
NT 100-RE-CO	NT 100-DP-CO	NT 100-CO-CO	NT 100-DN-CO
NT 100-RE-DP	NT 100-DP-DN	NT 100-CO-DP	NT 100-DN-DP
NT 100-RE-DN	NT 100-DP-DP	NT 100-CO-DN	NT 100-DN-DN
NT 100-RE-RS	NT 100-DP-RS	NT 100-CO-RS	NT 100-DN-RS
NT 100-RE-EN	-	-	-

The NT 100 devices are in a compact housing and suitable for DIN rail mounting according to DIN EN 60715.

2.3 Personnel Qualification

The netTAP NT 100 Gateway must only be installed, configured and removed by qualified personnel. Job-specific technical skills for people professionally working with electricity must be present concerning the following topics:

- Safety and health at work
- Mounting and attaching of electrical equipment
- Measurement and Analysis of electrical functions and systems
- Evaluation of the safety of electrical systems and equipment
- Installing and Configuring IT

2.4 References Safety

- [1] ANSI Z535.6-2006 American National Standard for Product Safety Information in Product Manuals, Instructions, and Other Collateral Materials
- [2] IEC 60950-1, Information technology equipment - Safety - Part 1: General requirements, (IEC 60950-1:2005, modified); German Edition EN 60950-1:2006
- [3] EN 61340-5-1 and EN 61340-5-2 as well as IEC 61340-5-1 and IEC 61340-5-2

2.5 Safety Instructions to avoid Personal Injury

To ensure your own personal safety and to avoid personal injury, you necessarily must read, understand and follow the following safety instructions and all safety messages in this manual about danger causing personal injury, before you install and operate your netTAP NT 100 device.

2.5.1 Danger of unsafe System Operation

To prevent harm of persons, do not remove this device under runtime conditions before you can not guarantee further a safe and secure operation of the plant.

2.6 Safety Instructions to avoid Property Damage

To avoid property damage respectively device destruction of the netTAP NT 100 device, you necessarily must read, understand and follow the following safety instructions and all safety messages in this manual about danger causing property damage, before you install and operate your netTAP NT 100 device.

2.6.1 Device Destruction by exceeding allowed Supply Voltage

Adhere for all netTAP NT 100 device described in this manual the instruction hereafter:

The netTAP NT 100 may only be operated with the specified supply voltage. Make sure that the limits of the allowed range for the supply voltage are not exceeded. A supply voltage above the upper limit can cause severe damage to the netTAP NT 100! A supply voltage below the lower limit can cause malfunction in the netTAP NT 100. The allowed range for the supply voltage is defined by the tolerances specified in this manual.



The data on the mandatory supply voltage for the netTAP NT 100 device you find in the section *System Requirements* on page 30. There the required and permitted supply voltage for the netTAP NT 100 device is provided inclusively the permitted tolerance range.

2.6.2 Danger of unsafe System Operation

To prevent property damage, do not remove this device under runtime conditions before you can not guarantee further a safe and secure operation of the plant.

2.7 Labeling of Safety Messages

- The **Section Safety Messages** at the beginning of a chapter are pin-pointed particularly. They are highlighted with a specific safety symbol and a signal word according to the degree of endangerment. Inside the safety message the danger is exactly named.
- The **Integrated Safety Messages** within a instruction description are highlighted with a signal word according to the degree of endangerment and possibly by an principle symbol. Inside the safety message the danger is exactly named.



Safety Symbol	Safety Symbol (USA)	Sort of Warning or Principle
		Warning of Personal Injury and Property Damage Message USA: Warning of Personal Injury As in the scope of the ANSI Z535 Standard (for USA) instructions to a property damage message may not contain a warning triangle, this property damage messages are listed separately for the USA.
		Warning of Damages by Electrostatic Discharge

Table 18: Safety Symbols and Sort of Warning or Principle

Signal Word	Meaning	Meaning (USA)
NOTICE	Indicates a Property Damage Message.	Indicates a Property Damage Message.
Note	Indicates an important note in the manual.	Indicates an Important Note in the Manual.

Table 19: Signal Words

In this document all Safety Instructions and Safety Messages are designed according both to the international used safety conventions as well as to the ANSI Z535 standard, refer to reference safety [S1].

3 Description and Requirements

3.1 Device Description

The netTAP NT100 devices described in this manual are communication devices that are connecting two networks to each other. The NT 100 devices are operating as gateway between both networks.

The netTAP 100 is a device with two interface ports. Its principle functionality is illustrated in the figure below. The function of the device is determined by the loaded firmware and the loaded configuration.

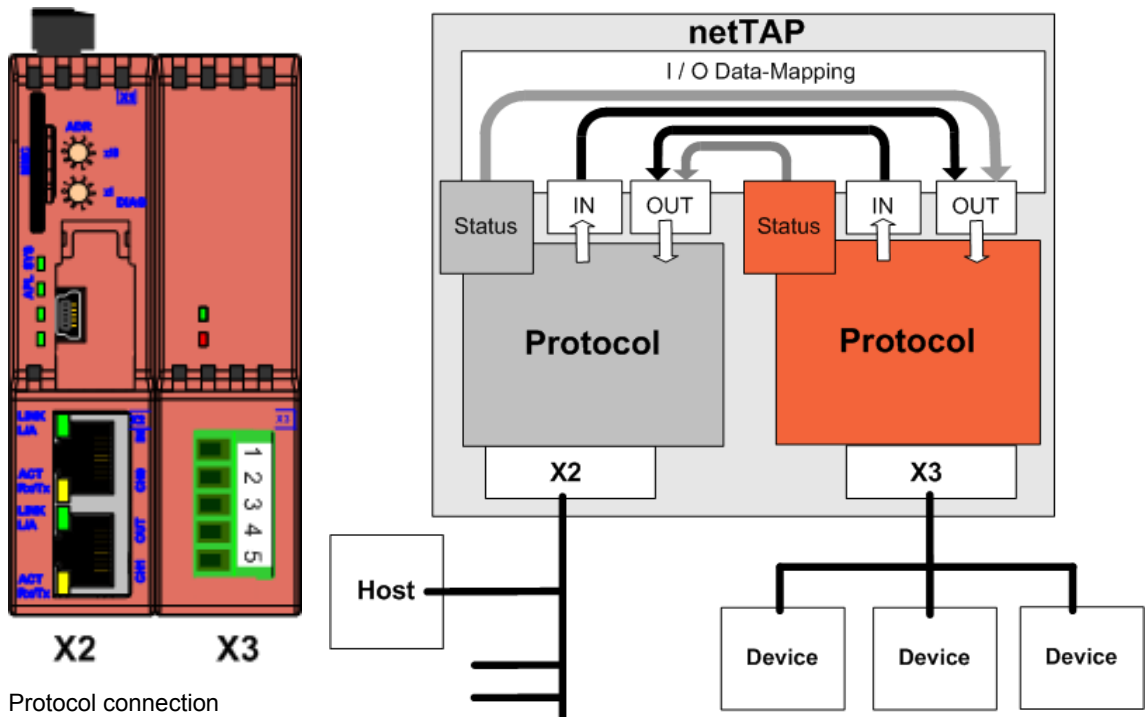

Protocol connection

The connection technology depends on the protocol

Block diagram

Figure 1: Function NT 100

The interface X2 may be Ethernet or a fieldbus interface, the interface X3 may be fieldbus, Ethernet or a serial interface. X2 and X3 is located at the front of the device.

Basically it is possible to connect either to port X2 or X3 to a host or to field devices.

The device is configured via the USB interface (under the cover) by a PC and the software SYCON.net. Online diagnosis is possible via the same interface.

The gateway functionality is determined by the loadable firmware. The operation of the configuration tool SYCON.net is described in the documentation *Configuration of Gateway and Proxy Devices* and located in the documents folder of the DVD included in the delivery.

The firmware buffers the cyclic send and receive data of the protocol at port X2 and the protocol of port X3 internally. The configuration tool enables the flexible mapping of the receive data of protocol X2 to send data of the protocol X3 and vice versa.

Status information of the protocol at port X2 can be mapped into the send data of the protocol at port X3 and vice versa.

The firmware of netTAP NT100 as gateway does not support acyclic communications or services of the supported protocols.

3.2 Device Versions and Usage Scenarios

3.2.1 Device Names

The following figure shows a NT 100-RE-DP.

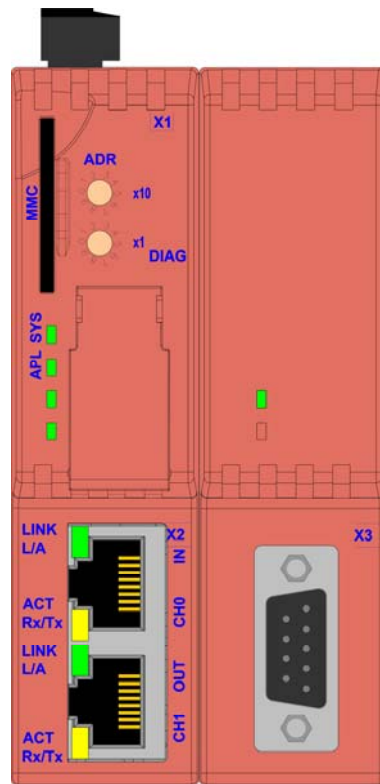
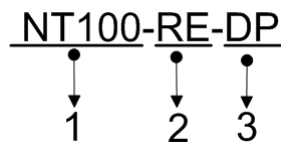

Figure 2: Device Drawing NT 100-RE-DP



The descriptive device name of netTAP devices consists of the following parts

1. Device Type netTAP 100
2. Network on port X2 (left part of device), in the example RE for Real-time Ethernet
3. Network on port X3 (right part of device), in the example DP for PROFIBUS

The following communication systems are currently supported at the primary network X2:

Code	Supported Communication System
CO	CANopen
DN	DeviceNet
DP	PROFIBUS DP
RE	Real-time Ethernet (2* RJ45)

Table 20: Network on Port X2 (Primary Network)

The following communication systems are currently supported at the secondary network X3:

Code	Supported Communication System
CC	CC-Link
CO	CANopen
DN	DeviceNet
DP	PROFIBUS DP
EN	Ethernet protocol e. g. Open Modbus/TCP and EtherNet/IP
RS	Serial (Modbus RTU, ASCII, 3964R respectively serial with netSCRIPT)

Table 21: Network on Port X3 (Secondary Network)

3.3 Protocol Conversions



Information about the configuration of the protocol conversion of the device is in the operating instruction manual *Configuration of Gateway and Proxy Devices OI xx EN.pdf* on the DVD in the directory Documentation.

3.3.1 Protocol Conversion 1: Ethernet to Ethernet

The netTAP NT 100 connects to Ethernet on port X2 and connects to Ethernet on port X3. The following netTAP NT 100 devices support this:

Device Name	Ethernet System (X2)	Ethernet System (X3)	Firmware File	Firmware Version
NT 100-RE-EN	EtherCAT Master	EtherNet/IP Adapter / Slave	NTECMEIS.NXF	1.5.x.x
	EtherCAT Master	Open Modbus/TCP	NTECMOMB.NXF	
	EtherCAT Slave	EtherNet/IP Adapter / Slave	NTECSEIS.NXF	
	EtherCAT Slave	Open Modbus/TCP	NTECSOMB.NXF	
	EtherNet/IP Scanner / Master	EtherNet/IP Adapter / Slave	NTEIMEIS.NXF	
	EtherNet/IP Scanner / Master	Open Modbus/TCP	NTEIMOMB.NXF	
	EtherNet/IP Adapter	EtherNet/IP Adapter / Slave	NTEISEIS.NXF	
	EtherNet/IP Adapter	Open Modbus/TCP	NTEISOMB.NXF	
	Open Modbus/TCP	Open Modbus/TCP	NTOMBOMB.NXF	
	Open Modbus/TCP	EtherNet/IP Adapter / Slave	NTOMBEIS.NXF	
	PROFINET IO Controller	EtherNet/IP Adapter / Slave	NTPNMEIS.NXF	
	PROFINET IO Controller	Open Modbus/TCP	NTPNMOMB.NXF	
	PROFINET IO Device	Open Modbus/TCP	NTPNSOMB.NXF	
	PROFINET IO Device	EtherNet/IP Scanner / Master	NTPNSEIM.NXF	
	PROFINET IO Device	EtherNet/IP Adapter / Slave	NTPNSEIS.NXF	
	POWERLINK Slave	EtherNet/IP Adapter / Slave	NTPLSEIS.NXF	
	POWERLINK Slave	Open Modbus/TCP	NTPLSOMB.NXF	
	sercos Master	EtherNet/IP Adapter / Slave	NTS3MEIS.NXF	
	sercos Master	Open Modbus/TCP	NTS3MOMB.NXF	
	sercos Slave	EtherNet/IP Adapter / Slave	NTS3SEIS.NXF	
sercos Slave	Open Modbus/TCP	NTS3SOMB.NXF		

Table 22: NT 100 for Ethernet to Ethernet

3.3.2 Protocol Conversion 2 - Ethernet to Fieldbus

The netTAP NT 100 connects to Ethernet on port X2 and connects to fieldbus on port X3. The following netTAP NT 100 devices support this:

Device Name	Ethernet System (X2)	Fieldbus System (X3)	Firmware File	Firmware Version
NT 100-RE-CC	EtherCAT Master	CC-Link Slave	NTECMCCS.NXF	1.5.x.x
	EtherCAT Slave	CC-Link Slave	NTECSCCS.NXF	
	EtherNet/IP Scanner / Master	CC-Link Slave	NTEIMCCS.NXF	
	EtherNet/IP Adapter / Slave	CC-Link Slave	NTEISCCS.NXF	
	Open Modbus/TCP	CC-Link Slave	NTOMBCCS.NXF	
	POWERLINK Slave	CC-Link Slave	NTPLSCCS.NXF	
	PROFINET IO Controller	CC-Link Slave	NTPNMCCS.NXF	
	PROFINET IO Device	CC-Link Slave	NTPNSCCS.NXF	
	sercos Master	CC-Link Slave	NTS3MCCS.NXF	
	sercos Slave	CC-Link Slave	NTS3SCCS.NXF	
NT 100-RE-CO	EtherCAT Master	CANopen Slave	NTECMCOS.NXF	1.5.x.x
	EtherCAT Slave	CANopen Master	NTECSCOM.NXF	
	EtherCAT Slave	CANopen Slave	NTECSCOS.NXF	
	EtherNet/IP Scanner / Master	CANopen Slave	NTEIMCOS.NXF	
	EtherNet/IP Adapter / Slave	CANopen Master	NTEISCOM.NXF	
	EtherNet/IP Adapter / Slave	CANopen Slave	NTEISCOS.NXF	
	Open Modbus/TCP	CANopen Master	NTOMBCOM.NXF	
	Open Modbus/TCP	CANopen Slave	NTOMBCOS.NXF	
	POWERLINK Slave	CANopen Master	NTPLSCOM.NXF	
	POWERLINK Slave	CANopen Slave	NTPLSCOS.NXF	
	PROFINET IO Controller	CANopen Slave	NTPNMCOS.NXF	
	PROFINET IO Device	CANopen Master	NTPNSCOM.NXF	
	PROFINET IO Device	CANopen Slave	NTPNSCOS.NXF	
	sercos Master	CANopen Slave	NTS3MCOS.NXF	
	sercos Slave	CANopen Master	NTS3SCOM.NXF	
	sercos Slave	CANopen Slave	NTS3SCOS.NXF	

Device Name	Ethernet System (X2)	Fieldbus System (X3)	Firmware File	Firmware Version
NT 100-RE-DN	EtherCAT Master	DeviceNet Slave	NTECMDNS.NXF	1.5.x.x
	EtherCAT Slave	DeviceNet Master	NTECSDNM.NXF	
	EtherCAT Slave	DeviceNet Slave	NTECSDNS.NXF	
	EtherNet/IP Scanner / Master	DeviceNet Slave	NTEIMDNS.NXF	
	EtherNet/IP Adapter / Slave	DeviceNet Master	NTEISDNM.NXF	
	EtherNet/IP Adapter / Slave	DeviceNet Slave	NTEISDNS.NXF	
	Open Modbus/TCP	DeviceNet Master	NTOMBDNM.NXF	
	Open Modbus/TCP	DeviceNet Slave	NTOMBDNS.NXF	
	POWERLINK Slave	DeviceNet Master	NTPLSDNM.NXF	
	POWERLINK Slave	DeviceNet Slave	NTPLSDNS.NXF	
	PROFINET IO Controller	DeviceNet Slave	NTPNMDNS.NXF	
	PROFINET IO Device	DeviceNet Master	NTPNSDNM.NXF	
	PROFINET IO Device	DeviceNet Slave	NTPNSDNS.NXF	
	sercos Master	DeviceNet Slave	NTS3MDNS.NXF	
	sercos Slave	DeviceNet Master	NTS3SDNM.NXF	
	sercos Slave	DeviceNet Slave	NTS3SDNS.NXF	
NT 100-RE-DP	EtherCAT Master	PROFIBUS DP Slave	NTECMDPS.NXF	1.5.x.x
	EtherCAT Slave	PROFIBUS DP Master	NTECSDPM.NXF	
	EtherCAT Slave	PROFIBUS DP Slave	NTECSDPS.NXF	
	EtherNet/IP Scanner / Master	PROFIBUS DP Slave	NTEIMDPS.NXF	
	EtherNet/IP Adapter / Slave	PROFIBUS DP Master	NTEISDPM.NXF	
	EtherNet/IP Adapter / Slave	PROFIBUS DP Slave	NTEISDPS.NXF	
	Open Modbus/TCP	PROFIBUS DP Master	NTOMBDPM.NXF	
	Open Modbus/TCP	PROFIBUS DP Slave	NTOMBDPS.NXF	
	POWERLINK Slave	PROFIBUS DP Master	NTPLSDPM.NXF	
	POWERLINK Slave	PROFIBUS DP Slave	NTPLSDPS.NXF	
	PROFINET IO Controller	PROFIBUS DP Slave	NTPNMDPS.NXF	
	PROFINET IO Device	PROFIBUS DP Master	NTPNSDPM.NXF	
	PROFINET IO Device	PROFIBUS DP Slave	NTPNSDPS.NXF	
	sercos Master	PROFIBUS DP Slave	NTS3MDPS.NXF	
	sercos Slave	PROFIBUS DP Master	NTS3SDPM.NXF	
	sercos Slave	PROFIBUS DP Slave	NTS3SDPS.NXF	

Table 23: NT 100 for Ethernet to Fieldbus

3.3.3 Protocol Conversion 3 - Ethernet to Serial

The netTAP NT 100 connects to Ethernet on port X2 and connects to serial on port X3. The following netTAP NT 100 devices support this:

Device Name	Ethernet System (X2)	Serial protocol on X3	Firmware File	Firmware Version
NT 100-RE-RS	EtherCAT Master	3964R	NTECMNVR.NXF	1.5.x.x
	EtherCAT Master	ASCII	NTECMASC.NXF	
	EtherCAT Master	Modbus RTU Master/Slave	NTECMMBR.NXF	
	EtherCAT Master	Serial with netSCRIPT	NTECMNSC.NXF	
	EtherCAT Slave	3964R	NTECSNVR.NXF	
	EtherCAT Slave	ASCII	NTECSASC.NXF	
	EtherCAT Slave	Modbus RTU Master/Slave	NTECSMBR.NXF	
	EtherCAT Slave	Serial with netSCRIPT	NTECSNSC.NXF	
	EtherNet/IP Scanner	3964R	NTEIMNVR.NXF	
	EtherNet/IP Scanner	ASCII	NTEIMASC.NXF	
	EtherNet/IP Scanner	Modbus RTU Master/Slave	NTEIMMBR.NXF	
	EtherNet/IP Scanner	Serial with netSCRIPT	NTEIMNSC.NXF	
	EtherNet/IP Adapter	3964R	NTEISNVR.NXF	
	EtherNet/IP Adapter	ASCII	NTEISASC.NXF	
	EtherNet/IP Adapter	Modbus RTU Master/Slave	NTEISMBR.NXF	
	EtherNet/IP Adapter	Serial with netSCRIPT	NTEISNSC.NXF	
	Open Modbus/TCP	3964R	NTOMBNVR.NXF	
	Open Modbus/TCP	ASCII	NTOMBASC.NXF	
	Open Modbus/TCP	Modbus RTU Master/Slave	NTOMBMBR.NXF	
	Open Modbus/TCP	Serial with netSCRIPT	NTOMBNSC.NXF	
	POWERLINK Slave	3964R	NTPLSNVR.NXF	
	POWERLINK Slave	ASCII	NTPLSASC.NXF	
	POWERLINK Slave	Modbus RTU Master/Slave	NTPLSMBR.NXF	
	POWERLINK Slave	Serial with netSCRIPT	NTPLSNSC.NXF	
	PROFINET IO Controller	3964R	NTPNMNVR.NXF	
	PROFINET IO Controller	ASCII	NTPNMASC.NXF	
	PROFINET IO Controller	Modbus RTU Master/Slave	NTPNMMBR.NXF	
	PROFINET IO Controller	Serial with netSCRIPT	NTPNMNSC.NXF	
	PROFINET IO Device	3964R	NTPNSNVR.NXF	
	PROFINET IO Device	ASCII	NTPNSASC.NXF	
	PROFINET IO Device	Modbus RTU Master/Slave	NTPNSMBR.NXF	
	PROFINET IO Device	Serial with netSCRIPT	NTPNSNSC.NXF	
	sercos Master	3964R	NTS3MNVR.NXF	
	sercos Master	ASCII	NTS3MASC.NXF	
sercos Master	Modbus RTU Master/Slave	NTS3MMBR.NXF		
sercos Master	Serial with netSCRIPT	NTS3MNVC.NXF		
sercos Slave	3964R	NTS3SNVR.NXF		
sercos Slave	ASCII	NTS3SASC.NXF		
sercos Slave	Modbus RTU Master/Slave	NTS3SMBR.NXF		
sercos Slave	Serial with netSCRIPT	NTS3SNSC.NXF		

Table 24: NT 100 for Ethernet to Serial

3.3.4 Protocol Conversion 4 - Fieldbus to Fieldbus

The netTAP NT 100 connects to Fieldbus on port X2 and connects to Fieldbus on port X3. The following netTAP NT 100 devices support this:

Device Name	Fieldbus System (X2)	Fieldbus System (X3)	Firmware File	Firmware Version
NT 100-CO-CC	CANopen Master	CC-Link Slave	NTCOMCCS.NXF	1.5.x.x
	CANopen Slave	CC-Link Slave	NTCOSCCS.NXF	
NT 100-CO-CO	CANopen Master	CANopen Slave	NTCOMCOS.NXF	
	CANopen Slave	CANopen Master	NTCOSCOM.NXF	
	CANopen Slave	CANopen Slave	NTCOSCOS.NXF	
NT 100-CO-DN	CANopen Master	DeviceNet Slave	NTCOMDNS.NXF	
	CANopen Slave	DeviceNet Master	NTCOSDNM.NXF	
	CANopen Slave	DeviceNet Slave	NTCOSDNS.NXF	
NT 100-CO-DP	CANopen Master	PROFIBUS DP Slave	NTCOMDPS.NXF	
	CANopen Slave	PROFIBUS DP Master	NTCOSDPM.NXF	
	CANopen Slave	PROFIBUS DP Slave	NTCOSDPS.NXF	
NT 100-DP-CC	PROFIBUS DP Master	CC-Link Slave	NTDPMCCS.NXF	
	PROFIBUS DP Slave	CC-Link Slave	NTDPSCCS.NXF	
NT 100-DP-CO	PROFIBUS DP Master	CANopen Slave	NTDPMCOS.NXF	
	PROFIBUS DP Slave	CANopen Master	NTDPSCOM.NXF	
	PROFIBUS DP Slave	CANopen Slave	NTDPSCOS.NXF	
NT 100-DP-DN	PROFIBUS DP Master	DeviceNet Slave	NTDPMDNS.NXF	
	PROFIBUS DP Slave	DeviceNet Master	NTDPSDNM.NXF	
	PROFIBUS DP Slave	DeviceNet Slave	NTDPSDNS.NXF	
NT 100-DP-DP	PROFIBUS DP Master	PROFIBUS DP Slave	NTDPMDPS.NXF	
	PROFIBUS DP Slave	PROFIBUS DP Master	NTDPSDPM.NXF	
	PROFIBUS DP Slave	PROFIBUS DP Slave	NTDPSDPS.NXF	
NT 100-DN-CC	DeviceNet Master	CC-Link Slave	NTDNMCCS.NXF	1.5.x.x
	DeviceNet Slave	CC-Link Slave	NTDNSCCS.NXF	
NT 100-DN-CO	DeviceNet Master	CANopen Slave	NTDNMCOS.NXF	
	DeviceNet Slave	CANopen Master	NTDNSCOM.NXF	
	DeviceNet Slave	CANopen Slave	NTDNSCOS.NXF	
NT 100-DN-DN	DeviceNet Master	DeviceNet Slave	NTDNMDNS.NXF	
	DeviceNet Slave	DeviceNet Master	NTDNSDNM.NXF	
	DeviceNet Slave	DeviceNet Slave	NTDNSDNS.NXF	
NT 100-DN-DP	DeviceNet Master	PROFIBUS DP Slave	NTDNMDPS.NXF	
	DeviceNet Slave	PROFIBUS DP Master	NTDNSDPM.NXF	
	DeviceNet Slave	PROFIBUS DP Slave	NTDNSDPS.NXF	

Table 25: NT 100 for Fieldbus to Fieldbus

3.3.5 Protocol Conversion 5 - Fieldbus to Serial

The netTAP NT 100 connects to Fieldbus on port X2 and connects to serial on port X3.

The following devices of the netTAP 100 series support this scenario:

Device Name	Fieldbus System (X2)	Serial (X3)	Firmware File	Firmware Version
NT 100-CO-RS	CANopen Master	3964R	NTCOMNVR.NXF	1.5.x.x
	CANopen Master	ASCII	NTCOMASC.NXF	
	CANopen Master	Modbus RTU Master/Slave	NTCOMMBR.NXF	
	CANopen Master	Serial with netSCRIPT	NTCOMNSC.NXF	
	CANopen Slave	3964R	NTCOSNVR.NXF	
	CANopen Slave	ASCII	NTCOSASC.NXF	
	CANopen Slave	Modbus RTU Master/Slave	NTCOSMBR.NXF	
	CANopen Slave	Serial with netSCRIPT	NTCOSNSC.NXF	
NT 100-DP-RS	PROFIBUS DP Master	3964R	NTDPMNVR.NXF	1.5.x.x
	PROFIBUS DP Master	ASCII	NTDPMASC.NXF	
	PROFIBUS DP Master	Modbus RTU Master/Slave	NTDPMMBR.NXF	
	PROFIBUS DP Master	Serial with netSCRIPT	NTDPMNSC.NXF	
	PROFIBUS DP Slave	3964R	NTDPSNVR.NXF	
	PROFIBUS DP Slave	ASCII	NTDPSASC.NXF	
	PROFIBUS DP Slave	Modbus RTU Master/Slave	NTDPSMBR.NXF	
	PROFIBUS DP Slave	Serial with netSCRIPT	NTDPSNSC.NXF	
NT 100-DN-RS	DeviceNet Master	3964R	NTDNMNVR.NXF	1.5.x.x
	DeviceNet Master	ASCII	NTDNMASC.NXF	
	DeviceNet Master	Modbus RTU Master/Slave	NTDNMMBR.NXF	
	DeviceNet Master	Serial with netSCRIPT	NTDNMNSC.NXF	
	DeviceNet Slave	3964R	NTDNSNVR.NXF	
	DeviceNet Slave	ASCII	NTDNSASC.NXF	
	DeviceNet Slave	Modbus RTU Master/Slave	NTDNSMBR.NXF	
	DeviceNet Slave	Serial with netSCRIPT	NTDNSNSC.NXF	

Table 26: NT 100 for Fieldbus to Serial

3.4 System Requirements

For correct application of the netTAP NT 100, the gateway device must be mounted on a DIN-rail according to DIN EN 60715.

A suitable power supply is required. The voltage to be applied must be in the allowed range $24\text{ V} \pm 6\text{ V DC}$. The power supply must be able to deliver at least a current of 130 mA at 24 V.

Power supply is possible via pins 1 (GND) and 2 (24V) of the netTAP NT 100 power supply connector located on the upper side of the device.

NOTICE**Device Destruction!**

- The voltage must not exceed 30 V significantly, otherwise the device may be destroyed or damaged.

In order to avoid damage caused by overheating or freezing, it is necessary that the temperature of the device does not exceed the limits of the allowed temperature range.

The following preconditions must additionally be met in order to operate the Gateway device successfully:

1. The Gateway device must have been provided with the correctly suiting firmware.
2. The Gateway device must have been configured correctly using the SYCON.net system configuration software.

3.5 Configuration Requirements

The configuration software SYCON.net must be installed on a PC. The requirements for the PC are:

- PC with 1 GHz processor or higher
- Windows[®] XP SP3, Windows[®] Vista (32 bit) SP2, Windows[®] 7 (32 bit) or Windows[®] 7 (64 bit)
- Administrator rights
- Internet Explorer 5.5 or higher
- Free disk space: min. 400 MByte
- DVD ROM drive
- RAM: min. 512 MByte, recommended 1024 MByte
- Graphic resolution: min. 1024 x 768 pixel
- Keyboard and Mouse
- USB



Note: If the project file is saved and opened again or it is used on another PC, the system requirements need to match. Particularly the DTMs need to be installed on the used PC.

3.6 Licenses

If the netTAP NT 100 device is used with a firmware with master functionality a master license in the netTAP device must be present.

If the device has a master license can be read out with the software SYCON.net.



Note: A firmware has to be loaded into the device to read out, if the device has a master license. The base firmware is not sufficient for this purpose. How to load a firmware into the device and how to read out if the device has a master license is described in the operating instruction manual *Configuration of Gateway and Proxy Devices OI xx EN.pdf*.

The master license can be ordered later with SYCON.net and transferred with SYCON.net into the device. (The master license can be ordered with at Hilscher 'NXLIC-MASTER' and has part number 8211.000.)

4 Device Drawings and Connections

4.1 Dimensioned Drawing

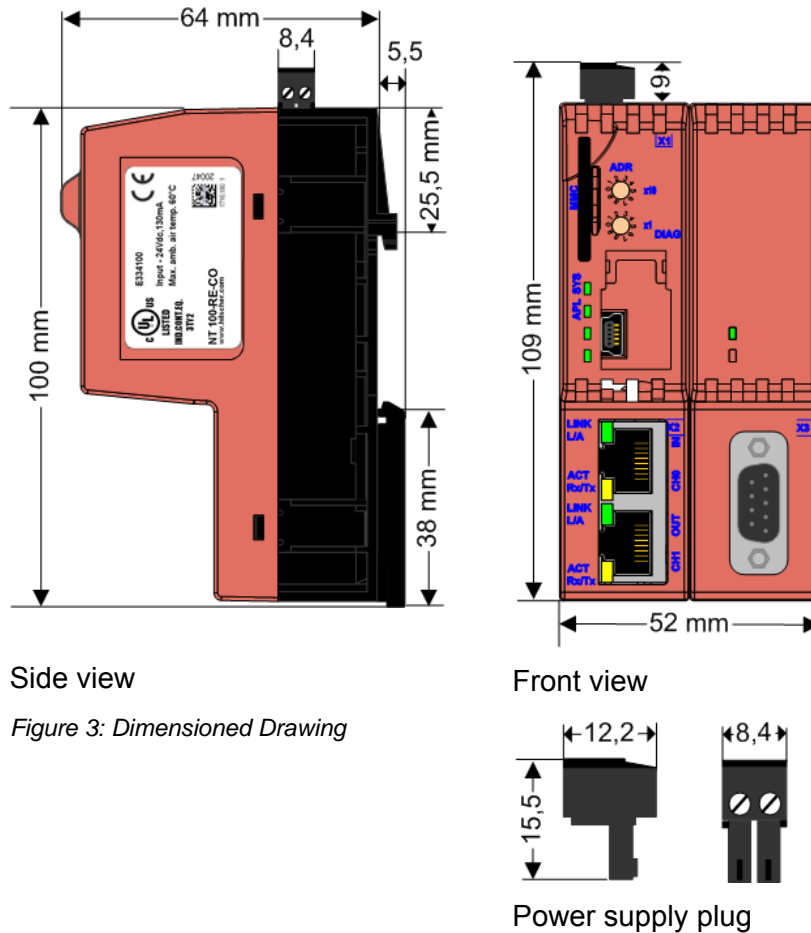

Side view

Front view

Power supply plug

Figure 3: Dimensioned Drawing

Please take care of the device's headroom. There is enough space necessary to allow the connection of the connectors and wires since they are all tending upwards.

The power supply plug is included in delivery. As spare part: the plug can be obtained from RIA CONNECT GmbH in 78176 Blumberg with part number 31369102-001792.

4.2 Device Label

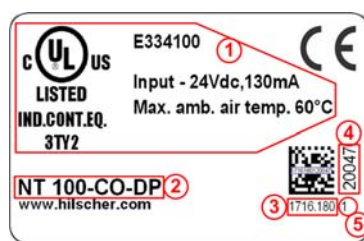

- ① UL certification data, can be viewed at <http://www.ul.com>
- ② Device type name
- ③ Part number
- ④ Serial number
- ⑤ Hardware revision number

Figure 4: Device Label

4.3 LEDs and Control Elements

4.3.1 LEDs and Control Elements of the upper half of the Device

LEDs and control elements of the upper half of the device are independent of the device type and the bus connections of the lower half of the device.

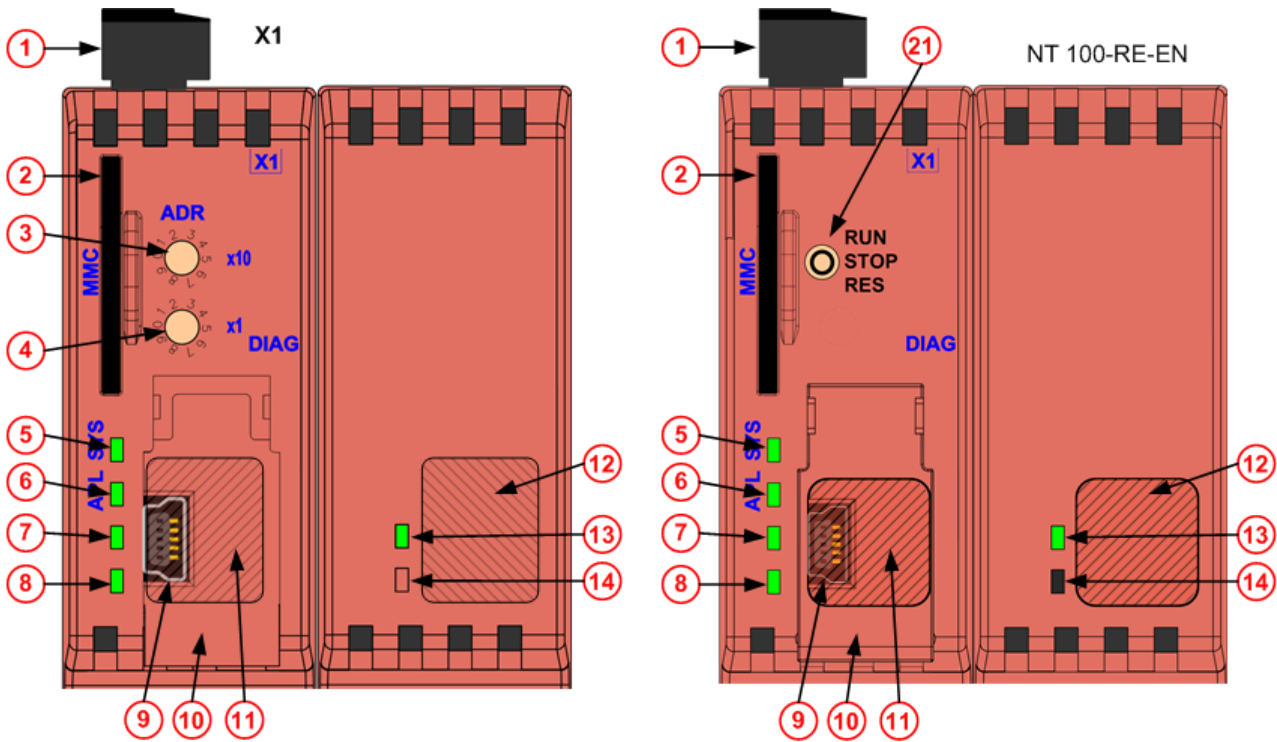

Figure 5: LEDs and Control Elements of the upper half of the Device

- ① Connector X1 for power supply
- ② Slot for memory card (part number of SD card: 1719.003)
- ③ Address switch, The address switches can be activated with SYCON.net version 1.351 (or higher) and can be used with firmware version 1.5 (or higher) for PROFIBUS DP Slave, DeviceNet Slave, CANopen Slave and CC-Link Slave. SYCON.net configures, if the address switches are used for X2 or X3. Section *Range of Values for the Address Switches* on page 34 lists the range of values for each protocol.
- ④ Address switch, factor 1
- ⑤ SYS LED
- ⑥ APL LED
- ⑦ LED, depends on protocol at X2
- ⑧ LED, depends on protocol at X2
- ⑨ Mini-USB diagnostic interface below the cover
- ⑩ Cover for diagnostic interface
- ⑪ Position for protocol depending label for the protocol at X2 on the cover
- ⑫ Position for protocol depending label for the protocol at X3

Continued on the next page

- ⑬ LED, depends on protocol at X3
- ⑭ LED, depends on protocol at X3
- ⑰ NT 100-RE-EN only, switch without function.

4.3.1.1 Range of Values for the Address Switches

Protocol	Valid range of values		
PROFIBUS DP Slave	0 ... 99 (station address)		
DeviceNet Slave	0 ... 63 (MAC ID)		
CANopen Slave	0 ... 99 (Node ID)		
Protocol	Valid range of values	Number of Stations	
CC-Link Slave	1 ... 64	1	The number of stations depends on the configuration
	1 ... 63	2	
	1 ... 62	3	
	1 ... 61	4	

Figure 6: Range of Values for the Address Switches

4.3.2 LEDs of the lower half of the Device

The lower part of the device has no control elements. Only the device type NT 100-RE-XX (Real-time Ethernet) has LEDs on the left (X2). The meaning of the LED depends on the used protocol.

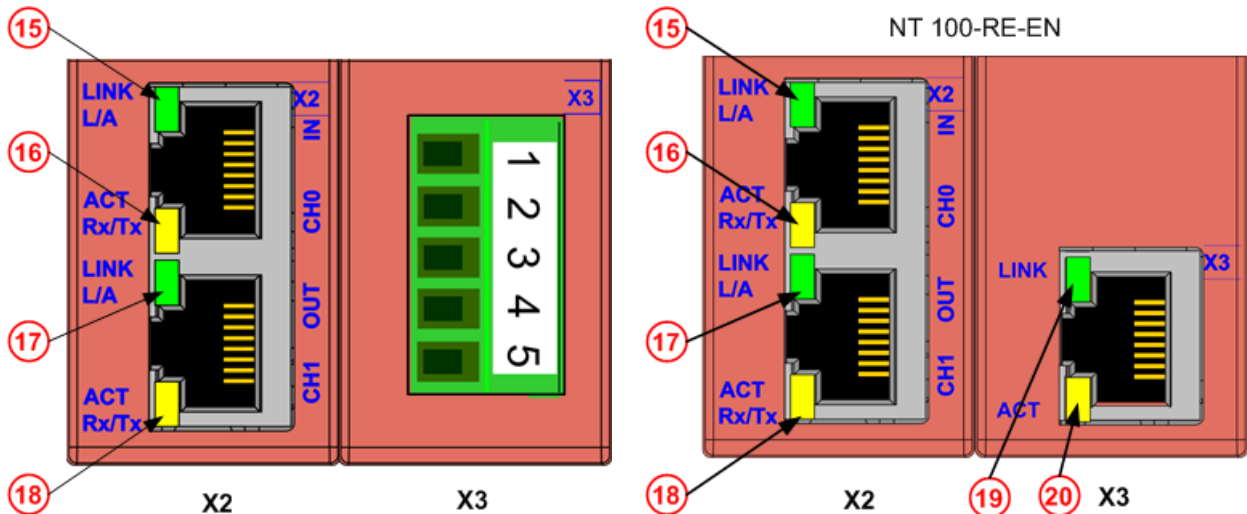

Figure 7: LEDs of the lower half of the Device

- ⑮ LINK LED (Link) / L/A LED (Link and activity) at channel 0 at X2, green.
- ⑯ ACT LED (Activity) / RxTx LED (Activity) at channel 0 at X2 yellow.
- ⑰ LINK LED (Link) / L/A LED (Link and activity) at channel 1 at X2, green.
- ⑱ ACT LED (Activity) / RxTx LED (Activity) at channel 1 at X2, yellow.
- ⑲ LINK LED (Link) at X3, green.
- ⑳ ACT LED (Activity) at X3, yellow.

4.4 Device Drawings of the left Part (with Connector X2)







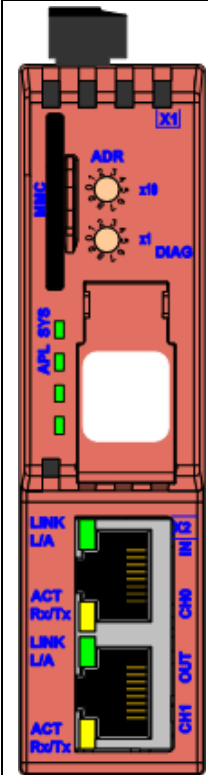
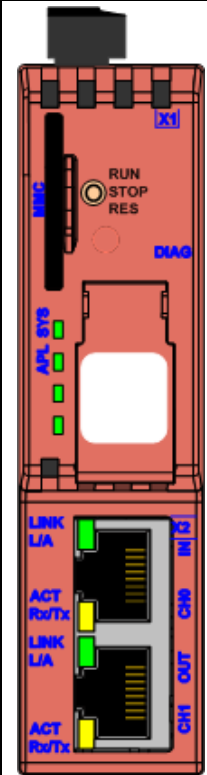
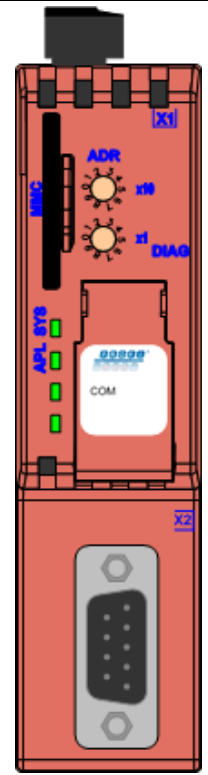
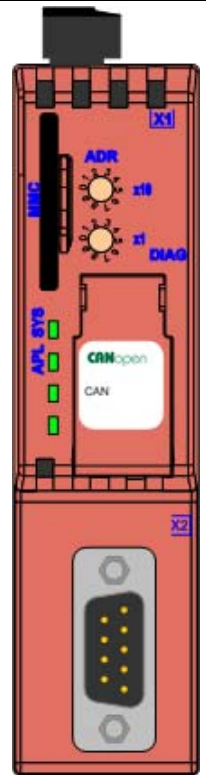

NT 100-RE-XX	NT 100-RE-EN	NT 100-DP-XX	NT 100-CO-XX	NT 100-DN-XX
				
X2 2*RJ45 socket	X2 2*RJ45 socket	X2 Dsub female 9-pin	X2 Dsub male 9-pin	X2 COMBICON 5-pin
These parts are parts of the following device types:				
NT100-RE-DP NT100-RE-CO NT100-RE-DN NT100-RE-RS NT100-RE-CC	NT 100-RE-EN	NT100-DP-DP NT100-DP-CO NT100-DP-DN NT100-DP-RS NT100-DP-CC	NT100-CO-DP NT100-CO-CO NT100-CO-DN NT100-CO-RS NT100-CO-CC	NT100-DN-DP NT100-DN-CO NT100-DN-DN NT100-DN-RS NT100-DN-CC

Figure 8: Device Drawings – Left Part (X2)

LED label for Real-time Ethernet (NT 100-RE-XX):

PROFINET IO	EtherCAT	EtherNet/IP	sercos	Open Modbus/TCP	POWERLINK
					
SF BF	RUN ERR	MS NS	STA ERR	RUN ERR	BS BE

The labels are part of delivery. Please stick the corresponding label on your device.

4.5 Device Drawings of the right Part (with Connector X3)





NT 100-XX-DP	NT 100-XX-CO	NT 100-XX-RS	NT 100-XX-DN	NT 100-XX-CC	NT 100-RE-EN
					
X3 Dsub female 9-pin	X3 Dsub male 9-pin	X3 Dsub male 9-pin	X3 COMBICON 5-pin	X3 COMBICON 5-pin	X3 *RJ45 socket
These parts are parts of the following device types:					
NT100-RE-DP NT100-DP-DP NT100-CO-DP NT100-DN-DP	NT100-RE-CO NT100-DP-CO NT100-CO-CO NT100-DN-CO	NT100-RE-RS NT100-DP-RS NT100-CO-RS NT100-DN-RS	NT100-RE-DN NT100-DP-DN NT100-CO-DN NT100-DN-DN	NT100-RE-CC NT100-DP-CC NT100-CO-CC NT100-DN-CC	NT 100-RE-EN

Figure 9: Device Drawings – Right Part (X3)

4.6 Connections

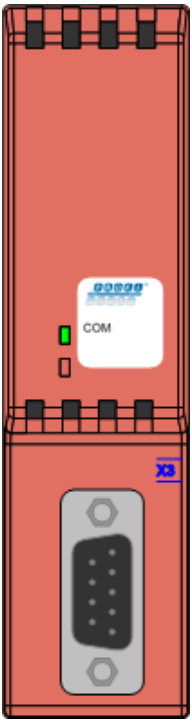
4.6.1 X1 Power Supply

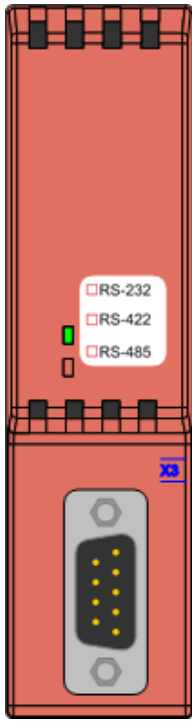
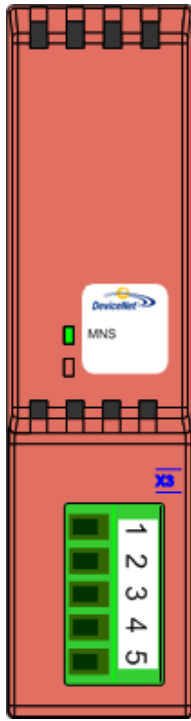
The power supply of the netTAP 100 gateway has to be connected to the power connector X1. The power supply voltage must be in the range between 18 V and 30 V DC. The plug is included in delivery.

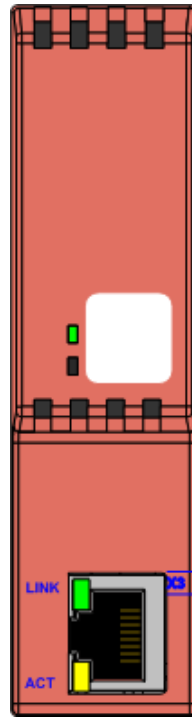
Power Supply Line Pin Assignment

Power supply line	Pin	Signal	Description
 Mini Combicon	1	0 V / GND	Ground of power supply
	2	24 V	+24 V power supply

Table 27: Power Supply Line Pin Assignment

4.6.2 X2/X3 Front Connection

4.6.2.1 X2/X3 PROFIBUS Interface

The PROFIBUS interface X2/X3 is a RS-485 interface according to PROFIBUS standard EN 50170. The interface is for NT 100-XX-DP devices on the left (X2) and for NT 100-DP-XX on the right (X3) half of the housing.

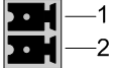
RS-485 PROFIBUS Pin Assignment

PROFIBUS	Pin	Signal	Description
 9-pole sub-D socket, female	3	Rx/Tx +	Receive- / Transmit data positive
	4	CNTR-P	Control signal for repeater (direction control)
	5	ISO GND	Data ground
	6	VP	Power supply positive 5V for terminating resistor. Maximum current 100 mA.
	8	Rx/Tx -	Receive- / Transmit data negative
	Shield	PE	Metal shell on PE

Table 28: PROFIBUS RS-485 Pin Assignment

A pull up resistor of 100 k Ω is connected device internally at "Rx / Tx +".

A pull down resistor of 100 k Ω is connected device internally at "Rx / Tx -".

Please note the wiring instructions in section *PROFIBUS* on page 115.

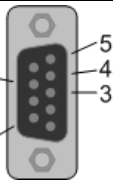
4.6.2.2 X2/X3 CANopen Interface

The CANopen interface X2/X3 is according to ISO 11898 according to the CANopen CiA DS 102 standard.

CANopen Pin Assignment



CANopen	Pin	Signal	Description
 <p>9-pole sub-D male.</p>	2	CAN L	CAN Low bus line
	3	ISO GND	CAN ground
	7	CAN H	CAN High bus line
	1, 4, 5, 6, 8, 9		 Important note and strongly recommended: Leave these pins unconnected! Otherwise there is a high risk of a device damage.
	Shield	PE	Metal shell on PE

Table 29: CANopen Pin Assignment

Please note the wiring instructions in section *CANopen* on page 117.

4.6.2.3 X2/X3 DeviceNet Interface

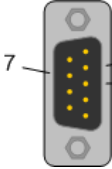
The pin assignment of the DeviceNet interface X2/X3 is according to the DeviceNet standard.

DeviceNet Pin Assignment

DeviceNet	Pin	Signal	Description
 <p>COMBICON Socket, female</p>	1	ISO GND	Common ground DeviceNet-power supply.
	2	CAN L	CAN Low signal
	3	Drain	Shield
	4	CAN H	CAN High signal
	5	V+	+24 V DeviceNet-power supply

Table 30: DeviceNet Pin Assignment

Please note the wiring instructions in section *DeviceNet* on page 118.

4.6.2.4 X2 Ethernet Interface

For Ethernet interface RJ45 sockets are used and twisted pair cables of category 5 (CAT5) or higher, which are 4 pairs of twisted pairs. The maximum baudrate is 100 MBit/s (CAT5).



Note: The device supports the Auto Crossover function. Due to this fact RX and TX can be switched. The following figure shows the RJ45 standard pinning.

Ethernet on RJ45 pin assignment

Ethernet	Pin	Signal	Description
<p>RJ45 socket, female</p>	1	TX+	Transmit data positive
	2	TX-	Transmit data negative
	3	RX+	Receive data positive
	4	Term 1	Connected and terminated to PE via RC combination*
	5	Term 1	
	6	RX-	Receive data negative
	7	Term 2	Connected and terminated to PE via RC combination*
	8	Term 2	
			* Bob Smith Termination

Table 31: Ethernet RJ45 pin assignment



Important: Please note for the use of hubs and switches the wiring instructions in section *Ethernet* on page 114.

4.6.2.5 X3 CC-Link Interface

CC-Link Pin Assignment

CC-Link	Pin	Signal	Description
<p>Socket, female</p>	1	DA	Data positive
	2	DB	Data negative
	3	DG	Data ground
	4	SLD	Shield, internally connected to common ground
	5	FG	Field ground, internally connected to common ground

Table 32: CC-Link Pin Assignment

Please note the wiring instructions in section *CC-Link* on page 120.

4.6.2.6 X3 Serial Interface – RS-232 / RS-422 / RS-485

The serial interface at X3 can be used with RS-232, RS-422 or RS-485.. This must be set by the software configuration.

RS-232 pin assignment

RS-232	Pin	Signal	Description
 <p>9-pole sub-D socket, male</p>	2	RxD	Receive data
	3	TxD	Transmit data
	5	GND	Reference potential
	7	RTS	Request to send
	8	CTS	Clear to send
	Shield	PE	Metal shell on PE

Table 33: RS-232 pin assignment

RS-422 pin assignment

RS-422	Pin	Signal	Description
 <p>9-pole sub-D socket, male</p>	1	RxD-	Receive data negative
	4	TxD+	Transmit data positive
	6	RxD+	Receive data positive
	9	TxD-	Transmit data negative
	Shield	PE	Metal shell on PE

Table 34: RS-422 pin assignment

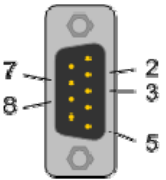
RS-485 pin assignment

RS-485	Pin	Signal	Description
 <p>9-pole sub-D socket, male</p>	1	RxD / TxD -	Receive data / Transmit data negative
	6	RxD / TxD +	Receive data / Transmit data positive
	Shield	PE	Metal shell on PE

Table 35: RS-485 pin assignment

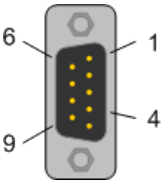
4.6.2.7 Termination for RS-422 and RS-485

On the back of the NT 100-XX-RS devices is a sliding switch (S3) for activation or deactivation of the termination.

Switch S3	Meaning	
 <p>Switch in position On (up).</p>	Switch up On	Termination switched on with 220 Ohm termination resistor for RS-422 between RxD + and RxD - respectively for RS-485 between RxD/TxD + and RxD/TxD - and 390 Ohm pull up/pull down resistor
	Switch down Off	Termination switched off

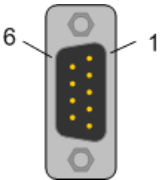
Table 36: Sliding Switch for Termination of RS-422 respectively RS-485 on NT 100-XX-RS Devices

The following figure shows the termination in the device for RS-485:

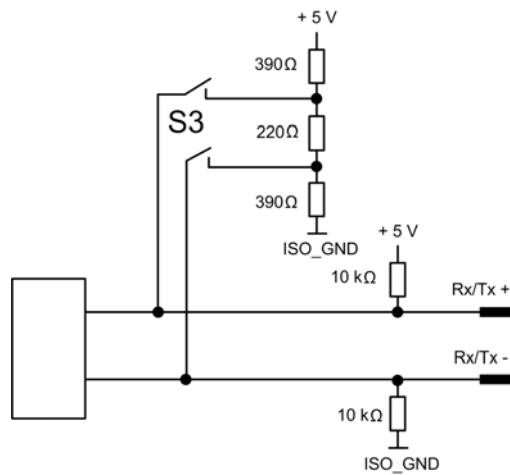

Figure 10: RS-485 Termination

For RS-422 the termination shown above is only at the RxD signals.

4.6.3 Diagnostic Interface (Mini-B USB)

The USB interface is for configuration and diagnostic purposes.

USB Socket	Pin	Signal	Description
	1	USB_EXT	Power supply USB Bus (+5 V, from externally)
	2	D-	Data -
	3	D+	Data +
	4	ID	
	5	GND	Ground
	Shield	PE	Metal shell to PE

Table 37: Pin Assignment Mini-B USB Connector (5-pin)

4.7 Schematic Diagram - Galvanic Isolation

The following schematic diagram illustrates the internal connection between the different connectors. This gives you the chance to properly install the device in accordance with the potential equalization concept of your plant.

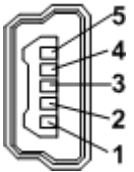

Note: The PE connection (potential equalization) of the device is done via the DIN rail.

4.7.1 Isolation in Case of NT 100-RE-EN Devices

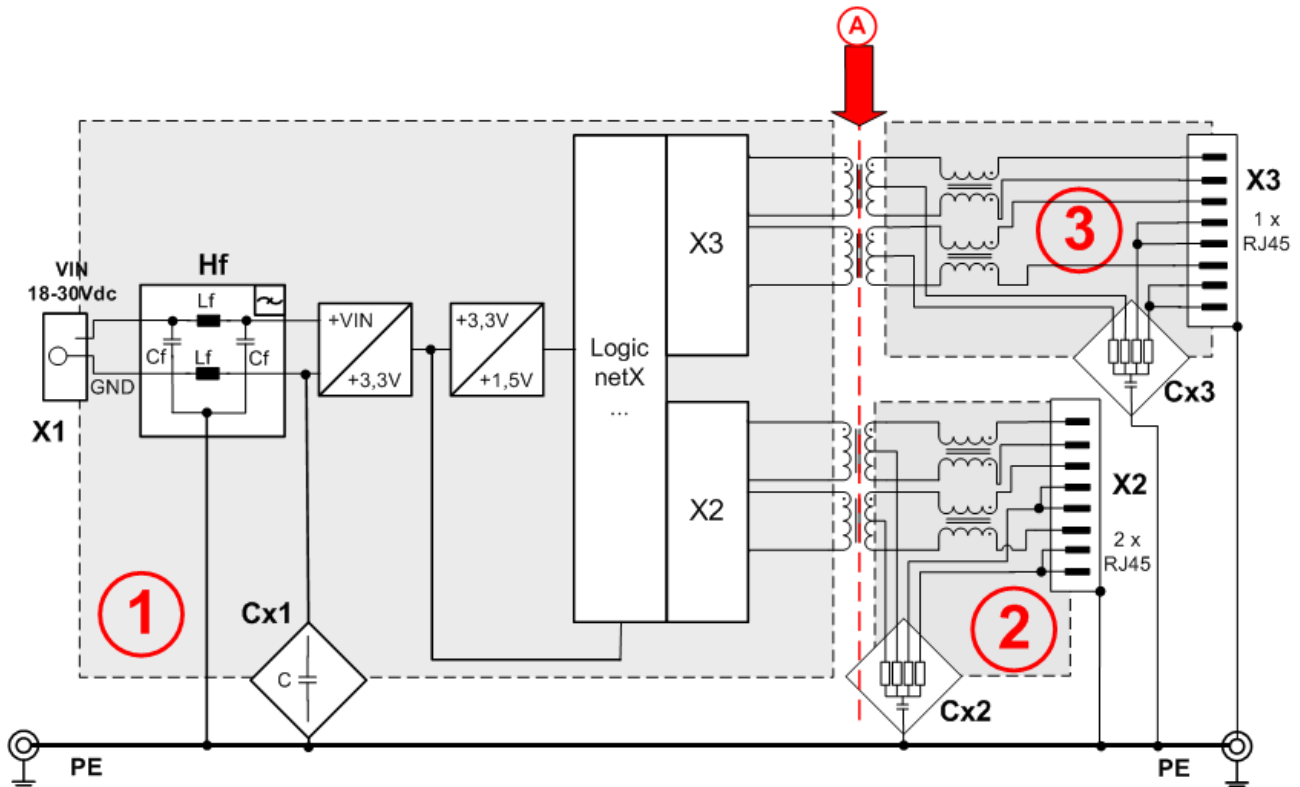

Figure 11: Galvanic Isolation of the NT 100-RE-EN Device

The device has three galvanically isolated areas. The isolation to the bus connection is indicated by an arrow **A**.

- 1** System area, galvanically coupled with the power supply connection X1
- 2** Ethernet connecting area, 2 * RJ45. The figure above shows only one RJ45 socket. The second RJ45 socket is built up identically and connected to the logic at netX X2.
- 3** Ethernet connection area 1 * RJ45 (right part of housing)

The following table shows the characteristics of the galvanic isolation of the different areas and coupling against potential equalization.

Area Connection	Protocol	galv. Isolation	Coupling	Coupling against PE potential	Functional earthing to PE
① X1	-	no	Cx1 ①	4 * 10 nF 500V	
			HF ①	Cf = 10 nF, Lf = 47 μH	
② X2	Ethernet	inductive	Cx2 ②	4 * 75 Ω, 1 nF 2000 V	Directly via the metal connection of RJ 45 sockets
③ X3	Ethernet	inductive	Cx3 ③	4 * 75 Ω, 1 nF 2000 V	Directly via the metal connection of RJ 45 sockets

Table 38: Coupling NT 100-RE-EN Devices

4.7.2 Isolation in Case of NT 100-RE-XX Devices

Coupling for the device types:

NT 100-RE-CC, NT 100-RE-CO, NT 100-RE-DP, NT 100-RE-DN,
NT 100-RE-RS

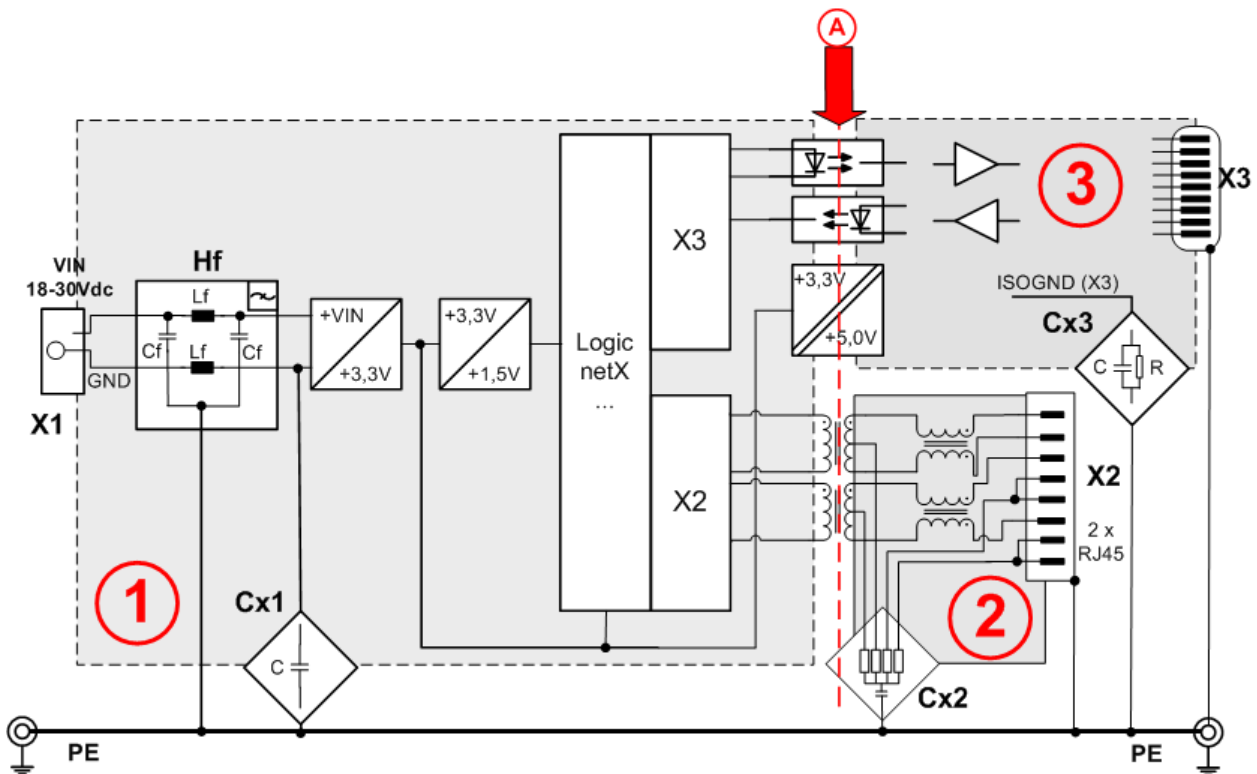

Figure 12: Galvanic Isolation NT 100-RE-XX Devices

The device has three galvanically isolated areas. The isolation to the bus connection is indicated by an arrow **A**.

- ① System area, galvanically coupled with the power supply connection X1
- ② Ethernet connecting area, 2 * RJ45. The figure above shows only one RJ45 socket. The second RJ45 socket is built up identically and connected to the logic at netX X2.
- ③ Fieldbus connecting area with DSub male / female or Combicon-connector.

The following table shows the characteristics of the galvanic isolation of the different areas and coupling against potential equalization.

Area Connection	Protocol	galv. Isolation	Coupling	Coupling against PE potential	Functional earthing to PE
① X1	-	no	Cx1 ①	4 * 10 nF 500V	
			HF ①	Cf = 10 nF, Lf = 47 µH	
② X2	Ethernet	inductive	Cx2 ②	4 * 75 Ω, 1 nF 2000 V	Directly via the metal connection of RJ 45 sockets
③ X3	CC-Link	inductive	Cx3 ③	3,3 nF 63 V	directly
	CANopen	optically	Cx3 ③	1 MΩ // 15 nF 1000V	directly
	PROFIBUS DP	inductive	Cx3 ③	1 MΩ // 2,2 nF 1000 V	directly
	DeviceNet	optically	Cx3 ③	1 MΩ // 15 nF 1000V	1 MΩ // 15 nF 1000V
	RS-232/422/485	optically	Cx3 ③	1 MΩ // 15 nF 1000V // 10 nF 500 V	directly

Table 39: Coupling RE Devices

Area Connection	Protocol	galv. Isolation	Coupling	Coupling against PE potential	Functional earthing to PE
① X1	-	no	Cx1 ①	4 * 10nF 500V	
			HF ①	Cf = 10 nF, Lf = 47 µH	
② X2	Profibus DP	inductive	Cx2 ②	1 MΩ // 2,2 nF 1000 V	directly
	CANopen	optically	Cx2 ②	1 MΩ // 15 nF 1000V	directly
	Profibus DP	inductive	Cx2 ②	1 MΩ // 2,2 nF 1000 V	directly
	DeviceNet	optically	Cx2 ②	1 MΩ // 15 nF 1000V	1 MΩ // 15 nF 1000V
③ X3	CC-Link	inductive	Cx3 ③	3,3 nF 63 V	directly
	CANopen	optically	Cx3 ③	1 MΩ // 15 nF 1000V	directly
	PROFIBUS DP	inductive	Cx3 ③	1 MΩ // 2,2 nF 1000 V	directly
	DeviceNet	optically	Cx3 ③	1 MΩ // 15 nF 1000V	1 MΩ // 15 nF 1000V
	RS-232/422/485	optically	Cx3 ③	1 MΩ // 15 nF 1000V // 10 nF 500 V	directly

Table 40: Coupling NT 100-DP-XX/CO-XX/DN-XX Devices

5 NT 100 Mounting and Dismounting

5.1 Mounting Instructions

The devices can be mounted side-by-side without any gap. On the top side, the devices should have a minimum distance of 20 mm to the next device.

The air ventilation slots of the device must not be covered by any objects.

NOTICE

Device Destruction!

- Please pay attention to the grounding concept and shielding concept of the plant. The concept should prevent that a compensating current flows via signal and power supply lines between the used devices. Otherwise a device destruction is possible.

5.2 DIN Top Hat Rail Mounting of the NT 100

Mount the top hat rail according to DIN EN 60715 for the netTAP device horizontally at the intended location. The DIN top hat rail has to be connected with the potential equalization conductor (PE).

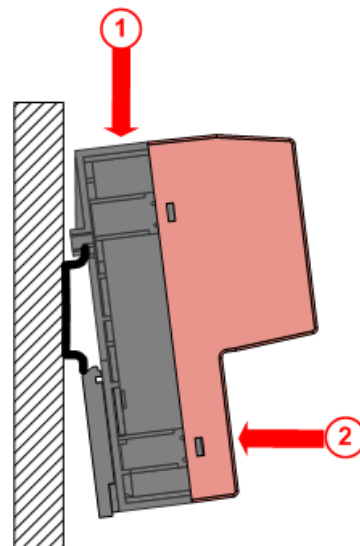

Push the device (as illustrated at the left) onto the top hat rail from above **1**.

Then press the device against the mounting surface, according to arrow **2**.

Figure 14: Mounting the netTAP NT 100 device onto the DIN top hat rail

Afterwards connect the 24 V supply voltage to the device. Grounding is done via a grounding contact located at the backside of the device connecting it electrically to the DIN top hat rail.

5.3 Removing the NT 100 from the DIN Top Hat Rail

In order to remove the netTAP from the DIN Top Hat Rail, first remove the power supply cable and all data cables from the device.

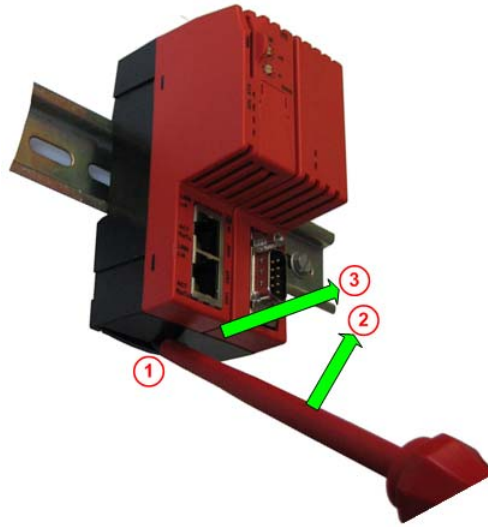

To release the device from the DIN Top Hat Rail, use a screw driver, which you put at the clip **①** in the center of the device. By pressing the screw driver in direction of arrow **②** the lock at the DIN top hat rail is released. You can then easily pull the device off the DIN top hat rail in direction of arrow **③**.

Figure 15: Removing the NT 100 device from the DIN Top Hat Rail

6 Installing Driver

Always use the installation program to install the USB driver. The installation program is named *setup.exe* and is on the Gateway Solution DVD in the folder `Setups & Drivers\USB Driver`.

Install the USB driver at first, before you connect the netTAP NT 100 gateway to the USP port of your PC the first time.

Windows XP: The **Found New Hardware Wizard** appears under Windows XP, when you connect the gateway to the USB port for the first time. Select the **Install the software automatically** option in the wizard, if the USB driver is installed on your PC.

7 Commissioning

7.1 Load Firmware and Configuration

The device is delivered without loaded firmware and without configuration. For commissioning it is necessary to load using the configuration software SYCON.net a firmware and a configuration into the device.

7.1.1 Download Configuration Files from the PC

1. Create and save the configuration on a standard PC using the configuration software SYCON.net.
2. First, download the firmware via a USB connection into the device and afterwards download the configuration into the device. The firmware has to be downloaded only once, while the configuration has to be downloaded after each change.

The firmware and configuration is stored in a non-volatile memory in the device and will be available after each power on.

A step by step description is in the operating instruction manual *Configuration of Gateway and Proxy Devices*.

7.1.2 Transfer Configuration from Memory Card

7.1.2.1 Prerequisite for Memory Cards

1. A memory card with a maximum capacity of 2 GByte can be used.
2. The memory card has to be formatted in FAT format. The FAT12/16/32 formats are supported. The exFAT format is not supported.
3. Memory cards of the type MMC or SD card can be used. Additional prerequisites apply to use any SD card, which are described below.

Prerequisites to use any SD card

Any SD cards can only be used if **both** of the following prerequisites are fulfilled:

1. Firmware version 1.5.10.0 or higher has to be used in the device.
2. The following devices can be used with any MMC and SD card for saving and recovering the device:
 - NT 100-RE-xx with serial number 24906 and higher,
 - NT 100-DP-xx with serial number 21473 and higher,
 - NT 100-DN-xx with serial number 20283 and higher as well as
 - NT 100-CO-xx with serial number 20148 and higher.

Only the SD card which can be ordered from Hilscher (part number 1719.003) can be used reliable with devices that have a lower serial number.

7.1.2.2 Steps to Transfer Configuration Files from Memory Card

Using a memory card makes it possible to load the same configuration (and firmware) into several devices without using a PC. At first a PC and software SYCON.net is necessary to prepare the memory card.

1. Create and save the configuration on a standard PC using the software SYCON.net.
2. Transfer the configuration from the PC via a USB connection into the device.
3. Insert an empty but formatted memory card into the memory card slot of the netTAP device until it snaps in.
4. Use SYCON.net to copy the firmware and configuration inside the netTAP device to the memory card.
5. Remove the memory card from the device.

6. Insert this memory card into the memory card slot (labeled MMC) of the new device. This device continues its operation with the firmware and configuration, which is stored in the device in the non-volatile flash memory.
7. Remove the power supply from the device.
8. Reconnect the power supply. After return of power the files from the memory card are copied into the non-volatile flash memory of the device (this operation takes a moment) and then the device starts with it.
9. Remove the memory card from the device to have a faster start of the device for the next power on, because the copy operation is not done.

7.2 Start-up Behavior

The start-up behavior of the device depends on the fact, whether at the time of return of power supply a memory card is inserted in the device or not.

7.2.1 Start-up without Memory Card

After return of power supply the configuration data are loaded into the device internal memory. Depending on the amount of stored configuration data this can last for some seconds (approx. 4 s).

7.2.2 Start-up with Memory Card



Important: Two parameters are displayed in SYCON.net software for the start behavior in case of repowering the device and memory card present in the slot of the device. Only the **Start-up Options** parameter **Restore automatically** with setting “Every start” has to be used!

The **Start-up Options** parameter **Restore automatically** with the setting **If different** is not supported by the netTAP firmware and results in the situation that no files from the memory card are transferred into the device. However it is possible to copy the files from memory card to the device with SYCON.net software (manually).

The following description refers to the parameter start behavior **Every Start** of the memory card.

1. Remove power supply from the netTAP NT 100 device
 2. Insert memory card with until it snaps in
 3. Supply 24 V operation voltage to the device
- ⇒ The SYS LED indicates a quick alternating between green and yellow for approx. 8 s. During this time the memory card can be removed from the device to prevent the data transfer.

Afterwards the files were transferred from the memory card into the non-volatile flash memory of the device. This operation takes (typically)

up to 1 minute. With large configuration files (especially netSCRIPT files) this time can be exceeded. During this operation the SYS LED is yellow.

➤ After the copy operation the device starts with the new configuration.

It is possible to load the same configuration from one MEMORY card into several devices without using a PC.

7.2.3 Reset Device to Factory Settings with Memory Card

Using a memory card that has the basic firmware stored on it, the netTAP NT 100 device can be set back to factory settings.

In order to do so, copy from the directory of the DVD

```
Supplements & Examples\Device Recovery\netTAP 100 Factory Settings\Recovery via Memory Card\
```

the file `STARTUP.INI` and the directory `BACKUP` (including all subdirectories) into the root directory of an empty MEMORY card.

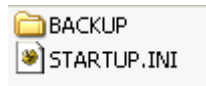

Proceed as follows:

1. Remove power supply from the netTAP NT 100 device.
 2. Insert the memory card with basic firmware until it snaps in.
 3. Supply 24 V operation voltage to the device.
- The device loads the firmware while the SYS-LED indicates the following states: Quick alternating between green and yellow (for approx. 8 s), then solid yellow (for approx. 10 s), then switched off for a short time and finally solid green.
- Afterwards the device is reset to factory settings.

Subsequently the device needs to be configured by the software SYCON.net using a PC. The configuration steps are described in document *Configuration of Gateway and Proxy Devices*.

7.2.4 Boot up Behaviour on invalid Firmware

If after the power up cycle the LED SYS **5** in section *LEDs and Control Elements* on page 33 is flashing yellow / green at a rate of 1 Hz, the firmware of the device is invalid or has been destroyed. In this case there is no further access possible with the configuration tool SYCON.net. The device has fallen back into boot loader mode.

The device has to be recovered to the factory default settings.

7.2.4.1 Recover to Factory Default Settings via USB

The following devices are recoverable via USB:

- NT 100-RE-EN all
- NT 100-RE-xx serial number 20888 and above
- NT 100-DP-xx serial number 20397 and above
- NT 100-DN-xx serial number 20145 and above
- NT 100-CO-xx serial number 20060 and above

Devices with serial numbers below can not be updated via USB and are remaining recoverable with MEMORY card only! See section *Reset Device to Factory Settings with Memory Card* on page 53.

In case there is no further communication possible via and the configuration tool SYCON.net because a firmware download has failed for example, then a special recovery procedure can bring back the device back to life.

In this special state the LED SYS (No. **13**) in section *LEDs and Control Elements* on page 33 is flashing yellow / green at 1 Hz.

In case a NT 100 device is connected in this very special state to the USB port of a PC, windows will ask for a new USB driver, even if you have already installed it before. Please follow the instructions in the section *USB Driver Installation in Boot Loader Mode as „Hilscher netX boot monitor“* on page 55 to install the driver.

Just in the case that no driver installation is requested (cause the device has been previously connected in this state before already) please follow the instructions in the section *Loading Firmware in Boot Loader Mode* on page 59.

7.2.4.2 USB Driver Installation in Boot Loader Mode as „Hilscher netX boot monitor“



Note: The following section only need to be done in case of an error, if the firmware download into the devices was not completed without error. (Loss of power or line interruption during the firmware download).

After establishing the USB cable connection and powering the device, windows will ask for the USB driver with the following window:

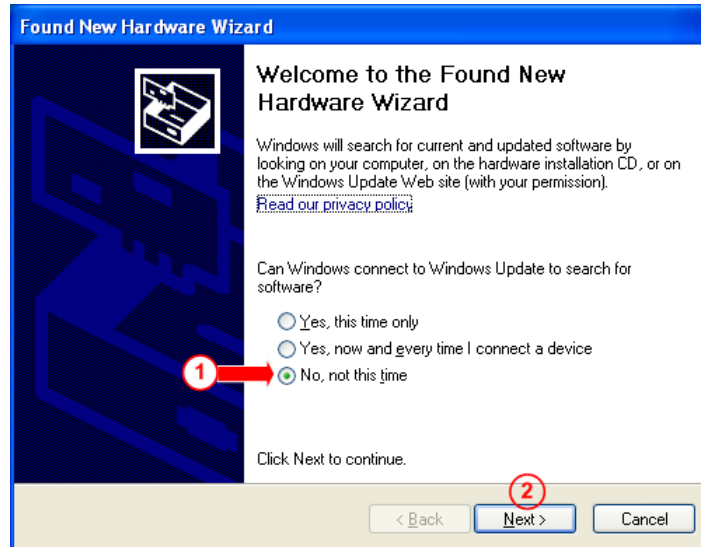

Figure 16: USB Installation in Boot Loader Mode Step 1

- Insert the DVD included in the delivery into the DVD drive of your PC.
- Select **No, not this time** ①. Afterwards click **Next** ②.

- The following window will be opened.

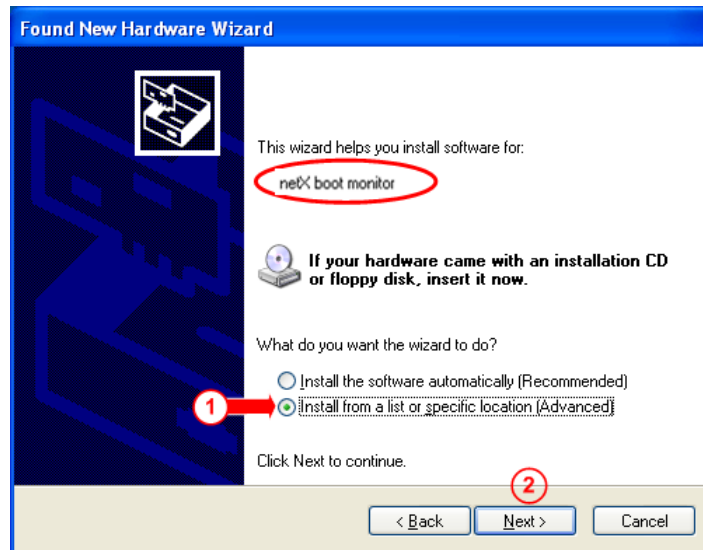

Figure 17: USB Installation in Boot Loader Mode Step 2

- Select in this windows the option **Install from a list or specific location** and then click **Next** ②.
- The following window will appear.

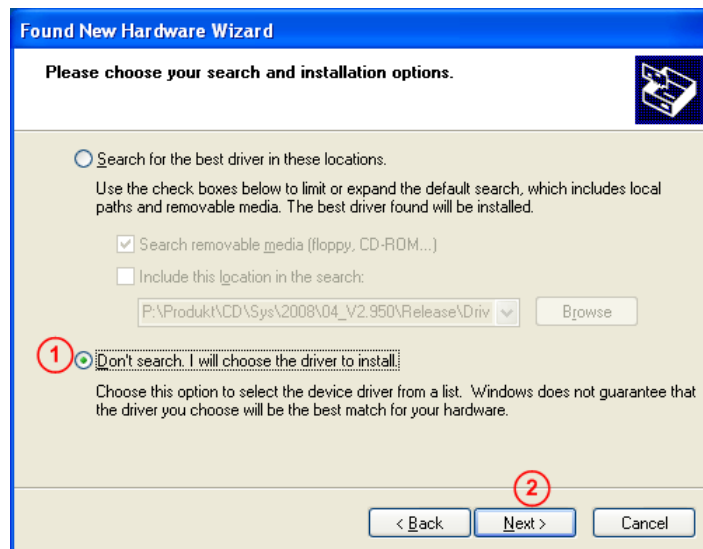

Figure 18: USB Installation in Boot Loader Mode Step 3

- Select **Don't search ...** ① and then click **Next** ②.

- The following window will be opened.

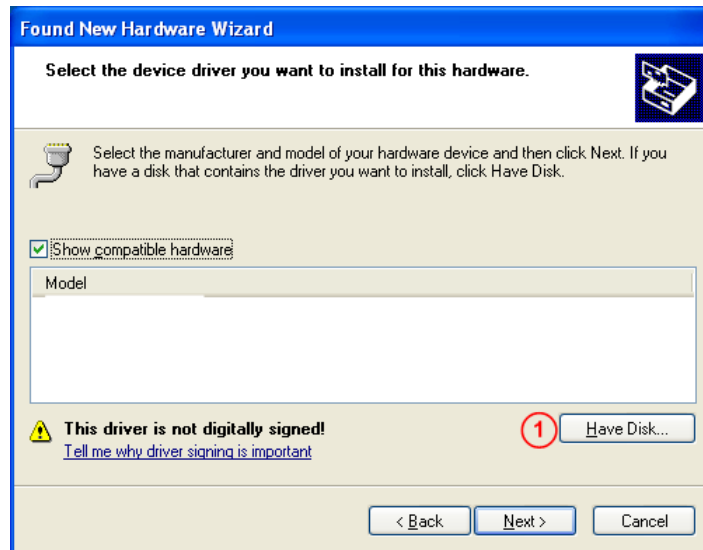

Figure 19: USB Installation in Boot Loader Mode Step 4

- Select the option **Have Disk** ①.
- The following window will be opened.

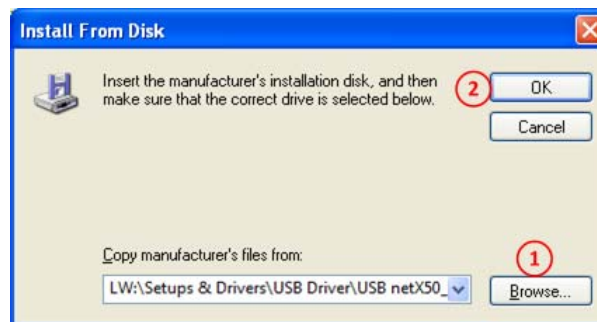

Figure 20: USB Installation in Boot Loader Mode Step 5

- Click **Browse** ①.
- In the opening file explorer move to the DVD folder `Setups & Drivers\USB Driver\USB netX50_51_52 and netX100` and select the file `netX_usb_cdc.inf`.
- After returning to this window click **OK** ②.

➤ You will return back to the following window.

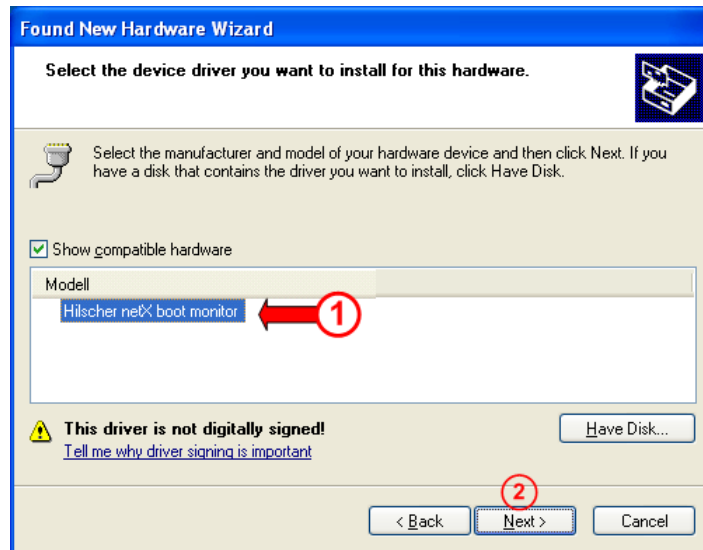

Figure 21: USB Installation in Boot Loader Mode Step 6

- Select **Hilscher netX boot monitor** ① (even if there are other entries shown, please select this one) and confirm with **Next** ②.
- The following window will be opened.

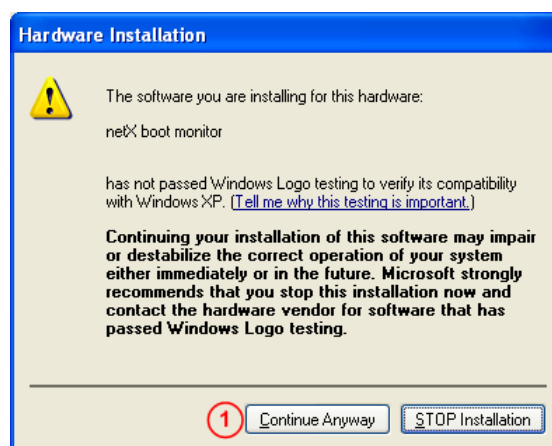

Figure 22: USB Installation in Boot Loader Mode Step 7

- Confirm with **Continue Anyway** ①.
- Wait until the driver has been properly installed.
- Continue with section Loading Firmware in Boot Loader Mode on page 59.

7.2.4.3 Loading Firmware in Boot Loader Mode

- Start directly from the DVD Supplements & Examples\Device Recovery\netTAP 100 Factory Settings\Recovery via USB\comproX.exe.
- Alternatively, copy all files from Supplements & Examples\Device Recovery\netTAP 100 Factory Settings\Recovery via USB onto your PC and then start comproX.exe.
- The following window will be opened.

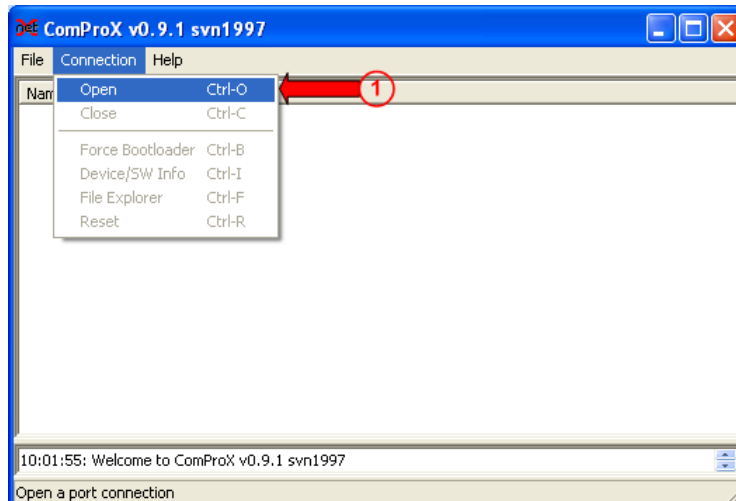

Figure 23: ComProX Start

- Select the drop down menu **Connection > Open** ①.
- The following window will be opened.

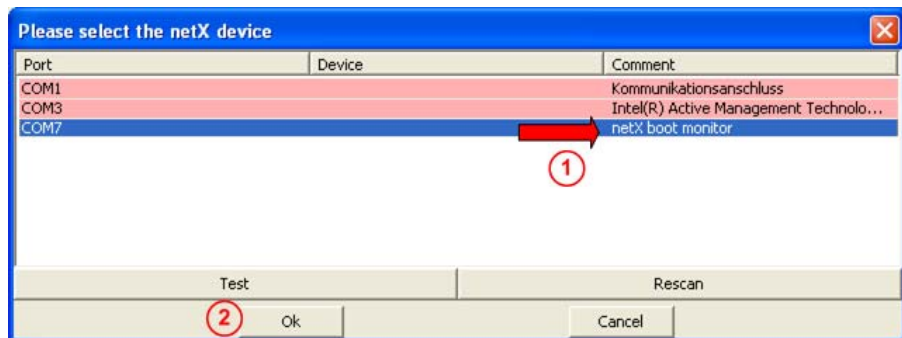

Figure 24: ComProX Choice of Connection

- Select **netX boot monitor** ① and confirm with **OK** ②.

➤ You are forwarded back to the program's start screen.

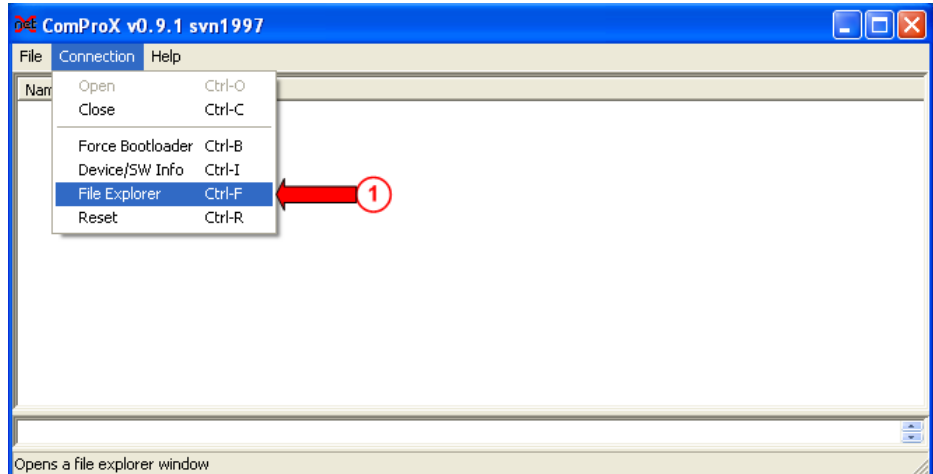

Figure 25: ComProX Choice File Explorer

- Select now from the drop down menu **Connection > File Explorer** ①.
- The following additional windows will be opened.

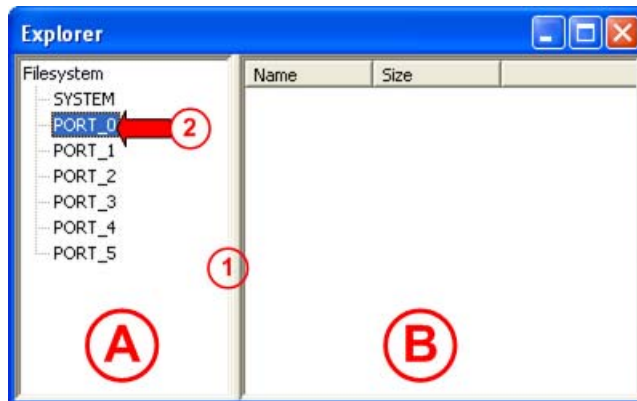

Figure 26: ComProX File Explorer - NT 100 File System Structure

- In order to see the file system of the device in the window area ① move the dividing line ① slightly to the right.
- Select in the window area ① the entry **PORT_0** ② and then do a right mouse click afterwards in the window area ②.

➤ The following dialog menu will be opened.

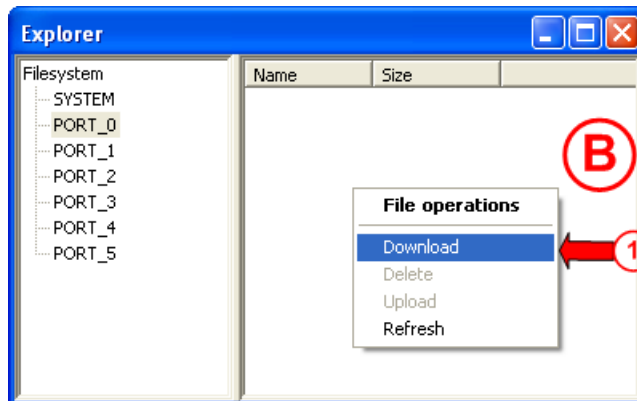

Figure 27: ComProX File Explorer - File Menu 1

- Select from the drop down menu **Download** ①.
- The standard file explorer of your windows will be opened.
- Move on the DVD to folder
Supplements & Examples\Device Recovery\netTAP 100
Factory Settings\Recovery via USB
or move to the local folder and select the file NTBASEFW.NXF .
- Loading the firmware may take some seconds.
- Right mouse click into the window area ② of the window above.
- The following dialog menu will be opened.

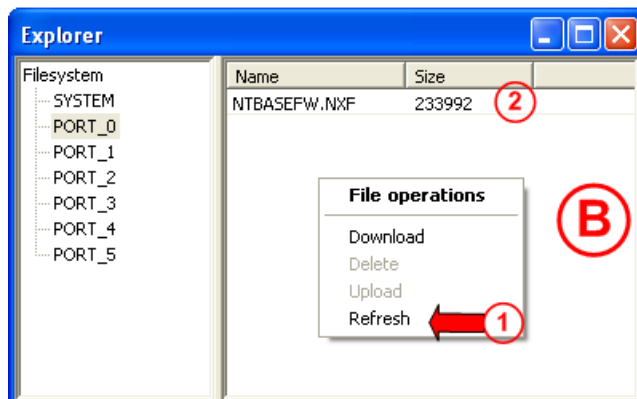

Figure 28: ComProX File Explorer - File Menu 2

- Select **Refresh** ①.
- In case the download was successful ComProX will show the downloaded firmware as shown at ②.
- Close the window above and close the main window of ComProX.
- Remove the power from your device and perform a power cycle.

- ↗ The device will be restarted and the firmware will be started. Now the LED SYS (No. 5 in section *LEDs and Control Elements* on page 33) will be on green and the LED APL (No. 6 in section *LEDs and Control Elements* on page 33) flashes red.

The reset to factory settings has successfully been executed. Now you can access to the device again with the configuration tool SYCON.net via the USB port. From there you can now download the firmware of your choice.

8 Troubleshooting

Two methods for troubleshooting exist:

- The visual analysis of the LED conditions of the device
- The analysis via the USB port along with the configuration tool SYCON.net.

The following overview describes the error conditions that may be detected by a visual check of the LEDs.

To determine the position of the LEDs use the device drawings in section *LEDs and Control Elements* from page 33. The number in the LED state column shows the position of the LED in the device drawing.







LED state	Remedy
No LED is on	The device is not powered or the device has a malfunction and needs replacement
LED 5 flashes   yellow/green at 1 Hz	After a power cycle the device has not found a valid firmware and remains in boot loader mode. The device has to be recovered and set back to factory setting. Follow the chapter <i>Reset Device to Factory Settings</i> on page 53.
LED 5 on  yellow	The device has a malfunction and needs replacement.
LED 5 on  green, LED 6 on  red flashing or red on.	The device is well initialized. Further analysis is possible with the LED 6 APL. Follow the chapter <i>APL LED</i> on page 66.
LED 6 flashing  green	The communication via port X2 or/and port X3 is not in data exchange mode. See chapter <i>APL LED</i> on page 66.

Table 41: NT 100 Troubleshooting

The device is operational just in case the illustrated error conditions do not met. Further protocol specific error diagnostics via the LEDs is possible by reading on the chapter “LED”.

In deep diagnostics is possible at any time via the USB diagnostic port of the device and a PC with the software SYCON.net.

In case of trouble you should make sure that you have downloaded a correct signal mapping to the device via SYCON.net

For some protocols it is necessary to synchronize data via a handshake between the gateway and the superordinated PLC. Please make sure that the handshake mechanism is kept.

8.1 Failure in 10 MBit/s Half Duplex Mode and Workaround

Only older devices of device type NT 100-RE-xx are affected, which have a serial number below 20356.

Device type NT 100-RE-EN is not affected.

Affected Hardware

Hardware with the communication controller netX 50, netX 100 or netX 500; netX/Internal PHYs.

When can this Failure occur?

When using standard Ethernet communication with 10 MBit/s half duplex mode, the PHY gets stuck in case of network collisions. Then no further network communication is possible. Only device power cycling allows Ethernet communication again.

This problem can only occur with Ethernet TCP/UDP IP, EtherNet/IP or Modbus TCP protocols when using hubs at 10 MBit/s. The issue described above is not applicable for protocols which use 100 MBit/s or full duplex mode.

Solution / Workaround:

Do not use 10 MBit/s-only hubs. Use either switches or 10/100 MBit/s Dual Speed hubs, to make sure the netX Ethernet ports are connected with 100 MBit/s or in full duplex mode.

This erratum is fixed with all components of the 'Y' charge (9 digit charge number shows 'Y' at position 5 (nnnnYnnnn)).

Reference

"Summary of 10BT problem on EthernetPHY",
RenesasElectronics Europe, April 27, 2010

9 LED

9.1 SYS LED

This LED indicates important operating states (without configuration of the device).







LED	Color	State	Meaning
SYS Number in the device drawing 	Duo LED yellow/green		
	 (green)	On	Operating System running. further diagnostic see APL LED.
	 (yellow)	static	Firmware and configuration files are loaded. The duration of this state depends from the size of the firmware and configuration files. This can take one minute and longer. Remains the LED with yellow permanently, then a hardware failure is possible.
	 (yellow)	Flashing	The device doesn't work. In the USB cable attached to the device has pin 4 connected with ground.
			➤ Remove the USB cable from the device. Disconnect the power supply to the device. Reconnect the power supply to the device. After some seconds reconnect the USB cable to the device.
			↻ The device is working.
	 (yellow / green)	Flashing yellow/green 1 Hz	Error state! Boot loader active. No STARTUP.INI files was found. No communication via USB with SYCON.net is possible. A memory card with the files for factory setting on it is necessary to make the device operational. Ho to create an appropriate memory card see section " Reset Device to Factory Settings " on page 53.
	 (yellow / green)	Flashing yellow/green 16 Hz	Waiting period (appr. 8 sec, adjustable) before copying the firmware and configuration files from the memory card into the Flash memory.
 (off)	Off	Power supply for the device is missing or hardware failure.	

Table 42: System LED

To determine the position of the LEDs use the device drawings in section *LEDs and Control Elements* from page 33.

9.2 APL LED

This LED indicates the communication state for X2 and X3 as well as the configuration state.







LED	Color	State	Meaning
APL number in the device drawing ⑥	Duo LED green/read		
	 (green)	On	The communication on X2 and X3 is in cyclic data exchange and the gateway function is executed
	 (green)	Blinking with 2 s off, 0,5 s on	netTAP is initialized, but the communication on X2 is not in cyclic data exchange.
	 (green)	Blinking with 2 s off, 0,5 s on, 0,5 s off, 0,5 s on,	netTAP is initialized, but the communication on X3 is not in cyclic data exchange.
	 (red)	Blinking with 2 s off, 0,5 s on	netTAP is initialized, but the configuration for the communication protocol on X2 is missing or has an error
	 (red)	Blinking with 2 s off, 0,5 s on, 0,5 s off, 0,5 s on,	netTAP is initialized, but the configuration for the communication protocol on X3 is missing or has an error
 (red)	On	netTAP has detected an error during the initialization: Missing configuration, error in configuration or internal error	

Table 1: LED APL

To determine the position of the LEDs use the device drawings in section *LEDs and Control Elements* from page 33.

9.3 LED Real Time Ethernet Systems

9.3.1 LED EtherCAT Master

The subsequent table describes the meaning of the LEDs for the Real-Time Ethernet device when the firmware of the EtherCAT Master protocol is loaded to the device.











LED	Color	State	Meaning
RUN Name in the device drawing: 	Duo LED red/green		
	 (off)	Off	INIT : The device is in state INIT
	 (green)	Blinking	PRE-OPERATIONAL : The device is in PRE-OPERATIONAL state
	 (green)	Flickering	BOOT : Device is in Boot mode
	 (green)	Single Flash	SAFE-OPERATIONAL : The device is in SAFE-OPERATIONAL state
ERR Name in the device drawing: 	Duo LED red/green		
	 (red)	On	Master has detected a communication error. The error is indicated in the DPM
LINK RJ45 Ch0 	LED green		
	 (green)	On	A link is established
ACT RJ45 Ch0 	LED yellow		
	 (yellow)	Flashing	The device sends/receives Ethernet frames

Table 43: LEDs EtherCAT Master

LED State Definition for EtherCAT Master for the RUN and ERR LEDs

Indicator state	Definition
On	The indicator is constantly on.
Off	The indicator is constantly off.
Blinking	The indicator turns on and off with a frequency of 2,5 Hz: on for 200 ms, followed by off for 200 ms.
Flickering	The indicator turns on and off with a frequency of approximately 10 Hz: on for approximately 50 ms, followed by off for 50 ms.
Single Flash	The indicator shows one short flash (200 ms) followed by a long off phase (1,000 ms).
Double Flash	The indicator shows a sequence of two short flashes (each 200 ms), separated by a short off phase (200 ms). The sequence is finished by a long off phase (1,000 ms).

Table 44: LED State Definition for EtherCAT Master for the RUN and ERR LEDs

To determine the position of the LEDs use the device drawings in section *LEDs and Control Elements* from page 33.

9.3.2 LED EtherCAT Slave

The subsequent table describes the meaning of the LEDs for the Real-Time Ethernet device when the firmware of the EtherCAT Slave protocol is loaded to the device.













LED	Color	State	Meaning
RUN Number in the device drawing: ⑦	Duo LED red/green		
	 (off)	Off	INIT: The device is in state INIT
	 (green)	Blinking	PRE-OPERATIONAL: The device is in state PRE-OPERATIONAL
	 (green)	Single Flash	SAFE-OPERATIONAL: The device is in state SAFE-OPERATIONAL
	 (green)	On	OPERATIONAL: The device is in state OPERATIONAL
ERR Number in the device drawing: ⑧	Duo LED red/green		
	 (off)	Off	No error: The EtherCAT communication of the device is in working condition
	 (red)	Blinking	Invalid Configuration: General Configuration Error (Example: State change commanded by master is impossible due to register or object settings.)
	 (red)	Single Flash	Unsolicited State Change: Slave device application has changed the EtherCAT state autonomously: Parameter "Change" in the AL status register is set to 0x01:change/error (Example: Synchronization Error, device enters Safe-Operational automatically.)
	 (red)	Double Flash	Application Watchdog Timeout: An application watchdog timeout has occurred. (Example: Sync Manager Watchdog timeout)
	 (red)	On	PDI Watchdog Timeout: A PDI Watchdog timeout has occurred (Example: Application controller is not responding any more)
L/A IN RJ45 Ch0 ⑮	LED green		
	 (green)	On	A link is established
	 (green)	Flashing	The device sends/receives Ethernet frames
L/A OUT RJ45 Ch1 ⑰	 (off)	Off	No link established
RJ45 Ch0 ⑯ RJ45 Ch1 ⑱	LED yellow		
	 (yellow)	-	This LED is not used.

Table 45: LEDs EtherCAT Slave

LED State Definition for EtherCAT Slave for the LEDs RUN ⁷ and ERR LED ⁸

Indicator state	Definition
On	The indicator is constantly on.
Off	The indicator is constantly off.
Blinking	The indicator turns on and off with a frequency of 2,5 Hz: on for 200 ms, followed by off for 200 ms.
Single Flash	The indicator shows one short flash (200 ms) followed by a long off phase (1,000 ms).
Double Flash	The indicator shows a sequence of two short flashes (each 200 ms), separated by a short off phase (200 ms). The sequence is finished by a long off phase (1,000 ms).

Table 46: LED State Definition for EtherCAT Slave for the RUN and ERR LEDs

To determine the position of the LEDs use the device drawings in section *LEDs and Control Elements* from page 33.

9.3.3 LED EtherNet/IP Scanner (Master)

The subsequent table describes the meaning of the LEDs for the Real-Time Ethernet device when the firmware of the EtherNet/IP Scanner (Master) protocol is loaded to the device.





















LED	Color	State	Meaning
MS Number in the device drawing: 	Duo LED red/green		
	 (green)	On	Device operational: If the device is operating correctly, the module status indicator shall be steady green.
	 (green)	Flashing	Standby: If the device has not been configured, the module status indicator shall be flashing green.
	 (red)	On	Major fault: If the device has detected a non-recoverable major fault, the module status indicator shall be steady red.
	 (red)	Flashing	Minor fault: If the device has detected a recoverable minor fault, the module status indicator shall be flashing red. NOTE: An incorrect or inconsistent configuration would be considered a minor fault.
	 (red/green)	Flashing	Self-test: While the device is performing its power up testing, the module status indicator shall be flashing green/red.
	 (off)	Off	No power: If no power is supplied to the device, the module status indicator shall be steady off.
NS Number in the device drawing: 	Duo LED red/green		
	 (green)	On	Connected: If the device has at least one established connection (even to the Message Router), the network status indicator shall be steady green.
	 (green)	Flashing	No connections: If the device has no established connections, but has obtained an IP address, the network status indicator shall be flashing green.
	 (red)	On	Duplicate IP: If the device has detected that its IP address is already in use, the network status indicator shall be steady red.
	 (red)	Flashing	Connection timeout: If one or more of the connections in which this device is the target has timed out, the network status indicator shall be flashing red. This shall be left only if all timed out connections are reestablished or if the device is reset.
	 (red/green)	Flashing	Self-test: While the device is performing its power up testing, the network status indicator shall be flashing green/red.
	 (off)	Off	Not powered, no IP address: If the device does not have an IP address (or is powered off), the network status indicator shall be steady off.
LINK/RJ45 Ch0 & Ch1  & 	LED green		
	 (green)	On	A connection to the Ethernet exists
	 (off)	Off	The device has no connection to the Ethernet
ACT/RJ45 Ch0 & Ch1  & 	LED yellow		
	 (yellow)	Flashing	The device sends/receives Ethernet frames

Table 47: LEDs EtherNet/IP Scanner (Master)

To determine the position of the LEDs use the device drawings in section *LEDs and Control Elements* from page 33.

9.3.4 LED EtherNet/IP Adapter (Slave)

9.3.4.1 LED EtherNet/IP Adapter (Slave) at X2

LED signal, if EtherNet/IP Adapter is used at X2.

The subsequent table describes the meaning of the LEDs for the Real-Time Ethernet device when the firmware of the EtherNet/IP Adapter (Slave) protocol is loaded to the device.















LED	Color	State	Meaning
MS Number in the device drawing: 7	Duo LED red/green		
	 (green)	On	Device operational: If the device is operating correctly, the module status indicator shall be steady green.
	 (green)	Flashing	Standby: If the device has not been configured, the module status indicator shall be flashing green.
	 (red)	On	Major fault: If the device has detected a non-recoverable major fault, the module status indicator shall be steady red.
	 (red)	Flashing	Minor fault: If the device has detected a recoverable minor fault, the module status indicator shall be flashing red. NOTE: An incorrect or inconsistent configuration would be considered a minor fault.
	 (red/green)	Flashing	Self-test: While the device is performing its power up testing, the module status indicator shall be flashing green/red.
	 (off)	Off	No power: If no power is supplied to the device, the module status indicator shall be steady off.
NS Number in the device drawing: 8	Duo LED red/green		
	 (green)	On	Connected: If the device has at least one established connection (even to the Message Router), the network status indicator shall be steady green.
	 (green)	Flashing	No connections: If the device has no established connections, but has obtained an IP address, the network status indicator shall be flashing green.
	 (red)	On	Duplicate IP: If the device has detected that its IP address is already in use, the network status indicator shall be steady red.
	 (red)	Flashing	Connection timeout: If one or more of the connections in which this device is the target has timed out, the network status indicator shall be flashing red. This shall be left only if all timed out connections are reestablished or if the device is reset.
	 (red/green)	Flashing	Self-test: While the device is performing its power up testing, the network status indicator shall be flashing green/red.
	 (off)	Off	Not powered, no IP address: If the device does not have an IP address (or is powered off), the network status indicator shall be steady off.
LINK/RJ45 Ch0 & Ch1 15 & 17	LED green		
	 (green)	On	A connection to the Ethernet exists
	 (off)	Off	The device has no connection to the Ethernet
ACT/RJ45 Ch0 & Ch1 16 & 18	LED yellow		
	 (yellow)	Flashing	The device sends/receives Ethernet frames

Table 48: LEDs EtherNet/IP Adapter (Slave)

To determine the position of the LEDs use the device drawings in section *LEDs and Control Elements* from page 33.

9.3.4.2 LED EtherNet/IP Adapter (Slave) at X3

LED signal, if EtherNet/IP Adapter is used at X3.

The subsequent table describes the meaning of the LEDs for the Real-Time Ethernet device when the firmware of the EtherNet/IP Adapter (Slave) protocol is loaded to the device.









LED	Color	State	Meaning
NS Number in the device drawing: 13	Duo LED red/green		
	 (green)	On	Connected: If the device has at least one established connection (even to the Message Router), the network status indicator shall be steady green.
	 (green)	Flashing	No connections: If the device has no established connections, but has obtained an IP address, the network status indicator shall be flashing green.
	 (red)	On	Duplicate IP: If the device has detected that its IP address is already in use, the network status indicator shall be steady red.
	 (red)	Flashing	Connection timeout: If one or more of the connections in which this device is the target has timed out, the network status indicator shall be flashing red. This shall be left only if all timed out connections are reestablished or if the device is reset.
	 (red/green)	Flashing	Self-test: While the device is performing its power up testing, the network status indicator shall be flashing green/red.
	 (off)	Off	Not powered, no IP address: If the device does not have an IP address (or is powered off), the network status indicator shall be steady off.
LINK/RJ45 19	LED green		
	 (green)	On	A connection to the Ethernet exists
	 (off)	Off	The device has no connection to the Ethernet
ACT/RJ45 20	LED yellow		
	 (yellow)	Flashing	The device sends/receives Ethernet frames

Table 49: LEDs EtherNet/IP Adapter (Slave)

To determine the position of the LEDs use the device drawings in section *LEDs and Control Elements* from page 33.

9.3.5 LED Open Modbus/TCP

9.3.5.1 LED Open Modbus/TCP at X2

LED signals, if Open Modbus/TCP is used at X2.

The subsequent table describes the meaning of the LEDs for the Real-Time Ethernet device when the firmware of the Open Modbus/TCP protocol is loaded to the device.

















LED	Color	State	Meaning
RUN Number in the device drawing: 	Duo LED red/green		
	 (off)	Off	Not Ready OMB task is not ready
	 (green)	Flashing cyclic with 1Hz	Ready, not configured yet OMB task is ready and not configured yet
	 (green)	Flashing cyclic with 5Hz	Waiting for Communication: OMB task is configured
	 (green)	On	Connected: OMB task has communication – at least one TCP connection is established
ERR Number in the device drawing: 	Duo LED red/green		
	 (off)	Off	No communication error
	 (red)	Flashing cyclic with 2Hz (On/Off Ratio = 25 %)	System error
	 (red)	On	Communication error active
LINK/RJ45 Ch0 & Ch1  & 	LED green		
	 (green)	On	A connection to the Ethernet exists
	 (off)	Off	The device has no connection to the Ethernet
ACT/RJ45 Ch0 & Ch1  & 	LED yellow		
 (yellow)	Flashing	The device sends/receives Ethernet frames	

Table 50: LEDs Open Modbus/TCP

To determine the position of the LEDs use the device drawings in section *LEDs and Control Elements* from page 33.

9.3.5.2 LED Open Modbus/TCP at X3

LED signals, if Open Modbus/TCP is used at X3.

The subsequent table describes the meaning of the LEDs for the Real-Time Ethernet device when the firmware of the Open Modbus/TCP protocol is loaded to the device.









LED	Color	State	Meaning
RUN/ERR Number in the device drawing: 13	Duo LED red/green		
	 (off)	Off	Not Ready OMB task is not ready
	 (green)	Flashing cyclic with 1Hz	Ready, not configured yet OMB task is ready and not configured yet
	 (green)	Flashing cyclic with 5Hz	Waiting for Communication: OMB task is configured
	 (green)	On	Connected: OMB task has communication – at least one TCP connection is established
	 (red)	Flashing cyclic with 2Hz (On/Off Ratio = 25 %)	System error
LINK/RJ45 19	LED green		
	 (green)	On	A connection to the Ethernet exists
	 (off)	Off	The device has no connection to the Ethernet
ACT/RJ45 20	LED yellow		
	 (yellow)	Flashing	The device sends/receives Ethernet frames

Table 51: LEDs Open Modbus/TCP

To determine the position of the LEDs use the device drawings in section *LEDs and Control Elements* from page 33.

9.3.6 LED POWERLINK Controlled Node/Slave

The subsequent table describes the meaning of the LEDs for the Real-Time Ethernet device when the firmware of the Powerlink Controlled Node/Slave protocol is loaded to the device.







LED	Color	State	Meaning
BS Number in the device drawing: 7	Duo LED red/green		
	 (off)	Off	Slave initializing
	 (green)	Flickering	Slave is in Basic Ethernet state
		Single Flash	Slave is in Pre-Operational 1
		Double Flash	Slave is in Pre-Operational 2
		Triple Flash	Slave is in ReadyToOperate
		On	Slave is Operational
		Blinking	Slave is Stopped
BE Number in the device drawing: 8	Duo LED red/green		
	 (off)	Off	Slave has no error
	 (red)	On	Slave has detected an error
L/A/RJ45 Ch0 & Ch1 15 & 17	LED green		
	 (green)	On	Link: A connection to the Ethernet exists
	 (green)	Flashing	Activity: The device sends/receives Ethernet frames
	 (off)	Off	The device has no connection to the Ethernet
RJ45 Ch0 & Ch1 16 & 18	LED yellow		
	-	-	This LED is not used.

Table 52: LEDs Powerlink Controlled Node/Slave

LED State Definition for Powerlink Controlled Node/Slave for the BS/BE LEDs

Indicator state	Definition
On	The indicator is constantly on.
Off	The indicator is constantly off.
Blinking	The indicator turns on and off with a frequency of approximately 2,5 Hz: on for approximately 200 ms, followed by off for 200 ms. Red and green LEDs shall be on alternately.
Flickering	The indicator turns on and off with a frequency of approximately 10 Hz: on for approximately 50 ms, followed by off for 50 ms. Red and green LEDs shall be on alternately.
Single Flash	The indicator shows one short flash (approximately 200 ms) followed by a long off phase (approximately 1,000 ms).
Double Flash	The indicator shows a sequence of two short flashes (each approximately 200 ms), separated by a short off phase (approximately 200 ms). The sequence is finished by a long off phase (approximately 1,000 ms).
Triple Flash	The indicator shows a sequence of three short flashes (each approximately 200 ms), separated by a short off phase (approximately 200 ms). The sequence is finished by a long off phase (approximately 1,000 ms).

Table 53: LED State Definition for Powerlink Controlled Node/Slave for the BS/BE LEDs

To determine the position of the LEDs use the device drawings in section *LEDs and Control Elements* from page 33.

9.3.7 LED PROFINET IO RT Controller

The subsequent table describes the meaning of the LEDs for the Real-Time Ethernet device when the firmware of the PROFINET IO-RT Controller protocol is loaded to the device.









LED	Color	State	Meaning
SF Name in the device drawing: 7	Duo LED red/green		
	 (red)	On	<i>(together with BF „red ON“)</i> No valid Master license
	 (red)	Flashing cyclic at 2 Hz	System error: Invalid configuration, Watchdog error or internal error
	 (off)	Off	No error
BF Name in the device drawing: 8	Duo LED red/green		
	 (red)	On	No Connection: No Link. <i>or (together with SF „red ON“)</i> No valid Master license
	 (red)	Flashing cyclic at 2 Hz	Configuration fault: not all configured IO-Devices are connected.
	 (off)	Off	No error
LINK RJ45 Ch0 & Ch1 15 & 17	LED green		
	 (green)	On	A connection to the Ethernet exists
	 (off)	Off	The device has no connection to the Ethernet
RX/TX RJ45 Ch0 & Ch1 16 & 18	LED yellow		
	 (yellow)	Flashing	The device sends/receives Ethernet frames

Table 54: LEDs PROFINET IO-RT Controller

9.3.8 LED PROFINET IO-RT-Device

The subsequent table describes the meaning of the LEDs for the Real-Time Ethernet device when the firmware of the PROFINET IO-RT-Device protocol is loaded to the device.









LED	Color	State	Meaning
SF Number in the device drawing: 7	Duo LED red/green		
	 (red)	On	Watchdog timeout; channel, generic or extended diagnosis present; system error
	 (red)	Flashing cyclic at 2 Hz (for 3 sec.)	DCP signal service is initiated via the bus
	 (off)	Off	No error
BF Number in the device drawing: 8	Duo LED red/green		
	 (red)	On	No configuration; or low speed physical link; or no physical link
	 (red)	Flashing cyclic at 2 Hz	No data exchange
	 (off)	Off	No error
LINK/RJ45 Ch0 & Ch1 15 & 17	LED green		
	 (green)	On	A connection to the Ethernet exists
	 (off)	Off	The device has no connection to the Ethernet
RX/TX/RJ45 Ch0 & Ch1 16 & 18	LED yellow		
	 (yellow)	Flashing	The device sends/receives Ethernet frames

Table 55: LEDs PROFINET IO-RT-Device

To determine the position of the LEDs use the device drawings in section *LEDs and Control Elements* from page 33.

9.3.9 LED sercos Master

The subsequent table describes the meaning of the LEDs for the Real-Time Ethernet device when the firmware of the sercos Master protocol is loaded to the device.

















LED	Color	State	Meaning
S3 (STA) Name in the device drawing: 7	Duo LED red/green		
	 (green)	Blinking	CP0: Communication phase 0
	 (green)	Flickering	Master isn't configured and is in NRT. After a status change this isn't indicated again
	 (green)	Single Flash	CP1: Communication phase 1
	 (green)	Double Flash	CP2: Communication phase 2
	 (green)	Triple Flash	CP3: Communication phase 3
	 (green)	On	CP4: Communication phase 4
	 (off)	Off	NRT: Non Real-time Mode
	 (red)	Blinking	Error in the configuration database.
	 (red)	Flickering	Boot-up was stopped due to an error.
	 (red)	Single Flickering	Channel Init was executed at the Master.
	 (red)	Quadruple Flash	No Master license present in the device
	 (red)	Triple Flash	DPM Watchdog has expired.
	 (red)	Double Flash	Internal Stop of the bus cycle
 (red)	Single Flash	Bus Sync Error Threshold	
Name in the device drawing: 8	Duo LED red/green		
	-	-	This LED is not used.
L/A RJ45 Ch0 & Ch1 15 & 17	LED green		
	 (green)	On	Link: A connection to the Ethernet exists
	 (green)	Flashing	Activity: The device sends/receives Ethernet frames
	 (off)	Off	The device has no connection to the Ethernet
RJ45 Ch0 & Ch1 16 & 18	LED yellow		
	-	-	This LED is not used.

Table 56: LEDs sercos Master

LED State Definition for sercos Master for the S3 (STA) ⁷ and ERR LEDs ⁸

Indicator state	Definition
Off	The indicator is constantly off.
Blinking	The indicator turns on and off with a frequency of 2,5 Hz: on for 200 ms, followed by off for 200 ms.
Single Flickering	The indicator turns on and off with a frequency of approximately 10 Hz: on for approximately 50 ms, followed by off for 50 ms.
Flickering	The indicator turns on and off once: on for approximately 50 ms, followed by off for 50 ms.
Single Flash	The indicator shows one short flash (200 ms) followed by a long off phase (1,000 ms).
Double Flash	The indicator shows a sequence of two short flashes (each 200 ms), separated by a short off phase (200 ms). The sequence is finished by a long off phase (1,000 ms).
Triple Flash	The indicator shows a sequence of three short flashes (each 200 ms), separated by a short off phase (200 ms). The sequence is finished by a long off phase (1,000 ms).
Quadruple Flash	The indicator shows a sequence of four short flashes (each 200 ms), separated by a short off phase (200 ms). The sequence is finished by a long off phase (1,000 ms).

Table 57: LED State Definition for sercos Master for the STA and ERR LEDs

To determine the position of the LEDs use the device drawings in section *LEDs and Control Elements* from page 33.

9.3.10 LED sercos Slave

The subsequent table describes the meaning of the LEDs for the Real-Time Ethernet device when the firmware of the sercos Slave protocol is loaded to the device.











LED	Color	State	Meaning
S3 (STA) Name in the device drawing: 7	Duo LED red/green/orange (orange = red/green simultaneously)		
	 (green)	On	CP4: Communication phase 4, Normal operation, no error
	 (green)	Flashing (4 Hz)	Loopback: The network state has changed from „fast-forward“ to „loopback“.
	 (red/ green)	Flashing (4 Hz), <i>The LED flashes at least for 2 seconds from red to green.</i>	Communication Error: Depends on IDN S-0-1003 (for details refer to <i>sercos Slave Protocol API.pdf</i> on the product DVD). Shows how long the Master may in the communication phases CP3 and CP4 not received Master SYNC telegrams.
	 (red)	On	SIII C1D: Error detected according to sercos third generation Cass 1 Diagnosis.
	 (orange)	On	CP0 ... CP3: Communication phase 0 to Communication phase 3
	 (orange)	Flashing (4 Hz)	Identification: Bit 15 in the Slave device control that indicates remote address allocation or configuration errors between Master and Slaves (for details refer to <i>sercos Slave Protocol API.pdf</i> on the product CD oder DVD).
 (off)	Off	No sercos Communication	
Name in the device drawing: 8	Duo LED red/green		
	-	-	This LED is not used.
L/A/RJ45 Ch0 & Ch1 15 & 17	LED green		
	 (green)	On	Link: A connection to the Ethernet exists
	 (green)	Flashing	Activity: The device sends/receives Ethernet frames
 (off)	Off	The device has no connection to the Ethernet	
RJ45 Ch0 & Ch1 16 & 18	LED yellow		
	-	-	This LED is not used.

Table 58: LEDs sercos Slave

LED State Definition for sercos Slave for the S3 LED (STA-LED) 7

Indicator state	Definition
On	The indicator is constantly on.
Off	The indicator is constantly off.
Flashing (4 Hz)	The indicator turns on and off with a frequency of 4 Hz: on for appr. 125 ms, followed by off for appr. 125 ms.

Table 59: LED State Definition for sercos Slave for the S3 LED (STA LED)

To determine the position of the LEDs use the device drawings in section *LEDs and Control Elements* from page 33.

9.4 LED Fieldbus Systems

9.4.1 LED CANopen Master

The subsequent table describes the meaning of the LEDs for the device when the firmware of the CANopen Master protocol is loaded to the device.







LED	Color	State	Meaning
Communication LED			
CAN ⑦ with protocol at X2, ⑬ with protocol at X3	Duo LED red/green		
	 (off)	Off	RESET: The device is executing a reset
	 (green)	Single flash	STOPPED: The device is in STOPPED state
	 (green)	Blinking	PREOPERATIONAL: The device is in the PREOPERATIONAL state
	 (green)	On	OPERATIONAL: The device is in the OPERATIONAL state
	 (red)	Single flash	Warning Limit reached: At least one of the error counters of the CAN controller has reached or exceeded the warning level (too many error frames).
	 (red)	Double flash	Error Control Event: A guard event (NMT Slave or NMT-master) or a heartbeat event (Heartbeat consumer) has occurred.
 (red)	On	Bus Off: The CAN controller is bus off	

Table 60: LEDs CANopen Master – 1 Communication LED (current Hardware Revision)

LED State Definition for CANopen Master for the CAN LED ⑦ with protocol at X2 respectively ⑬ with protocol at X3

Indicator state	Definition
On	The indicator is constantly on.
Off	The indicator is constantly off.
Flickering	The indicator turns on and off with a frequency of 10 Hz: on for 50 ms, followed by off for 50 ms.
Blinking	The indicator turns on and off with a frequency of 2,5 Hz: on for 200 ms, followed by off for 200 ms.
Single Flash	The indicator shows one short flash (200 ms) followed by a long off phase (1,000 ms).
Double Flash	The indicator shows a sequence of two short flashes (each 200 ms), separated by a short off phase (200 ms). The sequence is finished by a long off phase (1,000 ms).

Table 61: LED State Definition for CANopen Master for the CAN LED

To determine the position of the LEDs use the device drawings in section *LEDs and Control Elements* from page 33.

9.4.2 LED CANopen Slave

The subsequent table describes the meaning of the LEDs for the device when the firmware of the CANopen Slave protocol is loaded to the device.









LED	Color	State	Meaning
CAN 7 with protocol at X2, 13 with protocol at X3	Duo LED red/green		
	 (off)	Off	RESET: The device is executing a reset
	 (green)	Single flash	STOPPED: The device is in STOPPED state
	 (green)	Blinking	PREOPERATIONAL: The device is in the PREOPERATIONAL state
	 (green)	On	OPERATIONAL: The device is in the OPERATIONAL state
	 (red/green)	Flickering (alternatively red / green)	Auto Baud Rate Detection active: The Device is in the Auto Baud Rate Detection mode
	 (red)	Single flash	Warning Limit reached: At least one of the error counters of the CAN controller has reached or exceeded the warning level (too many error frames).
	 (red)	Double flash	Error Control Event: A guard event (NMT Slave or NMT-master) or a heartbeat event (Heartbeat consumer) has occurred.
 (red)	On	Bus Off: The CAN controller is bus off	

Table 62: LEDs CANopen Slave

LED State Definition for CANopen Slave for the CAN LED 7 with protocol at X2 respectively 13 with protocol at X3

Indicator state	Definition
On	The indicator is constantly on.
Off	The indicator is constantly off.
Flickering	The indicator turns on and off with a frequency of 10 Hz: on for 50 ms, followed by off for 50 ms.
Blinking	The indicator turns on and off with a frequency of 2,5 Hz: on for 200 ms, followed by off for 200 ms.
Single Flash	The indicator shows one short flash (200 ms) followed by a long off phase (1,000 ms).
Double Flash	The indicator shows a sequence of two short flashes (each 200 ms), separated by a short off phase (200 ms). The sequence is finished by a long off phase (1,000 ms).

Table 63: LED State Definition for CANopen Slave for the CAN LED

To determine the position of the LEDs use the device drawings in section *LEDs and Control Elements* from page 33.

9.4.3 LED CC-Link Slave

The subsequent table describes the meaning of the LEDs for the fieldbus device when the firmware of the CC-Link Slave protocol is loaded to the device.





LED	Color	State	Meaning
L RUN L ERR  with protocol at X3	Duo LED red/green		
	 (off)	Off	1. Before participating in the network 2. Unable to detect carrier 3. Timeout 4. Resetting hardware
	 (green)	On	Receive both refresh and polling signals or just the refresh signal normally, after participating in the network.
	 (red)	Blinking	The switch setting has been changed from the setting at the reset cancellation (blinks for 0.4 sec.).
	 (red)	On	1. CRC error 2. Address parameter error (0, 65 or greater is set including the number of occupied stations) 3. Baud rate switch setting error during cancellation of reset (5 or greater)

Table 64: LEDs CC-Link Slave

To determine the position of the LEDs use the device drawings in section *LEDs and Control Elements* from page 33.

9.4.4 LED DeviceNet Master

The subsequent table describes the meaning of the LEDs for the fieldbus device when the firmware of the DeviceNet Master protocol is loaded to the device.







LED	Color	State	Meaning
MNS ⑦ with protocol at X2, ⑬ with protocol at X3	Duo LED red/green		
	 (green)	On	Device is online and has one or more connections in the established state.
	 (green)	Flashing	Device is online and has no connection in the established state.
	 (green/red/off)	Green/Red/Off	Selftest after power on: Green on for 0,25 s, then red on for 0,25 s, then off
	 (red)	Flashing	Connection timeout
	 (red)	On	Critical connection failure; device has detected a network error: duplicate MAC-ID or sever error in CAN network (CAN-bus off)
 (off)	Off	After start of the device and during duplicate MAC-ID check.	

Table 65: LEDs DeviceNet Master

To determine the position of the LEDs use the device drawings in section *LEDs and Control Elements* from page 33.

9.4.5 LED DeviceNet Slave

The subsequent table describes the meaning of the LEDs for the fieldbus device when the firmware of the DeviceNet Slave protocol is loaded to the device.







LED	Color	State	Meaning
MNS ⑦ with protocol at X2, ⑬ with protocol at X3	Duo LED red/green		
	 (green)	On	Device is online and has one or more connections in the established state
	 (green)	Flashing	Device is online and has no connection in the established state
	 (green/red/off)	Green/Red/Off	Selftest after power on: Green on for 0,25 s, then red on for 0,25 s, then off
	 (red)	On	Critical connection failure; device has detected a network error: duplicate MAC-ID or sever error in CAN network (CAN-bus off)
	 (red)	Flashing	Connection timeout
 (off)	Off	After start of the device and during duplicate MAC-ID check	

Table 66: LEDs DeviceNet Slave

To determine the position of the LEDs use the device drawings in section *LEDs and Control Elements* from page 33.

9.4.6 LED PROFIBUS DP Master

The subsequent table describes the meaning of the LED of the device when the firmware of the PROFIBUS DP Master protocol is loaded to the device.





LED	Color	State	Meaning
Communication LED			
COM ⑦ with protocol at X2, ⑬ with protocol at X3	Duo LED red/green		
	 (green)	Flashing acyclic	No configuration or stack error
	 (green)	Flashing cyclic	Profibus is configured, but bus communication is not yet released from the application
	 (green)	On	Communication to all Slaves is established
	 (red)	Flashing cyclic	Communication to at least one Slave is disconnected
	 (red)	On	Communication to one/all Slaves is disconnected

Table 67: LEDs PROFIBUS DP Master

To determine the position of the LEDs use the device drawings in section *LEDs and Control Elements* from page 33.

9.4.7 LED PROFIBUS DP Slave

The subsequent table describes the meaning of the LED for the device when the firmware of the PROFIBUS-DP Slave protocol is loaded to the device.





LED	Color	State	Meaning
COM ⑦ with protocol at X2, ⑬ with protocol at X3.	Duo LED red/green		
	 (green)	On	RUN, cyclic communication.
	 (red)	On	Wrong configuration at PROFIBUS-DPside.
	 (red)	Flashing cyclic	STOP, no communication, connection error.
	 (red)	Flashing acyclic	Not configured.

Table 68: LEDs PROFIBUS DP Slave

To determine the position of the LEDs use the device drawings in section *LEDs and Control Elements* from page 33.

9.5 LEDs Serial

9.5.1 LED Modbus RTU

The subsequent table describes the meaning of the LEDs for the Modbus RTU protocol.



LED	Color	State	Meaning
COM 13	Duo LED red/green		
	 (green)	On	The device has a valid configuration for Modbus RTU and is ready for Modbus communication respectively sends/receives Modbus RTU telegrams
	 (red)	On	Communication error: The device works as Modbus RTU Master : - the slave device answered with a error (Modbus Exception), e. g. functioncode not supported, access to invalid register addresses or coil addresses - receive error detected, e. g. parity error or checksum error - timeout (slave device does not answer) The device works as Modbus RTU Slave : - the Modbus RTU Master device uses an invalid functioncode - the Modbus RTU Master device has accessed an invalid register addresses or coil addresses - receive error detected, e. g. parity error or checksum error - timeout (application does not answer or answers with error) The error display is set back with the next error free Modbus telegram sequence
	 (off)	Off	During initialisation or invalid Modbus RTU configuration or missing power supply

Table 69: LEDs Modbus RTU Protocol

To determine the position of the LEDs use the device drawings in section *LEDs and Control Elements* from page 33.

9.5.2 LED ASCII

The subsequent table describes the meaning of the LEDs for the ASCII protocol.





LED	Color	State	Meaning
COM 13	Duo LED red/green		
	 (green)	Flashing cyclic with 5 Hz	The device sends/receive data
	 (green)	On	The device is ready for serial communication
	 (red)	Flashing cyclic with 5 Hz	The device is configured and is in the state stop
	 (red)	Flashing cyclic with 1 Hz	The device is not configured
 (off)	Off	During initialisation or missing power supply	

Table 70: LEDs ASCII Protocol

To determine the position of the LEDs use the device drawings in section *LEDs and Control Elements* from page 33.

9.5.3 LED Serial with netSCRIPT

The subsequent tables describe the meaning of the LEDs using 'serial with netSCRIPT'.

The meaning of the LED is determined by the device firmware, when the script is not executed. The meaning of the LED is determined by the script, when the script is executed.

Script is not executed

The device firmware does the following steps after the download of the netSCRIPT file into the device:

1. The script file is searched and loaded
2. The script file was loaded successfully. The device firmware now switches the COM LED off.
3. The script file is executed. The script now has the control of the COM LED.





LED	Color	State	Meaning
COM 	Duo LED red/green		
	 (red)	On	netSCRIPT file is searched and loaded
	 (green)	On (for appr. 0,5 s)	netSCRIPT file was loaded successfully
	 (red)	Single Flash The indicator shows one short flash (200 ms) followed by a long off phase (1000 ms).	No script file loaded Script error occurred, which lead to a stop of the script execution The execution of the script was stopped by the debugger. If the red LED changes into this state, then the green LED stays in its last state, e. g. green is on or off.
	 (off)	Off	Script running. The control of the LED states (after the startup sequence) is done with the netSCRIPT functions "setRunLed()" and "setErrorLed()" by the programmer

Table 71: LED serial with netSCRIPT – Script is not executed

Script is executed





LED	Color	State	Meaning
COM 	Duo LED red/green		
	 (green)	Controlled by the script	The meaning is defined by the use of the netSCRIPT function "setRunLed()" in the script
	 (red)	Controlled by the script	The meaning is defined by the use of the netSCRIPT function "setErrorLed()" in the script
	 (off)	Off	The meaning is defined by the use of the netSCRIPT function "setRunLed()" and "setErrorLed()" in the script

Table 72: LED serial with netSCRIPT – Script is executed

To determine the position of the LEDs use the device drawings in section *LEDs and Control Elements* from page 33.

9.5.4 LED 3964R

The subsequent table describes the meaning of the LEDs for the 3964R protocol.







LED	Color	State	Meaning
COM 	Duo LED red/green		
	 (green)	Flashing cyclic with 10 Hz	The device sends/receive data
	 (green)	On	The device is ready for serial communication
	 (red)	On	Communication error: - receive error detected, e. g. parity error or checksum error - timeout (remote device does not answer) The error display is set back with the next error free 3964R telegram sequence
	 (red)	Flashing cyclic with 5 Hz	The device is configured and is in the state stop
	 (red)	Flashing cyclic with 1 Hz	The device is not configured
	 (off)	Off	During initialisation or missing power supply

Table 73: LEDs 3964R Protocol

To determine the position of the LEDs use the device drawings in section *LEDs and Control Elements* from page 33.

10 Technical Data

10.1 Technical Data netTAP NT 100 Gateway

NT 100	Parameter	Value
Communication controller	Type	netX 100
Memory	RAM	8 MB SDRAM
	FLASH	4 MB serial Flash
	Memory card (optional)	Type: SD or MMC card Max. 2 GByte Important: Consider the prerequisite for using SD cards as described in section <i>Prerequisite for Memory Cards</i> on page 51.
	netSCRIPT and Variables	Appr. 1 MByte
Diagnostic Interface	Socket	Mini-USB, 5-pin
Display	LED Display	SYS System Status APL Application Status COM Communication Status LINK Link ACT Activity
Power supply	Voltage	24 V ± 6 V DC with reverse voltage protection
	Current at 24 V (typically)	130 mA
	Power Consumption	3.2 W
	Connector	Mini-COMBICON, 2-pin
	Power supply	For UL compliant usage: Device shall be supplied by an isolated voltage source
Environmental conditions	Temperature range	0 ... + 60 °C
	Humidity	No condensation permitted
	Environment	For UL compliant usage: Device must be used in a pollution degree 2 environment
Device	Dimensions (L x W x H)	100 x 52 x 70 mm (without connector)
	Weight	appr. 150 g
	Mounting	on DIN rail EN 60715
	Protection Class	IP 20
	RoHS	Yes
CE Sign	CE Sign	Yes
	Emission	CISPR 11 Class A
	Immunity	EN 61131-2:2003
UL	UL listed: UL 508	UL-File No E334100
Configuration	Software	SYCON.net

Table 74: Technical Data NT 100 (Part 1)

NT 100	Parameter	Value
Ethernet Interface for the device types: NT 100-RE-CC, NT 100-RE-CO, NT 100-RE-DN, NT 100-RE-DP, NT 100-RE-RS, NT 100-RE-EN.	Transmission rate	100 MBit/s 10 MBit/s (depending on loaded firmware)
	Interface Type	100 BASE-TX, isolated 10 BASE-TX (depending on loaded firmware), isolated
	Half duplex/Full duplex	supported (at 100 MBit/s)
	Auto-Negotiation	supported (depending on loaded firmware)
	Auto-Crossover	supported
	Connector	2 * RJ45, 3 * RJ45 (nur NT 100-RE-EN)
PROFIBUS Interface for the device types: NT 100-xx-DP, NT 100-RE-DP, NT 100-CO-DP NT 100-DN-DP, NT 100-DP-DP, NT 100-DP-CC, NT 100-DP-CO, NT 100-DP- DN, NT 100-DP-RS.	Transmission rate	9,6 kBit/s, 19,2 kBit/s, 31,25 kBit/s, 45,45 kBit/s, 93,75 kBit/s, 187,5 kBit/s, 500 kBit/s, 1,5 MBit/s, 3 MBit/s, 6 MBit/s, 12 MBit/s
	Interface Type	RS 485, optically isolated
	Connector	SubD female, 9-pin
CANopen Interface for the device type: NT 100-RE-CO, NT 100-DN-CO, NT 100-DP-CO, NT 100-CO-CO, NT 100-CO-CC, NT 100-CO-DP, NT 100-CO-DN, NT 100-CO-RS.	Transmission rate	10 kBit/s, 20 kBit/s, 50 kBit/s, 100 kBit/s, 125 kBit/s, 250 kBit/s, 500 kBit/s, 800 kBit/s, 1 MBit/s
	Interface Type	ISO 11898, optically isolated
	Connector	SubD male, 9-pin
DeviceNet Interface for the device type: NT 100-RE-DN, NT 100-DP-DN, NT 100-CO-DN, NT 100-DN-DN NT 100-DN-CO, NT 100-DN-CC, NT 100-DN-DP, NT 100-NN-RS.	Transmission rate	125 kBit/s, 250 kBit/s, 500 kBit/s
	Interface Type	ISO 11898, optically isolated
	Connector	COMBICON, 5-pin

Table 75: Technical Data NT 100 (Part 2)

NT 100	Parameter	Value
CC-Link Interface Version 1 and 2 for the device type: NT 100-RE-CC NT 100-DP-CC, NT 100-CO-CC, NT 100-DN-CC.	Transmission rate	156 kBit/s 625 kBit/s 2500 kBit/s 5 MBit/s 10 MBit/s
	Interface Type	RS-485, galvanically isolated
	Connector	COMBICON, 5-pin
Serial Interface for the device type: NT 100-RE-RS, NT 100-CO-RS, NT 100-DN-RS, NT 100-DP-RS.	Interface Type	RS-232, RS422, RS-485, optically isolated
	Transmission rate ASCII	300 Bit/s 600 Bit/s 1200 Bit/s 2400 Bit/s 4800 Bit/s 9600 Bit/s 19200 Bit/s 38400 Bit/s 57600 Bit/s 115200 Bit/s
	Transmission rate Modbus RTU	4800 Bit/s 9600 Bit/s 19200 Bit/s 38400 Bit/s 57600 Bit/s 115200 Bit/s
	Transmission rate netSCRIPT	Adjustable in the range RS232: 6 ... 460000 Bit/s RS422: 6 ... 1000000 Bit/s RS485: 6 ... 1000000 Bit/s

Table 76: Technical Data NT 100 (Part 3)

10.2 Technical Data of Real-Time Ethernet Communication Protocols

10.2.1 EtherCAT Master

Parameter	Description
Maximum number of EtherCAT slaves	Maximum 200 Slaves
Maximum number of cyclic input data	5760 bytes
Maximum number of cyclic output data	5760 bytes
Minimum bus cycle time	1 ms (fix)
Topology	Line
Baud rate	100 MBit/s
Data transport layer	Ethernet II, IEEE 802.3
Configuration File (ethercat.xml)	Maximum 1 MByte
Limitations	<p>CoE-Upload, CoE-Download for user data transfer not supported</p> <p>The size of the bus configuration file is limited by the size of the RAM Disk (1 Megabyte)</p> <p>Only Ethernet Port 0 of the device is used for communication</p> <p>All CoE Uploads, Downloads and information services must fit in one TLR-Packet. Fragmentation is not supported</p> <p>Support of Distributed clocks (Slave synchronisation) is always activated</p> <p>The bus cycle time is fixed to a value of 1000 µs</p> <p>The watchdog time is fixed to a value of 20 ms</p>
Reference to stack version	V2.4.x.x

Table 77: Technical Data EtherCAT Master Protocol

10.2.2 EtherCAT Slave

Parameter	Description
Maximum number of cyclic input data	200 bytes
Maximum number of cyclic output data	200 bytes
Type	Complex Slave
FMMUs	3 (netX 100/netX 500)
SYNC Manager	4 (netX 100/500)
Baud rate	100 MBit/s
Data transport layer	Ethernet II, IEEE 802.3
Limitation	<p>Acyclic communication not supported</p> <p>LRW is not supported</p>
Reference to stack version	V2.5.x.x

Table 78: Technical Data EtherCAT Slave Protocol

10.2.3 EtherNet/IP Scanner (Master)

Parameter	Description
Maximum number of EtherNet/IP connections	64 connections for implicit
Maximum number of total cyclic input data	5712 bytes
Maximum number of total cyclic output data	5760 bytes
Maximum number of cyclic input data	504 bytes per slave per telegram
Maximum number of cyclic output data	504 bytes per slave per telegram
IO Connection type	Cyclic, minimum 1 ms (depending on used number of connections and used number of input and output data)
UCMM, Class 3	Supported
Predefined standard objects	Identity Object Message Route Object Assembly Object Connection Manager Ethernet Link Object TCP/IP Object
Topology	Tree, Line, Ring
DLR (Device Level Ring)	Beacon based 'Ring Node'
ACD (Address Conflict Detection)	Supported
DHCP	Supported
BOOTP	Supported
Baud rates	10 and 100 MBit/s
Data transport layer	Ethernet II, IEEE 802.3
Integrated switch	Supported
Limitations	No acyclic user data communication CIP Sync Services are not implemented TAGs are not supported
Reference to stack version	V2.4.x.x

Table 79: Technical Data EtherNet/IP Scanner (Master) Protocol

10.2.4 EtherNet/IP Adapter (Slave)

Parameter	Description
Maximum number of input data	504 bytes
Maximum number of output data	504 bytes
IO Connection (implicit)	1 exclusive owner, up to 2 listen only
IO Connection type	Cyclic, minimum 1 ms
UCMM	Supported
Predefined standard objects	Identity Object Message Route Object Assembly Object Connection Manager Ethernet Link Object TCP/IP Object
Topology	Tree, Line, Ring
DLR (Device Level Ring)	Beacon based 'Ring Node'
ACD (Address Conflict Detection)	Supported
DHCP	Supported
BOOTP	Supported
Baud rates	10 and 100 MBit/s
Data transport layer	Ethernet II, IEEE 802.3
Integrated switch	Supported
Limitations	No acyclic user data communication CIP Sync Services are not implemented TAGs are not supported
Reference to firmware/stack version	V2.6.x.x

Table 80: Technical Data EtherNet/IP Adapter (Slave) Protocol

10.2.5 Open Modbus/TCP

Parameter	Description
Maximum number of input data	2880 Registers
Maximum number of output data	2880 Registers
Maximum number of connections	16
Acyclic communication	Read/Write Register: - Max. 125 Registers per Read Telegram (FC 3, 4, 23), - Max. 121 Registers per Write Telegram (FC 23), - Max. 123 Registers per Write Telegram (FC 16) Read/Write Coil: - Max. 2000 Coils per Read Telegram (FC 1, 2), - Max. 1968 Coils per Write Telegram (FC 15)
Modbus Function Codes	1, 2, 3, 4, 5, 6, 7, 15, 16, 23 (Function code 23 in server mode only)
Protocol Mode	Client or Server
Baud rates	10 and 100 MBit/s
Data transport layer	Ethernet II, IEEE 802.3
Reference to stack version	V2.5.x.x

Table 81: Technical Data Open Modbus/TCP Protocol

10.2.6 POWERLINK Controlled Node (Slave)

Parameter	Description
Maximum number of cyclic input data	1490 bytes
Maximum number of cyclic output data	1490 bytes
Baud rate	100 MBit/s, half-duplex
Data transport layer	Ethernet II, IEEE 802.3
Ethernet POWERLINK version	V 2
Limitation	No acyclic communication No slave to slave communication
Reference to stack version	V2.1.x.x

Table 82: Technical Data POWERLINK Controlled Node (Slave) Protocol

10.2.7 PROFINET IO-RT-Controller

Parameter	Description
Maximum number of PROFINET IO Devices	128
Maximum number of total cyclic input data	5712 bytes
Maximum number of total cyclic output data	5760 bytes
Maximum number of cyclic input data	1024 bytes per device (= IOCR data length)
Maximum number of cyclic output data	1024 bytes per device (= IOCR data length)
Supported Protocols	RTC – Real Time Cyclic Protocol, Class 1 RTA – Real Time Acyclic Protocol DCP – Discovery and configuration Protocol CL-RPC – Connectionless Remote Procedure Call
Context management by CL-RPC	Supported
Minimum cycle time	1 ms Different IO-Devices can be configured with different cycle times
Baud rate	100 MBit/s Full-Duplex mode
Data transport layer	Ethernet II, IEEE 802.3
Configuration File	Maximum 1 MByte
Limitations	<p>Read/Write Record not supported</p> <p>No Alarm processing</p> <p>RT over UDP not supported</p> <p>Multicast communication not supported</p> <p>DHCP is not supported</p> <p>Only one IOCR per IO Device</p> <p>NameOfStation of IO Controller CANNOT be set using the DCP SET NameOfStation service but only at start-up while configuring the IO Controller</p> <p>SNMP not supported</p> <p>LLDP not supported</p> <p>The buffer for IO-Device diagnosis data will be overwritten in case of multiple diagnostic events. Only one (the last) event is stored at the same time. If a single event produces more than 200 bytes of diagnosis data, only the first 200 bytes will be taken care of.</p> <p>The usable (minimum) cycle time depends on the number of used IO Devices, the number of used input and output data. The cycle-time, the number of configured IO Devices and the amount of IO data depend on each other. For example it is not possible due to performance reasons to have 128 IO Devices communication with cycle-time 1ms.</p> <p>The size of the bus configuration file is limited by the size of the RAM Disk (1 MByte)</p> <p>Only one API (API = 0) is supported. Any Profile requesting a different API is currently not supported.</p> <p>The IO-Device feature "FastStartUp" can not be used</p> <p>WriteMultiple-Record service is not supported</p>
Reference to stack version	V2.4.x.x

Table 83: Technical Data PROFINET IO RT Controller

10.2.8 PROFINET IO-RT-Device

Parameter	Description
Maximum number of cyclic input data	1024 bytes
Maximum number of cyclic output data	1024 bytes
Supported protocols	RTC – Real Time Cyclic Protocol, Class 1 and 2 (unsynchronized) RTA – Real Time Acyclic Protocol DCP – Discovery and configuration Protocol CL-RPC – Connectionless Remote Procedure Call LLDP – Link Layer Discovery Protocol SNMP – Simple Network Management Protocol
Used Protocols (subset)	UDP, IP, ARP, ICMP (Ping)
Topology recognition	LLDP, SNMP V1, MIB2, physical device
VLAN- and priority tagging	yes
Context Management by CL-RPC	Supported
Minimum cycle time	1 ms for RTC1 and RTC2
Baud rate	100 MBit/s
Data transport layer	Ethernet II, IEEE 802.3
Limitations	No acyclic user data transfer RT over UDP not supported Multicast communication not supported DHCP is not supported RT Class 2 synchronized (IRT “flex”) is not supported RT Class 3 synchronized not supported FastStartUp is not supported. Media Redundancy is not supported Access to the submodule granular status bytes (IOCS) is not supported. The amount of configured IO-data influences the minimum cycle time that can be reached. Supervisor-AR is not supported, Supervisor-DA-AR is supported Only 1 Input-CR and 1 Output-CR are supported Multiple WriteRequests are not supported
Reference to stack version	V3.4.x.x

Table 84: Technical Data PROFINET IO RT Device Protocol

10.2.9 Sercos Master

Parameter	Description
Maximum number of cyclic input data	5760 bytes (including Connection Control per Connection)
Maximum number of cyclic output data	5760 bytes (including Connection Control per Connection)
Maximum number of configured slave devices	511
Minimum cycle time	250 µs
Acyclic communication	Service channel: Read/Write/Commands (for configuration only)
Functions	Bus Scan
Communication phases	NRT, CP0, CP1, CP2, CP3, CP4
Topology	Line and double ring
Redundancy	supported
Baud rate	100 MBit/s, full duplex
Data transport layer	Ethernet II, IEEE 802.3
Auto crossover	supported
Supported sercos version	Communication Specification Version 1.1.1/1.1.2
Limitations	No acyclic user data transfer NRT channel not supported Hot-Plug not supported Cross Communication not supported Ring healing (needed for redundancy) is only available if the Master has a configuration
Reference to stack version	V2.0.x.x

Table 85: Technical Data sercos Master Protocol

10.2.10 Sercos Slave

Parameter	Description
Maximum number of cyclic input data (Tx)	128 bytes (including Connection Control and IO Status)
Maximum number of cyclic output data (Rx)	128 bytes (including Connection Control and IO Control)
Maximum number of slave devices	1
Maximum number of applicable sercos addresses	1 ... 511
Minimum cycle time	250 µs
Topology	Line and ring
Communication phases	NRT, CP0, CP1, CP2, CP3, CP4
Baud rate	100 MBit/s
Data transport layer	Ethernet II, IEEE 802.3
Supported sercos version	sercos in the third generation Communication Specification Version 1.1.2
Supported sercos Communication Profiles	SCP_FixCFG Version 1.1.1 SCP_VarCFG Version 1.1.1 SCP_VarCFG Version 1.1.3
Supported FSP profiles	FSP_IO
SCP_NRTPC support	Yes
S/IP support	Yes
Identification LED feature supported	Yes
Limitations	Max. 2 connections: 1 for consumer and 1 for producer No acyclic user data transfer Modifications of the Service-Channel Object Dictionary will be volatile after reset, if it resides on device Hot plug is not supported Cross communication not supported NRT Channel only forwarding and S/IP
Reference to stack version	V3.1.x.x

Table 86: Technical Data sercos Slave Protocol

10.3 Technical Data Fieldbus Protocols

10.3.1 CANopen Master

Parameter	Description
Maximum number of CANopen nodes	126
Maximum number of cyclic input data	3584 bytes
Maximum number of cyclic output data	3584 bytes
Maximum number of receive PDOs	512
Maximum number of transmit PDOs	512
Exchange of process data	Via PDO transfer: - synchronized, - remotely requested and - event driven (change of date)
Functions	Emergency message (consumer) Node guarding / life guarding, heartbeat PDO mapping NMT Master SYNC protocol (producer) Simple boot-up process, reading object 1000H for identification
Baud rates	10 kBits/s, 20 kBits/s, 50 kBits/s, 100 kBits/s, 125 kBits/s, 250 kBits/s, 500 kBits/s, 800 kBits/s, 1 MBits/s
Data transport layer	CAN Frames
CAN Frame type for CANopen	11 Bit
Limitations	SDO-Upload/Download for user data transfer not supported
Reference to stack version	V2.9.x.x

Table 87: Technical Data CANopen Master Protocol

10.3.2 CANopen Slave

Parameter	Description
Maximum number of cyclic input data	512 bytes Objects 2200, 2201, 2202, 2203 each with up to 128 bytes
Maximum number of cyclic output data	512 bytes Objects 2000, 2001, 2002, 2003 each with up to 128 bytes
Maximum number of receive PDOs	64
Maximum number of transmit PDOs	64
Exchange of process data	Via PDO transfer - synchronized, - remotely requested and - event driven (change of date, event timer)
Functions	Node guarding / life guarding, heartbeat PDO mapping NMT Slave SYNC protocol (consumer) SDO upload/download (server, for configuration) Emergency message (producer)
Baud rates	10 kBits/s, 20 kBits/s, 50 kBits/s, 100 kBits/s, 125 kBits/s, 250 kBits/s, 500 kBits/s, 800 kBits/s, 1 MBits/s Auto baudrate detection is supported
Data transport layer	CAN Frames
CAN Frame type for CANopen	11 Bit
Limitations	Timestamp (producer/consumer) not supported on application level.
Reference to stack version	V3.0.x.x

Table 88: Technical Data CANopen Slave Protocol

Configuration of the node address

The CANopen node address can be configured by SYCON.net or by address switches. The address switches can be activated with SYCON.net version 1.351 (or higher) and can be used with firmware version 1.5 (or higher).

10.3.3 CC-Link Slave

Parameter	Description
Firmware works according to CC-Link Version 2.0:	
Station Types	Remote Device Station (up to 4 occupied stations)
Maximum input data	368 bytes
Maximum output data	368 bytes
Input data remote device station	112 bytes (RY) and 256 bytes (RWw)
Output data remote device station	112 bytes (RX) and 256 bytes (RWr)
Extension cycles	1, 2, 4, 8
Baud rates	156 kBit/s, 625 kBit/s, 2500 kBit/s, 5 MBit/s, 10 MBit/s
Limitation	Intelligent Device Station not supported
Firmware works according to CC-Link Version 1.11:	
Station Types	Remote I/O station, Remote device station' (up to 4 occupied stations)
Maximum input data	48 bytes
Maximum output data	48 bytes
Input data remote I/O station	4 bytes (RY)
Output data remote I/O station	4 bytes (RX)
Input data remote device station	4 bytes (RY) and 8 bytes (RWw) per occupied station
Output data remote device station	4 bytes (RX) and 8 bytes (RWr) per occupied station
Baud rates	156 kBit/s, 625 kBit/s, 2500 kBit/s, 5 MBit/s, 10 MBit/s
Firmware	
Reference to stack version	V2.6.x.x

Table 89: Technical Data CC-Link-Slave Protocol

Configuration of the station number

The CC-Link station number can be configured by SYCON.net or by address switches. The address switches can be activated with SYCON.net version 1.351 (or higher) and can be used with firmware version 1.5 (or higher).

10.3.4 DeviceNet Master

Parameter	Description
Maximum number of DeviceNet slaves	63
Maximum number of total cyclic input data	3584 bytes
Maximum number of total cyclic output data	3584 bytes
Maximum number of cyclic input data	255 bytes/connection
Maximum number of cyclic output data	255 bytes/connection
Maximum configuration data	1000 bytes/slave
Baud rates	125 kBits/s, 250 kBit/s, 500 kBit/s Auto baudrate detection is not supported
Data transport layer	CAN frames
Connections	Bit Strobe Change of State Cyclic Poll Explicit Peer-to-Peer Messaging
Function	Quick Connect
Fragmentation	Explicit and I/O
Function	Proxy for explicit messaging for user communication to all '.group 2 only' slaves
UCMM	Supported
Objects	Identity Object (Class Code 0x01) Message Router Object (Class Code 0x02) DeviceNet Object (Class Code 0x03) Connection Object (Class Code 0x05) Acknowledge Handler Object (Class Code 0x06)
Baud rates	125 kBits/s, 250 kBit/s, 500 kBit/s Auto baudrate detection is not supported
Data transport layer	CAN frames
Limitations	User data transfer through the gateway only via IO connections
Reference to stack version	V2.3.x.x

Table 90: Technical Data DeviceNet Master Protocol

10.3.5 DeviceNet Slave

Parameter	Description
Maximum number of cyclic input data	255 bytes
Maximum number of cyclic output data	255 bytes
Connections	Poll Change-of-state Cyclic Bit-strobe
Fragmentation	Explicit and I/O
UCMM	Not supported
Baud rates	125 kBits/s, 250 kBit/s, 500 kBit/s Auto baudrate detection is not supported
Data transport layer	CAN frames
Limitations	Access to Application Object only via IO connection
Reference to stack version	V2.3.x.x

Table 91: Technical Data DeviceNet Slave Protocol

Configuration of the MAC ID

The DeviceNet MAC ID can be configured by SYCON.net or by address switches. The address switches can be activated with SYCON.net version 1.351 (or higher) and can be used with firmware version 1.5 (or higher).

10.3.6 PROFIBUS DP Master

Parameter	Description
Maximum number of PROFIBUS DP slaves	125
Maximum number of total cyclic input data	5712 bytes
Maximum number of total cyclic output data	5760 bytes
Maximum number of cyclic input data	244 bytes/slave
Maximum number of cyclic output data	244 bytes/slave
Configuration data	Max. 244 bytes per slave
Parameterization data per slave	7 bytes/slave standard parameters Max. 237 bytes/slave application specific parameters
Baud rate	9,6 kBits/s, 19,2 kBits/s, 31,25 kBits/s, 45,45 kBits/s, 93,75 kBits/s, 187,5 kBits/s, 500 kBits/s, 1, 5 MBits/s, 3 MBits/s, 6 MBits/s, 12 MBit/s Auto baud rate detection is not supported
Data transport layer	PROFIBUS FDL
Limitations	DP V1 services class 1 and 2 are not supported DP V2 services are not supported
Reference to stack version	V2.5.x.x

Table 92: Technical Data PROFIBUS DP Master Protocol

10.3.7 PROFIBUS DP Slave

Parameter	Description
Maximum number of cyclic input data	244 bytes
Maximum number of cyclic output data	244 bytes
Maximum number of modules	Max. 4 input modules and max. 4 output modules, max. 24 modules when using manual setting
Baud rate	9,6 kBits/s, 19,2 kBits/s, 31,25 kBits/s, 45,45 kBits/s 93,75 kBits/s, 187,5 kBits/s, 500 kBits/s, 1, 5 MBits/s, 3 MBits/s, 6 MBits/s, 12 MBit/s Auto baudrate detection is supported
Data transport layer	PROFIBUS FDL
Limitations	DP V1 services class 1 and 2 to transfer user data are not supported SSCY1S – Slave to slave communication state machine not implemented Data exchange broadcast not implemented I&M0 with fixed settings only
Reference to firmware/stack version	V2.4.x.x

Table 93: Technical Data PROFIBUS DP Slave Protocol

Configuration of the station address

The PROFIBUS station address can be configured by SYCON.net or by address switches. The address switches can be activated with SYCON.net version 1.351 (or higher) and can be used with firmware version 1.5 (or higher).

10.4 Technical Data Serial Protocols

10.4.1 ASCII

Parameter	Description and Value Range
Maximum telegram length	1024 bytes
Data bits	7, 8 bits
Stop bits	1, 2 bit(s)
Parity	None, even, odd
Baud rate	300 bit/s, 600 bit/s, 1200 bit/s, 2400 bit/s, 4800 bit/s, 9600 bit/s, 19200 bit/s, 38400 bit/s, 57600 bit/s, 115200 bit/s
Duplex	Half-duplex
Flow control	None
Indicator for end of received telegram	On receipt of a fixed number of characters On receipt of termination character(s) Elapse of character delay time
Timing parameter	Response timeout Receive watchdog time Send cycle time Character delay time
Number of send buffers	1
Number of receive buffers	1
Number of transmission retries	1
Maximum number of structure elements of a send telegram	10
Maximum number of structure elements of a receive telegram	10
Structure elements	Start character(s), Device address, Object index or start address, Command identifier, Data area with length information, Data area with termination character(s), End character(s), Checksum, Character(s) without meaning (fix length)
Checksum methods	CRC8, CRC16, CRC32, Exor
Reference to stack version	V1.0.x.x

Table 94: Technical Data ASCII Protocol

10.4.2 Modbus RTU Master/Slave

Parameter	Description and Value Range
Maximum number of input data	2880 Registers
Maximum number of output data	2880 Registers
Acyclic communication	Read/Write Register, Maximum 125 Registers per Read Telegram (FC 3, 4), Maximum 123 Registers per Write Telegram (FC 16), Maximum 118 Registers per Write Telegram (FC 23), Maximum 118 Registers per Read Telegram (FC 23) Read/Write Coil, Maximum 2000 Coils per Read Telegram (FC 1, 2), Maximum 1968 Coils per Write Telegram (FC 15)
Function Codes Modbus Master	1, 2, 3, 4, 5, 6, 15, 16
Function Codes Modbus Slave	1, 2, 3, 4, 5, 6, 7, 8, 15, 16, 23
Mode	Modbus Master or Modbus Slave
Modbus Address	1 ... 247
Baud rates	1200 bit/s, 2400 bit/s, 4800 bit/s, 9600 bit/s, 19200 bit/s, 38400 bit/s, 57600 bit/s, 115200 bit/s
Data bits	8 bits
Stop bits	1, 2 bit(s)
Parity	None, even, odd
Limitations	Broadcast not supported
Reference to stack version	V1.3.x.x

Table 95: Technical Data Modbus RTU Protocol

10.4.3 netSCRIPT (Serial)

Parameter	Description and Value Range
Data bits	1 ... 8 bits
Inversion of data bits	Adjustable
Stop bits	1 ... 65535 bit(s), polarity is adjustable
Start bit	1, polarity is adjustable
Parity	none, even, odd, constant value
Baudrate	Depends on the used hardware interface. See technical data of the device.
Flow control RS-232	None or RTS/CTS handshake Polarity of RTS signal adjustable
Timing Parameter	Response timeout, programmable in script, Character delay time (adjustable) (resolution 10 ns) Receive watchdog time and Send cycle time, programmable in script (resolution script cycle time)
Number of transmission retries	1, retries programmable in script
Maximum number of structure elements of a send telegram	Programmable in script
Maximum number of structure elements of a receive telegram	Programmable in script
Structure elements	Start character(s), Device address, Object index or start address, Command identifier, Data area with length information, Data area with termination character(s), Endcharacter(s), Checksum, Character(s) without meaning All listed and further structure elements are programmable in script
Checksum methods	CRC algorithm configurable (width, polynom, initial value, bit direction of input bytes and result value) XOR and sum function possible
Parameter FIFO Mode	
Maximum telegram length	Only limited by the script processing speed and by the data transfer speed
Duplex	Full-duplex for RS-232, RS-422 Half-duplex for RS-485
End indicator of received telegram	Programmable in script
Number of send buffers	1, with 256 characters
Number of receive buffers	1, with 256 characters
Parameter Block Mode	
Maximum telegram length	1024 bytes
Duplex	Half-duplex
End indicator of received telegram	Free definable end indicator with up to 64 bit and bit by bit AND mask
Number of send and receive buffers	15 ... 240 (15 buffers with 1024 character buffer size, 240 buffers with 1 character buffer size)
Trailer bytes	0 ... 255 bytes
Firmware	
Reference to stack version	V1.3.x.x

Table 96: Technical Data netSCRIPT Serial

10.4.4 3964R

Parameter	Description and Value Range
Maximum Telegram Length	5736 bytes
Data Bits	7, 8 bits
Stop Bits	1, 2 bit(s)
Parity	None, even, odd
Baud Rate	300 bit/s, 600 bit/s, 1200 bit/s, 2400 bit/s, 4800 bit/s, 9600 bit/s, 19200 bit/s, 38400 bit/s, 57600 bit/s, 115200 bit/s
Duplex	Half-duplex
Priority	Adjustable: High or low Priority
Timing Parameter	Acknowledge Timeout Character Delay Time
Number of Send Buffers	1
Number of Receive Buffers	Ring Buffer with 30 buffers (FIFO)
Number of Transmission Retries	Adjustable
Checksum Method	BCC
Reference to stack version	V0.9.x.x

Table 97: Technical Data 3964R Protocol

11 Wiring Instructions

Please note the wiring instructions for the corresponding protocol specifications, otherwise a perfect function of the device is not guaranteed.

Use shielded cables, where the shield at both end should be connect extensively with the potential equalization. Cables for communication should be layed/placed as far away as possible from cables transferring energy, to avoid EMC influence caused by switching operation from cables transferring energy.

11.1 Assembly of D-Sub Connectors

The design of the bus cabling is an essential factor for the proper function of communication. Therefore, special attention should be paid to the cable connections with its connectors. Particularly, ensure good shield connection.

The shield must be connected as follows

1. Dismantle the cable.
2. Pull back the shielding from the cable sheathing.
3. Reduce the shielding that later it is covered by the nozzle.
4. Push a nozzle or shrinking tube over the cable sheathing that at the cable end a zone of 5 to 8 mm remains free.
5. Connect the wire ends with the connector
6. Then push the cable in the plug to the bare braided shield under the strain relief.
7. Fix the strain relief with screws.

The cable connection should look like shown below:

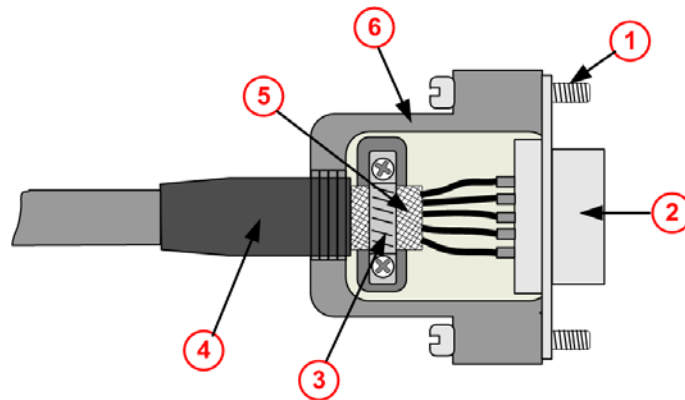

Figure 29: D-Sub Cable Assemblies

- ① Fixing screw UNC.
- ② Metallic plug collar
- ③ Strain relief for connecting the shielding with the connector housing
- ④ Shrinking tube or nozzle to cover the shielding and for bend protection
- ⑤ Cable shielding pulled back over the cable sheathing
- ⑥ Metallic or metallized connector housing

11.2 Ethernet

Use of Hubs and Switches

For the corresponding communication systems, the use of hubs and/or switches is either forbidden or allowed. The following table shows the acceptable use of hubs and switches by each communication system:

Communication System	Hub	Switch
EtherCAT	forbidden	only allowed between EtherCAT Master and first EtherCAT Slave (100 MBit/s, Full Duplex)
EtherNet/IP	allowed	allowed (10 MBit/s/100 MBit/s, Full or Half Duplex, Auto-Negotiation)
Open Modbus/TCP	allowed	allowed (10 MBit/s/100 MBit/s, Full or Half Duplex, Auto-Negotiation)
POWELINK	allowed	forbidden
PROFINET IO RT	forbidden	Only allowed, if the switch supports 'Priority Tagging' and LLDP (100 MBit/s, Full Duplex)
sercos	forbidden	forbidden

Table 98: Use of Hubs and Switches

When using older NT 100-RE-xx devices, then follow:



NOTICE

Failure of the Network Communication

- Do not operate hardware with the communication controllers netX 50, netX100 or netX 500 with the protocols Ethernet TCP/UDP/IP, EtherNet/IP or Modbus TCP at 10 MBit/s in half-duplex mode, otherwise failure of the network communication can occur.
- Use only switches or 10/100 MBit/s dual-speed hubs and ensure that the network operates at 100 MBit/s and in full-duplex mode.

For further information refer to section *Failure in 10 MBit/s Half Duplex Mode and Workaround* on page 64.

11.3 PROFIBUS

Please ensure that termination resistors are available at both ends of the cable. If special PROFIBUS connectors are being used, these resistors are often found inside the connector and must be switched on. For baud rates above 1.5 MBaud use only special connectors, which also include additional inductance.

It is not permitted to have T-stubs on PROFIBUS high baud rates. Use only a special cable which is approved for PROFIBUS-DP. Make a solid connection from the cable shield to ground at every device and make sure that there is no potential difference between the grounds at the devices.

If the Hilscher device is linked with only one other device on the bus, they must be at the ends of the bus line. The reason is that these devices must deliver the power supply for the termination resistors. Otherwise the Master can be connected at any desired position.

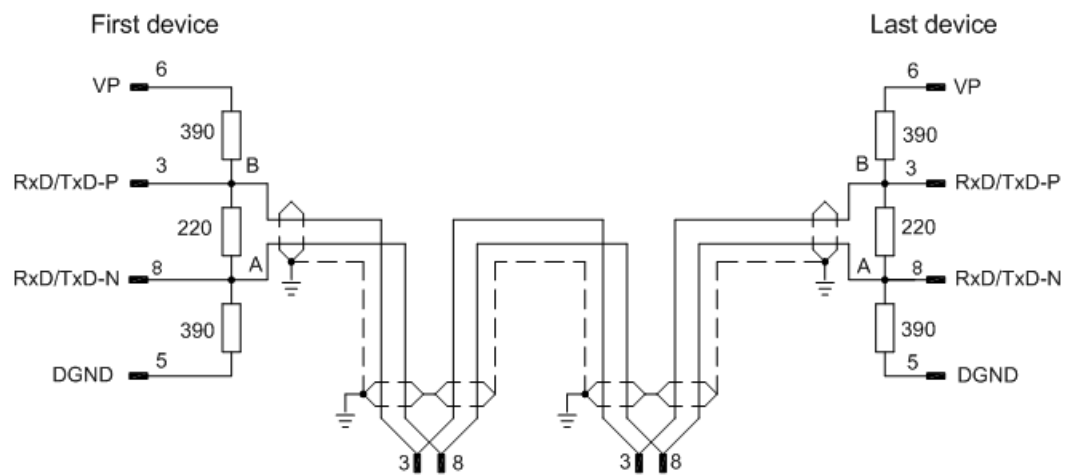

Figure 30: PROFIBUS-DP-Network

Up to 32 PROFIBUS devices can be connected to one bus segment. If several bus segments are linked to each other with repeaters, there can be up to 127 devices on the network.

Only PROFIBUS certified cable, preferably the cable type A, should be used.

The maximum length of a bus segment depends on the baudrate used, see the following table.

Baud rate in kBit/s	Max. distance in m
9,6	1.200
19,2	1.200
93,75	1.200
187,5	1.000
500	400
1.500	200
3.000	100
6.000	100
12.000	100

Table 99: PROFIBUS Segment Length in Dependence of the Baud Rate

The following table contains the most important electrical data concerning PROFIBUS certified cable:

Parameter	Value
Impedance	135... 165 Ω
Capacity	< 30 pF/m
Loop resistance	110 Ω /km
Wire gauge	0,64 mm

Table 100: Characteristics of PROFIBUS certified Cable

11.4 CANopen

Please use only CAN certified cable with the following characteristics:

Parameter	Value
Impedance	120 Ω ± 12 Ω
Capacity per units length	< 50 pF/m

Table 101: Characteristics of CAN certified Cable

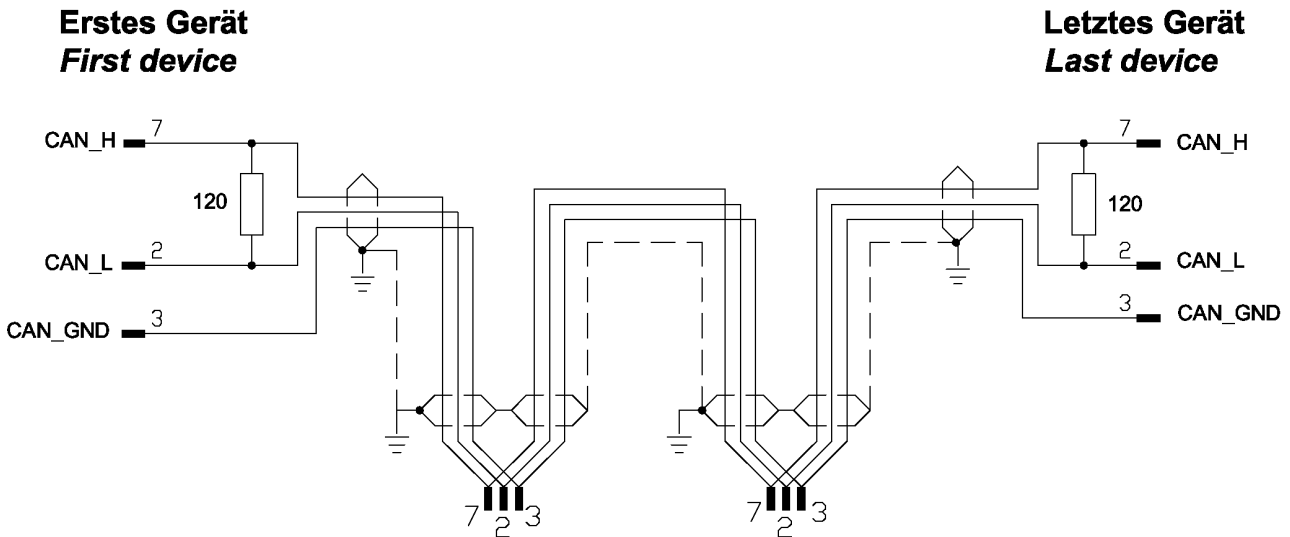

Figure 31: Termination CANopen Network

At the ends of the network there must be two resistors of 120 Ω to terminate the cable. It is allowed to use repeaters to increase the number of nodes, which may be connected, or to increase the maximum cable length.

The CAN segment length in dependence of the Baud rate or corresponding Loop Resistance and Wire Gauge is given in the following table:

Baud rate in kBit/s	Max. distance	Loop Resistance	Wire Gauge
10	1000 m	<26 Ω/km	0,75...0,80 mm ²
20	1000 m	<26 Ω/km	0,75...0,80 mm ²
50	1000 m	<26 Ω/km	0,75...0,80 mm ²
125	500 m	<40 Ω/km	0,50...0,60 mm ²
250	250 m	<40 Ω/km	0,50...0,60 mm ²
500	100 m	<60 Ω/km	0,34...0,60 mm ²
800	50 m	<60 Ω/km	0,34...0,60 mm ²
1.000	30 m	70 Ω/km	0,25...0,34 mm ²

Table 102: CAN Segment Length in dependence of the Baud rate or corresponding Loop Resistance and Wire Gauge

11.5 DeviceNet

Up to 64 DeviceNet devices can be linked together over the bus. The maximum length of the bus cable depends on the used baud rate and the used cable type. Only special proved DeviceNet cable should be used.

The maximum length of the DeviceNet cable depends from the baud rate and from the chosen cable type. In the following table, these are listed in the following table:

Baudrate in kbit/s	Maximum length of cable (thick cable)	Maximum length of cable (thick cable)
125	500 m	100 m
250	250 m	100 m
500	100 m	100 m

Table 103: Maximum length in dependence from the Baud Rate for DeviceNet Cables

The data line cables must match the following conditions:

Data line cable	Impedance	Capacity	Loop Resistance	Wire Gauge (Diameter)
Thick	120 Ohm	<39,4 pf/m	<22,6 Ohm/km	2 * 1.1 mm
Thin	120 Ohm	<39,4 pf/m	<91,8 Ohm/km	2 * 0,6 mm

Table 104 Characteristics of DeviceNet Data Line Cable

The power supply cables must match the following conditions:

Power supply cable	Loop Resistance	Wire Gauge (Diameter)
Thick	<11,8 Ohm/km	2 * 1.4 mm
Thin	<57,4 Ohm/km	2 * 0,7 mm

Table 105: Characteristics of DeviceNet Power Supply Cable

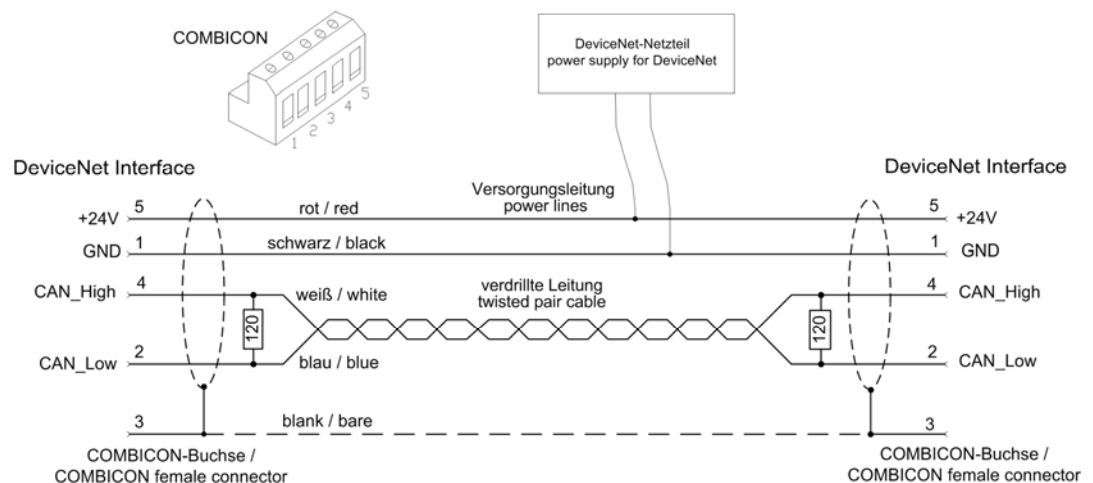

Figure 32: DeviceNet Network

Please ensure that termination resistors with 120 Ohm are available at both ends of the cable.

Further devices can be connected via T-stubs to the bus cable. The maximum length of all T-stubs is 6 m. The whole length of the bus cable and all T-stubs does not exceed the maximum length listed in the following table. There are two different types of cables. If both cables types are used within the same network, the maximum length is:

Max. distance	Baud rate in kBits/s
$L_{\text{thick}} + 5 \times L_{\text{thin}} \leq 500 \text{ m}$	at 125 kBaud
$L_{\text{thick}} + 2,5 \times L_{\text{thin}} \leq 250 \text{ m}$	at 250 kBaud
$L_{\text{thick}} + L_{\text{thin}} \leq 100 \text{ m}$	at 500 kBaud

Table 106: DeviceNet Segment Length in dependence of the Baud rate

The DeviceNet cable contains the data line cables and the power supply cables.

11.6 CC-Link

Use only a special cable which is approved for CC-Link. CC-Link specifies several shielded three-core Twisted Pair cables. It is recommended to use only one type of cable for an installation. Please ensure that termination resistors are available at both ends of the cable. The value of the termination resistor depends on the used type of cable and can be 100, 110 and 130 Ω , respectively.

The following illustration displays the basic network structure.

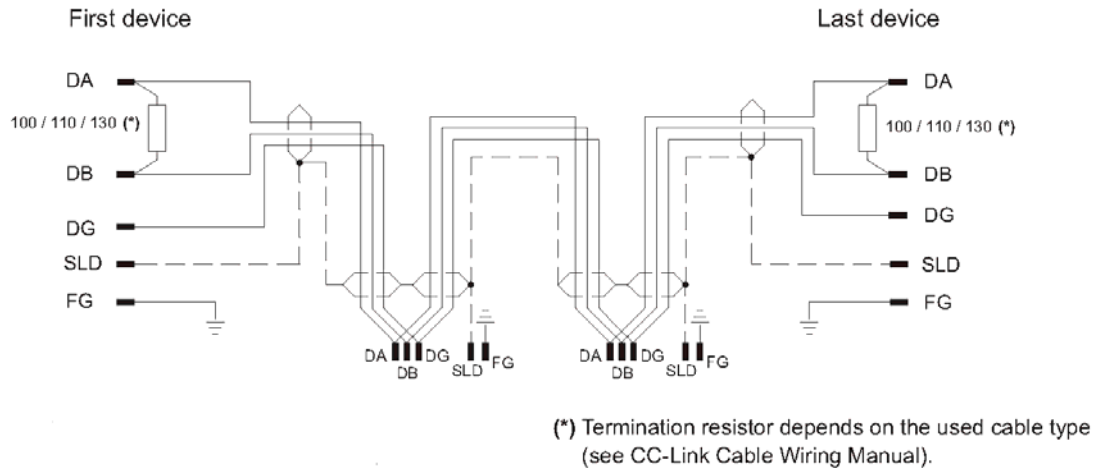

Figure 33: CC-Link Network

(*) The termination resistor depends on the used cable type (see CC-Link Cable Wiring Manual).

The maximum length of one bus segment depends on the used baud rate. The structure of the network can be built up without or with branches. The details listed here are taken from the "CC link Cable Wiring manual" from July 2004. Also further details are contained there. The document is ready for download on <http://www.cc-link.org>.



Note: For CC-Link V2.00 the cable specification V1.10 has not been changed.

Only trunk line, without branches:

Baud rate	max. Length cable V1.00	max. Length cable V1.10 and cable V1.00 with high capacity	max. length high flexible V1.10 (Type 50%)
156 kbps	1200 m	1200 m	600 m
625 kbps	600 m	900 m	450 m
2,5 Mbps	200 m	400 m	200 m
5 Mbps	150 m	160 m	80 m
10 Mbps	100 m	100 m	50 m

Table 107: Maximum length



Note: Further cable types are available with which however only lower maximum lengths can be reached.

Trunk line with branch lines:

baud rate	156 kbps	625 kbps
max. length trunk line	500 m	100 m
max. number of devices in branch line	6	6
max. cable length of branch line	8 m	8 m
max. length of all branch lines	200 m	50 m

Table 108: Maximum length

Further devices can be connected via T-branches to the bus cable only at the baud rates 156 kbps and 625 kbps. The maximum length of all T-stubs is limited to 8 m. The whole length of the bus cable and all T-branches does not exceed the maximum length listed in the following table.

Minimum Distance:

Between two devices a minimum distance is to be kept.

Distance between CC-Link devices	CC-Link cable V1.00	CC-Link cable V1.10
Remote device to next remote device	0.3 m or more	0.2 m or more
Remote device to next Master and/or intelligent device	1 m or more	0.2 m or more

Table 109: Minimum distance between two devices

CC-Link Cable Housing

With delivery of a netTAP NT 100-XX-CC gateway device a CC-Link cable housing is included. The cable housing is from Phoenix Contact, number 1803895, KGG-MSTB 2,5/5.

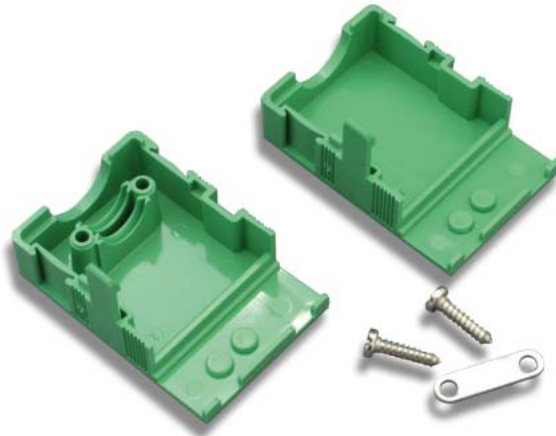

Figure 34: CC-Link Cable Housing - Items



Note: Use the delivered cable housing. The cable housing is used to protect the CC-Link communication line against EMC disturbance, which could come in via the screws of the COMBICON connector.

Assembly

- Put the Combicon connector with the screwed CC-Link cable into the lower part of the cable housing.
- Attach over the CC-Link cable the strain relief with two screws on the cable housing.
- Put the upper part of the cable housing on the lower part of the cable housing to close the cable housing.

The following figure shows the mounted cable housing on the CC-Link cable.



Figure 35: Mounted CC-Link Cable Housing

11.7 RS-232

The RS232 interface (EIA-232) is a point-to-point connection of two communication devices. Only shielded cables have to be used. No termination resistors are required.

Take care of the pin assignment at the communication partner. This decides, whether you need a so called null modem cable with crossed pin assignments.

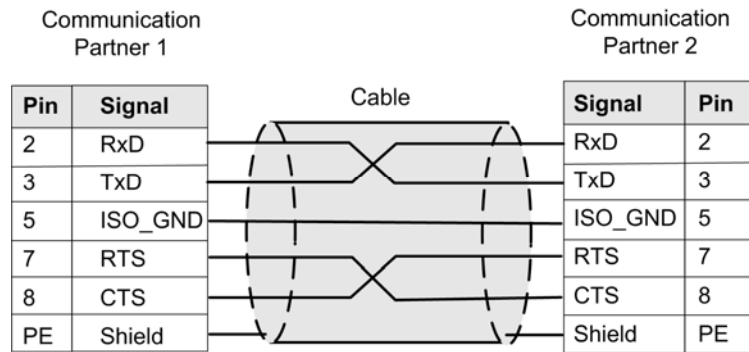

Figure 36: RS-232 Null-Modem Cable Connection

The pin assignment are for a DSub connector.

The signals RTS and CTS are not present on all devices.

Conductor length and transmission rates

In the EIA-232 norm a maximum cable capacitance of 2500 pF is allowed for a RS232 connection.

Cables of such capacitance may have the following lengths depending on the baud rate

max. baud rate	max. length
19.200	15 m
57.600	5 m
115.200	<2 m

Higher length can be achieved with cables of extraordinarily low capacitance.

11.8 RS-422

The lines of this industry bus interface are operated in push-pull action, four lines are required which can be controlled in half duplex or full duplex mode. This interface has been designed for one master and at maximum 10 slaves. Using repeaters, using even more slaves is possible.

Cable lengths of up to 1.2 km (at low baud rates) and data transmission rates of up to 10 MBit/s (at maximally 12 m length of line) are possible. The maximum useable transmission rate depends on the technical data of the used devices.

The following illustration shows wiring for RS-422:

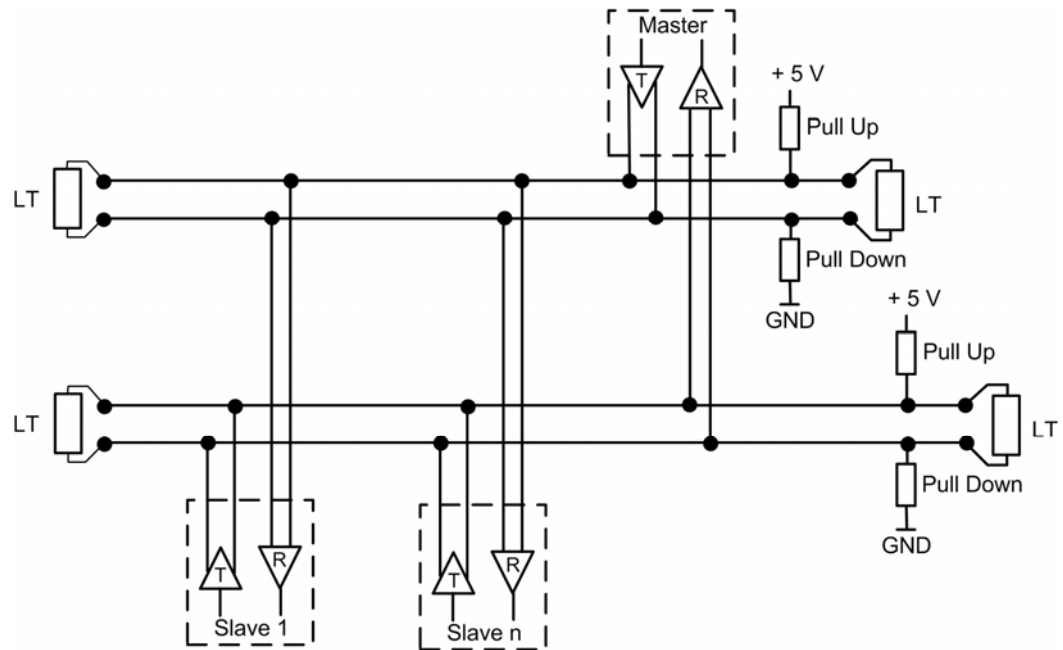

Figure 37: RS-422 Wiring

Bus Requirements:

The bus cable must be a shielded 4-wire twisted pair cable. Each pair of wires has to be used for exactly one data transmission direction. The shield should be connected at both ends to the potential equalization system.

On each end, the bus requires a termination resistor (LT) of $90\ \Omega$ to $150\ \Omega$ between the lines. This value depends on the characteristic wave impedance of the cable.

The pull-up and pull-down resistors should have a resistance of $390\ \Omega$ up to $650\ \Omega$.

Cable Requirements:

The workmanship of bus cabling is an important factor of the reliable operation and also for the electromagnetic compatibility and emission. It is mandatory to use shielded twisted-pair cables. The shield of the cable must consist of a copper wire mesh.

Parameter	Value
Characteristic wave impedance	150 Ω \pm 15 Ω
Capacitance	< 30 pF/m
Loop resistance	110 Ω /km
Wire gauge	0,64 mm

Table 110: Electric Requirements to RS-422 Cables

The following lengths of lines can be achieved:

Max. overall length of line	Max. Baud rate	Max. length of a single branch line
120 m	1 MBit/s	0,3 m
600 m	500 kBit/s	0,6 m
1200 m	100 kBit/s	1,5 m

Table 111: RS-422 Conductor Length and Transmission Rates

11.9 RS-485

The lines of this industry bus interface are operated in push-pull action, only two lines are required which can be controlled in half duplex or full duplex mode. The advantage of the 2-wire technology mainly consists in the multi-master capability. In principle, each participant is able to exchange data with any other participant. However, synchronous send attempts of two or more participants must be prevented by the applied protocol. The RS-485 interface allows the connection of up to 32 transmitters and receivers using a protocol. (With repeaters even more participants are possible.)

Nowadays, RS-485 supports cable lengths of up to 1.2 km (see Table 113: RS-485 Cable Lengths *on page 127*) and data transmission rates of up to 1 MBit/s. The maximum useable transmission rate depends on the technical data of the used devices.

The following illustration shows wiring for RS-485:

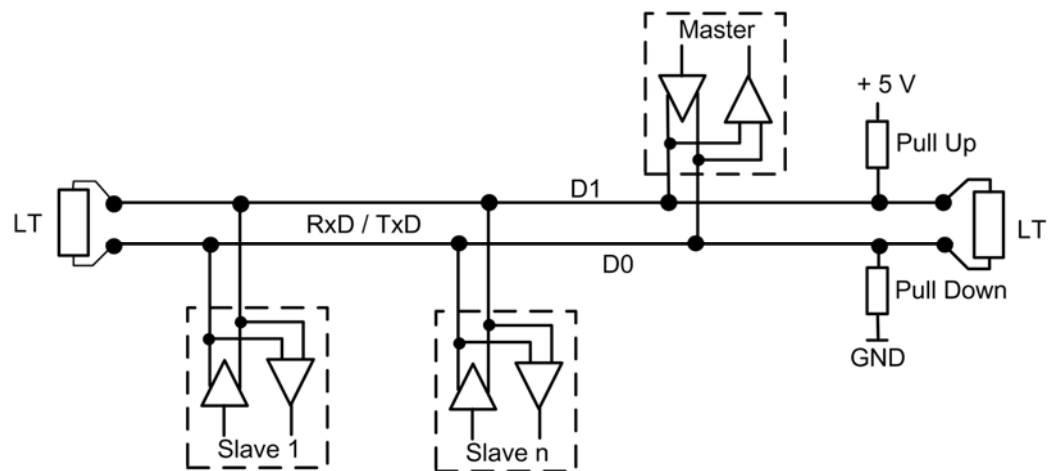

Figure 38: RS-485 Wiring

Bus requirements:

The bus cable must be a shielded twisted pair cable where the shield should be connected at both ends with large contact areas to the potential equalization system.

On each end, the bus requires a termination resistor (LT) between the lines D1 und D0 of approximately the amount of the characteristic wave impedance of the cable, which usually amounts to a value between 120 Ω and 220 Ω .

The pull-up and pull-down resistors should have a value of 390 Ω up to 650 Ω .

Cable requirements:

The workmanship of bus cabling is an important factor of the reliable operation and also for the electromagnetic compatibility and emission. It is mandatory to use shielded twisted-pair cables. The shield of the cable must consist of a copper wire mesh.

Parameter	Value
Characteristic wave impedance	150 $\Omega \pm 15 \Omega$
Capacitance	< 30 pF/m
Loop resistance	110 Ω /km
Wire gauge	0,64 mm

Table 112: Electric Requirements to RS-485 Cables

The following lengths of lines can be achieved:

Max. overall length of line	Max. Baud rate	Max. length of a single branch line
120 m	1 MBit/s	0,3 m
600 m	500 kBit/s	0,6 m
1200 m	100 kBit/s	1,5 m

Table 113: RS-485 Cable Lengths

12 Decommissioning/Disposal

12.1 Put the Device out of Operation

NOTICE**Danger of unsafe System Operation!**

➤ To prevent property damage, do not remove this device under runtime conditions before you can not guarantee further a safe and secure operation of the plant.

- Disconnect the communication cables from the device.
- Disconnect the plug for power supply.
- Remove the device as described in section „Removing the NT 100 from the DIN Top Hat Rail“ on page 48 from the DIN rail.

12.2 Disposal of Waste Electronic Equipment

According to the European Directive 2002/96/EG “Waste Electrical and Electronic Equipment (WEEE)”, waste electronic equipment may not be disposed of as household waste. As a consumer, you are legally obliged to dispose of all waste electronic equipment according to national and local regulations.

**Waste Electronic Equipment**

- This product must not be treated as household waste.
- This product must be disposed of at a designated waste electronic equipment collecting point.

13 Glossary

10-Base T

Standard for communication on Ethernet over twisted pair lines with RJ45 connectors and a [baud rate](#) of 10 MBit/s (according to the IEEE 802.3 specification).

100-Base TX

Standard for communication on Ethernet over unshielded twisted pair lines with RJ45 connectors and a baud rate of 100 MBit/s according to the IEEE 802. specification

Auto-Crossover

Auto-Crossover is a feature of an interface: An interface with Auto-Crossover capability will automatically detect and correct if the data lines have been exchanged vice versa.

Auto-Negotiation

Auto-Negotiation is a feature of an interface: An interface with Auto- Negotiation will automatically determine a set of correct communication parameters.

Baud rate

Data transmission speed of a communication channel or interface.

Boot loader

Program loading the firmware into the memory of a device in order to be executed.

DDF

[Device Description File](#).

Device Description File

A file containing configuration information about a device being a part of a network that can be read out by masters for system configuration. Device Description Files use various formats which depend on the communication system. Often these formats are based on [XML](#) such as [EDS files](#) or files. Contains configuration information

EDS file

A special kind of Device Description File used by EtherNet/IP.

EtherCAT

A communication system for industrial Ethernet designed and developed by Beckhoff Automation GmbH.

EtherNet/IP

A communication system for industrial Ethernet designed and developed by Rockwell. It partly uses the CIP (Common Industrial Protocol).

Ethernet Powerlink

A communication system for industrial Ethernet designed and developed by B&R. It partly uses CANopen technologies.

Gateway

A device interfacing between two different communication standards.

GND

Reference potential

ISO GND

Isolated reference potential, isolated from other device areas.

Open Modbus/TCP

A communication system for Industrial Ethernet designed and developed by Schneider Automation and maintained by the Modbus-IDA organization based on the Modbus protocols for serial communication.

PE

Potential equalization line, Potential equalization line of the process plant.

PROFINET

A communication system for Industrial Ethernet designed and developed by PROFIBUS International. It uses some mechanisms similar to those of the PROFIBUS field bus.

Real-Time Ethernet

Real-Time Ethernet (also denominated as *Industrial Ethernet*) is an extension of the Ethernet networking technology for industrial purposes with very good Real-Time features and performance. There is a variety of different Real-Time Ethernet systems on the market which are incompatible with each other. The most important systems of these are

- EtherCAT
- EtherNet/IP
- Ethernet Powerlink
- Open Modbus/TCP
- PROFINET
- sercos

sercos

A communication system for industrial Ethernet designed and developed by Bosch-Rexroth and supported by sercos International.

14 Appendix

14.1 List of Figures

Figure 1: Function NT 100	21
Figure 2: Device Drawing NT 100-RE-DP	22
Figure 3: Dimensioned Drawing	32
Figure 4: Device Label	32
Figure 5: LEDs and Control Elements of the upper half of the Device	33
Figure 6: Range of Values for the Address Switches	34
Figure 7: LEDs of the lower half of the Device	34
Figure 8: Device Drawings – Left Part (X2)	35
Figure 9: Device Drawings – Right Part (X3)	36
Figure 10: RS-485 Termination	41
Figure 11: Galvanic Isolation of the NT 100-RE-EN Device	42
Figure 12: Galvanic Isolation NT 100-RE-XX Devices	43
Figure 13: Galvanic Isolation NT 100-DP-XX/CO-XX/DN-XX Devices	45
Figure 14: Mounting the netTAP NT 100 device onto the DIN top hat rail	47
Figure 15: Removing the NT 100 device from the DIN Top Hat Rail	48
Figure 16: USB Installation in Boot Loader Mode Step 1	55
Figure 17: USB Installation in Boot Loader Mode Step 2	56
Figure 18: USB Installation in Boot Loader Mode Step 3	56
Figure 19: USB Installation in Boot Loader Mode Step 4	57
Figure 20: USB Installation in Boot Loader Mode Step 5	57
Figure 21: USB Installation in Boot Loader Mode Step 6	58
Figure 22: USB Installation in Boot Loader Mode Step 7	58
Figure 23: ComProX Start	59
Figure 24: ComProX Choice of Connection	59
Figure 25: ComProX Choice File Explorer	60
Figure 26: ComProX File Explorer - NT 100 File System Structure	60
Figure 27: ComProX File Explorer - File Menu 1	61
Figure 28: ComProX File Explorer - File Menu 2	61
Figure 29: D-Sub Cable Assemblies	113
Figure 30: PROFIBUS-DP-Network	115
Figure 31: Termination CANopen Network	117
Figure 32: DeviceNet Network	118
Figure 33: CC-Link Network	120
Figure 34: CC-Link Cable Housing - Items	122
Figure 35: Mounted CC-Link Cable Housing	122
Figure 36: RS-232 Null-Modem Cable Connection	123
Figure 37: RS-422 Wiring	124
Figure 38: RS-485 Wiring	126

14.2 List of Tables

Table 1: List of Revisions	7
Table 2: Reference to Hardware	9
Table 3: Reference to Software	9
Table 4: Reference to Driver	9
Table 5: Directory Structure of the Gateway Solutions DVD	10
Table 6: Device description files for netTAP NT 100 on the DVD	11
Table 7: Basic Documentation for netTAP NT 100	12
Table 8: Additional Documentation for netTAP NT 100 with EtherCAT Master	12
Table 9: Additional Documentation for netTAP NT 100 with EtherNet/IP Scanner/Master	13
Table 10: Additional Documentation for netTAP NT 100 with PROFINET IO Controller	13
Table 11: Additional Documentation for netTAP NT 100 with sercos Master	13
Table 12: Additional Documentation for netTAP NT 100 with CANopen Master	13
Table 13: Additional Documentation for netTAP NT 100 with DeviceNet Master	14
Table 14: Additional Documentation for netTAP NT 100 with PROFIBUS DP Master	14
Table 15: Additional Documentation for netTAP NT 100 with netSCRIPT	14
Table 16: Additional Documentation for netTAP NT 100 with ASCII	14
Table 17: Additional Documentation for netTAP NT 100 with 3964R	14
Table 18: Safety Symbols and Sort of Warning or Principle	20
Table 19: Signal Words	20
Table 20: Network on Port X2 (Primary Network)	23
Table 21: Network on Port X3 (Secondary Network)	23
Table 22: NT 100 for Ethernet to Ethernet	24
Table 23: NT 100 for Ethernet to Fieldbus	26
Table 24: NT 100 for Ethernet to Serial	27
Table 25: NT 100 for Fieldbus to Fieldbus	28
Table 26: NT 100 for Fieldbus to Serial	29
Table 27: Power Supply Line Pin Assignment	37
Table 28: PROFIBUS RS-485 Pin Assignment	37
Table 29: CANopen Pin Assignment	38
Table 30: DeviceNet Pin Assignment	38
Table 31: Ethernet RJ45 pin assignment	39
Table 32: CC-Link Pin Assignment	39
Table 33: RS-232 pin assignment	40
Table 34: RS-422 pin assignment	40
Table 35: RS-485 pin assignment	40
Table 36: Sliding Switch for Termination of RS-422 respectively RS-485 on NT 100-XX-RS Devices	41
Table 37: Pin Assignment Mini-B USB Connector (5-pin)	41
Table 38: Coupling NT 100-RE-EN Devices	43
Table 39: Coupling RE Devices	44
Table 40: Coupling NT 100-DP-XX/CO-XX/DN-XX Devices	46
Table 41: NT 100 Troubleshooting	63
Table 42: System LED	65
Table 43: LEDs EtherCAT Master	67
Table 44: LED State Definition for EtherCAT Master for the RUN and ERR LEDs	67
Table 45: LEDs EtherCAT Slave	68
Table 46: LED State Definition for EtherCAT Slave for the RUN and ERR LEDs	69
Table 47: LEDs EtherNet/IP Scanner (Master)	70
Table 48: LEDs EtherNet/IP Adapter (Slave)	71
Table 49: LEDs EtherNet/IP Adapter (Slave)	72
Table 50: LEDs Open Modbus/TCP	73
Table 51: LEDs Open Modbus/TCP	74

Table 52: LEDs Powerlink Controlled Node/Slave	75
Table 53: LED State Definition for Powerlink Controlled Node/Slave for the BS/BE LEDs	76
Table 54: LEDs PROFINET IO-RT Controller	77
Table 55: LEDs PROFINET IO-RT-Device	78
Table 56: LEDs sercos Master	79
Table 57: LED State Definition for sercos Master for the STA and ERR LEDs	80
Table 58: LEDs sercos Slave	81
Table 59: LED State Definition for sercos Slave for the S3 LED (STA LED)	81
Table 60: LEDs CANopen Master – 1 Communication LED (current Hardware Revision)	82
Table 61: LED State Definition for CANopen Master for the CAN LED	82
Table 62: LEDs CANopen Slave	83
Table 63: LED State Definition for CANopen Slave for the CAN LED	83
Table 64: LEDs CC-Link Slave	84
Table 65: LEDs DeviceNet Master	85
Table 66: LEDs DeviceNet Slave	85
Table 67: LEDs PROFIBUS DP Master	86
Table 68: LEDs PROFIBUS DP Slave	86
Table 69: LEDs Modbus RTU Protocol	87
Table 70: LEDs ASCII Protocol	87
Table 71: LED serial with netSCRIPT – Script is not executed	88
Table 72: LED serial with netSCRIPT – Script is executed	88
Table 73: LEDs 3964R Protocol	89
Table 74: Technical Data NT 100 (Part 1)	90
Table 75: Technical Data NT 100 (Part 2)	91
Table 76: Technical Data NT 100 (Part 3)	92
Table 77: Technical Data EtherCAT Master Protocol	93
Table 78: Technical Data EtherCAT Slave Protocol	93
Table 79: Technical Data EtherNet/IP Scanner (Master) Protocol	94
Table 80: Technical Data EtherNet/IP Adapter (Slave) Protocol	95
Table 81: Technical Data Open Modbus/TCP Protocol	96
Table 82: Technical Data POWERLINK Controlled Node (Slave) Protocol	96
Table 83: Technical Data PROFINET IO RT Controller	97
Table 84: Technical Data PROFINET IO RT Device Protocol	98
Table 85: Technical Data sercos Master Protocol	99
Table 86: Technical Data sercos Slave Protocol	100
Table 87: Technical Data CANopen Master Protocol	101
Table 88: Technical Data CANopen Slave Protocol	102
Table 89: Technical Data CC-Link-Slave Protocol	103
Table 90: Technical Data DeviceNet Master Protocol	104
Table 91: Technical Data DeviceNet Slave Protocol	105
Table 92: Technical Data PROFIBUS DP Master Protocol	106
Table 93: Technical Data PROFIBUS DP Slave Protocol	107
Table 94: Technical Data ASCII Protocol	108
Table 95: Technical Data Modbus RTU Protocol	109
Table 96: Technical Data netSCRIPT Serial	110
Table 97: Technical Data 3964R Protocol	111
Table 98: Use of Hubs and Switches	114
Table 99: PROFIBUS Segment Length in Dependence of the Baud Rate	116
Table 100: Characteristics of PROFIBUS certified Cable	116
Table 101: Characteristics of CAN certified Cable	117
Table 102: CAN Segment Length in dependence of the Baud rate or corresponding Loop Resistance and Wire Gauge	117
Table 103: Maximum length in dependence from the Baud Rate for DeviceNet Cables	118

Table 104 Characteristics of DeviceNet Data Line Cable	118
Table 105: Characteristics of DeviceNet Power Supply Cable	118
Table 106: DeviceNet Segment Length in dependence of the Baud rate	119
Table 107: Maximum length	121
Table 108: Maximum length	121
Table 109: Minimum distance between two devices	121
Table 110: Electric Requirements to RS-422 Cables	125
Table 111: RS-422 Conductor Length and Transmission Rates	125
Table 112: Electric Requirements to RS-485 Cables	127
Table 113: RS-485 Cable Lengths	127

14.3 Contacts

Headquarters

Germany

Hilscher Gesellschaft für
Systemautomation mbH
Rheinstrasse 15
65795 Hattersheim
Phone: +49 (0) 6190 9907-0
Fax: +49 (0) 6190 9907-50
E-Mail: info@hilscher.com

Support

Phone: +49 (0) 6190 9907-99
E-Mail: de.support@hilscher.com

Subsidiaries

China

Hilscher Systemautomation (Shanghai) Co. Ltd.
200010 Shanghai
Phone: +86 (0) 21-6355-5161
E-Mail: info@hilscher.cn

Support

Phone: +86 (0) 21-6355-5161
E-Mail: cn.support@hilscher.com

France

Hilscher France S.a.r.l.
69500 Bron
Phone: +33 (0) 4 72 37 98 40
E-Mail: info@hilscher.fr

Support

Phone: +33 (0) 4 72 37 98 40
E-Mail: fr.support@hilscher.com

India

Hilscher India Pvt. Ltd.
Pune, Delhi, Mumbai
Phone: +91 8888 750 777
E-Mail: info@hilscher.in

Italy

Hilscher Italia S.r.l.
20090 Vimodrone (MI)
Phone: +39 02 25007068
E-Mail: info@hilscher.it

Support

Phone: +39 02 25007068
E-Mail: it.support@hilscher.com

Japan

Hilscher Japan KK
Tokyo, 160-0022
Phone: +81 (0) 3-5362-0521
E-Mail: info@hilscher.jp

Support

Phone: +81 (0) 3-5362-0521
E-Mail: jp.support@hilscher.com

Korea

Hilscher Korea Inc.
Seongnam, Gyeonggi, 463-400
Phone: +82 (0) 31-789-3715
E-Mail: info@hilscher.kr

Switzerland

Hilscher Swiss GmbH
4500 Solothurn
Phone: +41 (0) 32 623 6633
E-Mail: info@hilscher.ch

Support

Phone: +49 (0) 6190 9907-99
E-Mail: ch.support@hilscher.com

USA

Hilscher North America, Inc.
Lisle, IL 60532
Phone: +1 630-505-5301
E-Mail: info@hilscher.us

Support

Phone: +1 630-505-5301
E-Mail: us.support@hilscher.com