

CROSLEY®

**SIDE BY SIDE
REFRIGERATOR**

Use & Care Guide

Table of Contents 2

TABLE OF CONTENTS

REFRIGERATOR SAFETY	3	Convertible Vegetable/Meat Drawer, Crisper and Covers	15
Proper Disposal of Your Old Refrigerator	3	Convertible Vegetable/Meat Drawer Temperature Control	15
INSTALLATION INSTRUCTIONS	4	Crisper Humidity Control	15
Unpacking	4	Wine or Can/Bottle Rack	15
Location Requirements	4	Utility Bin	15
Electrical Requirements	5	FREEZER FEATURES	16
Water Supply Requirements	5	Freezer Shelf	16
Base Grille	5	Freezer Basket or Bin	16
Door Removal	6	DOOR FEATURES	16
Door Closing	8	Door Rails	16
Water Supply Connection	8	Can Racks and Door Bins	16
Water System Preparation	9	REFRIGERATOR CARE	17
Normal Sounds	10	Cleaning	17
REFRIGERATOR USE	10	Changing the Light Bulbs	17
Ensuring Proper Air Circulation	10	Power Interruptions	18
Using the Controls	10	Vacation and Moving Care	18
Water and Ice Dispensers	11	TROUBLESHOOTING	19
Water Filter Status Light	12	ASSISTANCE OR SERVICE	21
Water Filtration System	12	In the U.S.A.	22
Ice Maker and Storage Bin	13	Accessories	22
REFRIGERATOR FEATURES	14	WATER FILTER CERTIFICATIONS	22
Refrigerator Shelves	14	PRODUCT DATA SHEETS	23
Flip-up Shelf	14	WARRANTY	24
Adjustable Flip-up Shelf	14		
Deli Drawer	14		

REFRIGERATOR SAFETY

Your safety and the safety of others are very important.

We have provided many important safety messages in this manual and on your appliance. Always read and obey all safety messages.



This is the safety alert symbol.

This symbol alerts you to potential hazards that can kill or hurt you and others.

All safety messages will follow the safety alert symbol and either the word "DANGER" or "WARNING." These words mean:

! DANGER

You can be killed or seriously injured if you don't immediately follow instructions.

! WARNING

You can be killed or seriously injured if you don't follow instructions.

All safety messages will tell you what the potential hazard is, tell you how to reduce the chance of injury, and tell you what can happen if the instructions are not followed.

IMPORTANT SAFETY INSTRUCTIONS

WARNING: To reduce the risk of fire, electric shock, or injury when using your refrigerator, follow these basic precautions:

- Plug into a grounded 3 prong outlet.
- Do not remove ground prong.
- Do not use an adapter.
- Do not use an extension cord.
- Disconnect power before servicing.
- Replace all panels before operating.
- Remove doors from your old refrigerator.
- Use nonflammable cleaner.
- Keep flammable materials and vapors, such as gasoline, away from refrigerator.
- Use two or more people to move and install refrigerator.
- Disconnect power before installing ice maker (on ice maker kit ready models only).
- Use a sturdy glass when dispensing ice or water (on some models).

SAVE THESE INSTRUCTIONS

Proper Disposal of Your Old Refrigerator

! WARNING

Suffocation Hazard

Remove doors from your old refrigerator.

Failure to do so can result in death or brain damage.

Before you throw away your old refrigerator or freezer:

- Take off the doors.
- Leave the shelves in place so that children may not easily climb inside.

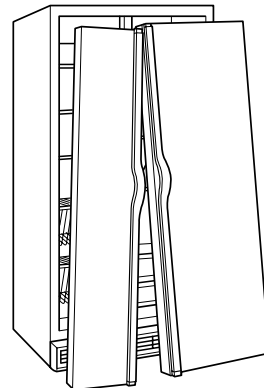

IMPORTANT: Child entrapment and suffocation are not problems of the past. Junked or abandoned refrigerators are still dangerous – even if they will sit for "just a few days." If you are getting rid of your old refrigerator, please follow these instructions to help prevent accidents.

INSTALLATION INSTRUCTIONS

Unpacking

⚠ WARNING

Excessive Weight Hazard

Use two or more people to move and install refrigerator.

Failure to do so can result in back or other injury.

Removing packaging materials

- Remove tape and glue residue from surfaces before turning on the refrigerator. Rub a small amount of liquid dish soap over the adhesive with your fingers. Wipe with warm water and dry.
- Do not use sharp instruments, rubbing alcohol, flammable fluids, or abrasive cleaners to remove tape or glue. These products can damage the surface of your refrigerator. For more information, see the "Refrigerator Safety" section.

When Moving Your Refrigerator:

Your refrigerator is heavy. When moving the refrigerator for cleaning or service, be sure to protect the floor. Always pull the refrigerator straight out when moving it. Do not wiggle or "walk" the refrigerator when trying to move it, as floor damage could occur.

Cleaning before use

After you remove all of the packaging materials, clean the inside of your refrigerator before using it. See the cleaning instructions in the "Refrigerator Care" section.

Important information to know about glass shelves and covers:

Do not clean glass shelves or covers with warm water when they are cold. Shelves and covers may break if exposed to sudden temperature changes or impact, such as bumping. For your protection, tempered glass is designed to shatter into many small, pebble-size pieces. This is normal. Glass shelves and covers are heavy. Use special care when removing them to avoid impact from dropping.

Location Requirements

⚠ WARNING



Explosion Hazard

Keep flammable materials and vapors, such as gasoline, away from refrigerator.

Failure to do so can result in death, explosion, or fire.

To ensure proper ventilation for your refrigerator, allow for ½ in. (1.25 cm) space on each side and at the top. When installing your refrigerator next to a fixed wall, leave 2 in. (5.08 cm) minimum on each side (depending on your model) to allow for the door to swing open. If your refrigerator has an ice maker, allow extra space at the back for the water line connections.

NOTE: Do not install the refrigerator near an oven, radiator, or other heat source, nor in a location where the temperature will fall below 55°F (13°C).

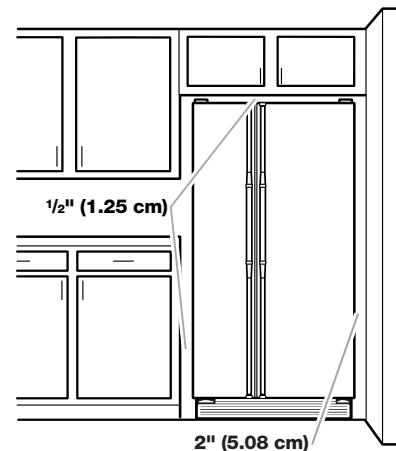

Electrical Requirements

⚠ WARNING



Electrical Shock Hazard

Plug into a grounded 3 prong outlet.

Do not remove ground prong.

Do not use an adapter.

Do not use an extension cord.

Failure to follow these instructions can result in death, fire, or electrical shock.

Before you move your refrigerator into its final location, it is important to make sure you have the proper electrical connection.

Recommended grounding method

A 115 Volt, 60 Hz., AC only 15 or 20 ampere fused, grounded electrical supply is required. It is recommended that a separate circuit serving only your refrigerator be provided. Use an outlet that cannot be turned off by a switch. Do not use an extension cord.

NOTE: Before performing any type of installation, cleaning, or removing a light bulb, turn the control (Thermostat, Refrigerator or Freezer Control depending on the model) to OFF and then disconnect the refrigerator from the electrical source. When you are finished, reconnect the refrigerator to the electrical source and reset the control (Thermostat, Refrigerator or Freezer Control depending on the model) to the desired setting.

Water Supply Requirements

Read all directions carefully before you begin.

IMPORTANT:

- If you turn the refrigerator on before the water line is connected, turn the ice maker OFF.
- All installations must meet local plumbing code requirements.
- Use copper tubing and check for leaks. Install copper tubing only in areas where the household temperatures will remain above freezing.

Tools Required: Flat-blade screwdriver, $\frac{7}{16}$ in. and $\frac{1}{2}$ in. open-end wrenches or two adjustable wrenches, $\frac{1}{4}$ in. nut driver and drill bit, hand drill or electric drill (properly grounded).

NOTE: Your refrigerator dealer has a kit available with a $\frac{1}{4}$ in. (6.35 mm) saddle-type shutoff valve, a union, and copper tubing. Before purchasing, make sure a saddle-type valve complies with your local plumbing codes. Do not use a piercing-type or $\frac{3}{16}$ in. (4.76 mm) saddle valve which reduces water flow and clogs more easily.

Water Pressure

A cold water supply with water pressure of between 30 and 120 psi (207-827 kPa) is required to operate the water dispenser and ice maker. If you have questions about your water pressure, see "Troubleshooting" or call a licensed, qualified plumber.

Reverse Osmosis Water Supply

If a reverse osmosis water filtration system is connected to your cold water supply, the water pressure to the system needs to be a minimum of 40 to 60 psi (276 - 414 kPa).

If the water pressure to the reverse osmosis system is less than 40 to 60 psi (276 - 414 kPa) a booster pump can be inserted into the small tubing that goes from the cold water line to the reverse osmosis system.

If the water dispenser is still not dispensing water properly:

- Check to see whether the sediment filter in the reverse osmosis system is blocked. Replace the filter if necessary.
- Allow the storage tank on the reverse osmosis system to refill after heavy usage.
- If your refrigerator has a water filter cartridge, it may further reduce the water pressure when used in conjunction with a reverse osmosis system. Remove the water filter cartridge. See "Water Filtration System."

If you have questions about your water pressure, refer to "Troubleshooting" or call a licensed, qualified plumber.

Base Grille

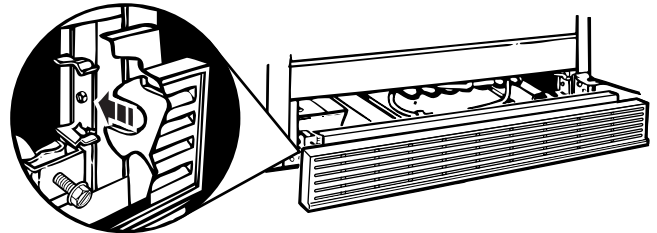

To remove the base grille:

1. Open both doors.
2. Place hands along the ends of the grille, with your thumbs along the top. Push in with your thumbs and pull up on the bottom.

NOTE: Be sure to refasten the Tech Sheet behind the base grille after cleaning.

To replace the base grille:

1. Open both doors.
2. Line up the grille support tabs with the metal clips.
3. Push the grille firmly to snap it into place.

Door Removal

TOOLS NEEDED: 1/4 in. hex-head socket wrench, 5/16 in. hex-head socket wrench and a flat-blade screwdriver.

IMPORTANT: Before you begin, turn the refrigerator control OFF, unplug refrigerator or disconnect power. Remove food and any adjustable door or utility bins from doors.

NOTE: It may only be necessary to remove either the door handle or the doors to get your product through the doorway of your residence. Measure the door opening to determine whether to remove the refrigerator handles or the doors.



! WARNING

Electrical Shock Hazard

Disconnect power before removing doors.
Reconnect both ground wires before operating.
Failure to do so can result in death or electrical shock.

4 Top Left Hinge



Style 1

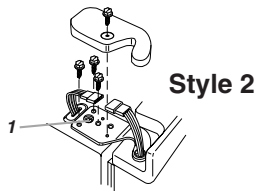

Style 2

1. Do Not Remove Screw

3 Water Dispenser Tubing Connection

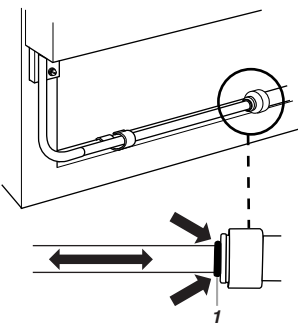

1. Red Outer Ring

2 Base Grille

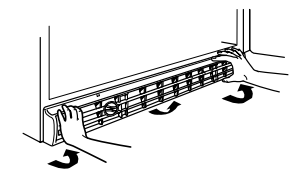

5 Door Removal



6 Top Right Hinge

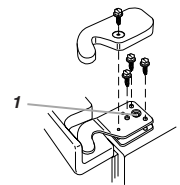

1. Do Not Remove Screw

1 Handle Removal (Optional)

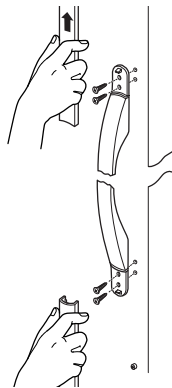

7 Bottom Hinge

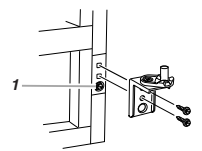

1. Do Not Remove Screw

8 Door Alignment

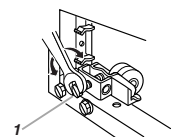

1. Leveling Screw

Handle Removal (optional)

1. Apply firm pressure with your hand on the face of trim. Slide top trim up and bottom trim down away from handle. Lift trim pieces off shoulder screws (see Graphic 1).

NOTE: Some models include accent pieces between the handle and the handle trim. If your model includes the accents, you will need to carefully remove them with a flat-blade screwdriver before removing the handle screws. The accent pieces are optional and can be reinstalled or left off of the handle assembly.

2. Remove handle screws and handles.
3. Move refrigerator into place. Replace handles as shown (see Graphic 1).

Door Removal

⚠ WARNING



Electrical Shock Hazard
Disconnect power before removing doors.
Failure to do so can result in death or electrical shock.

1. Unplug refrigerator or disconnect power.
2. Open both refrigerator doors. Remove the base grille by pulling up on the bottom outside corners (see Graphic 2).
3. Close both doors and keep them closed until you are ready to lift them free from the cabinet.
4. If you have a dispenser (ice or water), disconnect the water dispenser tubing located behind the base grille on the freezer door side (see Graphic 3).
 - Press the red outer ring against the face of fitting and pull the dispenser tubing free.
 - On some models, remove tubing from hose clip.
5. Remove top left hinge screw and cover as shown (see Graphic 4). Do not remove screw 1.

6. Disconnect wiring:

Style 1

- Disconnect wiring plug.
- Remove green ground wire screw to disconnect ground wires.

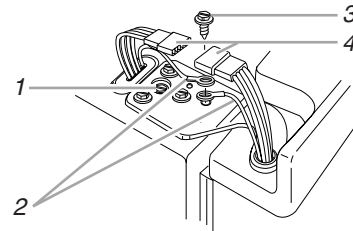

1. Do not remove screw 1
2. Ground wires
3. Green ground wire screw
4. Wiring plug

Style 2

- Disconnect wiring plug.

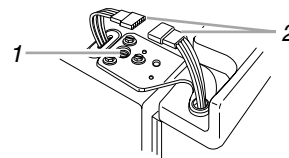

1. Do not remove screw 1
2. Wiring plug

7. Carefully lift freezer door straight up off bottom hinge (see Graphic 5). The water dispenser tubing remains attached to the freezer door and pulls through the bottom left hinge. Make sure you protect the dispenser tubing from damage.
8. Remove top right hinge cover and screws as shown (see Graphic 6). Do not remove screw 1.
9. Lift the refrigerator door straight up off bottom hinge.
10. It may not be necessary to remove the bottom hinge to move the refrigerator through a doorway. Both bottom hinges have similar construction. If necessary, disassemble the hinges as shown (see Graphic 7). Do not remove screw 1.

Door and Hinge Replacement

1. Replace both bottom hinges, if removed. Tighten screws.
2. Assistance may be needed to feed the water dispenser tubing through the bottom hinge while reinstalling the freezer door. Carefully feed the dispenser tubing through the bottom left hinge before replacing the door on the hinge.

NOTE: Provide additional support for the doors while the top hinges are being replaced. Do not depend on the door magnets to hold the doors in place while you are working.

3. Reconnect water dispenser tubing by pushing tubing into fitting until it stops and black mark touches face of fitting (see Graphic 3). On some models, replace tubing in hose clip.

- Align and replace the top left hinge as shown (see Graphic 4). Tighten screws.

⚠ **WARNING**



Electrical Shock Hazard

Reconnect both ground wires.

Failure to do so can result in death or electrical shock.

Style 1

- Reconnect both ground wires.
- Reconnect wiring plug.

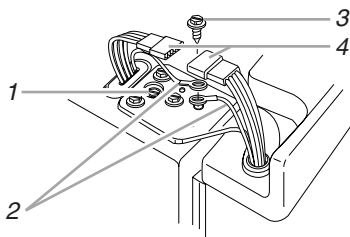

- Do not remove screw 1
- Ground wires
- Green ground wire screw
- Wiring plug

Style 2

- Reconnect wiring plug.

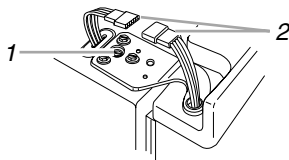

- Do not remove screw 1
- Wiring plug

- Replace left hinge cover and screws.
- Replace the refrigerator door by carefully lifting the door onto the bottom right hinge.
- Align and replace the top right hinge as shown (see Graphic 6). Tighten screws.
- Replace hinge cover and screws. Tighten screws.
- Plug into a grounded 3 prong outlet.

Door Closing

Your refrigerator has two front adjustable rollers — one on the right and one on the left. If your refrigerator seems unsteady or if you want the doors to close more easily, adjust the refrigerator's tilt using the instructions below:

- Move the refrigerator into its final position.
- The two leveling screws are part of the front roller assemblies which are at the base of the refrigerator on either side (see Graphic 8).

- Use a hex-head socket wrench to adjust the leveling screws. Turn the leveling screw to the right to raise that side of the refrigerator or turn the leveling screw to the left to lower that side. It may take several turns of the leveling screws to adjust the tilt of the refrigerator (see Graphic 8).

NOTE: Having someone push against the top of the refrigerator takes some weight off the leveling screws and rollers. This makes it easier to adjust the screws.

- Open both doors again and check to make sure that they close as easily as you like. If not, tilt the refrigerator slightly more to the rear by turning both leveling screws to the right. It may take several more turns, and you should turn both leveling screws the same amount.
- Replace the base grille.

NOTE: Be sure to refasten the Tech Sheet behind the base grille.

Water Supply Connection

Read all directions before you begin.

IMPORTANT: If you turn the refrigerator on before the water line is connected, turn the ice maker OFF.

Connecting to Water Line

- Unplug refrigerator or disconnect power.
- Turn OFF main water supply. Turn ON nearest faucet long enough to clear line of water.
- Locate a ½ in. to 1¼ in. (1.25 cm to 3.18 cm) vertical COLD water pipe near the refrigerator.

NOTE: Horizontal pipe will work, but drill on the top side of the pipe, not the bottom. This will help keep water away from the drill and normal sediment from collecting in the valve.
- Determine the length of copper tubing you need. Measure from the connection on the lower left rear of refrigerator to the water pipe. Add 7 ft. (2.1 m) to allow for cleaning. Use ¼ in. (6.35 mm) O.D. (outside diameter) copper tubing. Be sure both ends of copper tubing are cut square.
- Using a grounded drill, drill a ¼ in. hole in the cold water pipe you have selected.

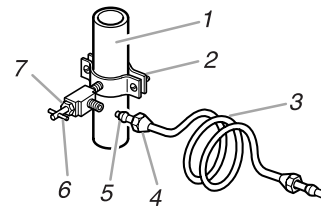

- Cold water pipe
- Pipe clamp
- Copper tubing
- Compression nut
- Compression sleeve
- Shutoff valve
- Packing nut

- Fasten the shutoff valve to the cold water pipe with the pipe clamp. Be sure the outlet end is solidly in the ¼ in. drilled hole in the water pipe and that the washer is under the pipe clamp. Tighten the packing nut. Tighten the pipe clamp screws carefully and evenly so washer makes a watertight seal. Do not overtighten or you may crush the copper tubing.
- Slip the compression sleeve and compression nut on the copper tubing as shown. Insert the end of the tubing into the outlet end squarely as far as it will go. Screw compression nut onto outlet end with adjustable wrench. Do not overtighten.
- Place the free end of the tubing in a container or sink, and turn ON the main water supply. Flush the tubing until water is clear. Turn OFF the shutoff valve on the water pipe. Coil the copper tubing.

Connecting to Refrigerator

Style 1

1. Unplug refrigerator or disconnect power.
2. Attach the copper tube to the valve inlet using a compression nut and sleeve as shown. Tighten the compression nut. Do not overtighten.
3. Use the tube clamp on the back of the refrigerator to secure the tubing to the refrigerator as shown. This will help prevent damage to the tubing when the refrigerator is pushed back against the wall.
4. Turn shutoff valve ON.
5. Check for leaks. Tighten any connections (including connections at the valve) or nuts that leak.

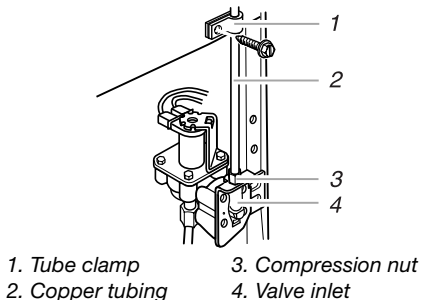

6. The ice maker is equipped with a built-in water strainer. If your water conditions require a second water strainer, install it in the ¼ in. (6.35 mm) water line at either tube connection. Obtain a water strainer from your nearest appliance dealer.
7. Plug in refrigerator or reconnect power.
8. Flush the water system. See the “Water System Preparation” section.

NOTE: Allow 24 hours to produce the first batch of ice. Allow 3 days to completely fill ice container.

Style 2

1. Unplug refrigerator or disconnect power.
2. Remove the shipping tape from the gray, coiled water tubing on the rear of the refrigerator.
3. Thread the provided nut onto the coupling on the end of the copper tubing. Tighten the nut by hand. Then tighten it with a wrench two more turns. Do not overtighten.

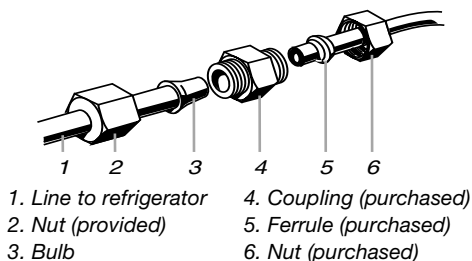

4. Turn shutoff valve ON.
5. Check for leaks. Tighten any nuts or connections (including connections at the valve) that leak.
6. The ice maker is equipped with a built-in water strainer. If your water conditions require a second water strainer, install it in the ¼ in. (6.35 mm) water line at either tube connection. Obtain a water strainer from your nearest appliance dealer.
7. Plug in refrigerator or reconnect power.
8. Flush the water system. See the “Water System Preparation” section.

NOTE: Allow 24 hours to produce the first batch of ice. Allow 3 days to completely fill ice container.

Style 3

1. Unplug refrigerator or disconnect power.
2. Remove the shipping tape from the gray, coiled water tubing on the rear of the refrigerator.
3. Thread the provided nut onto the water valve as shown.

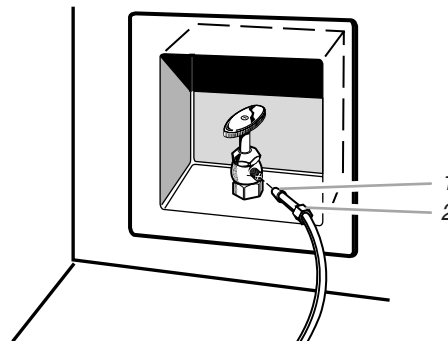

NOTE: Tighten the nut by hand. Then tighten it with a wrench two more turns. Do not overtighten.

4. Turn shutoff valve ON.
5. Check for leaks. Tighten any nuts or connections (including connections at the valve) that leak.
6. The ice maker is equipped with a built-in water strainer. If your water conditions require a second water strainer, install it in the ¼ in. (6.35 mm) water line at either tube connection. Obtain a water strainer from your nearest appliance dealer.
7. Plug in refrigerator or reconnect power.
8. Flush the water system. See the “Water System Preparation” section.

NOTE: Allow 24 hours to produce the first batch of ice. Allow 3 days to completely fill ice container.

Water System Preparation (on some models)

Please read before using the water system.

Immediately after installation, follow the steps below to make sure that the water system is properly cleaned.

1. Open the freezer door and turn off the ice maker by lifting up the wire shutoff arm as shown.

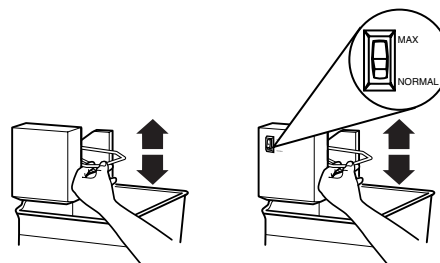

NOTES:

- If your model has a base grille filter system, make sure the base grille filter is properly installed and the cap is in the horizontal position.
- **Do not use with water that is microbiologically unsafe or of unknown quality without adequate disinfection before or after the system.**

REFRIGERATOR USE

Ensuring Proper Air Circulation

In order to ensure proper temperatures, you need to permit air to flow between the two sections. Cold air enters the bottom of the freezer section and moves up. It then enters the refrigerator section through the top vent. Air then returns to the freezer as shown.

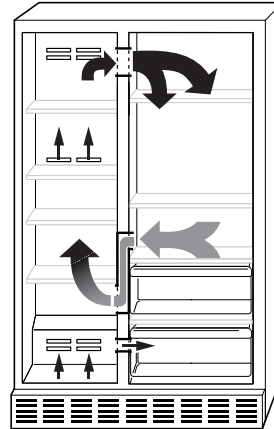

Do not block any of these vents with food such as soda, cereal, bread, etc. If the vents are blocked, airflow will be prevented and the temperature controls will not function properly.

IMPORTANT: Because air circulates between both sections, any odors formed in one section will transfer to the other. You must thoroughly clean both sections to eliminate odors. To prevent odor transfer from food, wrap or cover foods tightly.

2. Use a sturdy container to depress the water dispenser bar until the water begins to flow. Flush the water system by dispensing and discarding 2 to 3 gal. (8 to 12 L) of water. Cleaning the system will take approximately 6 to 7 minutes and will help clear air from the line. Additional flushing may be required in some households.

NOTE: As air is cleared from the system, water may spurt out of the dispenser.

3. Open the freezer door and turn on the ice maker by lowering the wire shutoff arm. Please refer to the “Ice Maker and Storage Bin” section for further instructions on the operation of your ice maker.
 - Allow 24 hours to produce the first batch of ice.
 - Discard the first three batches of ice produced.
 - Depending on your model, you may want to select the maximum ice feature to increase the production of ice. To do so, set the switch on the front of the ice maker to MAX.
-

Normal Sounds

Your new refrigerator may make sounds that your old one didn't make. Because the sounds are new to you, you might be concerned about them. Most of the new sounds are normal. Hard surfaces, such as the floor, walls, and cabinets, can make the sounds seem louder. The following describes the kinds of sounds and what may be making them.

- If your product is equipped with an ice maker, you will hear a buzzing sound when the water valve opens to fill the ice maker for each cycle.
- Your refrigerator is designed to run more efficiently to keep your food items at the desired temperatures and to minimize energy usage. The high efficiency compressor and fans may cause your refrigerator to run longer than your old one. You may also hear a pulsating or high-pitched sound from the compressor or fans adjusting to optimize performance.
- You may hear the evaporator fan motor circulating air through the refrigerator and freezer compartments. The fan speed may increase as you open the doors or add warm food.
- Rattling noises may come from the flow of refrigerant, the water line, or items stored on top of the refrigerator.
- Water dripping on the defrost heater during a defrost cycle may cause a sizzling sound.
- As each cycle ends, you may hear a gurgling sound due to the refrigerant flowing in your refrigerator.
- Contraction and expansion of the inside walls may cause a popping noise.
- You may hear air being forced over the condenser by the condenser fan.
- You may hear water running into the drain pan during the defrost cycle.

Using the Controls

For your convenience, your refrigerator controls are preset at the factory. When installing your refrigerator, make sure that the controls are still preset to the “mid-settings” as shown.

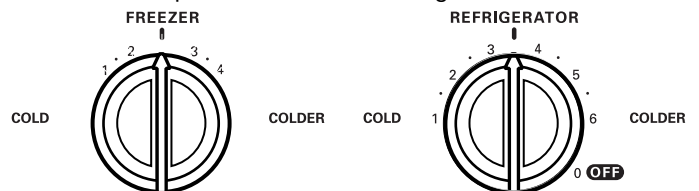

IMPORTANT:

- Your product will not cool when the Refrigerator Control is set to OFF.
- The Refrigerator Control adjusts the refrigerator compartment temperature. The Freezer Control adjusts the freezer compartment temperature. Higher numbered settings make the compartment colder. Lower numbered settings make the temperature less cold.
- Wait 24 hours before you put food into the refrigerator. If you add food before the refrigerator has cooled completely, your food may spoil.

NOTE: Adjusting the Refrigerator and Freezer Controls to a higher (colder) setting will not cool the compartments any faster.
- The preset settings should be correct for normal household usage. The controls are set correctly when milk or juice is as cold as you like and when ice cream is firm.
- If the temperature is too warm or too cold in the refrigerator or freezer, first check the air vents to be sure they are not blocked before adjusting the controls.

Adjusting Controls

If you need to adjust temperatures, adjust the refrigerator temperature first.

NOTE: Wait at least 24 hours between adjustments and then recheck the temperatures.

Turn the control right (clockwise) to make the compartment colder. Turn the control left (counterclockwise) to make it less cold.

CONDITION/REASON:	SETTING ADJUSTMENT:
REFRIGERATOR too cold - Not set correctly for your conditions	REFRIGERATOR Control one setting lower
REFRIGERATOR too warm - Door opened often, large amount of food added or room temperature very warm	REFRIGERATOR Control one setting higher
FREEZER too cold - Not set correctly for your conditions	FREEZER Control one setting lower
FREEZER too warm/too little ice - Door opened often, or large amount of food added or very cold room temperature (can't cycle often enough) or heavy ice usage	FREEZER Control one setting higher

Water and Ice Dispensers (on some models)

WARNING



Cut Hazard

**Use a sturdy glass when dispensing ice or water.
Failure to do so can result in cuts.**

Depending on your model, you may have one or more of the following options: the ability to select either crushed or cubed ice, a special light that turns on when you use the dispenser, or a lock option to avoid accidental dispensing.

The Ice Dispenser

Ice dispenses from the ice maker storage bin in the freezer. When the dispenser lever is pressed:

- A trap door opens in a chute between the dispenser and the ice bin. Ice moves from the bin and falls through the chute.
- When you release the dispenser lever, the trap door closes and the ice dispensing stops. The dispensing system will not operate when the freezer door is open.

Some models dispense both cubed and crushed ice. Before dispensing ice, select which type of ice you prefer. The button controls are designed for easy use and cleaning.

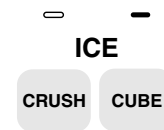

For crushed ice, cubes are crushed before being dispensed. This may cause a slight delay when dispensing crushed ice. Noise from the ice crusher is normal, and pieces of ice may vary in size. When changing from CRUSH to CUBE, a few ounces of crushed ice will be dispensed along with the first cubes.

To dispense ice:

1. Press button for the desired type of ice.
2. Press a sturdy glass against the ice dispenser lever. Hold the glass close to the dispenser opening so ice does not fall outside of the glass.

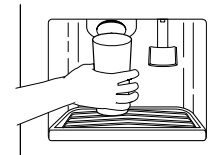

IMPORTANT: You do not need to apply a lot of pressure to the lever in order to activate the ice dispenser. Pressing hard will not make the ice dispense faster or in greater quantities.

3. Remove the glass to stop dispensing.

NOTE: The first few batches of ice may have an off-flavor from new plumbing and parts. Throw the ice away. Also, take large amounts of ice from the ice bin, not through the dispenser.

The Water Dispenser

If you did not flush the water system when the refrigerator was first installed, press the water dispenser bar with a glass or jar until you draw and discard 2 to 3 gal. (8 to 12 L) or approximately 6 to 7 minutes of water after water begins dispensing. It will take 3 to 4 minutes for the water to begin dispensing. The water you draw and discard cleans the system and helps clear air from the lines. Allow several hours for the refrigerator to cool down and chill water.

IMPORTANT: Depending on your model, the small removable tray at the bottom of the dispenser is designed to catch small spills and allow for easy cleaning. There is no drain in the tray. The tray can be removed from the dispenser and carried to the sink to be emptied or cleaned.

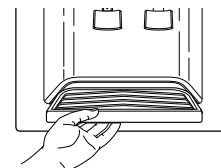

To dispense water:

1. Press a glass against the water dispenser lever.
2. Remove the glass to stop dispensing.

NOTE: Water may have an off-flavor if you do not use the dispenser periodically. Dispense enough water every week to maintain a fresh supply.



The Dispenser Light

The dispenser area has a light. It can be turned on manually by pressing the ON button (touchpad or rocker switch).

On some models: Whenever you use the dispenser, the lever will automatically turn the light on.

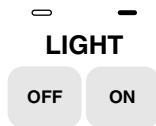

NOTE: See the “Changing the Light Bulbs” section for information on changing the dispenser light bulb.

The Dispenser Lock (on some models)

Your dispenser can be turned off for easy cleaning or to prevent accidental dispensing by small children and pets.

NOTE: The lock feature does not shut off power to the product, to the ice maker, or to the dispenser light. It simply deactivates the dispenser levers.

To turn off the dispenser, press the LOCK button. The indicator will appear above the LOCK button and the ice and water dispensers will not work. To unlock the dispenser, press the UNLOCK button until the indicator appears. Then continue to dispense ice or water as usual.

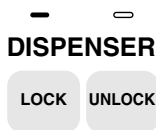

Water Filter Status Light

The water filter status light will help you know when to change your water filter cartridge. The light is located at the top of the refrigerator compartment. The light will change from green to yellow. This tells you that it is almost time to change the water filter cartridge (90% of the filter life has been used). It is recommended that you replace the base grille water filter cartridge when the water filter indicator light changes to red OR water flow to your water dispenser or ice maker decreases noticeably. See “Changing the Water Filter Cartridge” later in this section.

After changing the water filter cartridge, reset the water filter status light by pressing the light switch 5 times within 10 seconds. The indicator light will change from red to green when the system is reset.

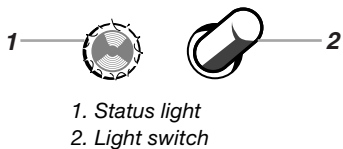

Non-indicator Water Filter (on some models)

If your refrigerator does not have the water filter status light, you should change the water filter cartridge every 6 to 9 months depending upon your usage. If the water flow to the water dispenser or ice maker decreases noticeably before 6 months have passed, replace the water filter cartridge more often.

Water Filtration System

(on some models)

NOTE: Do not use with water that is microbiologically unsafe or of unknown quality without adequate disinfection before or after the system.

Changing the Water Filter Cartridge

The base grille water filter is located below the freezer compartment door. Depending on your model, you may have a filter that is installed behind the base grille (**Style 1**) or a filter that is installed through the base grille (**Style 2**).

Style 1: Behind the base grille filter

1. Remove the base grille (see “Door Removal” section). Rotate the cartridge counterclockwise to a vertical position and pull the filter cartridge out.

NOTE: There will be water in the cartridge. Some spilling may occur.

2. Take the new cartridge out of its packaging and remove protective cover from o-rings.
3. Push the new filter cartridge into the base until it stops. Rotate the cartridge clockwise to a horizontal position. Flush the water system (see “Flushing the Water System After Replacing Filter” later in this section).

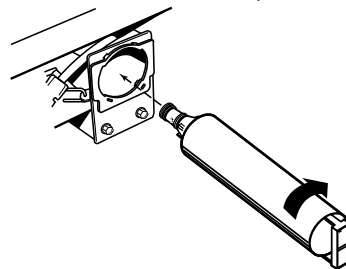

Style 2: Through the base grille filter

1. Locate the water filter cartridge cap in the front base grille. Rotate the cap counterclockwise to a vertical position and pull the cap and filter cartridge out through the base grille.

NOTE: There will be water in the cartridge. Some spilling may occur.

2. Remove the cartridge cap by sliding it off the end of the old cartridge. The cap will slide to the left or right. **DO NOT DISCARD THE CAP.**

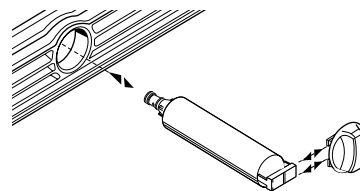

3. Take the new cartridge out of its packaging and remove protective cover from o-rings.

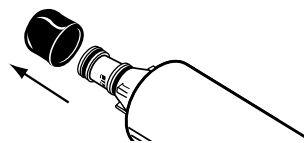

4. Slide the cartridge cap onto the new cartridge. See illustration in Step 2.

- With cartridge cap in the vertical position, push the new filter cartridge into the base grille until it stops. Rotate the cartridge cap clockwise to a horizontal position. Flush the water system (see “Flushing the Water System After Replacing Filter” later in this section).

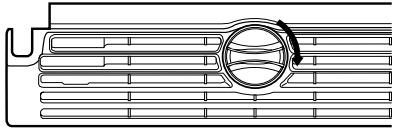

Flushing the Water System After Replacing Filter

Use a sturdy container to depress the water dispenser bar until the water begins to flow. Flush the water system by dispensing and discarding 2 to 3 gal. (8 to 12 L) of water. Cleaning the system will take approximately 6 to 7 minutes and will help clear air from the line. Additional flushing may be required in some households.

NOTE: As air is cleared from the system, water may spurt out of the dispenser.

Using the Dispenser Without the Water Filter

You can run the dispenser without a water filter cartridge. Your water will not be filtered.

- Remove the base grille water filter cartridge. For **Style 1**, replace the base grille after removing the filter.
- For **Style 2**, slide the cartridge cap off the end of the filter cartridge. **DO NOT DISCARD THE CAP.** With the cartridge cap in the vertical position, insert the cap into the base grille until it stops.

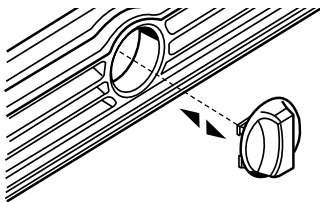

- Rotate the cartridge cap to a horizontal position. The cartridge cap might not be even with the base grille.

Ice Maker and Storage Bin

(on some models - Accessory)

To turn the ice maker on/off:

The on/off switch for the ice maker is a wire shutoff arm located on the side of the ice maker.

- To turn the ice maker on, simply lower the wire shutoff arm.

NOTE: Your ice maker has an automatic shutoff. As ice is made, the ice cubes will fill the ice storage bin and the ice cubes will raise the wire shutoff arm to the OFF (arm up) position.
- To manually turn the ice maker off, lift the wire shutoff arm to the OFF (arm up) position and listen for the click to make sure the ice maker will not continue to operate.

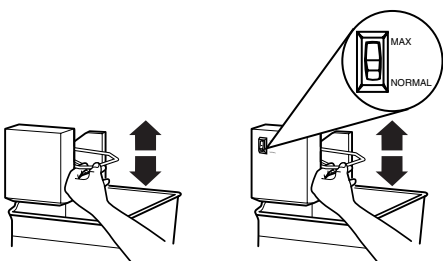

To increase ice production rate:

- Normal Ice Production:** In normal ice production mode, the ice maker should produce approximately 7 to 9 batches of ice in a 24-hour period. If ice is not being made fast enough, turn the Freezer Control toward a higher (colder) number in half number steps. (For example, if the control is at 3, move it to between 3 and 4.) Wait 24 hours between each increase.
- Maximum Ice Production (on some models):** In maximum ice production, the ice maker should produce approximately 10 to 14 batches of ice in a 24-hour period. If your refrigerator has the maximum ice production feature, push the switch to MAX.

To remove and replace the ice bin:

- Pull the covering panel out from the bottom and then slide it back toward the rear.
- Lift the wire shutoff arm so it clicks into the OFF (up) position. Ice can still be dispensed, but no more can be made.
- Lift up the front of the storage bin and pull it out.

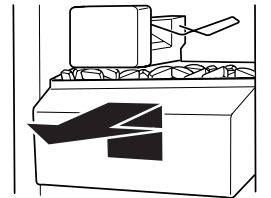

- Replace the bin by pushing it in all the way or the dispenser will not work. Push the wire shutoff arm down to the ON position to restart ice production. Make sure the door is closed tightly.

Clean the Ice Storage Bin

- Empty the ice bin. Use warm water to melt the ice if necessary.

NOTE: Never use anything sharp to break up the ice in the bin. This can cause damage to the ice container and the dispenser mechanism.
- Wash ice bin with a mild detergent, rinse well and dry thoroughly. Do not use harsh or abrasive cleaners or solvents.

REMEMBER

- Allow 24 hours to produce the first batch of ice.
- Discard the first three batches of ice produced to avoid impurities that may be flushed out of the system.
- The quality of your ice will be only as good as the quality of the water supplied to your ice maker.
- Avoid connecting the ice maker to a softened water supply. Water softener chemicals (such as salt) can damage parts of the ice maker and lead to poor quality ice. If a softened water supply cannot be avoided, make sure the water softener is operating properly and is well maintained.
- It is normal for the ice cubes to be attached at the corners. They will break apart easily.
- Do not force the wire shutoff arm up or down.
- Do not store anything on top of the ice maker or in the ice storage bin.

REFRIGERATOR FEATURES

Your model may have some or all of these features. Features that can be purchased separately as product accessories are labeled with the word "Accessory." Not all accessories will fit all models. If you are interested in purchasing one of the accessories, please call the toll-free number on the cover or in the "Accessories" section.

Important information to know about glass shelves and covers:

Do not clean glass shelves or covers with warm water when they are cold. Shelves and covers may break if exposed to sudden temperature changes or impact, such as bumping. For your protection, tempered glass is designed to shatter into many small, pebble-size pieces. This is normal. Glass shelves and covers are heavy. Use special care when removing them to avoid impact from dropping.

Refrigerator Shelves

Your model may have glass or wire shelves. Store similar foods together and adjust the shelves to fit different heights. This reduces the time the refrigerator door is open and saves energy.

Slide-out Shelves (on some models)

To remove and replace a shelf in a metal frame:

1. Pull the shelf forward to the stop. Tilt the front of the shelf up and lift it slightly as you pull the shelf from the frame.
2. Replace the shelf by guiding it back into the slots on the frame and pushing the shelf in past the stop.

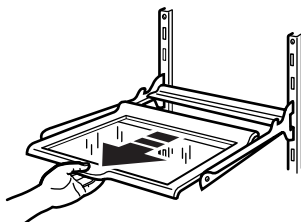

Shelves and Shelf Frames

To remove and replace a shelf/frame:

1. Remove the shelf/frame by tilting it up at the front and lifting it out of the shelf supports.
2. Replace the shelf/frame by guiding the rear shelf hooks into the shelf supports. Tilt the front of the shelf up until rear shelf hooks drop into the shelf supports. Check to make sure that the shelf is securely in position.

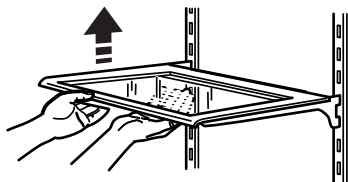

Flip-up Shelf

(on some models)

To raise or lower the shelf:

1. Raise the shelf by pulling forward on the lever located at the bottom front of the shelf and lift until the shelf locks into the vertical position.
2. Lower the shelf until it is latched securely in place.

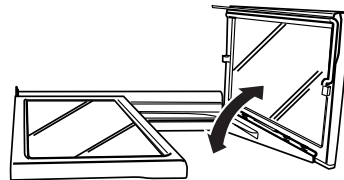

Adjustable Flip-up Shelf

(on some models)

To raise or lower the shelf:

1. Raise the shelf by first sliding it back and down to make it half-width. (You can use the shelf in this position to allow taller items to be stored on the shelf below.)
2. Lift the front of the shelf until it fits securely in place against the back wall. Lower the shelf securely back into position.
3. Pull the front of the shelf forward until it fits into place.

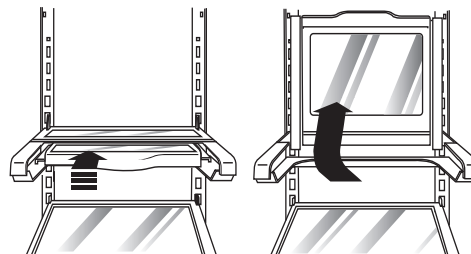

Deli Drawer

(on some models)

The deli drawer stores raisins, nuts, spreads, and other small items at normal refrigerator temperatures.

To remove and replace the deli drawer:

1. Remove the deli drawer by sliding it straight out to the stop. Lift the front and slide the drawer out the rest of the way.
2. Replace the deli drawer by sliding it back past the stop.

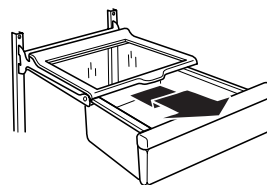

Convertible Vegetable/Meat Drawer, Crisper and Covers

(on some models)

Crisper and Convertible Vegetable Meat Drawers

To remove and replace drawers:

1. Slide crisper or meat drawer straight out to the stop. Lift the front of drawer with one hand while supporting the bottom of drawer with other hand and slide the drawer out the rest of the way.
2. Replace the crisper or meat drawer by sliding it back in fully past the drawer stop.

Crisper or Vegetable/Meat Drawer Covers

To remove and replace covers:

1. Remove the crisper and meat drawer. Press up in center of crisper glass insert until it rises above the plastic frame. Holding the crisper glass firmly, carefully slide the glass insert forward to remove.
2. Lift crisper cover frame and remove. Repeat steps to remove the meat drawer cover.

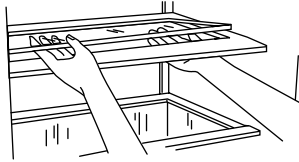

3. Replace back of meat drawer cover frame into supports or slides on side walls of the refrigerator and lower or slide the front of the cover frame into place.
4. Slide rear of glass insert into cover frame and lower front into place. Repeat steps to replace the crisper cover.

Convertible Vegetable/Meat Drawer Temperature Control

The convertible vegetable/meat drawer can be adjusted to properly chill meats or vegetables. The air inside the pan is cooled to prevent "spot" freezing and can be set to keep meats at the National Livestock and Meat Board recommended storage temperatures of 28° - 32°F (-2° - 0°C).

IMPORTANT: To extend freshness, wrap meats in airtight, moisture-proof materials before storing. Always store meat as recommended.

Adjusting the Control

The convertible control comes preset at the lowest meat setting.

To change a control setting: Move the control to the right (colder) or to the left (less cold) as desired.

To store vegetables: Set the control to VEG (all the way to the left) to store vegetables at their optimal storage temperatures (which need to be warmer than those for meat).

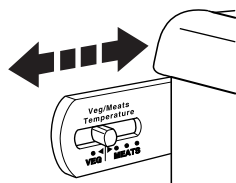

IMPORTANT: If food starts to freeze, move the control to the left (less cold). Remember to wait 24 hours between adjustments. Doing so gives the temperature of the food time to change.

Meat Storage Guide

Store most meat in original wrapping as long as it is airtight and moisture-proof. Rewrap if necessary. See the following chart for storage times. When storing meat longer than the times given, freeze the meat.

Fresh fish or shellfish..... use same day as purchased
 Chicken, ground beef, variety meat (liver, etc.) 1-2 days
 Cold cuts, steaks/roasts 3-5 days
 Cured meats 7-10 days
 Leftovers - Cover leftovers with plastic wrap, aluminum foil, or plastic containers with tight lids.

Crisper Humidity Control

(on some models)

You can control the amount of humidity in the moisture-sealed crisper. Adjust the control to any setting between LOW and HIGH.

LOW (open) lets moist air out of the crisper for best storage of fruits and vegetables with skins.

- Fruit: Wash, let dry and store in refrigerator in plastic bag or crisper. Do not wash or hull berries until they are ready to use. Sort and keep berries in original container in crisper, or store in a loosely closed paper bag on a refrigerator shelf.

- Vegetables with skins: Place in plastic bag or plastic container and store in crisper.

HIGH (closed) keeps moist air in the crisper for best storage of fresh, leafy vegetables.

- Leafy vegetables: Wash in cold water, drain and trim or tear off bruised and discolored areas. Place in plastic bag or plastic container and store in crisper.

Humidity control location:

- Humidity Control on crisper drawer (**Style 1** - on left)
- Humidity Control on crisper cover (**Style 2** - on right)

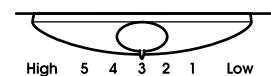
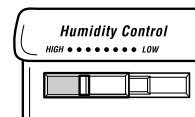

Wine or Can/Bottle Rack

(on some models - Accessory)

To remove and replace the wine rack (left) or can/bottle rack (right):

1. Remove the rack by pulling it straight out from the shelf.
2. Replace the rack by sliding it in between the shelf and the wall of the refrigerator.

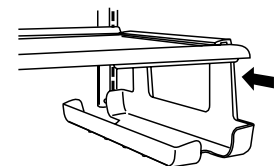
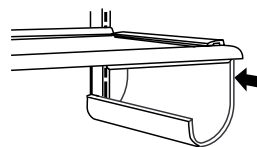

Utility Bin

(on some models - Accessory)

NOTE: For long-term storage, place eggs in a covered container or in their original carton on an interior shelf.

FREEZER FEATURES

Your model may have some or all of these features. Features that can be purchased separately as product accessories are labeled with the word "Accessory." Not all accessories will fit all models. If you are interested in purchasing one of the accessories, please call the toll-free number on the cover or in the "Accessories" section.

Freezer Shelf

(number of shelves varies with model)

To remove and replace the shelf:

1. Lift the shelf off of the supports.
2. Slide it out of the shelf support holes.
3. Replace shelf in the reverse order.

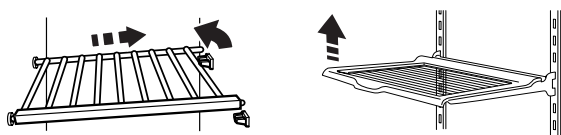

Frozen Food Storage Guide

Storage times will vary according to the quality and type of food, the type of packaging or wrap used (should be airtight and moisture-proof), and the storage temperature. Ice crystals inside a sealed package are normal. This simply means that moisture in the food and air inside the package have condensed, creating ice crystals.

Put no more unfrozen food into the freezer than will freeze within 24 hours (no more than 2 to 3 lbs. of food per cubic foot [907-1,350 g per L] of freezer space). Leave enough space in the freezer for air to circulate around packages. Be careful to leave enough room for the door to close tightly.

For more information on preparing food for freezing, check a freezer guide or reliable cookbook.

Freezer Basket or Bin

(plastic bin on some models)

The freezer basket or bin can be used to store bags of frozen fruits and vegetables that may slide off freezer shelves.

To remove and replace the freezer basket or bin:

1. Remove basket or bin by sliding it out to the stop.
2. Lift the front of the basket or bin and slide it out the rest of the way.



3. Replace the basket or bin by positioning it on the side wall guide rails. Lift the basket or bin front slightly while pushing it past the guide rail stops and slide basket or bin in the rest of the way.

DOOR FEATURES

Your model may have some or all of these features. Features that can be purchased separately as product accessories are labeled with the word "Accessory." Not all accessories will fit all models. If you are interested in purchasing one of the accessories, please call the toll-free number on the cover or in the "Accessories" section.

Door Rails

The door rails may be removed for easier cleaning.

Snap-on Door Rails

To remove and replace the rails:

1. Remove the rails by pushing in slightly on the front of the bracket while pulling out on the inside tab. Repeat these steps for the other end of the rail.
2. Replace the rails by aligning the ends of the brackets with the buttons on the sides of the door liner. Firmly snap bracket and rail assembly onto the tabs above the shelf as shown.

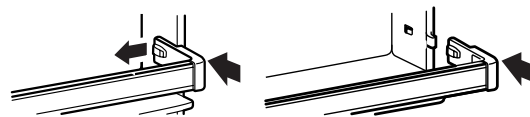

Drop-in Door Rails

To remove and replace the rails:

1. Remove the rails by pulling straight up on each end of the rail.
2. Replace the rails by sliding the shelf rail into the slots on the door and pushing the rail straight down until it stops.

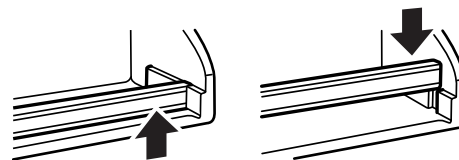

Can Racks and Door Bins

(on some models)

NOTE: Can racks may be purchased as an Accessory for some models.

To remove and replace the racks/bins:

1. Remove the rack/bin by lifting it and pulling it straight out.
2. Replace the rack/bin by sliding it in above the desired support and pushing it down until it stops.

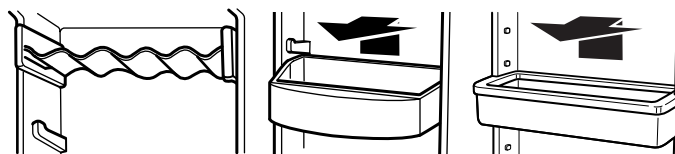

REFRIGERATOR CARE

Cleaning

⚠ WARNING



Explosion Hazard

Use nonflammable cleaner.

Failure to do so can result in death, explosion, or fire.

Both the refrigerator and freezer sections defrost automatically. However, clean both sections about once a month to prevent odors from building up. Wipe up spills immediately.

Cleaning your refrigerator

1. Unplug refrigerator or disconnect power.
2. Remove all removable parts from inside, such as shelves, crispers, etc.
3. Hand wash, rinse, and dry removable parts and interior surfaces thoroughly. Use a clean sponge or soft cloth and a mild detergent in warm water.
 - Do not use abrasive or harsh cleaners such as window sprays, scouring cleansers, flammable fluids, cleaning waxes, concentrated detergents, bleaches or cleansers containing petroleum products on plastic parts, interior and door liners or gaskets. Do not use paper towels, scouring pads, or other harsh cleaning tools. These can scratch or damage materials.
 - To help remove odors, you can wash interior walls with a mixture of warm water and baking soda (2 tbs. to 1 qt. [26 g to .95 L] of water).
4. Determine whether your refrigerator exterior is painted metal, brushed aluminum or stainless steel and choose the appropriate cleaning method.

Painted metal: Wash exteriors with a clean sponge or soft cloth and a mild detergent in warm water. Do not use abrasive or harsh cleaners, or cleaners designed for stainless steel. Dry thoroughly with a soft cloth. For additional protection against damage to painted metal exteriors, apply appliance wax (or auto paste wax) with a clean, soft cloth. Do not wax plastic parts.

Brushed Aluminum: Wash with a clean sponge or soft cloth and a mild detergent in warm water. Do not use abrasive or harsh cleaners, or cleaners designed for stainless steel. Dry thoroughly with a soft cloth.

Stainless steel finish: Wash with a clean sponge or soft cloth and a mild detergent in warm water. Do not use abrasive or harsh cleaners, or cleaners designed for stainless steel. Dry thoroughly with a soft cloth.

- To keep your Stainless Steel refrigerator looking like new and to remove minor scuffs or marks, it is suggested that you use the manufacturer's approved Stainless Steel Cleaner & Polish.

IMPORTANT: This cleaner is for Stainless Steel parts only!

Do not allow the Stainless Steel Cleaner & Polish to come into contact with any plastic parts such as the trim pieces, dispenser covers or door gaskets. If accidental contact does occur, clean plastic part with a sponge and mild detergent in warm water. Dry thoroughly with a soft cloth. To order the cleaner, see the "Accessories" section.

5. There is no need for routine condenser cleaning in normal home operating environments. If the environment is particularly greasy or dusty, or there is significant pet traffic in the home, the condenser should be cleaned every 2 to 3 months to ensure maximum efficiency.

If you need to clean the condenser:

- Remove the base grille. See "Base Grille" or "Door Removal" section.
 - Use a vacuum cleaner with a soft brush to clean the grille, the open areas behind the grille and the front surface area of the condenser.
 - Replace the base grille when finished.
6. Plug in refrigerator or reconnect power.

Changing the Light Bulbs

NOTE: Not all appliance bulbs will fit your refrigerator. Be sure to replace the bulb with one of the same size and shape. The dispenser light requires a heavy duty 10-watt bulb. All other lights require a 40-watt appliance bulb. Replacement bulbs are available from your dealer.

1. Unplug refrigerator or disconnect power.
2. Remove light shield when applicable as shown.

NOTE: To clean the light shield, wash it with warm water and liquid detergent. Rinse and dry the shield well.
3. Remove light bulb and replace with one of the same size, shape and wattage.
4. Replace light shield when applicable as shown.
5. Plug in refrigerator or reconnect power.

Dispenser Light (on some models)

Reach through the dispenser area to remove and replace light bulb.

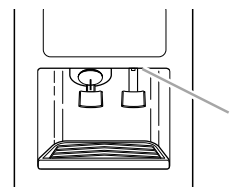

1. Dispenser light

Refrigerator Control Panel Light

Reach behind the refrigerator control panel to remove and replace light bulb.

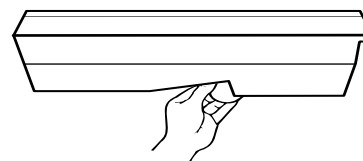

Crisper Lights

- If necessary, remove the top crisper drawer to access the crisper light shield. Remove the light shield by lifting the ends out of the brackets as shown.
- Replace the light shield by inserting the ends into the brackets. If necessary, replace the top crisper drawer.

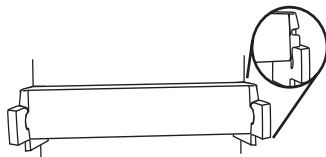

Upper Freezer Light (on some models)

Style 1

- Remove light shield by grasping the top center of the shield and pulling forward while turning it slightly to one side. If necessary, remove top crisper drawer to gain access to the crisper light shield.
- Replace the light shield by inserting the tabs on one end into the slotted holes in the refrigerator or freezer liner. Then, carefully bend the shield at the center to insert the tabs on the other end.

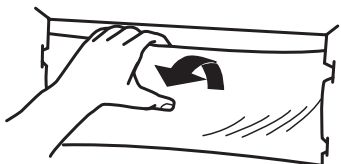

Style 2

- Remove the light shield by squeezing the sides of the light shield in toward the center while pulling the shield forward as shown.
- Replace the light shield by fitting the tabs into the slotted holes in the freezer liner. Push in the shield until it snaps into place.

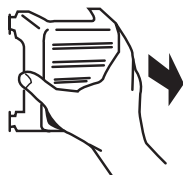

Lower Freezer Light (on some models)

Style 1 - Beneath Ice Bin

- Remove the light shield by grasping the sides and squeezing in toward the center. Once the side hooks of shield are free from the freezer lining, pull down the shield.
- Replace the light shield by squeezing the sides toward the center and inserting the side hooks into the slotted holes. Once the side hooks are in place, snap the front tab into the slotted hole.

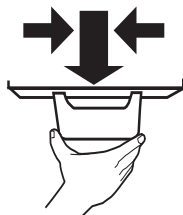

Style 2 - Behind Freezer Basket

- Depending on your model, remove the top freezer basket or top freezer basket shelf. Remove light shield by removing the Phillips screw on the top of the shield. Carefully rotate the shield until the left tab can be gently pulled from the freezer wall.
- Replace the light shield by inserting the left tab into the freezer wall. Align top tab with screw hole and replace screw.

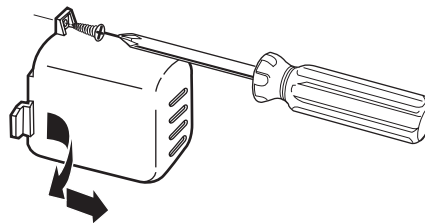

Power Interruptions

If the power will be out for 24 hours or less, keep both refrigerator doors closed to help food stay cold and frozen.

If the power will be out for more than 24 hours, do one of the following:

- Remove all frozen food and store it in a frozen food locker.
- Place 2 lbs (907 g) of dry ice in the freezer for every cubic foot (28 L) of freezer space. This will keep the food frozen for 2 to 4 days.
- If neither a food locker nor dry ice is available, consume or can perishable food at once.

REMEMBER: A full freezer stays cold longer than a partially filled one. A freezer full of meat stays cold longer than a freezer full of baked goods. If you see that food contains ice crystals, it may be refrozen, although the quality and flavor may be affected. If the condition of the food is poor, dispose of it.

Vacation and Moving Care

Vacations

If you choose to leave the refrigerator on while you're away:

1. Use up any perishables and freeze other items.
2. If your refrigerator has an automatic ice maker:
 - Raise wire shutoff arm to OFF (up) position or move the switch to the OFF (right) setting.
 - Shut off water supply to the ice maker.
3. Empty the ice bin.

If you choose to turn the refrigerator off before you leave:

1. Remove all food from the refrigerator.
2. If your refrigerator has an automatic ice maker:
 - Turn off the water supply to the ice maker at least one day ahead of time.
 - When the last load of ice drops, raise the wire shutoff arm to the OFF (up) position or move the switch to the OFF (right) setting.
3. Depending on your model, turn the Thermostat Control or Refrigerator Control to OFF. See the "Using the Controls" section.
4. Clean refrigerator, wipe it, and dry well.
5. Tape rubber or wood blocks to the tops of both doors to prop them open far enough for air to get in. This stops odor and mold from building up.

Moving

When you are moving your refrigerator to a new home, follow these steps to prepare it for the move.

1. If your refrigerator has an automatic ice maker:
 - Turn off the water supply to the ice maker at least one day ahead of time.
 - Disconnect the water line from the back of the refrigerator.
 - When the last load of ice drops, raise the wire shutoff arm to the OFF (up) position or move the switch to the OFF (right) setting.
2. Remove all food from the refrigerator and pack all frozen food in dry ice.
3. Empty the ice bin.
4. Depending on your model, turn the Thermostat Control or Refrigerator Control to OFF. See the “Using the Controls” section.
5. Unplug refrigerator.
6. Empty water from the defrost pan.
7. Clean, wipe, and dry thoroughly.
8. Take out all removable parts, wrap them well, and tape them together so they don't shift and rattle during the move.
9. Depending on the model, raise the front of the refrigerator so it rolls more easily OR screw in the leveling legs so they don't scrape the floor. See the “Door Closing” or “Leveling Your Refrigerator” section.
10. Tape the doors closed and tape the power cord to the refrigerator cabinet.

When you get to your new home, put everything back and refer to the “Installation Instructions” section for preparation instructions. Also, if your refrigerator has an automatic ice maker, remember to reconnect the water supply to the refrigerator.

TROUBLESHOOTING

Try the solutions suggested here first in order to avoid the cost of an unnecessary service call.

Your refrigerator will not operate

- **Is the power supply cord unplugged?** Plug into a grounded 3 prong outlet.
- **Has a household fuse or circuit breaker tripped?** Replace the fuse or reset the circuit breaker.
- **Is the refrigerator or freezer control turned to the OFF position?** See “Using the Controls.”
- **Is the refrigerator defrosting?** Recheck to see whether the refrigerator is operating in 30 minutes. Your refrigerator will regularly run an automatic defrost cycle.
- **Is the refrigerator not cooling?** For models with digital controls, turn the unit OFF then ON again to reset. See “Using the Controls.” If this does not correct the problem, call for service.

The lights do not work

- **Is the power supply cord unplugged?** Plug into a grounded 3 prong outlet.
- **Is a light bulb loose in the socket or burned out?** See “Changing the Light Bulbs.”

There is water in the defrost drain pan

- **Is the refrigerator defrosting?** The water will evaporate. It is normal for water to drip into the defrost pan.
- **Is it more humid than normal?** When it is humid, expect that the water in the defrost pan will take longer to evaporate.

The motor seems to run too much

- **Is the room temperature hotter than normal?** The motor will run longer under warm conditions. At normal room temperatures, expect your motor to run about 40% to 80% of the time. Under warmer conditions, it will run even more.
 - **Has a large amount of food just been added to the refrigerator?** Adding a large amount of food warms the refrigerator. The motor normally will run longer to cool the refrigerator back down.
 - **Are the doors opened often?** The motor will run longer when this occurs. Conserve energy by getting all items out at one time, keeping food organized, and closing the door as soon as possible.
 - **Are the controls not set correctly for the surrounding conditions?** See “Using the Controls.”
 - **Are the doors not closed completely?** Close the doors firmly. If they do not close completely, see “The doors will not close completely” later in this section.
 - **Are the condenser coils dirty?** This prevents air transfer and makes the motor work harder. Clean the condenser coils. See “Cleaning.”
 - **Are the door gaskets not sealed all the way around?** Contact a technician or other qualified person.
- NOTE:** Your new refrigerator will run longer than your old one due to its high-efficiency motor.

The refrigerator seems to make too much noise

- The sounds may be normal for your refrigerator. See “Normal Sounds.”

The ice maker is not producing ice or not enough ice

- **Has the ice maker just been installed?** Wait 72 hours for full ice production to begin. Once your refrigerator is cooled, the ice maker should produce 70 to 120 cubes every 24 hours.
- **Is the freezer temperature cold enough to produce ice?** Wait 24 hours after ice maker hookup for ice production. See “Using the Controls.”
- **Is the ice maker wire shutoff arm in the OFF (arm up) position (on some models)?** Lower the wire shutoff arm to the ON (arm down) position. See “Ice Maker and Storage Bin.”
- **Is the ice maker switch in the OFF (right) position (on some models)?** Move ice maker switch to the ON (left) position. See “Ice Maker and Storage Bin.”
- **Is the water line shutoff valve to the refrigerator turned on?** Turn on the water valve. See “Water Supply Connection.”
- **Does the ice maker mold have water in it or has no ice been produced?** Make sure your refrigerator has been connected to a water supply and the supply shutoff valve is turned on. See “Water Supply Connection.”

- **Is an ice cube jammed in the ice maker ejector arm?** For models with a standard ice storage bin, remove the ice from the ejector arm with a plastic utensil. For models with an ice storage bin on the freezer door, access the ice maker by depressing the ice sensor door on the upper left side of the freezer interior. While depressing the sensor door, lift the ice maker service door and remove the ice from the ejector with a plastic utensil. See “Ice Maker and Storage Bin.”
- **Has a large amount of ice just been removed?** Allow 24 hours for ice maker to produce more ice.
- **Are the controls set correctly?** See “Using the Controls.”
- **Is there a water filter installed on the refrigerator?** The filter may be clogged or installed incorrectly. Check the filter installation instructions to ensure that the filter was installed correctly and is not clogged. If installation or clogging is not a problem, call a technician or other qualified person.
- **Is a reverse osmosis water filtration system connected to your cold water supply?** See “Water Supply Requirements.”

NOTE: If not due to any of the above, there may be a problem with the water line. Call for service.

Off-taste, odor or gray color in the ice

- **Are the plumbing connections new, causing discolored or off-flavored ice?** Discard the first few batches of ice.
- **Have the ice cubes been stored too long?** Throw old ice away and make a new supply.
- **Does the freezer and ice storage bin need to be cleaned?** See “Cleaning” or “Ice Maker and Storage Bin.”
- **Has food in the freezer or refrigerator been wrapped properly?** Use airtight, moisture-proof packaging to help prevent odor transfer to stored food.
- **Does the water contain minerals (such as sulfur)?** A filter may need to be installed to remove the minerals.
- **Is there a water filter installed on the refrigerator?** Gray or dark discoloration in ice indicates that the water filtration system needs additional flushing. Run additional water through the water dispenser to flush the water filtration system more thoroughly (at least 2 to 3 gal. [8 to 12 L] or 6 to 7 minutes initially). Discard discolored ice.

The ice dispenser will not operate properly

- **Is the freezer door closed completely?** Push the door firmly closed. If it will not close all the way, see “The doors will not close completely” later in this section.
- **Is the ice storage bin installed correctly?** For models with a standard ice storage bin, push the ice storage bin in all the way. For models with an ice storage bin on the freezer door, the bin should sit level. Remove and replace the bin in the door making sure it is properly aligned and snapped securely into place. See “Ice Maker and Storage Bin.”
- **Has the wrong ice been added to the bin?** Use only cubes produced by the current ice maker. If other cubes have been added, remove all cubes and check to see that none have become stuck in the delivery chute.
- **Has the ice frozen in the ice storage bin?** Shake the ice storage bin to separate cubes. If cubes do not separate, empty bin and wait 24 hours for ice to restock.
- **Has the ice melted around the auger (metal spiral) in the ice storage bin?** Dump the ice cubes and clean the ice storage bin completely. Allow 24 hours for the ice maker to restock. Do not try to remove the melted ice with a sharp object. You could damage the ice storage bin.

- **Is ice stuck in the delivery chute?** Clear the ice from the delivery chute with a plastic utensil. Do not use anything sharp to remove the ice. You could cause damage.
- **Is the ice dispenser stalling while dispensing “crushed” ice?** Stop dispensing ice. Change the ice button from “crushed” to “cubed.” Depress the ice dispenser arm using a sturdy glass. If cubed ice dispenses correctly, depress the button for “crushed” ice and begin dispensing again. See “Water and Ice Dispensers.”
- **Is there ice in the storage bin?** See “The ice maker is not producing ice” earlier in this section.
- **Has the dispenser arm been held in too long?** Release dispenser arm. Ice will stop dispensing when the arm is held in too long. Wait 3 minutes for dispenser motor to reset before using again. It is best to take large amounts of ice directly from the ice storage bin, not through the dispenser.

Ice storage bin difficult to remove

- **Is the ice storage bin difficult to remove (on some models)?** For models with an ice storage bin located on the freezer door, select “cubed” ice. Using a sturdy glass, quickly depress and release the ice dispenser arm. Open the freezer door, depress the release button on the ice storage bin and lift upward. See “Ice Maker and Storage Bin.”

The water dispenser will not operate properly

- **Has the water system not filled?** The water system needs to be filled the first time it is used. Use a sturdy container to depress the water dispenser bar until the water begins to flow. Flush the water system by dispensing and discarding 2 to 3 gal. (8 to 12 L) of water. Cleaning the system will take approximately 6 to 7 minutes and will help clear air from the line. Additional flushing may be required in some households. See “Water and Ice Dispensers.”
- **Is the water shutoff valve not turned on or the water line connected at the source?** Make sure the water shutoff valve is turned on and the water source is connected to the refrigerator. See “Water Supply Connection.”
- **Is the water shutoff valve clogged or incorrectly installed?** See “Water Supply Connection.” If clogging or installation is not a problem, call for service or contact a plumber.
- **Is there a kink in the home water source line?** If you find or suspect a kink in the water line, contact a licensed, qualified plumber.
- **Is there a water filter installed on the refrigerator?** The filter may be clogged or incorrectly installed. First, check the filter installation instructions to ensure that the filter was installed correctly and is not clogged. If installation or clogging is not a problem, call for service.
- **Is a reverse osmosis water filtration system connected to your cold water supply?** See “Water Supply Requirements.”

Water or ice is leaking from the dispenser

- **Is the glass not being held under the ice dispenser long enough, causing the ice to spill?** Hold the container under the ice chute for 2 to 3 seconds after releasing the dispenser lever. Water or ice may continue to dispense during this time.
- **Is an ice cube stuck in the chute and holding the trap door open?** Remove the cube.

- **Is there a water filter installed on the refrigerator?** The water filtration system may have air in the lines, causing water to drip. Additional flushing may help clear air from the lines. Normal dispenser use should flush air from the lines within 24 to 72 hours.

Water flow from the dispenser decreases noticeably

- **Is there a water filter installed on the refrigerator?** The filter may be full or incorrectly installed. Remove the water filter cartridge. See “Water Filtration System.” Operate the dispenser. If the water flow increases noticeably, replace the filter.

The dispenser water is not cool enough

- **Has the refrigerator been newly installed?** Allow 24 hours for the refrigerator to cool completely.
- **Has a large amount of water been recently dispensed?** Allow 24 hours for the water to cool completely.
- **Has water not been recently dispensed?** The first glass of water may not be cool. Discard the first glass of water.

The divider between the two compartments is warm

- The warmth is probably due to normal operation of the automatic exterior moisture control. If still concerned, call for service.

Temperature is too warm

- **Are the air vents blocked in either compartment?** This prevents the movement of cold air from the freezer to the refrigerator. Remove any objects from in front of the air vents. See “Ensuring Proper Air Circulation” for the location of air vents.
- **Are the door(s) opened often?** The refrigerator will warm when this occurs. Keep the refrigerator cool by getting all items out at one time, keeping food organized, and closing the door as soon as possible.
- **Has a large amount of food just been added to the refrigerator or freezer?** Adding a large amount of food warms the refrigerator. It can take several hours for the refrigerator to return to the normal temperature.
- **Are the controls set correctly for the surrounding conditions?** See “Using the Controls.”
- **Is the refrigerator not cooling?** For models with digital controls, turn the unit OFF then ON again to reset. See “Using the Controls.” If this does not correct the problem, call for service.

There is interior moisture buildup

- **Are the air vents blocked in the refrigerator?** Remove any objects from in front of the air vents. See “Ensuring Proper Air Circulation” for the location of air vents.
- **Are the doors opened often?** Avoid humidity buildup by getting all items out at one time, keeping food organized, and closing the door as soon as possible.
- **Is the room humid?** It is normal for moisture to build up inside the refrigerator when the room air is humid.

- **Is the food packaged correctly?** Check that all food is securely wrapped. Wipe off damp food containers before placing in the refrigerator.
- **Are the controls set correctly for the surrounding conditions?** See “Using the Controls.”
- **Was a self-defrost cycle completed?** It is normal for droplets to form after the refrigerator self-defrosts.

The doors will not close completely

- **Are food packages blocking the door open?** Rearrange containers so that they fit more tightly and take up less space.
- **Is the ice storage bin out of position?** For models with an interior ice storage bin, push the ice storage bin in all the way. If the ice storage bin does not go in all the way, it may not be put in straight. Pull it out and try again. For models with an ice storage bin located on the freezer door, the bin should sit level. To remove the bin, press the release button on the right side of the bin and lift straight up. Replace the bin in the door making sure it is properly aligned and snapped securely into place. See “Ice Maker and Storage Bin.”
- **Are the pans, shelves, bins, or baskets out of position?** Put the crisper cover and all pans, shelves, bins, and baskets back into their correct positions. See the “Convertible Vegetable/Meat Drawer, Crisper and Covers” section for more information.
- **Are the gaskets sticking?** Clean gaskets according to the directions in the “Cleaning” section.
- **Does the refrigerator wobble or seem unstable?** Level the refrigerator. See “Door Closing.”
- **Were the doors removed during product installation and not properly replaced?** Remove and replace the doors according to the instructions in the “Door Removal” section, or call a qualified service technician.

The doors are difficult to open

- **Are the gaskets dirty or sticky?** Clean gaskets according to the directions in the “Cleaning” section.

ASSISTANCE OR SERVICE

Before calling for assistance or service, please check “Troubleshooting.” It may save you the cost of a service call. If you still need help, follow the instructions below.

When calling, please know the purchase date and the complete model and serial number of your appliance. This information will help us to better respond to your request.

If you need replacement parts

If you need to order replacement parts, we recommend that you only use factory specified replacement parts. Factory specified replacement parts will fit right and work right because they are made with the same precision used to build every new CROSLEY® appliance.

To locate factory specified replacement parts in your area, call our Customer Interaction Center telephone number or your nearest designated service center.

In the U.S.A.

Call the Whirlpool Customer Interaction Center
toll free: **1-800-253-1301**.

Our consultants provide assistance with:

- Features and specifications on our full line of appliances.
- Installation information.
- Use and maintenance procedures.
- Accessory and repair parts sales.
- Specialized customer assistance (Spanish speaking, hearing impaired, limited vision, etc.).
- Referrals to local dealers, repair parts distributors, and service companies. Whirlpool designated service technicians are trained to fulfill the product warranty and provide after-warranty service, anywhere in the United States.

To locate the Whirlpool designated service company in your area, you can also look in your telephone directory Yellow Pages.

For further assistance

If you need further assistance, you can write to Crosley with any questions or concerns at:

Crosley Distribution Center
c/o Correspondence Dept.
675 North Main Street
Winston-Salem, NC 27102-2111

Please include a daytime phone number in your correspondence.

Accessories

To order accessories, call **1-800-442-9991** and ask for the appropriate part number listed below or contact your authorized Crosley dealer.

Stainless Steel Cleaner & Polish

Order Part #4396095

Base grille water filter cartridges:

NOTE: Do not use with water that is microbiologically unsafe or of unknown quality without adequate disinfection before or after the system.

Standard Cartridge:

Order Part #4392857 (NLC-300 and WF-L500)

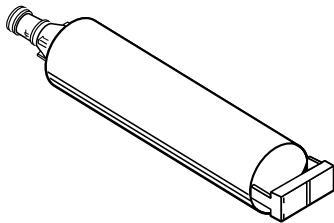

WATER FILTER CERTIFICATIONS

State of California
Department of Health Services
Water Treatment Device
Certificate Number

98 - 1344

Date Issued: June 9, 1998

Trademark/Model Designation

WF-NL300

Replacement Elements

NL300

Manufacturer: Whirlpool Corp.

The water treatment device(s) listed on this certificate have met the testing requirements pursuant to Section 116830 of the Health and Safety Code for the following health related contaminants:

Microbiological Contaminants and Turbidity

None

Inorganic/Radiological Contaminants

Lead

Organic Contaminants

None

Rated Service Capacity: 300 gallons

Rated Service Flow: 0.5 gpm

Do not use with water that is microbiologically unsafe or of unknown quality, without adequate disinfection before or after the system.

State of California
Department of Health Services
Water Treatment Device
Certificate Number

98 - 1343

Date Issued: June 9, 1998

Trademark/Model Designation

WF-L500

Replacement Elements

L500

Manufacturer: Whirlpool Corp.

The water treatment device(s) listed on this certificate have met the testing requirements pursuant to Section 116830 of the Health and Safety Code for the following health related contaminants:

Microbiological Contaminants and Turbidity

None

Inorganic/Radiological Contaminants

Lead

Organic Contaminants

None

Rated Service Capacity: 500 gallons

Rated Service Flow: 0.5 gpm

Do not use with water that is microbiologically unsafe or of unknown quality, without adequate disinfection before or after the system.

PRODUCT DATA SHEETS

Base Grille Water Filtration System Model WF-NL300/NL300 capacity 300 Gallons (1136 Liters) Model WF-L500/L500 capacity 500 Gallons (1893 Liters)



System tested and certified by NSF International against ANSI/NSF Standard 53 for the reduction of **Lead**; and against Standard ANSI/NSF 42 for the reduction of **Taste and Odor, Chlorine Class I**.

This system has been tested according to ANSI/NSF 42/53 for the reduction of the substances listed below. The concentration of the indicated substances in water entering the system was reduced to a concentration less than or equal to the permissible limit for water leaving the system, as specified in ANSI/NSF 42/53.

Contaminant Reduction	Average Influent mg/L	Influent Challenge Concentration	Product Water mg/L	Average % Reduction	Max. Permissible Concentration mg/L	Max. Effluent mg/L	Min. % Reduction
Lead: @ pH 6.5	0.16	0.15 mg/L $\pm 10\%$	0.0024	98.4	0.01	.005	97
Lead: @ pH 8.5	0.17	0.15 mg/L $\pm 10\%$	0.0045	97.4	0.01	.009	95
Substance Reduction					Min. Required % reduction		
Chlorine, Taste/Odor	2.0	2.0 mg/L $\pm 10\%$	0.14	93.0	$\geq 75\%$	N/A	N/A

Test Parameters: pH = 7.5 \pm 0.5 unless otherwise noted. Flow = 0.5 gpm (1.9 Lpm). Pressure = 60 psig (413.7 kPa). Temp. = 63°F (17.2°C).

- It is essential that operational, maintenance, and filter replacement requirements be carried out for the product to perform as advertised.
- Using Replacement Cartridge NL300 - Model WF-NL300:**
The concentration of the indicated substances in water entering the system was reduced to a concentration less than or equal to the permissible limit for water leaving the system as specified in ANSI/NSF 42 and 53. Change cartridge at least every 6-9 months. Use replacement cartridge NL 300, part# 4392857. 2003 suggested retail price of \$29.95 U.S.A./\$39.95 Canada. Prices are subject to change without notice.
- Using Replacement Cartridge L500 - Model WF-L500:**
The concentration of the indicated substances in water entering the system was reduced to a concentration less than or equal to the permissible limit for water leaving the system as specified in ANSI/NSF 42 and 53. The filter monitor system measures the amount of water that passes through the filter and alerts you to replace the filter. When 90% of the filter's rated life is used, the filter indicator light changes from green to yellow. When 100% of the filter's rated life is used, the filter indicator light changes from yellow to red, and it is recommended that you replace the filter. Use replacement cartridge L500, part# 4392857. 2003 suggested retail price of \$29.95 U.S.A./\$39.95 Canada. Prices are subject to change without notice.
- The product is for cold water use only.
- Do not use with water that is microbiologically unsafe or of unknown quality without adequate disinfection before or after the system.**
- Refer to the "Assistance or Service" section for parts and service availability or for the Manufacturer's name, address and telephone number.
- Refer to the "Warranty" section for the Manufacturer's limited warranty.
- Note that while the testing was performed under standard laboratory conditions, actual performance may vary. Systems must be installed and operated in accordance with manufacturer's recommended procedures and guidelines.

Application Guidelines/Water Supply Parameters

Water Pressure	30 - 120 psig (207 - 827 kPa)
Water Temperature	33° - 100°F (0.6° - 37.8° C)
Rated Service Flow	0.5 gpm (1.9 Lpm)

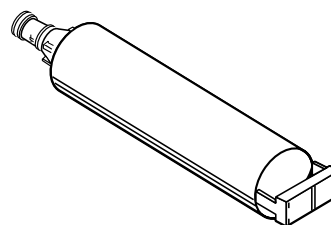

CROSLEY® REFRIGERATOR WARRANTY

ONE-YEAR FULL WARRANTY ON REFRIGERATOR

For one year from the date of purchase, when this refrigerator (excluding the water filter) is operated and maintained according to instructions attached to or furnished with the product, Whirlpool Corporation will pay for factory specified replacement parts and repair labor costs to correct defects in materials or workmanship. Service must be provided by a Whirlpool designated service company.

On models with a water filter: 30 day limited warranty on water filter. For 30 days from the date of purchase, when this filter is operated and maintained according to instructions attached to or furnished with the product, Whirlpool Corporation will pay for replacement parts to correct defects in materials and workmanship.

FIVE-YEAR FULL WARRANTY ON SEALED REFRIGERATION SYSTEM PARTS AS LISTED

For five years from the date of purchase, when this refrigerator is operated and maintained according to instructions attached to or furnished with the product, Whirlpool Corporation will pay for factory specified replacement parts and repair labor costs to correct defects in materials or workmanship in the sealed refrigeration system. These parts are: compressor, evaporator, condenser, dryer, and connecting tubing. Service must be provided by a Whirlpool designated service company.

Whirlpool Corporation will not pay for:

1. Service calls to correct the installation of your refrigerator, to instruct you how to use your refrigerator, to replace house fuses or correct house wiring or plumbing, or to replace light bulbs.
 2. Repairs when your refrigerator is used in other than normal, single-family household use.
 3. Pickup and delivery. Your refrigerator is designed to be repaired in the home.
 4. Damage resulting from accident, alteration, misuse, abuse, fire, flood, improper installation, acts of God, or use of products not approved by Whirlpool Corporation.
 5. Any food loss due to product failure.
 6. Repairs to parts or systems resulting from unauthorized modifications made to the appliance.
 7. Replacement parts and repair labor costs for units operated outside the United States.
 8. Any labor costs for replacement of the water filter during the limited warranty period.
-

WHIRLPOOL CORPORATION SHALL NOT BE LIABLE FOR INCIDENTAL OR CONSEQUENTIAL DAMAGES.

Some states do not allow the exclusion or limitation of incidental or consequential damages, so this exclusion or limitation may not apply to you. This warranty gives you specific legal rights, and you may also have other rights which vary from state to state.

Outside the 50 United States, this warranty does not apply. Contact your authorized Crosley dealer to determine if another warranty applies.

Whirlpool Corporation is responsible for providing any in-warranty service covered in this warranty. If you need service, first see the "Troubleshooting" section of this book. After checking "Troubleshooting," additional help can be found by checking the "Assistance or Service" section or by calling the Whirlpool Customer Interaction Center, **1-800-253-1301** (toll free) from anywhere in the U.S.A. or writing Crosley Distribution Center, c/o Correspondence Dept., 675 N. Main St., Winston-Salem, NC 27102-2111. 8/02

Keep this book and your sales slip together for future reference. You must provide proof of purchase or installation date for in-warranty service.

Write down the following information about your refrigerator to better help you obtain assistance or service if you ever need it. You will need to know your complete model number and serial number. You can find this information on the model and serial number label located on the inside wall of the refrigerator compartment.

Dealer name _____
Address _____
Phone number _____
Model number _____
Serial number _____
Purchase date _____