



Thinking of you
Electrolux



ESL 6610RO

.....
EN DISHWASHER

.....
USER MANUAL



CONTENTS

1. SAFETY INSTRUCTIONS	3
2. PRODUCT DESCRIPTION	5
3. CONTROL PANEL	6
4. PROGRAMMES	6
5. OPTIONS	8
6. BEFORE FIRST USE	10
7. DAILY USE	12
8. HINTS AND TIPS	13
9. CARE AND CLEANING	14
10. TROUBLESHOOTING	15
11. TECHNICAL INFORMATION	17
12. ENVIRONMENT CONCERNS	17

WE'RE THINKING OF YOU

Thank you for purchasing an Electrolux appliance. You've chosen a product that brings with it decades of professional experience and innovation. Ingenious and stylish, it has been designed with you in mind. So whenever you use it, you can be safe in the knowledge that you'll get great results every time.

Welcome to Electrolux.

Visit our website for:



Get usage advice, brochures, trouble shooter, service information:
www.electrolux.com



Register your product for better service:
www.electrolux.com/productregistration



Buy Accessories, Consumables and Original spare parts for your appliance:
www.electrolux.com/shop

CUSTOMER CARE AND SERVICE

We recommend the use of original spare parts.

When contacting Service, ensure that you have the following data available.

The information can be found on the rating plate. Model, PNC, Serial Number.



Warning / Caution-Safety information



General information and tips



Environmental information

Subject to change without notice.

1. SAFETY INSTRUCTIONS

Before the installation and use of the appliance, carefully read the supplied instructions. The manufacturer is not responsible if an incorrect installation and use causes injuries and damages. Always keep the instructions with the appliance for future reference.

1.1 Children and vulnerable people safety



WARNING!

Risk of suffocation, injury or permanent disability.

- Do not let persons, children included, with reduced physical sensory, reduced mental functions or lack of experience and knowledge use the appliance. They must have supervision or instruction for the operation of the appliance by a person who is responsible for their safety.
- Do not let children play with the appliance.
- Keep all packaging away from children.
- Keep all detergents away from children.
- Keep children and pets away from the appliance door when it is open.

1.2 Installation

- Remove all the packaging.
- Do not install or use a damaged appliance.
- Do not install or use the appliance where the temperature is less than 0 °C.
- Obey the installation instruction supplied with the appliance.
- Make sure that the appliance is installed below and adjacent to safe structures.

Electrical connection



WARNING!

Risk of fire and electrical shock.

- The appliance must be earthed.
- Make sure that the electrical information on the rating plate agrees with the power supply. If not, contact an electrician.

- Always use a correctly installed shock-proof socket.
- Do not use multi-plug adapters and extension cables.
- Make sure not to cause damage to the mains plug and to the mains cable. Should the appliance power supply cable need to be replaced, this must be carried out by our Service Centre.
- Connect the mains plug to the mains socket only at the end of the installation. Make sure that there is access to the mains plug after the installation.
- Do not pull the mains cable to disconnect the appliance. Always pull the mains plug.
- Do not touch the mains cable or the mains plug with wet hands.
- **Only for UK and Ireland.** The appliance has a 13 amp mains plug. If it is necessary to change the fuse in the mains plug, use a 13 amp ASTA (BS 1362) fuse.
- This appliance complies with the E.E.C. Directives.

Water connection

- Make sure not to cause damage to the water hoses.
- Before you connect the appliance to new pipes or pipes not used for a long time, let the water flow until it is clean.
- The first time you use the appliance, make sure that there is no leakage.
- The water inlet hose has a safety valve and a sheath with an inner mains cable.

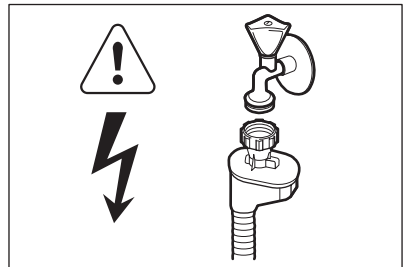

WARNING!

Dangerous voltage.

- If the water inlet hose is damaged, immediately disconnect the mains plug from the mains socket. Contact the Service to replace the water inlet hose.

1.3 Use

- This appliance is intended to be used in household and similar applications such as:
 - Staff kitchen areas in shops, offices and other working environments
 - Farm houses
 - By clients in hotels, motels and other residential type environments
 - Bed and breakfast type environments.



WARNING!

Risk of injury, burns, electrical shock or fire.

- Do not change the specification of this appliance.
- Put knives and cutlery with sharp points in the cutlery basket with the points down or in a horizontal position.
- Do not keep the appliance door open without supervision to prevent to fall on it.
- Do not sit or stand on the open door.

- Dishwasher detergents are dangerous. Obey the safety instructions on the detergent packaging.
- Do not drink and play with the water in the appliance.
- Do not remove the dishes from the appliance until the programme is completed. There can be detergent on the dishes.
- The appliance can release hot steam if you open the door while a programme operates.
- Do not put flammable products or items that are wet with flammable products in, near or on the appliance.
- Do not use water spray and steam to clean the appliance.

1.4 Disposal



WARNING!

Risk of injury or suffocation.

- Disconnect the appliance from the mains supply.
- Cut off the mains cable and discard it.
- Remove the door catch to prevent children and pets to get closed in the appliance.

2. PRODUCT DESCRIPTION

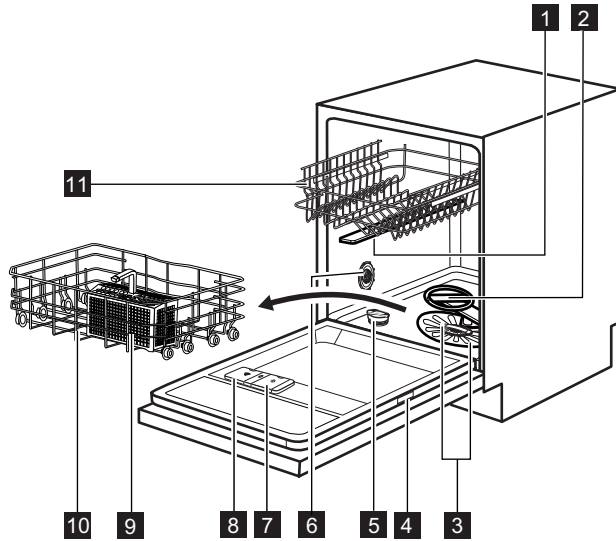

- 1** Upper spray arm
- 2** Lower spray arm
- 3** Filters
- 4** Rating plate
- 5** Salt container
- 6** Water hardness dial
- 7** Rinse aid dispenser
- 8** Detergent dispenser
- 9** Cutlery basket
- 10** Lower basket
- 11** Upper basket

- When the programme starts to operate, the red light comes on and stays on for all the duration of the programme.
- When the programme is completed, the green light comes on.
- When the appliance has a malfunction, the red light flashes.



The **Beam-on-Floor** goes off when the appliance is deactivated.

2.1 Beam-on-Floor

The **Beam-on-Floor** is a light that shows on the floor below the appliance door.

3. CONTROL PANEL

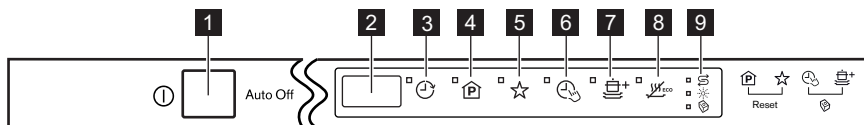

1 On/off button

2 Display

3 **Delay** touchpad

4 **Program** touchpad

5 **MyFavourite** touchpad

6 **TimeSaver** touchpad

7 **XtraPower** touchpad



8 **EnergySaver** touchpad

9 Indicators

Indicators	Description
	Salt indicator. It is always off while the programme operates.
	Rinse aid indicator. It is always off while the programme operates.
	Multitab indicator.



4. PROGRAMMES



Programme	Degree of soil Type of load	Programme phases	Options
P1 1) ECO 50°	Normal soil Crockery and cutlery	Prewash Wash 50 °C Rinses Dry	TimeSaver EnergySaver
P2 2) AUTO AutoFlex 45°-70°	All Crockery, cutlery, pots and pans	Prewash Wash from 45 °C to 70 °C Rinses Dry	EnergySaver
P3 3) FlexiWash 50°-65°	Mixed soil Crockery, cutlery, pots and pans	Prewash Wash 50 °C and 65 °C Rinses Dry	TimeSaver EnergySaver
P4 Intensive 70°	Heavy soil Crockery, cutlery, pots and pans	Prewash Wash 70 °C Rinses Dry	TimeSaver EnergySaver XtraPower

Programme	Degree of soil Type of load	Programme phases	Options
P5  1 Hour 55°	Normal soil Crocery and cut- lery	Wash 55 °C Rinses	
P6 ⁴⁾  QuickPlus 60°	Fresh soil Crocery and cut- lery	Wash 60 °C Rinse	
P7 ⁵⁾  Rinse & Hold	All	Prewash	

- 1) With this programme you have the most efficient use of water and energy consumption for crockery and cutlery with normal soil. (This is the standard programme for test institutes).
- 2) The appliance senses the degree of soil and the quantity of items in the baskets. It automatically adjusts the temperature and quantity of the water, the energy consumption and the programme duration.
- 3) With this programme you can wash different loads with different soil. A higher temperature and water pressure in the lower basket, to wash items with heavy soil (e.g. pots and pans). A lower temperature and water pressure in the upper basket, to wash items with normal soil (e.g. glassware).
- 4) With this programme you can wash a load with fresh soil. It gives good washing results in a short time.
- 5) Use this programme to quickly rinse the dishes. This prevents the remaining food to bond on the dishes and bad odours to come out from the appliance.
Do not use detergent with this programme.

Consumption values

Programme ¹⁾	Duration (min)	Energy (kWh)	Water (l)
P1 ECO 50°	170 - 180	0.9 - 1.0	9 - 10
P2 AUTO AutoFlex 45°-70°	40 - 150	0.6 - 1.4	7 - 14
P3  FlexiWash 50°-65°	130 - 140	1.3 - 1.5	14 - 15
P4  Intensive 70°	140 - 160	1.4 - 1.6	13 - 15
P5  1 Hour 55°	55 - 65	1.0 - 1.2	10 - 11

Programme ¹⁾	Duration (min)	Energy (kWh)	Water (l)
P6 	30	0.8	9
P7 	14	0.1	4

1) The pressure and the temperature of the water, the variations of the mains supply, the options and the quantity of dishes can change the values.

Information for test institutes

For all the necessary information for test performance, send an email to:

info.test@dishwasher-production.com

Write down the product number (PNC) that is on the rating plate.

5. OPTIONS



Activate or deactivate the options before the start of a programme. You cannot activate or deactivate the options while a programme operates.



If one or more options are set, make sure that the related indicators are on before the programme starts.

5.1 MyFavourite

With this option you can set and memorise the programme that you use more frequently.



You can only memorise 1 programme at a time. A new setting cancels the previous one.

How to memorise a programme

1. Press the on/off button to activate the appliance.
2. Set the programme that you want to memorise. you can also set applicable options together with the programme. It is not possible to memorise the options Multitab and Delay.
3. Press and hold **MyFavourite** until the related indicator comes on with fixed light.

How to set the MyFavourite programme

1. Press **MyFavourite**. The indicators that are related to the MyFavourite programme and options come on.
 - The display shows the number and the duration of the programme.

5.2 TimeSaver

This option increases the pressure and the temperature of the water. The washing and drying phases are shorter. The total programme duration decreases by approximately 50%.

The washing results are the same as with the normal programme duration. The drying results can decrease.

How to activate the TimeSaver option

1. Press **TimeSaver**. The related indicator comes on. In the display you can see the update of the programme duration.
 - If the option is not applicable to the programme, the related indicator flashes quickly 3 times and then goes off.

5.3 XtraPower

This option increases the water pressure in the prewash and washing phases by 40%. The washing results are very good also with heavy soiled loads.

How to activate the XtraPower option

1. Press **XtraPower**, the related indicator comes on. In the display you can see the update of the programme duration.
 - If the option is not applicable to the programme, the related indicator flashes quickly 3 times and then goes off.

5.4 EnergySaver

This option decreases the temperature in the last rinse phase.

The use of this option decreases the energy consumption (up to 25%) and the programme duration.

The dishes can be wet at the end of the programme.

How to activate the EnergySaver option

1. Press **EnergySaver**. The related indicator comes on. In the display you can see the update of the programme duration.
 - If the option is not applicable to the programme, the related indicator flashes quickly 3 times and then goes off.

5.5 Multitab

Activate this option only when you use the combi detergent tablets.

This option deactivates the use of rinse aid and salt. The related indicators stay off.

The programme duration can increase.

How to activate the Multitab option

1. Press the on/off button to activate the appliance.
2. Press and hold, at the same time, **TimeSaver** and **XtraPower** until the Multitab indicator comes on. The option stays on until you deactivate it. Press and hold, at the same time, **TimeSaver** and **XtraPower** until the Multitab indicator goes off.

If you stop to use the combi detergent tablets, before you start to use separately detergent, rinse aid and dishwasher salt, do these steps:

1. Deactivate the Multitab option.
2. Set the water softener to the highest level.
3. Make sure that the salt container and the rinse aid dispenser are full.
4. Start the shortest programme with a rinsing phase, without detergent and without dishes.
5. Adjust the water softener to the water hardness in your area.
6. Adjust the released quantity of rinse aid.

5.6 Acoustic signals

The acoustic signals operate when the appliance has a malfunction or when the adjustment of the level of the water softener occurs. It is not possible to deactivate these acoustic signals.

There is also an acoustic signal that operates when the programme is completed. By default, this acoustic signal is off, but it is possible to activate it.

How to activate the acoustic signal for the end of programme

1. Press the on/off button to activate the appliance.
2. Do the Reset function.
3. Press and hold, at the same time, **Program** and **MyFavourite** until the indicators of Delay, Program and MyFavourite start to flash.
4. Press **MyFavourite**.
 - The indicators of Delay and Program go off.
 - The indicator of MyFavourite continues to flash.
 - The display shows the current setting.

1b Acoustic signal on.

0b Acoustic signal off.

5. Press **MyFavourite** to change the setting.
6. Press the on/off button to deactivate the appliance and to confirm the setting.

6. BEFORE FIRST USE

1. Make sure that the set level of the water softener agrees with the water hardness in your area. If not, adjust the water softener. Contact your local water authority to know the water hardness in your area.
2. Fill the salt container.
3. Fill the rinse aid dispenser.
4. Open the water tap.
5. Processing residues can stay in the appliance. Start a programme to remove them. Do not use detergent and do not load the baskets.



If you use the combi detergent tablets, activate the Multitab option.

6.1 Adjusting the water softener

Water hardness				Water softener adjustment	
German degrees (°dH)	French degrees (°fH)	mmol/l	Clarke degrees	Manual	Electronic
51 - 70	91 - 125	9.1 - 12.5	64 - 88	2 1)	10
43 - 50	76 - 90	7.6 - 9.0	53 - 63	2 1)	9
37 - 42	65 - 75	6.5 - 7.5	46 - 52	2 1)	8
29 - 36	51 - 64	5.1 - 6.4	36 - 45	2 1)	7
23 - 28	40 - 50	4.0 - 5.0	28 - 35	2 1)	6
19 - 22	33 - 39	3.3 - 3.9	23 - 27	2 1)	5 1)
15 - 18	26 - 32	2.6 - 3.2	18 - 22	1	4
11 - 14	19 - 25	1.9 - 2.5	13 - 17	1	3
4 - 10	7 - 18	0.7 - 1.8	5 - 12	1	2
< 4	< 7	< 0.7	< 5	1 2)	1 2)

1) Factory position.

2) Do not use salt at this level.



You must adjust the water softener manually and electronically.

Manual adjustment

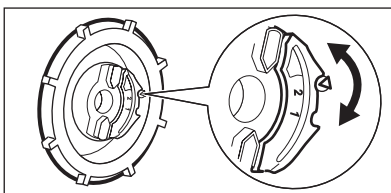

Turn the water hardness dial to the position 1 or 2.

Electronic adjustment

1. Press the on/off button to activate the appliance.
 2. Do the Reset function.
 3. Press and hold, at the same time, **Program** and **MyFavourite** until the indicators of Delay, Program and My-Favourite start to flash.
 4. Press **Delay**.
 - The indicators of Program and My-Favourite go off.
 - The indicator of Delay continues to flash.
 5. Press **Delay** again and again to change the setting.
 6. Press the on/off button to deactivate the appliance and to confirm the setting.
- The acoustic signals operate. E.g. five intermittent acoustic signals = level 5.
 - The display shows the setting of the water softener. E.g. **5 L** = level 5.

6.2 Filling the salt container

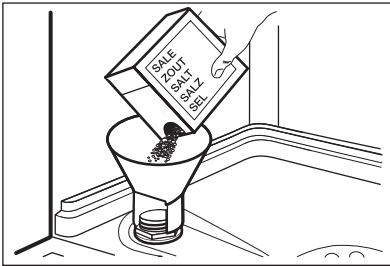

1. Turn the cap counterclockwise and open the salt container.
2. Put 1 litre of water in the salt container (only for the first time).
3. Fill the salt container with dishwasher salt.
4. Remove the salt around the opening of the salt container.
5. Turn the cap clockwise to close the salt container.

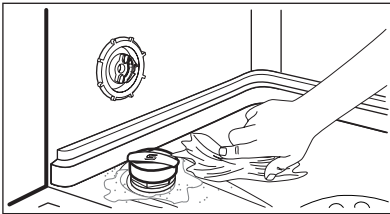

CAUTION!

Water and salt can come out from the salt container when you fill it. Risk of corrosion. To prevent it, after you fill the salt container, start a programme.

6.3 Filling the rinse aid dispenser

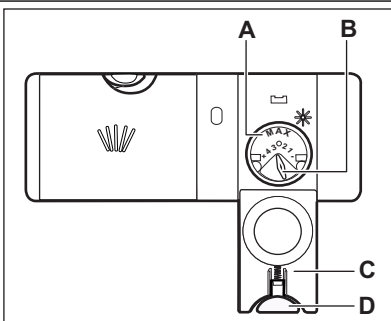

1. Press the release button (**D**) to open the lid (**C**).
2. Fill the rinse aid dispenser (**A**), no more than the mark 'max'.
3. Remove the spilled rinse aid with an absorbent cloth to prevent too much foam.
4. Close the lid. Make sure that the release button locks into position.



You can turn the selector of the released quantity (**B**) between position 1 (lowest quantity) and position 4 (highest quantity).

7. DAILY USE

1. Open the water tap.
2. Press the on/off button to activate the appliance.
 - If the salt indicator is on, fill the salt container.
 - If the rinse aid indicator is on, fill the rinse aid dispenser.
3. Load the baskets.
4. Add the detergent.
5. Set and start the correct programme for the type of load and the degree of soil.

7.1 Using the detergent

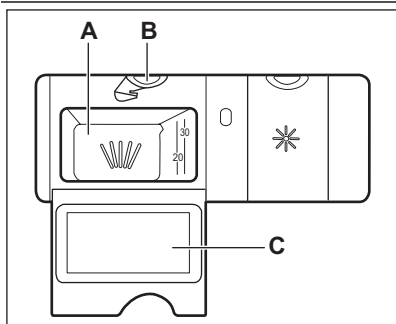

1. Press the release button (B) to open the lid (C).
2. Put the detergent in the compartment (A).
3. If the programme has a prewash phase, put a small quantity of detergent on the inner part of the appliance door.
4. If you use detergent tablets, put the tablet in the compartment (A).
5. Close the lid. Make sure that the release button locks into position.

7.2 Setting and starting a programme

The Auto Off function

To decrease the energy consumption, this function automatically deactivates the appliance a few minutes after:

- You have not closed the door to start the programme.
- The programme is completed.

Reset function

For some settings it is necessary that the appliance is in user mode.

To set the appliance in user mode, do the Reset function.

1. Press and hold, at the same time, **Program** and **MyFavourite** until the display shows the programme P1.

Starting a programme without delay start

1. Open the water tap.
2. Press the on/off button to activate the appliance. The display shows the

number and the duration of the last set programme.

3. Set a programme.
 - If you want to start the last set programme, close the appliance door.
 - If you want to set the **MyFavourite** programme, press **MyFavourite**.
 - If you want to set a different programme, press **Program** again and again until the display shows intermittently the number and the duration of the programme you want to set. If you want you can set the applicable options.
4. Close the appliance door. The programme starts. The programme duration starts to decrease with steps of 1 minute.

Starting a programme with delay start

1. Set the programme.
2. Press **Delay** again and again until the display shows the delay time you want to set (from 1 to 24 hours).
 - The display shows intermittently the programme number, the pro-

gramme duration and the delay time.

- The Delay indicator comes on.
- 3.** Close the appliance door. The countdown starts.
- When the countdown is completed, the programme starts.

Opening the door while the appliance operates

If you open the door, the appliance stops. When you close the door, the appliance continues from the point of interruption.

Cancelling the delay start while the countdown operates

Do the Reset function.



When you cancel the delay start you have to set the programme and options again.

Cancelling the programme

Do the Reset function.



Make sure that there is detergent in the detergent dispenser before you start a new programme.

At the end of the programme

When the programme is completed, the display shows 0:00.

- 1.** Press the on/off button or wait for the Auto Off function to automatically deactivate the appliance.
- 2.** Close the water tap.

Important

- Let the dishes become cold before you remove them from the appliance. Hot dishes can be easily damaged.
- First remove the items from the lower basket, then from the upper basket.
- There can be water on the sides and on the door of the appliance. Stainless steel becomes cool more quickly than the dishes.

8. HINTS AND TIPS

8.1 The water softener

Hard water contains a high quantity of minerals that can cause damage to the appliance and bad washing results. The water softener neutralises these minerals. The dishwasher salt keeps the water softener clean and in good conditions. It is important to set the right level of the water softener. This makes sure that the water softener uses the correct quantity of dishwasher salt and water.

8.2 Using salt, rinse aid and detergent

- Only use salt, rinse aid and detergent for dishwasher. Other products can cause damage to the appliance.
- The rinse aid helps, during the last rinsing phase, to dry the dishes without streaks and stains.

- Combi detergent tablets contain detergent, rinse aid and other added agents. Be sure that these tablets are applicable to the water hardness in your area. Refer to the instructions on the packaging of the products.
- Detergent tablets do not fully dissolve with short programmes. To prevent detergent residues on the tableware, we recommend that you use the tablets with long programmes.



Do not use more than the correct quantity of detergent. Refer to the instructions on the detergent packaging.

8.3 Loading the baskets



Refer to the supplied leaflet with examples of the load of the baskets.

- Only use the appliance to wash items that are dishwasher-safe.
- Do not put in the appliance items made of wood, horn, aluminium, pewter and copper.
- Do not put in the appliance items that can absorb water (sponges, household cloths).
- Remove remaining food from the items.
- To remove easily remaining burned food, soak pots and pans in water before you put them in the appliance.
- Put hollow items (cups, glasses and pans) with the opening down.
- Make sure that cutlery and dishes do not bond together. Mix spoons with other cutlery.
- Make sure that glasses do not touch other glasses.
- Put the small items in the cutlery basket.
- Put the light items in the upper basket. Make sure that they do not move.

- Make sure that the spray arms can move freely before you start a programme.

8.4 Before starting a programme

Make sure that:

- The filters are clean and correctly installed.
- The spray arms are not clogged.
- The position of the items in the baskets is correct.
- The programme is applicable for the type of load and for the degree of soil.
- The correct quantity of detergent is used.
- There is dishwasher salt and rinse aid (unless you use combi detergent tablets).
- The cap of the salt container is tight.

9. CARE AND CLEANING



WARNING!

Before maintenance, deactivate the appliance and disconnect the mains plug from the mains socket.



Dirty filters and clogged spray arms decrease the washing results.

Make a check regularly and, if necessary, clean them.

9.1 Cleaning the filters

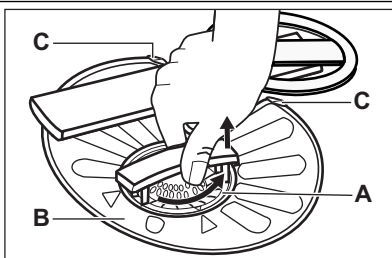

1. Turn the filter (A) counterclockwise and remove it.

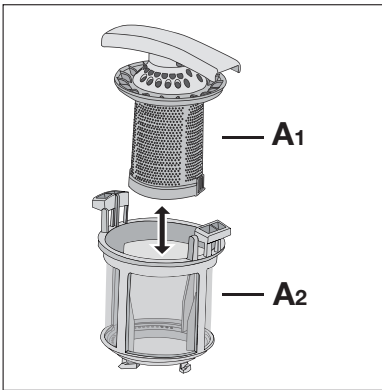

2. To disassemble the filter (A), pull apart (A1) and (A2).
3. Remove the filter (B).
4. Wash the filters with water.
5. Put the filter (B) to its initial position. Make sure that it assembles correctly under the two guides (C).

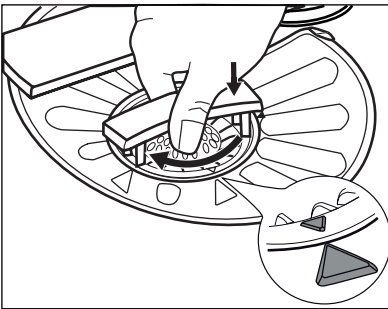

6. Assemble the filter (A) and put it into position in filter (B). Turn it clockwise until it locks.



An incorrect position of the filters can cause bad washing results and damage to the appliance.

9.2 Cleaning the spray arms

Do not remove the spray arms. If the holes in the spray arms are clogged, remove remaining parts of soil with a thin pointed object.

Only use neutral detergents. Do not use abrasive products, abrasive cleaning pads or solvents.

9.3 External cleaning

Clean the appliance with a moist soft cloth.

10. TROUBLESHOOTING

The appliance does not start or it stops during operation.

Before you contact the Service, refer to the information that follows for a solution to the problem.

With some problems, the display shows an alarm code:

- **,10** - The appliance does not fill with water.

- **,20** - The appliance does not drain the water.
- **,30** - The anti-flood device is on.



WARNING!

Deactivate the appliance before you do the checks.

Problem	Possible solution
You cannot activate the appliance.	Make sure that the mains plug is connected to the mains socket.
	Make sure that there is not a damaged fuse in the fuse box.
The programme does not start.	Make sure that the appliance door is closed.
	If the delay start is set, cancel the setting or wait for the end of the countdown.
The appliance does not fill with water.	Make sure that the water tap is open.
	Make sure that the pressure of the water supply is not too low. For this information, contact your local water authority.
	Make sure that the water tap is not clogged.
	Make sure that the filter in the inlet hose is not clogged.
	Make sure that the inlet hose has no kinks or bends.
The appliance does not drain the water.	Make sure that the sink spigot is not clogged.
	Make sure that the drain hose has no kinks or bends.
The anti-flood device is on.	Close the water tap and contact the Service.

After the checks are completed, activate the appliance. The programme continues from the point of interruption. If the problem occurs again, contact the Service.
If the display shows other alarm codes, contact the Service.

10.1 If the washing and drying results are not satisfactory

Whitish streaks or bluish layers on glasses and dishes

- The released quantity of rinse aid is too much. Adjust the rinse aid selector to a lower position.
- The quantity of detergent is too much.

Stains and dry water drops on glasses and dishes

- The released quantity of rinse aid is not sufficient. Adjust the rinse aid selector to a higher position.
- The quality of the detergent can be the cause.

Dishes are wet

- The programme is without a drying phase or with a low temperature drying phase.
- The rinse aid dispenser is empty.
- The quality of the rinse aid can be the cause.
- The quality of the combi detergent tablets can be the cause. Try a different brand or activate the rinse aid dispenser and use rinse aid together with the combi detergent tablets.



Refer to 'HINTS AND TIPS' for other possible causes.

10.2 How to activate the rinse aid dispenser

The activation of the rinse aid dispenser can occur only with the Multitab option activated.

1. Press the on/off button to activate the appliance.
2. Do the Reset function.

3. Press and hold, at the same time, **Program** and **MyFavourite** until the indicators of Delay, Program and MyFavourite start to flash.
4. Press **Program**.
 - The indicators of Delay and MyFavourite go off.
 - The indicator of Program continues to flash.
 - The display shows the current setting.

<i>0d</i>	Rinse aid dispenser off.
-----------	--------------------------

<i>1d</i>	Rinse aid dispenser on.
-----------	-------------------------

5. Press **Program** to change the setting.
6. Press the on/off button to deactivate the appliance and to confirm the setting.
7. Adjust the released quantity of rinse aid.
8. Fill the rinse aid dispenser.

11. TECHNICAL INFORMATION

Dimensions	Width / Height / Depth (mm)	596 / 818 - 898 / 550
Electrical connection	Refer to the rating plate.	
	Voltage	220-240 V
	Frequency	50 Hz
Water supply pressure	Min. / max. (bar / MPa)	(0.5 / 0.05) / (8 / 0.8)
Water supply 1)	Cold water or hot water 2)	max. 60 °C
Capacity	Place settings	12
Power consumption	Left-on mode	0.10 W
	Off-mode	0.10 W

1) Connect the water inlet hose to a water tap with a 3/4" thread.

2) If the hot water comes from alternative sources of energy, (e.g. solar panels, aeolian energy), use the hot water supply to decrease energy consumption.

12. ENVIRONMENT CONCERNS

Recycle the materials with the symbol .
 . Put the packaging in applicable containers to recycle it.
 Help protect the environment and human health and to recycle waste of electrical

and electronic appliances. Do not dispose appliances marked with the symbol  with the household waste. Return the product to your local recycling facility or contact your municipal office.

www.electrolux.com/shop



117922132-B-222012

