



Diamond Digital

DV260

Wide Screen LCD Flat
Panel Display
26" (66cm) LCD Panel Size

User Manual

Color LCD TV**USER'S MANUAL**

Thank you for purchasing the LCD TV.

Before using your TV, please read the "SAFETY INSTRUCTIONS" and this "USER'S MANUAL" carefully to learn how to operate the TV properly. Keep this manual in a safe place. You will find it useful in the future.

Notes on Installation

This product is marketed with the assumption that it is to be installed by qualified personnel with relevant skills and competence. It is recommended to consult with an installation specialist or your dealer install and set up the product. We cannot assume liabilities for damages caused by improper installation or mounting, misuse, modifications or natural disasters.







IMPORTANT SAFETY INSTRUCTIONS

SAFETY POINTS THAT YOU SHOULD KNOW ABOUT YOUR LCD TV

Our reputation has been built on the quality, performance, and ease of service of LCD TV.

Safety is also foremost in our minds in the design of these units. To help you operate these products properly, this section illustrates safety tips which will be of benefit to you. Please read it carefully and apply the knowledge you obtain from it to the proper operation of your LCD TV.

Follow all warnings and instructions marked on this TV.

 <div data-bbox="247 436 614 548" style="text-align: center;"> CAUTION RISK OF ELECTRIC SHOCK DO NOT OPEN </div>  <p data-bbox="135 582 742 705">CAUTION: TO REDUCE THE RISK OF ELECTRIC SHOCK, DO NOT REMOVE THE COVER (OR BACK). NO USER SERVICEABLE PARTS INSIDE. REFER SERVICING TO QUALIFIED SERVICE PERSONNEL.</p>	 <p data-bbox="949 403 1524 571">The lightning flash with arrowhead symbol, within an equilateral triangle, is intended to alert the user to the presence of uninsulated "dangerous voltage" within the product's enclosure that may be of sufficient magnitude to constitute a risk of electric shock to persons.</p>  <p data-bbox="949 582 1524 716">The exclamation point within an equilateral triangle, is intended to alert the user to the presence of important operating and maintenance (servicing) instructions in the literature accompanying the appliance.</p>
--	---

WARNING: **TO AVOID FIRE OR ELECTROCUTION, DO NOT EXPOSE THIS MONITOR TO RAIN OR MOISTURE. THE MONITOR SHOULD NOT BE EXPOSED TO DRIPPING OR SPLASHING AND OBJECTS SUCH AS VASES FILLED WITH LIQUIDS, SHOULD NOT BE PLACED ON THE TV.**

NOTE: **There are no user serviceable parts inside the TV. Model information and serial numbers are indicated on the rear side of the TV.**

CAUTION: Adjust only those controls that are covered in these instructions, as improper changes or modifications not expressly approved by us could void the user's authority to operate the TV.

MODIFICATIONS: The FCC requires that the user be notified that any changes or modifications made to this device, that are not expressly approved by us may void the user's authority to operate the equipment.

POWER SOURCE

THIS TV IS DESIGNED TO OPERATE ON 120 VOLT 60Hz, AC CURRENT. INSERT THE POWER CORD INTO A 120 VOLT 60Hz OUTLET.

TO PREVENT ELECTRIC SHOCK, DO NOT USE THE TV (POLARIZED) PLUG WITH AN EXTENSION CORD, RECEPTACLE, OR OTHER OUTLET UNLESS THE BLADES AND GROUND TERMINAL CAN BE FULLY INSERTED. THIS IS TO PREVENT BLADE EXPOSURE. NEVER CONNECT THE TV TO DIRECT CURRENT OR ANYTHING OTHER THAN THE SPECIFIED VOLTAGE.

 **CAUTION:** Never remove the back cover of the TV as this can expose you to very high voltages and other hazards. If the TV does not operate properly, unplug the TV and call your authorized dealer or service center.



IMPORTANT SAFETY INSTRUCTIONS

Read before operating the appliance

Follow all warnings and instructions marked on this TV.

1. Read these instructions.
2. Keep these instructions.
3. Heed all warnings.
4. Follow all instructions.
5. Do not use this apparatus near water.
6. Clean only with a dry cloth.
7. Do not block any ventilation openings. Install in accordance with the manufacturer's instructions.
8. Do not install near any heat sources such as radiators, heat registers, stoves, or other apparatus (including amplifiers) that produce heat.
9. Do not defeat the safety purpose of the polarized or grounding-type plug. A polarized plug has two blades with one wider than the other. A grounding type plug has two blades and a third grounding prong. The wide blade or the third prong are provided for your safety. If the provided plug does not fit into your outlet, consult an electrician for replacement of the obsolete outlet.
10. Protect the power cord from being walked on or pinched, particularly at plugs, convenience receptacles, and at the point where they exit from the apparatus.
11. Only use the attachments/accessories specified by the manufacturer.
12.  Use only with the cart, stand, tripod, bracket, or table specified by the manufacturer, or sold with the apparatus. When a cart is used, use caution when moving the cart/appliance combination to avoid injury from tip-over.
13. Unplug this apparatus during lightning storms or when unused for long periods of time.
14. Refer all servicing to qualified service personnel. Servicing is required when the appliance has been damaged in any way, such as when a power-supply cord or plug is damaged, liquid has been spilled or objects have fallen into apparatus, the apparatus has been exposed to rain or moisture, does not operate normally, or has been dropped.
15. Warning-To reduce the risk of fire or electric shock, do not expose this apparatus to rain or moisture.
16. Apparatus shall not be exposed to dripping or splashing and no objects filled with liquids, shall not be placed on the apparatus.
17. The apparatus is entertainment use only and visual display takes are excluded.

18. The Shock Hazard Marking and Associated Graphical Symbol is provided on the bottom panel of the unit.
19. This apparatus is designed to comply with the recommended safety standards for tilt and stability.
Do not pull the cabinet with excessive force. Doing so can cause the product to overturn, resulting in damage to the product and/or personal injury.
20. Follow instructions for wall, shelf, or ceiling mounting as recommended by the manufacturer.
21. An outdoor antenna should not be located in the vicinity of overhead power lines or other electrical circuits.
22. If an outdoor antenna is connected to the receiver, ensure that the antenna is grounded to provide some protection against voltage surges and built up static charges. Section 810 of the National Electric Code, ANSI/NFPA No. 70-1984, provides information with respect to proper grounding for the mast and supporting structure, grounding of the lead-in wire to an antenna discharge unit, size of grounding connectors, location of antenna-discharge unit, connection to grounding electrodes and requirements for the grounding electrode.

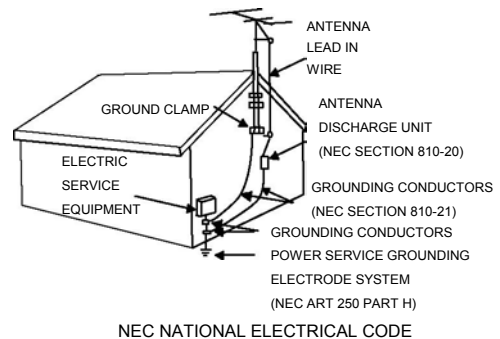

Note to the CATV system installer: This reminder is intended to point the CATV system installer to Article 820-40 of the NEC that provides guidelines for proper grounding and, in particular, specifies that the cable's ground wire shall be connected to the grounding system of the building, as close to the point of cable entry as possible.

Do not place any objects on top of the TV. They may fall or cause a child to climb up to retrieve the objects.

Disposal of this product may require specific instructions pertaining to your resident state. For disposal or recycling information, please contact your local authorities or the Electronic Industries Alliance: www.eiae.org.



CAUTION: PREVENTION OF SCREEN BURN IN

Continuous on-screen displays such as video games, stock market quotations, computer generated graphics and other fixed (non-moving) patterns can cause permanent damage to the TV. Such "SCREEN BURN IN" constitute misuse and are NOT COVERED by our Factory Warranty.

PUBLIC VIEWING OF COPYRIGHTED MATERIAL

Public viewing of programs broadcast by TV stations and cable companies, as well as programs from other sources, may require prior authorization from the broadcaster or owner of the video program material.

Important

Please read this User's Manual thoroughly, especially the Important Safety Instructions on Pages 2 to 3 and 6 to 10. Misuse may cause damage to your LCD TV and could shorten its lifespan, or may even cause injury to yourself. Should you encounter any difficulty in the set-up or operation of your TV, refer to the Troubleshooting guide at the back of this manual. In the unlikely event that there is a problem with your LCD TV, switch off the power and unplug the TV, and contact your dealer immediately.

CAUTION

Under no circumstances should you remove the back cover of your LCD TV. Never guess or take any chances with electrical equipment of any kind - it is better to be safe than sorry!

Software Notice

It is prohibited for the end user of this product to copy, reverse engineer or reverse compile the software included therein, to the extent permitted by law.

LCD TV

After the LCD TV has been on for any length of time, you will notice that the screen becomes warm. Please note that this is normal.

To prevent scratches or damages to the LCD screen, do not knock or rub the surface with sharp or hard objects. Clean the screen with a soft cloth moistened with warm water and dry with a soft cloth. A mild soap may be used if the screen is extremely dirty. Do not use harsh or abrasive cleaners!

CAUTION

Use a soft cloth to clean the cabinet and the control panel of the TV. When excessively soiled, dilute a neutral detergent in water, wet and wring out the soft cloth, then wipe the TV and afterwards wipe it off with a dry soft cloth.

Never use acid/alkaline detergent, alcoholic detergent, abrasive cleaner, powder soap, Electronic equipment cleaner, car wax, glass cleaner, etc. especially because they would cause discoloration, scratches or cracks.

FEATURE

Enhanced definition LCD panel

The 26-inch color LCD display panel, with a resolution of 1366 (H) x 768 (V) pixels, creates a widescreen picture. This panel features a thin form factor and can be hung on a wall with an optional wall mounting kit.

High Performance Digital Processor

This panel displays a wide range of personal computer signals from 640 x 350, 640 x 400 VGA to 1360 x 768 .(RGB Analog input)

Easy-to-use remote control and on screen display system

The included remote control operates all TV functions. Further, the on-screen display system, shows the status of the control settings in an easy-to-view fashion.

Power saving system

The International ENERGY STAR® power saver feature saves power consumption automatically when input signals are not available. When connected to a VESA DPMS-compliant PC, the monitor cuts its power consumption while it is idle.

CONTENTS

IMPORTANT SAFETY INSTRUCTIONS	2	Volume Adjustment.....	19
SAFETY INSTRUCTIONS	6	Audio Mute.....	19
INSTALLATION INSTRUCTIONS	10	Using the Menu Screen (On-screen display system)	20
Desk Top Stand	10	Image Settings.....	21
Anti-Tipping Prevention.....	10	Display Settings.....	22
Power Cord Connection.....	11	Advanced PC.....	23
Connecting Antenna / Cable TV Signal	12	Audio Settings.....	23
Connecting to Video Components	13	Setup	24
Connecting to a PC.....	14	Channel Setting	25
COMPONENT NAMES	15	ASPECT	29
Main Unit	15	Teletext Menu	30
ATTENTION	16	TROUBLESHOOTING	31
Remote Control (continued).....	17	Symptoms	31
OPERATING INSTRUCTIONS	18	Abnormal Displays Corrections VGA Only	34
Turning Power Off.....	18	PRODUCT SPECIFICATIONS	35
Selecting AV Inputs.....	19	Component Connection.....	36
		Recommended Signal List.....	36

Notes about this manual

The information in this manual is subject to change without notice.

While meticulous care has been taken in the preparation of this manual, you are requested to notify your dealer or us should you have any comments, views or questions about our product.

Fully understand the prerequisites to using the product, such as hardware and software specifications and constraints, when using the product. We are not held liable for damages caused by improper handling of the product.

Reproduction of this manual in whole or in part without our prior written permission is prohibited.

The product names mentioned in this manual may be trademarks or registered trademarks of their respective owners.

SAFETY INSTRUCTIONS

This LCD TV has been designed and manufactured to meet international safety standards, but like any electrical equipment, care must be taken if you are to obtain the best results and safety is to be assured.

Before using this product, please read and understand the Safety Instructions thoroughly to ensure correct usage, and follow all the instructions

About the Symbols

Various symbols are used in this manual, the user's manual and on the product itself to ensure correct usage, to prevent danger to the users and to prevent property damage. The meaning of these symbols are described below. It is important that you read these descriptions thoroughly and fully understand the contents.



This symbol indicates information that, if ignored, could possibly result in personal injury or even death due to incorrect handling.



This symbol indicates information that, if ignored, could result possibly in personal injury or physical damage due to incorrect handling.

Typical Symbols



This symbol indicates an additional warning (including cautions). An illustration is provided to clarify the contents.



This symbol indicates a prohibited action. The contents will be clearly indicated in an illustration or adjacent to the symbol (the symbol to the left indicates that disassembly is prohibited).



This symbol indicates a compulsory action. The contents will be clearly indicated in an illustration or adjacent to the symbol. (the symbol to the left indicates that the power plug should be disconnected from the power outlet).



Never use the TV if a problem should occur.

Abnormal operations such as smoke, strange odor, no image, no sound, excessive sound, damaged casing, elements, cables, penetration of liquids, or foreign matter, can cause a fire or electrical shock.

In such cases, immediately turn off the power switch and then disconnect the power plug from the power outlet. After making sure that the smoke or odor has cleared, contact your dealer. Never attempt to make repairs yourself because this could be dangerous.



Disconnect the plug from the power outlet.

Do not insert foreign objects or pour liquids inside the TV.

Penetration of liquids or foreign objects could result in a fire or electrical shock. Use special caution in households where children are present.

If liquids or foreign objects should enter the projector, immediately turn off the power switch, disconnect the power plug from the power outlet and contact your dealer.

Do not place the TV in a bathroom.

Do not expose the TV to rain or moisture.

Do not place flower vases, pots, cups, cosmetics, liquids such as water, etc. on or around the TV.

Do not place metals, combustibles, etc. on or around the TV.



Do not disassemble.

Never disassemble or modify the TV.

The TV contains high voltage components. Modification could result in a fire or electrical shock.

Never remove any cover.

Do not subject the TV to shock or impact.

If the TV is subject to shock and/or is broken, it could result in an injury, and continued use in such a state could result in fire or electrical shock. If the glass panel is broken or damaged, immediately turn off the power switch, disconnect the power plug from the power outlet and contact your dealer.



Do not place the TV on an unstable surface.

If the TV should be dropped and/or broken, it could result in an injury, and continued use in such a state could result in fire or electrical shock. Do not place the TV on an unstable, slanting or vibrant surface such as a wobbly or inclined stand.

Do not obstruct the ventilation of the TV.

If ventilation is obstructed during the operation of the TV or just after switching off the power, it could result in damage and shorten the lifespan of your TV due to overheating. Make sure there is ample ventilation.

Keep a space of 100mm (10cm) or more between the sides, rear and top of the TV and other objects such as walls.

Do not place anything around ventilation openings of the TV.

Never block ventilation openings.

Do not put the LCD screen side up.

Do not cover the TV with a tablecloth, etc.

Do not place the TV on a carpet or bedding, or near a curtain.



Use only the correct power outlet.

Incorrect power supply could result in fire or electrical shock. Use the correct power outlet depending on the indication on the TV and the safety standard.

The enclosed power cord must be used depending on the power outlet to be used.



SAFETY INSTRUCTIONS (continued)



WARNING

Be cautious of the power cord connection.

Incorrect connection of the power cord could result in fire or electrical shock.

Do not touch the power cord with a wet hand.

Check that the connecting portion of the power cord is clean (with no dust), before using. Use a soft and dry cloth to clean the power plug.

Insert the power plug into a power outlet firmly. Avoid using a loose, unsound outlet or contact failure.

Do not cut off the fitted power plug, the removal of which could lead to impaired performance. If you wish to extend the lead, obtain an appropriate extension lead or consult your dealer.

Be sure to ground the connection properly.

Connect the ground terminal of the AC inlet of this TV with the ground terminal provided at the power outlet using the enclosed power cord.

If the provided plug does not fit your outlet, consult an electrician for replacement of the obsolete outlet.



Surely connect the ground wire.

ENGLISH

Be careful when handling the power cord and external connection cables.

Do not use damaged power cords or cables as they can cause a fire or electrical shock. Do not apply excessive heat, pressure or tension to the power cord and cables.

If the power cord or cables are damaged (exposed or broken core wires, etc.), contact your dealer.

Do not place the TV or other heavy objects on the power cord and cables. Also, do not place a spread, cover, etc., over them as this could result in the inadvertent placing of heavy objects on the concealed power cord or cables.

Do not pull the power cord and cables. When connecting and disconnecting the power cord or cables, do it with your hand holding the plug or connector.

Do not place the power cord near a heater.

Do not touch the power plug just after disconnecting it from the power outlet. The static discharge can cause an electric shock.

Do not touch the power plug during a lightning storm.

Avoid coiling the power cord and bending it sharply.

Protect the power cord from being walked on or pinched at particularly at plugs, conveniences receptacles, and at the point where they exit from the panel.

Do not modify the power cord.



Be careful when handling the batteries of the remote control.

Incorrect handling of the batteries could result in a fire or personal injury. The batteries may explode if not handled properly.

Keep the batteries away from children and pets. If swallowed, consult a physician immediately for emergency treatment.

Do not allow the batteries to be exposed to fire or water.

Avoid fire or high-temperature environments.

Do not hold the batteries with metallic tweezers.

Keep the batteries in a dark, cool and dry place.

Do not short circuit the batteries.

Do not recharge, disassemble or solder the batteries.

Do not physically impact the batteries.

Use only the batteries specified in the manual accompanying this TV.

Make sure the plus and minus terminals are correctly aligned when inserting the batteries.

If you observe a leakage of the batteries, wipe out the liquid and then replace the batteries. If you spill the liquid on your body or clothes, rinse well with water.

Obey the local laws when disposing the batteries.



SAFETY INSTRUCTIONS (continued)



CAUTION

Be careful in moving the TV.

Neglect could result in an injury or damage.

Do not move the TV during use. Before moving, disconnect the power plug and all external connections.

Get the help of another person if you find it difficult to move the TV alone.

Avoid any impact or shock to the TV; in particular take care of the glass screen.



Do not put anything on top of the TV.

Placing anything on top of the TV could result in loss of balance or falling, and can cause an injury or damage. Take special care in households where children are present.



Avoid a humid or dusty place.

Placing the TV in a smoke filled, or in a highly humid, dusty place with oily soot or corrosive gas could result in fire or electrical shock.

Do not place the TV near the kitchen, a humidifier or any other place where there is oil, smoke or humidity.



Avoid a high temperature environment.

The heat could have adverse influence on the TV and its components, and could result in transformation, melting or fire.

Do not place the TV, the remote control and other parts in direct sunlight or near a hot object such as heater, etc.

Do not put the TV in a place where the temperature varies rapidly.



Remove the power cord when not using the TV for a long time.

For safety, disconnect the power cord if the TV is not to be used for prolonged periods of time.

Before cleaning, turn off and unplug the TV. Neglect to do so could result in a fire or electrical shock.



Disconnect the plug from the power outlet.

PRECAUTIONS

Installation environment

Do not obstruct the ventilation slots.

Do not place the TV on a carpet or blanket, or near a curtain or anywhere else where there is a possibility of obstructing the ventilation slots of the TV.

Do not place the TV in the following places.

Hot places such as near heaters, or in places exposed to the direct rays of the sun.

Places where the temperature varies rapidly.

Places with soot, dust or high humidity.

Places with poor ventilation.

Places such as near a fire.

Wet places such as bathrooms, or shower rooms.

Places where you can trip over the TV.

On objects that vibrate.

On objects that are unstable.

How to view the TV

If you use the TV in too dark a room, your eyes may become tired.

Use it in a reasonably bright room.

Avoid direct rays of the sun on the screen to prevent eye fatigue.

Your eyes will get tired after viewing the TV for long periods of time.

Relax your eyes by looking away from the TV from time to time.

Please watch the TV in downward direction.

How to clean the LCD screen panel of the TV

Before cleaning the TV, turn off the TV and disconnect the power plug from the power outlet.

To prevent scratching or damaging the LCD screen, do not knock or rub the surface with sharp or hard objects. Clean the screen with a soft cloth moistened with warm water and dry with a soft cloth. If it is not enough, then use a cloth with mild detergent. Do not use harsh or abrasive cleaners.

How to clean the cabinet of the TV

Use a soft cloth to clean the cabinet and control panel of the TV. When excessively soiled, dilute a neutral detergent in water, wet and wring out the soft cloth, wipe the TV and afterwards wipe with a dry soft cloth.

Never use acid/alkaline detergent, alcoholic detergent, abrasive cleaner, powder soap, OA cleaner, car wax, glass cleaner, etc. as they could cause discoloration, scratches or cracks.

SAFETY INSTRUCTIONS (continued)

Prevention of an obstacle to Radio receivers

This TV has been designed pursuant to the international EMI standards. This is to prevent a problem to Radio receivers.

Keep the TV away from Radio.

Adjust Radio antennas in order for the TV not to receive interference.

The antenna cable of Radio should be kept away from the TV.

Use a coaxial cable for antenna.

You can check if this TV influences Radio receivers by turning off all other equipment other than the TV.

If you find a problem receiving Radio when using the TV, check the instructions mentioned above.

Precautions for the cable connection

Do ensure that all connections, (including the power plug, extension leads and interconnections between the pieces of equipment), are properly made and in accordance with the manufacturers instructions. Switch off and withdraw the power plug before making or changing connections.

Confirm the connector is fixed tightly when the signal cable is connected.

Also confirm the screws on the connector are tightened.

Plug the power cord of the TV into a different socket from that for other equipment, such as Radio etc.

Use a plug with ground terminal and make sure that it connects to the ground.

Precaution during transportation

Please pay attention when you transport this TV because it is heavy.

Furthermore, use the original carton box and its packaging materials when the TV is transported.

Failure to transport the TV in any carton except the original carton may result in damage to the TV.

Save the original carton box and all packing material.

Do not physically impact the remote control.

A physical impact could cause damage or malfunction of the remote control.

Take care not to drop the remote control.

Do not place heavy objects on the remote control.

Avoid strong rays.

Any strong rays (such as direct sun rays or room lighting) onto the remote control sensors could invalidate the remote control.

Avoid radio interference.

Any interfering radiation could cause distorted images or noises.

Avoid radio generator such as a mobile telephone, transceiver, etc. around the TV.

Set the sound volume at a suitable level.

It is better to keep the volume level low and close the windows at night to protect the neighborhood environment.

Precautions for the installation

Do not use makeshift stands and NEVER fix legs with wood screws - to ensure complete safety, always fit the manufacturers approved stand or legs with the fixings provided according to the instructions.

Use only with the cart, stand, tripod, bracket, or table specified by the manufacturer, or sold with the apparatus. When a cart is used, use caution when moving the cart/apparatus combination to avoid injury from tip-over.

This product is designed to comply with the recommended safety standards for tilt and stability. Do not apply excessive pulling force to the front, or top, of the cabinet that could cause the product to overturn resulting in product damage and/or personal injury.

Follow instructions for wall, shelf or ceiling mounting as recommended by the manufacturer.

Only use the attachments/accessories specified by the manufacturer.

Consult your dealer if you are in any doubt about installation, operation or safety of your equipment.

Other precautions

Do not leave equipment switched on when it is unattended unless it is specifically stated that it is designed for unattended operation or has a stand-by mode.

Switch off using the switch on the equipment and show your family how to do this. Make special arrangements for infirm or handicapped people.

Disposal of this product may require specific instructions pertaining to your resident region.

Never guess or take any chances with electrical equipment of any kind - it is better to be safe than sorry!

INSTALLATION INSTRUCTIONS

Desk Top Stand

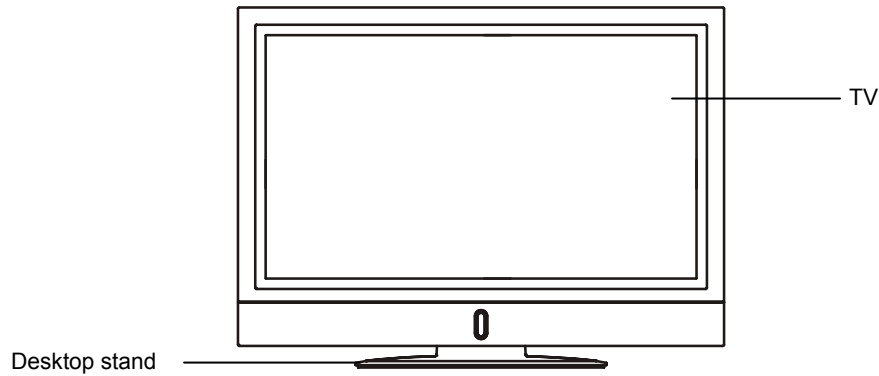

WARNING

Use one of the special mounting units to install this product. A mounting unit of insufficient strength or inadequate design can cause overturning or dropping and result in fire, electrical shock or injury. Please note that our company assumes absolutely no responsibility for personal injuries or property damage caused by use of other mounting units or improper installation.



CAUTION

Do not attempt installation of the wall mounting unit and ceiling mounting unit by yourself as it can be dangerous. Ask your dealer to provide the name of a qualified technician.

In order to prevent overheating, maintain a space of 10cm (4 inches: For a desktop setup) or more between the sides of the TV and other objects such as walls, etc., so that the ventilation holes are not blocked.

10cm (4 inches) or more*

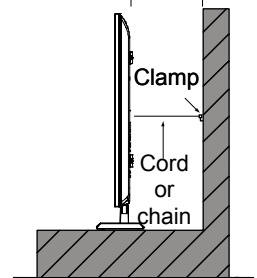

Anti-Tipping Prevention



CAUTION

Have this unit mounted in a stable place. Take measures to prevent it from tumbling down to avoid possible physical injury.

Using a commercially available cord, chain and clamp, secure the set to a firm wall or pillar.

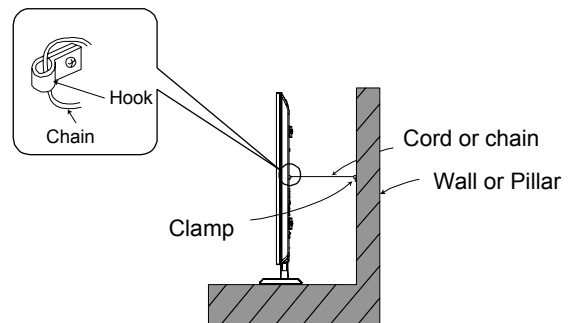

INSTALLATION INSTRUCTIONS (continued)

Power Cord Connection

Connect the power cord, after completing all other connections.

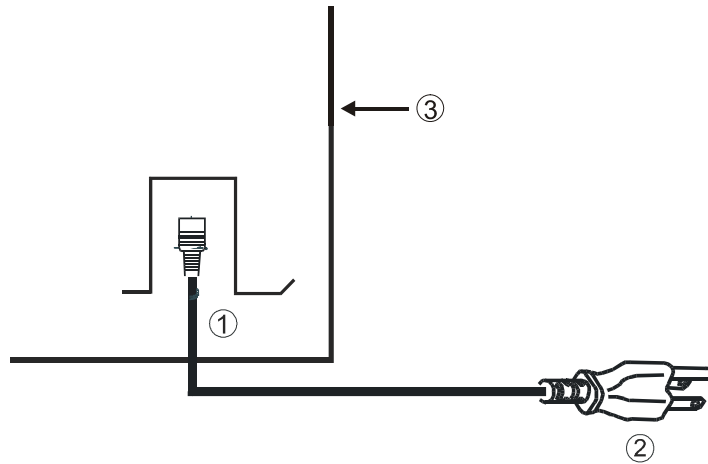

1. Connect the power cord to the rear of the TV.
2. Connect the power cord plug to the power outlet.
3. Turn ON the main power switch is located on the side
(The type of plug is different from this drawing for some countries.)



CAUTION

Use only the power cord provided.

Do not use a power supply voltage other than that indicated (AC100-240V, 50/60Hz) as this may cause fire or electric shock.

INSTALLATION INSTRUCTIONS (continued)

Connecting Antenna / Cable TV Signal

Make sure that the power switch of the TV is turned off.

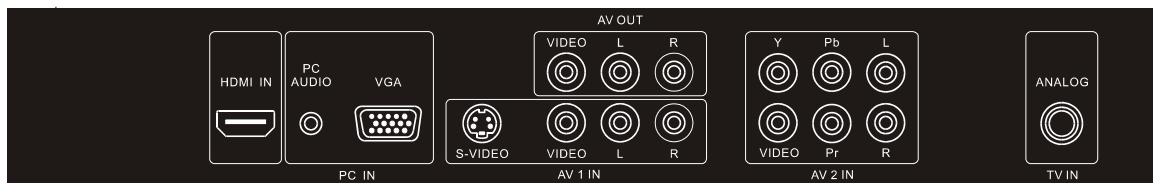
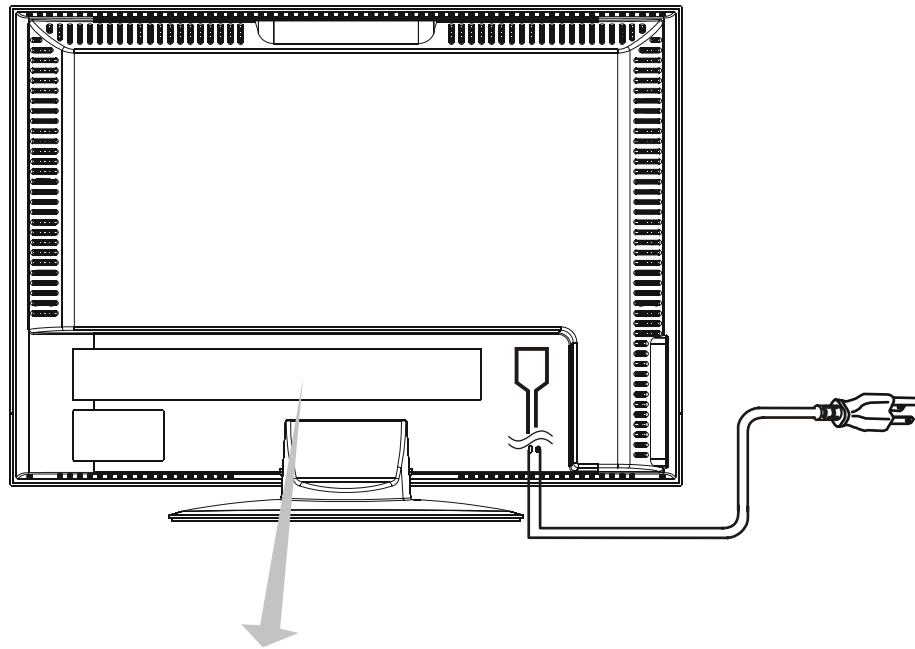

1. TV IN connector (Analog) Connect an antenna or a cable TV box using the coaxial cable
2. HDMI IN connector Connect devices such as a DVD player or set-top box
3. PC Audio connector for VGA Connect the audio cable from your computer
4. VGA connector Connect to the VGA cable from your computer to the TV
5. Component audio and video connectors (AV2 IN) Connect devices such as a DVD player, set-top box, or cable TV box
6. AV-out & Subwoofer audio out connectors AV-out connect devices such as a VCR, Subwoofer audio out connect an optional powered subwoofer to the TV.
7. Composite video, S-Video and audio connectors (AV1/AV3 IN) Connect devices such as a VCR or DVD player
8. Side I/O (AV3 IN) S-Video, composite and audio connectors Connect devices such as a video game system or a DVD player and turn on or turn off the Main power switch the power of your appliance.
9. Power connector Connect your power cord

Precautions when connecting the antenna

Use a coaxial cable which is free from interference. Avoid using a parallel flat wire as interference may occur, causing the reception to become unstable and noise to appear on the screen.

Avoid using an indoor antenna as this may be affected by interference and poor reception.

Keep the power cord as far away from the antenna wire as possible.

VHF(300-Ohm) antenna / UHF antenna

When using a 300-ohm twin lead from an outdoor antenna, connect the VHF or UHF antenna leads to the screws of the VHF or UHF adapter. Plug the 300-ohm to 75-ohm adapter into the antenna terminal on the TV.

When both VHF and UHF antennas are combined

Attach an optional antenna cable signal combiner to the TV antenna terminal, and connect the cables to the antenna mixer. Consult your local electronics retailer.

INSTALLATION INSTRUCTIONS (continued)

Connecting to Video Components

1. Make sure that the power switch of the TV is turned off.
2. Make sure that the power switch of the Video component is turned off.

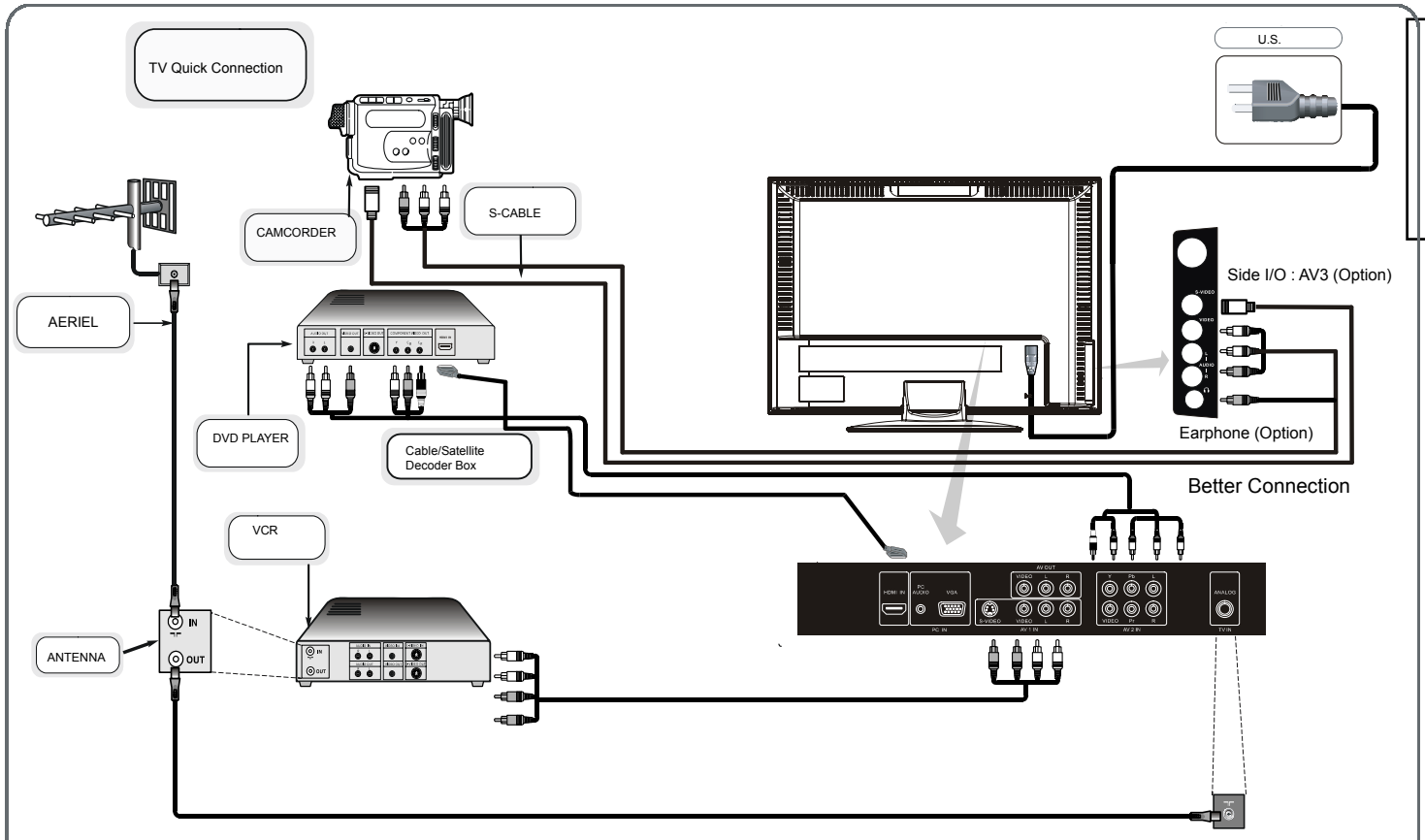

[An example of connecting video components]

If the OUTPUT RCA terminal is connected to a 2nd monitor, it is possible to view the same image as on the main source. The composite video signal from CVBS input will be displayed on both screens at the same time.

Applicable video signals for each input terminal

(See page 36, 37 for details)

Terminal	RCA / 4Pin Mini Din			HDMI	D-Sub
Signal	CVBS	S-Video	Component	Video	RGB
AV1	○	○			
AV2	○		○		
AV3: option	○	○			
HDMI				○	
VGA					○

(○: Available)

INSTALLATION INSTRUCTIONS (continued)

Choose an appropriate site and install the product on a level table where the stand is secure.
Ensure that a power socket is readily accessible near the place where you install the TV.
Make sure that the power switch of this device is turned off.

Connecting to a PC

- 1. Make sure that the display signal of the personal computer to be used is compatible with the specifications of this device.**
See "Product Specifications" concerning the specifications of this device.
- 2. Make sure that the power switch of the personal computer is turned off.**
- 3. Connect the signal input terminal VGA on the rear panel of this device to the display signal output terminal of the personal computer.**

Use a cable that fits the input terminal of this device and the output terminal of the personal computer.
Depending on the type of personal computer being connected, the use of an optional conversion adapter or the adapter provided with the personal computer may be necessary in some cases. For details, refer to the instruction manual of the personal computer or ask the personal computer manufacturer or your local retail dealer.

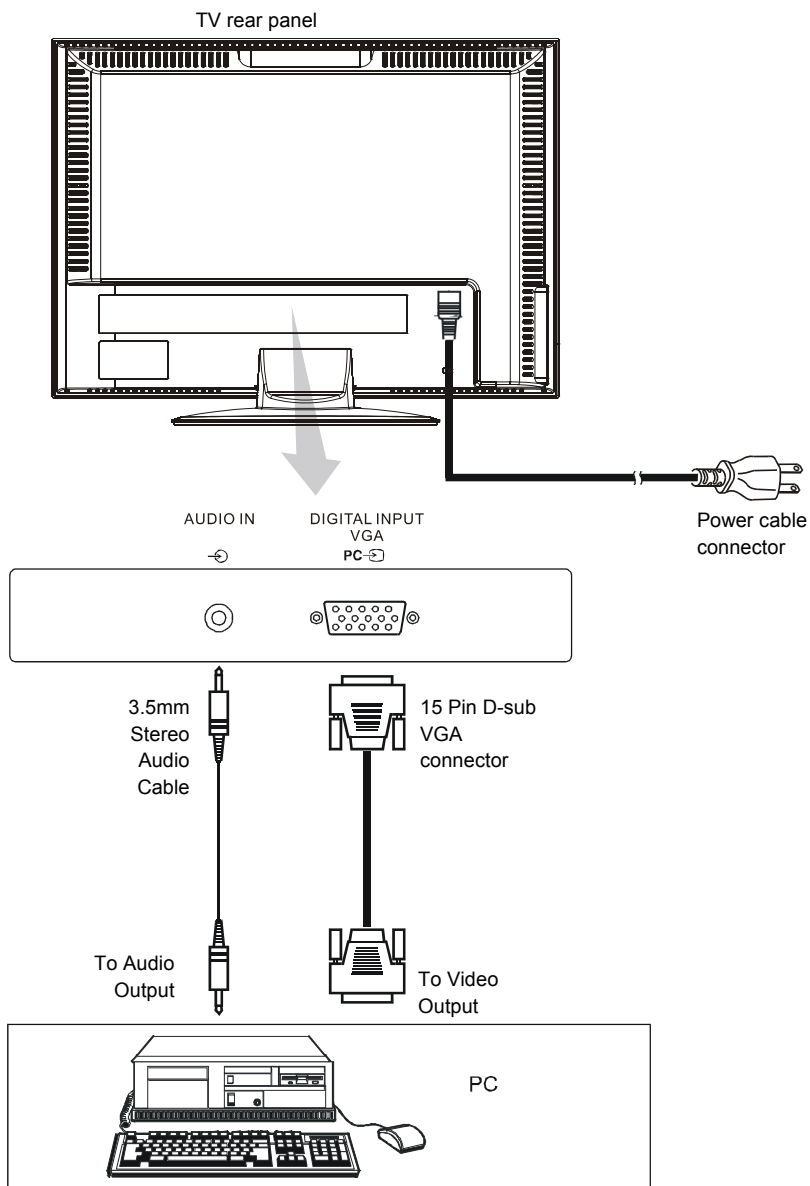

 Note	Please refer to the caution regarding prevention of screen burn in on page 3.
---	---

Subwoofer Output provides a single un-amplified audio output that passes along the audio signal from the LCD TV.
Note: When using a Home Theater audio system with this LCD TV, please connect the sub woofer (if originally supplied with the audio system) directly to the Home Theater components subwoofer terminal.

COMPONENT NAMES

Main Unit

Front

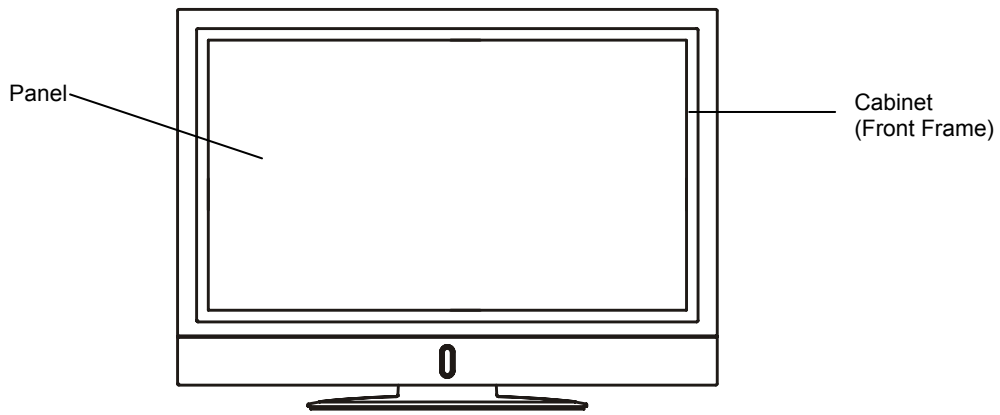

Control Panel

These buttons are located on the top.



Press the television panel power button.

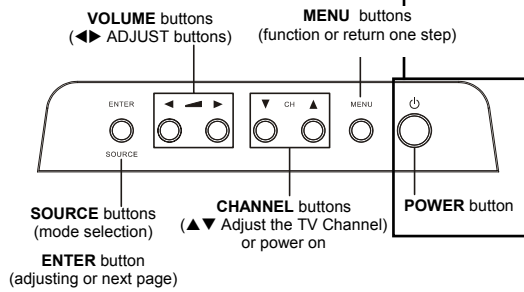

Indicator lamp

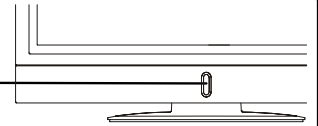

The main power switch is located at the back, on the lower surface.

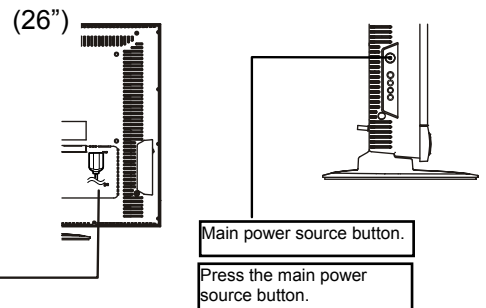

Caution when moving the main unit

As this product is heavy, whenever it is moved, two people are required to transport it safely.

Whenever the unit is moved it should be gripped on the top of the panel and the unit should then be held at the base on both sides for stability as shown.

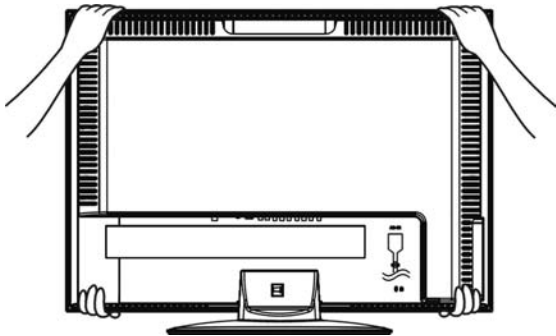

Rear

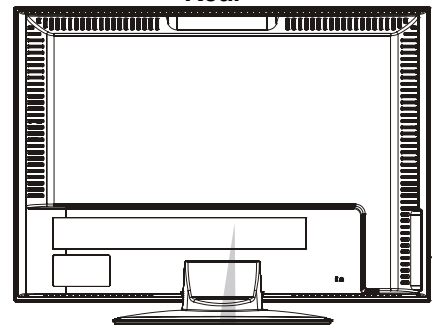

External device connection terminals

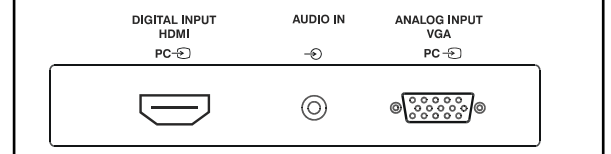

COMPONENT NAMES (continued)

Remote Control

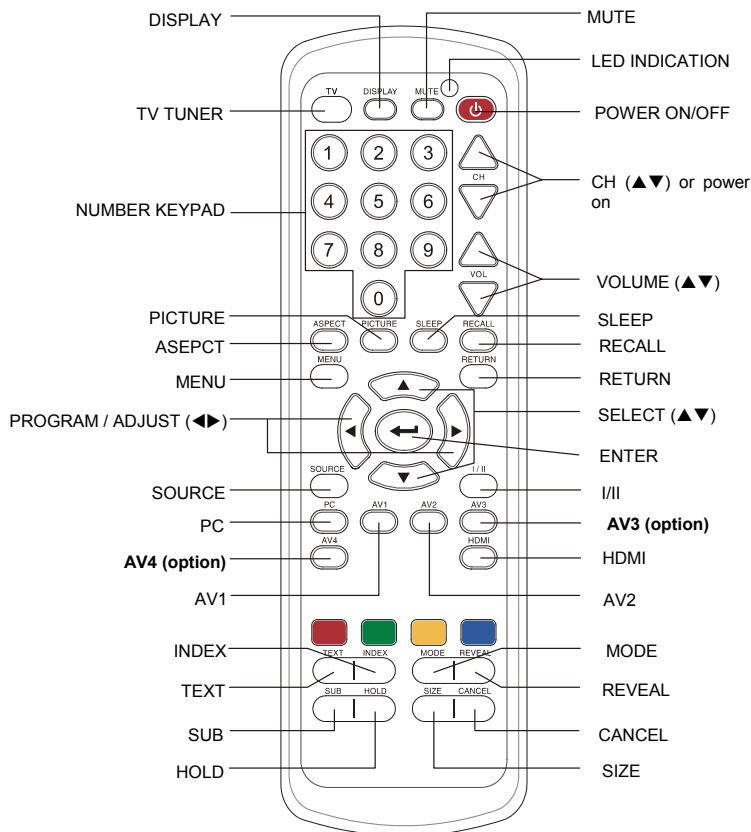

Installing the Batteries

1. Open the battery cover.

Slide back and remove the battery cover in the direction of the arrow.

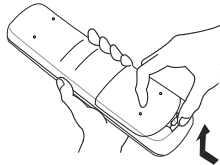

2. Installing the batteries.

Install two included Size AAA batteries observing the correct polarities(+,-).

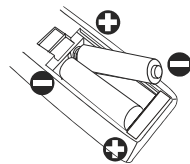

3. Close the battery cover.

Replace the battery cover in the direction of the arrow and snap it back into place.

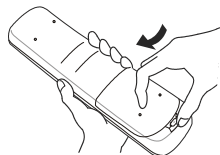

Handling the Remote Control

Use the remote control within about 16 feet from front of the unit's remote-control sensor and within 30 degrees on both sides.

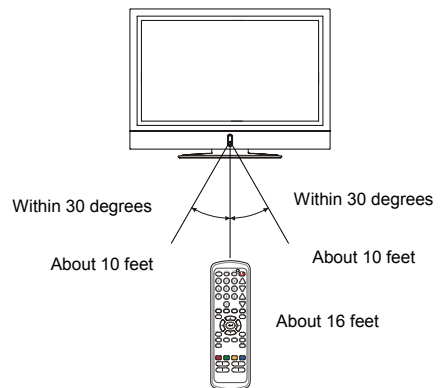

ATTENTION

Do not drop the remote control.

To avoid possible failures, do not splash the remote control with water or put it on a wet object.

If leaving the remote control out of use for an extended period of time, remove the batteries from it.

If the remote control does not respond properly, replace the batteries.

Strong light such as direct sunlight exposed on the photoreceptor of the remote control can cause operational failure. Position this unit to avoid direct contact with such light.



Do not mix new and old batteries together. The batteries could explode or leak, resulting in fires, physical injury, or stains.

When inserting batteries, observe their correct polarities as marked on the product. If inserted in the wrong direction, the batteries could explode or leak, resulting in fires, physical injury, or stains.

COMPONENT NAMES (continued)

Remote Control (continued)

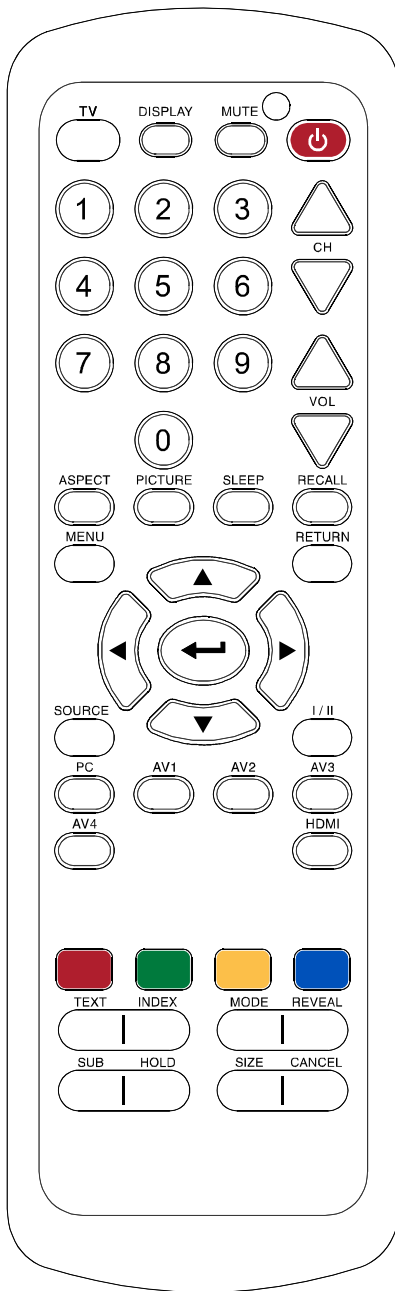

POWER Press this button to turn the TV on or off.	SOURCE OSD source select input menu
MUTE Press this button to turn off the sound. Press it once more or press the volume up button to return the sound.	AV4 Option, depen on model define.
DISPLAY Press this button to show the input signal information	AV3 Switch to input source Side I/O AV3 composite or AV3 S-video. Option, depen on model define.
TV Press this button to choose TV as the source.	AV2 Switch to input source AV2 Component YcbCr/YPbPr or composite
CHANNEL (CH) TV select channels up or down or DC power-on	AV1 Switch to input source AV1 composite or AV1 S-video
VOLUME (VOL) Press these two buttons to adjust the volume up or down	PC Switch to input source PC
RECALL TV switch to last channel program	HDMI Switch to input source HDMI
SLEEP Select timer to turn power off. The default timer is 30, 60, 90 and 120 minutes (Only enable in TV function).	Teletext color Keys Turn ON/OFF conceal information.
0~9 Number Keys Used to select cable TV or Terrestrial programs.	REVEAL For special teletext functions
PICTURE Picture image scheme mode (Personal, Sport, Game, Movie, Vivid)	MODE Teletext Turn ON/OFF list mode.
ASPECT Selcet how the picture is displayed on the screen; pillar box, letter box expand, Panoramic, or Full Screen modes	INDEX Teletext Turn page to index page.
RETURN Return to last level OSD menu	TEXT Turn the Teletext function ON/OFF
MENU Turn on the OSD menu.	CANCEL Press the CANCEL button again into display the TELETEXT screen
◀ ▶ Adjust the selected item on menu.	SIZE Teletext font size change
▲ ▼ * Press to select desired item on the menu * Press to select desired page on the text mode	HOLD Teletext hold funtion
↵ Enter key, confirm OSD select function	SUB Teletext SUB function
I/II TV multi-language sound system select	

OPERATING INSTRUCTIONS

Turning Power Off

1. To turn the TV power OFF, press the power button or the power button on the remote control.

Note: During normal use, the main power switch is set in the ON position.

Power lamp

Power lamp	Power Status	Operation
Dark	Off	When the main power switch is set to OFF.
RED	Off (standby)	When the main power switch is ON, and the OFF button on the remote control or the SUB POWER button is OFF.
GREEN	On	When the main power switch is ON, and the Power or Channel up/down button on the remote control or the Power or Channel up/down button is ON.
AMBER	Off (Power Save)	When the main power switch is ON, and the PC is in power save mode.

When the indicator lamp lights Amber or the message "No Signal connected" or "Going to sleep" appears on the screen, there is something abnormal about the status of the reception.

See Trouble Shooting.

CAUTION

Avoid repeatedly turning the TV on and off at short time intervals. Failures might result from doing so.

Turn off the main power switch before leaving the TV out of use for an extended period of time.

If a power failure occurs while the main unit is running, it would be powered on upon recovery from the failure. Turn off the main power switch when a power failure occurs.

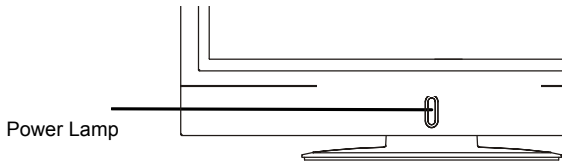

Power Lamp

1

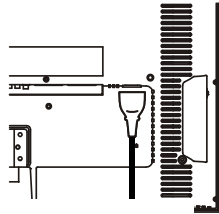

Main power switch

2

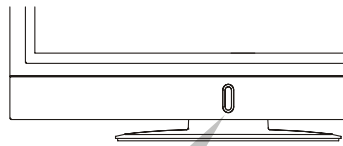

SUB-POWER button

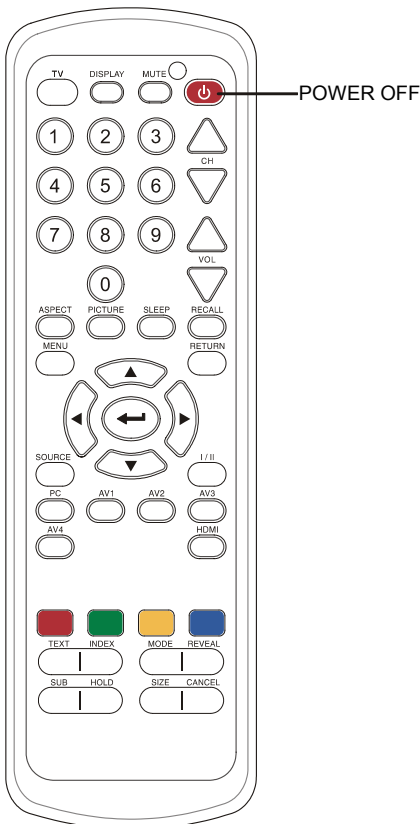
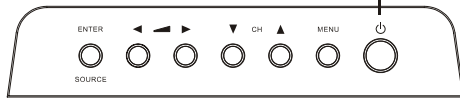

POWER OFF

OPERATING INSTRUCTIONS (continued)

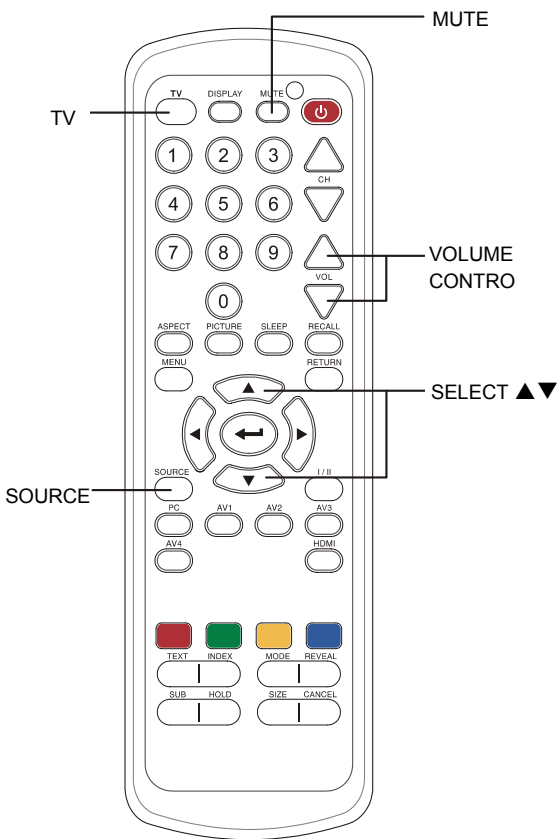
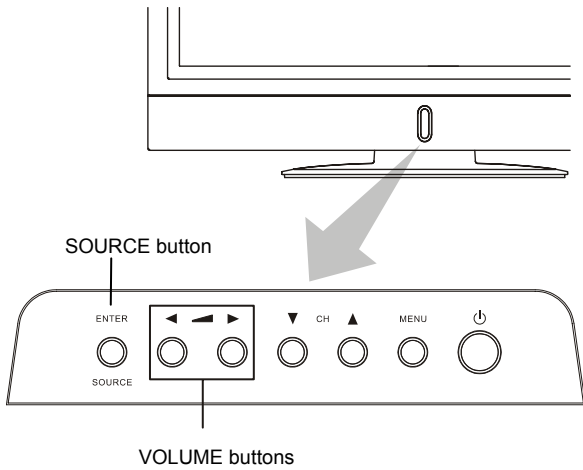

Volume Adjustment

The volume can be adjusted by pressing the ▲ and ▼ buttons of the remote control (or the < - and > + volume buttons of the TV).

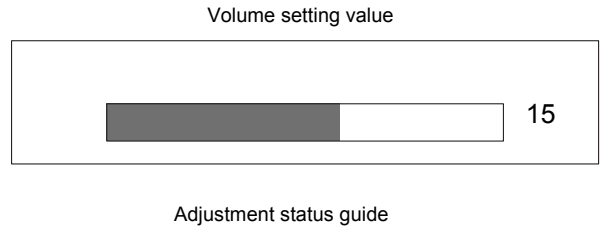

When the volume buttons are pressed, the volume adjustment status guide will be displayed.

The volume will increase when the VOL+ (or ▲) button is pressed while the guide is being displayed.

The volume will decrease when the VOL- (or ▼) button is pressed while the guide is being displayed.

Audio Mute

The audio volume can be temporarily muted by pressing the MUTE button of the remote control.



When the MUTE button is pressed, the above icon will appear.

The volume setting can be lowered by pressing the VOL- button while the audio is muted.

Muting can be cancelled by pressing the VOL+ button or the MUTE button while the audio is muted.

Selecting AV Inputs

Input can be switched by pressing the TV, AV 1, AV 2, AV 3, HDMI, PC buttons

Input can be switched in the sequence TV → AV 1 → AV 2 → AV 3 (OPTION) → HDMI → VGA by pressing the SOURCE button and then select the Input with the select keys ▲ ▼ and then press the ENTER (↵) button. To select a TV station, press the TV button.

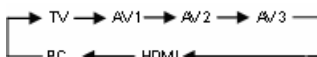

OPERATING INSTRUCTIONS (continued)

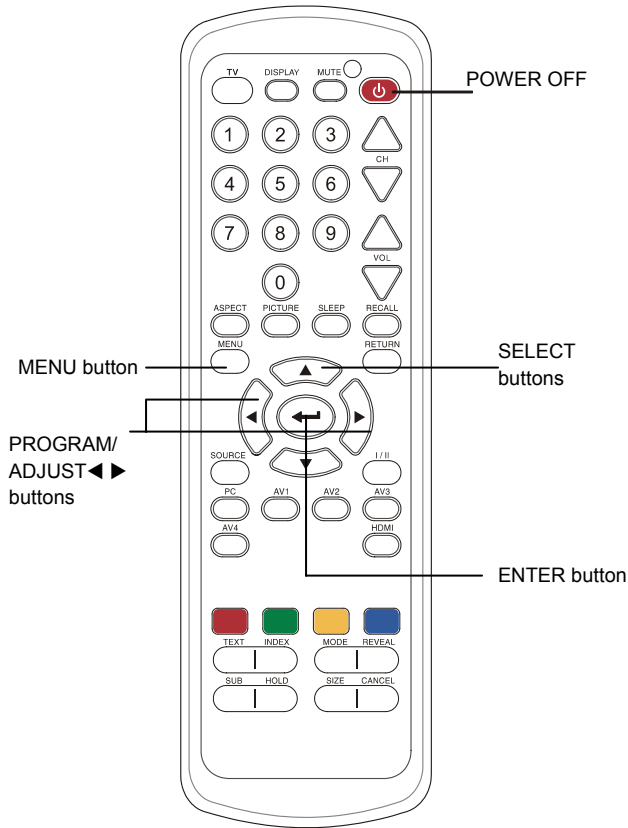

Using the Menu Screen (On-screen display system)

When the MENU button is pressed, the adjustment menu screen will appear. Adjustment and setting are possible by using the SELECT buttons, PROGRAM ADJUST buttons and the ENTER button.

Example: Selecting the Image Settings

1. Press the MENU button to display the Main Menu screen.

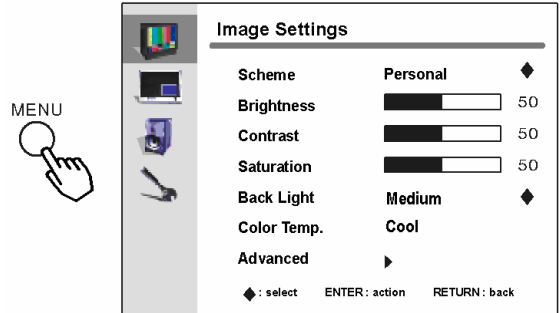

2. Select the Image Settings screen with the ◀ and ▶ PROGRAM ADJUST buttons and press the ◀ ENTER button.

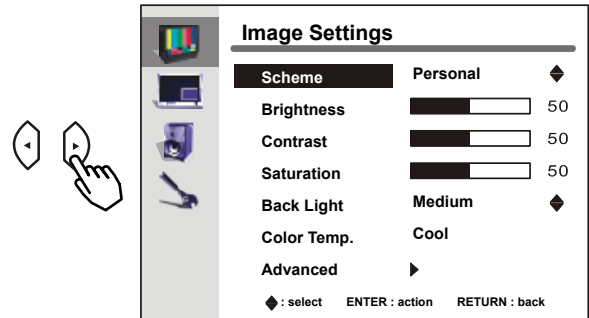

3. Use the ▲ and ▼ SELECT buttons to select the item to be adjusted and then use the ◀ and ▶ ADJUST buttons to adjust (example: Brightness.)

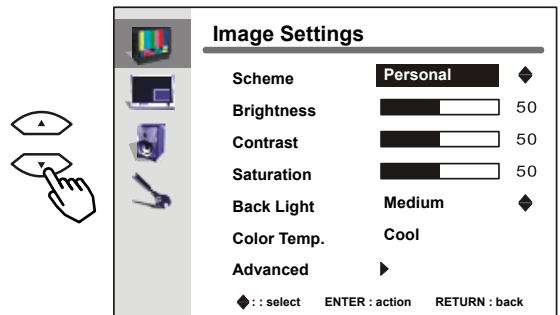

Press the MENU button to return to the previous screen. If there is no operation for a period of one minute, the Adjustment Menu screen will disappear.

OPERATING INSTRUCTIONS (continued)

Display Settings

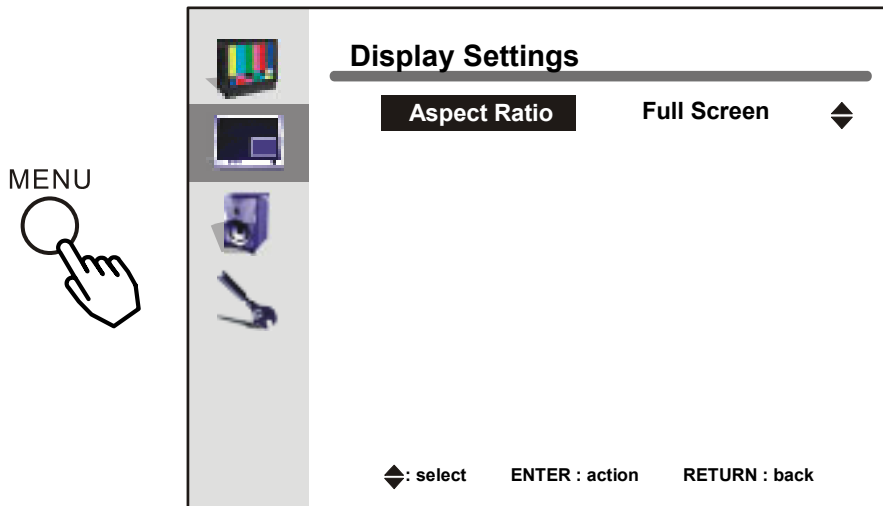

Selecting Source

While a black box appears on the screen, press SOURCE button menu appears.

Picture mode will change in the following sequence, each time the remote button is pressed.

Select the SOURCE by using the ▼ ▲ select keys on the remote control. Then, press the ENTER button.

SOURCE
TV
AV 1 VIDEO1
AV1 SVIDEO
AV 2 VIDEO
AV2 Component
AV 3 VIDEO3
AV3 SVIDEO
PC
HDMI

Or

SOURCE
TV
AV 1 VIDEO1
AV1 SVIDEO
AV 2 VIDEO
AV2 Component
PC
HDMI

Advanced PC

Selected characters	◀	▶	Setup hint
AUTO Adjustment	Press the  ENTER button to action.		Normally set to off mode. Adjust automatically for clock, phase, and position.
POSITION	Press the PROGRAM button to adjust the display position		Adjust the horizontal and vertical display positions.
PHASE	Slows the dot clock Phase		Advances the dot clock Phase
CLOCK	Reduces the dot clock.	Increases the dot clock.	Adjust for maximum character clarity.

Audio Settings

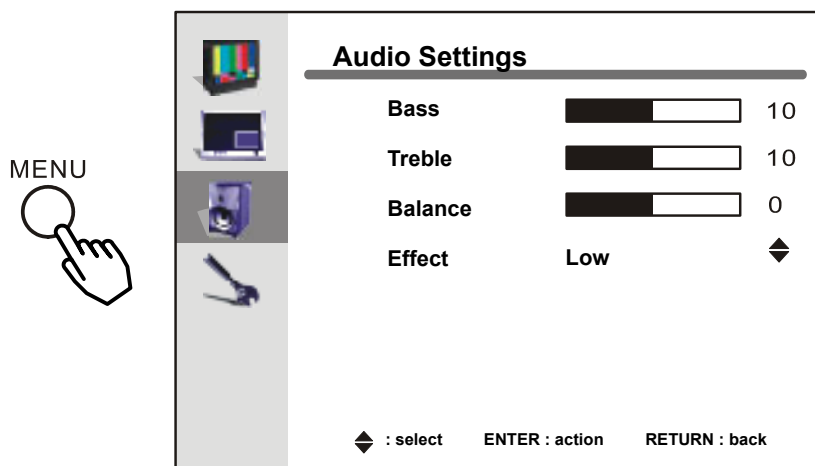

Selected characters	◀	▶	Setup hint
Bass	Decreases bass.	Increases bass.	Adjust as desired.
Treble	Decreases treble.	Increases treble.	Adjust as desired.
Balance	Decreases right volume level.	Increases left volume level.	Adjust as desired.

OPERATING INSTRUCTIONS (continued)

Setup

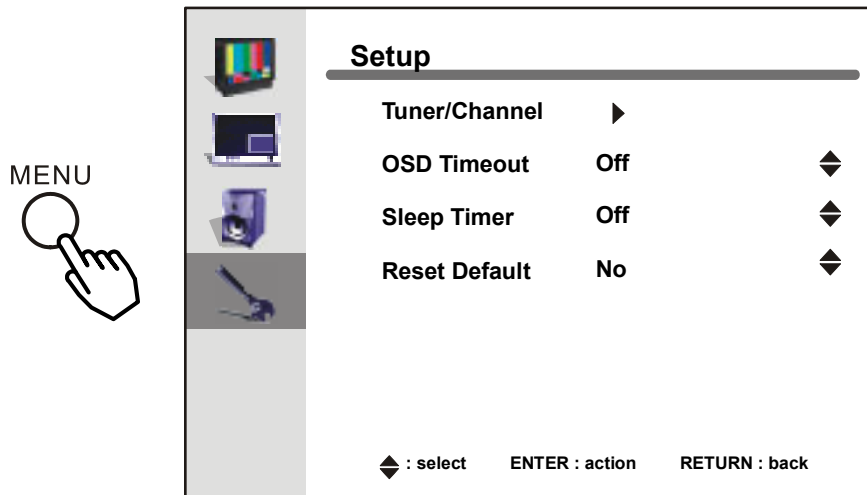

Selected characters	▲	▼	Setup hint
Tuner/Channel			Adjusts Tuner/Channel Settings.
OSD Timeout			Adjusts OSD display and on-screen time
Sleep Timer			Set the TV off time for each mode
Reset Default	YES	NO	Resets all settings to FACTORY defaults.

* Depending on the type of signal displayed, displays may not be optimized through automatic adjustment. Manually adjust to optimize them.

* When operating the TV at first time, its TV system is at "default factory mode" and this mode cannot display the image normally on the screen. In order to watch the TV program without problem, please refer to the page 28 to setup the TV system accordingly for normally display.

OPERATING INSTRUCTIONS (continued)

Channel Setting

*Note: The TV must be in TV mode for access to this Menu.

When operating the TV at first time, its TV system is at "default factory mode" and this mode cannot display the image normally on the screen. In order to watch the TV program without problem, please refer to the follow steps to setup the TV system accordingly for normally display

1. **Auto Scan:** then execute **Auto Scan** when you select Country already

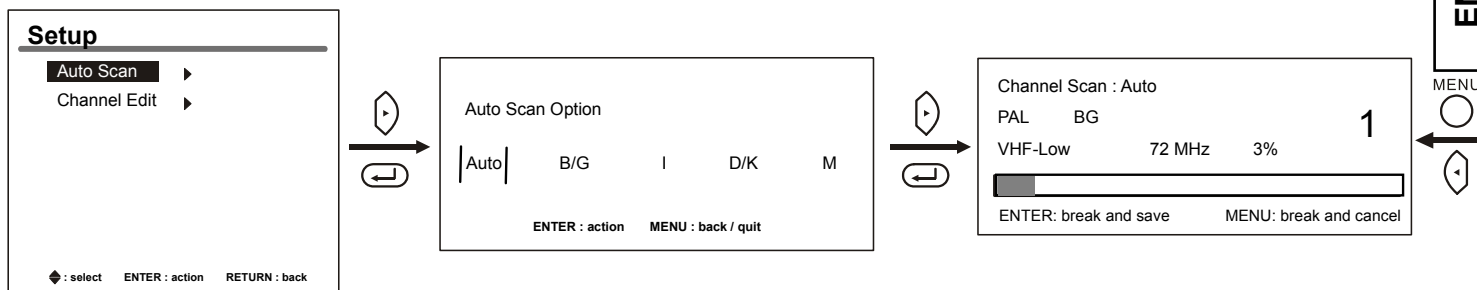

2. **Channel Edit**

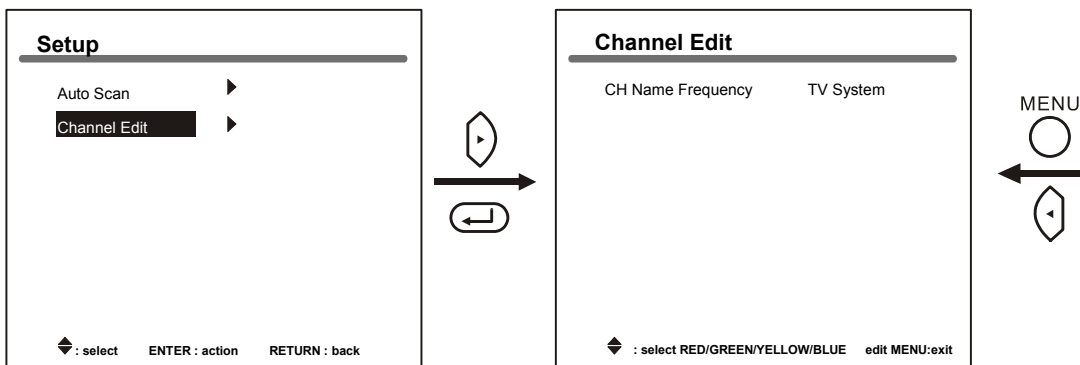

Selected characters	◀	▶	Operating hint
Auto Scan		--	Press "ENTER" will display the TV system options menu, select any mode to auto scan TV channel. If select "auto" mode option will auto detect TV system, else will set TV system as option mode.
Channel Edit	Red : Channel Swap edit Green : Channel Name edit Yellow : Channel Frequency edit Blue : Channel System edit		Press correct color button to edit channel.

NOTE:

Connecting the antenna or cable. Please execute the **System Frequency Scan** first.

1 Enter "Channel Edit" menu:

1.1 Press "Menu" key to enter OSD -> Select "Setup" page-> "Tuner/Channel"-> "Channel Edit", you will see "Channel Edit" menu, it will display the channels that the TV currently can show

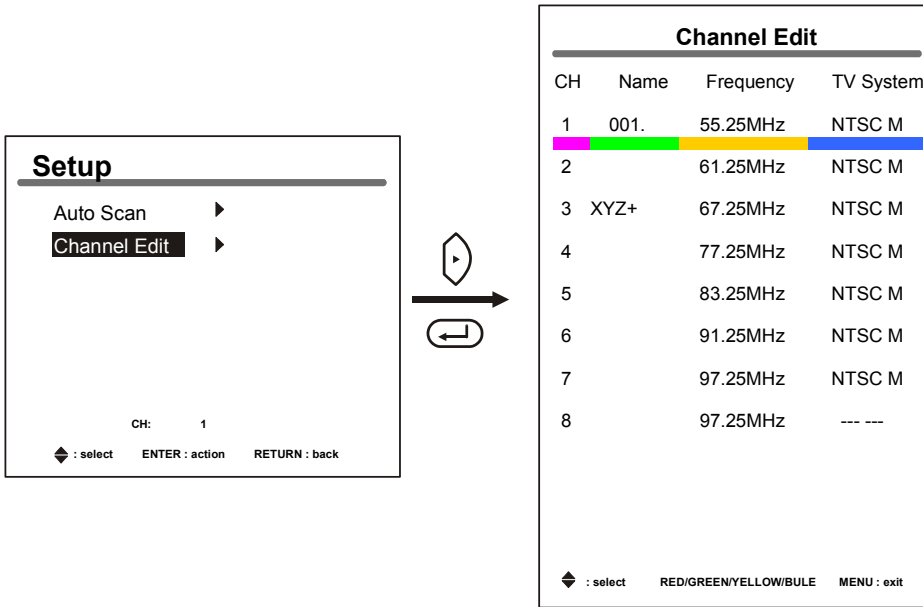

2 Select channel: use "Up/Down" key to select channel

3 Edit channel Data: different Color keys can be used to edit channel's info, details as below:

3.1 Red key: can swap between two channels, example: when the color bar is at CH1, press the "Red" key and then move the color bar to CH3 and press again on the "Red" key, CH1 will swap with CH3

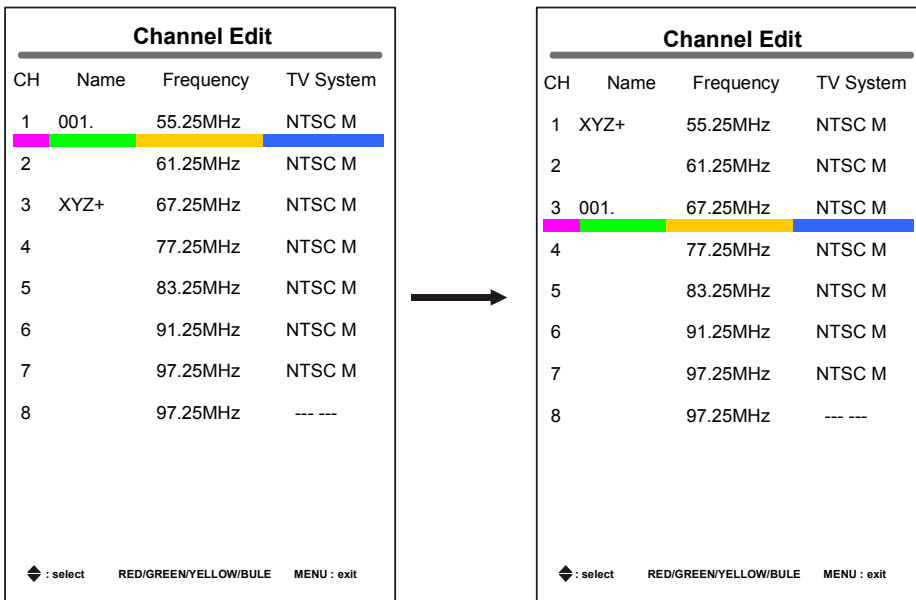

3.2 Green key: to edit the channel name. After pressing the "Green" key, using the "Left/Right" key and move to the desired name position and use "Up/Down" key to select the characters you need

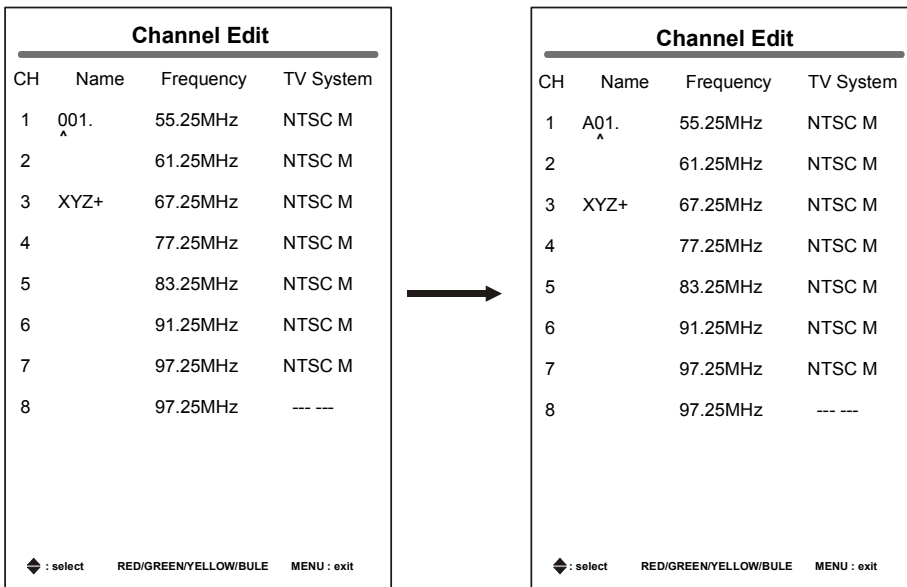

- 3.3 Yellow key: for editing channel's frequency. After pressing the "Yellow" key, it will show a frequency tuning window, use "Up/Down/Left/Right" to tune to your required frequency

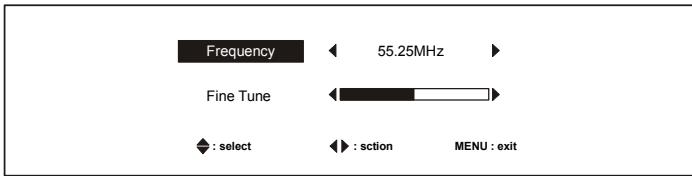

- 3.4 Blue key: for editing the TV system. After pressing the "Blue" key, it will show a TV system edit window (containing Color and Sound system), use "Up/Down/Left/Right" to change to your required Color and Sound system

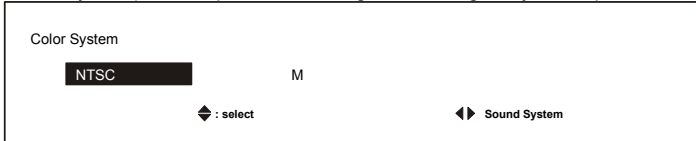

4 The Other functions:

- 4.1 Add: when you open the "Channel Edit" menu, you will see that at the end of the list will be a channel with "---" as the sound system. This is automatically added for user to edit new channel. You can move the color bar to there and edit the Sound system of that channel, once you change the sound system to none "---", the system will automatically add a new channel for user to edit, this will continue until the maximum channel number supported is reached

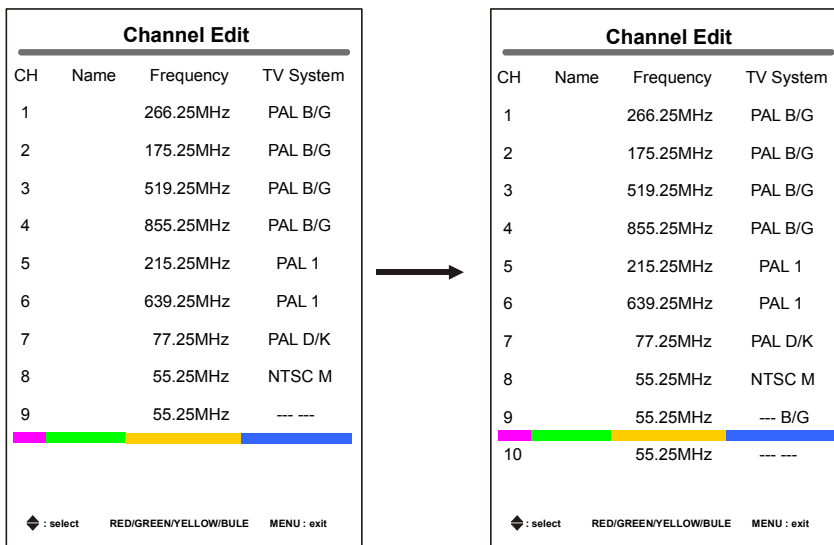

- 4.2 Skip: if there is channel that you would like to skip, you can use "Blue" key in "Channel Edit" menu and change the Sound System in the TV System to "---" and then exit the "Channel Edit" menu. After this, use "Channel Up/Down" key to change channels, it will skip the channel that Sound System has changed to "---"



- 4.3 Auto Clean Channel List: when the user exit the "Channel Edit" menu, the system will automatically delete the channels whose Sound System set to "---" at the bottom of the list

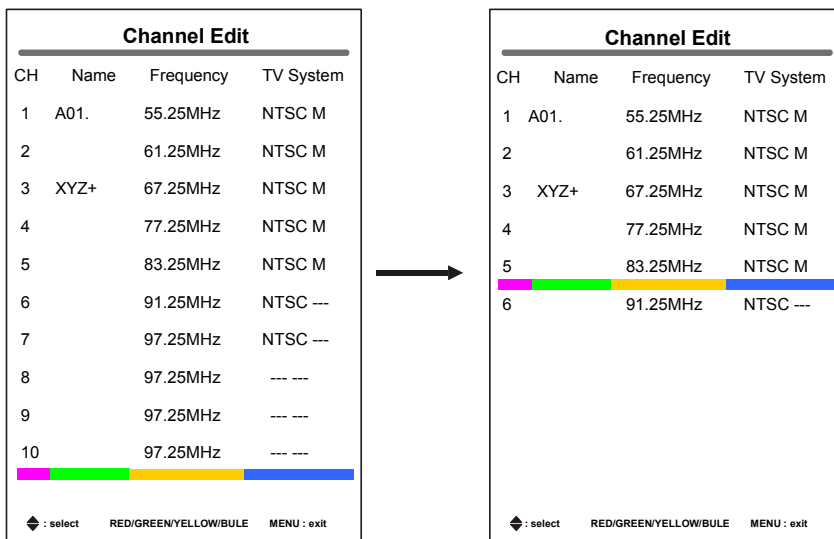

3. MPX(I/II) of remote control:

The MPX(I/II) button of remote control is used only when using the TV system and different TV system will present difference selection.

When a bilingual program is received, the sound mode display appears as shown on the right. Press the MPX(I/II) button to select the sound to be heard

1). PAL TV SYSTEM :

NICAM_DUAL and NICAM_STEREO (2nd Audio program) sound program

NICAM_DUAL signal received

Each time the button is pressed, NICAM_DUAL_I, NICAM_DUAL_II or FM MONO appears on the screen.

NICAM_STEREO signal received

NICAM_STERRO, NICAM_MONO or FM MONO appears on the screen.

NICAM_MONO signal received

Each time the button is pressed, NICAM_MONO or FM MONO appears on the screen.

FM_STEREO sound received

Each time the MPX(I/II) button is pressed, FM STEREO, FM MONO will appear on the screen.

FM_DUAL sound signal received

Each time the MPX(I/II) button is pressed, FM MONO, FM DUAL I, FM DUAL II will appear on the screen.

FM_MONO Monaural sound

When a monaural program is received, the sound mode display will be shown. You can press the MPX(I/II) button to manually select monaural Sound.

BTSC sound signal received

Each time the MPX(I/II) button is pressed, MONO, STEREO will appear on the screen. If channel program support second language, SAP will appear on the screen.

OPERATING INSTRUCTIONS (continued)

ASPECT

Each time the ASPECT button of the remote control is pressed, the screen display size will change in sequence and the status will be displayed at the bottom of the screen.

During TV/VIDEO signal input (AV 1, AV 2, AV 3 (option))

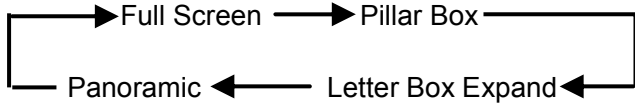

Note: For VGA, you can select Full Screen and Pillar Box

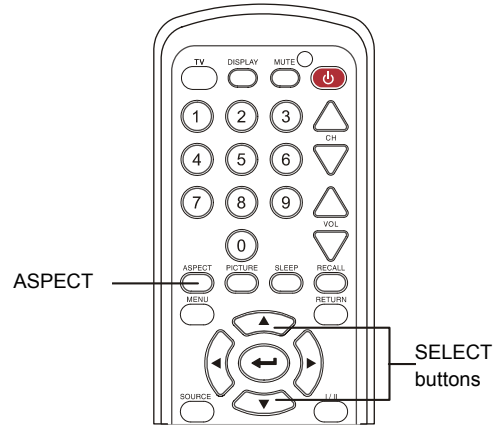

ZOOM

Each time when ▲ ▼ SELECT is 16:9, the ZOOM button of the remote control is pressed, the screen display zoom size will extend linearly (Zoom=0~ 5 in sequence)

Resolution	Full display	Display		
Display	Full(Zoom=0)	Zoom1	Zoom2	Zoom3~Zoom5
TV				Image extend linearly
AV 1				
AV 2				
AV 3 (Option)				
HDMI				

Processes such as expansion are performed for the above signal display. Because of this, there is a possibility that flicker may become noticeable on Zoom = (1 ~ 3) depending on the display contents.

OPERATING INSTRUCTIONS (continued)

Teletext Menu

Text / MIX

Teletext is an information system broadcast by certain channels which can be consulted like a newspaper. It also offers access to subtitles for viewers with hearing problems or who are not familiar with the transmission language (cable networks, satellite channels, etc.).

Press TEXT / MIX Key: This is used to call teletext, and exit this function when press again

Press 0 / 9 or ▲ and ▼ :

This is used to select a page when TEXT function enable, enter the number of the page required using the 0 to 9 to select a desired page, example: page 120, enter 1 2 0

CH▲ and CH▼ can select page up or page down.

Press     **direct access to the items.**

Colour areas are displayed at the bottom of the screen. The 4 coloured keys are used to access the items or corresponding pages.

Press TEXT / MIX key:

This is used under TEXT function enable. The function is to mix current TV image and teletext display, press MIX key again to disable the mix function .

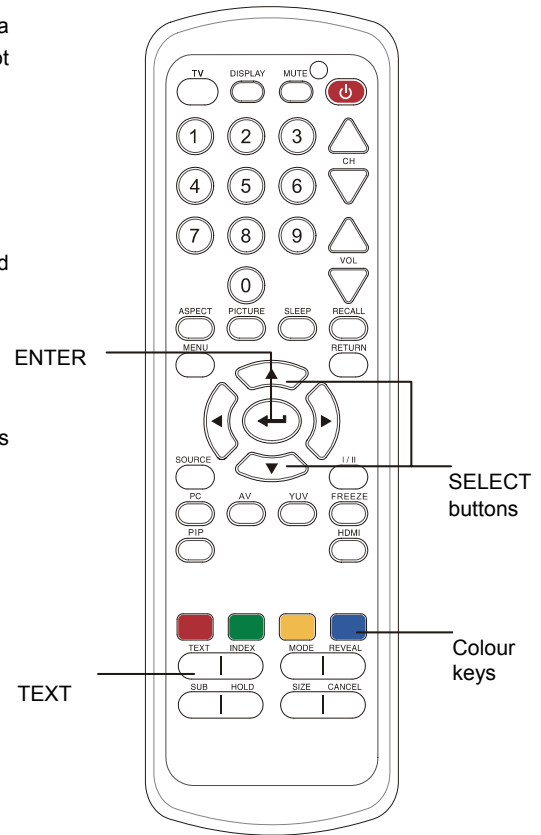

TROUBLESHOOTING

Symptoms

If the point to check does not correct the symptoms, please contact your local Service center for assistance.



WARNING

Self servicing can be hazardous.

Symptom		Point to check	See Page
There is no picture and the power-indicating lamp is off.		Check to see that the power cable is properly connected. Press the main switch.	18 ①
The message "No Signal" or "Going To Deep Sleep" is displayed. There is no picture and the power indicating lamp lights Amber.		No sync signal is detected. Check that the signal cable is properly connected. Make sure that the computer, imaging equipment, etc., is turned on. Make sure the computer is not in power-save mode. Ensure that the input selection matches the connection terminal.	14
The message "Invalid Scan Freq." is displayed.		An input signal is received abnormally. Ensure that the input signal matches the monitor specifications. Check to see that the signal cable is properly connected.	14 37 13
The power indicating lamp is lit normally but there is no picture.		Check the contrast and brightness settings (adjust them for higher contrast and brightness). Check to see that the signal cable is properly connected.	21 13
The display image appears slanted. Text displayed across the screen appears vertically streaked, with the characters in vertical columns blurred.		Adjust the clock frequency and the phase. (Adjust the clock frequency first, the dot clock phase next.) (VGA input)	26 26
Text displayed across the screen appears blurred. A fine pattern flickers when displayed on the screen.		Adjust the clock phase till the desired clarity is obtained. (RGB input)	26 14
The remote control does not work.		Ensure that the batteries in the remote control are inserted with the correct polarity. Check to see that the batteries in the remote control are functional.	16

TROUBLESHOOTING(continued)

Symptoms(continued)

Symptom	Point to check	See Page
The temperature of the display panel surface is warm.	The LCD display panel works by lighting phosphors. In some cases, this may cause the temperature of the panel surface to increase. Please note that this is not a malfunction.	-
Points that do not light, points with brightness different from that of the periphery, points with color different from that of the periphery, etc.	High-precision technology is used to manufacture the LCD display panel, However over the life of the LCD panel, a few pixel elements may fail. This is not to be considered a defect in the panel.	-
Coarse horizontal stripes appear in FULL display.	Adjusting the Clock Phase will reduce the horizontal stripes. (RGB input)	26 13
The screen flickers in the form of horizontal lines oscillating up and down. (PC INPUT MODE only)	If the frequency from the computer is below 75Hz, try a higher frequency (to a maximum limit of 75Hz). There may be a slight attenuation of the current image.	
The top surface of the monitor heats up.	When used for long periods of time, the top surface of the monitor may heat up. This is not a malfunction.	-
Text characters are displayed with varying thickness.	The thickness of characters and lines may vary when images with a vertical resolution greater than 720 lines are displayed; however this is not a malfunction.	-
The display does not seem bright enough.	The ambient temperature of the monitor may be low. Ambient temperatures less than about 15° degrees, may cause lower luminance. The panel protection circuit automatically lowers the luminance, and is not a malfunction. The luminance will be restored when power is turned on for a while.	-
The display does not seem bright enough. (RGB input)	The setup-frequency setting in RGB input may be set to PC mode. When set to PC mode, the luminance is lowered by about 10% than when set as Movie mode. This is not a malfunction. If you do not mind flicker on the display, please switch to Movie mode.	-

TROUBLESHOOTING(continued)



Symptoms(continued)

Make the checks suggested below depending on the symptoms observed. If the symptoms remain unresolved, contact your dealer.

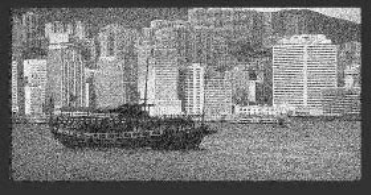

WARNING

Do not attempt to service this unit.

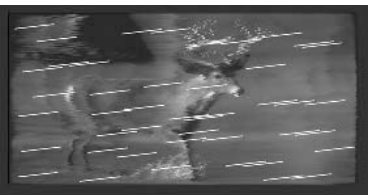
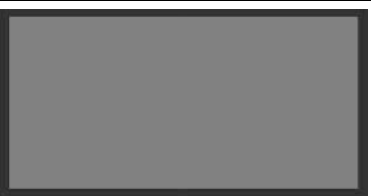
Symptom	Possible reason	Remedy
 snowy picture - poor sound	(1)Connection of antenna/cable lead in wire to the TV is poor (2)Corroded or poor antenna/cable connections (3)Antenna has moved position (4)Adverse weather conditions (5)Transmitter problems	(1)Make new connection and/or change antenna plug (2)Make new connections or use new cable. (3)Re-align the antenna (4)None (5)Check with the local Operator
 multiple images - sound O.K	(1)Antenna has moved position (2)Adverse weather conditions (3)Transmitter problems (4)AV Input is not set correctly (5)Corroded or poor antenna / cable connections	(1)Re-align the antenna (2)None (3)Check with the local Operator (4)Check the external equipment connected (5)Make new connections or use new cable.
 intermittent interference	(1)Interference from electrical or mechanical motors, fluorescent lights, portable radios etc. (2)Corroded or poor antenna/cable connections.	(1)Check devices for shielding and renew if necessary or move further from TV (2)Make new connections or use new cable.
 no picture or sound	(1)TV may be in AV mode (2)Picture/sound setting is set to minimum (3)TV is in standby or power save mode (4)Corroded or poor antenna / cable connections.	(1)Press the PROGRAM button or the@to@ buttons on your remote control to return to normal TV mode (2)Check picture / sound controls (go to MAIN MENU) (3)Press POWER ON / OFF button (4)Make new connections or use new cable.

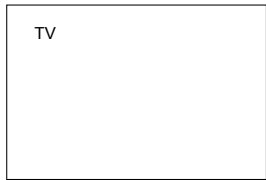

TROUBLESHOOTING (continued)

Abnormal Displays Corrections VGA Only

Depending on the kind of system equipment used, images may not be displayed normally. In this case, make the adjustments suggested below. (only forVGA)

Symptom 1	Text displayed across the screen appears vertically streaked, with some characters blurred (figure 1). The display image appears flowing (figure 2) (VGA input).
Example	<p>Figure 1</p> <p>Figure 2</p>
Adjustment procedure	<ol style="list-style-type: none"> 1) Press the MENU button. The Main Menu will be displayed. 2) Press the ▼ SELECT button and Select Setup. 3) Press the ENTER button. The Setup Menu will be displayed. 4) Press the ▼ SELECT button and select Auto Adjust.
	<p>When adjustment is not possible with Auto Adjust:</p> <ol style="list-style-type: none"> 5) Press the MENU button. The Main Menu will be displayed. 6) Press the ▼ SELECT button and select Setup. 7) Press the ENTER button. The Setup Menu will be displayed. 8) Press the ▼ SELECT button and select Horizontal Clock. <p>(Displays fine patterns as characters or a vertical striped pattern over the entire screen during Horizontal Clock adjustment.)</p> <ol style="list-style-type: none"> 9) Press the ◀ or ▶ ADJUST buttons and search for clear characters over the entire screen. 10) Perform adjustment for symptom 2 below, when the characters are blurred on the entire screen.

The display image may be momentarily disturbed during clock adjustment but this is not a failure.

Symptom 2	Text displayed across the screen appears blurred in its entirety (figure 2). A fine pattern flickers when displayed on the screen (figure 3).
Example	<p>Figure 2</p> <p>Figure 3</p>
Adjustment procedure	<ol style="list-style-type: none"> 1) Press the MENU button. The Main Menu will be displayed. 2) Press the ▼ SELECT button and Select Setup. 3) Press the ENTER button. The Setup Menu will be displayed. 4) Press the ▼ SELECT button and select Auto Adjust.
	<p>When adjustment is not possible with Auto Adjust</p> <ol style="list-style-type: none"> 5) Press the MENU button. The Main Menu will be displayed. 6) Press the ▼ SELECT button and select Setup. 7) Press the ENTER button. The Setup Menu will be displayed. 8) Press the ▼ SELECT button and select Clock Phase. <p>(Displays fine patterns as characters or a vertical striped pattern over the entire screen during Clock Phase adjustment.)</p>
	<ol style="list-style-type: none"> 9) Press ◀ or ▶ ADJUST buttons to make the text appear clean across the screen.
	<ol style="list-style-type: none"> 9) Press ◀ or ▶ ADJUST buttons to make the text appear without flickering.

PRODUCT SPECIFICATIONS

Panel	Display dimensions	Approx. 26inches (575.769 (H) × 323.712 (V) mm)
	Resolution	1360 (H) × 768 (V) pixels
Net dimensions		790 (W) × 585.3 (H) × 308.5 (D) mm (Speaker W/I under)
Net weight		18.5+-0.5 kg (including Speakers / Stand)
Ambient conditions	Temperature	Operating: 5°C to 35°C, Storage: -15°C to 60°C
	Relative Humidity	Operating: 20% to 80%, Storage: 20% to 90% (non-condensing)
Power supply		AC100 - 240V, 50/60Hz
Power consumption/at standby		220W / < 2W
Audio output		Speaker 10W + 10W (8 ohms)
(RGB input)		
Input signals	Input terminals	Audio input terminal (3.5mm Stereo Mini Jack) VGA analog RGB input terminal (D-sub 15-pin) HDMI input terminal
	Video signals	0.7 V
	Sync signals	H/V separate, TTL level H/V composite, TTL level
(Video input)		
Input signals	Input terminals	AV1 IN: Composite video, S-VIDEO input terminal for CVBS(RCA), S-VIDEO(4 pin mini din) AV1 IN: L/R audio input terminal for CVBS or S-Video (RCA) AV2 IN: Composite video, Component input (Y-CbCr or Y-PbPr)(RCA) AV2 IN: L/R audio input terminal (RCA) AV3 IN (option): Composite video, S-VIDEO input terminal for CVBS(RCA), S-VIDEO(4 pin mini din)AV3 IN: L/R audio input terminal for CVBS or S-Video (RCA)
	Video signals	AV1,AV3 (option):NTSC-M/PAL/SECAM AV2, :480i,480p,576i,576p,720p/60,720p/50,1080i/60,1080i/50
Video output Signal		OUTPUT (MONITOR): composite video monitor-output terminal (RCA) OUTPUT (MONITOR): L/R audio monitor- output terminal (RCA)
Input signals	Input terminals	ANT: 75 ohms Unbalanced
	RF Video stem	PAL – DK / BG / I / M NTSC – M / DK / BG / I SECAM – DK / BG / I

- It takes at least 30 minutes to attain the maximum picture quality.

PRODUCT SPECIFICATIONS (continued)

Component Connection

Component Connection

VGA Input (D-sub 15 pin connector)

Pin	Input signal
1	R
2	G or sync on green
3	B
4	No connection
5	No connection
6	R.GND
7	G.GND
8	B.GND
9	No connection
10	GND
11	No connection
12	[SDA]
13	H. sync or H/V composite sync
14	V.sync. [V.CLK]
15	[SCL]

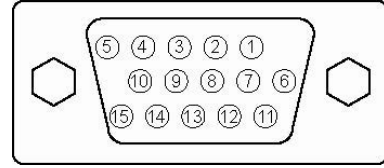

When different kinds of input signals are simultaneously input to the TV via a graphics board or the like, the TV will automatically select the signals in the following priority order:

Sync signal type	Priority
H/V separate sync.	1
H/V composite sync.	2
sync. on Green *	3

*Even in the case of the recommended signals shown on the following page, there may be instances when correct display is not possible. In this case, use H/V separate sync, or H/V composite sync.

HDMI Input

Pin	Input Signal	Pin	Input Signal
1	T.M.D.S. Data2+	14	No Connect
2	GND	15	SCL
3	T.M.D.S. Data2-	16	SDA
4	T.M.D.S. Data1+	17	GND
5	GND	18	+5V
6	T.M.D.S. Data1-	19	HPDET
7	T.M.D.S. Data0+		
8	GND		
9	T.M.D.S. Data0-		
10	T.M.D.S. CLK+		
11	GND		
12	T.M.D.S. CLK-		
13	No Connect		

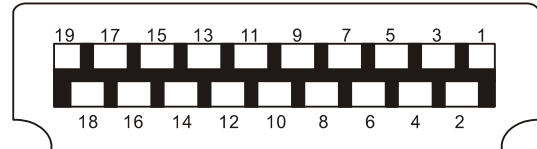

PRODUCT SPECIFICATIONS (continued)

Recommended Signal List

Digital HDMI Video Timing Chart

No.	Resolution	H-freq (kHz)	V-freq. (Hz)	Preposed	Remark
Video (Digital)					
1	720 x 480i	15.734	60		
2	720 x 480P	31.5	60		
3	720 x 576i	15.625	50		
4	720 x 576P	31.25	50		
5	1280 x 720P	45	60		
6	1280 x 720P	37.5	50		
7	1920 x 1080i	33.75	60		
8	1920 x 1080i	28.125	50		

Note : Vertical frequency : standard ± 1 Hz

Vertical lines : standare ± 14 lines

Analog RGB Video Timing Chart

No.	Resolution	H-freq (kHz)	V-freq. (Hz)	Preposed	Remark
PC (Analog)					
A	640 x 350	31.5	70		
B	640 x 480	31.5	60	VGA	
C	640 x 480	37.5	75	VGA	
D	720 x 400	31.5	70		
E	800 x 600	37.9	60	SVGA	
F	800 x 600	46.9	75	SVGA	
G	1024 x 768	48.4	60	XGA	
H	1024 x 768	56.5	70	XGA	
I	1024 x 768	60	75	XGA	
J	1280 x 768	48.1	60	SXGA	

With Composite Input and S-video Input (AV1~AV2 input)

No.	Signal mode			Horizontal frequency (kHz)	Remarks
	Signal name	Resolution	Vertical frequency (Hz)		
1	NTSC-M	525	59.94	15.73	
2	PAL	625	50	15.625	
3	SECAM	625	50	15.625	

With Y, Cb, Cr / Y, Pb, Pr input (AV2 component input)

No.	Signal mode			Horizontal frequency (kHz)	Remarks
	Signal name	Resolution	Vertical frequency (Hz)		
1	480i	480	59.94	15.73	
2	480p	480	59.94	31.47	
3	576i	576	50.00	15.63	
4	576p	576	50.00	31.26	
5	720p/50	720	50.00	37.50	
6	720p/60	720	60.00	45.00	
7	1080i/50	1080	50.00	28.13	
8	1080i/60	1080	60.00	33.75	

- The TV differentiates the signal modes according to the horizontal and vertical frequencies and the horizontal and vertical sync signal polarities. Note that different signals having all these elements alike may be handled as the same signal.
- Displaying images is not 720 lines of vertical resolution at Full display (compressed display) can result in the interpolation of stripes

Consumer Information Centres

SERVICE CONTACTS

If problems remain after checking this manual, please contact your place of purchase or contact:

Australian Service Contacts,

Visit the Customer Support section of Mitsubishi Electric Australia's web site at www.mitsubishielectric.com.au for details of your nearest Mitsubishi Electric Authorised Service Center, or contact the Service Department for your state:

New South Wales and Australian Capital Territory

348 Victoria Road
Rydalmere, NSW, 2116
Telephone: (02) 1300 651-808
Fax: (02) 9684-7684

Queensland

Unit 12 469 Nudgee Road
Hendra, QLD, 4011
(Airlink Business Park)
Telephone: (07) 3623-2000
Fax: (07) 3630-1888

South Australia and Northern Territory

77 Port Road
Hindmarsh, SA, 5007
Telephone: (08) 8340-0444
Fax: (08) 8340-0555

Victoria and Tasmania

4 / 303 Burwood Hwy
East Burwood, VIC, 3151
Telephone: (03) 9262-9899
Fax: (03) 9262-9850

Western Australia

5 / 329 Collier Road
Bassendean, WA, 6054
Telephone: (08) 9377-3411
Fax: (08) 9377-3499

