

7" Wide Touch Screen  
In-Dash Fully Motorized TFT Monitor  
/DVD/AM/FM/Bluetooth

# OWNER'S MANUAL

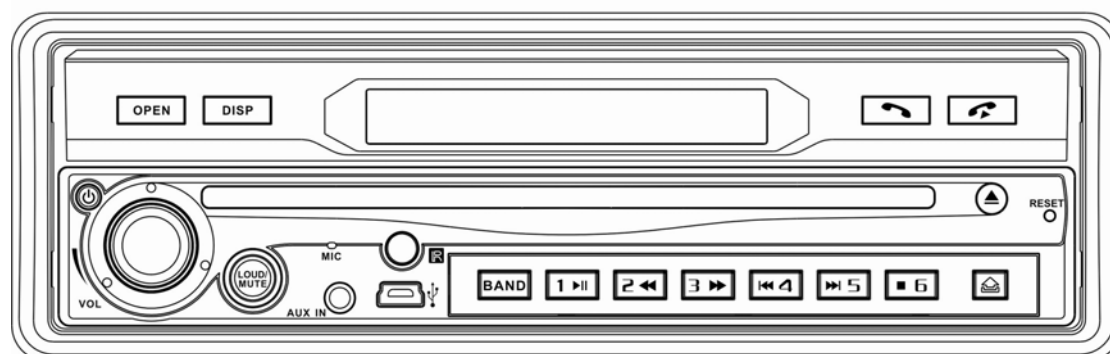
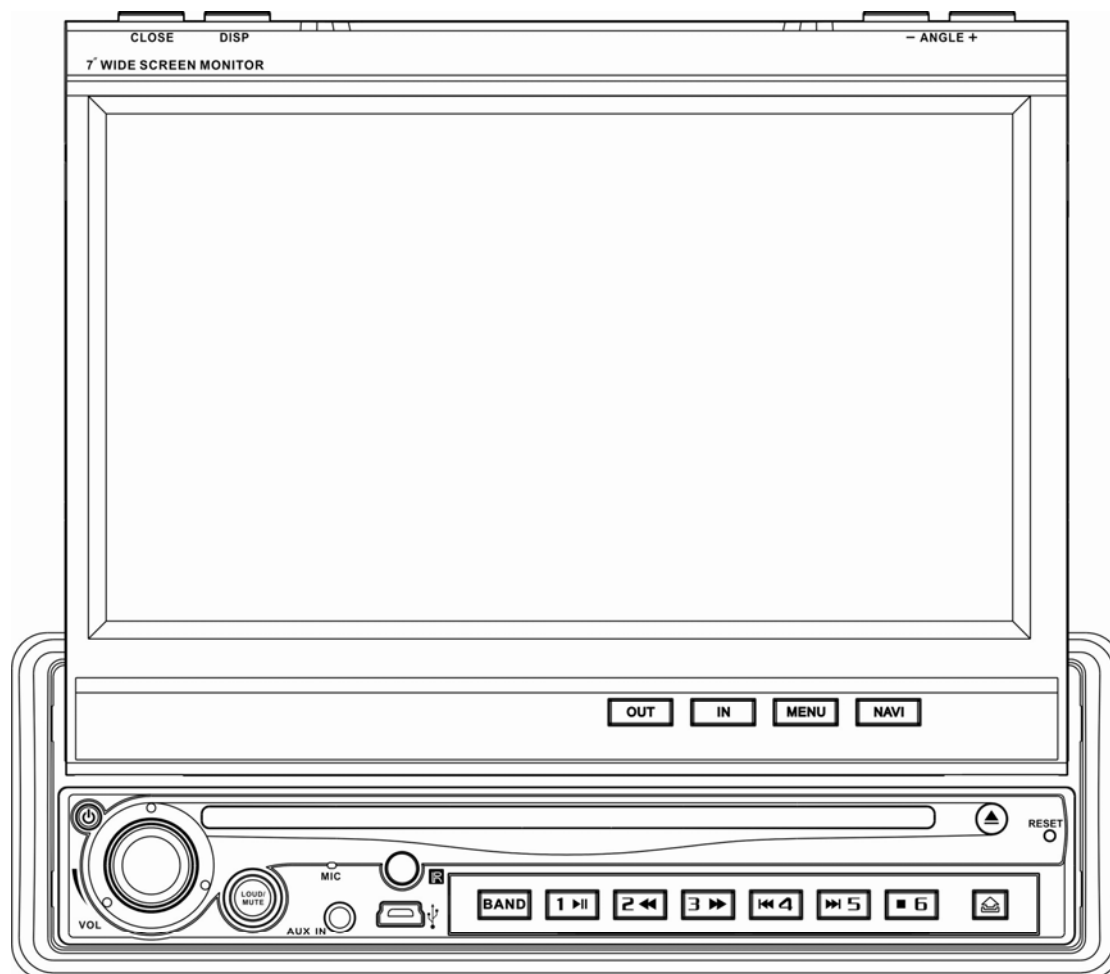

## **TABLE OF CONTENTS**

Table of Contents.....	1
Safety Information.....	2
Features.....	4
Accessories.....	5
Wire Connection.....	6
Unit Installation and Removal.....	10
Front Panel.....	15
Base Panel.....	19
Remote Control.....	14
Touch Screen Operations.....	24
Touch Screen Calibration.....	24
Main Menu.....	25
Radio Operations.....	26
DVD Operations.....	27
Bluetooth Operations.....	32
i-POD Operations.....	38
SD CARD Operations.....	39
USB Operations.....	39
AV IN Operations.....	40
AUX IN Operations.....	40
NAVI Operations.....	41
ATSC Operations.....	45
System Parameters Setup.....	46
Specifications.....	49
Troubleshooting.....	50
Disc Notes.....	52

## **SAFETY INFORMATION**

*PLEASE READ COMPLETELY AND BECOME FAMILIAR WITH THE CONTENTS OF THIS MANUAL BEFORE INSTALLATION AND OPERATION OF THIS UNIT, AND KEEP IT CAREFULLY FOR FUTURE REFERENCE.*

This unit is a class 1 laser product. The laser beam may cause hazardous radiation if exposure to laser system directly. Do not attempt to disassemble the unit personally.

This unit has been designed and manufactured to assure personal safety. Improper use can result in electric shock or fire hazard. The safeguards incorporated in this unit protect you if you observe the following procedures for installation, use and servicing. This unit doesn't contain any parts that can be repaired by the user. If the unit requires maintenance, contact an authorized service center.

### **Warnings**

- Do not expose the product to rain, water or excessive moisture. This could cause electrical shorts, fire or other damage.
- This product is designed to operate with a 12 volt DC, negative ground battery system. Use the proper power supply.
- The monitor is operated automatically. Do not push in or pull out the monitor or try to reverse the monitor manually! Do not attempt to adjust the monitor angle upward or downward manually. It will cause damage to the Monitor Mechanism Structure.
- Do not impact the monitor with a hard object. It may cause permanent damage.
  
- Do ground all equipments and works in order to avoid causing damage to the unit by electrostatic discharges.
- The user who handles this product takes all necessary precautions to avoid ESD (Electro-Static Discharge) failures.
- Do not attempt to install or service your unit by yourself. Installation or servicing of the unit by persons without training and experience in electronic equipment and automotive accessories may be dangerous and could expose you to the risk of electric shock or other hazards.

**Cautions:**

- ❶ To reduce the risk of fire or electric shock, and annoying interference, use only the recommended accessories.
- ❶ While driving, keep the volume level low enough to be aware of road and traffic conditions.
- ❶ Parking in direct sunlight can produce very high temperatures inside your vehicle. Give the interior a chance to cool down before starting playback.
- ❶ Do not use any chemical solvent, cleaning agent or corrosive detergent to clean away dirt on the surface of the TFT monitor screen. It may cause irreversible damage.
- ❶ Small black and shiny dots inside the liquid crystal panel are normal for liquid crystal product.
- ❶ In extremely cold temperatures, the movement of the picture may be slow and the picture may be dark, but this is not a malfunction. The unit will work normally once reach its operating temperature.
- ❶ Do not use and store the unit in dusty, high temperature and high humidity environments.
- ❶ Do not use the unit immediately when you bring it from cold to warm place. Fast growing temperature, may cause moisture condensing which influence the unit for certain time.

**NOTE:**

*This user's manual is only for reference.*

*Modifying rights are reserved.*

*Specifications are subject to change without notice.*

## **FEATURES**

### **Single Din A/V Source Unit w/ 7" Flip-Up TFT-LCD Touch Screen & Bluetooth Connection**

- Motorized TFT-LCD Telescopes Forwards/Backwards w/ Pre-Set Angles
- Detachable Theft Deterrent Front Panel Flips Down for DVD Loading
- Accepts Add-On GPS Navigation Module, NAVIBOX-1
- Accepts Add-On Digital TV Tuner Module, DTV-1
- Car-Spec DVD Transport for Extreme Temperature Exposure
- Playback from DVDR/RW & CDR/RW, Including VCD, MP3, MP4 & DiviX
- Recall Memory for Last DVD Position
- i-Pod Input Control (Requires IP-1C cable)
- Mini-USB Connection for MP3 & MP4 Playback from 4GB Flash Drive
- 4GB SD Card Reader for MP3, MP4, DiviX & Xvid Playback
- 1GB Internal Memory for Background & Screen Saver Images
- 18 FM / 12 AM Station Memory
- 50w x 4 MOSFET Powered Speaker Level Outputs
- Front & Rear Pre-Amp Outputs
- Variable Subwoofer Pre-Amp Output w/ LPF (80, 120, 160Hz)
- A/V Outputs for Multiple Components
- A/V Inputs for Secondary Source
- Front Panel 3.5mm Auxiliary A/V Input
- Reverse Camera Input w/ Trigger
- Custom & Pre-Set EQ Settings
- Audio Staging Controls
- 12/24 Hour Clock
- USA/European Frequency Stepping
- NTSC/PAL Auto Selection
- 480 x 234 Screen Resolution
- 350 NIT Backlight Brightness

### **Bluetooth Features**

- Work with Most Bluetooth V2.0 Enabled Phones
- Noise & Echo Cancellation
- Contacts List Transferred for Easy Access Dialing
- Caller ID Shows Name and Number from Contacts List
- Recent Calls & Talk Time Logs
- A2DP for MP3 Playback

## ACCESSORIES

1

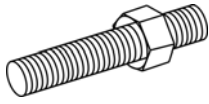

Bolt and Nut M5 x 1

2

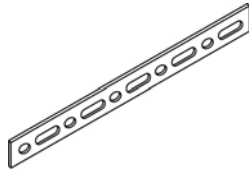

Back Strap x 1

3



M5X5 Screws x 4

4



Remote Control x 1

5

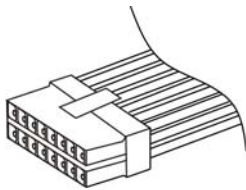

Power Wire x 1

6



Keys x 2

7

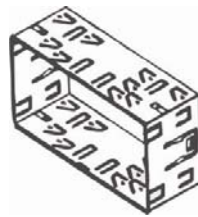

Mounting Sleeve x 1

8

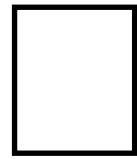

Operational Manual x 1

9



Trim Bezel x 1

10



iPod Cable x 1  
(Optional)

11



Slipcover x 1

12



External Microphone x 1

13

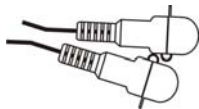

AUX Cable x 1

14



USB Cable x 1

## **WIRE CONNECTION**

### **Cautions:**

- To prevent short circuits, remove the key from the ignition and disconnect the terminal of the battery.
- Make the proper input and output cable connections for each unit.
- Connect the wiring harness cables in the following order: ground wire, battery wire, ignition wire.
- Reconnect the terminal of the battery.
- Do not connect the yellow wire of this product directly to the battery terminal.
- Do remember to connect the red wire of this product to the ACC. of the ignition key switch. Failure to do may result in draining off the battery charge prematurely.
- If the fuse blows, first make sure that the cables have not caused a short circuit, then replace the old fuse with new one with the same rating.
- Do not let unconnected cables or terminals touch the metal on the car or other conductor.
- To prevent short circuits, do not remove the caps from unused terminals or from the ends of the unconnected cables.
- After the monitor unit is installed, check whether the brake lamps, blinkers, wiper, etc. on the vehicle are working properly. If not, please make sure they are properly installed.
- Insulate unconnected wires with vinyl tape or other similar material.



### **Warnings:**

#### **Disconnecting the Battery**

To prevent a short circuit, be sure to turn off the ignition and remove the negative (-) battery cable prior to installation.

#### **Reconnecting the Battery**

When wiring is complete, reconnect the battery negative terminal.

#### **Fuse Replacement**

Never replace any fuse with one of a higher value than the fuse supplied with your unit. Using a higher current rated fuse may cause damage to your unit and/or electrical wiring.

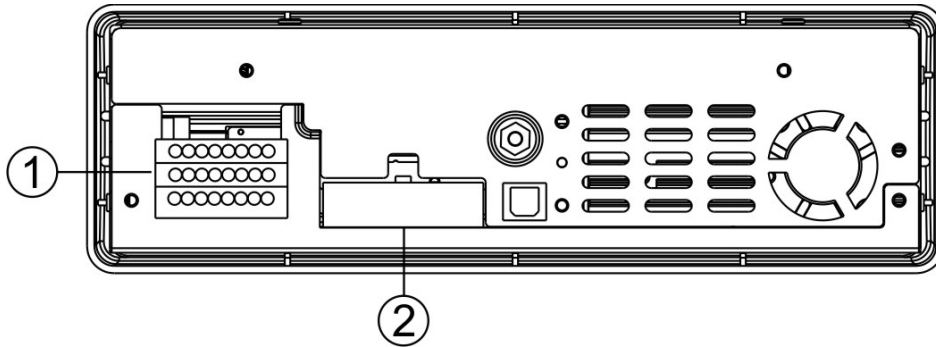

1. RADIO ANTENNA ADAPTER  
IPOD ADAPTER  
ANALOG TV ANTENNA (OPTIONAL)  
NAVI ADAPTER (OPTIONAL)  
AUDIO /VIDEO OUTPUT & INPUT  
DIGITAL TV ADAPTER (OPTIONAL)

2. 15PIN SOCKET

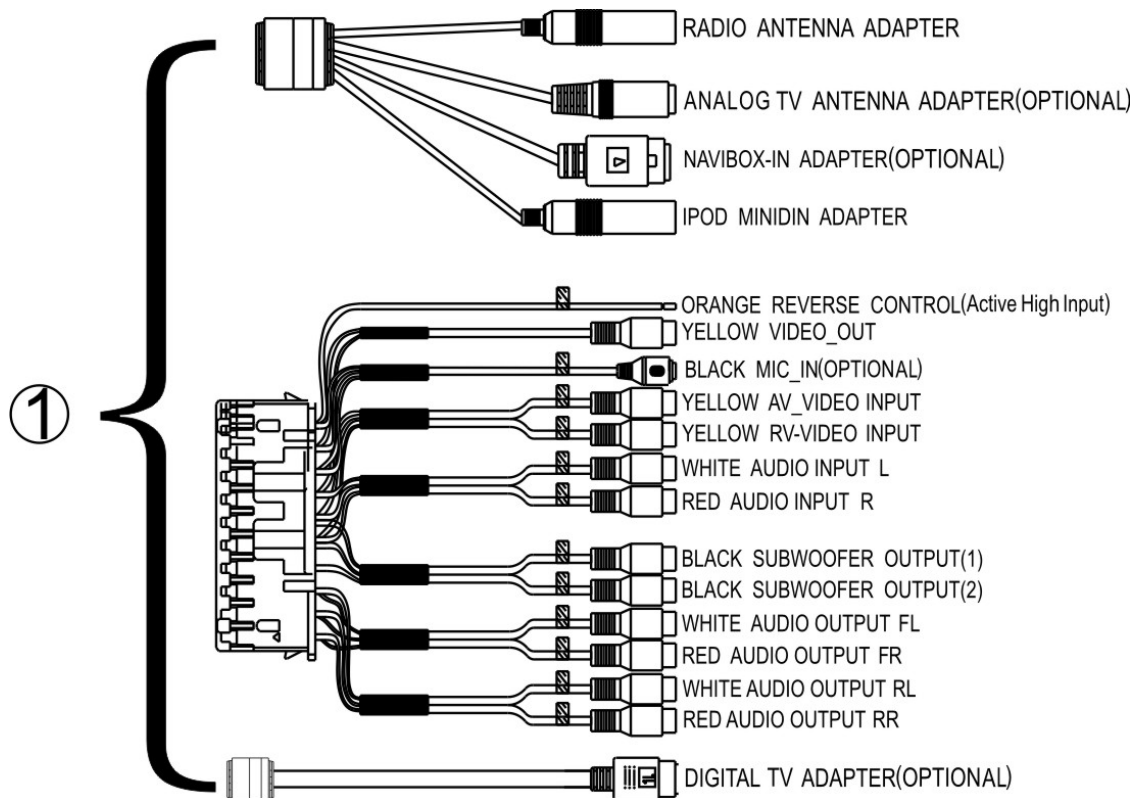



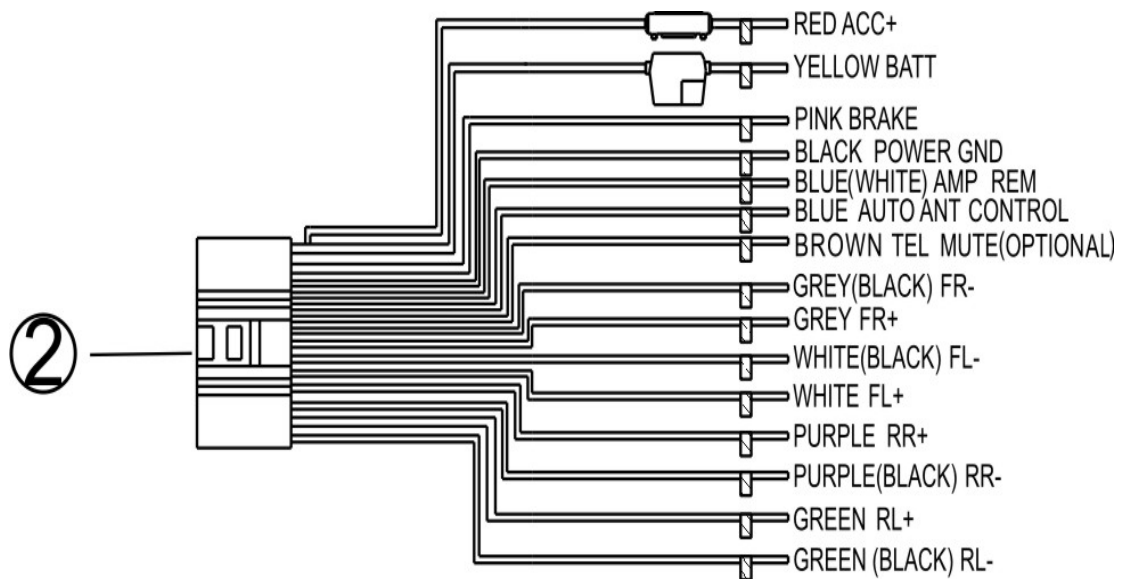

### Brake Control

Connect the brake control wire AUTO\_ANT (see Wiring Diagram). It is necessary to connect the Brake Control wire to the Hand-brake switch of the car. While driving, the TFT monitor will display the alarm picture (see as follows) in order to ensure the safety.

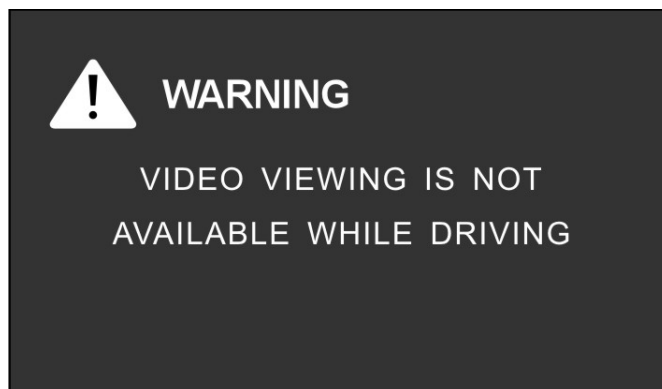

Under the Rear View Mode, the Brake Control function is no effective.

### Telephone Mute Control (Optional)

Connect the telephone mute control wire TEL\_MUTE (see Wiring Diagram). If there is a vehicle call comes in, the sound volume will mute off automatically, and TFT monitor shows: PHONE...; when call finished, the sound volume will recover to former volume, and the words PHONE... disappear.

### Auto Antenna Control

Connect the auto antenna control wire AUTO\_ANT (see Wiring Diagram). The antenna will lift when the unit startup; it will descend when the unit turnoff.

# Wiring Diagram

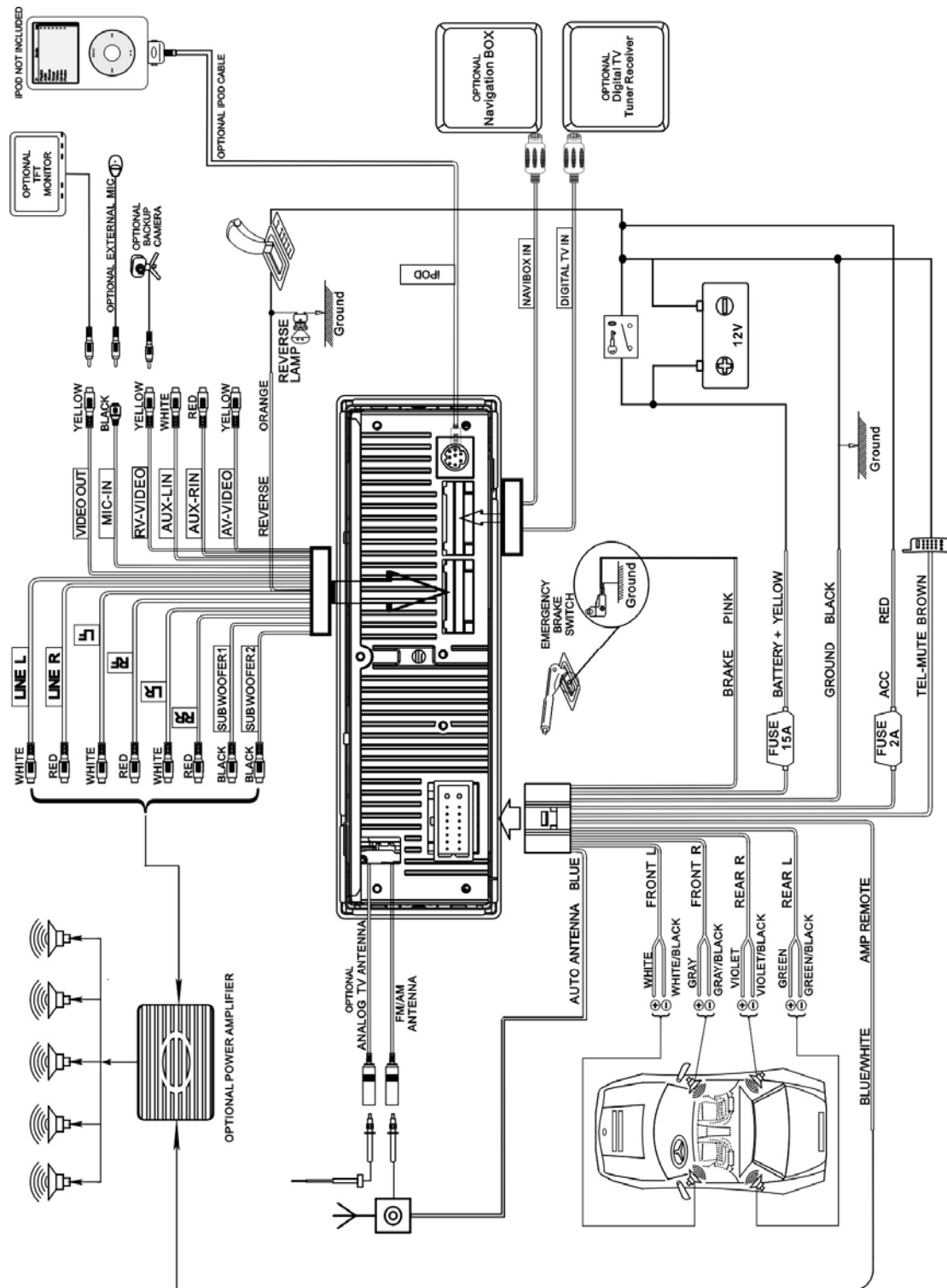

## **UNIT INSTALLATION AND REMOVE**

Please read all of the instructions before beginning the installation. Recommend having your unit installed by a professional installation shop.

### **Tools and Supplies:**

You will need these tools and supplies to install your unit:

- Torx type, flat-head and Philips screwdrivers
- Wire cutters and strippers
- Tools to remove existing radio (screwdriver, socket wrench set or other tools)
- Electrical tape
- Crimping tool
- Volt meter/test light
- Crimp connections
- 16 gauge wire for power connections
- 8 gauge speaker wire



### **Warnings:**

Choose the mounting location where the unit will not interfere with the safe driving conditions.

Install the unit where it does not get in the driver's way and can not injure the passenger if there is a sudden stop, like an emergency stop.

Avoid installing the unit where it would be subject to high temperature, such as from direct sunlight, or from hot air, from the heater, or where it would be subject to dust, dirt or excessive vibration.

### **Cautions:**

Before finally installing the unit, connect the wiring temporarily and make sure it is all connected up properly, the unit and the system work properly.

Use only the parts included with the unit to ensure proper installation. The use of unauthorized parts can cause malfunctions.

Consult with your nearest dealer if installation requires the drilling of holes or other modifications of the vehicle.

If installation angle exceeds 30 degrees from horizontal, the unit might not give its optimum performance.

### Installation Method 1:

1 Install the mounting sleeve into the dashboard.

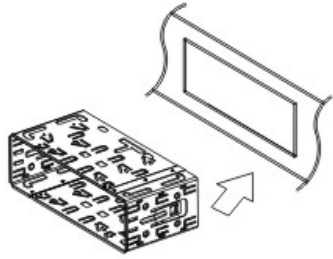

2 Bend the claws into place to secure the sleeve.

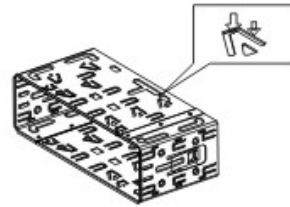

3 Slide the units into the mounting sleeve.

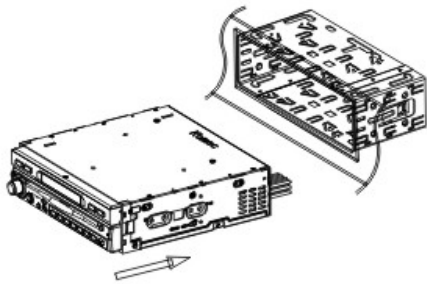

4 Install the trim bezel onto the unit.

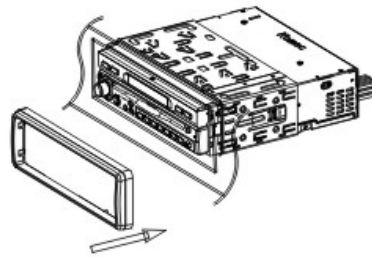

5 Sketch map when installation finished.

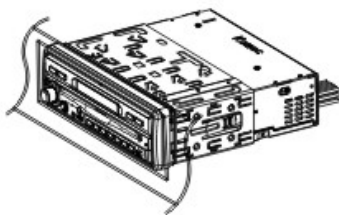

### Removal Method 1:

1 Detach the trim bezel.

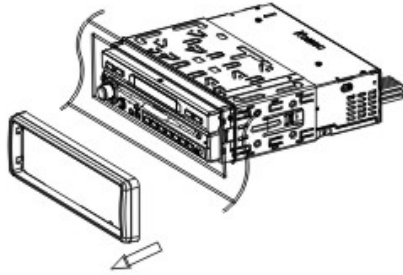

2 Insert the keys into the aperture between the unit and the mounting.

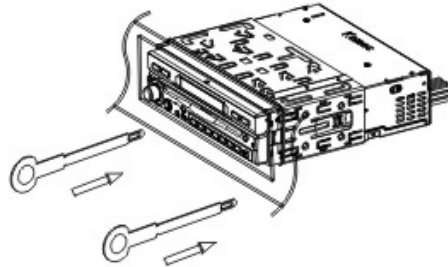

3 Pull the unit out of the mounting sleeve.

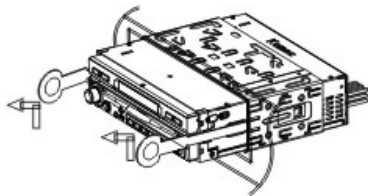

4 Sketch map when removal finished.

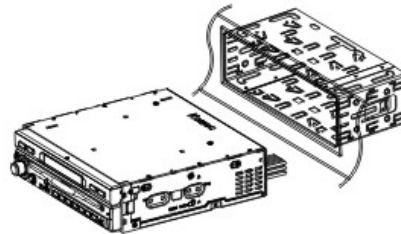

## Installation Method 2:

1 Tighten the bolt onto the rear panel of the unit.

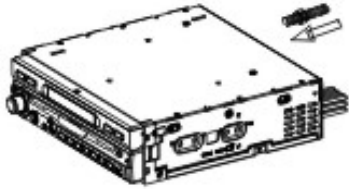

2 Tighten the back strap onto your car inside the dashboard.

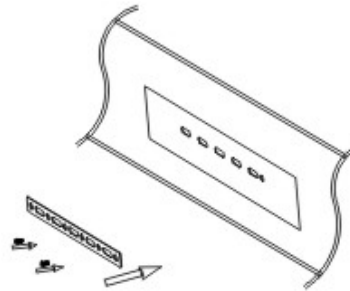

3 Place the unit into the dashboard; make the bolt bar across back strap; and then fix the bolt by the Nut M5.

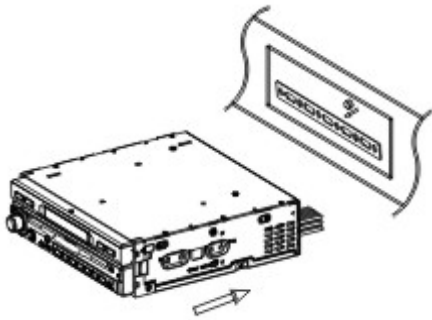

4 Screw the unit on the car on the two sides with M5×5 SCREWS.

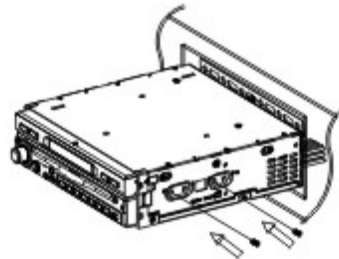

5 Install the trim bezel onto the unit.

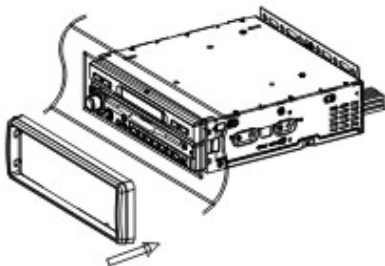

6 Sketch map when installation finished.

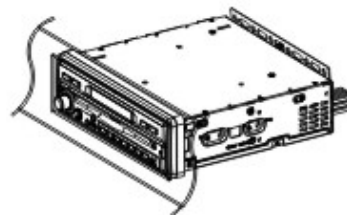

## Removal Method 2:

1 Detach the trim bezel.

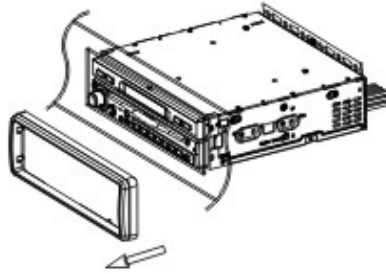

2 Unscrew the unit off the car on the two sides.

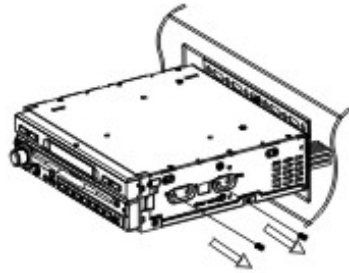

3 Unscrew the Nut M5 screw on the rear side of the unit and pull out the unit. 4 Sketch map when removal finished.

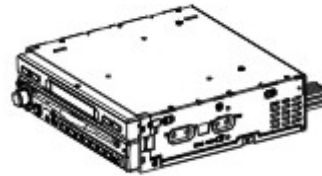
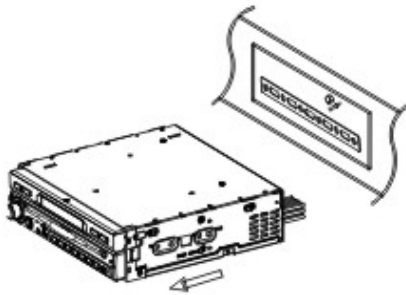

## FRONT PANEL

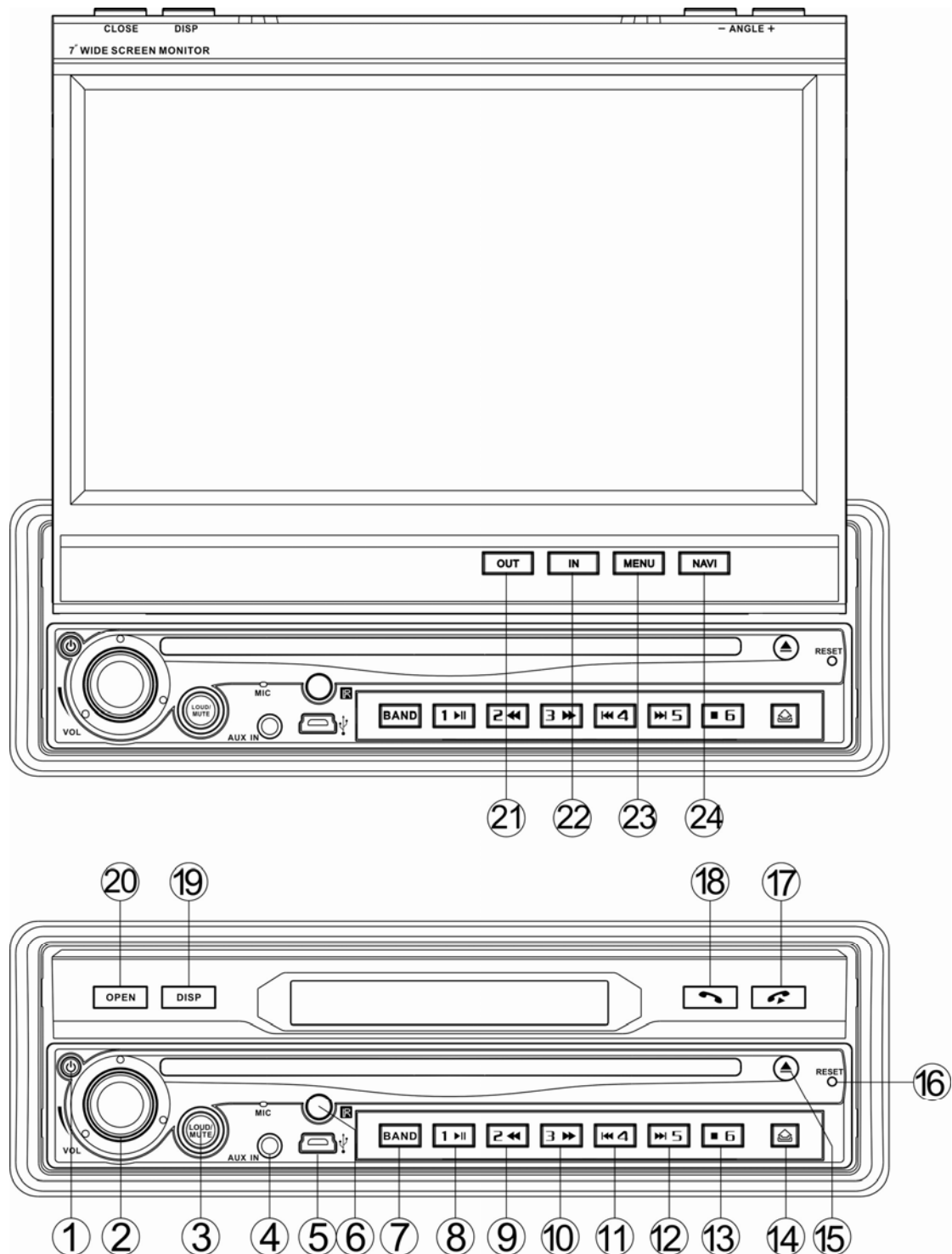

**1. POWER**  
**4. AUX IN**  
**7. BAND**  
**10. F. FWD**  
**13. STOP**  
**16. RESET**  
**19. DISPLAY**  
**22. IN**

**5. MIN USB**  
**8. PLAY / PAUSE**  
**11. PREV**  
**14. REL**  
**23. MENU**

**3. MUTE / LOUD**  
**6. REMOTE**  
**9. F. REV**  
**12. NEXT**  
**15. EJECT**  
**18. ANGLE - / CALL**  
**24. NAVI / SYSTEM**



### 1. Power

When ACC is on, press to turn the unit on; hold on pressing the button to turn off the unit.

When the unit is on, press to switch between different modes.

### 2. Volume / EQ

Rotate the button clockwise / anticlockwise to increase / decrease the volume.

Press vertically to switch the EQ setting as following:

**USER – POP – CLASSIC – ROCK – JAZZ – USER**

### 3. Mute / Loud

Press to switch off the sound; press it again to resume to the previous volume level.

Hold on pressing the button to activate LOUD on / off.

### 4. AUX IN

Connect an external audio device to this jack to listen to the device through your car speakers.

### 5. Mini USB

The unit will be switched to USB Mode automatically when USB connected, and play the songs, pictures, videos in USB.

### 6. Remote

Remote infrared receiver.

### 7. Band

Radio Mode, press to switch the wave band as following:

FM1 – FM2 - FM3 - AM1- AM2 - FM1

### 8. Play/Pause

Press to pause or resume the playback.

### 9. / 10. Fast Reverse / Fast Forward

Press to fast reverse / fast forward at 2x speed. Each press changes speed from 2x to 4x to 8x to 16x to 32x then back to normal play. Press the [PLAY/PAUSE] button to resume to normal playback.

### 11. Previous / 12. Next

Press to go to the next / pervious chapter, track or song.

### 13. Stop

When DVD/VCD/CD disc playback, press the button once to stop the playback, press the [Play/Pause] button to resume the playback again. Press the button twice to stop the playback, press the [Play/Pause] button to start the playback from the beginning of disc.

When MP3 disc playback, press the button to stop the playback, press the [Play/Pause] button to start the playback from the beginning of track.

### Preset Stations

Radio Mode, press the buttons [1, 2, 3, 4, 5, 6] to select a preset station, hold on pressing to store current radio frequency to the preset station.

### 14. REL

Press to take off the panel for burglar-proof purpose, the unit will turnoff automatically and the TFT monitor will retract after 15 seconds automatically.

**15. Eject**

Press to eject / load a disc.

**16. RESET**

Press and hold this button to switch back to all the original factory settings. Keep in mind this will erase all your preset radio stations and any EQ settings you may have made and saved.

**17. ANGLE + / END CALL / 18. ANGLE + / CALL**

Adjust the view angle of the monitor to choose the best displaying effect.

**1- Continual angle adjustment**

Hold on pressing the [ANGLE +] / [ANGLE -] buttons to adjust the angle of TFT monitor upward / downward by continual increasing / decreasing.

**2- Single step angle adjustment**

Press the [ANGLE +] / [ANGLE -] buttons to adjust the angle of TFT monitor upward / downward by singly increasing / decreasing.

Bluetooth Mode, press the [CALL] button to receive a cell phone call, press the [END CALL] button to reject or hang up a call.

**19. DISPLAY**

Press to display the current playback information.

**20. OPEN / CLOSE**

When unit power off, press the [OPEN] button to turn unit on and the monitor will spread out and turn around to the last angle position.

When unit power on, press the [OPEN] button, the monitor will spread out and turn around to the last angle position; Press the [CLOSE] button, the monitor will turn downward and completely retract in.

**21. OUT / 22. IN**

Press the [OUT] / [IN] buttons to move the monitor forward / backward by singly step. There are 2 steps to move the monitor forward / backward totally.

NAVI mode, hold on pressing the [OUT] / [IN] buttons to decrease / increase the brightness of panel.

**23. MENU**

Press to return the main menu.

Hold on pressing the button to enter the SYSTEM SETUP page.

**24. NAVI / SYSTEM**

Press to enter / exit the NAVI mode.

Hold on pressing to enter / exit the System Parameter Setup menu.

**Protection of the TFT Monitor**

During the movement of the TFT monitor, if it is halted by force, then the unit will begin self-protection to prevent from any damage on the motorized mechanical structure.

Press the [OPEN] button or shut down the ACC and then restart, the TFT monitor will act as the follow list to recover; if not, then please consult with an authorized service center.

Halt	Self-protection	Press the [OPEN] button	Shut down the ACC and restart
While extending	Retraction	Extending	Retraction
While retraction	Stop at the halt place and retract after 3 seconds	Extending	Retraction
While turning upward	Turning downward and retraction	Extending	Turning downward and retraction
While turning downward	Turning upward	Turning downward and retraction	Turning downward and retraction

## FRONT PANEL DISPLAY

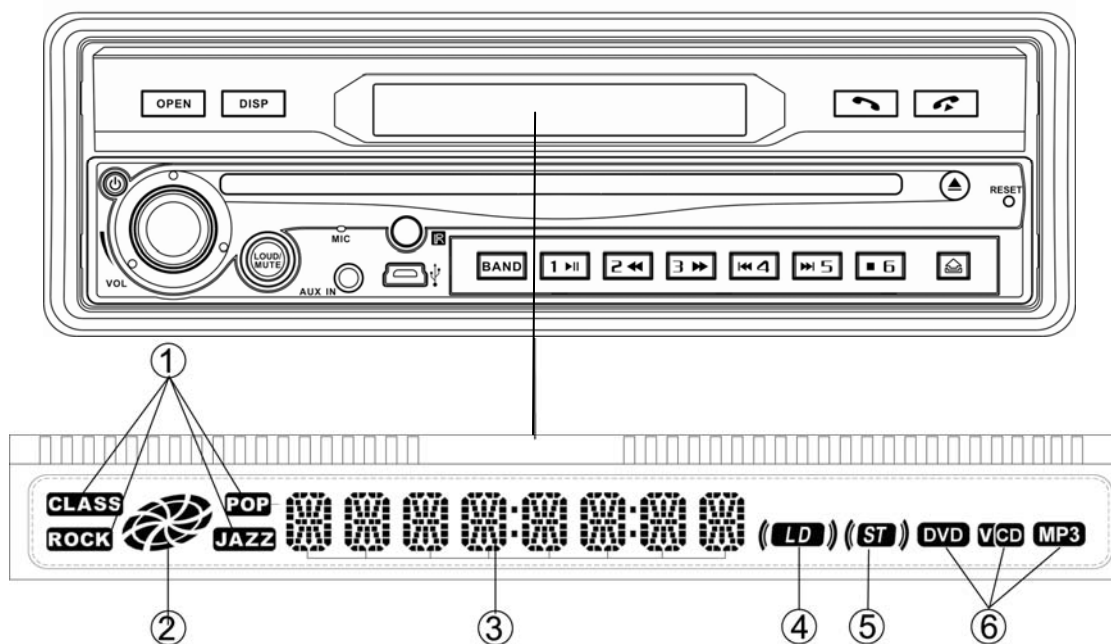

### 1. EQ Indicator:

It turns on to indicate the POP/CLASSIC/JAZZ/ROCK when corresponding setup.

### 2. Disc Icon:

It rotates when playing disc under the DVD Mode.

### 3. Main Display Area:

Display the information such as working mode, characters, playback time & number of track, radio frequency etc.

### 4. LOUD Icon:

It displays when the LOUD on, it disappears when the LOUD off.

### 5. ST Icon:

It displays when the STEREO on, it disappears when the STEREO off.

### 6. Disc Type Indicator:

It turns on to indicate DVD, CD, VCD, and MP3 when playing corresponding discs.

## REMOTE CONTROL

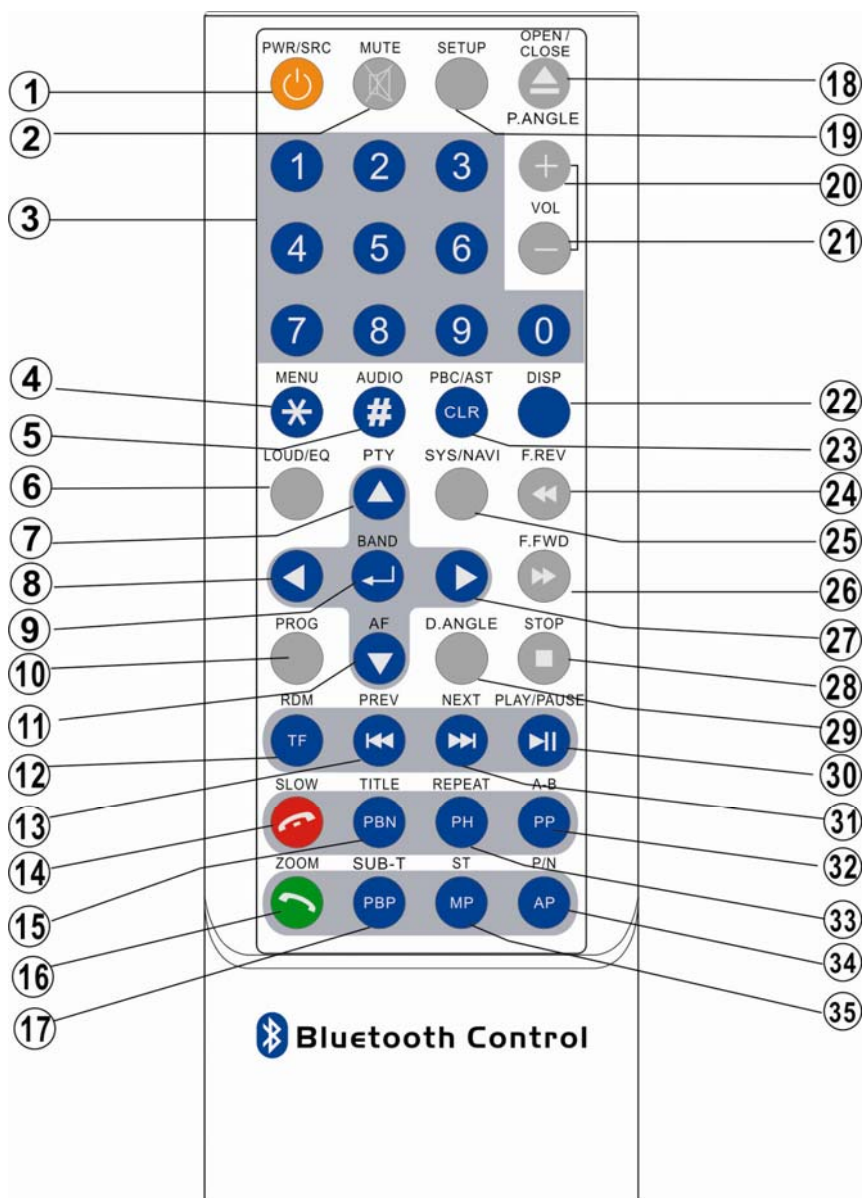

- |                         |                                    |                      |
|-------------------------|------------------------------------|----------------------|
| 1. POWER/SOURCE         | 13. PREVIOUS                       | 25. SYSTEM / NAVI    |
| 2. MUTE                 | 14. SLOW / END CALL                | 26. F.FWD            |
| 3. NUMBER BUTTONS       | 15. TITLE / PBN                    | 27. RIGHT (Seek up)  |
| 4. MENU / *             | 16. ZOOM / CALL                    | 28. STOP             |
| 5. AUDIO / #            | 17. SUBTITLE / PBP                 | 29. D.ANGLE          |
| 6. EQ / LOUD            | 18. OPEN / CLOSE / P.ANGLE / EJECT | 30. PLAY / PAUSE     |
| 7. UP (TUNE UP)/PTY     | 19. SETUP                          | 31. NEXT             |
| 8. LEFT (SEEK DOWN)     | 20. VOLUME+                        | 32. A-B / PHONE PAIR |
| 9. ENTER / BAND         | 21. VOLUME-                        | 33. REPEAT / PHONE   |
| 10. PROGRAM             | 22. DISPLAY                        | 34. PAL / NTSC / AP  |
| 11. DOWN (Tune Down)/AF | 23. PBC / AST / CLEAR              | 35. STEREO / MP      |
| 12. RANDOM / TRANSFER   | 24. F.REV                          |                      |

### **NOTE:**

*This is a universal remote, some functions would be optional.*

### **1. [POWER/SOURCE]**

When ACC is on, press the button to turn the unit on; hold on pressing the button to turn off the unit.

When the unit is on, press to switch between different modes.

### **2. [MUTE]**

Press to switch off the sound; press it again to resume to the previous volume level.

### **3. [NUMBERS 0~9]**

Radio Mode, press the buttons 1~6 to select a preset station, hold on touching to store current radio frequency to the preset station.

DVD Mode, When playing DVD, VCD, CD, MP3, press the buttons 0~9 to input the number of track, press the [BAND] button to confirm.

TV Mode, press the buttons 0~9 to choose the channel and press the [BAND] button to confirm.

Bluetooth Mode, press the buttons 0~9 to input phone numbers.

### **4. [MENU / \*]**

DVD Mode, press to return to the boot menu when playing DVD disc.

Bluetooth Mode, press to input the symbol \*.

### **5. [AUDIO / #]**

DVD Mode, press to change dialogue language when playing DVD disc; Press to select different audio channels when playing VCD, CD disc.

Bluetooth Mode, press to input the symbol #.

### **6. [LOUD/EQ]**

Press to adjust the EQ setting as following:

USER – POP – CLASSIC – ROCK – JAZZ – USER

Hold on pressing to switch between LOUD ON / OFF.

### **7. [^] / 8. [<] / 11. [v] / 27. [>] Direction Key**

DVD Mode and System Parameters Setup, press the [v] / [^] buttons to move the cursor upward / downward to select item. Press the [<] / [>] buttons to move the cursor leftward / rightward to select item.

Radio Mode, press the [<] / [>] buttons to switch the stored stations. Hold on pressing the [<] / [>] buttons to fast seeking the next available channel by decreasing / increasing the tuning frequency; seeking will stop by pressing any button. Press the [v] / [^] buttons to decrease / increase the frequency step by step. Hold on pressing the [v] / [^] buttons to fast seeking by decreasing / increasing the tuning frequency; seeking will stop when loose the button.

TV Mode, hold on pressing the [<] / [>] buttons to fast tuning channel forward the low / high frequency automatically. Press the [^] / [v] buttons to select the stored channel upward / downward.

Bluetooth Mode, press [<] / [>] buttons to switch between dialing page, phonebook, music and setup page.

GPS Mode, press the [V] / [^] buttons to decrease / increase the brightness of the screen.

### **9. [BAND/ENTER]**

DVD Mode, press to confirm the selection.

Radio Mode, press to switch the wave band as following:

FM1 – FM2 - FM3 - AM1- AM2 - FM1

TV Mode, press to switch the TV audio as following:

NTSC – PAL/BG – PAL/I – PAL/DK – NTSC

Hold on pressing to switch the TV system area as following:

USA – CCIR – ITALY – AUS – NZ – USA

Bluetooth Mode, press the button to turn on/off selected item.

### **10. [PROGRAM]**

DVD Mode, press to enter / exit the PROGRAM Function when playing the DVD, VCD, CD disc.

### **12. [RANDOM/TRANSFER]**

DVD Mode, press to turn RANDOM function on / off when playing DVD, VCD, CD disc.

Bluetooth Mode, press to transfer the call between the unit and your cell phone when talking the phone.

### **13. [PREVIOUS] / 31. [NEXT]**

DVD Mode, press to go to the pervious / next chapter, track or song.

### **14. [SLOW/END CALL]**

DVD Mode, press to slow motion playback at 1/2x speed when playing DVD/VCD disc. Each press changes speed from 1/2x to 1/4x to 1/8x to 1/16x then back to normal play.

Bluetooth Mode, press to reject or hang up a call.

### **15. [TITLE/PBN]**

DVD Mode, press to enter the title menu when playing DVD disc.

Bluetooth Mode, press to enter the next page of phone number list in phonebook.

### **16. [ZOOM/CALL]**

DVD Mode, press to zoon the picture display when playing DVD, VCD disc. Each press changes speed from 2x to 3x to 4x to 3x to 2x then back to normal play.

Bluetooth Mode, press to call a number or to receive a cell phone call.

### **17. [SUB-T/PBP]**

DVD Mode, press to change the subtitle language when playing DVD disc.

Bluetooth Mode, press to enter the previous page of phone number list in phonebook.

**18. [OPEN/CLOSE/P.ANGLE/EJECT]**

When unit power off, press the button to turn unit on and the monitor will spread out and turn around to the last angle position.

When unit power on, press the button, the monitor will spread out and turn around to the last angle position; Press the button again, the monitor will turn downward and completely retract in.

Hold on pressing the button to eject / load a disc.

**19. [SETUP]**

DVD Mode, press to enter/ exit the DVD SETUP menu.

**20. [VOL+] / 21. [VOL-]**

Press to increase / decrease the volume.

Hold on pressing the button to keep increasing/decreasing the volume.

**22. [DISPLAY]**

DVD Mode, press to display current playback information.

Bluetooth Mode, press to return to the previous page.

**23. [PBC/AST/CLEAR]**

DVD Mode, press to select the PBC function on / off when playing VCD disc.

Radio Mode, press to review stored stations; Hold on pressing to automatically program the 6 strongest stations available into the presets in the each wave band.

TV Mode, automatically seek the stations available.

Bluetooth Mode, press to cancel or clear the numbers you have input.

**24. [F.REV] / 26. [F.FWD]**

DVD Mode, press to fast reverse / fast forward at 2x speed. Each press changes speed from 2x to 4x to 8x to 16x to 32x then back to normal play. Press the [PLAY/PAUSE] button to resume to normal playback.

**25. [SYSTEM/NAVI]**

Press to enter / exit the System Parameter Setup menu when playing DVD, VCD and CD disc.

Hold on pressing to enter / exit the NAVI Mode.

**28. [STOP]**

DVD Mode, when DVD/VCD/CD disc playback, press the button once to stop the playback, press the [Play/Pause] button to resume the playback again. Press the button twice to stop the playback, press the [Play/Pause] button to start the playback from the beginning of disc. When MP3 disc playback, press the button to stop the playback, press the [Play/Pause] button to start the playback from the beginning of track.

**29. [D.ANGLE]**

DVD Mode, press to select different viewing angles with interactive DVD media during playback.

**30. [PLAY/PAUSE]**

DVD Mode, press to pause or resume the playback.



### 32. [A-B/PHONE PAIR]

DVD Mode, press to set point A, press it again to set point B, then the unit starts to repeat from A to B. When playing DVD, MP3, press it again to stop repeating. When playing VCD, CD, press it again to repeat all tracks.

Bluetooth Mode, press to start phone-pairing.

### 33. [REPEAT/PHONE]

DVD Mode, press to repeat as CHAPTER-TITLE-ALL-REPEAT OFF when DVD playback. Press to repeat as TRACK-ALL-REPEAT OFF when VCD/CD playback. Press to repeat as REPEAT ONE-REPEAT ALL-REPEAT OFF when MP3 playback.

Bluetooth Mode, press to break off or connect cell phone with the unit.

### 34. [P/N/AUDIO PLAYER]

DVD Mode, press to switch the video output (PAL/NTSC) when playing DVD disc.

Bluetooth Mode, press to enter into AUDIO PAIRING.

### 35. [STEREO/MUSIC PAIR]

Radio Mode, press to turn the stereo on / off under.

Bluetooth Mode, press to break off or connect the music storage medium with the unit.

## REPLACING THE BATTERIES

If the remote control has no function or if the operating range reduced, replace the old battery with new one.

1. Pull out the battery holder. Follow the arrow 1 slide it to the right toward the battery while at the same time pull the battery holder away from the remote control.
2. Place the new battery. Place the new lithium battery with the (+) side up.
3. Push the holder back. Using the finger to push in the holder back until the locking sound is heard.

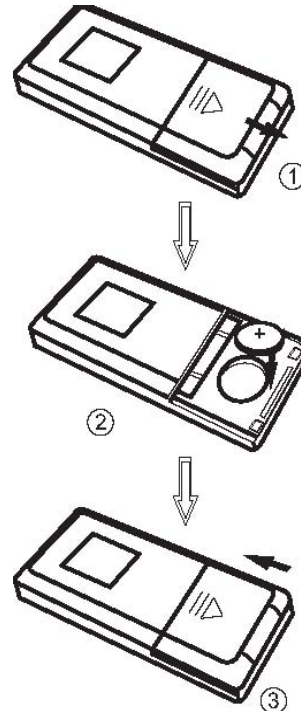



## TOUCH SCREEN OPERATIONS

### TOUCH SCREEN CALIBRATION

When "Power Off", press the buttons 2, [BAND] of remote control to enter the CALIBRATION page:

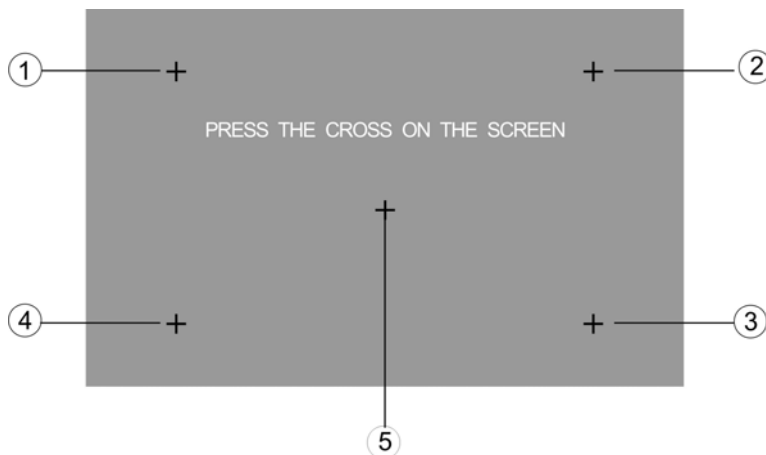

To touch the points from 1 to 5 until the points change to next cross by using a ballpoint pen or pencil. After all 5 points have been touched, the unit has been finished the CALIBRATION. If the calibration is succeeded, the unit would display the following page and then power off automatically.

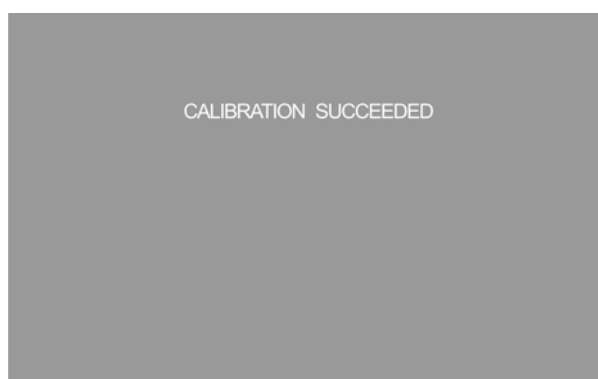

If the calibration is failed, the unit would display the following page and please operate the above processes again.



## MAIN MENU



- 1, Touch to access the **DVD** mode.
- 2, Touch to access the **Radio** mode.
- 3, Touch to access the **NAVI** mode.
- 4, Touch to access the **i-POD** mode.
- 5, Touch to access the **ATSC** mode.
- 6, Touch to access the **SD CARD** mode.
- 7, Touch to access the **Bluetooth** mode.
- 8, Touch to access the 2<sup>nd</sup> page of MAIN MENU.



- 1, Touch to access the **USB** mode.
- 2, Touch to access the **AV IN** mode.
- 3, Touch to access the **SYSTEM PARAMETERS SETUP**.
- 4, Touch to access the **AUX IN** mode.
- 5, Touch to access the 1<sup>st</sup> page of MAIN MENU.
- 6, Touch to access the previous working mode.

## **RADIO OPERATIONS**

Touch the [RADIO] icon to access to Radio Mode.



**1. Current Source Indicator**

Displays the source currently playing, touch to return the main menu.

**2. Mute**

Touch to switch off the sound; touch it again to resume to the previous volume level.

**3. Preset Stations**

Touch to select a preset station, hold on touching to store current radio frequency to the preset station.

**4. BAND**

Touch the icon to switch the FM/AM wave band as following:

FM1 - FM2 - FM3 - AM1- AM2 - FM1

**5. Auto Station Tune**

Touch to automatically program the 6 strongest stations available into the presets in the each wave band; touch any icon to stop the tuning. After tune, the unit will scan through all tunable presets stations and play them for 5 seconds each; touch any icon to stop the playing.

**6. Local**

Touch to set the local on / off. When you are using the local searching function, you can only receive the radio station with strong enough signals and fine state.

**7. / 8. Tune Frequency - Down / Up**

Touch to tune the radio to a lower / higher frequency by one frequency step. Hold on touching for continuous tuning down / up.

**9. Stereo**

Touch to set the stereo on / off.

**10. / 11. Seek Next Station – Down / Up**

Touch to tune to the next strong station at a lower / higher frequency. Touch any icon to stop seeking.

## **DVD PLAYER OPERATIONS**

- 1, Touch the [DVD] icon to access to DVD Mode if disc inside.
- 2, The unit will be switched to DVD Mode automatically when inserting the disc.
- 3, The unit will switch to RADIO Mode automatically if disc ejected.



### **1. Current Source Indicator**

Displays the source currently playing, touch to return the main menu.

### **2. Mute**

Touch to switch off the sound; touch it again to resume to the previous volume level.

### **3. Stop**

When DVD/VCD/CD disc playback, touch the icon once to stop the playback, touch the [Play/Pause] icon to resume the playback again. Touch the icon twice to stop the playback, touch the [Play/Pause] icon to start the playback from the beginning of disc. When MP3 disc playback, touch the icon to stop the playback, touch the [Play/Pause] icon to start the playback from the beginning of track.

### **4. Play/Pause**

Touch to pause or resume the playback.

### **5. / 8. Fast Forward / Fast Reverse**

Touch to fast forward / fast reverse at 2x speed. Each touch changes speed from 2x to 4x to 8x to 16x to 32x then back to normal play. Touch the [PLAY/PAUSE] icon to resume to normal playback.

### **6. Next / 7. Previous**

Touch to go to the next / pervious chapter, track or song.

### **9. Switch**

Touch to access the 2<sup>nd</sup> page of DVD menu.



### 1. Capture Image

Touch to capture the current playing image and store into memory for background or screen saver.

### 3. Display

Touch to display the current playback information on the screen.

### 4. Repeat

Touch to repeat as CHAPTER-TITLE-ALL-REPEAT OFF when DVD playback.

Touch to repeat as TRACK-ALL-REPEAT OFF when VCD/CD playback.

Touch to repeat as REPEAT ONE-REPEAT ALL-REPEAT OFF when MP3 playback.

### 5. Direction Arrows Keyboard

Touch to display the [Direction Arrows Keyboard] on the left side of screen. Touch repeatedly to move the [Direction Arrows Keyboard] icons on the right side or left side of screen.

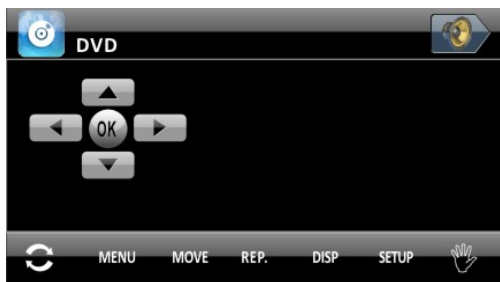

### 6. Menu

Touch to go to the menu of disc when playing DVD disc.

### 7. Switch

Touch to access the 1<sup>st</sup> page of DVD menu.

## 2. Setup

Touch to access the DVD SETUP menu.

Touch the [ < ] / [ > ] icons to switch the main menus as following:

### **SYSTEM – LANGUAGE – VIDEO – SPEAKER – DIGITAL**

Touch the [ ^ ] / [ v ] icons to access the submenus from main menus.

Touch the [ ^ ] icon on the top submenu or [ v ] icon on the bottom of submenu to exit the submenus to main menus.

Touch the [ ^ ] / [ v ] icons to select the submenus as your need.

Touch the [ > ] or [ ENTER ] icons to access the items of submenus.

Touch the [ < ] icon to exit the items of submenus.

Touch the [ v ] / [ ^ ] icons to select the item you want to change.

Touch the [ OK ] icon to confirm the item you have selected and exit to the submenus.

Touch the [ OK ] icon on the submenu EXIT SETUP to exit the DVD SETUP Menu and save all settings.

## **SYSTEM MENU**

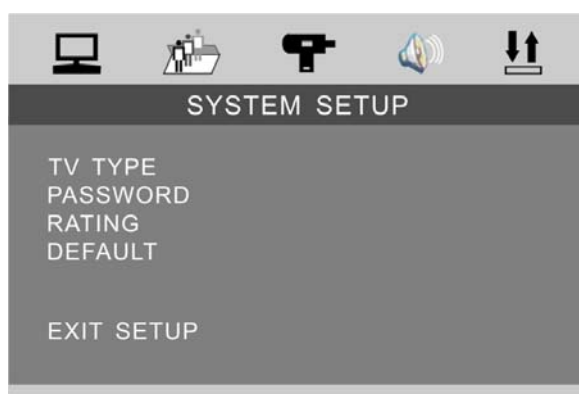

### **TV TYPE**

Following options are available for the TV Display:

4 : 3 PS      4 : 3 LB      16 : 9

### **PASSWORD**

Setup the password for Parental Ratings change. The default password is 0000.

### **RATING**

Following options are available for the Parental Ratings:

1 KID SAFE      2 G      3 PG      4 PG 13  
5 PG - R      6 R      7 NC - 17      8 ADULT

The Parental Ratings could be changed after the correct password input.

### **DEFAULT**

The unit will restore all default settings by selecting this option.

## LANGUAGE SETUP



### OSD LANGUAGE

Following options are available for the OSD LANGUAGE:

ENGLISH	GERMAN	SPANISH	FRENCH	PORTUGUESE
ITALIAN	RUSSIAN	DUTCH	SWEDISH	KOREAN
DANISH	NORWEGIAN	POLISH	HUNGARIAN	

### AUDIO LANGUAGE

Following options are available for the AUDIO LANGUAGE:

ENGLISH	GERMAN	SPANISH	FRENCH	PORTUGUESE
ITALIAN	RUSSIAN	DUTCH	SWEDISH	KOREAN
DANISH	NORWEGIAN	POLISH	HUNGARIAN	

### SUBTITLE LANGUAGE

Following options are available for the SUBTITLE LANGUAGE:

ENGLISH	GERMAN	SPANISH	FRENCH	PORTUGUESE
ITALIAN	RUSSIAN	DUTCH	SWEDISH	KOREAN
DANISH	NORWEGIAN	POLISH	HUNGARIAN	

### MENU LANGUAGE

Following options are available for the MENU LANGUAGE:

ENGLISH	GERMAN	SPANISH	FRENCH	PORTUGUESE
ITALIAN	RUSSIAN	DUTCH	SWEDISH	KOREAN
DANISH	NORWEGIAN	POLISH	HUNGARIAN	

## VIDEO SETUP



### BRIGHTNESS

Following options are available for the BRIGHTNESS:

0 2 4 6 8 10 12

## CONTRAST

Following options are available for the CONTRAST:

0 2 4 6 8 10 12

## HUE

Following options are available for the HUE:

-6 -4 -2 0 +2 +4 +6

## SATURATION

Following options are available for the SATURATION:

0 2 4 6 8 10 12

## SPEAKER SETUP



### DOWNMIX

Following options are available for the DOWNMIX:

LT / RT      STEREO      VSS

### FRONT

Following options are available for the FRONT:

LARGE      SMALL

## DIGITAL SETUP

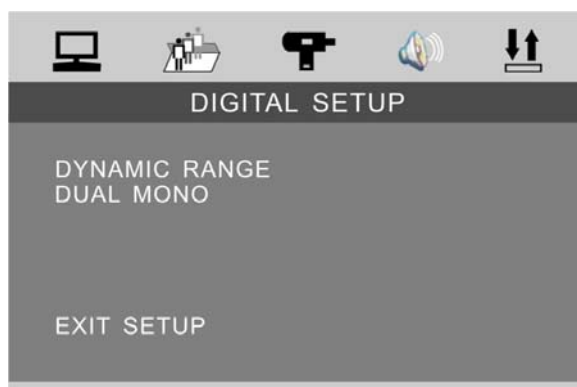

### DYNAMIC RANGE

Following options are available for the DYNAMIC RANGE:

FULL      6 / 8      4 / 8      2 / 8      OFF

### DUAL MONO

Following options are available for the DUAL MONO:

STEREO      MONO L      MONO R      MIX MONO



## **BLUETOOTH OPERATIONS (Optional)**

Touch the [BLUETOOTH] icon to access the Bluetooth Mode:

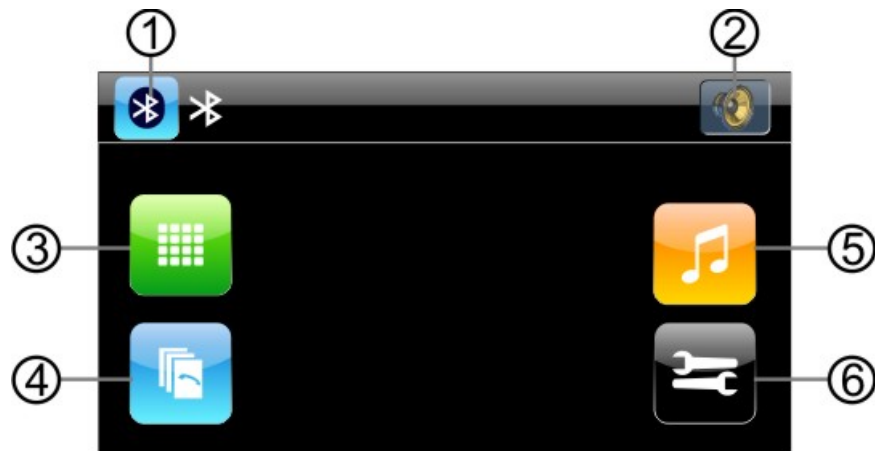

### **1. Current Source Indicator**

Displays the source currently playing, touch to return the main menu.

### **2. Mute**

Touch to switch off the sound; touch it again to resume to the previous volume level.

### **3. Phone Call**

Touch to enter the phone calling.

### **4. Phone Book**

Touch to enter the phone book lookup.

### **5. Audio**

Touch to enter the audio device operation.

### **6. Settings**

Touch to enter the Bluetooth settings.

## **SETTINGS**

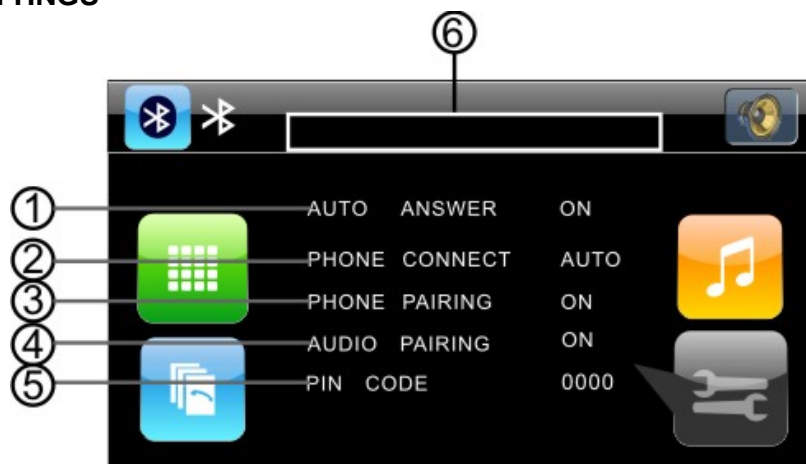

Touch the icon 1~5, when item is changed to yellow color, the item is selected. And touch it again and the item is changed to green color, the operation is active.

### 1. Auto Answer

Touch to select auto / manual answer when call is coming.

### 2. Phone Connect

Touch to select auto / manual phone connect when return back the car.

### 3. Phone Pairing

Touch the icon and the below words on information display:

**PHONE PAIR WAITING**

Then set the phone to pair with unit. When pairing finished, set the phone connect with unit, then you can see the phone name on information display.

Touch the icon again to cancel the pairing and the below words on information display:

**PHONE PAIR FAIL**

### 4. Audio Pairing

Touch the icon and see the below words on information display:

**AUDIO PAIR WAITING**

Then set the audio device to pair with unit. When pairing finished, set the audio device connect with unit, then you can see the audio device name on information display.

Touch the icon again to cancel the pairing and the below words on information display:

**AUDIO PAIR FAIL**

### 5. Pin Code

You can change the PIN code by remote control. Press the [CLR] button of remote control to clear the PIN code, and input the new 4 digitals number, press the [SETUP] button of remote control to save the new code.

### 6. Information Display

#### **NOTE:**

The unit can pair with totally 5 different devices including cell phones and audio players. Use the [PHONE] / [AUDIO PLAYER] buttons of remote control to connect / disconnect the device.

1, When you want to connect another paired cell phone with unit, to press the [PHONE] button of remote control to disconnect the current connecting cell phone; use the another cell phone to connect with the unit without pairing operations.

2, When you disconnected the current connecting cell phone, also you can press the [PHONE] button of remote control to connect the cell phone with the unit again.

3, When you want to connect another paired audio player with unit, to press the [AUDIO PLAYER] button of remote control to disconnect the current connecting audio player; use the another audio player to connect with the unit without pairing operations.

4, When you disconnected the current connecting audio player, also you can press the [AUDIO PLAYER] button of remote control to connect the audio player with the unit again.

## PHONE CALL



### 1. Call

Touch to call a number or receive a cell phone call. Touch to call the last number if no number input.

### 2. Clear

Touch to cancel or clear the numbers you have input.

### 3. End Call

Touch to reject or hang up a call.

### 4. Transfer

When talking the phone, touch to transfer the call between the unit and cell phone.

### 5. Number Keys

Touch the icons to input a phone number.

### 6. Information Display

## CALL OUT

When call out, you will see the below information:

**CALL OUT.\*\*\*\*\***

When talking, you will see the below information:

**TALKING.\*\*\*\*\***

When end the call, you will see the below information:

**END CALL.\*\*\*\*\***

## CALL IN

When call in, you will see the below image:



When talking, you will see the below image:



When end the call, you will see the below image:



## PHONEBOOK



**1. My Phonebook**

The phone numbers are stored in phone.

**2. SIM Phonebook**

The phone numbers are stored in SIM card.

**3. Dialed Call**

The phone numbers are dialed in phone.

**4. Received Call**

The phone numbers are received in phone.

**5. Missed Call**

The phone numbers are missed in phone.

**6. Transfer**

When talking the phone, touch to transfer the call between the unit and cell phone.

**7. Call**

Touch to call a selected number from phonebook or to receive a cell phone call.

**8. End Call**

Touch to reject or hang up a call.

**9. / 10. Previous Page / Next Page**

There are 5 numbers in each page, touch to see the previous / next page.

### Phone Number List

Touch the icon 1~5, when item is changed to yellow color, the item is selected. And touch it again and the item is changed to green color, the operation is active and you will see the below image:

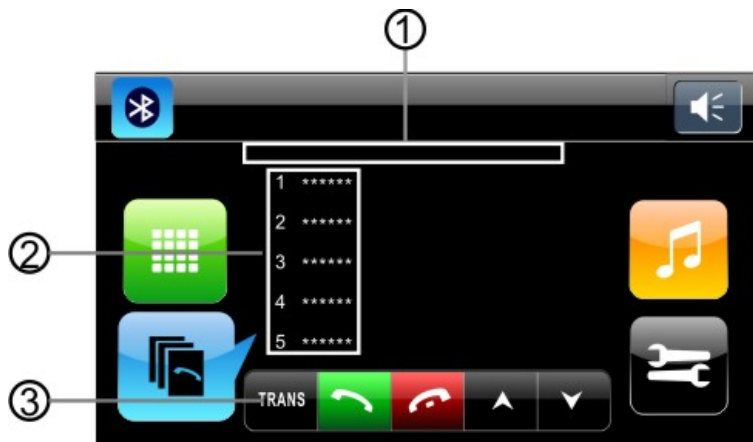

1, Information Display

You will see the phone number of the item in blue color.

2, Phone Number

If this number is stored, you will see the name; if not, you will see the phone number. Touch the icon when item is changed to yellow color, the item is selected.

3. Phonebook

Touch to return the phonebook page.

### AUDIO



1. Previous / 2. Next

Touch to select the previous / next track.

3. Play / Pause

Touch to stop the playback; touch it again to continue playing.

4. Stop

Touch to stop the playback, touch the [Play/Pause] icon to start the playback from the beginning.

## **IPOD OPERATIONS (Optional)**

- 1, Touch the [IPOD] icon to switch IPOD Mode if iPod connected.
- 2, The unit will switch to IPOD Mode automatically if iPod connected.
- 3, The unit will switch to RADIO Mode automatically if iPod disconnected.



### **Music Page**

Under the Music Page, it is not effective for the controller of iPod itself, use the keys of unit to control the operation and all operations are same as DVD Mode.

#### **1. Current Source Indicator**

Displays the source currently playing, touch to return the main menu.

#### **2. Mute**

Touch to switch off the sound; touch it again to resume to the previous volume level.

#### **3. Next / 4. Previous**

Touch to go to the next / pervious chapter, track or song.

#### **5. Play/Pause**

Touch to pause or resume the playback.

#### **6. Video**

Touch to access the video page.



### **Video Page**

Under the Video Page, use the controller of iPod itself to control all operations of iPod including play music, videos and view pictures.

#### **1. Music**

Touch the icon to access the music page.

#### **NOTE:**

*The TV Output in iPod SETUP should be effective, and the pictures & videos could be displayed on the TFT monitor of unit.*

### **SD CARD OPERATIONS**

1. Touch the [SD CARD] icon to access to SD CARD Mode if SD / MMC Card inserted.
2. The unit will switch to SD CARD Mode automatically if SD / MMC Card connected.
3. When SD / MMC Card disconnected, the unit will switch to RADIO Mode automatically if there is no disc in the unit; the unit will switch to DVD Mode automatically if there is a disc in the unit.
4. Under the SD CARD Mode, all operations are same as DVD Mode.

### **USB OPERATIONS**

1. Touch the icon [USB] to access the USB Mode if USB connected.
2. The unit will switch to USB Mode automatically if USB connected.
3. When USB disconnected, the unit will switch to RADIO Mode automatically if there is no disc in the unit; the unit will switch to DVD Mode automatically if there is a disc in the unit.
4. Under the USB Mode, all operations are same as DVD operations.



## **AV IN OPERATIONS**

Touch the icon "AV IN" to enter the AV IN Mode:

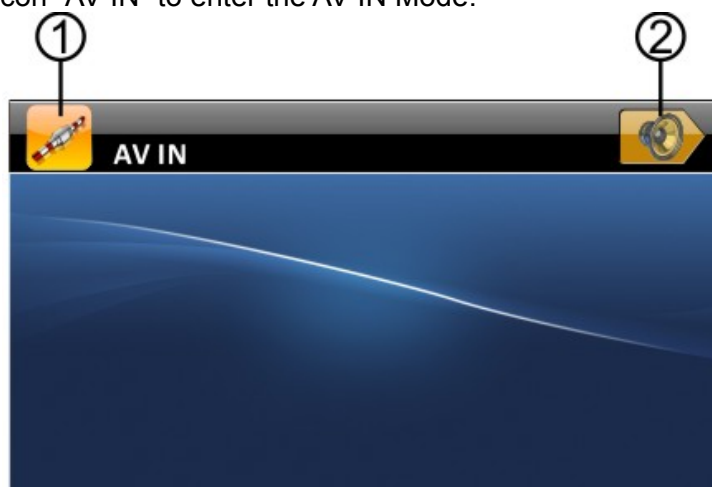

### **1. Current Source Indicator**

Displays the source currently playing, touch to return the main menu.

### **2. Mute**

Touch to switch off the sound; touch it again to resume to the previous volume level.

### **NOTE:**

There are 2 RCA Audio Inputs & 1 RCA Video Input for unit.

## **AUX IN OPERATIONS**

Touch the icon "AUX IN" to enter the AUX IN Mode:



### **1. Current Source Indicator**

Displays the source currently playing, touch to return the main menu.

### **2. Mute**

Touch to switch off the sound; touch it again to resume to the previous volume level.

## ATSC OPERATIONS (Optional)

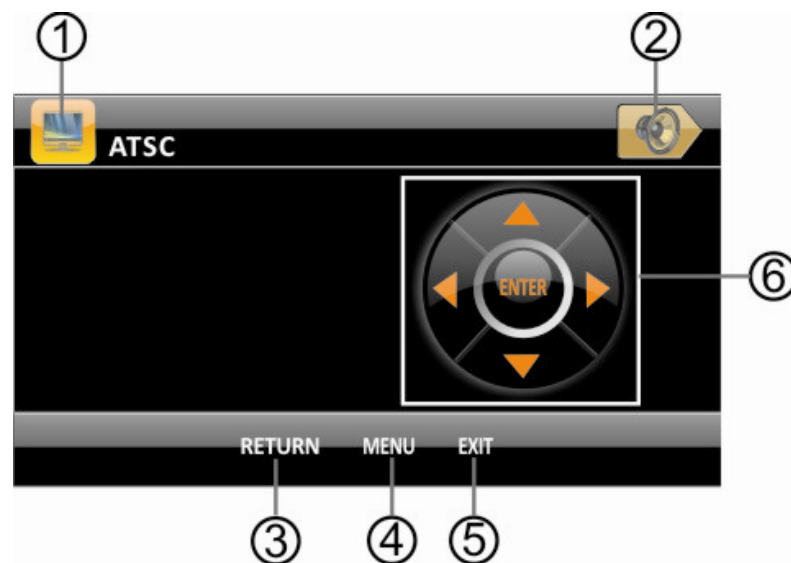

**1. Current Source Indicator**

Displays the source currently playing, touch to return the main menu.

**2. Mute**

Touch to switch off the sound; touch it again to resume to the previous volume level.

**3. Return**

Touch to return submenu to menu.

**4. Menu**

Touch to display the menu.

**5. Exit**

Touch to exit the menu.

**6. Direction Arrows Keyboard**

Touch the arrows icons to select the item, touch the [ENTER] icon to confirm the selection.

**NOTE:**

***Under ATSC mode, please view all operations by ATSC Device DTV-1 User's manual.***

## **NAVI OPERATIONS (Optional)**

### **Touch Screen Calibration**

When 1<sup>st</sup> time to enter NAVI mode, you will see the calibration screen. Please touch the points from 1 to 5 by using a ballpoint pen or pencil.

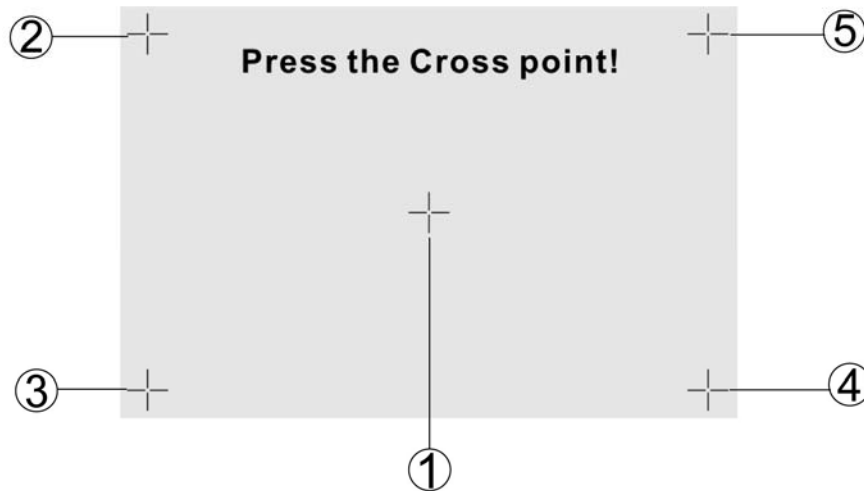

To verify the calibration, please touch the points from 1 to 5 again.

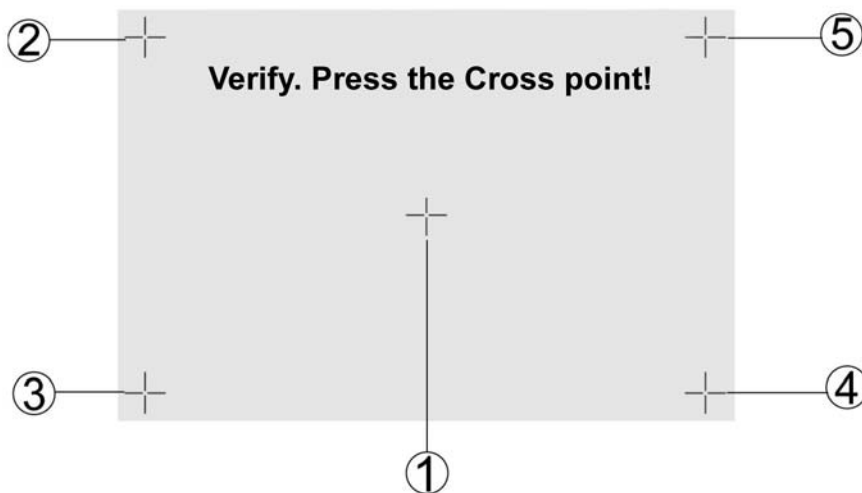

Then the following screen is displayed:

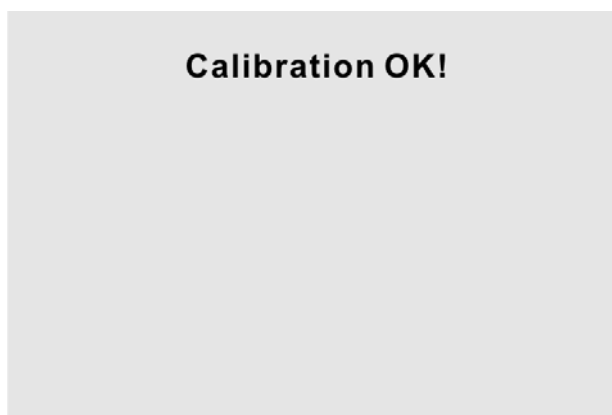

The Touch Screen is restored to their default positions. Touch anywhere of panel to finish the calibration and go to the following screen:

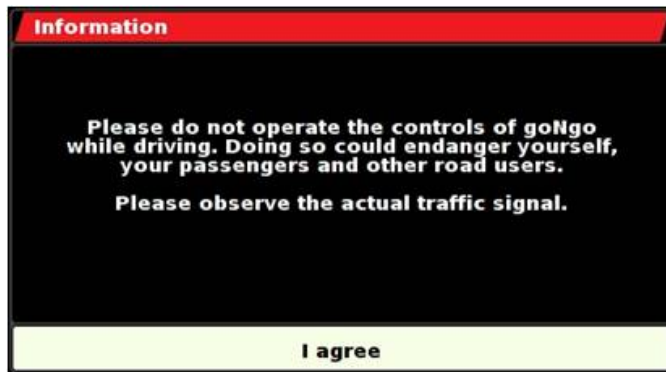

Read information and touch "I agree" button at the bottom of the screen, then enter the NAVI mode.

**NOTE:**

*If change the NAVIbox to connect another unit, please take out the SD card from the NAVIbox and connect with computer, the following screen is displayed on computer:*

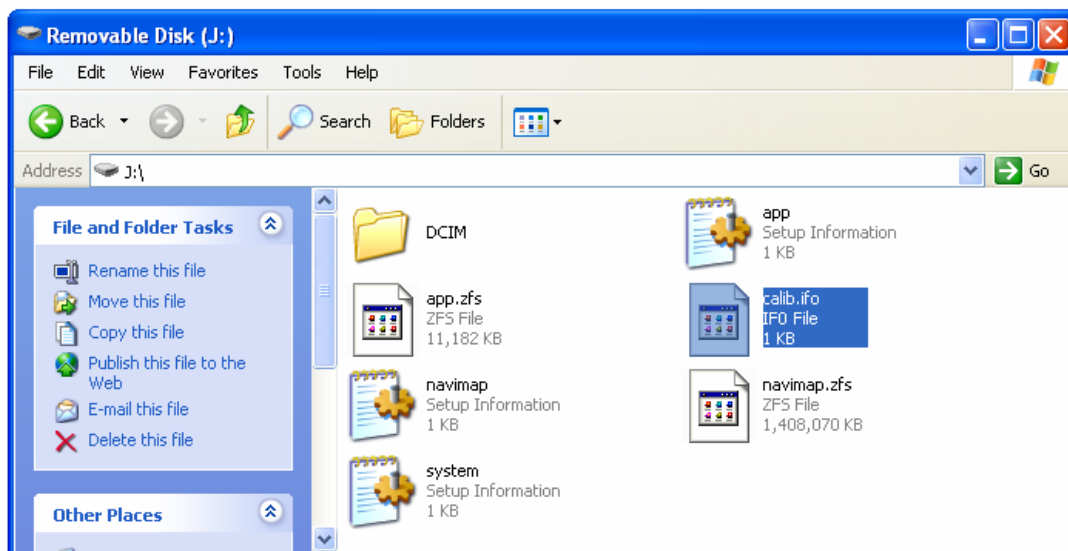

*Delete the file "calib.ifo" only. Insert the SD card into NAVIbox again, and connect the NAVIbox with another unit.*

## Go to NAVI mode

Touch the icon “NAVI” to enter the NAVI Mode if NAVIBOX connected:

Following screen will be displayed:

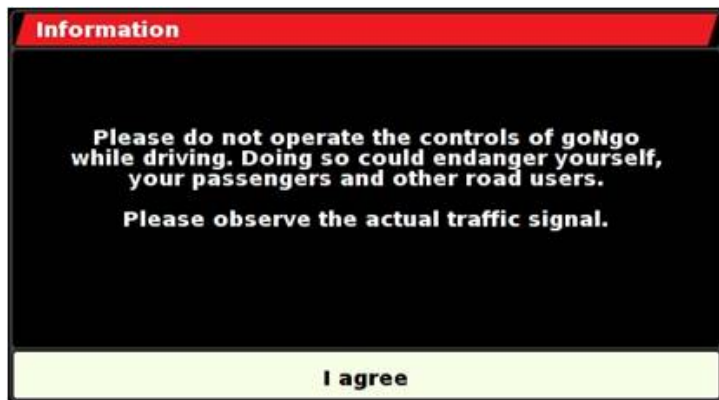

Read information and touch “I agree” button at the bottom of the screen.

Enter the NAVI mode by main menu, the NAVI operations are effective only, all other processes are disable such as Radio, CD etc.

### NOTE:

*Under NAVI mode, please view all operations by Navigation Device NAVIBOX-1 User's manual.*

### Quick Access Key [NAVI]

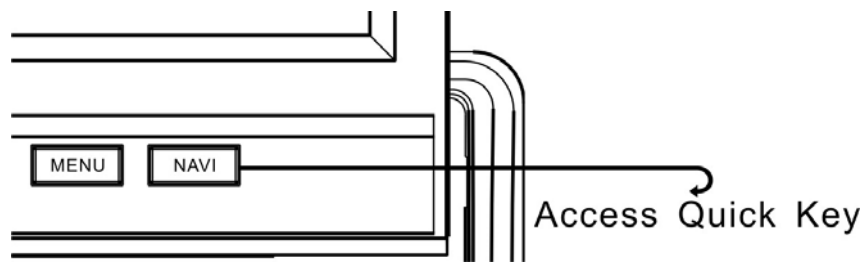

Under any working mode, press the [NAVI] button to switch to NAVI mode; press the [NAVI] button again to return the previous working mode. For example, under Radio mode, press the [NAVI] button to switch to NAVI mode; press the [NAVI] button again to quit the NAVI mode and return back the Radio mode.

Enter the NAVI mode by Quick Access Key, the previous working mode is still working on background. For example, under Radio mode, press the [NAVI] button to switch to NAVI mode, and you can still listen to the radio stations. But when voice of Navigation comes, the radio will be interrupted until voice of Navigation ends.

### No NAVIBOX Connection

Touch the "NAVI" icon to enter the following screen if the NAVIBOX not connected:



#### 1. Current Source Indicator

Displays the source currently playing, touch to return the main menu.

#### 2. Mute

Touch to switch off the sound; touch it again to resume to the previous volume level.

## **SYSTEM PARAMETERS SETUP**

Touch the [SYSTEM] icon to enter the System Parameters Setup.

### **SCREEN SETUP**

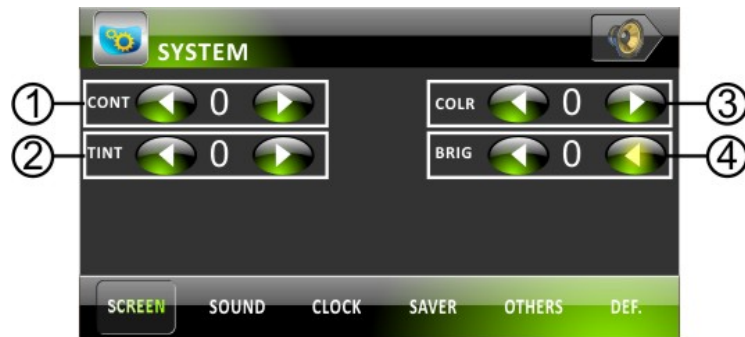

#### **1. Contrast**

Touch [UP] / [DOWN] icons to adjust the CONTRAST parameters (Range: -9 to 9);

#### **2. Tint**

Touch [UP] / [DOWN] icons to adjust the TINT parameters (Range: -9 to 9);

#### **3. Color**

Touch [UP] / [DOWN] icons to adjust the COLOR parameters (Range: -9 to 9);

#### **4. Brightness**

Touch [UP] / [DOWN] icons to adjust the BRIGHTNESS parameters (Range: -9 to 9);

### **SOUND SETUP**

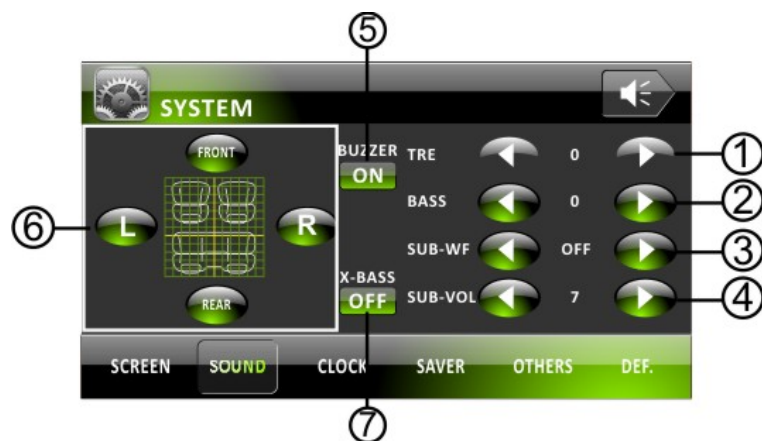

#### **1. Treble**

Touch [UP] / [DOWN] icons to adjust the TREBLE parameters (Range: -9 to 9);

#### **2. Bass**

Touch [UP] / [DOWN] icons to adjust the BASS parameters (Range: -9 to 9);

#### **3. Sub-Woofer Frequency**

Touch [UP] / [DOWN] icons to switch the SUB-WOOFER frequency as following:  
OFF — 80Hz — 120Hz — 160Hz — OFF

#### 4. Sub-Woofer Volume

Touch [UP] / [DOWN] icons to adjust the SUB-WOOFER volume parameter (Range: 0 to 15);

#### 5. Buzzer

Touch to turn Buzzer on or off;

#### 6. Balance / Fader

Touch [LEFT] / [RIGHT] icons to adjust the BALANCE parameters (Range: -9 to 9);

Touch [FRONT] / [REAR] icons to adjust FADER parameters (Range: -9 to 9);

#### 7. X-Bass

Touch to turn X-Bass on or off;

### CLOCK SETUP



#### 1. Hour

Touch [UP] / [DOWN] icons to adjust the HOUR;

#### 2. Minute

Touch [UP] / [DOWN] icons to adjust the MINUTE;

#### 3. Time Display

Displays the time currently.

#### 4. Time Mode

Touch to switch the time mode between 12-Hour and 24-Hour;

### SAVER SETUP





### 1. Source Images List

Touch [UP] / [DOWN] icons to select the image captured from DVD, SD card and USB.

### 2. Screen Saver Images List

Touch [UP] / [DOWN] icons to select the image of screen saver.

### 3. Desktop

Touch to set the selected image of source images list as desktop image.

### 4. Del

Touch to delete the selected image of screen saver images list, or delete the selected image of source images list.

### 5. Add

Touch to add the selected image of source images list as screen saver.

### 6. Screen Saver Time

Touch to adjust the screen saver time as following:  
3MIN - 5MIN - NEVER - 10S - 20S - 30S - 60S - 3MIN

## OTHERS SETUP



### 1. RADIO AREA

Touch [LEFT] / [RIGHT] icons to switch the Radio Area as following:  
USA – JAPAN – ORIT – EUROPE – ASIA – USA

### 2. LOC

Touch [LEFT] / [RIGHT] icons to switch the LOC and DX.

### 3. EQ

Touch [LEFT] / [RIGHT] icons to switch the EQ as following:  
USER – POP – CLASSIC – ROCK – JAZZ – USER

### 4. LOUD

Touch [LEFT] / [RIGHT] icons to turn Loud on or off;

## DEFAULT

The unit will restore all default settings of System Parameters Setup.

## **SPECIFICATIONS**

### **GENERAL**

Supply Voltage	: 14.4V DC (11-16V allowed)
Load Impedance	: 4Ω per channel
Max Power Output	: 50W x 4
Bass 100Hz	: ≥ 10dB
Treble 10KHz	: ≥ 10dB
Dimensions (approx.)	: 180 x 188 x 59 mm (d/w/h)
Mounting (approx.)	: 160 x 178 x 50 mm (d/w/h)

### **FM TUNER**

Frequency Range	: 87.5 – 108 MHz (Europe/Asia) 87.5 – 107.9 MHz (USA)
IF	: 10.7 MHz
Usable Sensitivity	: ≤ 15dBuV
Stereo Separation	: ≥ 26dB (1 KHz)
Frequency Response	: 100-20000Hz

### **AM TUNER**

Frequency Range	: 531 - 1602 KHz (Asia) 522 - 1620 KHz (Europe) 530 - 1710 KHz (USA)
IF	: 450 KHz
Usable Sensitivity	: ≤ 40dBuV

### **TV TUNER (Optional)**

Frequency Range	NTSC : 55.25 MHz~855.25MHz PAL: 48.25 MHz~855.25MHz
-----------------	--

### **DVD PLAYER**

Signal-to-noise Ratio	: ≥ 85dB (1 KHz)
Distortion	: ≤ 0.5%

### **MONITOR**

Resolution	: 480 (w) x 234 (H) (RGB)
Brightness	: 350 cd/m <sup>2</sup>
Contrast	: 250:1

### **NOTE:**

*Specifications and design are subject to modification without notice due to improvement in technology.*

## TROUBLE SHOOTING

If any of problem persists after checking the below list, Please consult your nearest service dealer. Never attempt to disassemble and repair unit personally.

Problem	Cause	Action
<b>GENERAL</b>		
Unit will not turn on (no power)	Yellow wire not connected or incorrect voltage Re wire not connected or incorrect voltage	Check connections for proper voltage(11-16vdc)
	Black wire not connected	Check connection to ground
	ACC Fuse blown or Car battery fuse blown	Install new fuse with correct rating
	Illegal operation	Press the RESET button
Unit has power (but no/low audio output)	Speaker wires not connected	Check connections at speakers
	One or more speaker wires touching each other or touching chassis ground	Insulate all bare speaker wires from each other and chassis ground
	Speakers damaged	Review wiring diagram and check
Poor sound quality or distortion	Speaker power rating not compatible with unit	Connect proper speakers
	Speaker is shorted	Check speaker wire contact
Unit resets itself when engine is off	Incorrect connection between ACC and Positive battery wire	Check wiring and correct
Unit blows fuse	Yellow or red wire touching chassis ground	Check for pinched wire
	Speaker wires touching chassis ground	Check for pinched wire
	Incorrect fuse rating	Use fuse with correct rating
Unit has audio (when in reverse)	Parking brake safety circuit not connected	Check connections at parking brake
	Parking brake not applied	Apply parking brake
Excessive skipping	Unit is not mounted correctly	Check mounting sleeve
	Physical defect in media	Check media for scratches
IR remote does not work	Dead battery	Replace battery
	Battery installed incorrectly	Remove battery and install correctly
<b>TUNER</b>		
Weak station searching	Auto antenna is not fully extended	Connect the auto antenna control cable properly
	Auto antenna not properly connected	Connect the auto antenna control cable properly
	LOCAL function is activated	Turn LOCAL function off

Problem	Cause	Action
<b>TFT MONITOR</b>		
No video display (when in reverse)	Reverse circuit not connected	Check connections at reverse lamp
	Vehicle is not in reverse	Select reverse gear
Front panel will not open/close	Front panel obstructed	Remove the obstruct and press OPEN to resume the monitor open/close sequence
Flashing image or interference appears on screen	DVD is not compatible with current TV system settings Image blurred, distorted, or dark	Change setup to accommodate disc
Prolonged image or improper height/width ratio display	Improper video signal connections	Check wiring and correct
	Improper aspect ratio setup	Use correct aspect ratio setting
Touch screen function disorder if the position is excursion	Under different condition, for example: temperature , humidity, tec.	Do touch screen calibrate
<b>DISC</b>		
Cannot insert disc	Disc already inside unit	Eject current disc and insert new one
DVD does not start playback	Disc is warped or scratched	Use disc in good condition
	Disc is dirty or wet	Clean disc with soft cloth
	Incompatible disc is used	Use compatible disc
	Disc rating exceeds Parental Lock rating limit	Change parental Lock settings to lower restriction
	Disc region code is not compatible with unit	Use disc with proper region code
	Disc is inserted upside down	Insert disc with label side up
Image blurred , distorted, or dark	Disc is illegally copied	Use original disc
No repeat or searching while playing VCD	PBC is on	Turn PBC off
Interruption occurred during MP3 playback	Disc is dirty or scratched	Clean disc or replace new disc
Bad Disc appears on display	Focus error	Press eject or RESET

## DISC NOTES

- Disc formats supported by this player



### Handling and Cleaning

- Dirty, dusty, scratched or warped discs will cause misoperation.
- Do not place stickers or make scratches on discs.
- Do not warp discs.
- A disc should always be kept in its case when not in use to prevent from damage.
- Do not place discs in the following places:
  1. Direct sunlight.
  2. Dirty, dusty and damp areas.
  3. High temperature places.
  4. On the seats or dashboard.

### Disc Cleaning

Use a dry soft cloth to wipe the surface. If the disc is quite dirty, use a soft cloth slightly moist with isopropyl (rubbing) alcohol. Never use solvent such as benzene, thinner or conventional record cleaners which may mar the surface of the disc.

### NOTE:

*A disc may become somewhat scratched (although not enough to make it unusable) depending on your handling it in the condition of the usage environment. These scratches are not an indication of any problem with the player.*

### Repairing New Discs with Rough Spots

A new disc may have rough edges on its inside and outside edges. If a disc with rough edges is used, the proper setting will not be performed and the player will not play the disc. Therefore, remove the rough edges in advance by using a ballpoint pen or pencil. To remove the rough edges, press the side of the pen or pencil against the inside and outside edges of the disc.

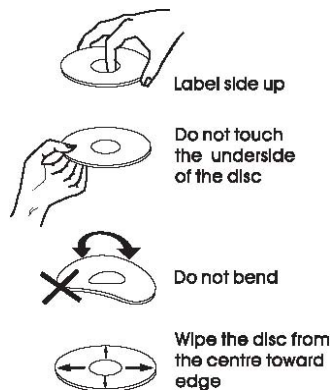
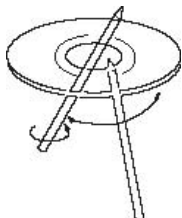

\* *Manufactured under license from Dolby Laboratories.*

\* *“Dolby” and the double-D symbol are trademarks of Dolby Laboratories.*