



AIA1803-200-04

EtherHighway™ Industrial Ethernet NetBridge™

User's Manual



Version 1.0



IMPORTANT SAFETY INFORMATION

1. Please read all instructions before installing and operating AIA1803-200-04 and keep all instructions for later reference.
2. Please follow all performance and safety requirements for each installation, including any applicable laws, regulations, codes and standards.
3. Do follow all the warnings and instructions marked on the product.
4. **AIA1803-200-04 is NOT field serviceable and should not be opened under any circumstance.**
5. Aboundi is not responsible or liable for indirect or consequential damage resulting from the use or application of this product.



Copyright © 2011 by Aboundi Inc. All rights reserved.

No part of this documentation may be reproduced in any form or by any means or used to make any derivative work (such as translation, transformation, or adaptation) without written permission from the copyright owner.

All the other trademarks and registered trademarks are the property of their respective owners.

Statement of Conditions

The content described in this manual may be improved or changed at any time and it is subject to be changed without notice.

Manufacturer assumes no responsibility for errors contained herein or for direct, indirect, special, incidental or consequential damages with the furnishing, performance, or use of this manual or equipment supplied with it, even if manufacturer or its suppliers have been advised of the possibility of such damages.

Electronic Emission Notices

This device complies with Part 15 of the FCC Rules. Operation is subject to the following two conditions:

- (1) This device may not cause harmful interference.
- (2) This device will accept any interference received, including interference that may cause undesired operation.

Audience

The information in this manual is composed for technicians, engineers and network administrators who are installing and maintaining a control system that includes the AIA1803-200-04 NetBridges. You should have a basic knowledge of:

- (1) Microsoft Windows OS
- (2) Ethernet Networks Installation and Maintenance

Support

- (1) Phone: 1-603-889-8188
- (2) Fax: 1-603-889-8181
- (3) Email: technicalsupport@aboundi.com
- (4) Web: http://www.aboundi.com/Support/Technical_Support.html

Please contact your local Aboundi representative if you need an on-site support.



Table of Content

1.	Introduction	5
1.1.	Features	5
1.2.	Product Package.....	6
1.3.	EtherHighway™ Network Examples.....	6
2.	Install AIA1803-200-04.....	8
2.1.	LED	8
2.2.	Communication Interfaces	9
2.3.	Din Rail Mounting	10
2.4.	Make a secured Ethernet cable (optional).....	11
2.5.	Connect the Ethernet RJ45 Ports	12
2.6.	Connect the Signal and Power Wires.....	12
2.7.	Inspect The Connectivity	14
3.	Install Ultra NetBridge™ Utility.....	16
3.1.	System Requirement	16
3.2.	Software Installation	16
4.	Web Configuration.....	24
4.1.	Start-up and Log in	24
4.2.	Connection Info	25
4.3.	Configuration.....	26
4.3.1.	Security Page	27
4.3.2.	Network Page	28
4.4.	Change Password.....	29
4.5.	Firmware Upgrade	30
4.6.	Factory Reset.....	31
4.7.	Reboot	32
5.	Default Settings	32

1. Introduction



The traditional Ethernet network cabling for the industrial automation I/O device network requires the deployment of new CAT5 wiring in addition to the legacy I/O process and control infrastructure. This addition of another paralleled wiring infrastructure at the I/O network level increases the Total Cost of Ownership (TCO) and ongoing operational maintenance expenditures. Aboundi's patent pending AIA1803-200 series of EtherHighway™ Industrial Ethernet NetBridge™ allows a Plug-and-Play simplicity utilizing the existing robust floor DC power electrical wiring as means of providing the network service. The Aboundi solution dramatically reduces the Total Cost of Operation (TCO) with its product line installation flexibility.

The robust AIA1803-200 NetBridge™ enclosure is designed to withstand the harsh industrial operating environments.

1.1. Features

- EtherHighway™ capability layer the Ethernet communication over the power wires and thus eliminates need for a separate communication wiring
- Compatible with all Ethernet ready I/O modules
- Simple Plug-and-Play installation
- 168-bit Tri-DES encryption for secure data transmission
- Robust housing
- Supports Industrial operating temperature

- DIN-Rail ready mounting installation
- Ident-and-Connect™ feature allows ease of network setup and monitoring
- Web configurable
- Up to 300 meters of operational distance
- Compliance with IEEE802.3u 100BASE-TX

1.2. Product Package

Before starting installation, please make sure the AIA1803-200-04 package includes the following five items:

- 1) Quick Installation Guide
- 2) AIA1803-200-04 unit
- 3) Female type 4-PIN Terminal Block
- 4) CD-ROM (containing Ultra NetBridge™ Utility for Windows and User's Manual).

If anything from the above items is missing, please contact your vendor.

1.3. EtherHighway™ Network Examples

Example 1 – EtherHighway™ Linear Ethernet Network

AIA1803-200-04 enables to utilize any twisted pair cables to establish the EtherNet/IP networks on the automation control system. With the EtherHighway™ capability, the deployment won't need additional Ethernet switches for the device level connections. The maximum number of connected AIA1803-200-04 can up to 32 in a physical wiring. The graphic below shows an example of a linear network.

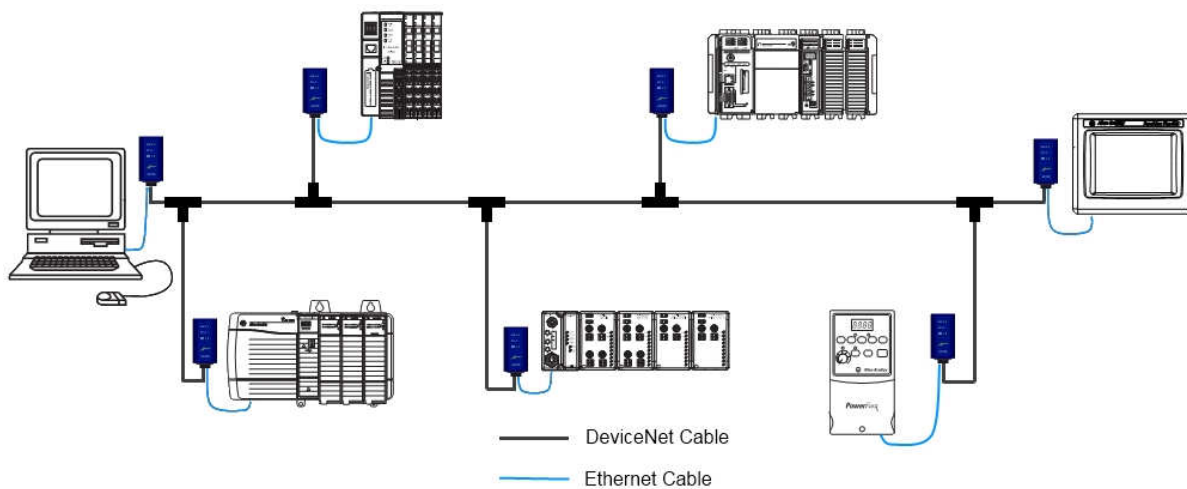

Fig. 1.3.1 EtherHighway™ Linear Network Example

Example 2 – EtherHighway™ RGV Ethernet Network

The AIA1803-200-04 enables the efficient networking deployment on the power track in the factory. It provides a reliable high speed Ethernet connection to enable networking for the industrial PLC control, HMI, industrial computer, IP cameras, video servers, and other Ethernet interfaced I/O equipments through the flexible power rail across all areas.

The AIA1803-200-04 NetBridge™ makes the warehouse automation, remote control industrial Ethernet easier and cost effectively with the TrolleyConnect™ technology. In a complex environment, flexible power tracks can supply both electrical power and high bandwidth network data. This innovative method can apply to many applications by dramatically increased network coverage and scale.

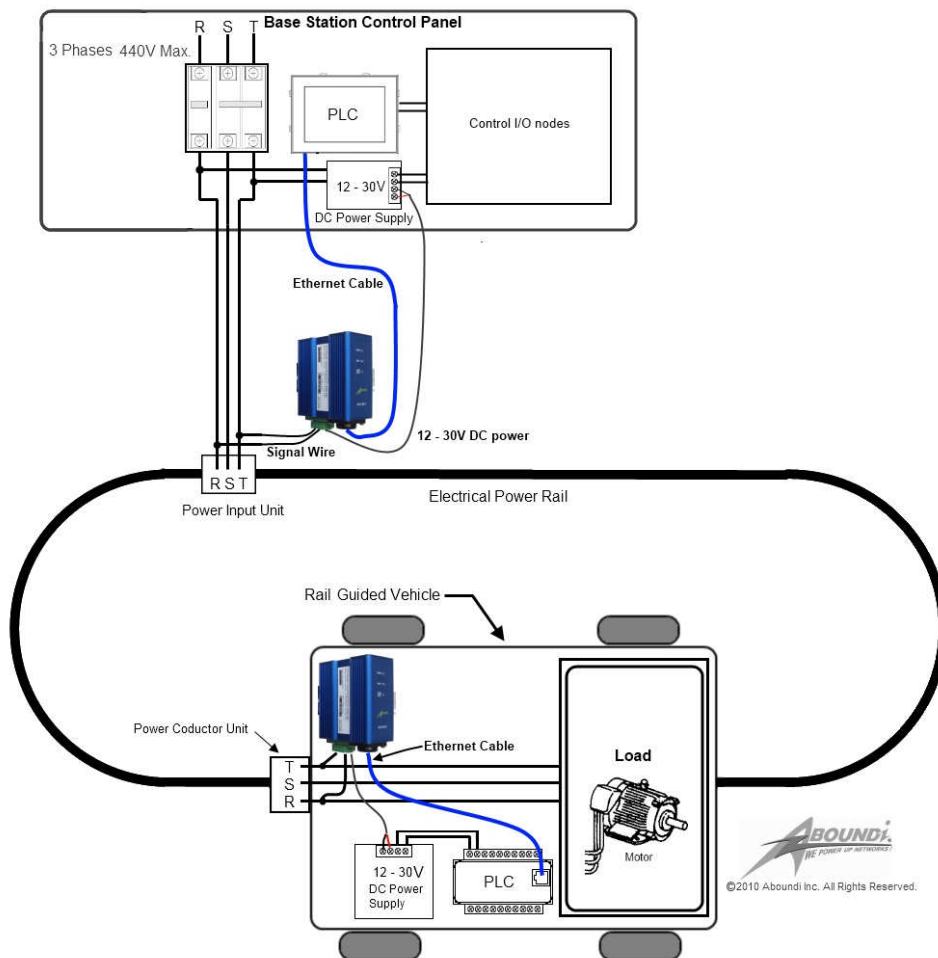

Fig. 1.3.2 EtherHighway™ RGV Network Example

2. Install AIA1803-200-04

2.1. LED

The following figure shows the AIA1803-200-04 LED indicator.



Front Panel

LED:

- Power LED (PWR) :
Green On: Power On
 Off: Power Off
- Application Bandwidth Status LED (NET) :
Blue (Best) On : Link speed over 12 Mbps
Purple (Good) On : Link speed between 6-12 Mbps
Amber (Poor) On : Link speed under 6 Mbps
 Blink : Activity
- Ethernet Ports (LNK/ACT) :
Green On : Link
 Blink : Activity

2.2. Communication Interfaces

The following figure shows the communication interfaces.



Terminal Strip for Power and Communication

1 2 3 4	PIN	Definition
	1	24Vdc+
	2	24Vdc -
	3	Data
	4	Data

Terminal Definition

2.3. Din Rail Mounting

Follow the steps below to mount AIA1803-200-04 on a DIN rail.

1. Determine a proper DIN rail. This product's grounded through the DIN rail to the chassis ground. Please make sure the material of the DIN rail to mount is good conductor to avoid improper or intermittent grounding.
2. Holding the AIA1803-200-04 body and hook the latch over the DIN rail bottom.

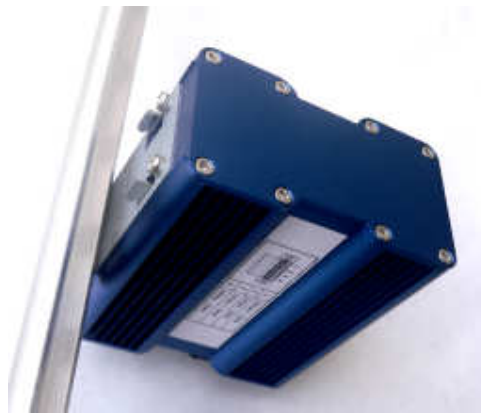

3. List the unit and push the unit to lock on the latch.

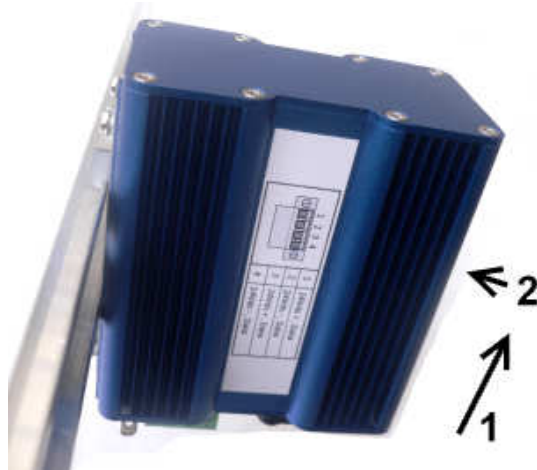

Figure 2.3.1 - AIA1801-200-04 on DIN Rail

2.4. Make a secured Ethernet cable (optional)

Dismantle the secured Ethernet RJ45 connector cover. You can find it in the package.



Inset the Ethernet cable through the cover parts then make a RJ-45 connector.



Tighten the parts and cable then screw on the cover parts.



2.5. Connect the Ethernet RJ45 Ports

Follow the steps below to connect the Ethernet RJ45 port on the AIA1803-200-04 unit.

1. Locate the Ethernet RJ45 port on the bottom of the unit. Connect one end of an Ethernet cable with RJ45 jack to the Ethernet port on the unit.



Figure 2.4.2 – Ethernet Cable on AIA1803-200-04 RJ45 port

2. Connect the other end of the Ethernet cable to the Ethernet port on the I/O module or the device with Ethernet interface.

2.6. Connect the Signal and Power Wires

1. Locate the terminal strip on the bottom of the unit and unplug it.



2. Insert the signal wires into the terminal strip and screw it tight.

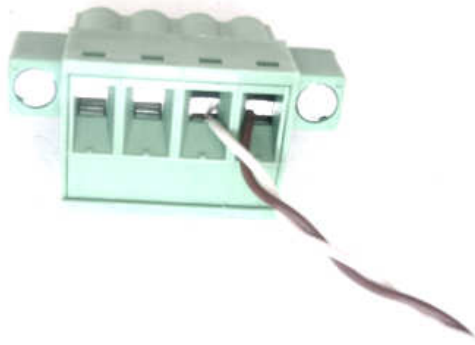

3. Insert the power wires into the terminal strip and screw it tight.

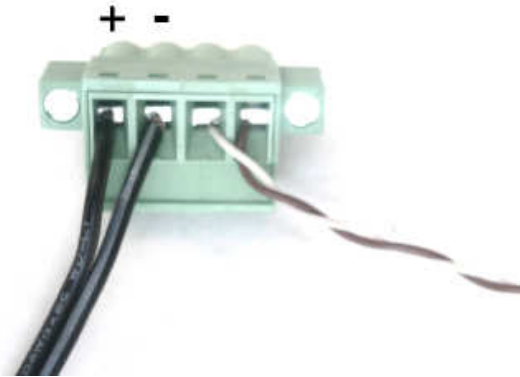

4. Plug the terminal block into the socket and screw it on.



- Repeat step 1 to 5 to connect all the Ethernet devices on a EtherHighway™ network. See the following drawings for examples.

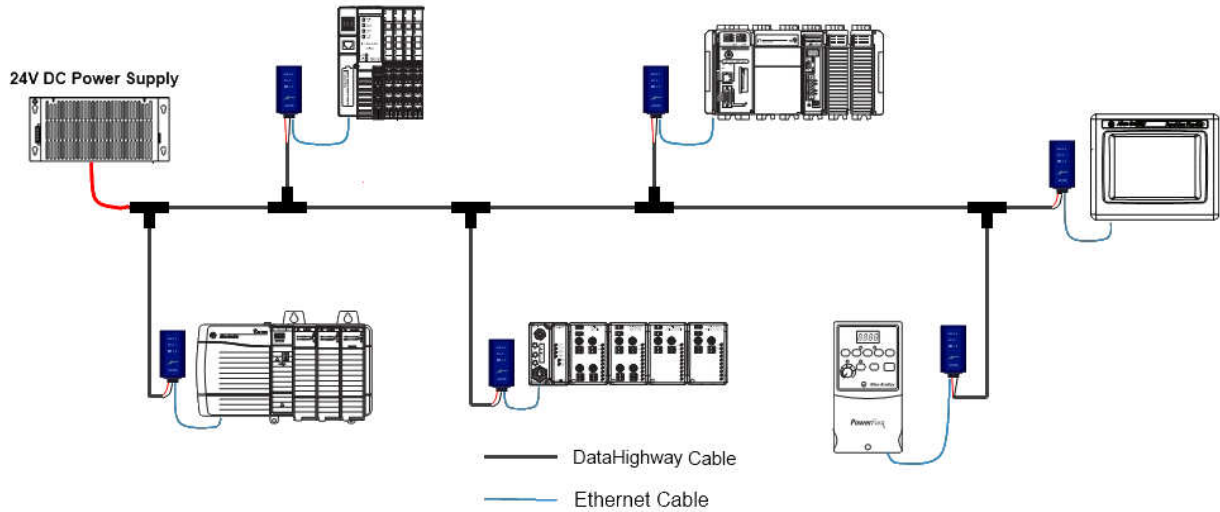

Figure 2.6.1 – DataHighway Cable Connection

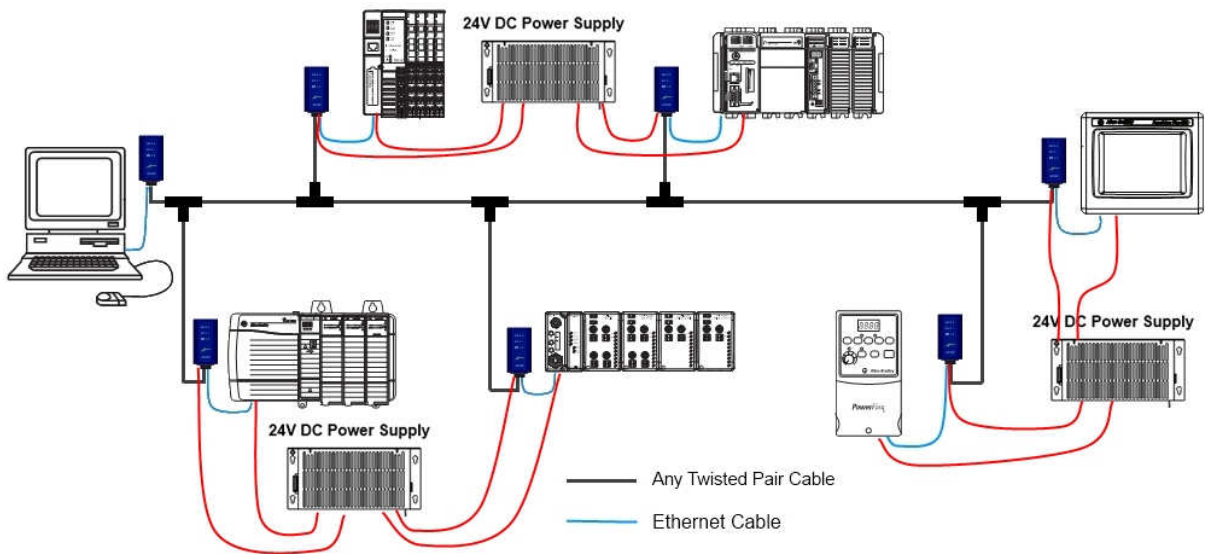

Figure 2.6.2 – Any Twisted Pair Cable Connection

2.7. Inspect The Connectivity

Follow the steps below to verify the connection on the cable is established and ready to go.

- Power on the 24V DC power supply for the device network and all connected

AIA1803-200-04 units should be powered on. The LED indicator should be also turned on.

2. Please examine the LED indicator and check the application bandwidth status LED. If the color is blue or purple, the quality of connection is good. See the figure 2.5 for the LED definition.



Front Panel

LED:

- Power LED (PWR) :
Green On: Power On
 Off: Power Off
- Application Bandwidth Status LED (NET) :
Blue (Best) On : Link speed over 12 Mbps
Purple (Good) On : Link speed between 6-12 Mbps
Amber (Poor) On : Link speed under 6 Mbps
 Blink : Activity
- Ethernet Ports (LNK/ACT) :
Green On : Link
 Blink : Activity

Figure 2.6 – LED Indication Definition

3. At this point, the essential deployment is completed. For some advanced configuration, you may want to customize these AIA1803-200 units by using the Ultra NetBridge™ Utility or via web configuration described by the next two chapters.

3. Install Ultra NetBridge™ Utility

If you need to do advance settings for AIA1801-200, please follow the steps below to install the Ultra NetBridge™ Utility.

3.1. System Requirement

Before installing Ultra NetBridge™ Utility, make sure the PC meets these requirements for hardware installation:

1. Microsoft Windows XP, Vista or Windows 7
2. Pentium®1.6 GHz processor, equivalent or higher
3. One free Ethernet port connecting to EtherHighway™ Series Ethernet NetBridge™
4. 30Mbyte free disk space

3.2. Software Installation

Before the installation, please close the application (if an older version is running) and uninstall it

To install the application just run the setup executable program **utility-setup.exe** in the Product CD-ROM, and follow the steps of the installation wizard. To start the Ultra NetBridge™ Utility installation, press “**Next**”:

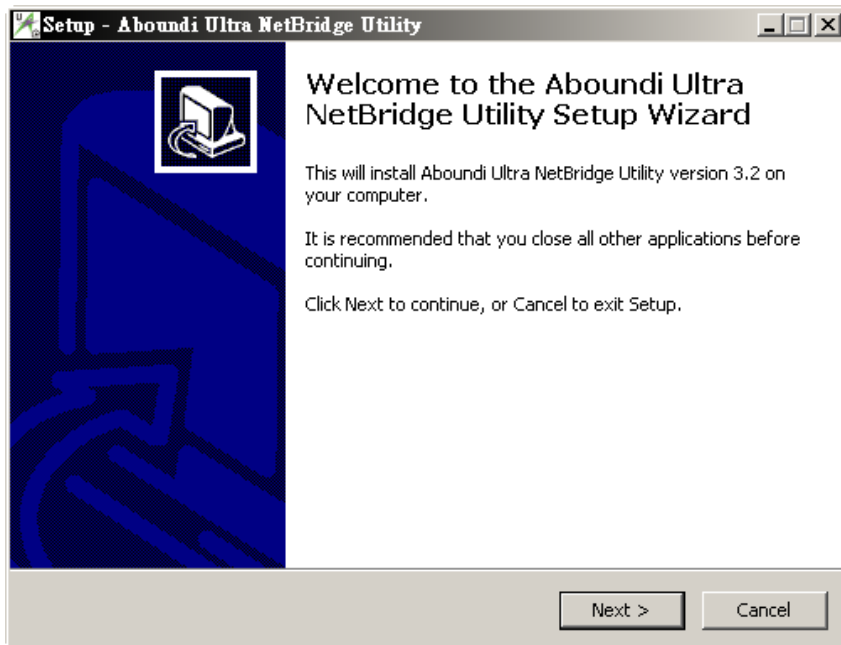

4.



Next screen shows our license agreement. Please select 'I accept the agreement' and click "Next" to next step.

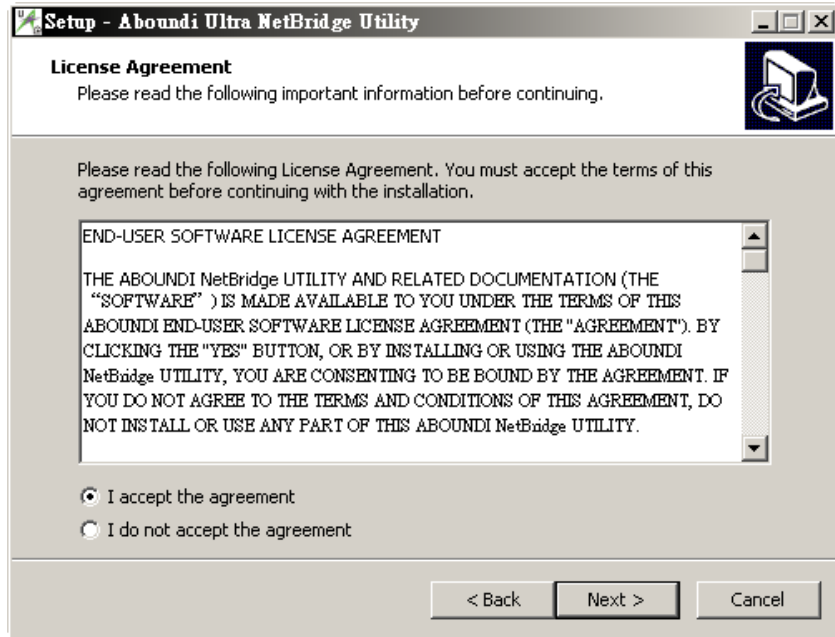

Next screen allows you to select the installation folder for the application. Click "Next>" to next step:

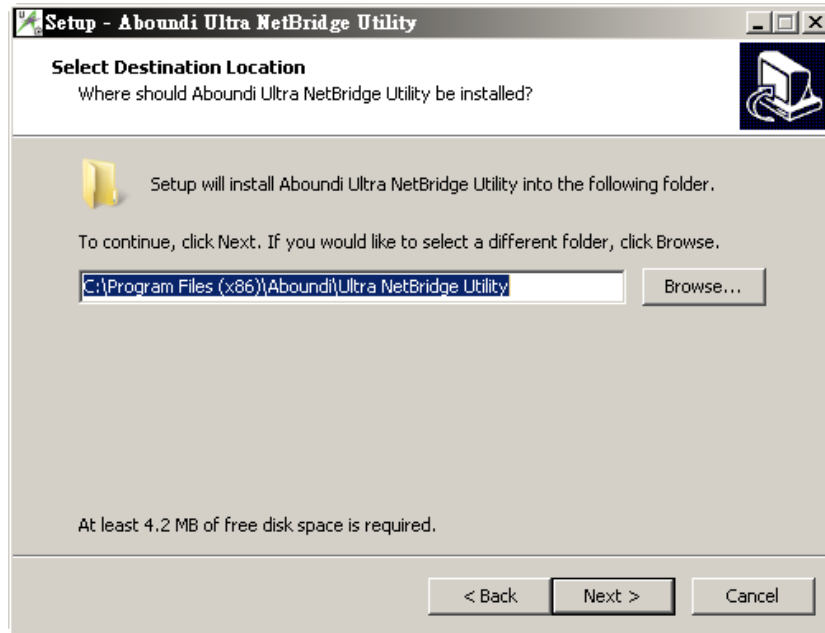

Please click “**Next>**” to install at the default Start Menu:

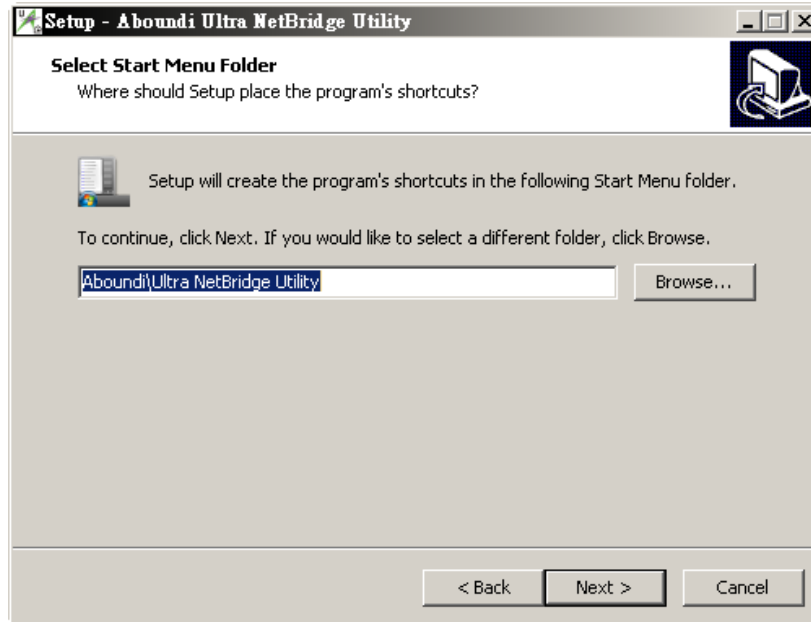

You can create a desktop icon on your windows desktop, click “**Next>**” to next step:

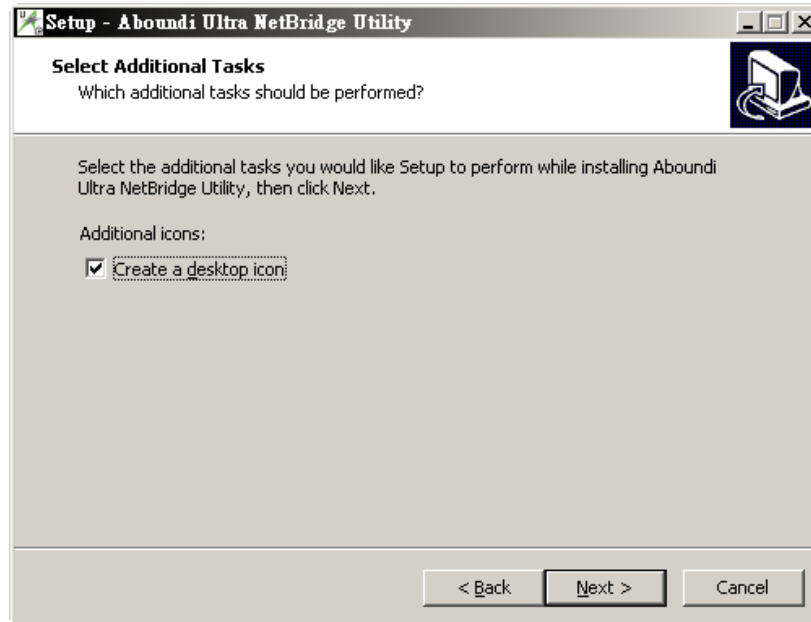



You are ready to extract and copy the files to your computer, it's the chance to change the installation settings by clicking the "<Back" button. Click "Install" button to start installation.

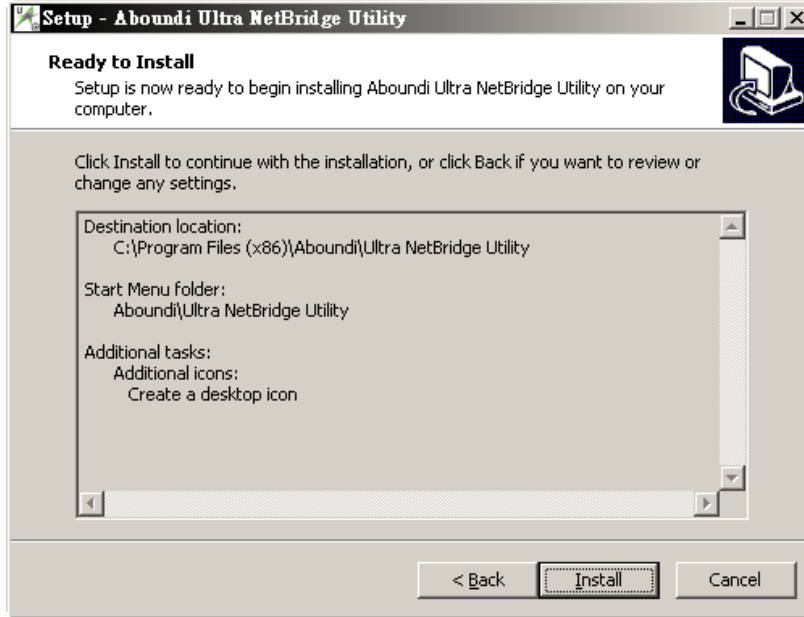

Please wait for Installation progress bar finish. Press "**Cancel**" button to abort the installation process.

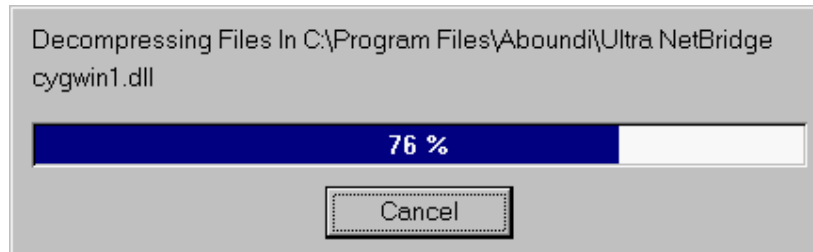

5.

Utility has been installed. Click the **“Finish”** to quit Setup window.

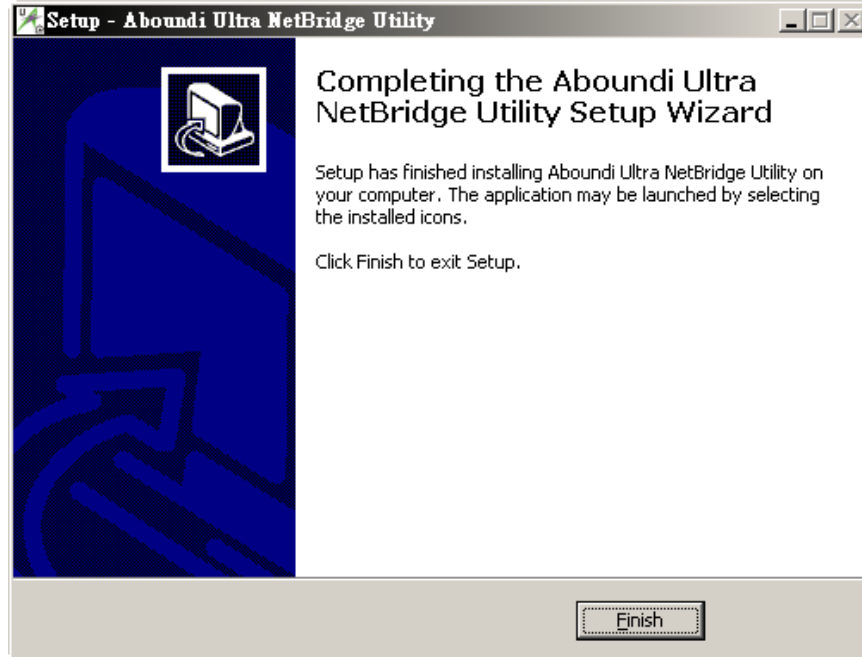

Run the Utility

When utility is installed, please run the utility from Start / Programs or double-click the Ultra

NetBridge™ Utility icon  on the Windows Desktop.

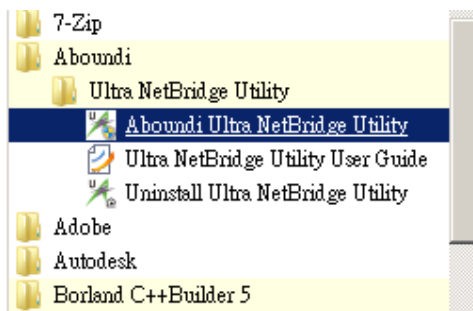

Configure IP Address (Optional)

1. Start the program and the main window will show up.

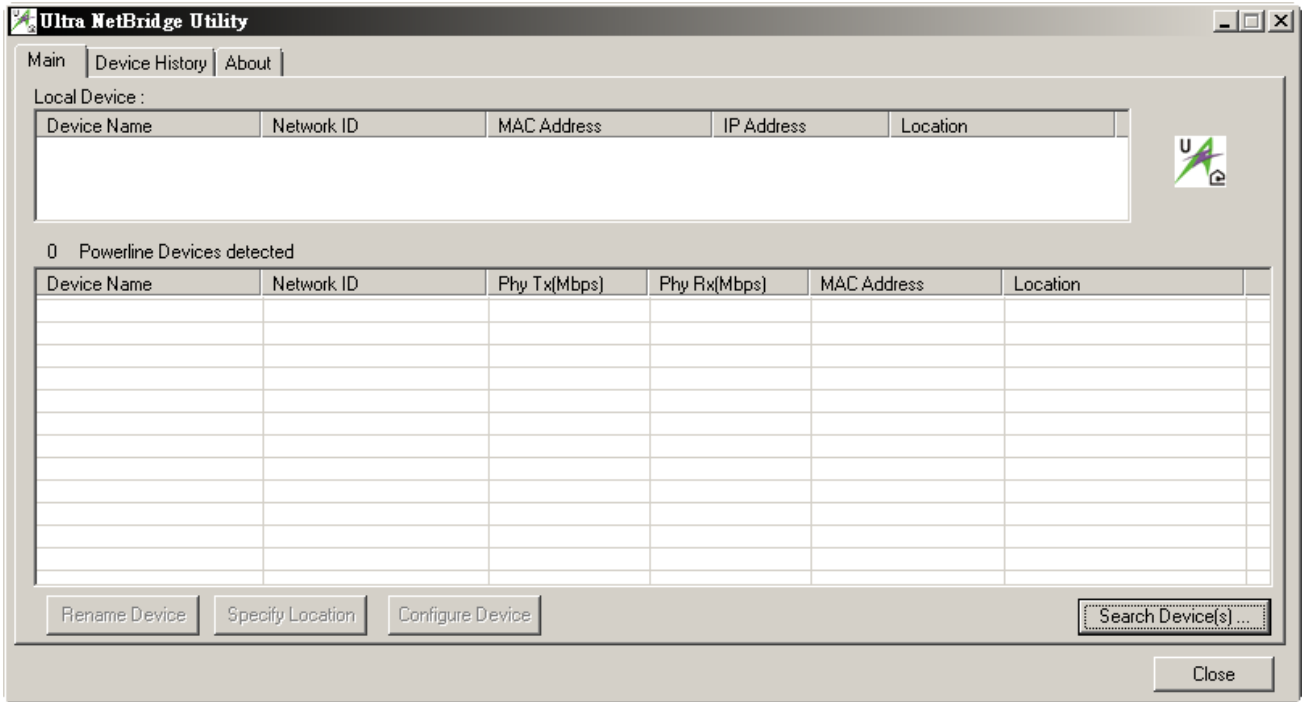

- Click on the “Search Device(s)” Button on the bottom right corner to start finding the connected Aboundi devices. The time for searching devices depends on the network quality of the number of connected Aboundi devices. When the program is performing scanning, it shows the message on the screen.

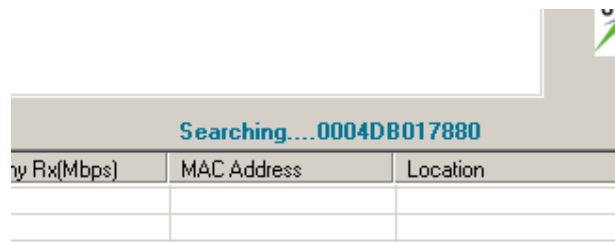

- When the searching finishes, the connected devices will be displayed on the list.

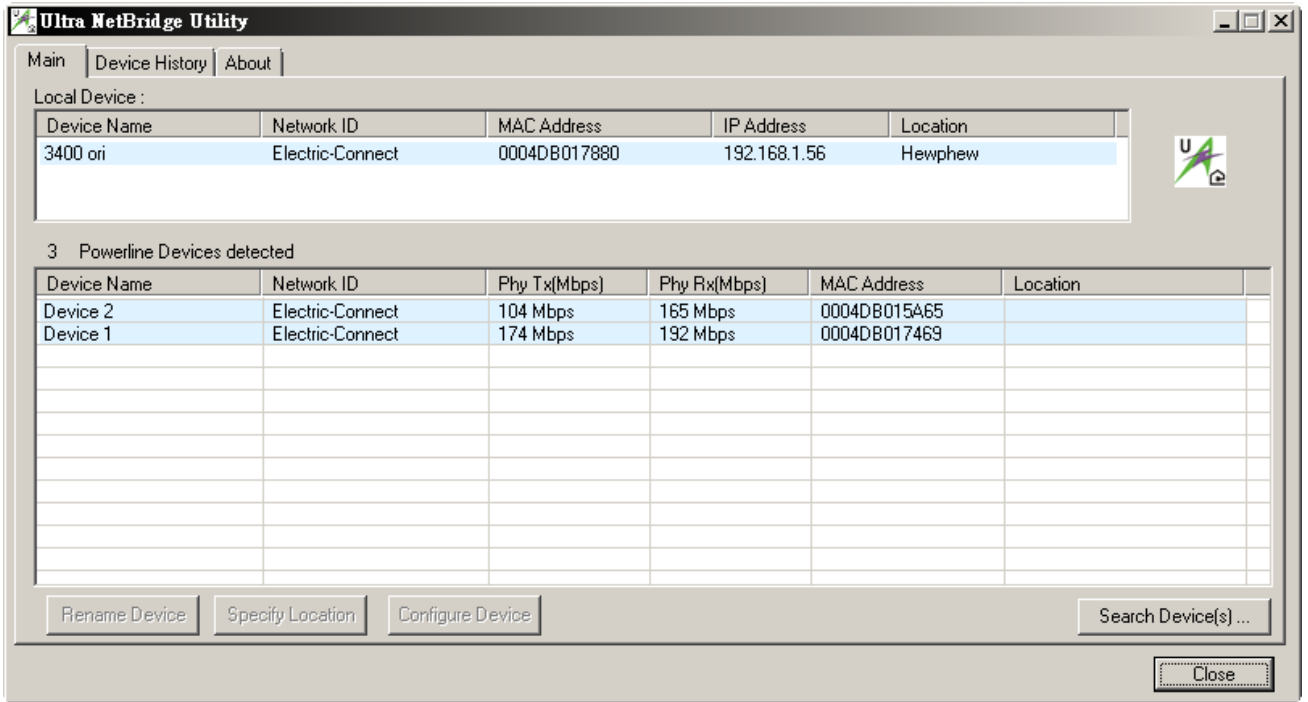

4. Select the device you want to configure and click the “Configure Device” button or double click the device to enter the configuration dialog.

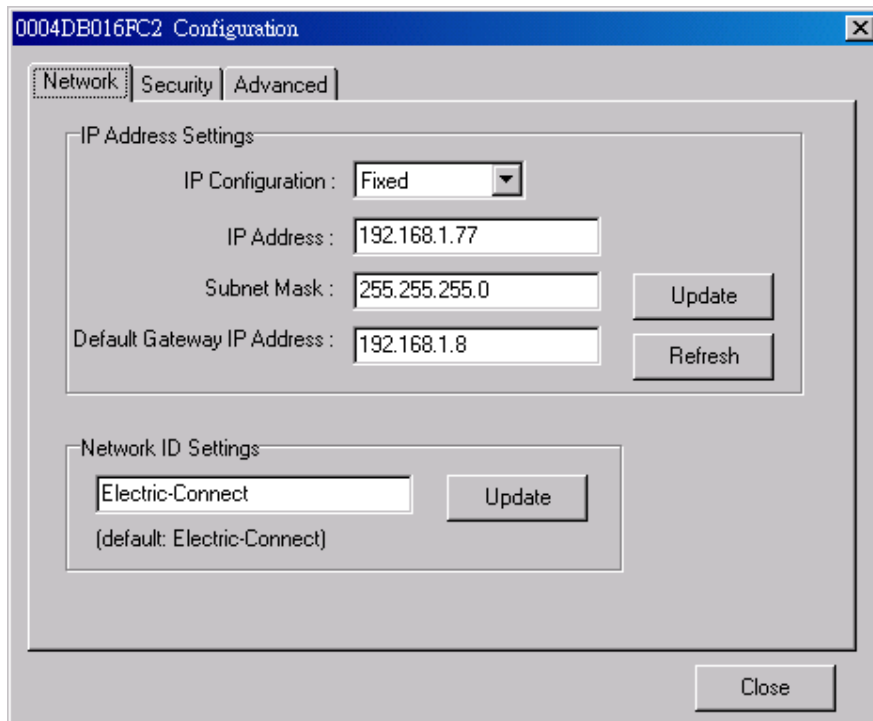



5. You are able to change the IP configuration of the individual NetBridge™. The default IP configuration is “**Fixed**” and the IP Address were set to “**0.0.0.0**”. The IP Address will be set when you want to use the web based configuration from a web browser or you’d like to ping the NetBridge™ from other device in the network. Select “**DHCP**” option to get an IP address assigned by an available DHCP server in the network. Select ‘**Fixed**’ option and fill in the values to all the text boxes then press the “**Update**” button to take effect.
6. Read more information about other configuration from the *Ultra NetBridge Utility User Guide* installed along with the software.



4. Web Configuration

The AIA1801-200-04 UltraSpeed™ NetBridge™ provides Web based configuration by your PC Web browser, such as Microsoft Internet Explorer. This approach can be adopted in any MS Windows, Mac or UNIX based platforms. You can configure the NetBridge™'s IP address using the Ultra Netbridge™ Utility before they use the Web Configuration

4.1. Start-up and Log in

Activate your browser, enter the IP address of NetBridge™ in the **Location** (for Netscape) or **Address** (for IE) field and press ENTER. For example: **http://192.168.1.176**.

After the connection is established, you will see the web user interface of NetBridge™. At the **Password** field, enter the password (the factory default value is **admin**) and then click **Log in**.

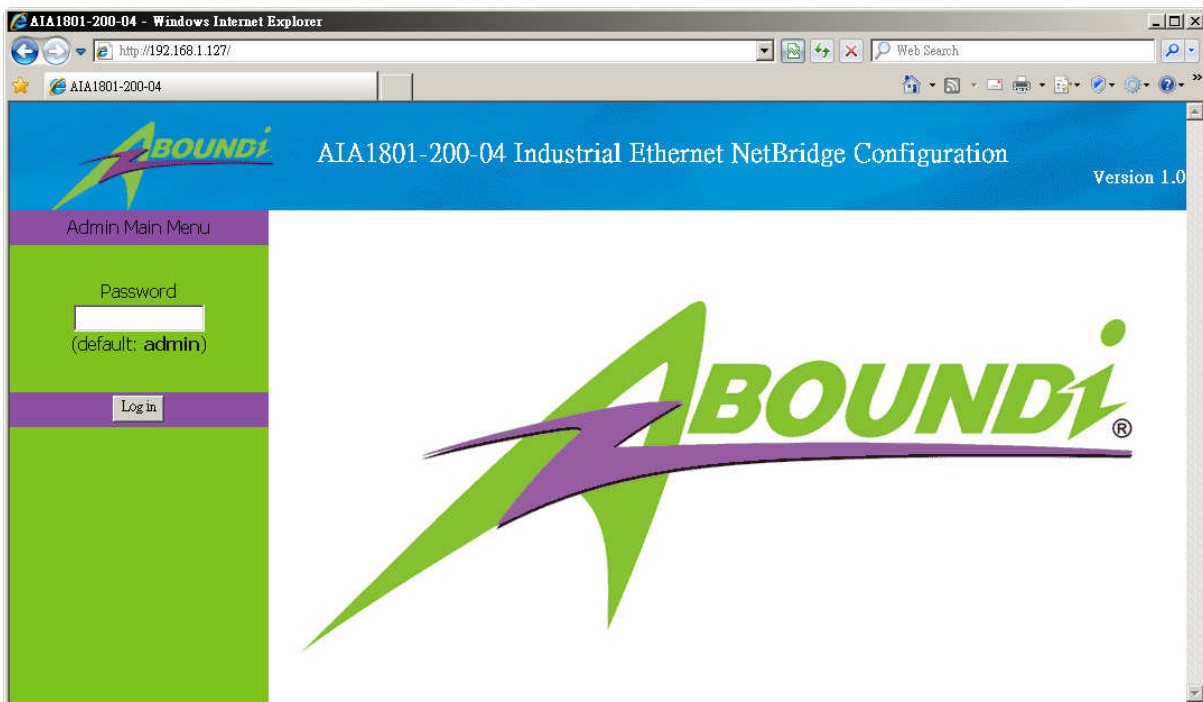

Figure 4.1.1 User Main Menu

If the password is correct, the web appearance will be changed as shown in Figure 3.1.2. As listed in its **Connection Info** page, there are several options for system administration.

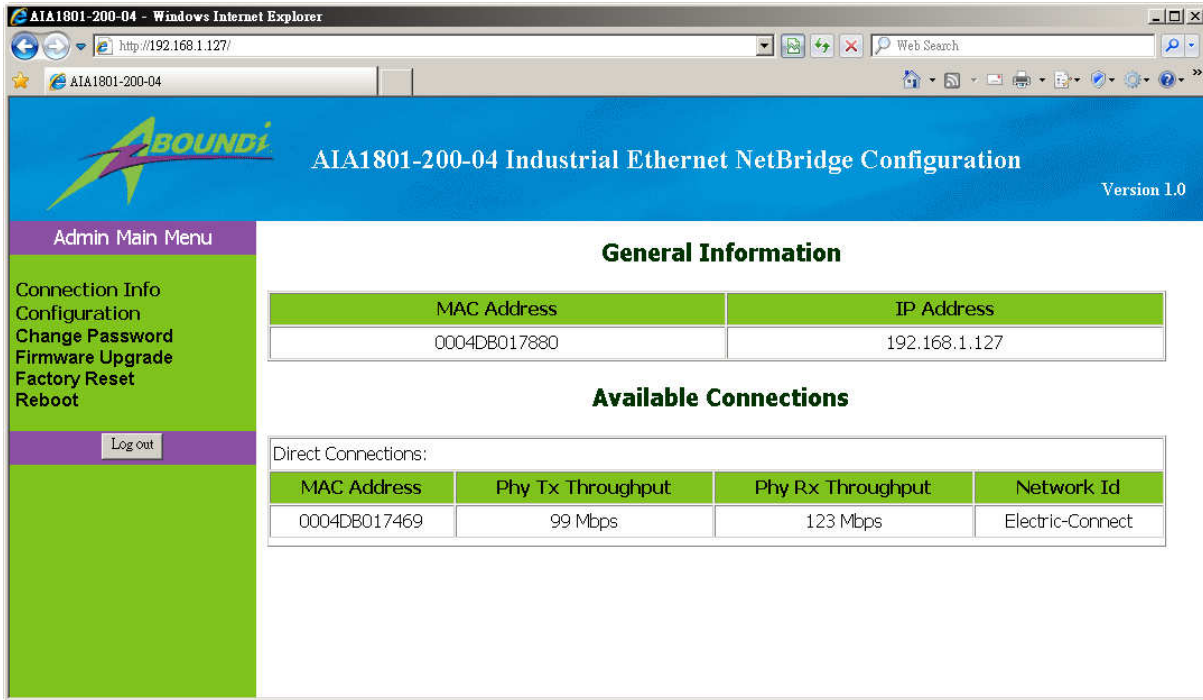

Figure 4.1.2 Connection Info Page

4.2. Connection Info

The Connection Info page displays basic information about the NetBridge™

1. **General Information:** MAC and IP addresses and the number of boots.
2. **Available Connections:** Display the list of all NetBridge™ devices discovered on the current logical power line or coax networks and the connectivity status.

4.3. Configuration

The Configuration page displays the current settings of the NetBridge™ including Security, Network, System Information.

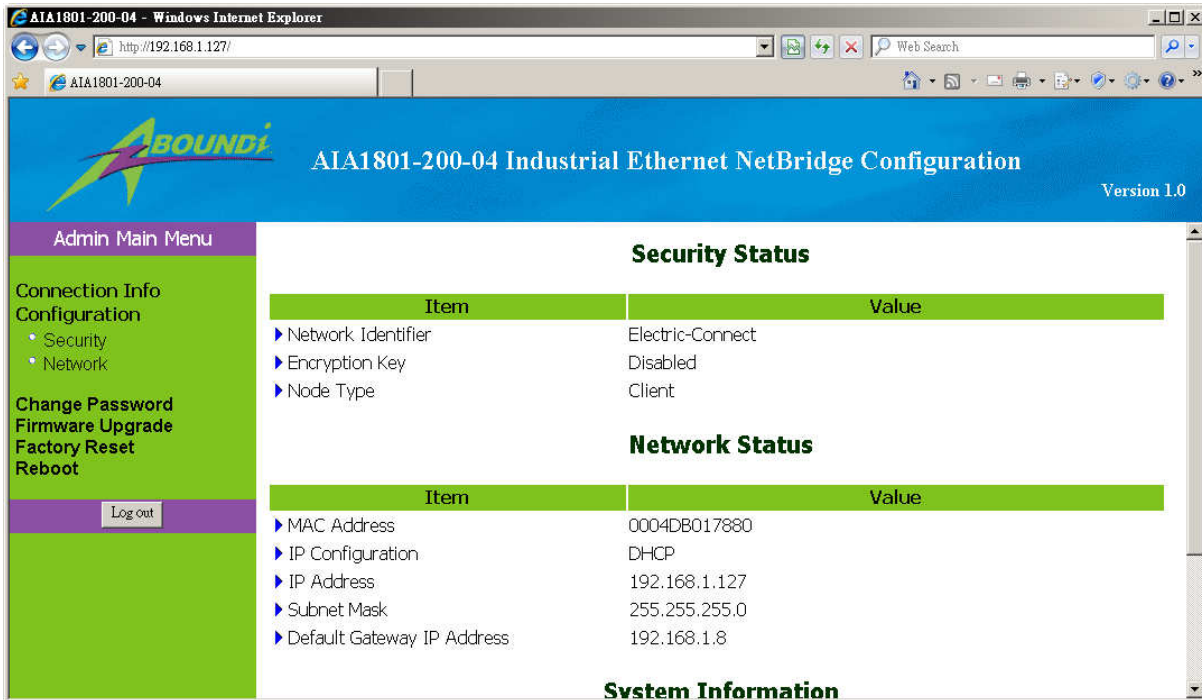

The screenshot shows a web browser window displaying the configuration page for the AIA1801-200-04 Industrial Ethernet NetBridge. The page title is "AIA1801-200-04 Industrial Ethernet NetBridge Configuration" and the version is "Version 1.0". The left sidebar contains an "Admin Main Menu" with options: "Connection Info Configuration" (with sub-items "Security" and "Network"), "Change Password", "Firmware Upgrade", "Factory Reset", and "Reboot", and a "Log out" button. The main content area is divided into sections: "Security Status", "Network Status", and "System Information".

Item	Value
▶ Network Identifier	Electric-Connect
▶ Encryption Key	Disabled
▶ Node Type	Client

Item	Value
▶ MAC Address	0004DB017880
▶ IP Configuration	DHCP
▶ IP Address	192.168.1.127
▶ Subnet Mask	255.255.255.0
▶ Default Gateway IP Address	192.168.1.8

Figure 4.3 Connection Info Page

4.3.1. Security Page

The Security page enables you to modify the Network Identifier, Encryption Key and the Mac mode.

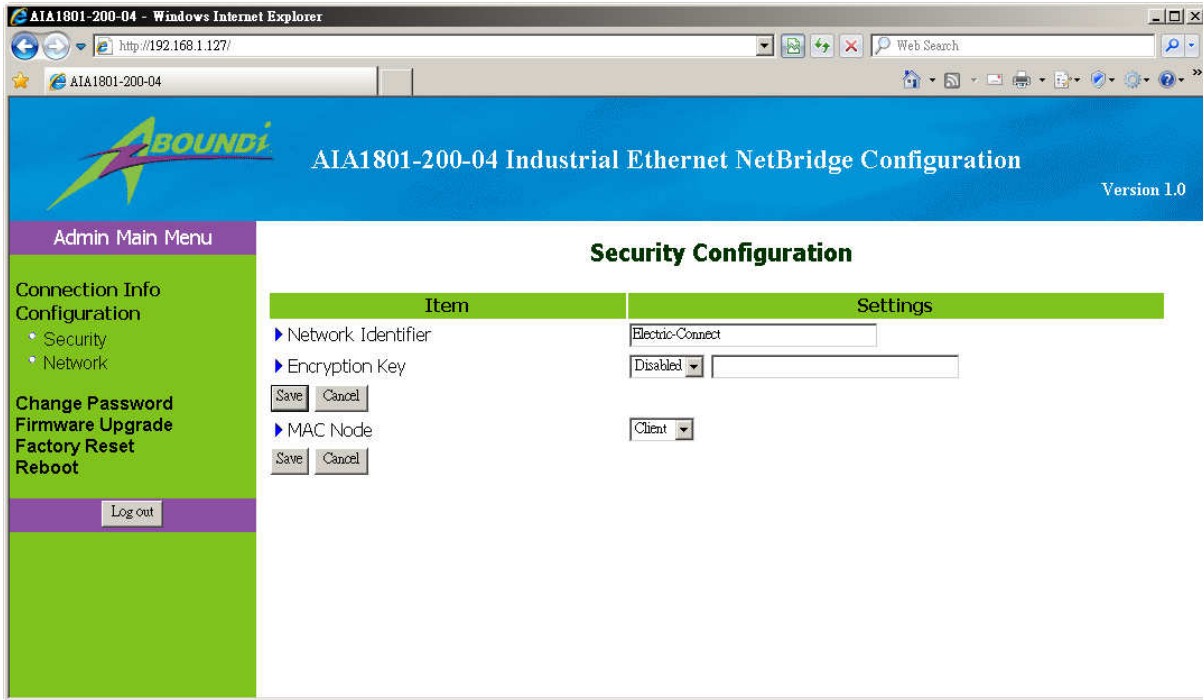

Figure 4.3.1 Security Page

4.3.2. Network Page

The Network page enables you to modify the network settings of the NetBridge™.

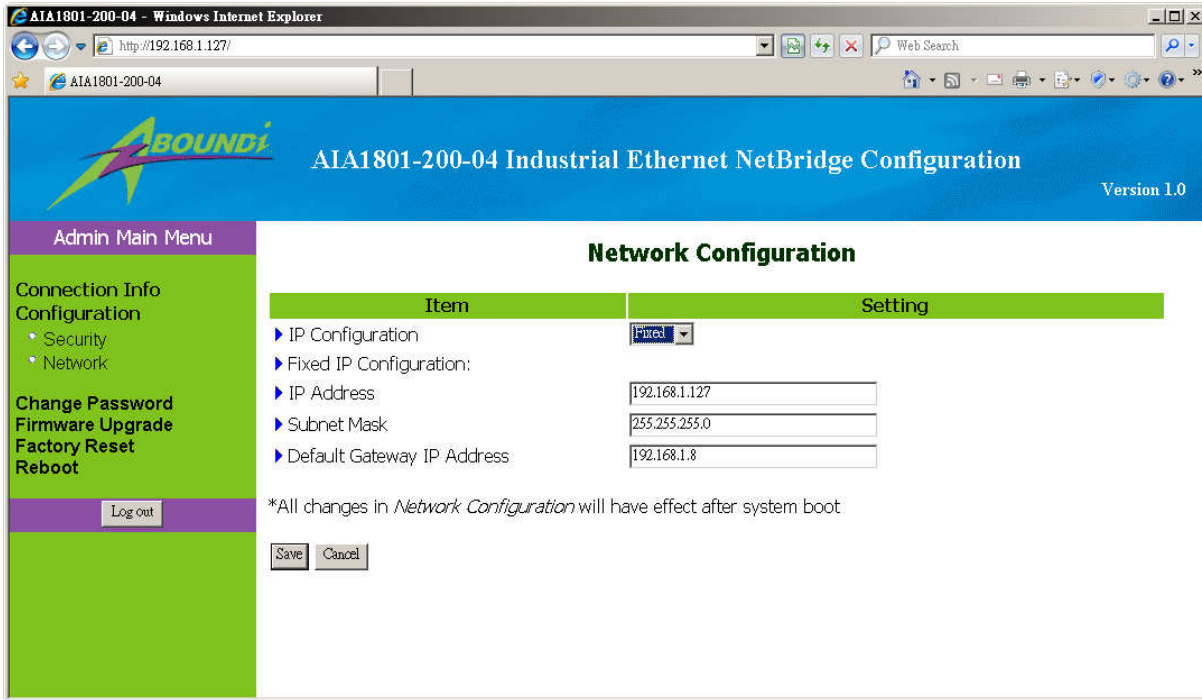

Figure 4.3.2 Network Page

4.4. Change Password

You can change the administration password for the NetBridge™ in the Change Password page.

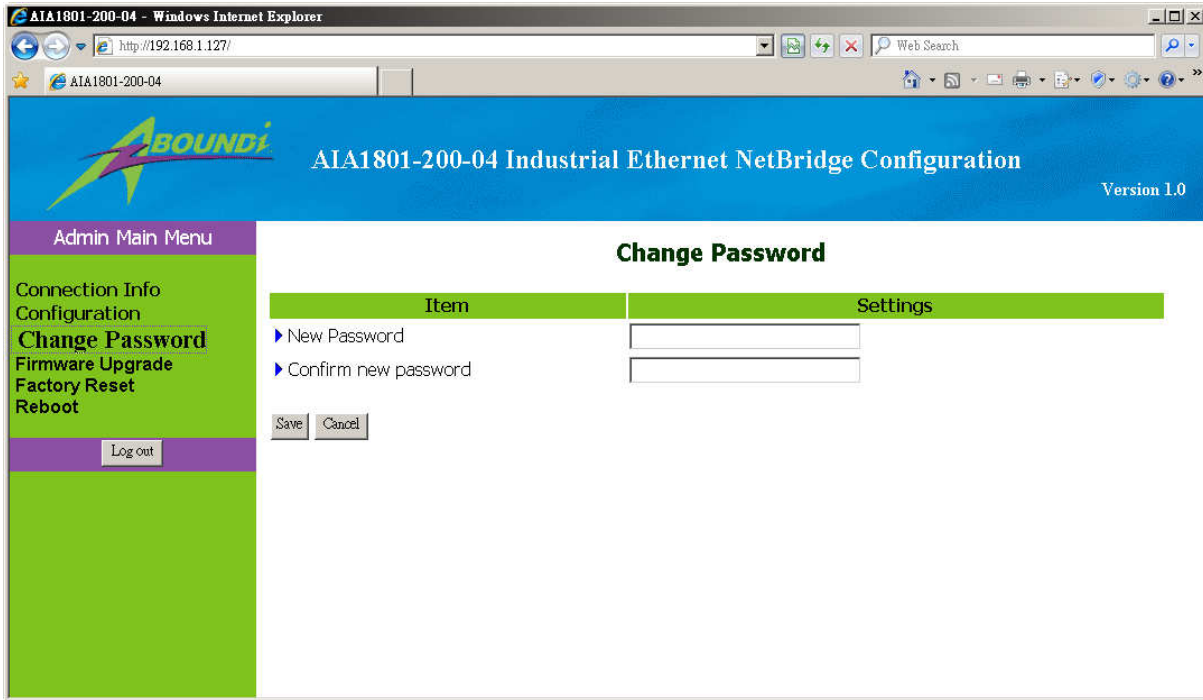

Figure 4.4 Change Password Page

4.5. Firmware Upgrade

You can upgrade the firmware for the NetBridge™ in the Firmware Upgrade page.

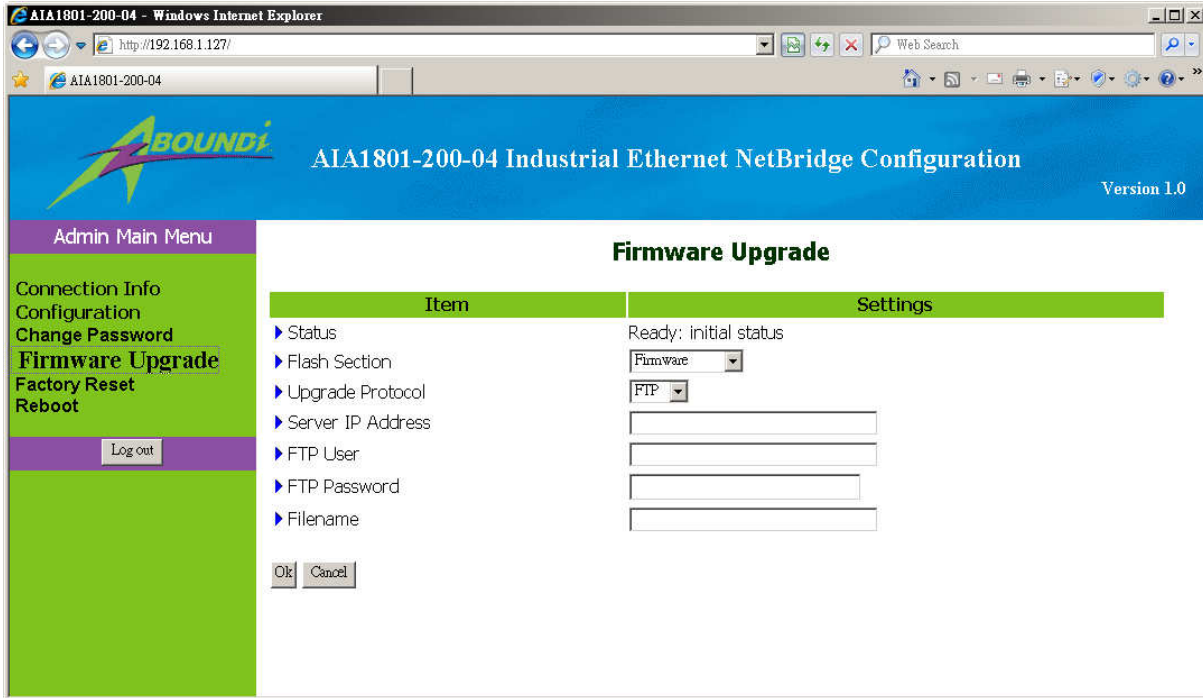

Figure 4.5 Firmware Upgrade Page

4.6. Factory Reset

You can reset the NetBridge™ to the factory default settings from the Factory Reset page.

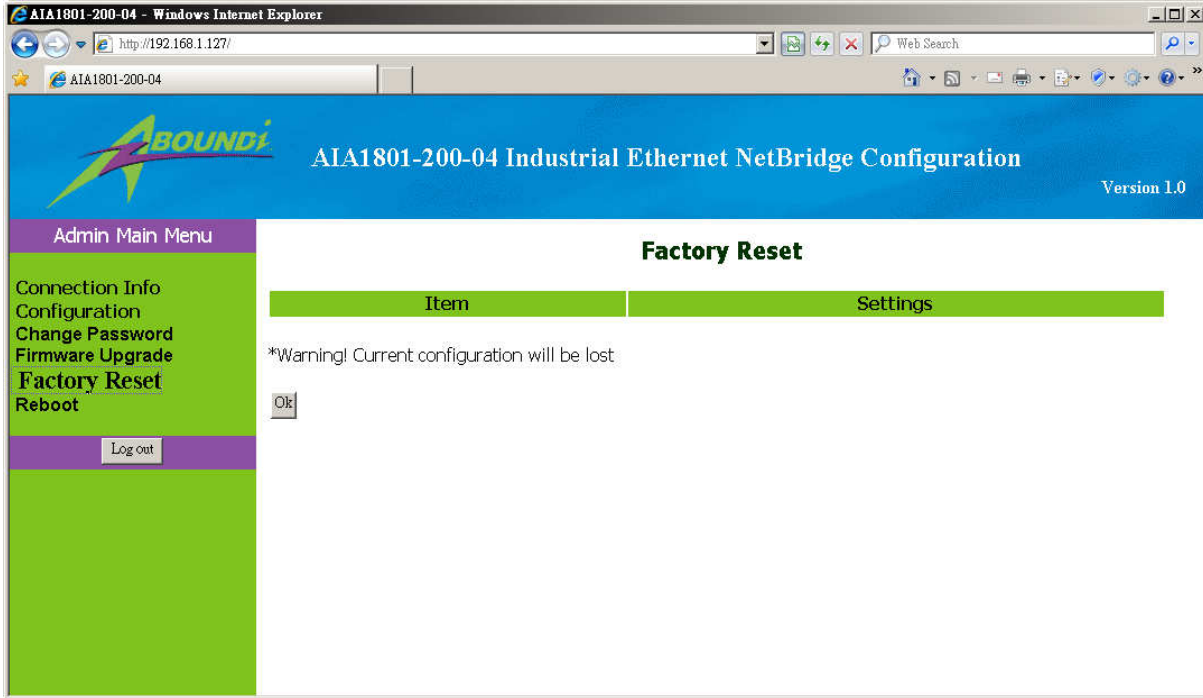

Figure 4.6 Factory Reset Page

4.7. Reboot

You can reboot the NetBridge™ remotely from the Reboot page.

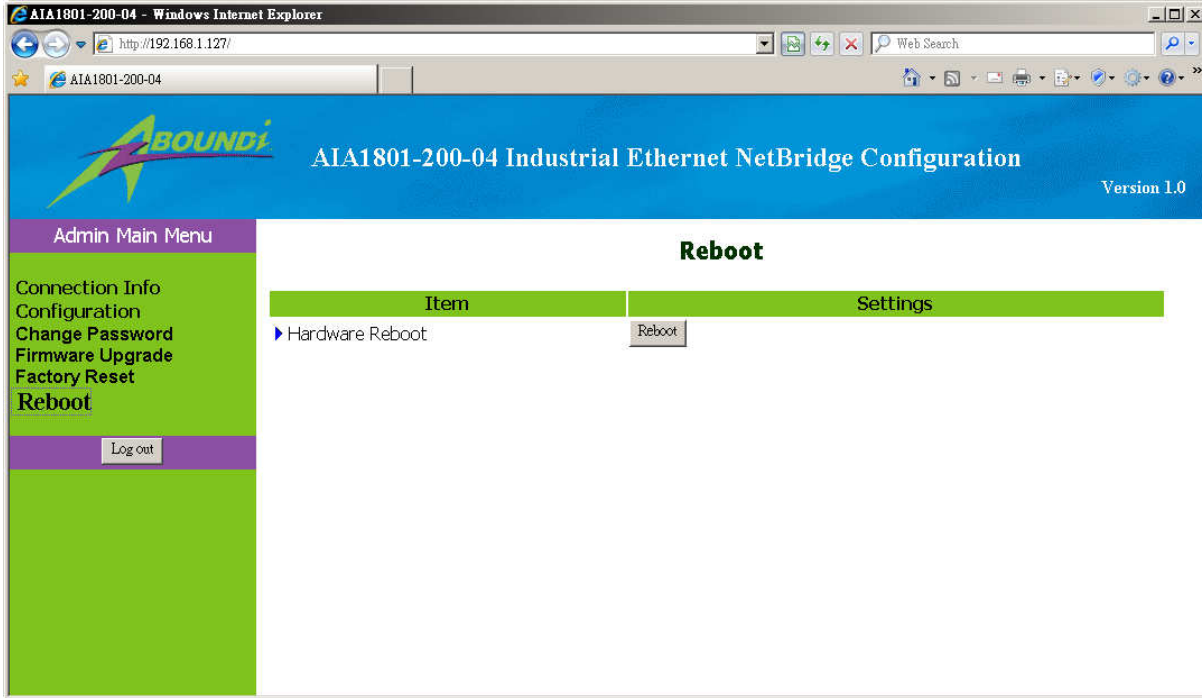

Figure 4.7 Reboot Page

5. Default Settings

Administration Password: **admin**

IP Address: **0.0.0.0**

Network Identifier: **Electric-Connect**