

MDrive® Plus

Integrated stepper motor control systems



MDrive® Plus

These compact, powerful and cost effective motion control solutions deliver unsurpassed smoothness and performance that will reduce system cost, design and assembly time for a large range of motion control applications.

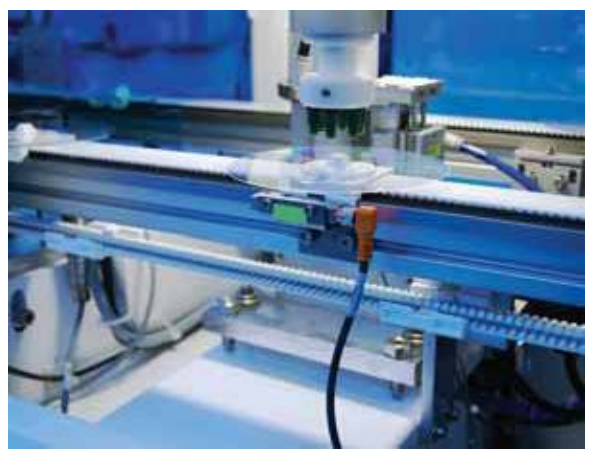

Electronics manufacture

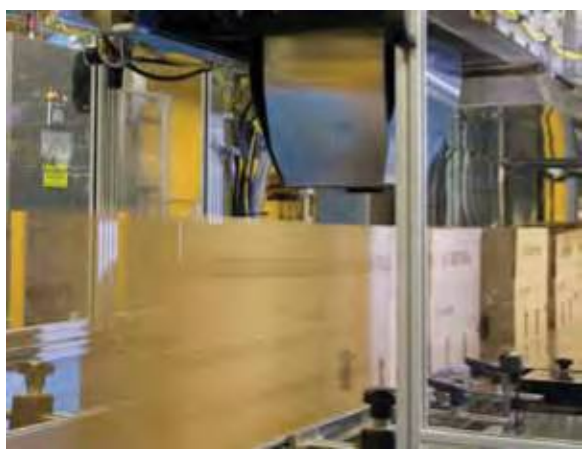

Packaging, printing, paper



Handling, labeling



Laboratory equipment



Material working



Medical technology

Keywords

Compactness

Motor and electronics form a single, compact unit with small footprint that dramatically reduces the space requirements in an application.

Simplicity

Integration of motor and electronics reduces installation costs and the potential for problems due to electrical noise by eliminating the cable between motor and drive. User-friendly PC commissioning software allows for rapid setup and configuration.

Ease of integration

Available in several versions: Motion Control, Step/direction input, CANopen, and Speed Control. This open communication concept allows for integration in existing system environments.

Flexibility

Fit a wide range of applications with four flange sizes, DC and AC power supply, and communication protocols: RS-422/485, CANopen, Ethernet, SPI.

Integrated motion

Save up to

50%

of space in the control cabinet

Reduce cabling by up to

40%

Cut installation time by up to

25%

With

100,000s

of MDrive products operating reliably all over the globe, we are the world market leader in the area of compact, low cost integrated motion

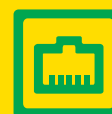

**Ethernet
now
available**



General

MDrive® Plus

Technical Support

We pride ourselves on our ability to provide first-rate technical support. Our friendly and helpful technical staff have both the knowledge and desire to answer all your technical inquiries.

Tel. +00 (1) 860 295-6102
Fax..... +00 (1) 860 295-6107
e-mail..... etech@imshome.com

Ordering

We have an extensive network of Distributors throughout the world. In addition to sales, they offer local applications support. For the name of an authorized Distributor near you, call IMS Schneider Electric Motion USA Customer Service at +00 (1) 860 295-6102, or go to the Contact page at www.imshome.com.

Customer Service

The IMS Schneider Electric Motion USA Customer Service Department is open from 8:30 A.M. to 5:00 P.M., Monday through Friday, Eastern Time.

Tel. +00 (1) 860 295-6102
Fax..... +00 (1) 860 295-6107
e-mail..... info@imshome.com
web site www.imshome.com

Contents



MDrive® Plus

Product overview

- Presentation page 2

MDrive Plus with step/direction input

- Description page 6
- Specifications page 7
- MDrive Plus with step/direction input
 - Dimensions page 8
 - Connectivity page 13
 - Part numbers page 18

MDrive Plus Motion Control fully programmable

- Description page 24
- Specifications page 25
- MDrive Plus Motion Control, fully programmable
 - Dimensions page 26
 - Connectivity page 31
 - Part numbers page 36

MDrive Plus CANopen

- Description page 42
- Specifications page 43
- MDrive Plus CANopen
 - Dimensions page 44
 - Connectivity page 49
 - Part numbers page 54

MDrive Plus Speed Control with programmable velocity control

- Description page 60
- Specifications page 61
- MDrive Plus Speed Control with programmable velocity control
 - Dimensions page 62
 - Connectivity page 65
 - Part numbers page 68

System performance

- Motor specifications page 73
- Speed torque characteristics page 74

Presentation

MDrive® Plus Product overview



- 1 microstepping drive
- 2 stepper motor
- 3 controller
- 4 up to 8 I/O lines
- 5 internal encoder
- 6 industrial connectors
- 7 communication protocols: RS-422/485, CANopen, Ethernet, SPI

Product offer

MDrive® Plus integrated motion control products consist of a motor and electronics, ideal for machine builders who want an optimized motor with on-board electronics. The integrated electronics of MDrive Plus products reduce the potential for problems due to electrical noise by eliminating the cable between motor and drive.

MDrive Plus products use 1.8° 2-phase stepper motors integrated with microstepping drive, and accept up to 20 resolution settings from full to 256 microsteps per full step, including: degrees, metric and arc minutes.

Compactness

Motor and electronics form a single, compact unit with small footprint. No space at all is required for the control electronics in the control cabinet and only very little space in the machine.

Simplicity

Integration of motor and electronics reduces installation costs and the potential for problems due to electrical noise by eliminating the cable between motor and drive. User-friendly PC commissioning software allows for rapid setup and configuration.

All-inclusive MDrive Plus QuickStart kits are available to simplify initial functional setup and system testing.

Ease of integration

MDrive Plus integrated motion control products are available in several versions:

- **Step/direction input:** motor and drive with optically isolated step and direction input via SPI communication
- **Motion Control:** motor, drive and fully programmable controller with up to 8 I/O lines, configurable 10-bit analog input, and RS-422/485 or Ethernet communication
- **CANopen:** motor, drive and controller with CANopen interface support CiA DS301 and DSP402 Device Profile for Drives and Motion Control
- **Speed Control:** motor, drive and variable speed controller configurable electronically with resolutions switchable on-the-fly, SPI communication

This open communication concept allows for integration into existing system environments.

Flexibility

MDrive Plus integrated motion control products are available with 1.8° 2-phase stepper motors in four flange sizes: NEMA 14 (36mm), NEMA 17 (42mm), NEMA 23 (57mm) and NEMA 34 (86mm). Each motor size offers specific advantages so that the MDrive Plus products can be used in a wide range of different applications.

MDrive Plus products are available in two power versions: DC and AC. The DC version is available in all four motor sizes with a power range from +12 VDC up to +75 VDC. The AC version is available for NEMA 34 (86mm) motors and includes a 120 or 240 VAC built-in power supply.

Presentation

MDrive® Plus

Product overview

Product groupings

size 14 size 17 size 23 size 34 size 34ac



Step/direction input

	MDM14	MDM17	MDM23	MDM34	MDM34ac
Holding torque range	18 ... 36 oz-in	32 ... 75 oz-in	90 ... 283 oz-in	381 ... 1061 oz-in	330 ... 750 oz-in
Communication for configuration	SPI				
Clock types	Step/Direction, Quadrature, Step Up/Step Down, Clockwise/Counterclockwise				
Step frequency	2 MHz default / 5 MHz maximum				
Configuration	Via IMS SPI Motor Interface software				

Motion Control

	MDI14	MDI17	MDI23	MDI34	MDI34ac
Holding torque range	18 ... 36 oz-in	32 ... 75 oz-in	90 ... 283 oz-in	381 ... 1061 oz-in	330 ... 750 oz-in
Communication for configuration and programming	RS-422/485 or Ethernet				
Operating modes	Fully programmable				
Configuration	Via supplied software				

CANopen

	MDI14 CAN	MDI17 CAN	MDI23 CAN	MDI34 CAN	MDI34ac CAN
Holding torque range	18 ... 36 oz-in	32 ... 75 oz-in	90 ... 283 oz-in	381 ... 1061 oz-in	330 ... 750 oz-in
Communication for configuration and programming	CANopen				
Operating modes	Profile Position, Profile Velocity, Homing Mode				
Configuration	Via supplied software				

Speed Control

	—	MDO17	MDO23	MDO34	—
Holding torque range	—	32 ... 75 oz-in	90 ... 283 oz-in	381 ... 1061 oz-in	—
Communication for configuration	SPI				
Analog speed control input	10 bit resolution				
Selectable analog input signal modes	Voltage, Current, or PWM				
Configuration	Via IMS SPI Motor Interface software				



Combining Today's Best Technologies

For Tomorrow's Break Through Discoveries

Phone: 877-478-3241
Phone: 877-IP-Tech1
Fax: 877-IP-Tech2
www.iptech1.com



Combining Today's Best Technologies

For Tomorrow's Break Through Discoveries

Phone: 877-478-3241

Phone: 877-IP-Tech1

Fax: 877-IP-Tech2

www.iptech1.com

MDrive® Plus

Step / direction input

Description

MDrive® Plus Step/direction input



MDrive® Plus with step/direction input

Presentation

The MDrive® Plus with step/direction input is a 1.8° 2-phase stepper motor with on-board control electronics. Step/direction signals of a master controller, e.g. a motion controller, or A/B signals of an encoder are converted directly into motion.

Settings for MDrive Plus step/direction input products may be changed on-the-fly or downloaded and stored in nonvolatile memory using the IMS SPI Motor Interface software provided. This eliminates the need for external switches or resistors. Parameters are changed via an SPI port.

Application areas

The MDrive Plus with step/direction input is ideal for machine builders who want an optimized motor with on-board electronics. The integrated electronics of the MDrive Plus with step/direction input reduces the potential for problems due to electrical noise by eliminating the cable between motor and drive.

These compact, powerful and cost effective motion control solutions deliver unsurpassed smoothness and performance that will reduce system cost, design and assembly time for a large range of 2-phase stepper motor applications.

Features

- Highly integrated microstepping drive and high torque 1.8° 2-phase stepper motor
- Advanced current control for exceptional performance and smoothness
- Single supply: from +12 up to +75 VDC or 120 and 240 VAC
- Cost effective
- Extremely compact
- 20 microstep resolutions up to 51,200 steps per rev including: Degrees, Metric, Arc Minutes
- Optically isolated input options:
 - Universal +5 to +24 VDC signals, sourcing or sinking
 - Differential +5 VDC signals (1)
- Automatic current reduction
- Configurable:
 - Motor run/hold current
 - Motor direction via direction input
 - Microstep resolution
 - Clock type: step and direction, quadrature, step up and step down, clockwise and counterclockwise (1)
 - Programmable digital filtering for clock and direction inputs
- Available options:
 - Long life linear actuators (2)
 - Hybrid Motion Technology™ (2)
 - Encoders
 - Control knob for manual positioning
 - Industrial connectors with IP54 rating (3)
- Several motor stack lengths available
- Setup parameters may be switched on-the-fly
- Numerous connector interface choices
- Graphical user interface provided for quick and easy parameter setup

(1) CW/CCW input unavailable for MDrive34 or MDrive34ac products.

(2) See separate documentation.

(3) Industrial connectors are unavailable for MDrive14 or MDrive34 products.

Specifications

MDrive® Plus Step/direction input

Plus specifications

		MDrive 14	MDrive 17	MDrive 23 (1)	MDrive 23 (1)	MDrive 34	MDrive 34 ac	
Input power	Voltage	VDC	12 to 48	12 to 48	12 to 75	12 to 60	12 to 75	
		VAC	—	—	—	—	—	120
	Current maximum (2)	1A	2A	2A	3.5A	4A	95 to 132 VAC @ 50/60 Hz	
Thermal	Operating temp non-condensing	Heat sink	-40° to +85°C				-40° to +75°C	
		Motor	-40° to +100°C				-40° to +90°C	
Temp output warning	Open-drain type	not applicable				+5 to +24 VDC, 50 mA current		
Protection	Type	not applicable					- Thermal - Over voltage/current	
Isolated input	Universal	Voltage range: +5 to +24 VDC sourcing or sinking step clock, direction and enable						
	Differential	Voltage range: +5 VDC clockwise and counterclockwise				not applicable		
Motion	Digital filter range	50 nS to 12.9 µS (10 MHz to 38.8 kHz)						
	Clock types	Step/direction, quadrature, step up/step down, clockwise/counterclockwise				Step/direction, quadrature, step up/step down		
	Step frequency	2 MHz default / 5 MHz maximum					2 MHz default	
	Resolution	Number of settings	20					
		Steps per revolution	200, 400, 800, 1000, 1600, 2000, 3200, 5000, 6400, 10000, 12800, 20000, 25000, 25600, 40000, 50000, 51200, 36000 (0.01 deg/µstep), 21600 (1 arc minute/µstep), 25400 (0.001 mm/µstep)					

Setup parameters (3)

SPI communication	Function	Range	Units	Default
MHC	Motor hold current	0 to 100	percent	5
MRC	Motor run current	1 to 100	percent	25
MSEL	Microstep resolution	1, 2, 4, 5, 8, 10, 16, 25, 32, 50, 64, 100, 108, 125, 127, 128, 180, 200, 250, 256	µsteps per full step	256
DIR	Motor direction override	0/1	—	CW
HCDT	Hold current delay time	0 or 2 – 65535	mSec	500
CLK TYPE	Clock type	Step/Dir, Quadrature, Up/Down, CW/CCW	—	Step/Dir
CLK IOF	Clock and direction filter	50 nS to 12.9 µS (10 MHz to 38.8 kHz)	nS (MHz)	200 nS (2 MHz)
USER ID	User ID	Customizable	1–3 characters	IMS
EN ACT	Enable active	High/Low	—	High
WARN TEMP (4)	Over temperature warning	0 to 125°C	°C	80°C

(1) Only quad stack NEMA 23 motors have +12 to +60 VDC drives, all other NEMA 23 motors have +12 to +75 VDC drives.

(2) Actual power supply current will depend on voltage and load.

(3) All parameters are set using the supplied IMS SPI Motor Interface GUI and may be changed on-the-fly. An optional Communication Converter is recommended with first orders.

(4) Only with MDrive34 and MDrive34ac products.



Dimensions

MDrive® 14 Plus Step/direction input

– Plus – mechanical specifications, dimensions in inches (mm)

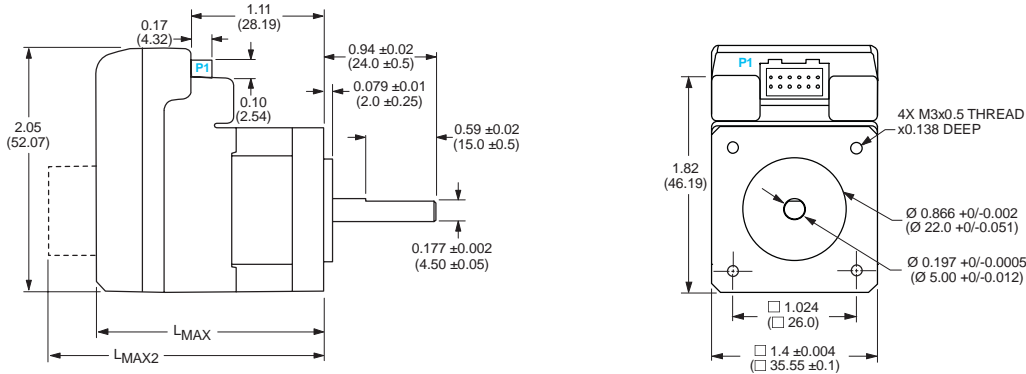

Motor stack length	Lmax (1)	Lmax2 (2)
Single	1.93 (49.02)	2.62 (66.55)
Triple	3.03 (76.96)	3.73 (94.74)

(1) Single shaft.
(2) Control knob or external encoder.

P1 connector

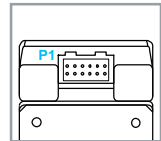

12-pin locking wire crimp connector

Lmax2 options

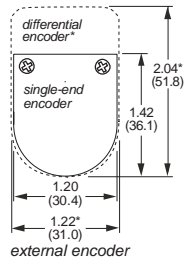
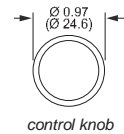

Dimensions

MDrive® 17 Plus Step/direction input

– Plus – mechanical specifications, dimensions in inches (mm)

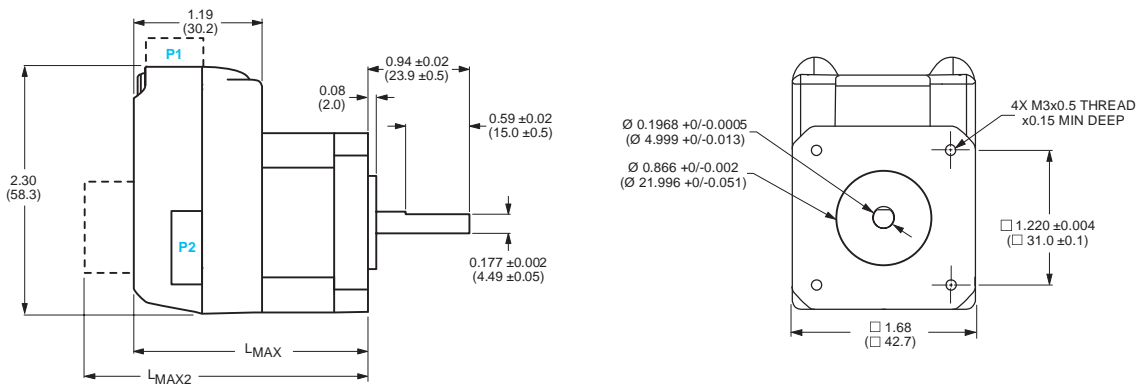

Motor stack length	Lmax (1)	Lmax2 (2)
Single	2.20 (55.9)	2.79 (70.9)
Double	2.43 (61.7)	3.02 (76.7)
Triple	2.77 (70.4)	3.37 (85.6)

(1) Single shaft.
(2) Control knob or external encoder.

P1 connector options

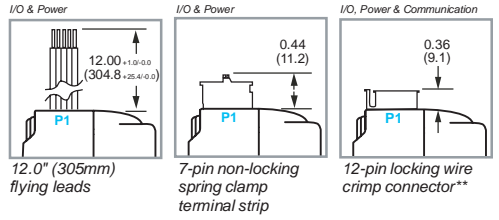

P2 connector options

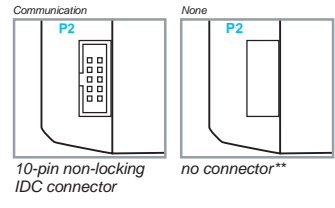

Lmax2 options

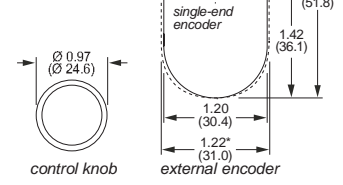

**12-pin locking wire crimp connector at P1 eliminates the P2 connector

– Plus with industrial connector – mechanical specifications, dimensions in inches (mm)

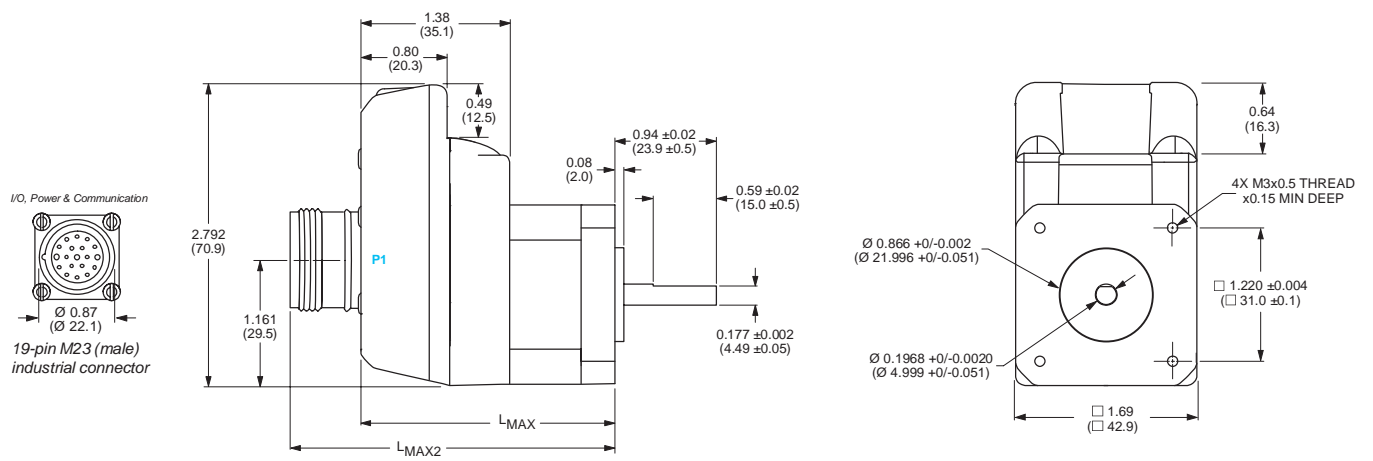

Motor stack length	Lmax	Lmax2
Single	2.39 (60.71)	3.06 (77.72)
Double	2.62 (66.55)	3.29 (83.57)
Triple	2.96 (75.18)	3.63 (92.20)

Dimensions

MDrive® 23 Plus
Step/direction input

– Plus – mechanical specifications, dimensions in inches (mm)

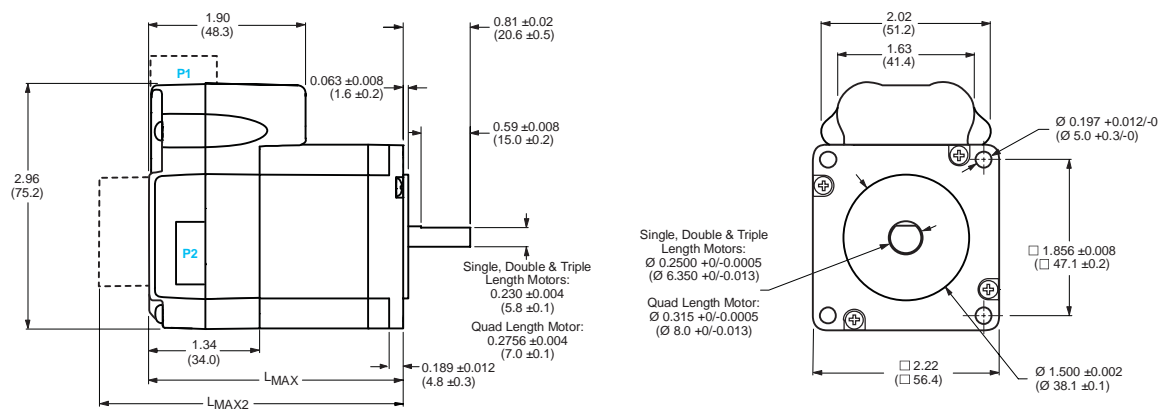

Motor stack length	Lmax (1)	Lmax2 (2)
Single	2.65 (67.31)	3.36 (85.34)
Double	3.02 (76.71)	3.73 (94.74)
Triple	3.88 (98.55)	4.59 (116.59)
Quad	5.28 (134.15)	5.99 (152.19)

(1) Single shaft.
(2) Control knob or external encoder.

P1 connector options

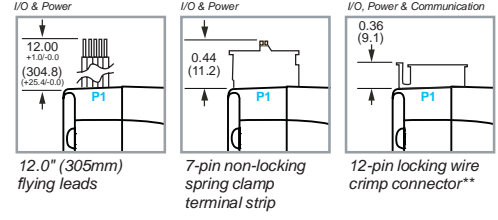

P2 connector options

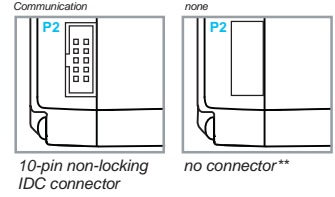

Lmax2 options

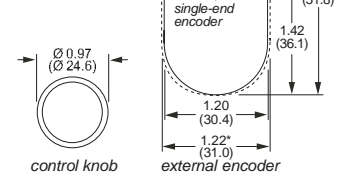

**12-pin locking wire crimp connector at P1 eliminates the P2 connector

– Plus with industrial connector – mechanical specifications, dimensions in inches (mm)

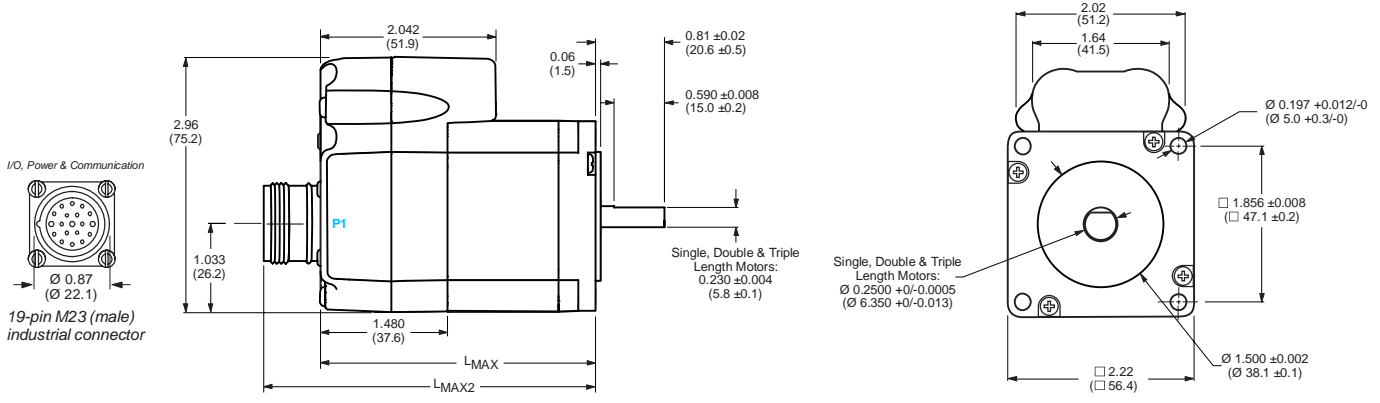

Motor stack length	Lmax	Lmax2
Single	2.82 (71.63)	3.48 (88.39)
Double	3.16 (80.26)	3.82 (97.03)
Triple	4.02 (102.11)	4.67 (118.62)

Dimensions

MDrive® 34 Plus

Step/direction input

– Plus – mechanical specifications, dimensions in inches (mm)

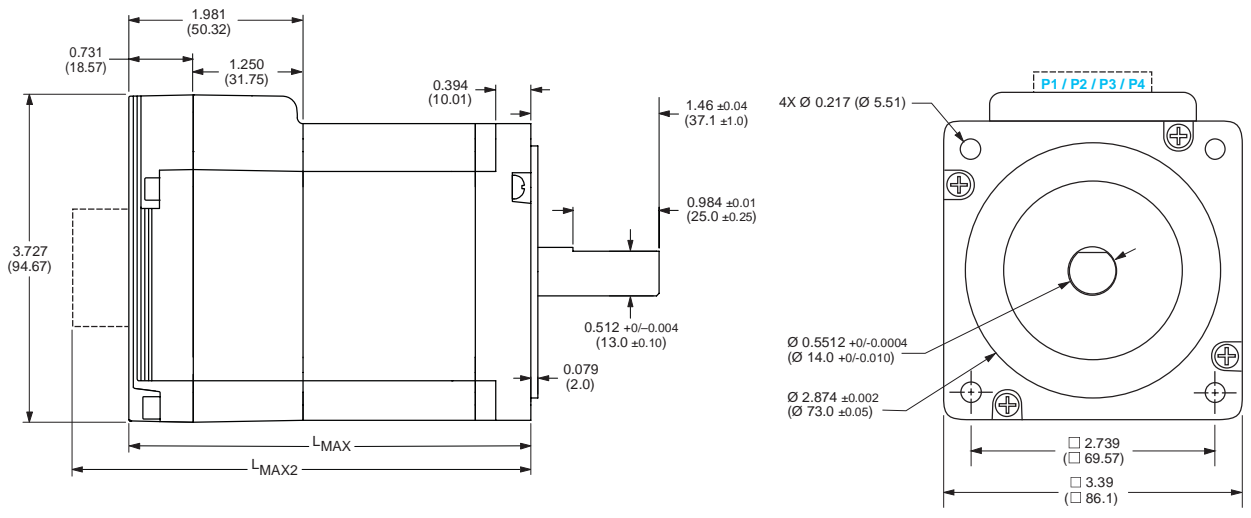

Motor stack length	Lmax (1)	Lmax2 (2)
Single	3.81 (96.77)	4.52 (114.81)
Double	4.60 (116.84)	5.31 (134.87)
Triple	6.17 (156.72)	6.88 (174.75)

(1) Single shaft or internal encoder.
 (2) Control knob.

Connector options

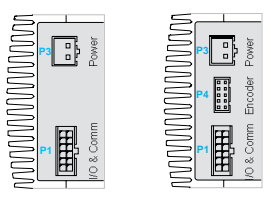

Pluggable interface version:
 12-pin and 2-pin locking wire crimp connectors only, or with 10-pin friction lock wire crimp connector when optional internal encoder is included

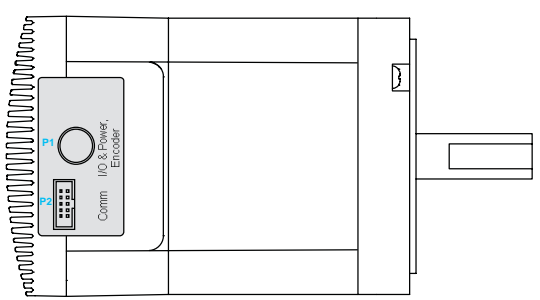

Flying leads interface version:
 12" (305mm) flying leads with 10-pin non-locking IDC connector

Lmax2 option

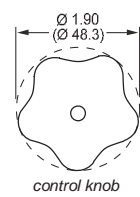

Dimensions

MDrive® 34 ac Plus
 Step/direction input

– Plus with industrial connectors – mechanical specifications, dimensions in inches (mm)

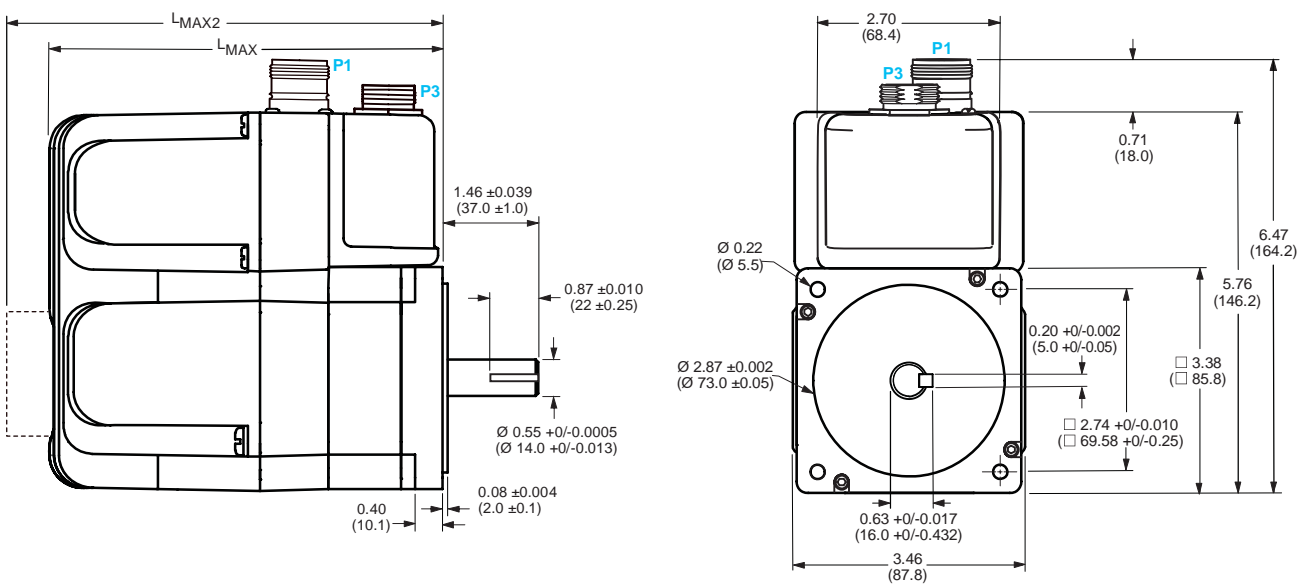

Motor stack length	Lmax (1)	Lmax2 (2)
Single	6.1 (155.0)	7.1 (180.4)
Double	6.9 (174.3)	7.9 (199.7)
Triple	8.4 (214.3)	9.4 (239.7)

(1) Single shaft or internal encoder.
 (2) Control knob.

Connector options

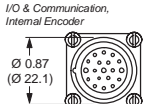

P1: 19-pin M23 (male) industrial connector

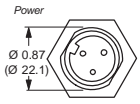

P3: 3-pin Euro AC (male) industrial connector

Lmax2 option

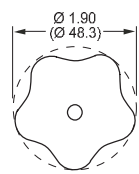

control knob

Connectivity

MDrive® 14 Plus Step/direction input

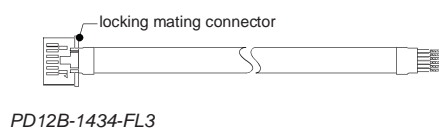
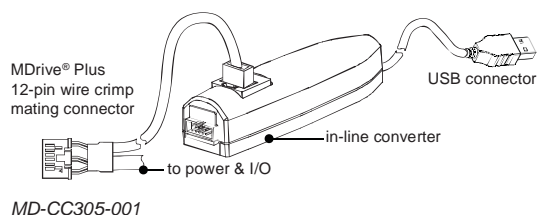

Installation accessories

Description	Length feet (m)	Part number
QuickStart Kit		
For rapid design verification, all-inclusive QuickStart Kits include connectivity, instructions and CD for MDrive Plus initial functional setup and system testing.		
■ For all MDrive14 step/direction input products	—	add "K" to part number (1)

Communication converter

Electrically isolated, in-line converter pre-wired with mating connector to conveniently set/program communication parameters for a single MDrive Plus via a PC's USB port.		
■ Mates to 12-pin locking wire crimp connector	12.0 (3.6)	MD-CC305-001

Prototype development cable

Speed test/development with pre-wired mating connector with other cable end open.		
■ Mates to 12-pin locking wire crimp connector for I/O, communication and power	10.0 (3.0)	PD12B-1434-FL3

Encoder cables

Pre-wired mating connector with other cable end open.		
■ For external single-end optical encoder	1.0 (0.3)	ED-CABLE-2
■ For external differential optical encoder with locking connector	6.0 (1.8)	ED-CABLE-6

Mating connector kit

Connectors for assembly of cables, cable material not supplied. Sold in lots of 5. Manufacturer's crimp tool recommended for crimp connectors.		
■ 12-pin locking wire crimp connector for I/O, communication and power	—	CK-08

Drive protection module

Limits surge current and voltage to a safe level when DC input power is switched on-and-off to an MDrive Plus.		
■ For all MDrive14 step/direction input products	—	DPM75

(1) See page 18.



Connectivity details: www.imshome.com/connect.html

Connectivity

MDrive® 17 Plus

Step/direction input

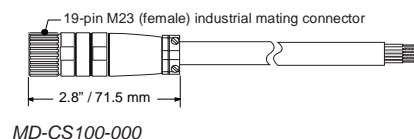
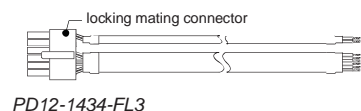
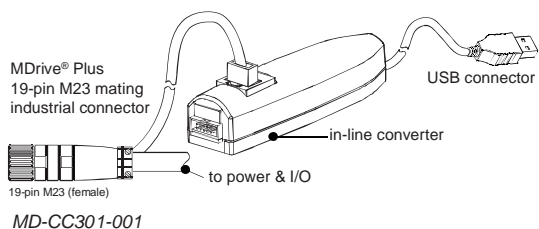
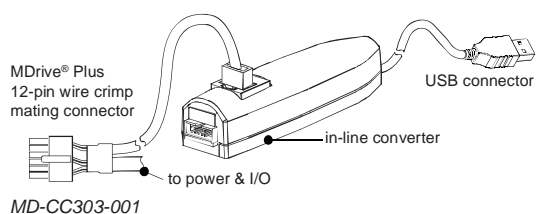
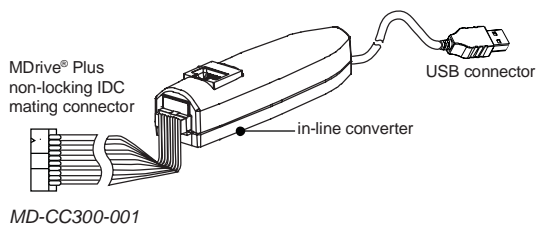

Installation accessories

Description	Length feet (m)	Part number
-------------	-----------------	-------------

QuickStart Kit

For rapid design verification, all-inclusive QuickStart Kits include connectivity, instructions and CD for MDrive Plus initial functional setup and system testing.

- For all MDrive17 step/direction input products — add "K" to part number (1)

Communication converter

Electrically isolated, in-line converter pre-wired with mating connector to conveniently set/program communication parameters for a single MDrive Plus via a PC's USB port.

■ Mates to 10-pin non-locking IDC connector	12.0 (3.6)	MD-CC300-001
■ Mates to 12-pin locking wire crimp connector	12.0 (3.6)	MD-CC303-001
■ Mates to 19-pin male M23 industrial connector	12.0 (3.6)	MD-CC301-001

Prototype development cable

Speed test/development with pre-wired mating connector with other cable end open.

■ Mates to 12-pin locking wire crimp connector for I/O, communication and power	10.0 (3.0)	PD12-1434-FL3
■ Mates to 19-pin male M23 industrial connector with straight termination for I/O, communication and power	13.0 (4.0)	MD-CS100-000
■ Mates to 19-pin male M23 industrial connector with right angle termination for I/O, communication and power	13.0 (4.0)	MD-CS101-000

Encoder cables (2)

Pre-wired mating connector with other cable end open.

■ For external single-end optical encoder with non-locking connector	1.0 (0.3)	ED-CABLE-2
■ For external differential optical encoder with locking connector	6.0 (1.8)	ED-CABLE-6

Mating connector kit

Connectors for assembly of cables, cable material not supplied. Sold in lots of 5. Manufacturer's crimp tool recommended for crimp connectors.

■ 10-pin non-locking IDC connector for communication	—	CK-01
■ 12-pin locking wire crimp connector for I/O, communication and power	—	CK-03

Drive protection module

Limits surge current and voltage to a safe level when DC input power is switched on-and-off to an MDrive Plus.

- For all MDrive17 step/direction input products — DPM75

(1) See page 19.



Connectivity details: www.imshome.com/connect.html

Connectivity

MDrive® 23 Plus

Step/direction input

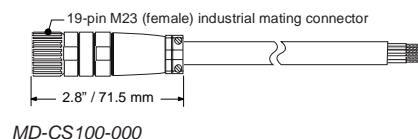
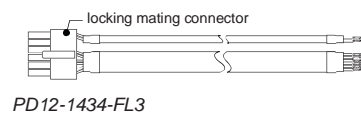
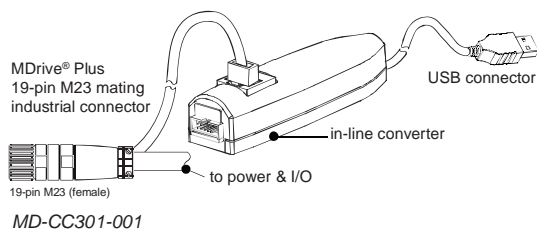
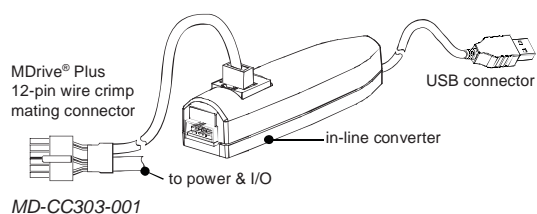
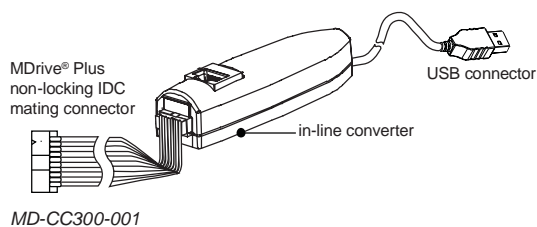

Installation accessories

Description	Length feet (m)	Part number
-------------	-----------------	-------------

QuickStart Kit

For rapid design verification, all-inclusive QuickStart Kits include connectivity, instructions and CD for MDrive Plus initial functional setup and system testing.

- For all MDrive23 step/direction input products — add "K" to part number (1)

Communication converter

Electrically isolated, in-line converter pre-wired with mating connector to conveniently set/program communication parameters for a single MDrive Plus via a PC's USB port.

■ Mates to 10-pin non-locking IDC connector	12.0 (3.6)	MD-CC300-001
■ Mates to 12-pin locking wire crimp connector	12.0 (3.6)	MD-CC303-001
■ Mates to 19-pin male M23 industrial connector	12.0 (3.6)	MD-CC301-001

Prototype development cable

Speed test/development with pre-wired mating connector with other cable end open.

■ Mates to 12-pin locking wire crimp connector for I/O, communication and power	10.0 (3.0)	PD12-1434-FL3
■ Mates to 19-pin male M23 industrial connector with straight termination for I/O, communication and power	13.0 (4.0)	MD-CS100-000
■ Mates to 19-pin male M23 industrial connector with right angle termination for I/O, communication and power	13.0 (4.0)	MD-CS101-000

Encoder cables (2)

Pre-wired mating connector with other cable end open.

■ For external single-end optical encoder with non-locking connector	1.0 (0.3)	ED-CABLE-2
■ For external differential optical encoder with locking connector	6.0 (1.8)	ED-CABLE-6

Mating connector kit

Connectors for assembly of cables, cable material not supplied. Sold in lots of 5. Manufacturer's crimp tool recommended for crimp connectors.

■ 10-pin non-locking IDC connector for communication	—	CK-01
■ 12-pin locking wire crimp connector for I/O, communication and power	—	CK-03

Drive protection module

Limits surge current and voltage to a safe level when DC input power is switched on-and-off to an MDrive Plus.

- For all MDrive23 step/direction input products — DPM75

(1) See page 20.



Connectivity details: www.imshome.com/connect.html

Connectivity

MDrive® 34 Plus

Step/direction input

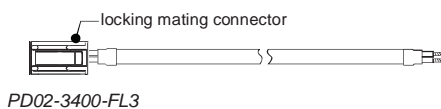
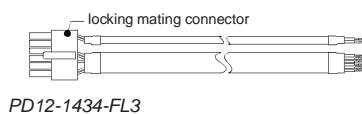
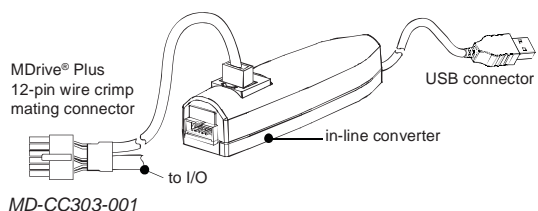
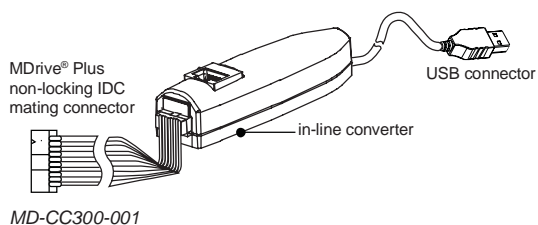

Installation accessories

Description	Length feet (m)	Part number
-------------	-----------------	-------------

QuickStart Kit

For rapid design verification, all-inclusive QuickStart Kits include connectivity, instructions and CD for MDrive Plus initial functional setup and system testing.

- For all MDrive34 step/direction input products — add "K" to part number (1)

Communication converter

Electrically isolated, in-line converter pre-wired with mating connector to conveniently set/program communication parameters for a single MDrive Plus via a PC's USB port.

- | | | |
|--|------------|--------------|
| ■ Mates to 10-pin non-locking IDC connector | 12.0 (3.6) | MD-CC300-001 |
| ■ Mates to 12-pin locking wire crimp connector | 12.0 (3.6) | MD-CC303-001 |

Prototype development cable

Speed test/development with pre-wired mating connector with other cable end open.

- | | | |
|--|------------|---------------|
| ■ Mates to 12-pin locking wire crimp connector for I/O and communication | 10.0 (3.0) | PD12-1434-FL3 |
| ■ Mates to 2-pin locking wire crimp connector for power | 10.0 (3.0) | PD02-3400-FL3 |

Encoder cables

Pre-wired mating connector with other cable end open.

- | | | |
|--|-----------|---------------|
| ■ 10-pin friction lock wire crimp connector for optional internal differential optical encoder | 6.0 (1.8) | PD10-3400-FL3 |
|--|-----------|---------------|

Mating connector kit

Connectors for assembly of cables, cable material not supplied. Sold in lots of 5. Manufacturer's crimp tool recommended for crimp connectors.

- | | | |
|--|---|-------|
| ■ 12-pin locking wire crimp connector for I/O and communication | — | CK-03 |
| ■ 2-pin locking wire crimp connector for power | — | CK-05 |
| ■ 10-pin friction lock wire crimp connector for optional internal differential optical encoder | — | CK-02 |
| ■ 10-pin non-locking IDC connector for I/O and communication | — | CK-01 |

Drive protection module

Limits surge current and voltage to a safe level when DC input power is switched on-and-off to an MDrive Plus.

- | | | |
|--|---|-------|
| ■ For all MDrive34 step/direction input products | — | DPM75 |
|--|---|-------|

(1) See page 21.



Connectivity details: www.inshome.com/connect.html

Connectivity

MDrive® 34 ac Plus

Step/ direction input

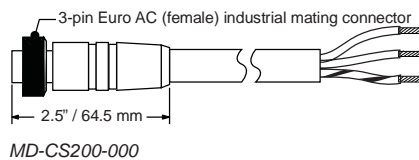
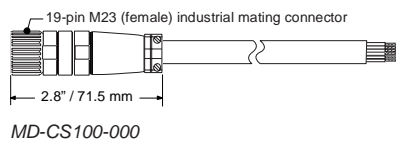
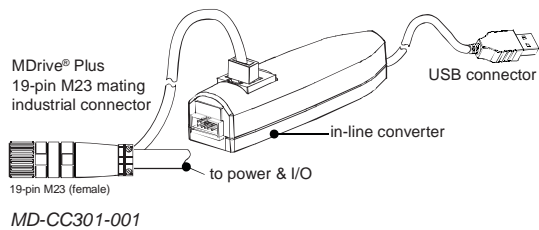

Installation accessories

Description	Length feet (m)	Part number
QuickStart Kit		
For rapid design verification, all-inclusive QuickStart Kits include connectivity, instructions and CD for MDrive Plus initial functional setup and system testing.		
■ For all MDrive34ac step/direction input products	—	add "K" to part number (1)

Communication converter

Electrically isolated, in-line converter pre-wired with mating connector to conveniently set/program communication parameters for a single MDrive Plus via a PC's USB port.

■ Mates to 19-pin male M23 industrial connector, with interface for optional internal differential optical encoder	12.0 (3.6)	MD-CC301-001
--	------------	---------------------

Prototype development cable

Speed test/development with pre-wired mating connector with other cable end open.

■ Mates to 19-pin male M23 industrial connector with straight termination for I/O, communication and optional encoder	13.0 (4.0)	MD-CS100-000
■ Mates to 19-pin male M23 industrial connector with right angle termination for I/O, communication and optional encoder	13.0 (4.0)	MD-CS101-000
■ Mates to 3-pin male Euro AC industrial connector with straight termination for power	13.0 (4.0)	MD-CS200-000
■ Mates to 3-pin male Euro AC industrial connector with right angle termination for power	13.0 (4.0)	MD-CS201-000

(1) See page 22.



Connectivity details: www.imshome.com/connect.html

Part numbers

MDrive® 14 Plus Step/direction input

MDrive® 14 Plus



P1: I/O, Power & Communication,
C = 12-pin locking wire crimp connector

Part numbers

Example:	K	M	D	M	1	C	S	Z	1	4	A	4	-E1
QuickStart Kit K = kit option, or leave blank if not wanted	K	M	D	M	1	C	S	Z	1	4	A	4	-E1
MDrive Plus version MDM = Step/direction input	K	M	D	M	1	C	S	Z	1	4	A	4	-E1
Input 1 = Universal input 5 = Differential CW/CCW input	K	M	D	M	1	C	S	Z	1	4	A	4	-E1
P1 connector C = wire crimp	K	M	D	M	1	C	S	Z	1	4	A	4	-E1
Communication S = SPI	K	M	D	M	1	C	S	Z	1	4	A	4	-E1
P2 connector Z = none	K	M	D	M	1	C	S	Z	1	4	A	4	-E1
Motor size 14 = NEMA 14 (1.4" / 36 mm)	K	M	D	M	1	C	S	Z	1	4	A	4	-E1
Motor length A = single stack C = triple stack	K	M	D	M	1	C	S	Z	1	4	A	4	-E1
Drive voltage 4 = +12 to +48 VDC	K	M	D	M	1	C	S	Z	1	4	A	4	-E1
Options Leave blank if not wanted Options may not be combined													-E1
-E ____ = external optical encoder with index mark													
	line count	100	200	250	256	400	500	512	1000	1024			
	single-end part #	E1	E2	E3	EP	E4	E5	EQ	E6	ER			
	differential part #	EAL	EBL	ECL	EWL	EDL	EHL	EXL	EJL	EYL			
-N = rear control knob for manual positioning													



Easy MDrive part numbers via an interactive tool at:
www.imshome.com/MDrivePlus.html

Part numbers

MDrive® 17 Plus

Step/direction input

MDrive® 17 Plus

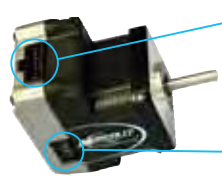

P1: I/O & Power
 F = 12" flying leads
 P = non-locking spring clamp terminal strip
 C = 12-pin locking wire crimp (includes I/O, Power & Comm)

P2: Communication
 D = SPI with 10-pin IDC non-locking connector
 Z = None. Used with 12-pin locking wire crimp in position P1, which includes communication.

MDrive® 17 Plus with industrial connector



P1: I/O, Power & Communication
 19-pin M23 male industrial connector

Part numbers

Example:	K	M	D	M	1	F	S	D	1	7	A	4	-E1	
QuickStart Kit K = kit option, or leave blank if not wanted	K	M	D	M	1	F	S	D	1	7	A	4	-E1	
MDrive Plus version MDM = Step/direction input	K	M	D	M	1	F	S	D	1	7	A	4	-E1	
Input 1 = Universal input 2 = Universal input with industrial connector, IP54-rated 5 = Differential CW/CCW input (1)	K	M	D	M	1	F	S	D	1	7	A	4	-E1	
P1 connector F = flying leads P = pluggable C = wire crimp M = industrial connector (2)	K	M	D	M	1	F	S	D	1	7	A	4	-E1	
Communication S = SPI	K	M	D	M	1	F	S	D	1	7	A	4	-E1	
P2 connector (3) (4) D = IDC Z = none	K	M	D	M	1	F	S	D	1	7	A	4	-E1	
Motor size 17 = NEMA 17 (1.7" / 42 mm)	K	M	D	M	1	F	S	D	1	7	A	4	-E1	
Motor length A = single stack B = double stack C = triple stack	K	M	D	M	1	F	S	D	1	7	A	4	-E1	
Drive voltage 4 = +12 to +48 VDC	K	M	D	M	1	F	S	D	1	7	A	4	-E1	
Options Leave blank if not wanted Options may not be combined													-E1	
-E ___ = external optical encoder with index mark (1)													-E1	
	line count	100	200	250	256	400	500	512	1000	1024				
	single-end part #	E1	E2	E3	EP	E4	E5	EQ	E6	ER				
	differential part #	EAL	EBL	ECL	EWL	EDL	EHL	EXL	EJL	EYL				
-N = rear control knob for manual positioning (1)													-E1	

(1) Not available with industrial connector products.
 (2) Only available with industrial connector products.
 (3) Wire crimp connector at P1 includes communication, so the P2 designator is Z=none.
 (4) Industrial connector at P1 includes communication, so the P2 designator is Z=none.

Easy MDrive part numbers via an interactive tool at:
www.imshome.com/MDrivePlus.html

Part numbers

MDrive® 23 Plus

Step/direction input

MDrive® 23 Plus



- P1: I/O & Power**
 F = 12" flying leads
 P = non-locking spring clamp terminal strip
 C = 12-pin locking wire crimp (includes I/O, Power & Comm)
- P2: Communication**
 D = SPI with 10-pin IDC non-locking connector
 Z = None. Used with 12-pin locking wire crimp in position P1, which includes communication.

MDrive® 23 Plus with industrial connector



- P1: I/O, Power & Communication**
 19-pin M23 male industrial connector

Part numbers

Example:	K	M	D	M	1	F	S	D	2	3	A	7	-E1
QuickStart Kit K = kit option, or leave blank if not wanted	K	M	D	M	1	F	S	D	2	3	A	7	-E1
MDrive Plus version MDM = Step/direction input	K	M	D	M	1	F	S	D	2	3	A	7	-E1
Input 1 = Universal input 2 = Universal input with industrial connector, IP54-rated 5 = Differential CW/CCW input (1)	K	M	D	M	1	F	S	D	2	3	A	7	-E1
P1 connector F = flying leads P = pluggable C = wire crimp M = industrial connector (2)	K	M	D	M	1	F	S	D	2	3	A	7	-E1
Communication S = SPI	K	M	D	M	1	F	S	D	2	3	A	7	-E1
P2 connector (3) (4) D = IDC Z = none	K	M	D	M	1	F	S	D	2	3	A	7	-E1
Motor size 23 = NEMA 23 (2.3" / 57 mm)	K	M	D	M	1	F	S	D	2	3	A	7	-E1
Motor length (5) A = single stack B = double stack C = triple stack D = quad stack	K	M	D	M	1	F	S	D	2	3	A	7	-E1
Drive voltage (5) 7 = +12 to +75 VDC 6 = +12 to +60 VDC	K	M	D	M	1	F	S	D	2	3	A	7	-E1
Options Leave blank if not wanted Options may not be combined													-E1
-E____ = external optical encoder with index mark (1)													-E1
	line count	100	200	250	256	400	500	512	1000	1024			
	single-end part #	E1	E2	E3	EP	E4	E5	EQ	E6	ER			
	differential part #	EAL	EBL	ECL	EWL	EDL	EHL	EXL	EJL	EYL			
-N____ = rear control knob for manual positioning (1)													-E1

(1) Not available with industrial connector products.

(2) Only available with industrial connector products.

(3) Wire crimp connector at P1 includes communication, so the P2 designator is Z=none.

(4) Industrial connector at P1 includes communication, so the P2 designator is Z=none.

(5) Only quad stack motors have +12 to +60 VDC drives, all other motors have +12 to +75 VDC drives.



Easy MDrive part numbers via an interactive tool at:
www.imshome.com/MDrivePlus.html

Part numbers

MDrive® 34 Plus Step/direction input

MDrive® 34 Plus
flying leads interface

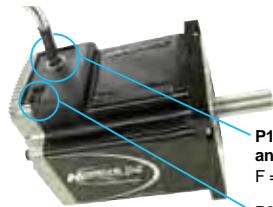

**P1: I/O & Power,
and optional encoder**
F = 12" flying leads

P2: Communication
D = SPI with 10-pin IDC
non-locking connector

MDrive® 34 Plus
pluggable interface

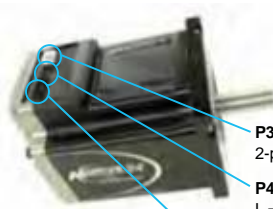

P3: Power
2-pin locking wire crimp

P4: Optional Encoder
L = 10-pin friction lock
wire crimp connector
Z = None. No encoder.

P1: I/O & Communication
C = SPI with 12-pin locking
wire crimp connector

Part numbers

Example:	K	M	D	M	1	F	S	D	3	4	A	7	-E1	
QuickStart Kit K = kit option, or leave blank if not wanted	K	M	D	M	1	F	S	D	3	4	A	7	-E1	
MDrive Plus version MDM = Step/direction input	K	M	D	M	1	F	S	D	3	4	A	7	-E1	
Input 1 = Universal input	K	M	D	M	1	F	S	D	3	4	A	7	-E1	
P1 connector F = flying leads C = pluggable	K	M	D	M	1	F	S	D	3	4	A	7	-E1	
Communication S = SPI	K	M	D	M	1	F	S	D	3	4	A	7	-E1	
P2 connector D = only with P1 connector F	K	M	D	M	1	F	S	D	3	4	A	7	-E1	
P4 connector L = only with encoder and P1 connector C Z = only without encoder and P1 connector C	K	M	D	M	1	F	S	D	3	4	A	7	-E1	
Motor size 34 = NEMA 34 (3.4" / 86 mm)	K	M	D	M	1	F	S	D	3	4	A	7	-E1	
Motor length A = single stack B = double stack C = triple stack	K	M	D	M	1	F	S	D	3	4	A	7	-E1	
Drive voltage 7 = +12 to +75 VDC	K	M	D	M	1	F	S	D	3	4	A	7	-E1	
Options Leave blank if not wanted Options may be combined													-E1	
-E___ = internal optical encoder with index mark (1)														
	line count	100	200	250	256	400	500	512	1000	1024				
	single-end part #	E1	E2	E3	EP	E4	E5	EQ	E6	ER				
	differential part #	EA	EB	EC	EW	ED	EH	EX	EJ	EY				
-N = rear control knob for manual positioning														

(1) Products with pluggable interface available only with differential encoder.



Easy MDrive part numbers via an interactive tool at:
www.imshome.com/MDrivePlus.html

Part numbers

MDrive® 34 ac Plus Step/direction input

MDrive® 34ac Plus

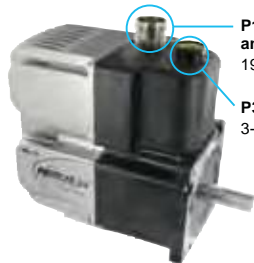

P1: I/O & Communication, and optional encoder
19-pin M23 male industrial connector

P3: Integrated Power Supply
3-pin Euro AC male industrial connector

Part numbers

Example:	K	M	D	M	2	M	S	Z	3	4	A	1	-EA	
QuickStart Kit K = kit option, or leave blank if not wanted	K	M	D	M	2	M	S	Z	3	4	A	1	-EA	
MDrive Plus version MDM = Step/direction input	K	M	D	M	2	M	S	Z	3	4	A	1	-EA	
Version 2 = Universal input with industrial connectors, IP54-rated	K	M	D	M	2	M	S	Z	3	4	A	1	-EA	
P1 connector M = M23 industrial connector	K	M	D	M	2	M	S	Z	3	4	A	1	-EA	
Communication S = SPI	K	M	D	M	2	M	S	Z	3	4	A	1	-EA	
P2 connector Z = none	K	M	D	M	2	M	S	Z	3	4	A	1	-EA	
Motor size 34 = NEMA 34 (3.4" / 86 mm)	K	M	D	M	2	M	S	Z	3	4	A	1	-EA	
Motor length A = single stack B = double stack C = triple stack	K	M	D	M	2	M	S	Z	3	4	A	1	-EA	
Drive voltage 1 = 120 VAC 2 = 240 VAC	K	M	D	M	2	M	S	Z	3	4	A	1	-EA	
Options Leave blank if not wanted Options may be combined													-EA	
-E ____ = internal optical encoder with index mark													-EA	
	line count	100	200	250	256	400	500	512	1000	1024				
	differential part #	EA	EB	EC	EW	ED	EH	EX	EJ	EY				
-N = rear control knob for manual positioning (1)													-EA	

(1) Not IP54-rated.



Easy MDrive part numbers via an interactive tool at:
www.imshome.com/MDrivePlus.html



Combining Today's Best Technologies

For Tomorrow's Break Through Discoveries

Phone: 877-478-3241
Phone: 877-IP-Tech1
Fax: 877-IP-Tech2
www.iptech1.com

MDrive® Plus

Motion Control

Description

MDrive® Plus

Motion Control

fully programmable



MDrive® Plus Motion Control, fully programmable

Presentation

The MDrive® Plus Motion Control is a 1.8° 2-phase stepper motor with on-board fully programmable motion controller, drive electronics and optional encoder. This means MDrive Plus Motion Control products are stand-alone motion control solutions that can be used without any external controller.

Programming of MDrive Plus Motion Control products with RS-422/485 interface is accomplished with MCode, simple 1 to 2 character instructions, using the IMS Terminal software tool. MDrive Plus Motion Control products may also be equipped with encoders for stall detection, position maintenance and find index mark.

MDrive Plus Motion Control programming for Ethernet is accomplished with the same MCode instruction set used for the RS-422/485 products. Ethernet products also support MODBUS/TCP application protocol, per specification Version 1.1b, with operation in immediate mode, not as programmable products.

Application areas

The MDrive Plus Motion Control is ideal for machine builders who want an optimized motor with on-board electronics. The integrated electronics of the fully programmable MDrive Plus Motion Control reduces the potential for problems due to electrical noise by eliminating the cable between motor and drive.

These compact, powerful and cost effective motion control solutions deliver unsurpassed smoothness and performance that will reduce system cost, design and assembly time for a large range of 2-phase stepper motor applications.

Features

Standard Plus

- Highly integrated microstepping drive and high torque 1.8° 2-phase stepper motor
- Advanced current control for exceptional performance and smoothness
- Single supply: from +12 up to +75 VDC or 120 and 240 VAC
- Cost effective
- Extremely compact
- 20 microstep resolutions to 51,200 steps/rev including: Degrees, Metric, Arc Minutes
- Auxiliary logic power supply input
- Open or optional closed loop control
- Programmable motor run and hold currents
- Four +5 to +24 VDC I/O lines accept sourcing or sinking outputs
- One 10 bit analog input selectable: 0 to +10 VDC, 0 to +5 VDC, 0-20 mA, 4-20 mA
- 0 to 5 MHz step clock rate selectable in 0.59 Hz increments
- RS-422/485 or Ethernet communication protocols (1)
- 62 software addresses for multi-drop communications (2)
- Simple 1 to 2 character instructions
- Available options:
 - Long life linear actuators (3)
 - Hybrid Motion Technology™ (3)
 - Encoders
 - Control knob for manual positioning
 - Industrial connectors with IP54 rating (4)
- Several motor stack lengths available
- Graphical user interface provided for quick and easy configuration and programming

Expanded Plus²

- +24 VDC tolerant I/O sourcing or sinking, inputs and outputs with up to 8 I/O lines and electronic gearing
- Closed loop control available with external/ remote encoder option
- High speed position capture input or trip output

(1) Ethernet only available for MDrive23 products.

(2) Only with RS-422/485 products.

(3) See separate documentation.

(4) Industrial connectors are unavailable for MDrive14 or MDrive34 products.

Specifications

MDrive® Plus

Motion Control

fully programmable

Standard Plus specifications

		MDrive 14	MDrive 17	MDrive 23 (1)	MDrive 23 (1)	MDrive 34	MDrive 34ac	
Input power	Voltage	12 to 48	12 to 48	12 to 75	12 to 60	12 to 75	—	
	VDC	—	—	—	—	—	—	
	VAC	—	—	—	—	—	120	
	Current maximum (2)	1A	2A	2A	3.5A	4A	95 to 132 VAC @ 50/60 Hz	
Thermal	Operating temp non-condensing	-40° to +85°C				-40° to +75°C		
	Heat sink Motor	-40° to +100°C				-40° to +90°C		
Protection	Type	not applicable					- Thermal - Over voltage/current	

Aux. logic input voltage	Range	+12 to +24 VDC <i>When input voltage is removed, maintains power only to control and feedback circuits.</i>		
Analog input	Resolution	10 bit		
	Voltage range	0 to +5 VDC, 0 to +10 VDC, 0-20 mA, 4-20 mA		
General purpose I/O	Number	4		
	Type	sourcing or sinking inputs, or sinking outputs		
	Logic range	Inputs and outputs tolerant to +24 VDC, inputs TTL level compatible		
	Output sink current	Up to 600 mA		
	Protection	Over temp, short circuit, transient over voltage, over voltage, inductive clamp		
Communication	Type	RS-422/485 or Ethernet (3)		
	Baud rate	4.8 to 115.2 kbps		
Motion	Open loop configuration	Number of settings	20	
		Steps per revolution	200, 400, 800, 1000, 1600, 2000, 3200, 5000, 6400, 10000, 12800, 20000, 25000, 25600, 40000, 50000, 51200, 36000 (0.01 deg/μstep), 21600 (1 arc minute/μstep), 25400 (0.001mm/μstep)	
	Closed loop configuration (requires encoder option)	Encoder resolution	512 lines/2048 edges per rev	
	Counters	Type	position, encoder/32 bit	
		Edge rate maximum	5 MHz	
	Velocity	Range	+/- 5,000,000 steps per second	
		Resolution	0.5961 steps per second	
	Accel/Decel	Range	1.5 x 10 ⁹ steps per second ²	
		Resolution	90.9 steps per second ²	
	Software	Program storage	Type/size	flash/6384 bytes
User registers		Four 32 bit		
User program labels & variables		192		
Math functions		+, -, ×, ÷, >, <, =, <=, >=, AND, OR, XOR, NOT		
Branch functions		Branch and Call		
General purpose I/O functions		Inputs	home, limit plus, limit minus, go, stop, pause, jog plus, jog minus, general purpose	
		Outputs	moving, fault, stall, velocity change, general purpose	
Trip functions		Trip on input, trip on position, trip on time, trip capture, trip on relative position		
Party mode addresses	62 (4)			
Encoder functions	Stall detection, position maintenance, find index			

Expanded Plus² specifications (5)

General purpose I/O	Number	8 (or 4 when remote encoder option is selected)		
	Type	sourcing or sinking outputs/inputs		
	Logic range	Sourcing outputs +12 to +24 VDC, inputs and sinking outputs tolerant to +24 VDC, inputs TTL level compatible		
	Output sinking current	Up to 600 mA		
Motion	Electronic gearing	Range/resolution/threshold – external clock in (6)	0.001 to 2.000/32 bit/TTL	
		Input filter range	50 nS to 12.9 μS (10 MHz to 38.8 kHz)	
		Range – secondary clock out (6)	1 to 1	
	High speed I/O	Position capture	Input filter range	50 nS to 12.9 μS (10 MHz to 38.8 kHz)
			Resolution	32 bit
		Trip output/input – speed/resolution/threshold	150 nS/32 bit/TTL	
	Closed loop configuration (requires remote encoder)	Steps per revolution	Same as Standard Plus specification shown in section above	
		Encoder type	User-supplied differential encoder	
		Encoder resolution	User-defined	

(1) Only quad stack NEMA 23 motors have +12 to +60 VDC drives, all other NEMA 23 motors have +12 to +75 VDC drives.

(2) Actual power supply current will depend on voltage and load.

(3) Ethernet only available with MDrive23 Plus products.

(4) Only with RS-422/485 products.

(5) MDrive34ac products available only as Plus² versions.

(6) Adjusting the microstep resolution can increase the range.

See User Manual for complete details: www.imshome.com/manuals.html



Dimensions

MDrive® 14 Plus
Motion Control
fully programmable

– Plus – mechanical specifications, dimensions in inches (mm)

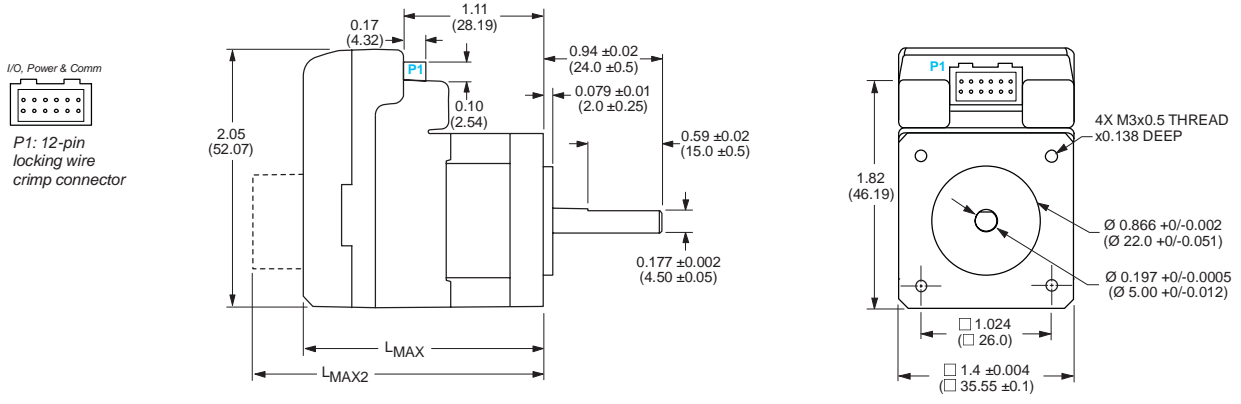

Motor stack length	Lmax (1)	Lmax2 (2)
Single	1.93 (49.02)	2.62 (66.55)
Triple	3.03 (76.96)	3.73 (94.74)

(1) Single shaft or internal encoder.
(2) Control knob.

– Plus² – mechanical specifications, dimensions in inches (mm)

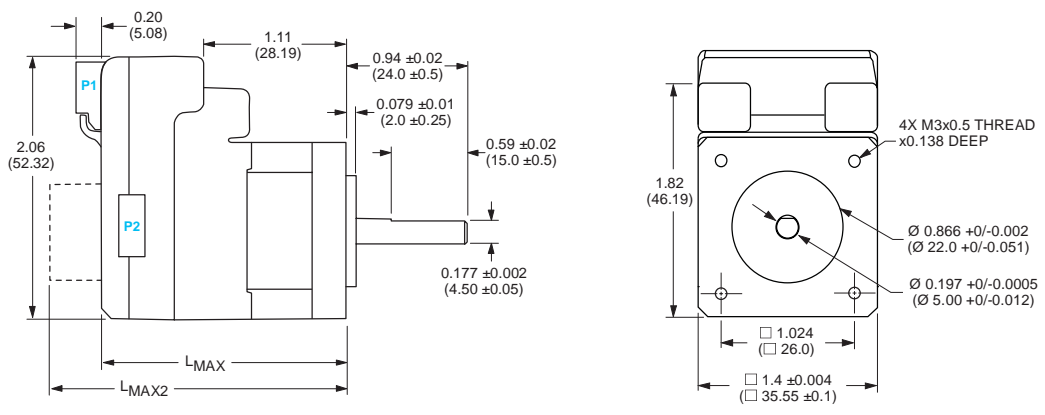

Motor stack length	Lmax (1)	Lmax2 (2)
Single	1.93 (49.02)	2.62 (66.55)
Triple	3.03 (76.96)	3.73 (94.74)

(1) Single shaft or internal encoder.
(2) Control knob.

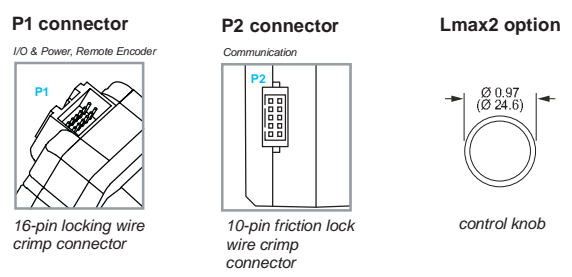

Dimensions

MDrive® 17 Plus
Motion Control
fully programmable

– Plus & Plus² – mechanical specifications, dimensions in inches (mm)

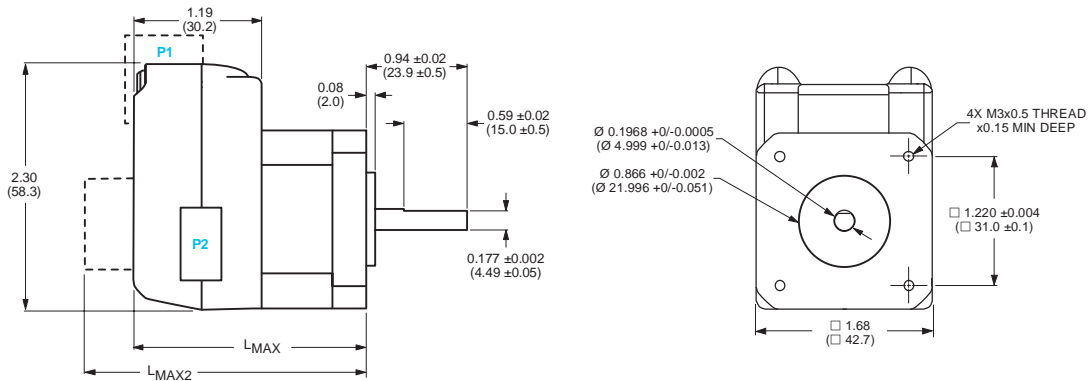

Motor stack length	Lmax (1)	Lmax2 (2)
Single	2.20 (55.9)	2.79 (70.9)
Double	2.43 (61.7)	3.02 (76.7)
Triple	2.77 (70.4)	3.37 (85.6)

(1) Single shaft or internal encoder.
(2) Control knob or external encoder.

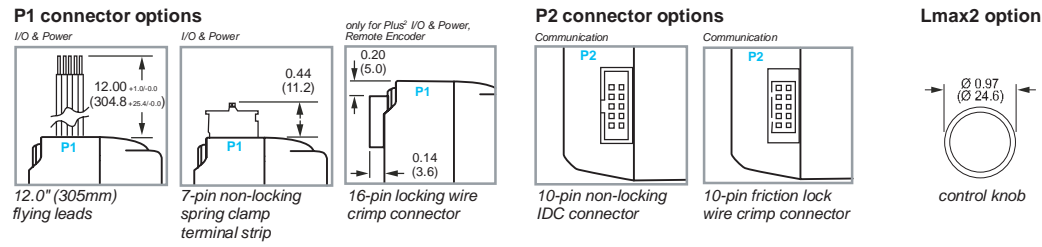

– Plus² with industrial connectors – mechanical specifications, dimensions in inches (mm)

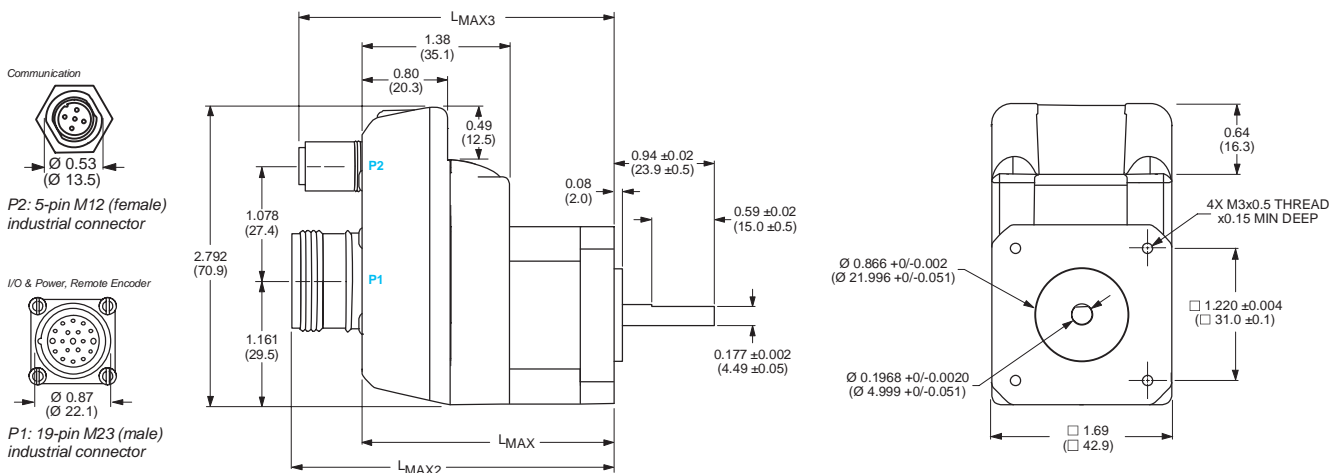

Motor stack length	Lmax	Lmax2	Lmax3
Single	2.39 (60.71)	3.06 (77.72)	2.99 (75.95)
Double	2.62 (66.55)	3.29 (83.57)	3.22 (81.79)
Triple	2.96 (75.18)	3.63 (92.20)	3.56 (90.42)

Dimensions

MDrive® 23 Plus

Motion Control

fully programmable

– Plus & Plus² – mechanical specifications, dimensions in inches (mm)

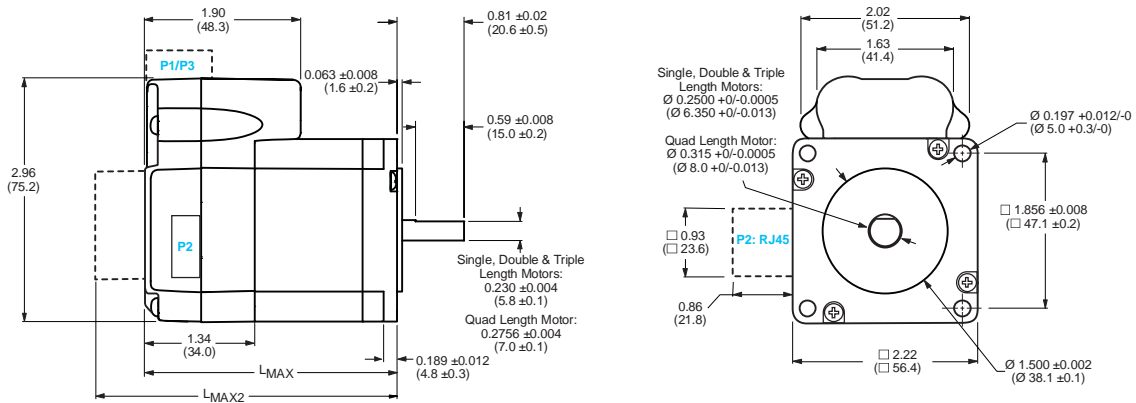

Motor stack length	Lmax (1)	Lmax2 (2)
Single	2.65 (67.31)	3.36 (85.34)
Double	3.02 (76.71)	3.73 (94.74)
Triple	3.88 (98.55)	4.59 (116.59)
Quad	5.28 (134.15)	5.99 (152.19)

(1) Single shaft or internal encoder.
(2) Control knob or external encoder.

P1 connector options

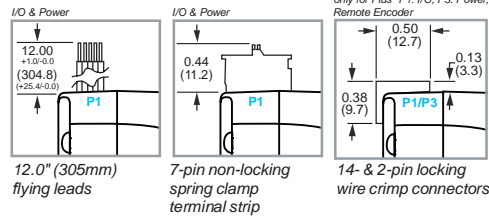

P2 connector options

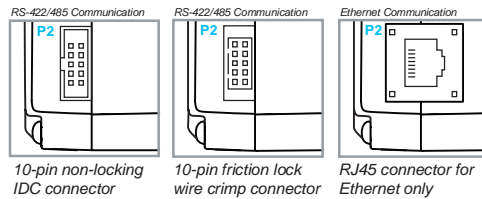

Lmax2 option

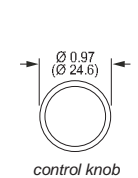

– Plus² with industrial connectors – mechanical specifications, dimensions in inches (mm)

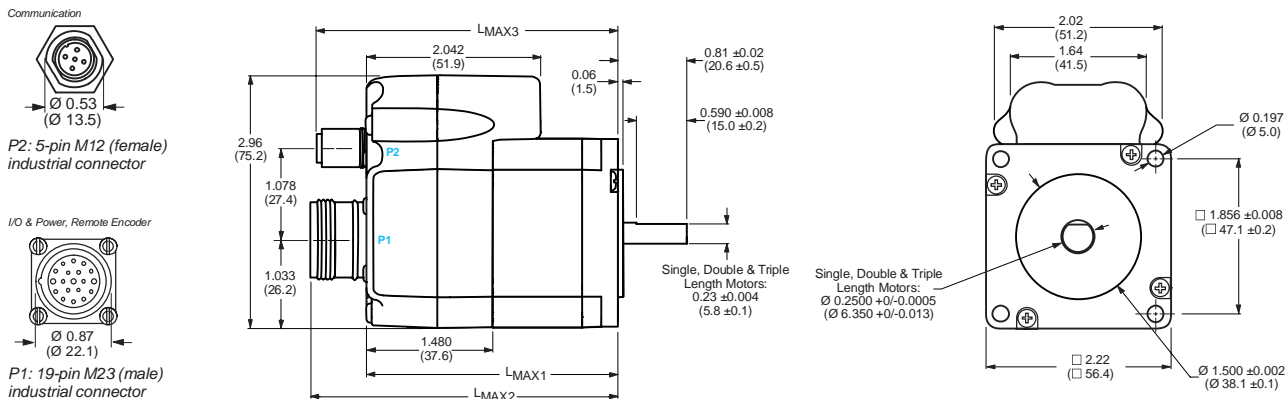

Motor stack length	Lmax	Lmax2	Lmax3
Single	2.82 (71.63)	3.48 (88.39)	3.42 (86.87)
Double	3.16 (80.26)	3.82 (97.03)	3.76 (95.5)
Triple	4.02 (102.11)	4.67 (118.62)	4.62 (117.35)

Dimensions

MDrive® 34 Plus

Motion Control

fully programmable

– Plus & Plus² – mechanical specifications, dimensions in inches (mm)

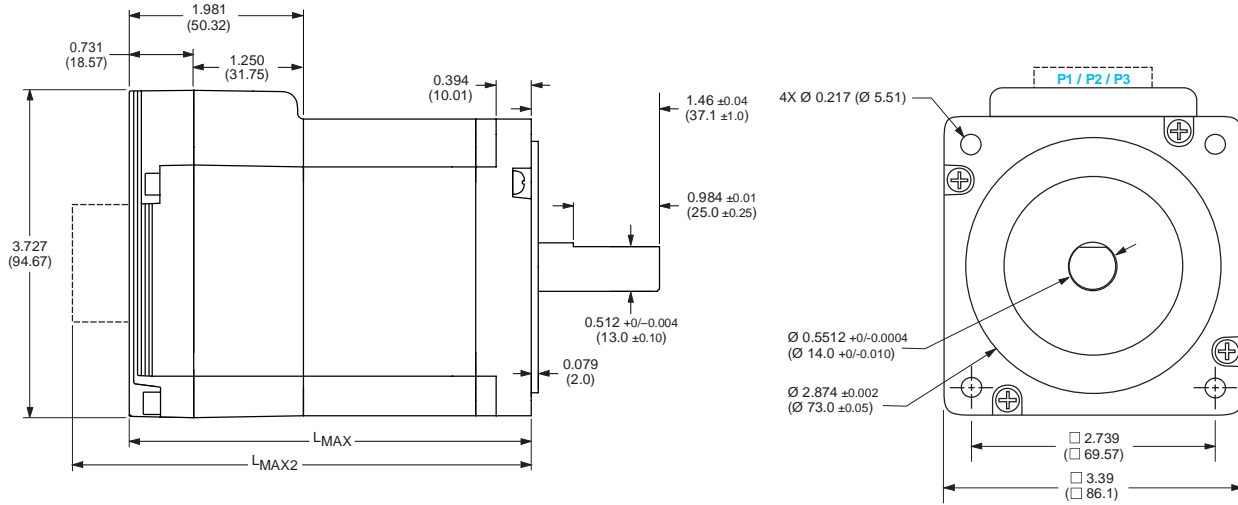

Motor stack length	Lmax (1)	Lmax2 (2)
Single	3.81 (96.77)	4.52 (114.81)
Double	4.60 (116.84)	5.31 (134.87)
Triple	6.17 (156.72)	6.88 (174.75)

(1) Single shaft or internal encoder.
(2) Control knob.

Connector options

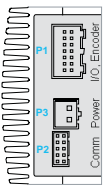

Pluggable interface version:
14-pin* and 2-pin locking wire crimp and
10-pin friction lock wire crimp connectors

* 14-pin replaced by 20-pin locking wire crimp
connector when optional remote encoder is
included

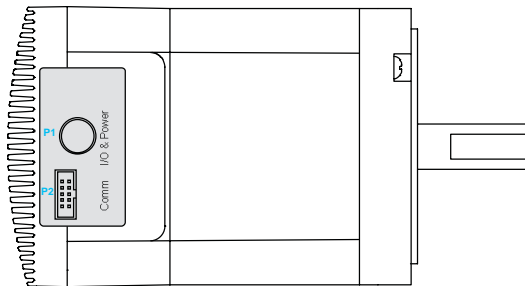

Flying leads interface version:
12" (305mm) flying leads with
10-pin non-locking IDC connector

Lmax2 option



Dimensions

MDrive® 34 ac Plus

Motion Control
fully programmable

– Plus² with industrial connectors – mechanical specifications, dimensions in inches (mm)

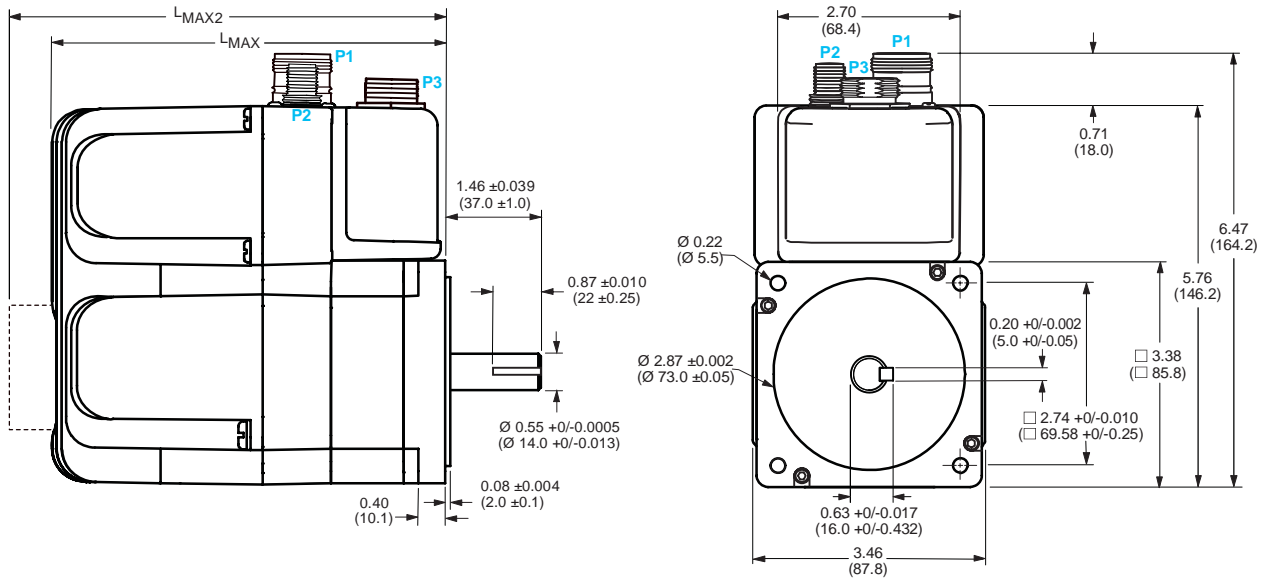

Motor stack length	Lmax (1)	Lmax2 (2)
Single	6.1 (155.0)	7.1 (180.4)
Double	6.9 (174.3)	7.9 (199.7)
Triple	8.4 (214.3)	9.4 (239.7)

(1) Single shaft or internal encoder.
(2) Control knob.

Connectors

I/O, Remote Encoder



P1: 19-pin M23 (male) industrial connector

Communication

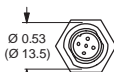

P2: 5-pin M12 (female) industrial connector

Power



P3: 3-pin Euro AC (male) industrial connector

Lmax2 option

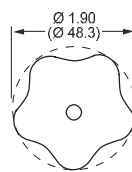

control knob

Connectivity

MDrive® 14 Plus

Motion Control

fully programmable

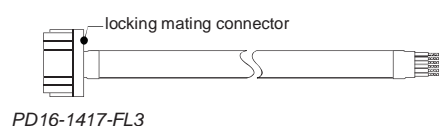
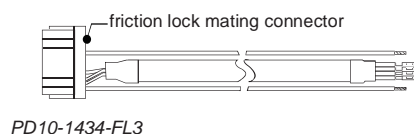
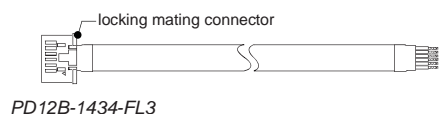
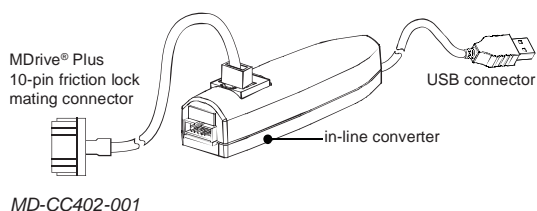
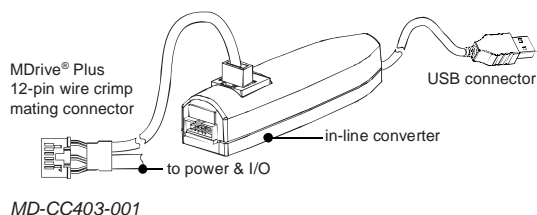

Installation accessories

Description	Length feet (m)	Part number
-------------	-----------------	-------------

QuickStart Kit

For rapid design verification, all-inclusive QuickStart Kits include connectivity, instructions and CD for MDrive Plus initial functional setup and system testing.

- For MDrive14 Motion Control products — add "K" to part number (1)

Communication converter

Electrically isolated, in-line converter pre-wired with mating connector to conveniently set/program communication parameters for a single MDrive Plus via a PC's USB port.

■ Mates to 12-pin locking wire crimp connector	12.0 (3.6)	MD-CC403-001
■ Mates to 10-pin friction lock wire crimp connector	12.0 (3.6)	MD-CC402-001

Prototype development cable

Speed test/development with pre-wired mating connector with other cable end open.

■ Mates to 12-pin locking wire crimp connector for I/O, communication and power	10.0 (3.0)	PD12B-1434-FL3
■ Mates to 10-pin friction lock wire crimp connector for communication	10.0 (3.0)	PD10-1434-FL3
■ Mates to 16-pin locking wire crimp connector for I/O, power and remote encoder option	10.0 (3.0)	PD16-1417-FL3

Mating connector kit

Connectors for assembly of cables, cable material not supplied. Sold in lots of 5. Manufacturer's crimp tool recommended for crimp connectors.

■ 12-pin locking wire crimp connector for I/O, communication and power	—	CK-08
■ 10-pin friction lock wire crimp connector for communication	—	CK-02
■ 16-pin locking wire crimp connector for I/O, power and remote encoder option	—	CK-10

Drive protection module

Limits surge current and voltage to a safe level when DC input power is switched on-and-off to an MDrive Plus.

■ For all MDrive14 Motion Control products	—	DPM75
--	---	-------

(1) See page 36.



Connectivity details: www.imshome.com/connect.html

Connectivity

MDrive® 17 Plus

Motion Control

fully programmable

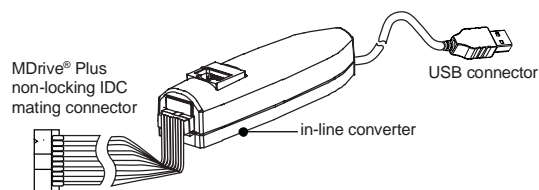

MD-CC400-001

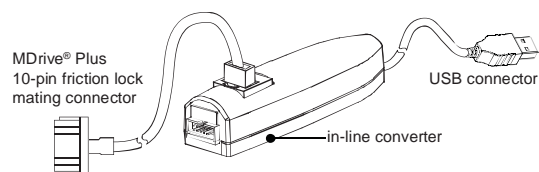

MD-CC402-001

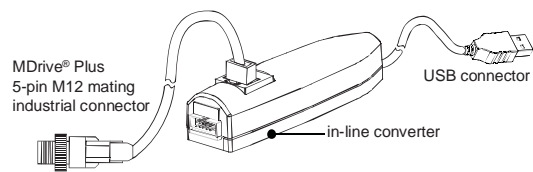

MD-CC401-001

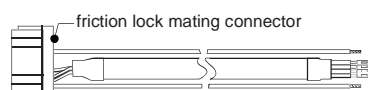

PD10-1434-FL3

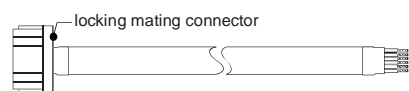

PD16-1417-FL3

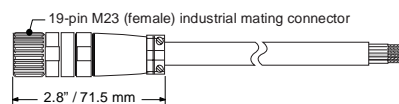

MD-CS100-000

Installation accessories

Description	Length feet (m)	Part number
-------------	-----------------	-------------

QuickStart Kit

For rapid design verification, all-inclusive QuickStart Kits include connectivity, instructions and CD for MDrive Plus initial functional setup and system testing.

- For MDrive17 Motion Control products — add "K" to part number (1)

Communication converter

Electrically isolated, in-line converter pre-wired with mating connector to conveniently set/program communication parameters for a single MDrive Plus via a PC's USB port.

■ Mates to 10-pin non-locking IDC connector	12.0 (3.6)	MD-CC400-001
■ Mates to 10-pin friction lock wire crimp connector	12.0 (3.6)	MD-CC402-001
■ Mates to 5-pin female M12 industrial connector	12.0 (3.6)	MD-CC401-001

Prototype development cable

Speed test/development with pre-wired mating connector with other cable end open.

■ Mates to 10-pin friction lock wire crimp connector for communication	10.0 (3.0)	PD10-1434-FL3
■ Mates to 16-pin locking wire crimp connector for I/O, power and remote encoder option	10.0 (3.0)	PD16-1417-FL3
■ Mates to 19-pin male M23 industrial connector with straight termination for I/O, power and remote encoder option	13.0 (4.0)	MD-CS100-000
■ Mates to 19-pin male M23 industrial connector with right angle termination for I/O, power and remote encoder option	13.0 (4.0)	MD-CS101-000

Mating connector kit

Connectors for assembly of cables, cable material not supplied. Sold in lots of 5. Manufacturer's crimp tool recommended for crimp connectors.

■ 10-pin friction lock wire crimp connector for communication	—	CK-02
■ 10-pin non-locking IDC connector for communication	—	CK-01
■ 16-pin locking wire crimp connector for I/O, power and remote encoder option	—	CK-10

Drive protection module

Limits surge current and voltage to a safe level when DC input power is switched on-and-off to an MDrive Plus.

- For all MDrive17 Motion Control products — DPM75

(1) See page 37.



Connectivity details: www.imshome.com/connect.html

Connectivity

MDrive® 23 Plus

Motion Control

fully programmable

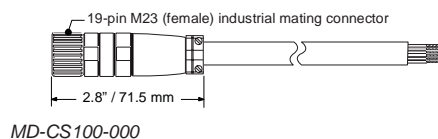
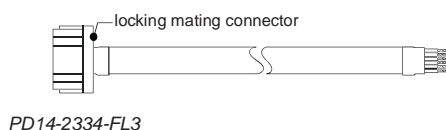
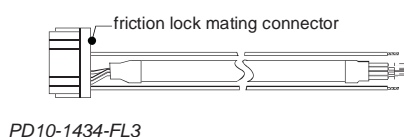
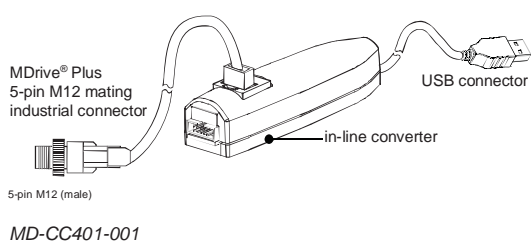
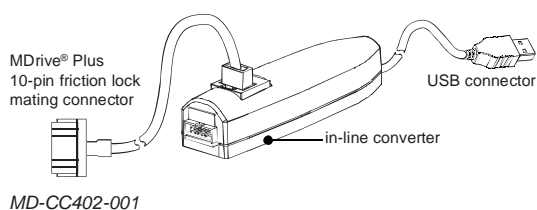
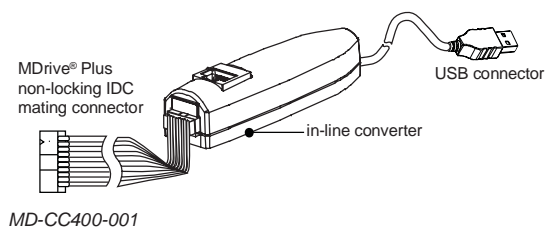

Installation accessories

Description	Length feet (m)	Part number
-------------	-----------------	-------------

QuickStart Kit

For rapid design verification, all-inclusive QuickStart Kits include connectivity, instructions and CD for MDrive Plus initial functional setup and system testing.

- For MDrive23 Motion Control products — add "K" to part number (1)

Communication converter

Electrically isolated, in-line converter pre-wired with mating connector to conveniently set/program communication parameters for a single MDrive Plus via a PC's USB port.

■ Mates to 10-pin non-locking IDC connector	12.0 (3.6)	MD-CC400-001
■ Mates to 10-pin friction lock wire crimp connector	12.0 (3.6)	MD-CC402-001
■ Mates to 5-pin female M12 industrial connector	12.0 (3.6)	MD-CC401-001

Prototype development cable

Speed test/development with pre-wired mating connector with other cable end open.

■ Mates to 10-pin friction lock wire crimp connector for communication	10.0 (3.0)	PD10-1434-FL3
■ Mates to 14-pin locking wire crimp connector for I/O and remote encoder option	10.0 (3.0)	PD14-2334-FL3
■ Mates to 2-pin locking wire crimp connector for power	10.0 (3.0)	PD02-2300-FL3
■ Mates to 19-pin male M23 industrial connector with straight termination for I/O, power and remote encoder option	13.0 (4.0)	MD-CS100-000
■ Mates to 19-pin male M23 industrial connector with right angle termination for I/O, power and remote encoder option	13.0 (4.0)	MD-CS101-000

Mating connector kit

Connectors for assembly of cables, cable material not supplied. Sold in lots of 5. Manufacturer's crimp tool recommended for crimp connectors.

■ 10-pin friction lock wire crimp connector for communication	—	CK-02
■ 10-pin non-locking IDC connector for communication	—	CK-01
■ 14-pin locking wire crimp connector for I/O and remote encoder option	—	CK-09
■ 2-pin locking wire crimp connector for power	—	CK-04

Drive protection module

Limits surge current and voltage to a safe level when DC input power is switched on-and-off to an MDrive Plus.

- For all MDrive23 Motion Control products — DPM75

(1) See page 38.

Connectivity

MDrive® 34 Plus

Motion Control

fully programmable

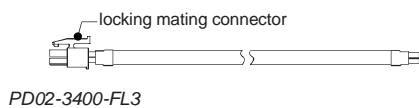
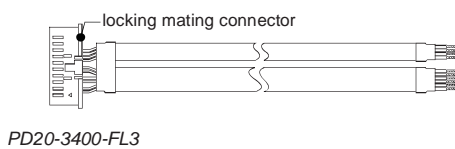
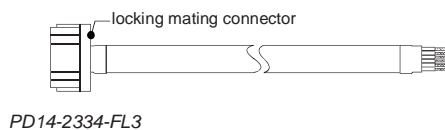
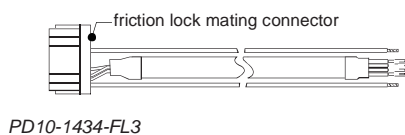
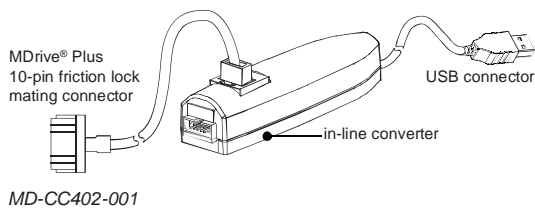
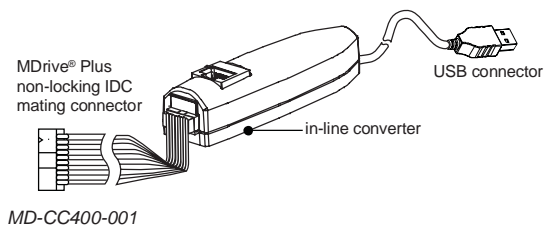

Installation accessories

Description	Length feet (m)	Part number
-------------	-----------------	-------------

QuickStart Kit

For rapid design verification, all-inclusive QuickStart Kits include connectivity, instructions and CD for MDrive Plus initial functional setup and system testing.

- For MDrive34 Motion Control products — add "K" to part number (1)

Communication converter

Electrically isolated, in-line converter pre-wired with mating connector to conveniently set/program communication parameters for a single MDrive Plus via a PC's USB port.

- | | | |
|--|------------|--------------|
| ■ Mates to 10-pin non-locking IDC connector | 12.0 (3.6) | MD-CC400-001 |
| ■ Mates to 10-pin friction lock wire crimp connector | 12.0 (3.6) | MD-CC402-001 |

Prototype development cable

Speed test/development with pre-wired mating connector with other cable end open.

- | | | |
|--|------------|---------------|
| ■ Mates to 10-pin friction lock wire crimp connector for communication | 10.0 (3.0) | PD10-1434-FL3 |
| ■ Mates to 14-pin locking wire crimp connector for I/O and optional internal encoder | 10.0 (3.0) | PD14-2334-FL3 |
| ■ Mates to 20-pin locking wire crimp connector for I/O and remote encoder option | 10.0 (3.0) | PD20-3400-FL3 |
| ■ Mates to 2-pin locking wire crimp connector for power | 10.0 (3.0) | PD02-3400-FL3 |

Mating connector kit

Connectors for assembly of cables, cable material not supplied. Sold in lots of 5. Manufacturer's crimp tool recommended for crimp connectors.

- | | | |
|---|---|-------|
| ■ 10-pin friction lock wire crimp connector for communication | — | CK-02 |
| ■ 14-pin locking wire crimp connector for I/O and optional internal encoder | — | CK-09 |
| ■ 20-pin locking wire crimp connector for I/O and remote encoder option | — | CK-11 |
| ■ 2-pin locking wire crimp connector for power | — | CK-05 |
| ■ 10-pin non-locking IDC connector for communication | — | CK-01 |

Drive protection module

Limits surge current and voltage to a safe level when DC input power is switched on-and-off to an MDrive Plus.

- | | | |
|--|---|-------|
| ■ For all MDrive34 Motion Control products | — | DPM75 |
|--|---|-------|

(1) See page 39.



Connectivity details: www.imshome.com/connect.html

Connectivity

MDrive® 34 ac Plus

Motion Control

fully programmable

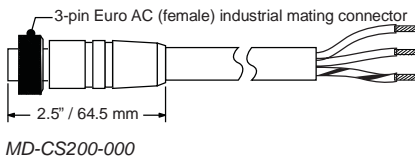
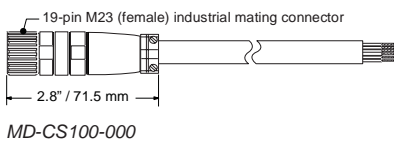
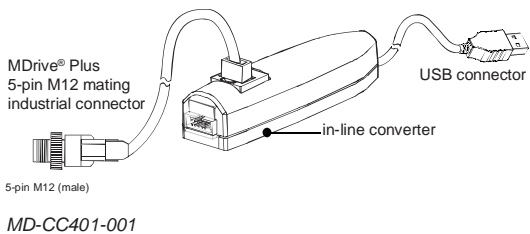

Installation accessories

Description	Length feet (m)	Part number
-------------	-----------------	-------------

QuickStart Kit

For rapid design verification, all-inclusive QuickStart Kits include connectivity, instructions and CD for MDrive Plus initial functional setup and system testing.

- For MDrive34ac Motion Control products — add "K" to part number (1)

Communication converter

Electrically isolated, in-line converter pre-wired with mating connector to conveniently set/program communication parameters for a single MDrive Plus via a PC's USB port.

- Mates to 5-pin female M12 industrial connector 12.0 (3.6) MD-CC401-001

Prototype development cable

Speed test/development with pre-wired mating connector with other cable end open.

- Mates to 19-pin male M23 industrial connector with straight termination for I/O and remote encoder option 13.0 (4.0) MD-CS100-000
- Mates to 19-pin male M23 industrial connector with right angle termination for I/O and remote encoder option 13.0 (4.0) MD-CS101-000
- Mates to 3-pin male Euro AC industrial connector with straight termination for power 13.0 (4.0) MD-CS200-000
- Mates to 3-pin male Euro AC industrial connector with right angle termination for power 13.0 (4.0) MD-CS201-000

(1) See page 40.



Connectivity details: www.imshome.com/connect.html

Part numbers

MDrive® 14 Plus

Motion Control

fully programmable

MDrive® 14 Plus



P1: I/O, Power & Communication
C = 12-pin locking wire crimp connector

MDrive® 14 Plus²



P1: I/O & Power, and optional remote encoder
C = 16-pin locking wire crimp connector

P2: Communication
L = RS-422/485 with 10-pin friction lock wire crimp connector

Part numbers

Example:	K	M	D	I	1	C	R	Z	1	4	A	4	-EQ
QuickStart Kit K = kit option, or leave blank if not wanted	K	M	D	I	1	C	R	Z	1	4	A	4	-EQ
MDrive Plus version MDI = Motion Control	K	M	D	I	1	C	R	Z	1	4	A	4	-EQ
Input 1 = Plus, standard features 3 = Plus ² , expanded features	K	M	D	I	1	C	R	Z	1	4	A	4	-EQ
P1 connector C = wire crimp	K	M	D	I	1	C	R	Z	1	4	A	4	-EQ
Communication R = RS-422/485	K	M	D	I	1	C	R	Z	1	4	A	4	-EQ
P2 connector Z = none (only for Plus products) L = wire crimp (only for Plus ² products)	K	M	D	I	1	C	R	Z	1	4	A	4	-EQ
Motor size 14 = NEMA 14 (1.4" / 36 mm)	K	M	D	I	1	C	R	Z	1	4	A	4	-EQ
Motor length A = single stack C = triple stack	K	M	D	I	1	C	R	Z	1	4	A	4	-EQ
Drive voltage 4 = +12 to +48 VDC	K	M	D	I	1	C	R	Z	1	4	A	4	-EQ
Options Leave blank if not wanted Options may be combined, unless noted													-EQ
-EQ	= internal encoder, 512-line internal magnetic encoder with index mark												
-EE	= remote encoder interface, differential encoder to be provided by user <i>Available with Plus² versions only. May not be combined with internal encoder option.</i>												
-N	= rear control knob for manual positioning												



Easy MDrive part numbers via an interactive tool at:
www.imshome.com/MDrivePlus.html

Part numbers

MDrive® 17 Plus

Motion Control

fully programmable

MDrive® 17 Plus

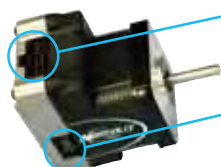

P1: I/O & Power

F = 12" flying leads
P = non-locking spring clamp terminal strip

P2: Communication

D = RS-422/485 with 10-pin IDC non-locking connector
L = RS-422/485 with 10-pin friction lock wire crimp connector

MDrive® 17 Plus²

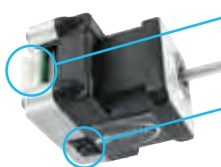

P1: I/O & Power, and optional remote encoder

C = 16-pin locking wire crimp connector

P2: Communication

D = RS-422/485 with 10-pin IDC non-locking connector
L = RS-422/485 with 10-pin friction lock wire crimp connector

MDrive® 17 Plus² with industrial connectors

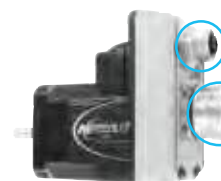

P2: Communication

Q = RS-422/485 with 5-pin M12 female industrial connector

P1: I/O & Power, and optional remote encoder

M = 19-pin M23 male industrial connector

Part numbers

Example:	K	M	D	I	1	F	R	D	1	7	A	4	-EQ
QuickStart Kit K = kit option, or leave blank if not wanted	K	M	D	I	1	F	R	D	1	7	A	4	-EQ
MDrive Plus version MDI = Motion Control	K	M	D	I	1	F	R	D	1	7	A	4	-EQ
Input 1 = Plus, standard features 3 = Plus ² , expanded features 4 = Plus ² , expanded features, with industrial connectors, IP54-rated	K	M	D	I	1	F	R	D	1	7	A	4	-EQ
P1 connector F = flying leads P = pluggable C = wire crimp (1) M = M23 industrial connector (2)	K	M	D	I	1	F	R	D	1	7	A	4	-EQ
Communication R = RS-422/485	K	M	D	I	1	F	R	D	1	7	A	4	-EQ
P2 connector D = IDC L = wire crimp Q = M12 industrial connector (2)	K	M	D	I	1	F	R	D	1	7	A	4	-EQ
Motor size 17 = NEMA 17 (1.7" / 42 mm)	K	M	D	I	1	F	R	D	1	7	A	4	-EQ
Motor length A = single stack B = double stack C = triple stack	K	M	D	I	1	F	R	D	1	7	A	4	-EQ
Drive voltage 4 = +12 to +48 VDC	K	M	D	I	1	F	R	D	1	7	A	4	-EQ
Options Leave blank if not wanted Options may be combined, unless noted													-EQ
-EQ = internal encoder, 512-line internal magnetic encoder with index mark													
-EE = remote encoder interface, differential encoder to be provided by user <i>Available with Plus² versions only. May not be combined with internal encoder option.</i>													
-N = rear control knob for manual positioning (3)													

(1) Only available with Plus² products without industrial connectors.

(2) Only available with Plus² products with industrial connectors.

(3) Not available with industrial connector products.



Easy MDrive part numbers via an interactive tool at:
www.imshome.com/MDrivePlus.html

Part numbers

MDrive® 23 Plus

Motion Control

fully programmable

MDrive® 23 Plus



P1: I/O & Power

F = 12" flying leads
P = non-locking spring clamp terminal strip

P2: Communication

D = RS-422/485 with 10-pin IDC non-locking connector
L = RS-422/485 with 10-pin friction lock wire crimp connector

MDrive® 23 Plus²

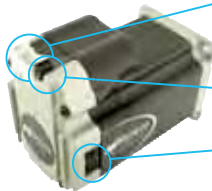

P1: I/O, and optional remote encoder

C = 14-pin locking wire crimp connector

P3: Power

2-pin locking wire crimp connector

P2: Communication

D = RS-422/485 with 10-pin IDC non-locking connector
L = RS-422/485 with 10-pin friction lock wire crimp connector
R = Ethernet with RJ45 locking connector

MDrive® 23 Plus² with industrial connectors



P2: Communication

Q = RS-422/485 with 5-pin M12 female industrial connector

P1: I/O & Power, and optional remote encoder

M = 19-pin M23 male industrial connector

Part numbers

Example:	K	M	D	I	1	F	R	D	2	3	A	7	-EQ
QuickStart Kit K = kit option, or leave blank if not wanted	K	M	D	I	1	F	R	D	2	3	A	7	-EQ
MDrive Plus version MDI = Motion Control	K	M	D	I	1	F	R	D	2	3	A	7	-EQ
Input 1 = Plus, standard features 3 = Plus ² , expanded features 4 = Plus ² , expanded features, with industrial connectors, IP54-rated	K	M	D	I	1	F	R	D	2	3	A	7	-EQ
P1 connector F = flying leads P = pluggable C = wire crimp (1) M = M23 industrial connector (2)	K	M	D	I	1	F	R	D	2	3	A	7	-EQ
Communication R = RS-422/485 E = Ethernet (3)	K	M	D	I	1	F	R	D	2	3	A	7	-EQ
P2 connector D = IDC L = wire crimp R = RJ45 (3) Q = M12 industrial connector (2)	K	M	D	I	1	F	R	D	2	3	A	7	-EQ
Motor size 23 = NEMA 23 (2.3" / 57 mm)	K	M	D	I	1	F	R	D	2	3	A	7	-EQ
Motor length (4) A = single stack B = double stack C = triple stack D = quad stack	K	M	D	I	1	F	R	D	2	3	A	7	-EQ
Drive voltage (4) 7 = +12 to +75 VDC 6 = +12 to +60 VDC	K	M	D	I	1	F	R	D	2	3	A	7	-EQ
Options Leave blank if not wanted Options may be combined, unless noted													-EQ
-EQ	= internal encoder, 512-line internal magnetic encoder with index mark												
-EE	= remote encoder interface, differential encoder to be provided by user <i>Available with Plus² versions only. May not be combined with internal encoder option.</i>												
-N	= rear control knob for manual positioning (5)												

(1) Only available with Plus² products without industrial connectors.

(2) Only available with Plus² products with industrial connectors.

(3) Only available with products with Ethernet protocol.

(4) Only quad stack motors have +12 to +60 VDC drives, all other motors have +12 to +75 VDC drives.

(5) Not available with Ethernet or industrial connector products.



Easy MDrive part numbers via an interactive tool at:
www.imshome.com/MDrivePlus.html

Part numbers

MDrive® 34 Plus

Motion Control

fully programmable

MDrive® 34 Plus
flying leads interface

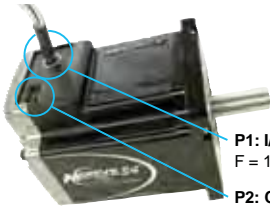

- P1: I/O & Power**
F = 12" flying leads
- P2: Communication**
D = RS-422/485 with 10-pin IDC non-locking connector
L = RS-422/485 with 10-pin friction lock wire crimp connector

MDrive® 34 Plus²
pluggable interface

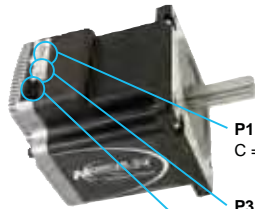

- P1: I/O, and optional remote encoder**
C = 14-pin locking wire crimp connector (20-pin with remote encoder option)
- P3: Power**
2-pin locking wire crimp connector
- P2: Communication**
L = RS-422/485 with 10-pin friction lock wire crimp connector

Part numbers

Example:	K	M	D	I	1	F	R	D	3	4	A	7	-EQ
QuickStart Kit K = kit option, or leave blank if not wanted	K	M	D	I	1	F	R	D	3	4	A	7	-EQ
MDrive Plus version MDI = Motion Control	K	M	D	I	1	F	R	D	3	4	A	7	-EQ
Input 1 = Plus, standard features 3 = Plus ² , expanded features	K	M	D	I	1	F	R	D	3	4	A	7	-EQ
P1 connector F = flying leads (1) C = pluggable (2)	K	M	D	I	1	F	R	D	3	4	A	7	-EQ
Communication R = RS-422/485	K	M	D	I	1	F	R	D	3	4	A	7	-EQ
P2 connector D = IDC (1) L = wire crimp	K	M	D	I	1	F	R	D	3	4	A	7	-EQ
Motor size 34 = NEMA 34 (3.4" / 86 mm)	K	M	D	I	1	F	R	D	3	4	A	7	-EQ
Motor length A = single stack B = double stack C = triple stack	K	M	D	I	1	F	R	D	3	4	A	7	-EQ
Drive voltage 7 = +12 to +75 VDC	K	M	D	I	1	F	R	D	3	4	A	7	-EQ
Options Leave blank if not wanted Options may be combined, unless noted													-EQ
-EQ	= internal encoder, 512-line internal magnetic encoder with index mark												
-EE	= remote encoder interface, differential encoder to be provided by user <i>Available with Plus² versions only. May not be combined with internal encoder option.</i>												
-N	= rear control knob for manual positioning												

(1) Only available with Plus products.
 (2) Only available with Plus² products.

 Easy MDrive part numbers via an interactive tool at:
www.imshome.com/MDrivePlus.html

Part numbers

MDrive® 34 ac Plus

Motion Control

fully programmable

MDrive® 34ac Plus²

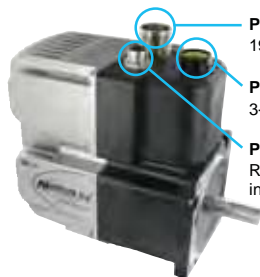

P1: I/O, and optional remote encoder
19-pin M23 male industrial connector

P3: Integrated Power Supply
3-pin Euro AC male industrial connector

P2: Communication
RS-422/485 with 5-pin M12 female industrial connector

Part numbers

Example:	K	M	D	I	4	M	R	Q	3	4	A	1	-EQ
QuickStart Kit K = kit option, or leave blank if not wanted	K	M	D	I	4	M	R	Q	3	4	A	1	-EQ
MDrive Plus version MDI = Motion Control	K	M	D	I	4	M	R	Q	3	4	A	1	-EQ
Input 4 = Plus ² , expanded features, with industrial connectors, IP54-rated	K	M	D	I	4	M	R	Q	3	4	A	1	-EQ
P1 connector M = M23 industrial connector	K	M	D	I	4	M	R	Q	3	4	A	1	-EQ
Communication R = RS-422/485	K	M	D	I	4	M	R	Q	3	4	A	1	-EQ
P2 connector Q = M12 industrial connector	K	M	D	I	4	M	R	Q	3	4	A	1	-EQ
Motor size 34 = NEMA 34 (3.4" / 86 mm)	K	M	D	I	4	M	R	Q	3	4	A	1	-EQ
Motor length A = single stack B = double stack C = triple stack	K	M	D	I	4	M	R	Q	3	4	A	1	-EQ
Drive voltage 1 = 120 VAC 2 = 240 VAC	K	M	D	I	4	M	R	Q	3	4	A	1	-EQ
Options Leave blank if not wanted Options may be combined, unless noted													-EQ
-EQ													= internal encoder, 512-line internal magnetic encoder with index mark
-EE													= remote encoder interface, differential encoder to be provided by user <i>May not be combined with internal encoder option.</i>
-N													= rear control knob for manual positioning (1)

(1) Not IP54-rated.



Easy MDrive part numbers via an interactive tool at:
www.imshome.com/MDrivePlus.html



Combining Today's Best Technologies

For Tomorrow's Break Through Discoveries

Phone: 877-478-3241

Phone: 877-IP-Tech1

Fax: 877-IP-Tech2

www.iptech1.com

MDrive[®] Plus
CANopen

Description

MDrive® Plus CANopen



MDrive® Plus CANopen

Presentation

The MDrive® Plus with CANopen interface is a 1.8° 2-phase stepper motor with on-board controller, drive electronics and optional encoder.

IMS CANopen firmware is provided for MDrive Plus CANopen products, in addition to CANopen Tester GUI software for interface with the MD-CC500-000 CANopen dongle.

MDrive Plus CANopen products support CiA DS301 and DSP402 Device Profile for Drives and Motion Control.

Application areas

The MDrive Plus with CANopen interface is ideal for machine builders who want an optimized motor with on-board electronics. The integrated electronics of the MDrive Plus with CANopen interface reduces the potential for problems due to electrical noise by eliminating the cable between motor and drive.

These compact, powerful and cost effective motion control solutions deliver unsurpassed smoothness and performance that will reduce system cost, design and assembly time for a large range of 2-phase stepper motor applications.

Features

Standard Plus

- Highly integrated microstepping drive and high torque 1.8° 2-phase stepper motor
- Advanced current control for exceptional performance and smoothness
- Single supply: from +12 up to +75 VDC or 120 and 240 VAC
- Cost effective
- Extremely compact
- 20 microstep resolutions to 51,200 steps/rev including: Degrees, Metric, Arc Minutes
- Auxiliary logic power supply input
- Open or optional closed loop control
- Programmable motor run and hold currents
- Four +5 to +24 VDC I/O lines accept sourcing or sinking outputs
- One 10 bit analog input selectable: 0 to +10 VDC, 0 to +5 VDC, 0-20 mA, 4-20 mA
- 0 to 5 MHz step clock rate selectable in 0.59 Hz increments
- CANopen communication
- Available options:
 - Long life linear actuators (1)
 - Hybrid Motion Technology™ (1)
 - Encoders
 - Control knob for manual positioning
 - Industrial connectors with IP54 rating (2)
- Several motor stack lengths available
- Graphical user interface provided for quick and easy configuration and programming

Expanded Plus²

- +24 VDC tolerant I/O sourcing or sinking, inputs and outputs with up to 8 I/O lines and electronic gearing
- Closed loop control available with external/ remote encoder option
- High speed position capture input or trip output

(1) See separate documentation.

(2) Industrial connectors are unavailable for MDrive14 or MDrive34 products.

Specifications

MDrive® Plus CANopen

Standard Plus specifications

		MDrive 14 (1)	MDrive 17	MDrive 23 (2)	MDrive 23 (2)	MDrive 34 (1)	MDrive 34ac (1)	
Input power	Voltage	VDC	12 to 48	12 to 48	12 to 75	12 to 60	12 to 75	
		VAC	—	—	—	—	120	
	Current maximum (3)		1A	2A	2A	3.5A	4A	
Thermal	Operating temp non-condensing	Heat sink	-40° to +85°C				-40° to +75°C	
		Motor	-40° to +100°C				-40° to +90°C	
Protection	Type	not applicable					- Thermal - Over voltage/ current	

Aux. logic input voltage	Range	+12 to +24 VDC <i>When input voltage is removed, maintains power only to control and feedback circuits.</i>		
Analog input	Resolution	10 bit		
	Voltage range	0 to +5 VDC, 0 to +10 VDC, 0-20 mA, 4-20 mA		
General purpose I/O	Number	4		
	Type	sourcing or sinking inputs, or sinking outputs		
	Logic range	Inputs and outputs tolerant to +24 VDC, inputs TTL level compatible		
	Output sink current	Up to 600 mA		
	Protection	Over temp, short circuit, transient over voltage, over voltage, inductive clamp		
Communication	Type	CANopen CiA DS301 (V3.0), DSP402 (V2.0), 2.0B active (4)		
	Baud rate	Configurable 5 KB to 1 Mb		
	ID	11 and/or 29 bit		
	Isolation	Galvanic		
Motion	Features	Node guarding, heartbeat, SDOs, PDOs (variable mapping)		
		Open loop configuration	Number of settings	20
		Steps per revolution	200, 400, 800, 1000, 1600, 2000, 3200, 5000, 6400, 10000, 12800, 20000, 25000, 25600, 40000, 50000, 51200, 36000 (0.01 deg/μstep), 21600 (1 arc minute/μstep), 25400 (0.001mm/μstep)	
	Counters	Type	position, encoder/32 bit	
		Edge rate maximum	5 MHz	
	Velocity	Range	+/- 5,000,000 steps per second	
		Resolution	0.5961 steps per second	
	Accel/Decel	Range	1.5 x 10 ⁹ steps per second ²	
		Resolution	90.9 steps per second ²	
	Software	Setup parameters	Storable to nonvolatile memory	
Transmit PDOs		3 dynamically mappable		
Receive PDOs		3 dynamically mappable		
Manufacturer specific objects		I/O configuration, run/hold current		
Modes of operation		Profile position, homing mode, profile velocity		
Input functions		General purpose, homing mode profiles		
Output functions	General purpose			

Expanded Plus² specifications

General purpose I/O	Number	8 (or 4 when remote encoder option is selected)		
	Type	sourcing or sinking outputs/inputs		
	Logic range	Sourcing outputs +12 to +24 VDC, inputs and sinking outputs tolerant to +24 VDC, inputs TTL level compatible		
	Output sinking current	Up to 600 mA		
Motion	Electronic gearing	Range/resolution/ threshold – external clock in (4)	0.001 to 2.000/32 bit/TTL	
		Input filter range	50 nS to 12.9 μS (10 MHz to 38.8 kHz)	
		Range – secondary clock out (4)	1 to 1	
	High speed I/O	Position capture	Input filter range	50 nS to 12.9 μS (10 MHz to 38.8 kHz)
			Resolution	32 bit
	Trip output – speed/resolution/threshold	150 nS/32 bit/TTL		

(1) CANopen available only with Plus² versions of MDrive14, MDrive34 and MDrive34ac products.

(2) Only quad stack NEMA 23 motors have +12 to +60 VDC drives, all other NEMA 23 motors have +12 to +75 VDC drives.

(3) Actual power supply current will depend on voltage and load.

(4) Adjusting the microstep resolution can increase the range.



Dimensions

MDrive® 14 Plus CANopen

– Plus² – mechanical specifications, dimensions in inches (mm)

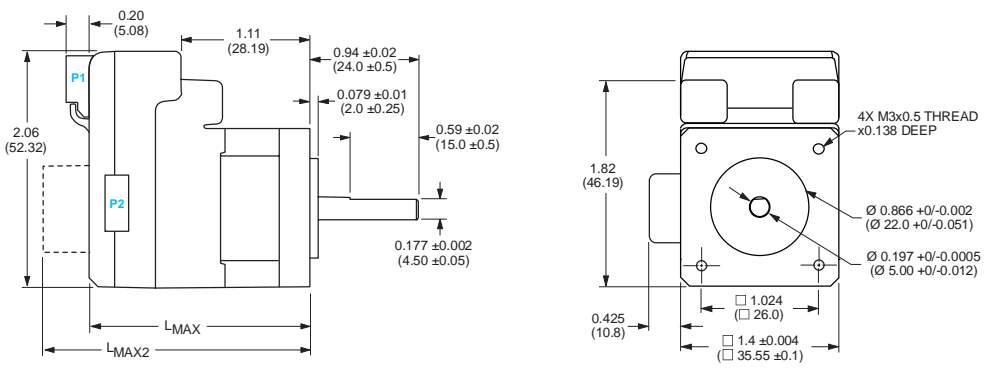

Motor stack length	Lmax (1)	Lmax2 (2)
Single	1.93 (49.02)	2.62 (66.55)
Triple	3.03 (76.96)	3.73 (94.74)

(1) Single shaft or internal encoder.
 (2) Control knob.

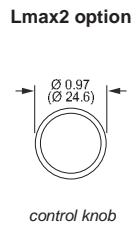
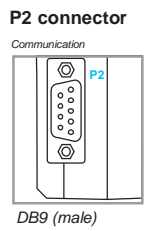
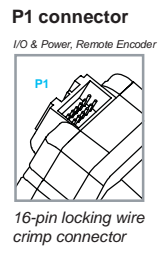

Dimensions

MDrive® 17 Plus CANopen

– Plus & Plus² – mechanical specifications, dimensions in inches (mm)

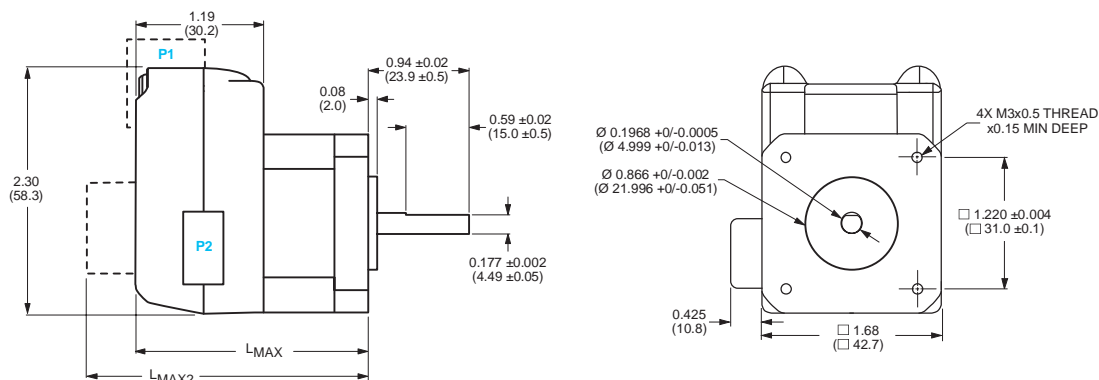

Motor stack length	Lmax (1)	Lmax2 (2)
Single	2.20 (55.9)	2.79 (70.9)
Double	2.43 (61.7)	3.02 (76.7)
Triple	2.77 (70.4)	3.37 (85.6)

(1) Single shaft or internal encoder.
(2) Control knob or external encoder.

P1 connector options

I/O & Power

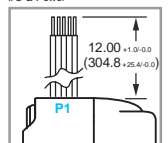

12.0" (305mm) flying leads

I/O & Power

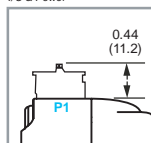

7-pin non-locking spring clamp terminal strip

only for Plus² I/O & Power, Remote Encoder

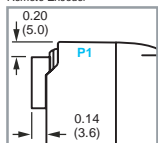

16-pin locking wire crimp connector

P2 connector

Communication

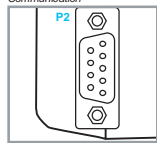

DB9 (male)

Lmax2 option

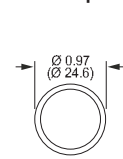

control knob

– Plus² with industrial connectors – mechanical specifications, dimensions in inches (mm)

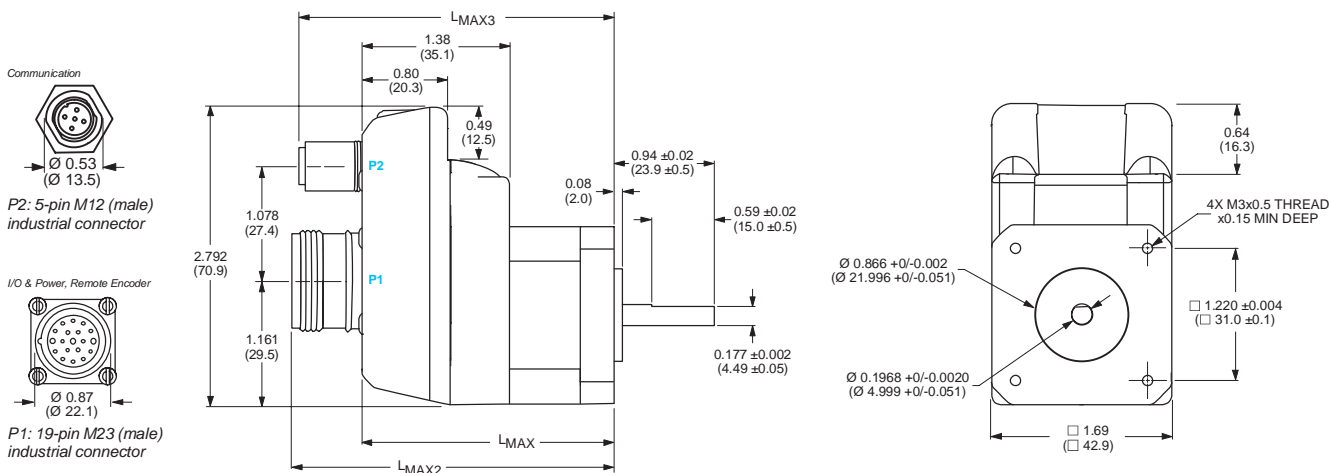

Motor stack length	Lmax	Lmax2	Lmax3
Single	2.48 (62.71)	3.15 (79.72)	3.08 (77.95)
Double	2.71 (68.55)	3.38 (85.57)	3.31 (83.79)
Triple	3.05 (77.18)	3.72 (94.20)	3.65 (92.42)

Dimensions

MDrive® 23 Plus
CANopen

– Plus & Plus² – mechanical specifications, dimensions in inches (mm)

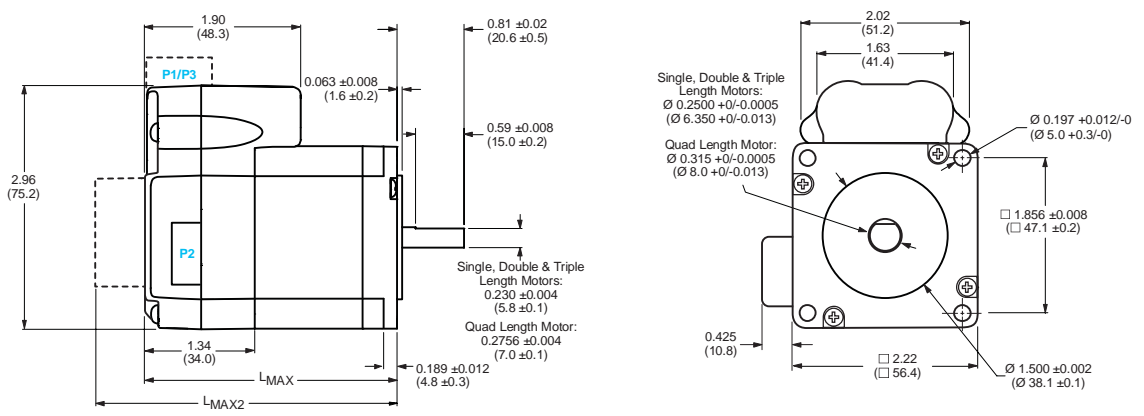

Motor stack length	Lmax (1)	Lmax2 (2)
Single	2.65 (67.31)	3.36 (85.34)
Double	3.02 (76.71)	3.73 (94.74)
Triple	3.88 (98.55)	4.59 (116.59)
Quad	5.28 (134.15)	5.99 (152.19)

(1) Single shaft or internal encoder.
(2) Control knob or external encoder.

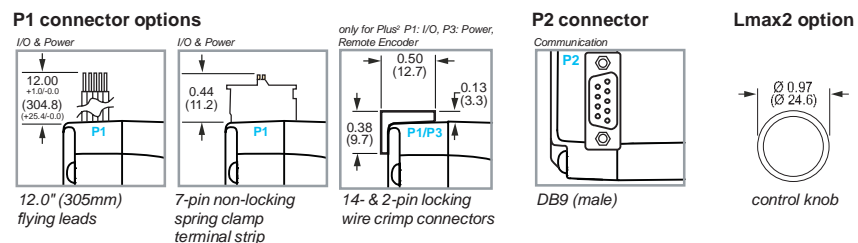

– Plus² with industrial connectors – mechanical specifications, dimensions in inches (mm)

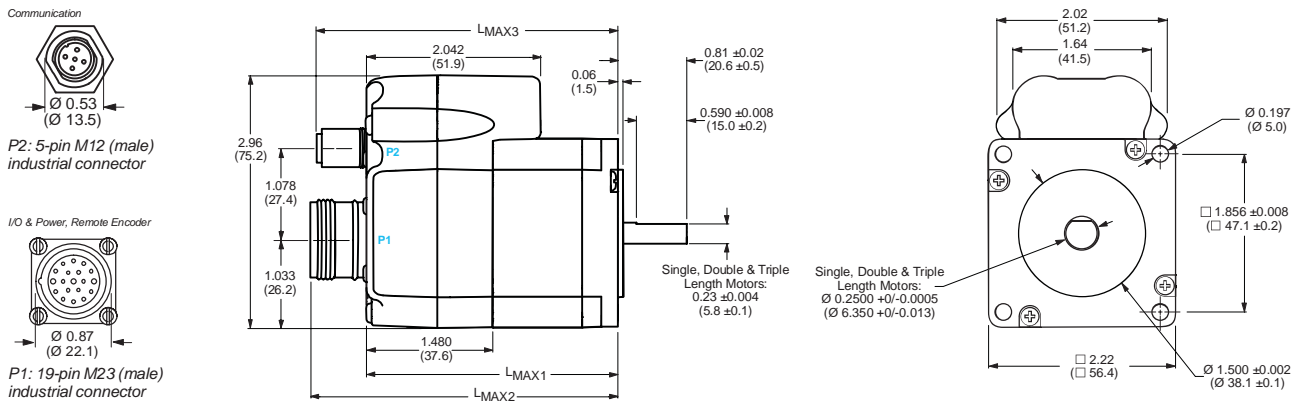

Motor stack length	Lmax	Lmax2	Lmax3
Single	2.91 (73.63)	3.57 (90.39)	3.51 (88.87)
Double	3.25 (82.26)	3.91 (99.03)	3.85 (97.5)
Triple	4.11 (104.11)	4.76 (120.62)	4.71 (119.35)

Dimensions

MDrive® 34 Plus CANopen

– Plus² – mechanical specifications, dimensions in inches (mm)

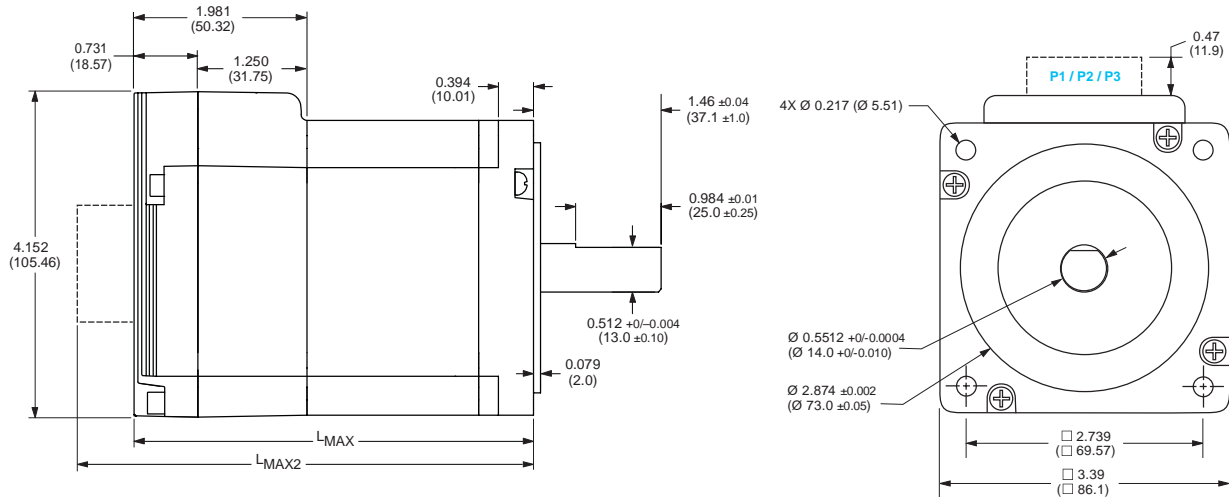

Motor stack length	Lmax (1)	Lmax2 (2)
Single	3.81 (96.77)	4.52 (114.81)
Double	4.60 (116.84)	5.31 (134.87)
Triple	6.17 (156.72)	6.88 (174.75)

(1) Single shaft or internal encoder.
(2) Control knob.

Connectors

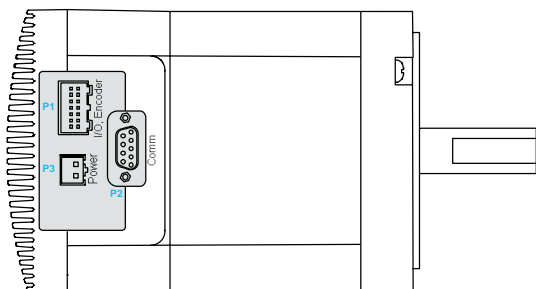

Lmax2 option

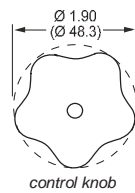

Pluggable interface version:
14-pin* and 2-pin locking wire crimp and
DB9 male connectors

* 14-pin replaced by 20-pin locking wire crimp
connector when optional remote encoder is
included

Dimensions

MDrive® 34 ac Plus CANopen

– Plus² with industrial connectors — mechanical specifications, dimensions in inches (mm)

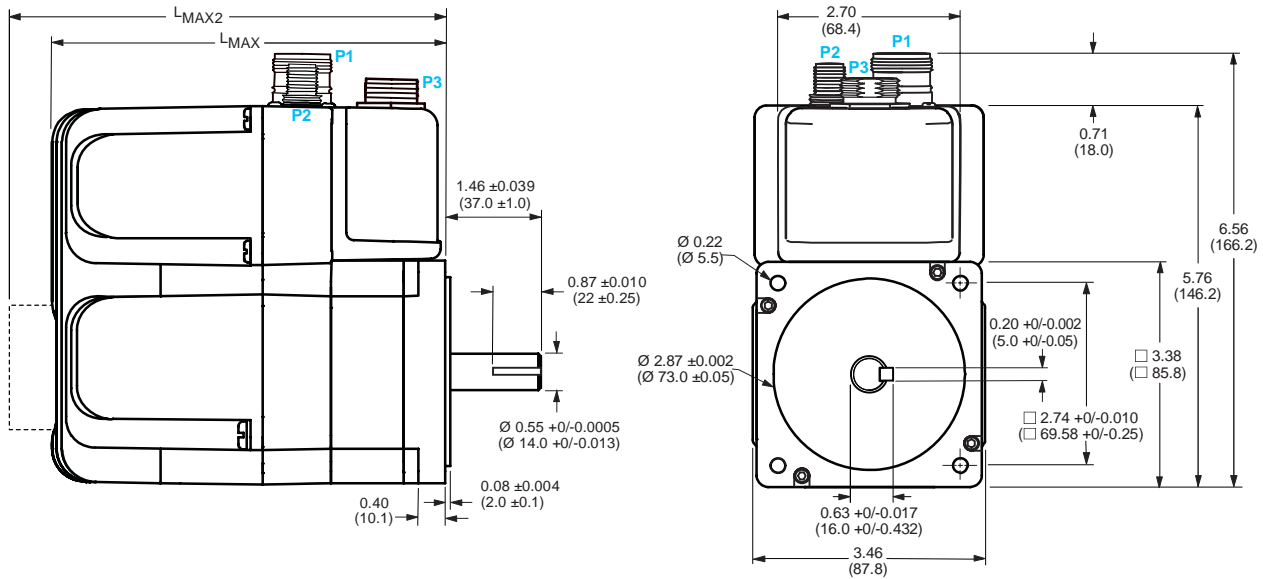

Motor stack length	Lmax (1)	Lmax2 (2)
Single	6.1 (155.0)	7.1 (180.4)
Double	6.9 (174.3)	7.9 (199.7)
Triple	8.4 (214.3)	9.4 (239.7)

(1) Single shaft or internal encoder.
(2) Control knob.

Connectors

I/O, Remote Encoder

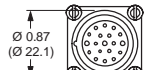

P1: 19-pin M23 (male) industrial connector

Communication

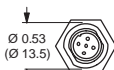

P2: 5-pin M12 (male) industrial connector

Power

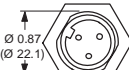

P3: 3-pin Euro AC (male) industrial connector

Lmax2 option

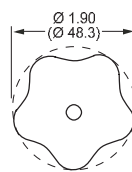

control knob

Connectivity

MDrive® 14 Plus CANopen

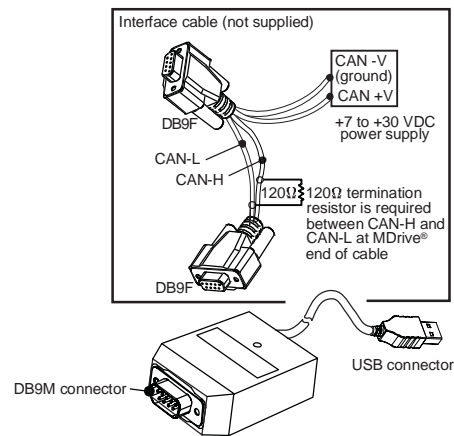

MD-CC500-000

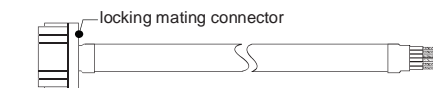

PD16-1417-FL3

Installation accessories

Description	Length feet (m)	Part number
Communication converter		
Electrically isolated, in-line converter pre-wired with mating connector to conveniently set/program communication parameters for a single MDrive Plus via a PC's USB port.		
<ul style="list-style-type: none"> Mates to DB9 connector (1) 	12.0 (3.6)	MD-CC500-000
Prototype development cable		
Speed test/development with pre-wired mating connector with other cable end open.		
<ul style="list-style-type: none"> Mates to 16-pin locking wire crimp connector for I/O, power and remote encoder option 	10.0 (3.0)	PD16-1417-FL3
Mating connector kit		
Connectors for assembly of cables, cable material not supplied. Sold in lots of 5. Manufacturer's crimp tool recommended for crimp connectors.		
<ul style="list-style-type: none"> 16-pin locking wire crimp connector for I/O, power and remote encoder option 	—	CK-10
Drive protection module		
Limits surge current and voltage to a safe level when DC input power is switched on-and-off to an MDrive Plus.		
<ul style="list-style-type: none"> For all MDrive14 CANopen products 	—	DPM75

(1) Requires mating connector adapter and power supply, not supplied.



Connectivity details: www.imshome.com/connect.html

Connectivity

MDrive® 17 Plus CANopen

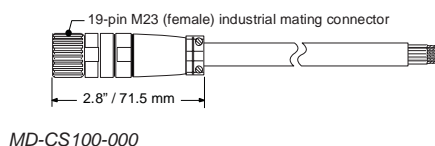
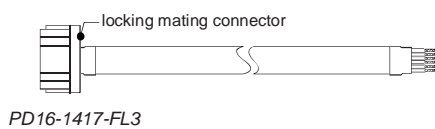
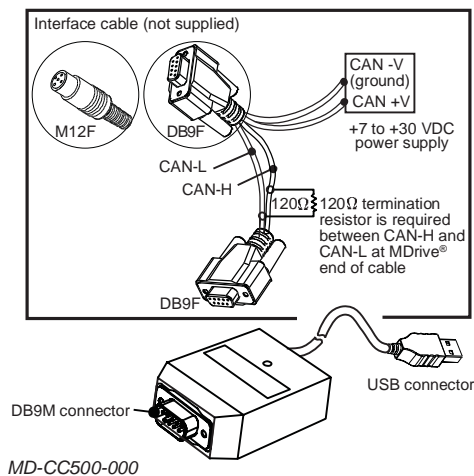

Installation accessories

Description	Length feet (m)	Part number
-------------	-----------------	-------------

Communication converter

Electrically isolated, in-line converter pre-wired with mating connector to conveniently set/program communication parameters for a single MDrive Plus via a PC's USB port.

■ Mates to DB9 connector (1)	12.0 (3.6)	MD-CC500-000
■ Mates to 5-pin male M12 industrial connector (1)	12.0 (3.6)	MD-CC500-000

Prototype development cable

Speed test/development with pre-wired mating connector with other cable end open.

■ Mates to 16-pin locking wire crimp connector for I/O, power and remote encoder option	10.0 (3.0)	PD16-1417-FL3
■ Mates to 19-pin male M23 industrial connector with straight termination for I/O, power and remote encoder option	13.0 (4.0)	MD-CS100-000
■ Mates to 19-pin male M23 industrial connector with right angle termination for I/O, power and remote encoder option	13.0 (4.0)	MD-CS101-000

Mating connector kit

Connectors for assembly of cables, cable material not supplied. Sold in lots of 5. Manufacturer's crimp tool recommended for crimp connectors.

■ 16-pin locking wire crimp connector for I/O, power and remote encoder option	—	CK-10
--	---	--------------

Drive protection module

Limits surge current and voltage to a safe level when DC input power is switched on-and-off to an MDrive Plus.

■ For all MDrive17 CANopen products	—	DPM75
-------------------------------------	---	--------------

(1) Requires mating connector adapter and power supply, not supplied.



Connectivity details: www.imshome.com/connect.html

Connectivity

MDrive® 23 Plus CANopen

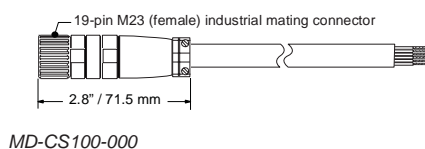
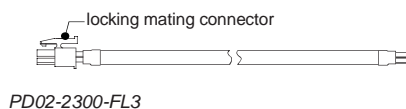
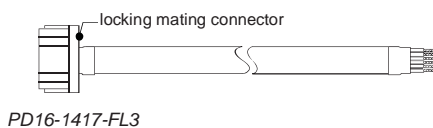
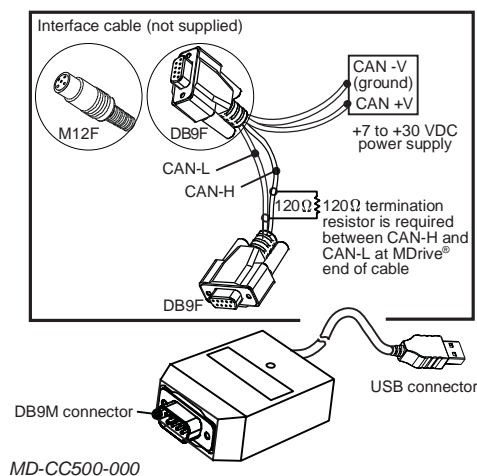

Installation accessories

Description	Length feet (m)	Part number
Communication converter		
Electrically isolated, in-line converter pre-wired with mating connector to conveniently set/program communication parameters for a single MDrive Plus via a PC's USB port.		
■ Mates to DB9 connector (1)	12.0 (3.6)	MD-CC500-000
■ Mates to 5-pin male M12 industrial connector (1)	12.0 (3.6)	MD-CC500-000
Prototype development cable		
Speed test/development with pre-wired mating connector with other cable end open.		
■ Mates to 14-pin locking wire crimp connector for I/O and remote encoder option	10.0 (3.0)	PD14-2334-FL3
■ Mates to 2-pin locking wire crimp connector for power	10.0 (3.0)	PD02-2300-FL3
■ Mates to 19-pin male M23 industrial connector with straight termination for I/O, power and remote encoder option	13.0 (4.0)	MD-CS100-000
■ Mates to 19-pin male M23 industrial connector with right angle termination for I/O, power and remote encoder option	13.0 (4.0)	MD-CS101-000
Mating connector kit		
Connectors for assembly of cables, cable material not supplied. Sold in lots of 5. Manufacturer's crimp tool recommended for crimp connectors.		
■ 14-pin locking wire crimp connector for I/O and remote encoder option	—	CK-09
■ 2-pin locking wire crimp connector for power	—	CK-04
Drive protection module		
Limits surge current and voltage to a safe level when DC input power is switched on-and-off to an MDrive Plus.		
■ For all MDrive23 CANopen products	—	DPM75

(1) Requires mating connector adapter and power supply, not supplied.



Connectivity details: www.imshome.com/connect.html

Connectivity

MDrive® 34 Plus CANopen

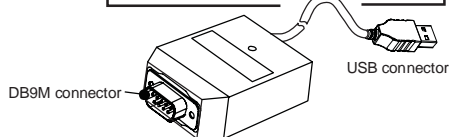
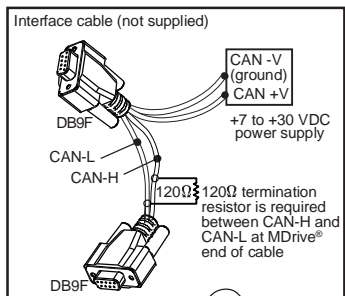

MD-CC500-000

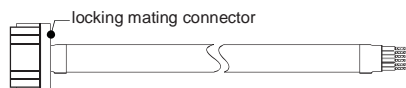

PD14-2334-FL3

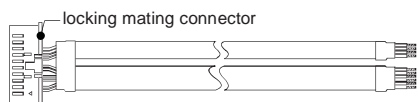

PD20-3400-FL3

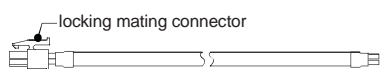

PD02-3400-FL3

Installation accessories

Description	Length feet (m)	Part number
-------------	-----------------	-------------

Communication converter

Electrically isolated, in-line converter pre-wired with mating connector to conveniently set/program communication parameters for a single MDrive Plus via a PC's USB port.

- Mates to DB9 connector (1) 12.0 (3.6) **MD-CC500-000**

Prototype development cable

Speed test/development with pre-wired mating connector with other cable end open.

- Mates to 14-pin locking wire crimp connector for I/O and optional internal encoder 10.0 (3.0) **PD14-2334-FL3**
- Mates to 20-pin locking wire crimp connector for I/O and remote encoder option 10.0 (3.0) **PD20-3400-FL3**
- Mates to 2-pin locking wire crimp connector for power 10.0 (3.0) **PD02-3400-FL3**

Mating connector kit

Connectors for assembly of cables, cable material not supplied. Sold in lots of 5. Manufacturer's crimp tool recommended for crimp connectors.

- 14-pin locking wire crimp connector for I/O and optional internal encoder — **CK-09**
- 20-pin locking wire crimp connector for I/O and remote encoder option — **CK-11**
- 2-pin locking wire crimp connector for power — **CK-05**

Drive protection module

Limits surge current and voltage to a safe level when DC input power is switched on-and-off to an MDrive Plus.

- For all MDrive34 CANopen products — **DPM75**

(1) Requires mating connector adapter and power supply, not supplied.



Connectivity details: www.imshome.com/connect.html

Connectivity

MDrive® 34 ac Plus CANopen

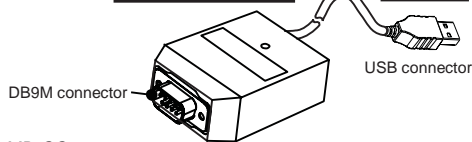
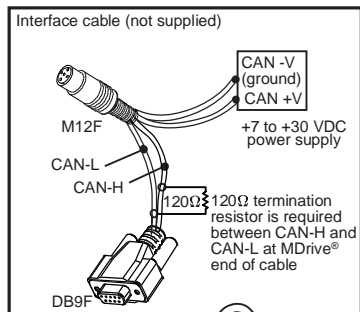

MD-CC500-000

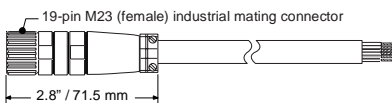

MD-CS100-000

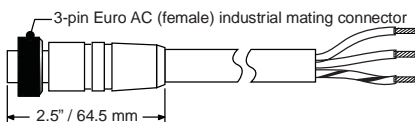

MD-CS200-000

Installation accessories

Description	Length feet (m)	Part number
Communication converter		
Electrically isolated, in-line converter pre-wired with mating connector to conveniently set/program communication parameters for a single MDrive Plus via a PC's USB port.		
<ul style="list-style-type: none"> Mates to 5-pin male M12 industrial connector (1) 	12.0 (3.6)	MD-CC500-000
Prototype development cable		
Speed test/development with pre-wired mating connector with other cable end open.		
<ul style="list-style-type: none"> Mates to 19-pin male M23 industrial connector with straight termination for I/O and remote encoder option 	13.0 (4.0)	MD-CS100-000
<ul style="list-style-type: none"> Mates to 19-pin male M23 industrial connector with right angle termination for I/O and remote encoder option 	13.0 (4.0)	MD-CS101-000
<ul style="list-style-type: none"> Mates to 3-pin male Euro AC industrial connector with straight termination for power 	13.0 (4.0)	MD-CS200-000
<ul style="list-style-type: none"> Mates to 3-pin male Euro AC industrial connector with right angle termination for power 	13.0 (4.0)	MD-CS201-000

(1) Requires mating connector adapter and power supply, not supplied.



Connectivity details: www.imshome.com/connect.html

Part numbers

MDrive® 14 Plus CANopen

MDrive® 14 Plus²



P1: I/O & Power, and optional remote encoder
C = 16-pin locking wire crimp connector

P2: Communication
B = CANopen with DB9 male connector

Part numbers

Part numbers	
Example:	M D I 3 C C B 1 4 A 4 -EQ
MDrive Plus version MDI = CANopen	M D I 3 C C B 1 4 A 4 -EQ
Input 3 = Plus ² , expanded features	M D I 3 C C B 1 4 A 4 -EQ
P1 connector C = wire crimp	M D I 3 C C B 1 4 A 4 -EQ
Communication C = CANopen	M D I 3 C C B 1 4 A 4 -EQ
P2 connector B = DB9	M D I 3 C C B 1 4 A 4 -EQ
Motor size 14 = NEMA 14 (1.4" / 36 mm)	M D I 3 C C B 1 4 A 4 -EQ
Motor length A = single stack C = triple stack	M D I 3 C C B 1 4 A 4 -EQ
Drive voltage 4 = +12 to +48 VDC	M D I 3 C C B 1 4 A 4 -EQ
Options Leave blank if not wanted Options may be combined, unless noted	-EQ
-EQ	= internal encoder, 512-line internal magnetic encoder with index mark
-EE	= remote encoder interface, differential encoder to be provided by user <i>May not be combined with internal encoder option.</i>
-N	= rear control knob for manual positioning



Easy MDrive part numbers via an interactive tool at:
www.imshome.com/MDrivePlus.html

Part numbers

MDrive® 17 Plus CANopen

MDrive® 17 Plus

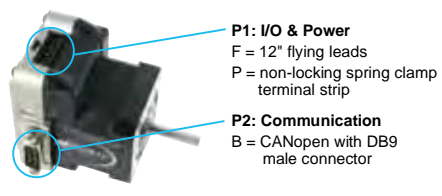

MDrive® 17 Plus²

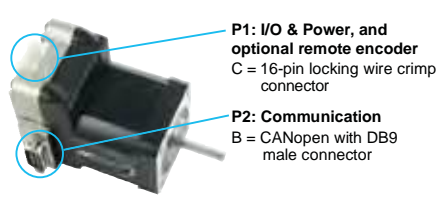

MDrive® 17 Plus²
with industrial connectors

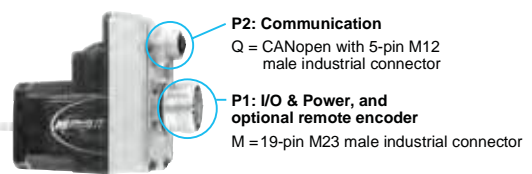

Part numbers												
Example:	M	D	I	1	F	C	B	1	7	A	4	-EQ
MDrive Plus version	M	D	I	1	F	C	B	1	7	A	4	-EQ
MDI = CANopen												
Input	M	D	I	1	F	C	B	1	7	A	4	-EQ
1 = Plus, standard features												
3 = Plus ² , expanded features												
4 = Plus ² , expanded features, with industrial connectors, IP54-rated												
P1 connector	M	D	I	1	F	C	B	1	7	A	4	-EQ
F = flying leads												
P = pluggable												
C = wire crimp (1)												
M = M23 industrial connector (2)												
Communication	M	D	I	1	F	C	B	1	7	A	4	-EQ
C = CANopen												
P2 connector	M	D	I	1	F	C	B	1	7	A	4	-EQ
B = DB9												
Q = M12 industrial connector (2)												
Motor size	M	D	I	1	F	C	B	1	7	A	4	-EQ
17 = NEMA 17 (1.7" / 42 mm)												
Motor length	M	D	I	1	F	C	B	1	7	A	4	-EQ
A = single stack												
B = double stack												
C = triple stack												
Drive voltage	M	D	I	1	F	C	B	1	7	A	4	-EQ
4 = +12 to +48 VDC												
Options												-EQ
Leave blank if not wanted												
Options may be combined, unless noted												
-EQ = internal encoder, 512-line internal magnetic encoder with index mark												
-EE = remote encoder interface, differential encoder to be provided by user <i>Available with Plus² versions only. May not be combined with internal encoder option.</i>												
-N = rear control knob for manual positioning (3)												

(1) Only available with Plus² products without industrial connectors.
 (2) Only available with Plus² products with industrial connectors.
 (3) Not available with industrial connector products.

Easy MDrive part numbers via an interactive tool at:
www.imshome.com/MDrivePlus.html

Part numbers

MDrive® 23 Plus CANopen

MDrive® 23 Plus

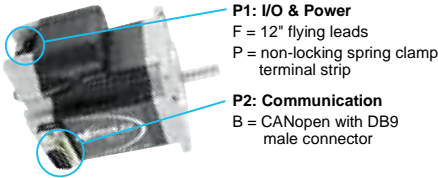

MDrive® 23 Plus²

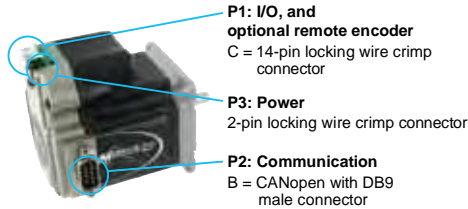

MDrive® 23 Plus² with industrial connectors

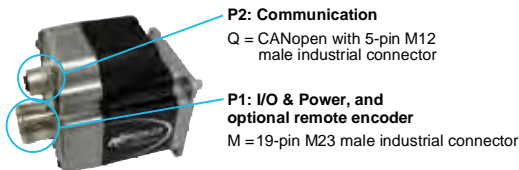

Part numbers

Example:	M	D	I	1	F	C	B	2	3	A	7	-EQ
MDrive Plus version MDI = CANopen	M	D	I	1	F	C	B	2	3	A	7	-EQ
Input 1 = Plus, standard features 3 = Plus ² , expanded features 4 = Plus ² , expanded features with industrial connectors, IP54-rated	M	D	I	1	F	C	B	2	3	A	7	-EQ
P1 connector F = flying leads P = pluggable C = wire crimp (1) M = M23 industrial connector (2)	M	D	I	1	F	C	B	2	3	A	7	-EQ
Communication C = CANopen	M	D	I	1	F	C	B	2	3	A	7	-EQ
P2 connector B = DB9 Q = M12 industrial connector (2)	M	D	I	1	F	C	B	2	3	A	7	-EQ
Motor size 23 = NEMA 23 (2.3" / 57 mm)	M	D	I	1	F	C	B	2	3	A	7	-EQ
Motor length (3) A = single stack B = double stack C = triple stack D = quad stack	M	D	I	1	F	C	B	2	3	A	7	-EQ
Drive voltage (3) 7 = +12 to +75 VDC 6 = +12 to +60 VDC	M	D	I	1	F	C	B	2	3	A	7	-EQ
Options Leave blank if not wanted Options may be combined, unless noted												-EQ
-EQ = internal encoder, 512-line internal magnetic encoder with index mark												-EQ
-EE = remote encoder interface, differential encoder to be provided by user <i>Available with Plus² versions only. May not be combined with internal encoder option.</i>												-EQ
-N = rear control knob for manual positioning (4)												-EQ

(1) Only available with Plus² products without industrial connectors.

(2) Only available with Plus² products with industrial connectors.

(3) Only quad stack motors have +12 to +60 VDC drives, all other motors have +12 to +75 VDC drives.

(4) Not available with industrial connector products.

Part numbers

MDrive® 34 Plus CANopen

MDrive® 34 Plus²
pluggable interface

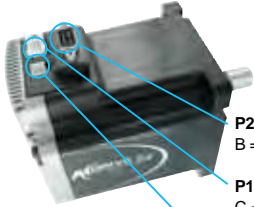

- P2: Communication**
B = CANopen with DB9 male connector
- P1: I/O, and optional remote encoder**
C = 14-pin locking wire crimp connector
(20-pin with remote encoder option)
- P3: Power**
2-pin locking wire crimp connector

Part numbers

Example:	M	D	I	3	C	C	B	3	4	A	7	-EQ
MDrive Plus version MDI = CANopen	M	D	I	3	C	C	B	3	4	A	7	-EQ
Input 3 = Plus ² , expanded features	M	D	I	3	C	C	B	3	4	A	7	-EQ
P1 connector C = pluggable	M	D	I	3	C	C	B	3	4	A	7	-EQ
Communication C = CANopen	M	D	I	3	C	C	B	3	4	A	7	-EQ
P2 connector B = DB9	M	D	I	3	C	C	B	3	4	A	7	-EQ
Motor size 34 = NEMA 34 (3.4" / 86 mm)	M	D	I	3	C	C	B	3	4	A	7	-EQ
Motor length A = single stack B = double stack C = triple stack	M	D	I	3	C	C	B	3	4	A	7	-EQ
Drive voltage 7 = +12 to +75 VDC	M	D	I	3	C	C	B	3	4	A	7	-EQ
Options Leave blank if not wanted Options may be combined, unless noted												-EQ
-EQ	= internal encoder, 512-line internal magnetic encoder with index mark											
-EE	= remote encoder interface, differential encoder to be provided by user <i>May not be combined with internal encoder option.</i>											
-N	= rear control knob for manual positioning											



Easy MDrive part numbers via an interactive tool at:
www.imshome.com/MDrivePlus.html

Part numbers

MDrive® 34 ac Plus CANopen

MDrive® 34ac Plus²

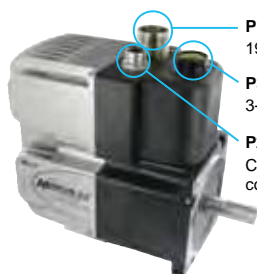

P1: I/O, and optional remote encoder
19-pin M23 male industrial connector

P3: Integrated Power Supply
3-pin Euro AC male industrial connector

P2: Communication
CANopen with 5-pin M12 male industrial connector

Part numbers

Example:	M	D	I	4	M	C	Q	3	4	A	1	-EQ
MDrive Plus version	M	D	I	4	M	C	Q	3	4	A	1	-EQ
MDI = CANopen												
Input	M	D	I	4	M	C	Q	3	4	A	1	-EQ
4 = Plus², expanded features with industrial connectors, IP54-rated												
P1 connector	M	D	I	4	M	C	Q	3	4	A	1	-EQ
M = M23 industrial connector												
Communication	M	D	I	4	M	C	Q	3	4	A	1	-EQ
C = CANopen												
P2 connector	M	D	I	4	M	C	Q	3	4	A	1	-EQ
Q = M12 industrial connector												
Motor size	M	D	I	4	M	C	Q	3	4	A	1	-EQ
34 = NEMA 34 (3.4" / 86 mm)												
Motor length	M	D	I	4	M	C	Q	3	4	A	1	-EQ
A = single stack												
B = double stack												
C = triple stack												
Drive voltage	M	D	I	4	M	C	Q	3	4	A	1	-EQ
1 = 120 VAC												
2 = 240 VAC												
Options												-EQ
Leave blank if not wanted												
Options may be combined, unless noted												
-EQ												
= internal encoder, 512-line internal magnetic encoder with index mark												
-EE												
= remote encoder interface, differential encoder to be provided by user												
<i>May not be combined with internal encoder option.</i>												
-N												
= rear control knob for manual positioning (1)												

(1) Not IP54-rated.



Easy MDrive part numbers via an interactive tool at:
www.imshome.com/MDrivePlus.html



Combining Today's Best Technologies

For Tomorrow's Break Through Discoveries

Phone: 877-478-3241

Phone: 877-IP-Tech1

Fax: 877-IP-Tech2

www.iptech1.com

MDrive® Plus Speed Control

Description

MDrive® Plus

Speed Control

with programmable velocity control



MDrive® Plus Speed Control with programmable velocity control

Presentation

The MDrive® Plus Speed Control with programmable velocity control is a 1.8° 2-phase stepper motor with on-board control electronics. The velocity control uses voltage, current, or PWM analog input signal modes.

Settings for MDrive Plus Speed Control products may be changed on-the-fly or downloaded and stored in nonvolatile memory using the IMS SPI Motor Interface software provided. This eliminates the need for external switches or resistors. Parameters are changed via an SPI port.

Application areas

The MDrive Plus Speed Control with programmable velocity control is ideal for machine builders who want an optimized motor with on-board electronics. The integrated electronics of the MDrive Plus Speed Control with programmable velocity control reduces the potential for problems due to electrical noise by eliminating the cable between motor and drive.

These compact, powerful and cost effective motion control solutions deliver unsurpassed smoothness and performance that will reduce system cost, design and assembly time for a large range of 2-phase stepper motor applications.

Features

- Highly integrated microstepping drive and high torque 1.8° 2-phase stepper motor
- Advanced current control for exceptional performance and smoothness
- Single supply: from +12 up to +75 VDC
- Cost effective
- Extremely compact
- 20 microstep resolutions up to 51,200 steps per rev including: Degrees, Metric, Arc Minutes
- 10-bit analog speed control inputs accept:
 - 0 to +5 VDC
 - 0 to +10 VDC
 - 4 to 20 mA
 - 0 to 20 mA
 - 15 to 25 kHz PWM
- Automatic current reduction
- Electronically configurable:
 - Motor run / hold current
 - Microstep resolution
 - Acceleration / deceleration
 - Initial and maximum velocity
 - Hold current delay time / motor settling delay time
 - Programmable filtering for the stop / start input
- Available options:
 - Encoder
 - Control knob for manual positioning
- Several motor stack lengths available
- Setup parameters may be switched on-the-fly
- Numerous connector interface choices
- Graphical user interface provided for quick and easy parameter setup

Specifications

MDrive® Plus

Speed Control

with programmable velocity control

Plus specifications

		MDrive 17	MDrive 23 (1)	MDrive 23 (1)	MDrive 34
Input power	Voltage	VDC			
	Current maximum (2)	12 to 48	12 to 75	12 to 60	12 to 75
Thermal	Operating temp non-condensing	Heat sink			
		Motor			
Speed control	Input	-40° to +85°C			-40° to +75°C
	A/D resolution	-40° to +100°C			-40° to +90°C
Logic input	Low level	0 to +5 VDC (4), 0 to +10 VDC, 4 to 20 mA, 0 to 20 mA, or 15 to 25 kHz PWM			
	High level	Speeds A1 and A2: 0 to +5 VDC (4), 0 to +10 VDC, 4 to 20 mA, or 0 to 20 mA			
Logic output	Internal pull-up resistance	10 bit			
	Optically isolated	10 bit			
Motion	Configurable	0 to +0.8 VDC			
	Step clock/direction	+2.0 to +5.0 VDC			
Motion	Open drain source maximum	20 kΩ (to +3.3 VDC)			
	Open drain current continuous	not applicable			
Motion	Output pulse width	no			
	Oscillator frequency maximum	sinking			
Motion	Number of settings	sourcing or sinking			
	Steps per revolution	not applicable			
Motion	Steps per revolution	+100 VDC			
		100 mA			
Motion	Steps per revolution	100 nSec to 12.8 μSec software configurable			
		5 MHz			
Motion	Number of settings	20			
	Steps per revolution	200, 400, 800, 1000, 1600, 2000, 3200, 5000, 6400, 10000, 12800, 20000, 25000, 25600, 40000, 50000, 51200, 36000 (0.01 deg/μstep), 21600 (1 arc minute/μstep), 25400 (0.001mm/μstep)			

Setup parameters (4)

SPI communication	Function	Range	Units	Default
A1 (5)	Analog input mode	0 to +5 VDC, 0 to +10 VDC, 4 to 20 mA, 0 to 20 mA, or 15 to 25 kHz PWM	—	0 to +5 VDC
ACCL	Acceleration	91 to 1.5 X 10 ⁹	steps/sec ²	1,000,000
C (7)	Joystick center	1 to 1022	counts	0
CLK OUT (6)	Clock out	none, step/dir, quadrature, up/down	—	none
DB (8)	Analog deadband	0 to 255	counts	1
DECL	Deceleration	91 to 1.5 X 10 ⁹	mSec	500
DIR	Motor direction override	Clockwise (cw)/counterclockwise (ccw)	—	cw
FAULT	Fault/checksum error	error code	—	none
FS (8)	Analog full scale	1 to 1023	counts	1023
HCDT	Hold current delay time	HCDT + MSDT ≤ 65535	milliseconds	500
IF (8)	Analog input filter	1 to 1000	counts	1
IMODE (6)	Source	A1 spd/A2 spd or PWM 15 to 25 kHz	—	A1&A2
	Analog input, A1&A2 spds	0 to +5 VDC, 0 to +10 VDC, 4 to 20 mA, 0 to 20 mA	volts or current	0 to +5 VDC
MHC	Motor hold current	0 to 100	percent	5
MRC	Motor run current	1 to 100	percent	25
MSDT	Motor settling delay time	MSDT + HCDT ≤ 65535	milliseconds	0
MSEL	Microstep resolution	1, 2, 4, 5, 8, 10, 16, 25, 32, 50, 64, 100, 108, 125, 127, 128, 180, 200, 250, 256	μsteps per full step	256
STEPW (6)	Step width	0 (square wave), 100 nSec to 12.8 μSec	nSec	550 nSec
SSD	Stop/start debounce	0 to 255	milliseconds	0
VI	Initial velocity	0 to <VM	steps/sec	1000
VM	Maximum velocity	VI to 5,000,000	steps/sec	768,000
TEMP (6)	Warning temperature	0 to 85°C	°C	80°C
USER ID	User ID	customizable	1-3 characters	IMS

(1) Only quad stack NEMA 23 motors have +12 to +60 VDC drives, all other NEMA 23 motors have +12 to +75 VDC drives.

(2) Adjusting the microstep resolution can increase the range.

(3) 10 kΩ potentiometer resistance.

(4) All parameters are set using the supplied IMS SPI Motor Interface GUI and may be changed on-the-fly. An optional Communication Converter is recommended with first orders.

(5) Only with MDrive17 & MDrive23 products.

(6) Only with MDrive34 products.

(7) Separate analog inputs for A1 and A2 speeds with MDrive34 products.



Dimensions

MDrive® 17 Plus

Speed Control

with programmable velocity control

– Plus – mechanical specifications, dimensions in inches (mm)

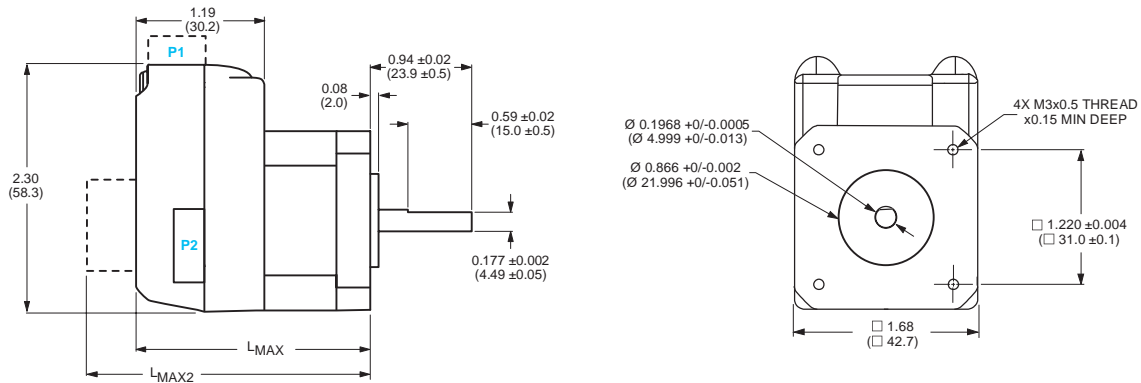

Motor stack length	Lmax (1)	Lmax2 (2)
Single	2.20 (55.9)	2.79 (70.9)
Double	2.43 (61.7)	3.02 (76.7)
Triple	2.77 (70.4)	3.37 (85.6)

(1) Single shaft.

(2) Control knob or external encoder.

P1 connector options

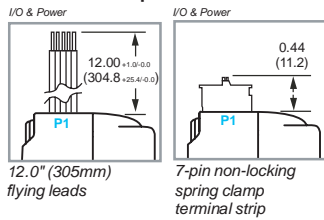

P2 connector options

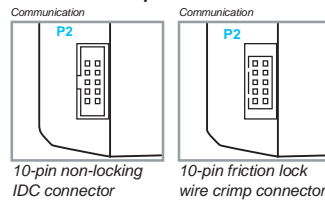

Lmax2 options

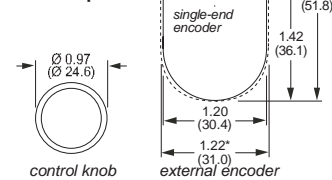

Dimensions

MDrive® 23 Plus

Speed Control

with programmable velocity control

– Plus – mechanical specifications, dimensions in inches (mm)

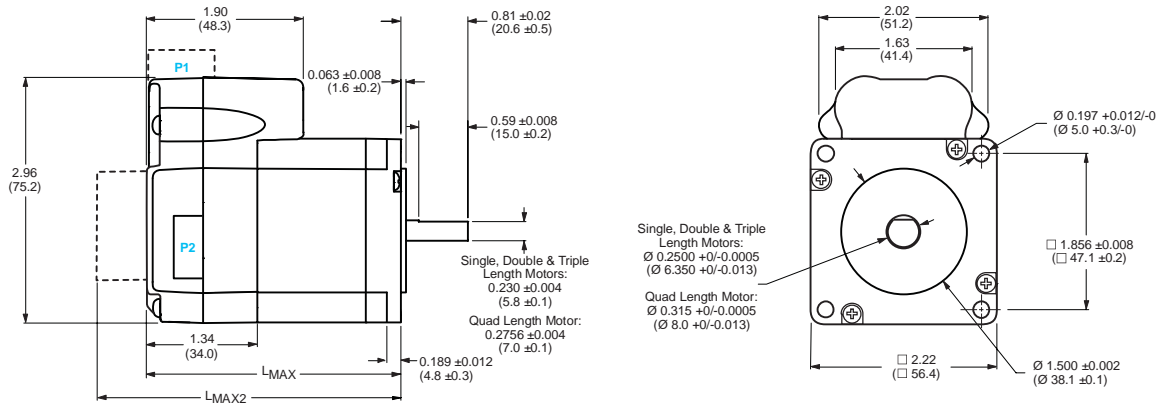

Motor stack length	L _{max} (1)	L _{max2} (2)
Single	2.65 (67.31)	3.36 (85.34)
Double	3.02 (76.71)	3.73 (94.74)
Triple	3.88 (98.55)	4.59 (116.59)
Quad	5.28 (134.15)	5.99 (152.19)

(1) Single shaft.
(2) Control knob or external encoder.

P1 connector options

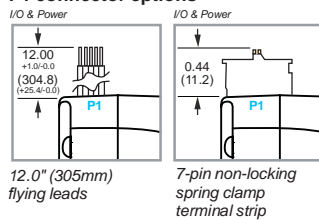

P2 connector options

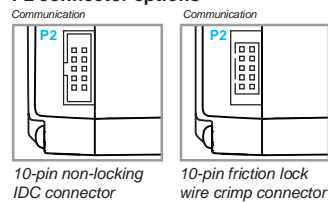

L_{max2} options

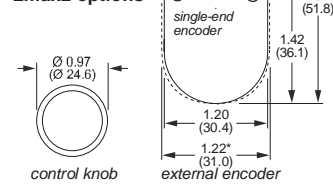

Dimensions

MDrive® 34 Plus

Speed Control

with programmable velocity control

– Plus – mechanical specifications, dimensions in inches (mm)

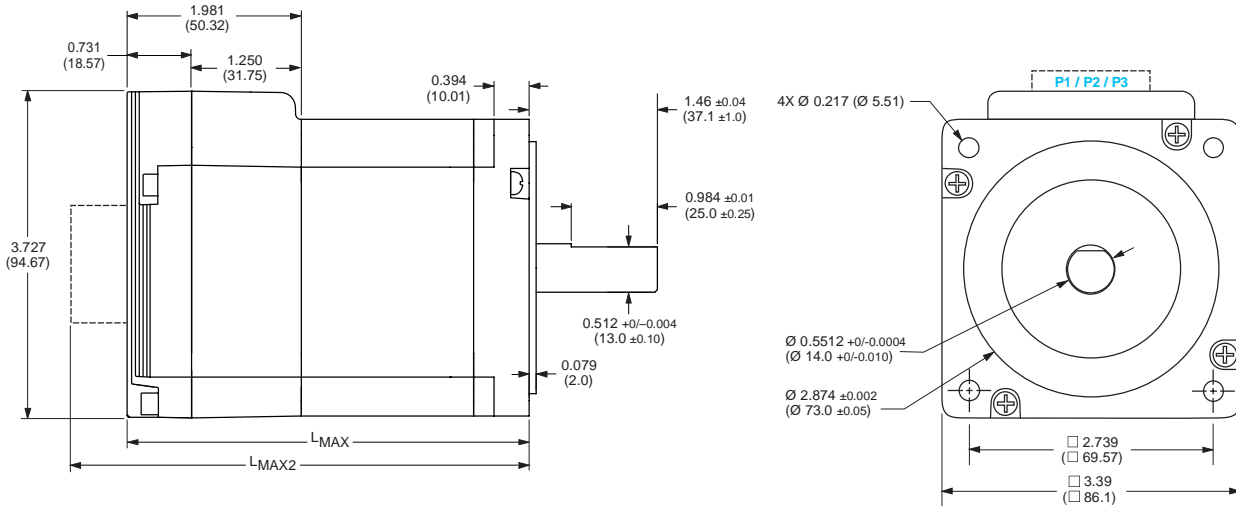

Motor stack length	L _{max} (1)	L _{max2} (2)
Single	3.81 (96.77)	4.52 (114.81)
Double	4.60 (116.84)	5.31 (134.87)
Triple	6.17 (156.72)	6.88 (174.75)

(1) Single shaft or internal encoder.
(2) Control knob.

Connector options

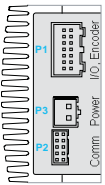

Pluggable interface version:
12-pin* and 2-pin locking and
10-pin friction lock wire crimp
connectors

* 12-pin replaced by 20-pin
locking wire crimp connector
when optional internal encoder
is included

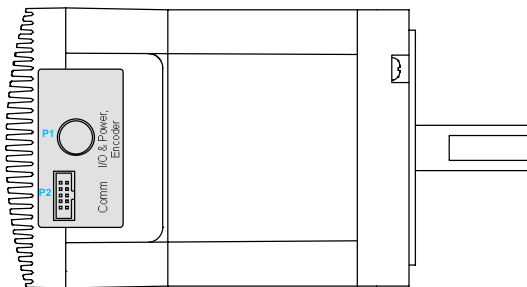

Flying leads interface version:
12" (305mm) flying leads with
10-pin non-locking IDC connector

L_{max2} option

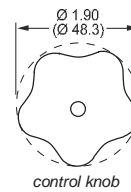

Connectivity

MDrive® 17 Plus

Speed Control

with programmable velocity control

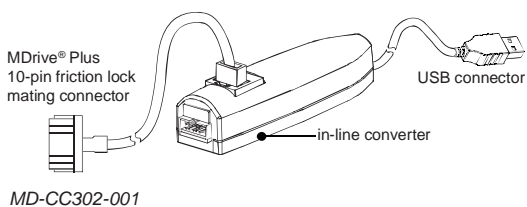
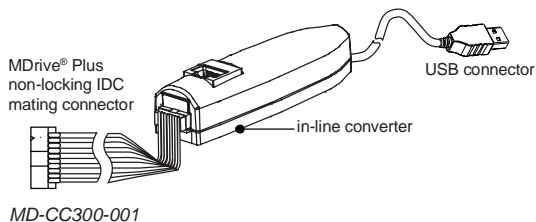

Installation accessories

Description	Length feet (m)	Part number
-------------	-----------------	-------------

QuickStart Kit

For rapid design verification, all-inclusive QuickStart Kits include connectivity, instructions and CD for MDrivePlus initial functional setup and system testing.

- For all MDrive17 Speed Control products. — add "K" to part number (1)

Communication converter

Electrically isolated, in-line converter pre-wired with mating connector to conveniently set/program communication parameters for a single MDrivePlus via a PC's USB port.

- | | | |
|--|------------|--------------|
| ■ Mates to 10-pin non-locking IDC connector | 12.0 (3.6) | MD-CC300-001 |
| ■ Mates to 10-pin friction lock wire crimp connector | 12.0 (3.6) | MD-CC302-001 |

Mating connector kit

Connectors for assembly of cables, cable material not supplied. Sold in lots of 5. Manufacturer's crimp tool recommended for crimp connectors.

- | | | |
|---|---|-------|
| ■ 10-pin non-locking IDC connector for communication | — | CK-01 |
| ■ 10-pin friction lock wire crimp connector for communication | — | CK-02 |

Encoder cables

Pre-wired mating connector with other cable end open.

- | | | |
|--|-----------|------------|
| ■ For external single-end encoder | 1.0 (0.3) | ED-CABLE-2 |
| ■ For external differential encoder, locking cable | 6.0 (1.8) | ED-CABLE-6 |

Drive protection module

Limits surge current and voltage to a safe level when DC input power is switched on-and-off to an MDrivePlus.

- For all MDrive17 Speed Control products — DPM75

(1) See page 68.



Connectivity details: www.imshome.com/connect.html

Connectivity

MDrive® 23 Plus

Speed Control

with programmable velocity control

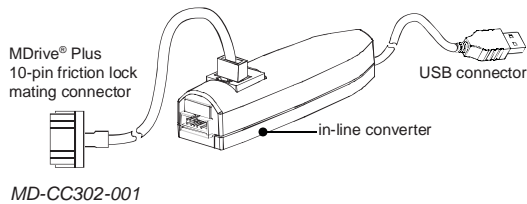
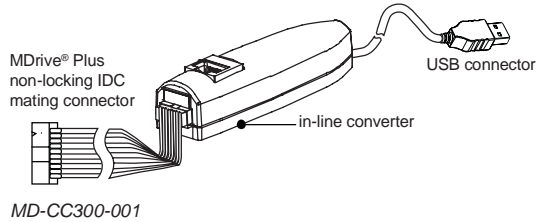

Installation accessories

Description	Length feet (m)	Part number
-------------	-----------------	-------------

QuickStart Kit

For rapid design verification, all-inclusive QuickStart Kits include connectivity, instructions and CD for MDrive Plus initial functional setup and system testing.

- For all MDrive23 Speed Control products. — add "K" to part number (1)

Communication converter

Electrically isolated, in-line converter pre-wired with mating connector to conveniently set/program communication parameters for a single MDrive Plus via a PC's USB port.

■ Mates to 10-pin non-locking IDC connector	12.0 (3.6)	MD-CC300-001
■ Mates to 10-pin friction lock wire crimp connector	12.0 (3.6)	MD-CC302-001

Mating connector kit

Connectors for assembly of cables, cable material not supplied. Sold in lots of 5. Manufacturer's crimp tool recommended for crimp connectors.

■ 10-pin non-locking IDC connector for communication	—	CK-01
■ 10-pin friction lock wire crimp connector for communication	—	CK-02

Encoder cables

Pre-wired mating connector with other cable end open.

■ For external single-end encoder	1.0 (0.3)	ED-CABLE-2
■ For external differential encoder, locking cable	6.0 (1.8)	ED-CABLE-6

Drive protection module

Limits surge current and voltage to a safe level when DC input power is switched on-and-off to an MDrive Plus.

- For all MDrive23 Speed Control products — DPM75

(1) See page 69.



Connectivity details: www.imshome.com/connect.html

Connectivity

MDrive® 34 Plus

Speed Control

with programmable velocity control

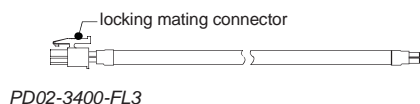
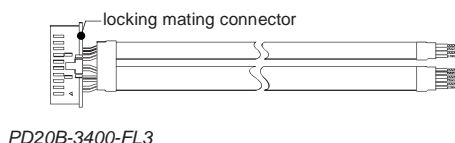
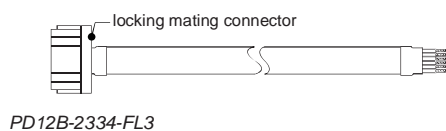
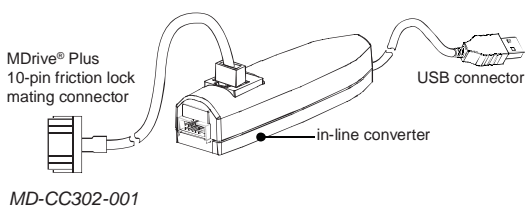
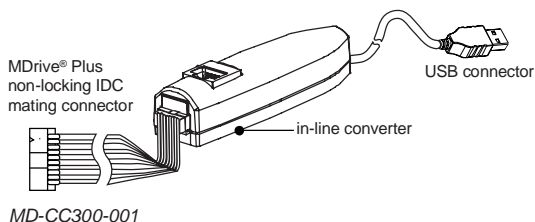

Installation accessories

Description	Length feet (m)	Part number
QuickStart Kit		
For rapid design verification, all-inclusive QuickStart Kits include connectivity, instructions and CD for MDrive Plus initial functional setup and system testing.		
■ For all MDrive34 Speed Control products.	—	add "K" to part number (1)

Communication converter

Electrically isolated, in-line converter pre-wired with mating connector to conveniently set/program communication parameters for a single MDrive Plus via a PC's USB port.

■ Mates to 10-pin non-locking IDC connector	12.0 (3.6)	MD-CC300-001
■ Mates to 10-pin friction lock wire crimp connector	12.0 (3.6)	MD-CC302-001

Prototype development cable

Speed test/development with pre-wired mating connector with other cable end open.

■ Mates to 12-pin locking wire crimp connector for I/O and optional internal encoder	10.0 (3.0)	PD12B-2334-FL3
■ Mates to 20-pin locking wire crimp connector for I/O and remote encoder option	10.0 (3.0)	PD20B-3400-FL3
■ Mates to 2-pin locking wire crimp connector for power	10.0 (3.0)	PD02-3400-FL3

Mating connector kit

Connectors for assembly of cables, cable material not supplied. Sold in lots of 5. Manufacturer's crimp tool recommended for crimp connectors.

■ 10-pin non-locking IDC connector for communication	—	CK-01
■ 10-pin friction lock wire crimp connector for communication	—	CK-02
■ 12-pin locking wire crimp connector for I/O and optional internal encoder	—	CK-08
■ 20-pin locking wire crimp connector for I/O and remote encoder option	—	CK-11
■ 2-pin locking wire crimp connector for power	—	CK-05

Drive protection module

Limits surge current and voltage to a safe level when DC input power is switched on-and-off to an MDrive Plus.

■ For all MDrive34 Speed Control products	—	DPM75
---	---	-------

(1) See page 70.



Connectivity details: www.imshome.com/connect.html

Part numbers

MDrive® 17 Plus

Speed Control

with programmable velocity control

MDrive® 17 Plus



P1: I/O & Power
F = 12" flying leads
P = non-locking spring clamp terminal strip

P2: Communication
D = SPI with 10-pin IDC non-locking connector
L = SPI with 10-pin friction lock wire crimp connector

Part numbers

Example:	K	M	D	O	1	F	S	D	1	7	A	4	-E1
QuickStart Kit K = kit option, or leave blank if not wanted	K	M	D	O	1	F	S	D	1	7	A	4	-E1
MDrive Plus version MDO = Speed Control	K	M	D	O	1	F	S	D	1	7	A	4	-E1
Input 1 = Plus, standard features	K	M	D	O	1	F	S	D	1	7	A	4	-E1
P1 connector — I/O & power F = flying leads P = pluggable	K	M	D	O	1	F	S	D	1	7	A	4	-E1
Communication S = SPI	K	M	D	O	1	F	S	D	1	7	A	4	-E1
P2 connector — communication D = IDC L = wire crimp	K	M	D	O	1	F	S	D	1	7	A	4	-E1
Motor size 17 = NEMA 17 (1.7" / 42 mm)	K	M	D	O	1	F	S	D	1	7	A	4	-E1
Motor length A = single stack B = double stack C = triple stack	K	M	D	O	1	F	S	D	1	7	A	4	-E1
Drive voltage 4 = +12 to +48 VDC	K	M	D	O	1	F	S	D	1	7	A	4	-E1
Options Leave blank if not wanted Options may not be combined													-E1
-E _____ = external optical encoder with index mark													-E1
	line count	100	200	250	256	400	500	512	1000	1024			
	single-end part #	E1	E2	E3	EP	E4	E5	EQ	E6	ER			
	differential part #	EAL	EBL	ECL	EWL	EDL	EHL	EXL	EJL	EYL			
-N _____ = rear control knob for manual positioning													-E1



Easy MDrive part numbers via an interactive tool at:
www.imshome.com/MDrivePlus.html

Part numbers

MDrive® 23 Plus

Speed Control

with programmable velocity control

MDrive® 23 Plus

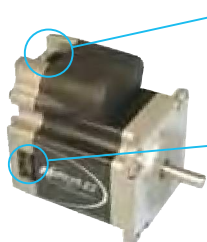

P1: I/O & Power
 F = 12" flying leads
 P = non-locking spring clamp terminal strip

P2: Communication
 D = SPI with 10-pin IDC non-locking connector
 L = SPI with 10-pin friction lock wire crimp connector

Part numbers												
Example:	K	M	D	O	1	F	S	D	2	3	A	7 -E1
QuickStart Kit K = kit option, or leave blank if not wanted	K	M	D	O	1	F	S	D	2	3	A	7 -E1
MDrive Plus version MDO = Speed Control	K	M	D	O	1	F	S	D	2	3	A	7 -E1
Input 1 = Plus, standard features	K	M	D	O	1	F	S	D	2	3	A	7 -E1
P1 connector — I/O & power F = flying leads P = pluggable	K	M	D	O	1	F	S	D	2	3	A	7 -E1
Communication S = SPI	K	M	D	O	1	F	S	D	2	3	A	7 -E1
P2 connector — communication D = IDC L = wire crimp	K	M	D	O	1	F	S	D	2	3	A	7 -E1
Motor size 23 = NEMA 23 (2.3" / 57 mm)	K	M	D	O	1	F	S	D	2	3	A	7 -E1
Motor length A = single stack B = double stack C = triple stack D = quad stack	K	M	D	O	1	F	S	D	2	3	A	7 -E1
Drive voltage (1) 7 = +12 to +75 VDC 6 = +12 to +60 VDC	K	M	D	O	1	F	S	D	2	3	A	7 -E1
Options Leave blank if not wanted Options may not be combined												-E1
-E ____ = external optical encoder with index mark												-E1
	line count	100	200	250	256	400	500	512	1000	1024		
	single-end part #	E1	E2	E3	EP	E4	E5	EQ	E6	ER		
	differential part #	EAL	EBL	ECL	EWL	EDL	EHL	EXL	EJL	EYL		
-N = rear control knob for manual positioning												-E1

(1) Only quad stack motors have +12 to +60 VDC drives, all other motors have +12 to +75 VDC drives.



Easy MDrive part numbers via an interactive tool at:
www.imshome.com/MDrivePlus.html

Part numbers

MDrive® 34 Plus

Speed Control

with programmable velocity control

MDrive® 34 Plus²
flying leads interface

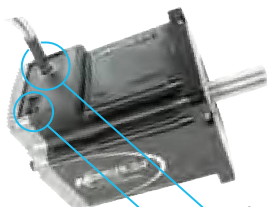

P1: I/O & Power
F = 12" flying leads

P2: Communication
D = SPI with 10-pin IDC non-locking connector

MDrive® 34 Plus²
pluggable interface

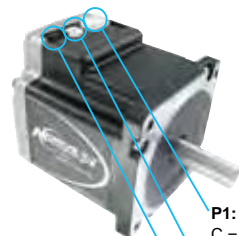

P1: I/O and optional encoder
C = 12-pin locking wire crimp connector (20-pin with internal encoder option)

P3: Power
2-pin locking wire crimp connector

P2: Communication
L = 10-pin friction lock wire crimp connector

Part numbers

Example:	K	M	D	O	3	F	S	D	3	4	A	7	-E1
QuickStart Kit K = kit option, or leave blank if not wanted	K	M	D	O	3	F	S	D	3	4	A	7	-E1
MDrive Plus version MDO = Speed Control	K	M	D	O	3	F	S	D	3	4	A	7	-E1
Input 3 = Plus ² , expanded features	K	M	D	O	3	F	S	D	3	4	A	7	-E1
P1 connector F = flying leads C = pluggable	K	M	D	O	3	F	S	D	3	4	A	7	-E1
Communication S = SPI	K	M	D	O	3	F	S	D	3	4	A	7	-E1
P2 connector D = only with P1 connector F L = only with P1 connector C	K	M	D	O	3	F	S	D	3	4	A	7	-E1
Motor size 34 = NEMA 34 (3.4" / 86 mm)	K	M	D	O	3	F	S	D	3	4	A	7	-E1
Motor length A = single stack B = double stack C = triple stack	K	M	D	O	3	F	S	D	3	4	A	7	-E1
Drive voltage 7 = +12 to +75 VDC	K	M	D	O	3	F	S	D	3	4	A	7	-E1
Options Leave blank if not wanted Options may be combined													-E1
-E ____ = internal optical encoder with index mark (1)													
line count	100	200	250	256	400	500	512	1000	1024				
single-end part #	E1	E2	E3	EP	E4	E5	EQ	E6	ER				
differential part #	EA	EB	EC	EW	ED	EH	EX	EJ	EY				
-N = rear control knob for manual positioning													

(1) Products with pluggable interface available only with differential encoder.



Easy MDrive part numbers via an interactive tool at:
www.imshome.com/MDrivePlus.html



Combining Today's Best Technologies

For Tomorrow's Break Through Discoveries

Phone: 877-478-3241
Phone: 877-IP-Tech1
Fax: 877-IP-Tech2
www.iptech1.com

MDrive® Plus

System performance



Combining Today's Best Technologies

For Tomorrow's Break Through Discoveries

Phone: 877-478-3241
Phone: 877-IP-Tech1
Fax: 877-IP-Tech2
www.iptech1.com



System performance

MDrive® Plus Motor specifications

Motor specifications MDrive 14

		Holding torque	Detent torque	Rotor inertia	Weight (motor + driver)
Motor stack length	Single	18.0 oz-in / 12.71 N-cm	2.0 oz-in / 1.4 N-cm	0.000278 oz-in-sec ² / 0.0199 kg-cm ²	5.29 oz / 150.0 g
	Triple	36.0 oz-in / 25.00 N-cm	4.4 oz-in / 3.1 N-cm	0.000801 oz-in-sec ² / 0.0566 kg-cm ²	12.8 oz / 380.0 g

Motor specifications MDrive 17

		Holding torque	Detent torque	Rotor inertia	Weight (motor + driver)
Motor stack length	Single	32.0 oz-in / 22.6 N-cm	1.66 oz-in / 1.17 N-cm	0.00053 oz-in-sec ² / 0.038 kg-cm ²	10.4 oz / 294.8 g
	Double	60.0 oz-in / 42.4 N-cm	2.08 oz-in / 1.47 N-cm	0.00080 oz-in-sec ² / 0.057 kg-cm ²	12.0 oz / 340.2 g
	Triple	74.9 oz-in / 52.9 N-cm	3.47 oz-in / 2.45 N-cm	0.00116 oz-in-sec ² / 0.082 kg-cm ²	15.2 oz / 430.9 g

Motor specifications MDrive 23

		Holding torque	Detent torque	Rotor inertia	Weight (motor + driver)
Motor stack length	Single	90.0 oz-in / 64.0 N-cm	3.9 oz-in / 2.7 N-cm	0.0025 oz-in-sec ² / 0.18 kg-cm ²	21.6 oz / 612.3 g
	Double	144.0 oz-in / 102.0 N-cm	5.6 oz-in / 3.92 N-cm	0.0037 oz-in-sec ² / 0.26 kg-cm ²	26.4 oz / 748.4 g
	Triple	239.0 oz-in / 169.0 N-cm	9.7 oz-in / 6.86 N-cm	0.0065 oz-in-sec ² / 0.46 kg-cm ²	39.2 oz / 1111.3 g
	Quad	283.0 oz-in / 200.0 N-cm	14.2 oz-in / 10.0 N-cm	0.0108 oz-in-sec ² / 0.76 kg-cm ²	61.6 oz / 1746.3 g

Motor specifications MDrive 34

		Holding torque	Detent torque	Rotor inertia	Weight (motor + driver)
Motor stack length	Single	381.0 oz-in / 269.0 N-cm	10.9 oz-in / 7.7 N-cm	0.01416 oz-in-sec ² / 1.0 kg-cm ²	4.1 lb / 1.9 kg
	Double	575.0 oz-in / 406.0 N-cm	14.16 oz-in / 10.0 N-cm	0.02266 oz-in-sec ² / 1.6 kg-cm ²	5.5 lb / 2.5 kg
	Triple	1061.0 oz-in / 749.0 N-cm	19.83 oz-in / 14.0 N-cm	0.04815 oz-in-sec ² / 3.4 kg-cm ²	8.8 lb / 4.0 kg

Motor specifications MDrive 34 ac

		Holding torque	Detent torque	Rotor inertia	Weight (motor + driver)
Motor stack length	Single	330.0 oz-in / 233.0 N-cm	10.9 oz-in / 7.7 N-cm	0.01416 oz-in-sec ² / 1.0 kg-cm ²	6.4 lb / 2.9 kg
	Double	500.0 oz-in / 353.0 N-cm	14.16 oz-in / 10.0 N-cm	0.02266 oz-in-sec ² / 1.6 kg-cm ²	7.7 lb / 3.5 kg
	Triple	750.0 oz-in / 529.0 N-cm	19.83 oz-in / 14.0 N-cm	0.04815 oz-in-sec ² / 3.4 kg-cm ²	11.0 lb / 5.0 kg

System performance

MDrive® Plus

Speed torque characteristics

Speed torque characteristics MDrive 14

Single stack length

Torque in Oz-In / N-cm

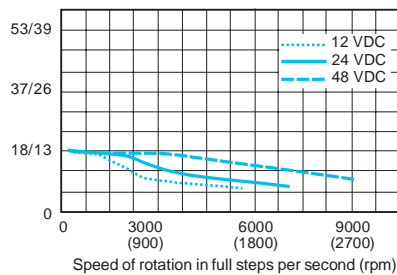

Triple stack length

Torque in Oz-In / N-cm

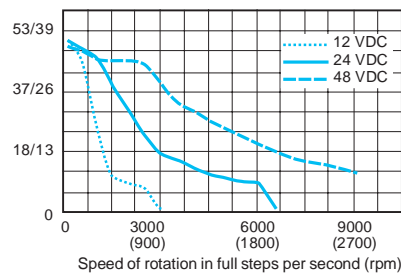

Speed torque characteristics MDrive 17

Single stack length

Torque in Oz-In / N-cm

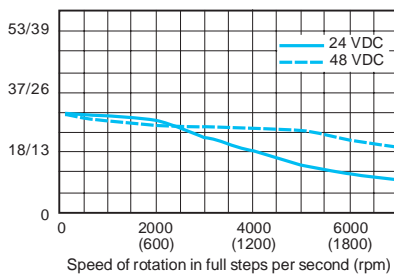

Double stack length

Torque in Oz-In / N-cm

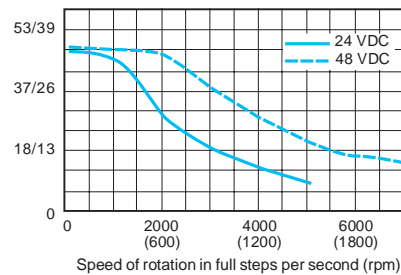

Triple stack length

Torque in Oz-In / N-cm

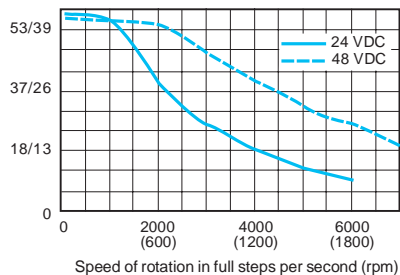

Speed torque characteristics MDrive 23

Single stack length

Torque in Oz-In / N-cm

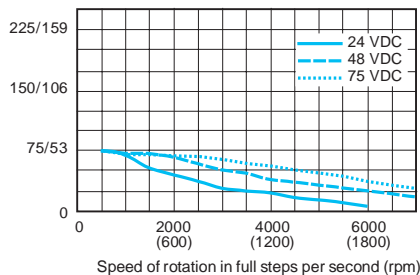

Double stack length

Torque in Oz-In / N-cm

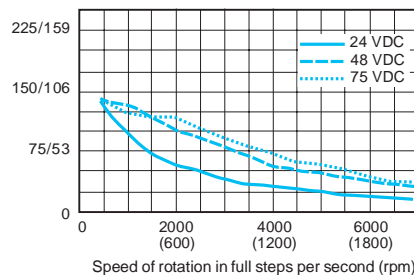

Triple stack length

Torque in Oz-In / N-cm

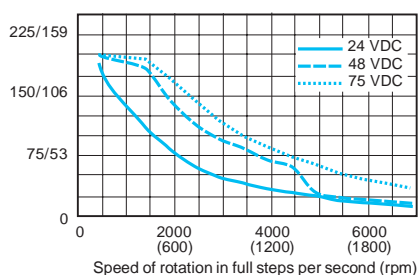

Quad stack length

Torque in Oz-In / N-cm

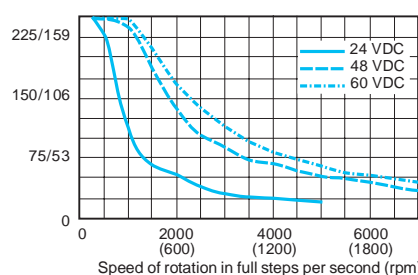

System performance

MDrive® Plus

Speed torque characteristics

Speed torque characteristics MDrive 34

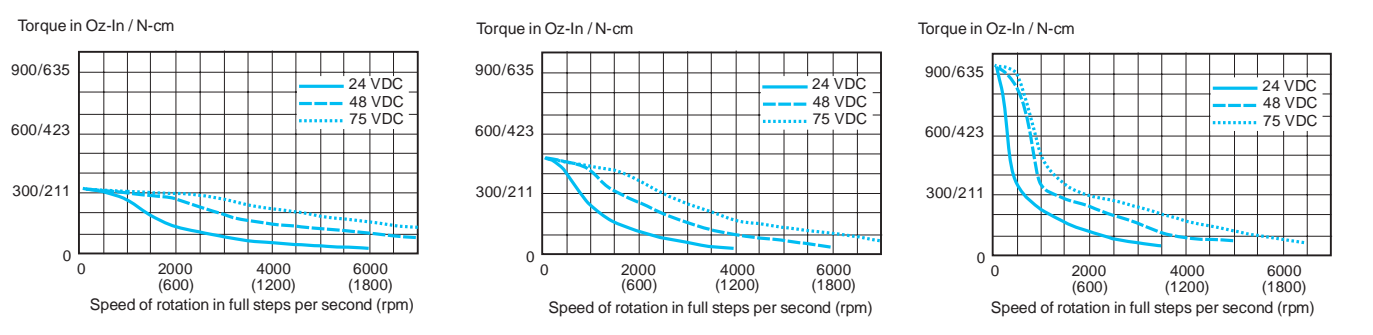

Speed torque characteristics MDrive 34 ac

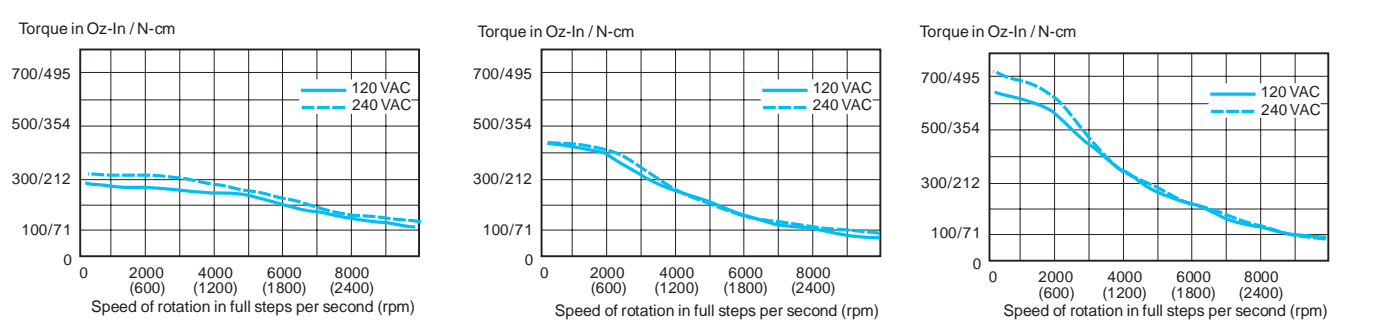



Warranty

TWENTY-FOUR MONTH LIMITED WARRANTY

IMS Schneider Electric Motion USA warrants only to the purchaser of the Product from IMS Schneider Electric Motion USA (the "Customer") that the product purchased from IMS Schneider Electric Motion USA (the "Product") will be free from defects in materials and workmanship under the normal use and service for which the Product was designed for a period of 24 months from the date of purchase of the Product by the Customer. Customer's exclusive remedy under this Limited Warranty shall be the repair or replacement, at Company's sole option, of the Product, or any part of the Product, determined by IMS Schneider Electric Motion USA to be defective. In order to exercise its warranty rights, Customer must notify Company in accordance with the instructions described under the heading "Obtaining Warranty Service".

NOTE: MDrive Motion Control electronics are not removable from the motor in the field. The entire unit must be returned to the factory for repair.

This Limited Warranty does not extend to any Product damaged by reason of alteration, accident, abuse, neglect or misuse or improper or inadequate handling; improper or inadequate wiring utilized or installed in connection with the Product; installation, operation or use of the Product not made in strict accordance with the specifications and written instructions provided by IMS; use of the Product for any purpose other than those for which it was designed; ordinary wear and tear; disasters or Acts of God; unauthorized attachments, alterations or modifications to the Product; the misuse or failure of any item or equipment connected to the Product not supplied by IMS Schneider Electric Motion USA; improper maintenance or repair of the Product; or any other reason or event not caused by IMS Schneider Electric Motion USA.

IMS SCHNEIDER ELECTRIC MOTION USA HEREBY DISCLAIMS ALL OTHER WARRANTIES, WHETHER WRITTEN OR ORAL, EXPRESS OR IMPLIED BY LAW OR OTHERWISE, INCLUDING WITHOUT LIMITATION, ANY WARRANTIES OF MERCHANTABILITY OR FITNESS FOR ANY PARTICULAR PURPOSE. CUSTOMER'S SOLE REMEDY FOR ANY DEFECTIVE PRODUCT WILL BE AS STATED ABOVE, AND IN NO EVENT WILL IMS SCHNEIDER ELECTRIC MOTION USA BE LIABLE FOR INCIDENTAL, CONSEQUENTIAL, SPECIAL OR INDIRECT DAMAGES IN CONNECTION WITH THE PRODUCT.

This Limited Warranty shall be void if the Customer fails to comply with all of the terms set forth in this Limited Warranty. This Limited Warranty is the sole warranty offered by IMS Schneider Electric Motion USA with respect to the Product. IMS Schneider Electric Motion USA does not assume any other liability in connection with the sale of the Product. No representative of IMS Schneider Electric Motion USA is authorized to extend this Limited Warranty or to change it in any manner whatsoever. No warranty applies to any party other than the original Customer.

IMS Schneider Electric Motion USA and its directors, officers, employees, subsidiaries and affiliates shall not be liable for any damages arising from any loss of equipment, loss or distortion of data, loss of time, loss or destruction of software or other property, loss of production or profits, overhead costs, claims of third parties, labor or materials, penalties or liquidated damages or punitive damages, whatsoever, whether based upon breach of warranty, breach of contract, negligence, strict liability or any other legal theory, or other losses or expenses incurred by the Customer or any third party.

OBTAINING WARRANTY SERVICE

If the Product was purchased from an IMS Schneider Electric Motion USA Distributor, please contact that Distributor to obtain a Returned Material Authorization (RMA). If the Product was purchased directly from IMS Schneider Electric Motion USA, please contact Customer Service at info@imshome.com or 860-295-6102 (Eastern Time Zone).

Customer shall prepay shipping charges for Products returned to IMS Schneider Electric Motion USA for warranty service, and IMS Schneider Electric Motion USA will pay for return of Products to Customer by ground transportation. However, Customer shall pay all shipping charges, duties and taxes for Products returned to IMS Schneider Electric Motion USA from outside the United States.

DISCLAIMER: The information in this document has been carefully checked and is believed to be accurate; however, no responsibility is assumed for inaccuracies.

IMS Schneider Electric Motion USA reserves the right to make changes without further notice to any products herein to improve reliability, function, or design. IMS Schneider Electric Motion USA does not assume any liability arising out of the application or use of any product or circuit described herein; neither does it convey any license under its patent rights of others.

The general policy of IMS Schneider Electric Motion USA does not recommend the use of its products in life support or aircraft applications wherein a failure or malfunction of the product may directly threaten life or injury. Per the terms and conditions of sales of IMS Schneider Electric Motion USA, the user of IMS Schneider Electric Motion USA products in life support or aircraft applications assumes all risks of such use and indemnifies IMS Schneider Electric Motion USA against all damages.



Up to 2 standard MDrive products ship within 5 working days.

USA SALES OFFICES

Eastern Region

Tel. 862 208-9742 - Fax 973 661-1275
e-mail: e.region@imshome.com

Northeast Region

Tel. 860 368-9703
e-mail: n.region@imshome.com

Central Region

Tel. 860 295-6102
e-mail: c.region@imshome.com

Western Region

Tel. 602 578-7201
e-mail: w.region@imshome.com

IMS EUROPEAN SALES MANAGEMENT

4 Quai Des Etroits
69005 Lyon, France
Tel. +33/4 7256 5113 - Fax +33/4 7838 1537
e-mail: europa.sales@imshome.com

TECHNICAL SUPPORT

Tel. +00 (1) 860 295-6102 - Fax +00 (1) 860 295-6107
e-mail: etech@imshome.com

Schneider Electric Motion USA

370 North Main Street, P.O. Box 457
Marlborough, CT 06447 - U.S.A.
Tel. +00 (1) 860 295-6102 - Fax +00 (1) 860 295-6107
e-mail: info@imshome.com
www.schneider-electric-motion.us