

# **Advanced Research Instruments Corporation**

**PO Box 7427, Golden CO 80403 USA**

**Phone (303)463-5500 Fax (303)463-5505**

**Email: [aricorp@aricorp.com](mailto:aricorp@aricorp.com) Web Site: [www.aricorp.com](http://www.aricorp.com)**

## **USER MANUAL**

**for the**

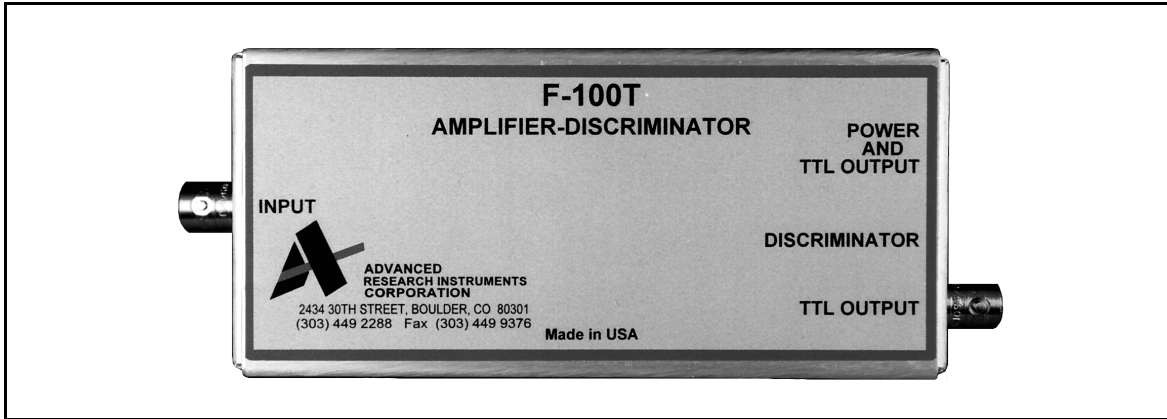
**F-100T PREAMPLIFIER/DISCRIMINATOR V9**

Rev. October 2005

# TABLE OF CONTENTS

<b>F-100TV9 SPECIFICATIONS.....</b>	<b>2</b>
<b>INSTALLATION .....</b>	<b>3</b>
<b>Output Considerations .....</b>	<b>3</b>
<b>Pulse Width .....</b>	<b>3</b>
<b>Figure 1. Timing Capacitor Selection for Desired Output Pulse Width..</b>	<b>3</b>
<b>Figure 2. Power Connector Pin-Out.....</b>	<b>4</b>
<b>Figure 3a. Cable Selection Guide.....</b>	<b>4</b>
<b>Figure 3b. Cable Diagrams.....</b>	<b>5</b>
<b>Potential Problems .....</b>	<b>6</b>
<b>Figure 4. Example of Ringing Reduction by 50Ω Termination.....</b>	<b>7</b>
<b>Input Considerations .....</b>	<b>7</b>
<b>Figure 5. Electron Multiplier Bias.....</b>	<b>8</b>
<b>OPERATION .....</b>	<b>9</b>
<b>Connecting and Disconnecting Your Preamplifier .....</b>	<b>9</b>
<b>Discriminator Set Up .....</b>	<b>9</b>
<b>Figure 6. Typical Signal from the Detector and the Threshold setting..</b>	<b>9</b>
<b>Figure 7. Relationship Between the Threshold             Position and Resulting Count Rate .....</b>	<b>9</b>
<b>Blank Page .....</b>	<b>11</b>
<b>TROUBLE-SHOOTING GUIDE.....</b>	<b>12</b>
<b>No Output Pulses.....</b>	<b>12</b>
<b>Too Much Noise .....</b>	<b>12</b>
<b>Figure 8. Missing Ground in the BNC Connector.....</b>	<b>13</b>
<b>Double Pulsing.....</b>	<b>14</b>
<b>Sensitivity Measurement .....</b>	<b>14</b>
<b>Reducing Power Supply Induced Noise .....</b>	<b>15</b>
<b>Using a Suitable Power Supply to Reduce Noise .....</b>	<b>15</b>
<b>Noise Reduction by Negative H.V. Biasing Technique.....</b>	<b>15</b>
<b>Positive H.V. Biasing.....</b>	<b>16</b>
<b>PHOTON COUNTING APPLICATIONS.....</b>	<b>17</b>
<b>How to Optimize Photon Counting .....</b>	<b>17</b>
<b>How To Minimize the Background Count .....</b>	<b>17</b>
<b>Maximizing the Useful Count Rate .....</b>	<b>18</b>
<b>How to Automate Your Data Acquisition .....</b>	<b>18</b>

## F-100TV9 SPECIFICATIONS



Transimpedance	18 k $\Omega$
Input impedance	50 $\Omega$
Input range	2 $\mu$ A - 4 mA [100 $\mu$ V to 200 mV]
Input linear range	2 $\mu$ A - 160 $\mu$ A [100 $\mu$ V to 8 mV]
Input charge sensitivity	<20 fC
Linear section transimpedance gain	50dB
Noise referred to input	< 0.4 $\mu$ Ap-p [20 $\mu$ Vp-p]
Input pulse polarity	Negative
Input pulse rise time	<2-3ns
Input over voltage protection	Standard
Input connector	BNC
Threshold adjustment range	0 – 14 mV referred to input
Remote threshold input	0 - +5V [0-14mV ref. to input]
Maximum pulse repetition rate	>50MHz
Pulse pair resolution	<20ns
Minimum output pulse width	10 ns (standard)
Maximum output pulse width	1 $\mu$ s
Output signal	+5V (TTL)
Output impedance	50 $\Omega$
Power connector and signal	9 pin mini D type
Second Output Signal	BNC
Power requirements	8V to 24VDC/50mA
Physical size	2.5" x 5" x 1.1"

# USER MANUAL

## for the

### F-100T TRANSIMPEDANCE PREAMPLIFIER/DISCRIMINATOR V9

This manual is written to assist you in the installation and operation of your F-100T transimpedance preamplifier/discriminator.

## INSTALLATION

Refer to Figure 2 on the following page for the connector pin-out.

The preamplifier requires an unregulated dual power supply of  $\pm 8V$  to  $\pm 24V$ : typically  $\pm 12V$ ,  $\pm 15V$  or  $\pm 24V$  at  $+50mA$  and  $-30mA$ . This is the least critical connection, since built-in voltage regulators virtually eliminate any ripple, instability, or noise on the power lines.

### Output Considerations

Output pulses from pin 1 represent the standard TTL/CMOS level:  $+5.0V$  unterminated with respect to ground (pin 6).

The output impedance of the F-100T is  $50\ \Omega$ . To avoid any potential problems related to an improperly terminated transmission line such as ringing or multiple pulsing, use a  $50\ \Omega$  coaxial cable terminated by a  $50\ \Omega$  resistor or a ratemeter with  $50\ \Omega$  input impedance.

### Pulse Width

The minimum output pulse width is about  $10ns$ . You can extend the pulse width by adding a C8T capacitor inside the F-100T. The graph in Figure 1 enables you to determine the required capacitor corresponding to the desired pulse width. However, it is important to use the minimum pulse width that can be tolerated by the rate meter. This is because the minimum pulse pair spacing (maximum pulse pair resolution) is directly related to the output pulse width, and pulse pair resolution is limited by the output pulse width. Therefore, the wider the output pulse width, the worse will be the pulse pair resolution, and the lower the maximum count rate.

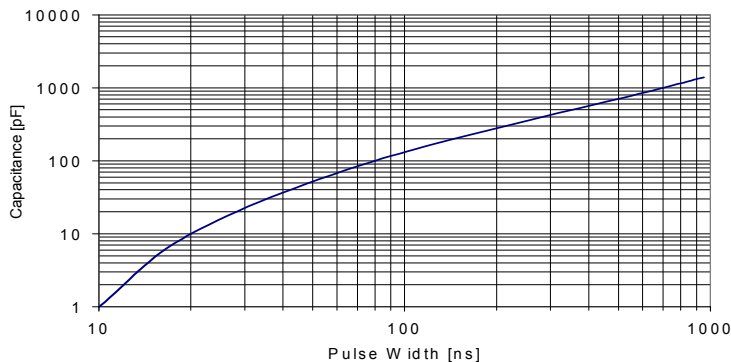
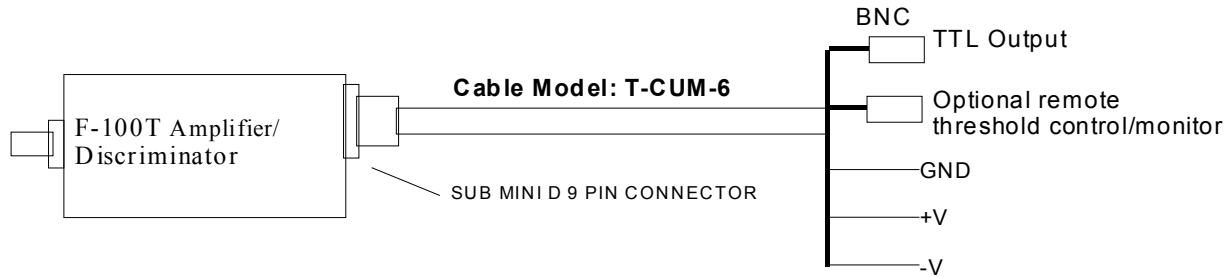


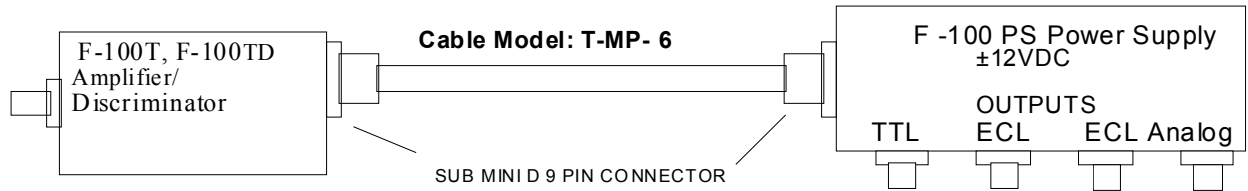
Figure 1. Timing Capacitor Selection for Desired Output Pulse Width

Pin Number	-	Signal
1	-	TTL Output
2	-	Not Used
3	-	V + (+8 to +24 VDC)
4	-	Remote Threshold Control Monitor (Optional)
5	-	Not Used
6	-	Signal Ground
7	-	Power Supply Ground
8	-	V - (-8 to -24VDC)
9	-	Threshold Monitor (Optional)

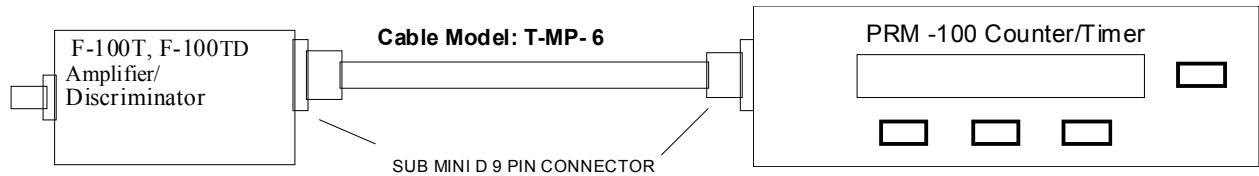
**Figure 2. Power connector pin-Out.**



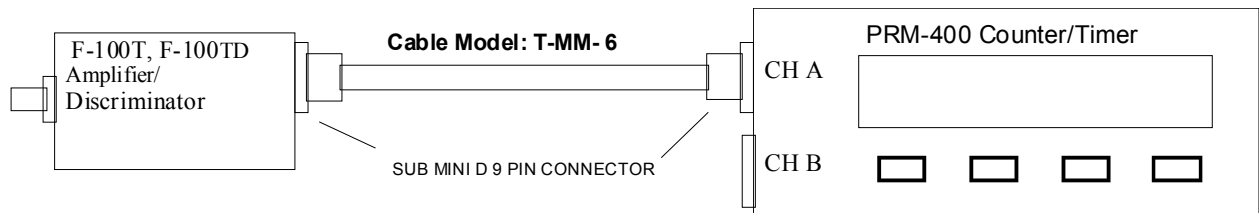
**SYSTEM PART NO.: F-100TPS**



**SYSTEM PART NO.: PRM-100T**

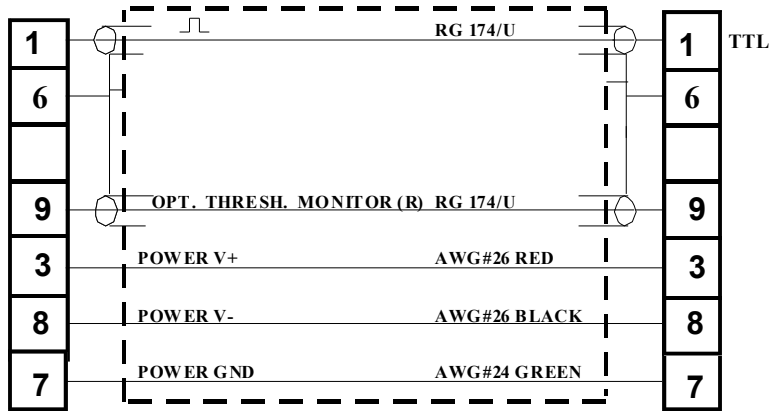


**SYSTEM PART NO.: PRM-400T**

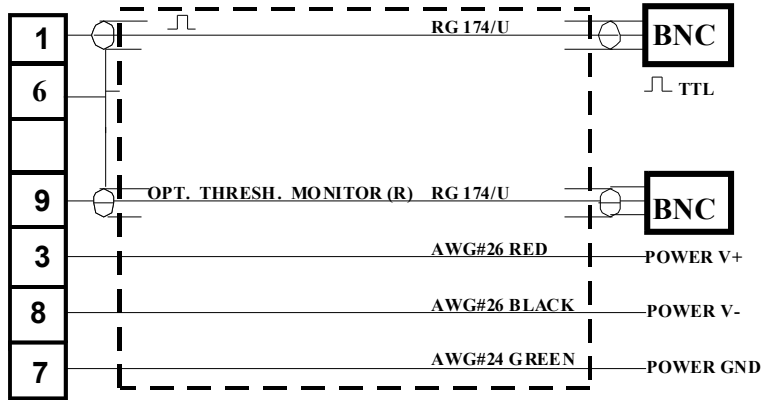


**Figure 3a. Cable Selection Guide.**

**Cable Model: T-MP-6**  
(F-100T to PRM-100 or to F-100PS)



**Cable Model: T-CUM-6**  
(F-100T OPEN ENDED CABLE)



Connectors: 9pin Submin.D Female

**Figure 3b. Cable Diagrams**

## Potential Problems

Two potential problems may be associated with the 50 $\Omega$  termination. These are discussed as follows:

- Some rate-meters or counters may have only a high impedance input available, therefore an external terminator must be used.

If your rate meter does not have 50 $\Omega$  input impedance, you can easily modify it by attaching a metal film or carbon resistor across the input. Do not use wire-wound resistors because they tend to have high inductance. If modifying the input is not feasible, a BNC "tee" adaptor may be used with a BNC 50  $\Omega$  terminator. The 50  $\Omega$  terminators are available from Advanced Research Instruments Corp. or any major electronic supplier.

- The 50 $\Omega$  terminator reduces the pulse height to +3.0V, which may not be sufficient for some rate meters to detect.

If the +3.0V pulse height is insufficient for your rate meter or counter, you might consider an unterminated signal connection; but only if the physical length of the coax cable is less than approximately one meter. The shorter the connection, the safer it is to use the unterminated cable.

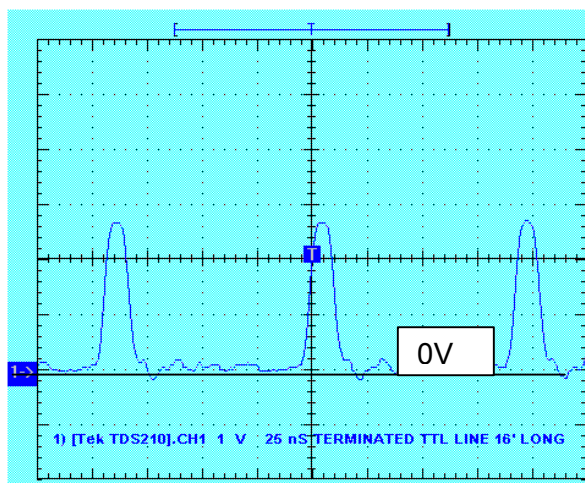
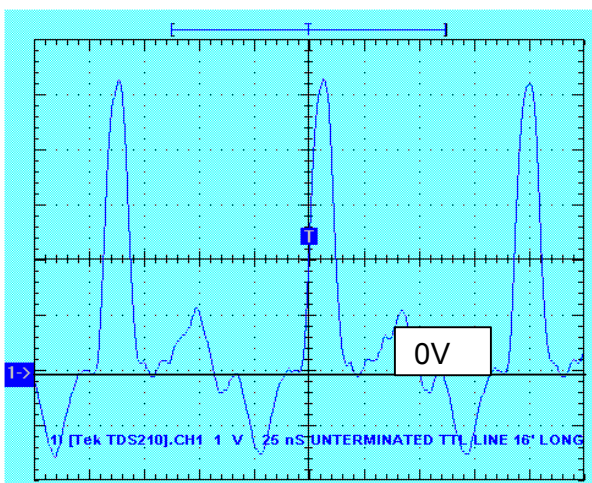
The decision as to whether to use a terminated cable must be based on the input specifications of the your counter/timer/rate meter. A fast, sensitive rate meter (>20 MHz, with sensitivity <1V) always requires proper termination. A relatively slow rate meter usually has an input sensitivity control or a threshold adjustment that can be used for input signals of .1V to 25V and high input impedance. In this case, although external termination for a short cable may not be absolutely necessary, it is nevertheless recommended. The 3.0V signal level, with a properly adjusted input threshold to about 1V is the best solution. A long cable longer than 15 feet (>5 meters) must almost always be terminated.

The following examples (Figures 4a and 4b, on page 7) show significant improvement of reflectance, for a terminated cable compared with an unterminated one.

The most significant value is the positive excursion of the ringing value, since the tripping threshold for the TTL signals is about +0.7V minimum. The +1.0V glitch on the unterminated cable will very likely produce a double pulsing.

The problem is most severe when a high frequency and high sensitivity counter is used. When selecting the counter/timer/rate meter, make sure that only the signal pulses are being counted. Measurements on a shorter cable indicate only minor ringing amplitude. So it is possible to use even unterminated cables, but only if an input threshold is, or can be adjusted safely above the ringing level.

Or, you could use high-threshold integrated circuits such as 7414, 74LS14, 74S14, 74HC series, etc., on the input of your counter/timer or rate meter.



**Figure 4a. 16 feet of unterminated 50Ω cable. Note the +1.0V glitch that may be detected by the counter as a second pulse.**

**Figure 4b. The same 16 foot 50Ω terminated cable. Note the absence of glitches but the pulse height is reduced to**

**Figure 4. Example of Ringing Reduction by 50Ω Termination  
(Horizontal: 25 ns; Vertical: 1V/div)**

To conclude, most TTL signals do not need termination unless long coaxial cables are involved. If you terminate the cable, ringing is reduced significantly; unfortunately, the signal is thereby reduced to about half its original amplitude. If this is a problem, an intermediate solution may be the answer. A 100Ω terminator on a 50Ω cable produces only slightly larger ringing than a 50 Ω terminator, but the pulse amplitude is only slightly less than the original.

### Input Considerations

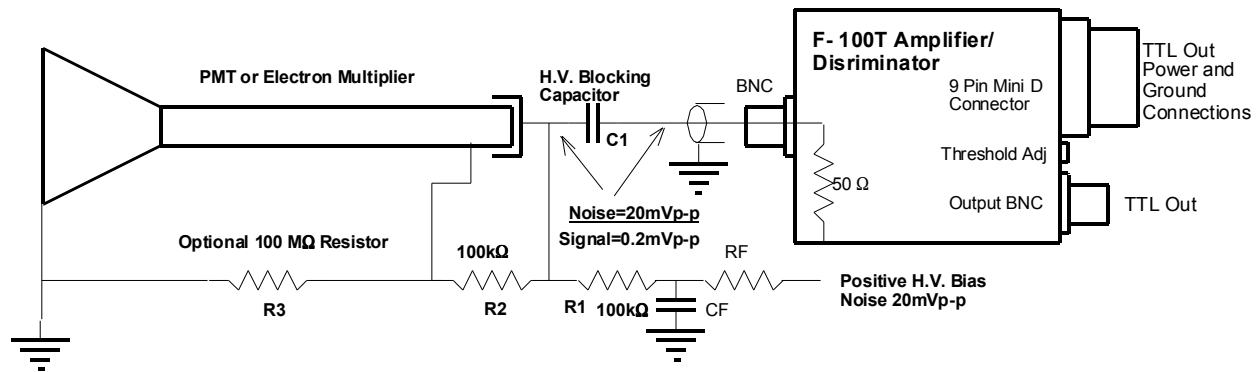
The input connection is far more critical than the output connection. High sensitivity input requires the shortest possible connection to the PMT or to an electron multiplier. Also, the noise in the input signal or in the input ground connection may be eliminated by setting the discriminator to the lower sensitivity region. However, this will reduce the overall performance.

Bear in mind that the 100 μV input sensitivity of the F-100T preamplifier is about the same as most radio and television receivers, except with a much larger bandwidth (making the situation much more critical). Also the preamplifier must operate in an electrically hostile environment without responding to the severe interference of switching power supplies, the R.F. part of mass spectrometers, computers, SCRs, etc.

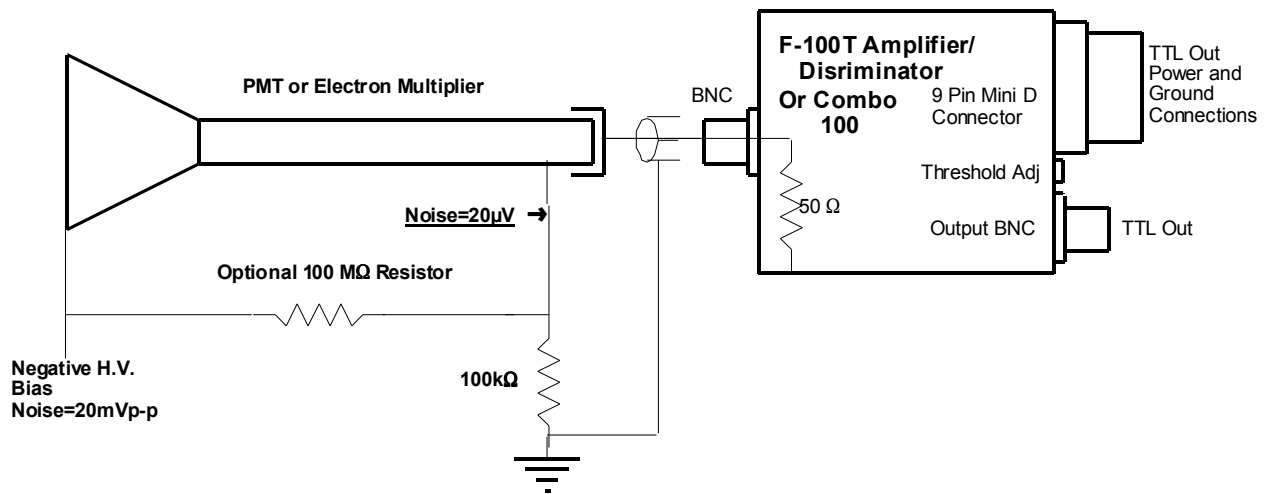
These interference sources are a serious threat to an interference-free operation of the preamplifier, especially if they are located in the vicinity of the detector/preamplifier. Therefore, good R.F. grounding and shielding rules must be strictly observed.



Preamplifiers are normally set to accept negative pulses since all PMT's and electron multipliers produce such pulses. Although the input of the F-100T is compatible with either a positive or a negative biasing scheme of the PMT, the details may vary substantially. Therefore, be sure to examine your particular bias diagram and compare it with Figure 5.



**Figure 5a. Electron Multiplier Bias with Positive Supply**



**Figure 5b. Electron Multiplier Bias with Negative Supply**

**Figure 5. Electron Multiplier Bias**

Note, there is no high voltage blocking capacitor in the F-100T. If the detector biasing system requires such isolation, the capacitor must be located outside the F-100T preamplifier, or a different preamplifier with built in blocking capacitor network may be used, such as MTS-100.

Finally, for the input connection itself, use a BNC-to-BNC adaptor or a very short cable. Under some circumstances an additional ground strap may be necessary.

## OPERATION

### Connecting and Disconnecting Your Preamplifier

#### CAUTION

Before applying power, recheck the low voltage polarity.  
Reversed +V with -V may destroy the preamplifier!

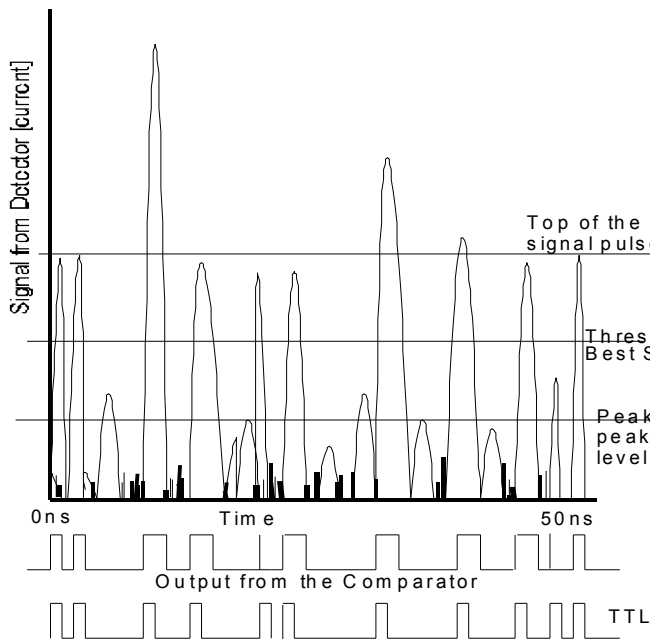
Although the input to the F-100T is protected against high voltage spikes, do not connect or disconnect the input with high voltage bias applied to the detector. Use the following procedure to ensure virtually trouble-free performance in your preamplifier:

- To connect the preamplifier to the detector, first make the connection, then turn on the high voltage.
- To disconnect the preamplifier from the detector, first turn off the high voltage, then wait 5-10 seconds. Then you may safely disconnect the preamplifier.

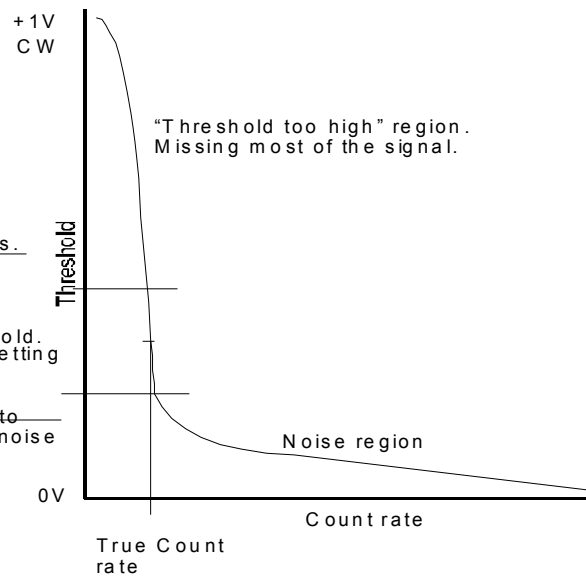
### Discriminator Set Up

The discriminator is factory set to the position that works well for the Advanced Research Instruments PMT test system.

However, this setting may need to be changed for different systems and different bias settings. Consider Figures 6 and 7.



**Figure 6. Typical signal from the detector and the threshold setting. The output from the comparator and the final TTL output from the F-100T.**



**Figure 7. Relationship between the threshold position and resulting count rate**

Figure 6 shows signal and noise coming from the linear preamplifier just before it enters the discriminator for thresholding. When the threshold trimmer is turned fully counterclockwise, the threshold is buried in noise (input noise plus preamplifier noise), and the F-100T may produce high count rate pulses even if no signal is present (see Figure 7).

Note the count rate when the threshold is set close to zero. Since this is an unacceptable situation, the solution is to increase the threshold by turning the trimmer clockwise until the noise disappears:

- Perform this adjustment with the F-100T connected to the detector and the rate meter.
- Be sure that when you perform the adjustment that power is applied to the F-100T, but without the high voltage applied to the detector.

**Note: If there are no pulses, even with the discriminator fully counterclockwise, the noise level might be below the minimum detectable threshold, or additional problems may be present.**

With the signal source (photons, electrons, etc.) turned off, turn on the high voltage and slowly increase to the approximate operating range. (If no H.V. adjustment is feasible, then just turn it on).

Noise should increase because the bias background is significantly higher than the noise of the preamplifier. Increase (turning clockwise) the threshold above the noise level. A count rate of 1 to 5 cps may be acceptable. The background count rate is usually determined by the quality of the detector or the entire experimental set-up.

Now apply the signal to your detector (PMT or electron multiplier). The count rate should increase to the correct level.

With the signal applied, increase the threshold by turning the threshold trimmer further clockwise, and note the change in the count rate. There should be minimal change within certain ranges. i.e., the "best setting," as shown in Figure 7. When you reach a threshold setting that is too high, the count rate drastically drops off. The best setting is approximately in the middle between the noise level and loss of the signal. An ideal detector would produce signal pulses all of the same height and in that case, there should be no change in the count rate when changing the threshold within the indicated range in fig. 6. In addition, one would observe an abrupt and complete loss of signal when the threshold passes the top of the uniform pulses. This is easily demonstratable by replacing the detector with a pulse generator. Any real detector however will produce non uniform signal pulses with approximately Gaussian pulse height distribution.

If you cannot locate the point of losing the signal, this indicates unnecessarily high voltage to the detector. Reduce this voltage to the level where you can observe the output change with respect to the threshold shown in Figure 7. The best setting range should not be greater than 1-2 turns of the threshold trimmer. If you cannot reduce the detector voltage as described, you may operate at the higher voltage without any damage to the preamplifier.

Check the "best setting" at least once a year to assure that detector aging or changes in the high voltage bias do not shift the threshold out of the correct setting range.

Blank page

USER NOTES:

## TROUBLE-SHOOTING GUIDE

### No Output Pulses

First check the D.C. supply voltage. Unplug the 9pin cable from the preamplifier and measure the voltage on the cable connector. You should see +8V to +24V on pin 3 and -8V to -24V on pin 8, relative to pin 7 (power ground).

Then, disconnect the input connector and turn the discriminator control fully counterclockwise. With a piece of wire touch the center pin of the input connector. This should produce plenty of a signal on the output. If you suspect that the F-100T may have insufficient sensitivity, check the "Sensitivity Measurement" section. If no signal appears at the output, the preamplifier may need to be repaired.

However, if the preamplifier appears to be functioning, then you should consider the detector, its power supply, or even the signal source itself.

Use an oscilloscope or different preamplifier to make sure the detector is producing a useful signal. If it is, you may have to slightly increase the H.V. bias on your detector. The reason for this is because some slower preamplifiers are even more sensitive than the F-100T and it is possible that the signal produced by your detector at this bias setting is below the sensitivity level of the F-100T.

### Too Much Noise

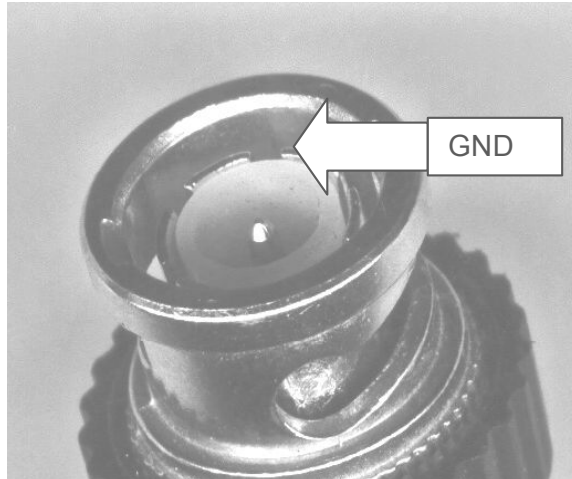
First, determine where the noise originates, whether in the amplifier itself, or from another source.

To find out where the noise is coming from, disconnect the input to the preamplifier, and if the noise persists, check the noise level on the positive and negative supply. The noise level should be less than 10mVp-p 120Hz and a high frequency noise even less. Check the supply ground connection and if there is no obvious power supply problem, then the preamplifier needs to be repaired.

If the noise disappears when you disconnect the input, then the noise is originating at the detector, or in the way the preamplifier is connected to the detection system.

To find out the source of the noise in the detection system, first turn off the detector's bias supply and the signal source, and reconnect the preamplifier to the detector. If the noise persists, try to locate its level by turning the discriminator trimmer clockwise until the noise disappears. If the noise is too high to be eliminated by the trimmer, check the input connections for a missing ground or shielding connection. The input signal conductor should not be exposed anywhere, from the detector to the preamplifier. Good R.F. rules must be observed so as not to turn the input connection into a receiving antenna.

One of the less obvious "missing ground" problems in the connection may be found in the BNC connector itself. In some cases, an intermittent noise is detected, especially when the preamplifier is touched or moved. Such a symptom usually indicates a poor ground connection at the input. The most likely culprit is the BNC connector. Check the ground connection at the BNC connector where the ground shroud of the male connector mates with the female. The shroud may be collapsed and failing to make solid ground connection. Fix or replace the male connector.



**Figure 8. Missing Ground in the BNC Connector. The ground shroud in the BNC connector may be responsible for poor ground connection.**

When you successfully locate the noise level with the discriminator trimmer, the next step is to lower it to an acceptable level via improved grounding and shielding.

When the noise level is below the minimum threshold setting, turn on the detector's bias and note any changes of the noise level. A slight increase is normal. A drastic increase of noise points to either a noisy bias supply or an H.V. insulations breakdown.

Check the noise level of the supply, if your biasing is similar to Figure 5a and make sure there is a low pass filter installed in the high voltage line before it reaches the detector (see Figure 5a, capacitor CF.) Since even the best supplies may have a 2-50 mV high frequency ripple that may be directly coupled to the input of the preamplifier, you may need to get a better H.V. supply such as ARI's model PMT-2000.

If your biasing corresponds to Figure 5b, you are using a negative high voltage supply and your preamplifier is connected to the ground side of the supply. The ripple in this arrangement is not critical because only a small portion of it reaches the preamplifier.

Attention should instead be focused on the H.V. breakdown effect where the most likely cause is contamination or device break down.

**Note: In many experimental set-ups the researcher forgets the high frequency grounding and shielding rules. Then any high and unpredictable noise is usually blamed on the preamplifier, since that is where the noise shows up.**

## Double Pulsing

The count rate is consistently about twice or even triple the rate it is supposed to be. This condition is usually the result of a poor connection between the preamplifier and the detector such as:

- Ground connection
- Mismatched impedance of various connectors
- Vacuum feedthrough devices
- Exposed input signal connection

This poor connection results in a standing wave condition on the input of the amplifier that may produce one or more extra pulses for each authentic pulse arriving from the detector.

Raising the threshold of the discriminator usually solves the problem. However, if good R.F. practice was not followed when the input connection was done, standing waves may be so severe that the preamplifier will enter sustaining oscillations.

Avoid severe ringing. Here is the primary rule that must never be compromised: the connection from the detector to the input of the preamplifier must be done with a 50  $\Omega$  impedance coaxial cable as short as possible, without exposing the center conductor at feedthrough or anywhere else.

Any compromise at all of this primary rule results in the increase of the standing wave condition (ringing) and an unnecessary high threshold level of the discriminator to avoid the double pulsing.

Double pulsing can also occur on the output of the preamplifier if a long and unterminated cable connects the preamplifier to a counting system such as a rate meter. This is perhaps the easiest problem to rectify.

Just terminate the connection on the rate meter side with a 50  $\Omega$  or 75  $\Omega$  resistor and make sure there is enough signal for the counting system to use. Use a 50  $\Omega$  resistor for a 50  $\Omega$  cable, and 75  $\Omega$  resistor for 75  $\Omega$  cable. If the 50  $\Omega$  termination is reducing the pulse amplitude excessively, you may have to resort to a 75  $\Omega$  cable termination system.

## Sensitivity Measurement

The sensitivity measurement is relatively simple, but requires some test equipment and an impedance matching network at the input of the amplifier. The F-100TV9 is transimpedance amplifier thus a current sensitive amplifier and requires a current input. Since most of the pulse generators have only low impedance 50 $\Omega$  output, this has to be converted to a current signal via 2k $\Omega$  resistor located directly at the input of the amplifier. To produce the minimum detectable current signal at the input, apply a negative pulse of 4mV amplitude and less than 5ns rise time to the 2k $\Omega$  input resistor. The resulting  $4\text{mV}/2\text{k}\Omega=2\mu\text{A}$  pulse will be converted into a TTL voltage pulse at the output of the F-100T if the threshold is set close to zero [fully counterclockwise]. The 2 $\mu\text{A}$  input signal would appear as 100 $\mu\text{V}$  at the input due the 50 $\Omega$  input impedance of the amplifier. When you increase the threshold above the top of the signal [clockwise turn or two] the output should disappear. In the same way 320mV should produce 8mV at the input and should be detectable with the discriminator setting close to fully clockwise. The 8mV signal is the top of the linear range of the input amplifier. Any further increase in the signal will result in saturating the linear amplifier and no further increase in the amplified pulses. This way, the discriminator is actually detecting the input signal level and the sensitivity. If a much larger signal is required for the detection, that indicates lower than standard gain and the amplifier should be repaired.

## Reducing Power Supply Induced Noise

Noise is one of the basic limitations of virtually any signal detection system: this is true no matter how advanced the system is. However, "excess noise," defined as noise above the theoretical limits, can often be virtually eliminated.

The most common sources of excess noise are poor shielding, poor grounding, and noisy power supplies. Since the noise induced by power supplies is the easiest to spot and remedy, the following paragraphs deal with reducing this type of noise.

### Using a Suitable Power Supply to Reduce Noise

Those who have system noise often comment that the power supply cannot be responsible. They say they have checked the specifications and they are "incredibly good."

However, the facts are often otherwise. For example, a typical high quality, high voltage, power supply specification may indicate noise less than .001% of the output voltage. Sounds good, but is it? Let's say the high voltage is 2000VDC. The .001% represents a 20mV noise level. Many detector/preamplifier configurations use a positive H.V. biasing technique directly coupling this noise to the preamplifier and therefore directly determining the minimum detection limit (see Figure 5a, on page 8).

### Noise from the Positive H.V. Supply

When a positive H.V. supply is used (see Figure 5a) the noise from the supply enters the preamplifier via R1 and C1 with almost the same amplitude as at the power supply. Note that we are trying to detect pulses of amplitude of 0.2mV in the presence of almost 20mV noise.

Yet, the detector/preamplifier (i.e., an F-100T preamplifier) system may be capable of detecting and processing signals as low as 100 $\mu$ V. The 20mV noise degrades the detection level from 100 $\mu$ V to 20mV. This problem can be remedied by obtaining an H.V. power supply with noise less than 100 $\mu$ Vp-p, such as the Advanced Research Instruments model PMT2000-2k Series.

### Noise Reduction by Negative H.V. Biasing Technique.

If a negative H.V. biasing technique (see Figure 5b) is used, the 20 mV noise does not appear directly at the preamplifier's input. The residual noise reaching the preamplifier is only 20 $\mu$ V, well below the detection capability of the system. The H.V. is applied to the front end of the detector while the output from the detector is at virtual ground. When the preamplifier is electrically at the ground side of the biasing system, the preamplifier will see only a small fraction of the power supply induced noise, in other words, a negligible noise level. Even higher noise levels than this may be quite acceptable.

Additional benefits of negative H.V. biasing are:

- The output of the detector is at virtual ground potential and can be DC coupled to the input of the preamplifier. This direct coupling eliminates an H.V. blocking capacitor and the necessary additional wiring, so that a potential source of noise is eliminated.
- DC current can be measured as the signal, when the count rate exceeds the maximum count rate



of the pulse processing channel.

- When pulses and a DC component both are present, a special dual channel preamplifier such as a COMBO-100 can be used. The COMBO-100 processes a low intensity signal as pulses, and it processes the high intensity signal as a DC voltage proportional to the intensity.

A disadvantage of the negative biasing technique is the presence of the high negative potential at the detector's front end. This negative potential prevents negatively charged particles from being detected and tends to collect any positive spurious ions, thus increasing the background count. Because of the higher background count, the negative H.V. bias scheme is not recommended for applications with signal intensities (count rates) just slightly above the background level. It should be used only for those applications in which the processing of higher count rates is more important than a low background.

### **Positive H.V. Biasing.**

This technique can be used to advantage in some situations. For example, a photo multiplier tube can be operated at lower dark current or background level. Also, positive H.V. biasing can be used to bias a charged particle detector, so the front end of the detector is at ground potential, or at a slight positive or negative bias to attract charged particles of given polarity. A disadvantage of this technique is the need for an H.V. supply with a noise level below the detection capability of the detector.

Summary. As we can see, both positive and negative biasing techniques present advantages and disadvantages. So if you want to improve the sensitivity and detection limits of your detector, you will want to consider the constraints of a given application, plus the limitations described above. Then you can better evaluate and choose a particular biasing arrangement and define the necessary specifications for the H.V. power supplies.

## PHOTON COUNTING APPLICATIONS

Two applications are discussed: how to optimize photon counting and how to automate your data acquisition.

### How to Optimize Photon Counting

The best way to perform very low light level measurements is by counting individual photons with a photo multiplier tube (PMT) and associated counting electronics.

When we use the PMT for counting individual photons, we are usually concerned with the background level (dark count) as well as the accuracy at the maximum count rates. The background count rate creates the low light level limit---the point at which the signal becomes smaller than the background fluctuation.

We can use high pulse pair resolution to improve accuracy at high count rates, thus minimizing the error caused by pulse pile-up and the resulting loss of counts.

So the best PMT systems feature the lowest possible background count coupled with the highest pulse pair resolution.

The following two sections explain how to minimize the background count and to maximize the useful count rate.

### How To Minimize the Background Count

Select a PMT with the certified lowest dark count rate, usually specified at a given temperature and bias voltage.

Lower the operating temperature by cooling the PMT to the lowest level that is practical.

#### **CAUTION**

**Too low a temperature may result in moisture condensation on the tube and cause problems with the high voltage bias.**

Lower the high voltage bias so that the signal (incoming photons) can be comfortably detected, (i.e., the threshold is safely above the noise level but not too high). To do this, you need a good preamplifier. The F-100T preamplifier is probably the best choice because it combines high sensitivity with high pulse pair resolution.

Minimize light leaks. This suggestion sounds so obvious it seems ridiculous to even mention it. But experience shows that a light leak is the most common culprit when it comes to minimizing background count. For example, just as a simple test, if you think there is a light leak in the system, try turning the room lights off and on and note the change of the background count rate.

## **Maximizing the Useful Count Rate**

You'll need to get the minimum pulse width your system can handle, since the maximum count rate is limited by the pulse pair resolution. For example, the F-100E preamplifier coupled with the PRM-100 precision rate meter is a system capable of processing pulses only 5ns wide, which results in counting frequencies of up to 75 MHz. Even higher count rate [up to 400 MHz] can be obtained from a F-400E and PRM-400 system.

The key word here is "frequency" rather than "count rate." "Frequency" implies a periodic wave form, or pulses equally spaced, which is not usually the case in which intensities are measured (ion, photon, electron counting, or X-Ray intensity measurements). So the pulse overlapping probability that results can be described statistically by the Poisson distribution function.

The measurement here consists of the number of counts during a fixed period of time, regardless of spacing or distribution. This gives us an average number of counts during that period. This number is usually recalculated to give us a number of counts per second (CPS).

For a given pulse pair resolution, the closer we approach the 5ns limit, the more likely we are to encounter pulses closer than our pulse pair resolution and the more often we lose them. However, the loss is statistically predictable, and we can correct for it using the Poisson distribution function and push the maximum count rate a bit closer to the maximum frequency.

## **How to Automate Your Data Acquisition**

The PRM-100, coupled with a computer possessing a fast parallel interface, becomes an intelligent, easy to use, fully automated system when attached to virtually any spectrometer. To control the spectrometer (to change the wave length, etc.), the parallel interface provides a driver for a low-power stepping motor and input for a set of limit switches.

The computer can be programmed to provide flexible intelligence to the system, to adapt specific requirements for a particular measurement, to improve accuracy, to store data for subsequent analyses, or to simply archive many spectra on a mass storage media.

Since most spectrometers are driven by a synchronous motor which produces a constant speed movement of the wave length selector shaft, a strip chart recorder can be driven at the same speed to produce a wave length vs intensity chart.

Although the PRM-100 produces an analog output compatible with most strip chart recorders, there is an easier, more accurate, and less expensive way to produce a wavelength vs. intensity chart. Just use any personal computer to do the data acquisition, and store and plot the charts on a dot matrix printer.

Also, to automate the acquisition of X-Ray diffraction patterns and have them readily available for further processing, Advanced Research Instrumentation Inc. provides software, which is specifically designed for an X-Ray diffractometer. This software can be easily tailored to particular spectrometers, typically without any additional expense.