

RCA THOMSON



U
S
E
R
M
A
N
U
A
L

Thomson multimedia Inc.
 10330 N. Meridian St.
 Indianapolis, IN 46290
 ©2001 Thomson multimedia Inc.
 Trademark(s) © Registered
 Marca(s) © Registrada(s)
 Marque(s) © Déposée(s)
 55164850 (EN/F/E)
 www.rca.com

RP2419/RP2420/
 RP2421/RP2422/
 RP2425/RP2427/
 LAD885/LAD885U
 LAD890RC/LAD890U

SAFETY INFORMATION

EN FCC Information

This device complies with Part 15 of the FCC Rules. Operation is subject to the following two conditions: (1) This device may not cause harmful interference, and (2) this device must accept any interference received, including interference that may cause undesired operation.

In accordance with FCC requirements, changes or modifications not expressly approved by Thomson multimedia Inc. could void the user's authority to operate this product.

This device generates and uses radio frequency (RF) energy, and if not installed and used properly, this equipment may cause interference to radio and television reception.

If this equipment does cause interference to radio or television reception (which you can determine by unplugging the unit), try to correct the interference by one or more of the following measures:

- Re-orient the receiving antenna (that is, the antenna for the radio or television that is "receiving" the interference).
- Move the unit away from the equipment that is receiving interference.
- Plug the unit into a different wall outlet so that the unit and the equipment receiving interference are on different branch circuits.

If these measures do not eliminate the interference, please consult your dealer or an experienced radio/television technician for additional suggestions. Also, the Federal Communications Commission has prepared a helpful booklet, "How To Identify and Resolve Radio TV Interference Problems." This booklet is available from the U.S. Government Printing Office, Washington, DC 20402. Please specify stock number 004-000-00345-4 when ordering copies. This product complies with DHHS Rules 21 CFR Subchapter J. Applicable at the date of manufacture.

WARNING: TO PREVENT FIRE OR ELECTRICAL SHOCK HAZARD, DO NOT EXPOSE THIS PRODUCT TO RAIN OR MOISTURE.

For Your Records

In the event that service should be required, you may need both the model number and the serial number. In the space below, record the date and place of purchase, and the serial number:

Model No.
Date of Purchase
Place of Purchase
Serial No.

Service Information

This product should be serviced only by those specially trained in appropriate servicing techniques. For instructions on how to obtain service, refer to the warranty included in this Guide.

This Class B digital apparatus complies with Canadian ICEC-003.
Cet appareil numérique de la class B est conforme à la norme du NMB-003 du Canada

	CAUTION RISK OF ELECTRICAL SHOCK DO NOT OPEN	
THE LIGHTNING BOLT AND ARROW HEAD WITHIN THE TRIANGLE IS A WARNING SIGN ALERTING YOU OF DANGEROUS VOLTAGE INSIDE THE PRODUCT.	CAUTION: TO REDUCE RISK OF ELECTRICAL SHOCK DO NOT REMOVE COVER (OR BACK). NO USER SERVICEABLE PARTS INSIDE. REFER SERVICING TO QUALIFIED SERVICE PERSONNEL.	THE EXCLAMATION POINT WITHIN THE TRIANGLE IS A WARNING SIGN ALERTING YOU OF DANGEROUS VOLTAGE INSIDE THE PRODUCT.
SEE MARKING ON BOTTOM / BACK OF PRODUCT		

SAFETY INFORMATION

Thomson Information

CAUTION!

Invisible laser radiation when open. Avoid exposure to beam. Class I laser product. This system must be opened only by qualified technicians to prevent accidents caused by the laser beam.

LASER $\lambda = 780 \text{ nm}$, $P_{\text{max}} = 5 \text{ mW}$
Rating Information: At bottom of the unit this unit comply with the existing requirements

In accordance with the rating plate of the unit, this unit complies with current standards concerning electrical safety and electromagnetic compatibility.



ADVARSEL!
USYNLIG LASERSTRÅLING VED ÅBNING NÅR SIKKERHEDSAFBRYDERE ER UDE AF FUNKTION - UNGDA UDSÆTTELSE FOR STRÅLING.
VORSICHT!
UNSICHTBARE LASERSTRÅLUNG WENN ABDECKUNG GEÖFFNET UND SICHERHEITS-VERRIEGELUNG ÜBERBRÜCKT.
NICHT DEM LASERSTRAHL AUSSETZEN!

CAUTION - INVISIBLE LASER RADIATION WHEN OPEN AND INTERLOCKS FAILED OR DEFEATED. AVOID EXPOSURE TO BEAM.
ATTENTION - RAYONNEMENT LASER INVISIBLE DANGEREUX EN CAS D'OUVERTURE ET LORSQUE LA SECURITE EST NEUTRALISEE. EXPOSITION DANGEREUSE AU FAISCEAU.



CLASS 1 LASER PRODUCT
LASER KLASSE 1
APPAREIL A LASER DE CLASSE 1
LUOKAN 1 LASERLAITE
KLASS 1 LASERAPPARAT

WARNING -
OSYNLIG LASERSTRÅLING NÅR DENNA DEL ÄR ÖPPNAD OCH SPÄRRAR ÄR URKOPPLADE.
BETRÄKTA EJ STRÅLEN
VARO!
AVARTRESSA JA SOUJALUKITUS OHITETTAESSA OLET ÄLTTINA NÄKYMÄTTÖMÄLLÄ LASERSTEILYKLE ALÄ KATSO SÄTEESÄN.



Have a Blast- Just Not in Your Eardrums
Make sure you turn down the volume on the unit before you put on headphones. Increase the volume to the desired level only after headphone are in place.



Please respect the environment! Before throwing any batteries away, consult your distributor who may be able to take them back for specific recycling.

THE CD PLAYER

EN

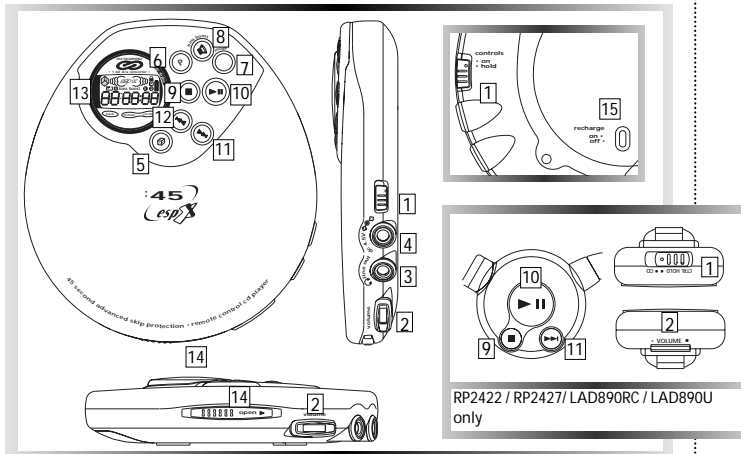

- | | |
|---|---|
| <p>1. CONTROL switch. To lock or unlock the buttons</p> <p>2. VOLUME button. To adjust the volume.</p> <p>3. Line Out /Headphones Jack. Insert your headphones here.</p> <p>4. DC Jack. You can insert the adapter instead of batteries for indoor use.</p> <p>5. For random playback.</p> <p>6. P button. To program & display.</p> <p>7. MODE button. For repeat or introscan function.</p> | <p>8. Press to adjust Bass Boost level.</p> <p>9. STOP button. Press to stop CD play.</p> <p>10. PLAY/PAUSE button. Press to play or pause CD.</p> <p>11. Skip / search forward track</p> <p>12. Skip / search backward track</p> <p>13. Display Panel. More information on Page 6.</p> <p>14. OPEN switch. Slide to open CD door.</p> <p>15. Recharge switch. To recharge batteries.</p> |
|---|---|

3

THE CD PLAYER

EN

Model Number	AC/DC Adaptor	Batteries
RP2419 / RP2420 / RP2421 / RP2422 / RP2425 / RP2427	5-4079B (US - Not Included Canada - Included) Required Rating: Input: 120VAC 60Hz 6.0W Output: 4.5VDC @ 600mA	AAx2 (Not Included)
LAD890RC / LAD885 / LAD890U / LAD885U	5-4079B (Included) (230V 50Hz)	AAx2 (Included)

AC OUTLET POWER SUPPLY

(Not Included with US models)

You can power your CD player with the supplied AC/DC adaptor. Refer to the table for details of the operating voltage of the adaptor supplied with your unit.

AC/DC adaptor is purposed for indoor use in dry rooms only. Remove the jack from the device to use it with the batteries.

Note : Power is fed to the unit even when it is not functioning. To cut the power supply off, the AC/DC adaptor must be unplugged.

CAR (DC) POWER SUPPLY

ADAPTOR (For RP2425 / RP2427 only)

Plug the car (DC) power supply adaptor into the DC in 4.5V jack at the rear/side of the CD player & then into the cigarette lighter receptacle in your car

BATTERIES POWER SUPPLY

Refer to the table for details of the batteries required to operate your unit.

Recharge function (For LAD890RC / LAD885 / LAD890U / LAD885U only) — To charge Ni-Cd batteries (not included):

Insert 2 rechargeable batteries in the compartment. Turn the switch to the ON position at the back of the unit. Connect the main adaptor. The batteries take about eight hours to become fully charged if the player is not operating.

Important : If you use your CD player with non rechargeable batteries, turn OFF the switch at the back of the unit in order to prevent any damage to the unit or batteries.

4

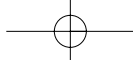

THE CD PLAYER

EN Listening to a Compact Disc

- Slide the **OPEN** switch to the right to open the door. Insert a disc and press lightly on the centre to lock. Close the door. Press **PLAY/PAUSE** button. **Rd DISC** will appear in the display. Then, the total number of tracks and time of the CD will be displayed. If the disc compartment is empty or the disc cannot be played, No Disc will appear in the display.
- You can also change tracks or quickly listen to part of a track by pressing down or holding or .
- Slide **CONTROL** switch to **HOLD** position to lock the button to avoid accidental activation of unwanted functions.

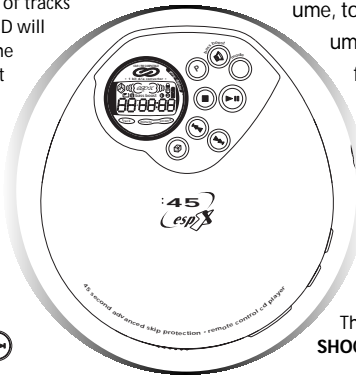

The **ELECTRONIC SHOCK PROTECTION*** system prevents sound interruptions when impacts or vibrations occur. Electronic anti-shock consumes less

power and increases the battery life. Therefore, the **ESPX** function is always **ON**. After many successive impacts, the buffer might be emptied causing a brief sound interruption for the memory to reload. The buffer is 45 seconds long.

Listening to a CD in your car (For RP2425 / RP2427 only)

- Select a power source (either battery power or the car DC adaptor)
- Insert the cassette adaptor into the

- tape deck and plug the cord into the CD player's **HEADPHONES** jack.
- Insert a compact disc and press **PLAY/PAUSE** button. Adjust CD player's volume to a mid level (make sure the Bass Boost is turned off).
- Use the car stereo to adjust volume, tone. Adjust the volume of your CD player for better volume control.
- Before ejecting the cassette after you have finished listening, make sure the car stereo's volume is turned down.

THE CD PLAYER

EN

Repeating/Intro scan

You can replay the entire CD or one track as many times as you wish as well as listen to the beginning of each track for 10 seconds.

Press **MODE** successively to

1. Replay the entire CD .
2. Replay the current track.
3. Play the beginning of each track for 10 seconds.

(The number of the track being played will be displayed and **SCAN** will appear.)

4. Press again to the function de-select.

Note : To prevent excessive battery consumption, the unit switches off automatically in all modes after 30s if no key has been activated.

You can program up to 24 tracks. To play your program again, press play. To add/edit tracks to the program, go to stop mode ; press and hold **P** button again. Refer to step 2 of the above paragraph.

Press **P** to turn program mode on, then press **PLAY/PAUSE** and to check the program.

Program

This function lets you listen to the tracks you selected in the order you want. The CD player must be in Stop mode.

1. Press **P** button. **P** will appear in the display.
2. Select the track to store by pressing or & press **P** again to confirm.
3. Return to step 2 to store other tracks.
4. Press **PLAY/PAUSE** button to listen to your programming.

To cancel your program, press and hold the mode key when you are in the stop mode. **ERASE** will appear in the display. The program will be automatically canceled. To exit program mode, remove **P** from the display by pressing **STOP** then **P**.

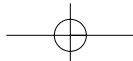

THE CD PLAYER

EN Random tracks play (MIX for Thomson & SHUFFLE for RCA)

1. Listen press **PLAY**

2. Press  key.

To cancel this function, De-select 

PAUSE

Suspend the playback by pressing **PLAY/PAUSE button**. The minutes and seconds flash when interrupted

STOP

Stop playback by pressing **STOP button**. The player switches off automatically after 10 seconds. Press twice stop key to stop your CD player.

REMAIN TIME

Display remaining time in the play mode, at play mode Press **P** display information about CD playing time.

THE DISPLAY

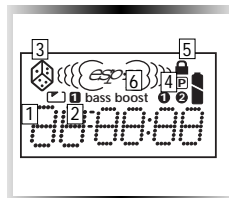

1. Repeat entire disc.
2. Repeat current track.
3. **RANDOM TRACKS**
4. **PROGRAM**
5. Is displayed when the control button is on **HOLD** position.
6. Is displayed when Bass Boost is **ON**. Press **BASS BOOST** momentarily to toggle between Bass Boost 1, Bass Boost 2 and off.

MORE INFORMATION

MORE INFORMATION USEFUL ADVICE

- Do not store CDs in damp areas.
- Do not expose CDs to high temperatures.
- Do not put any tape or adhesives on either side of the disc.
- You should avoid leaving the CD door open. Dust is liable to impair performance of the laser optical unit.
- Do not use your set immediately after transport from a cold place to a warm place : there may be condensation problems.
- Do not touch the playing surface. Make sure that you keep your set away from water and high temperatures.
- If you do not use your set on battery power for more than one month, we advise you to take out all the batteries.
- To prevent personal injury, do not reverse any battery and do not mix battery types.
- Discard leaking batteries immediately. Leaking batteries can cause skin burns or other personal injury.
- Thomson recommends Duracell Ultra Batteries.
- Prolonged use of the CD player at full volume can damage the user's ear.

SPC: Sound Pressure Control at 100dB maximum (only for Thomson models)

PLEASE RESPECT THE ENVIRONMENT !

Before throwing any batteries away, consult your distributor who may be able to take them back for specific recycling.

MAINTENANCE

Clean the player with a soft cloth, or a damp chamois leather. Never use solvents.

Notes on CD-R/RW Discs

- CD-R/RW discs that are recorded by personal computers or some CD-R/RW recorders may not be played on this unit due to the differences in recording platforms.
- Do not load an unrecorded CD-R/RW disc into the unit. This may take a longer time to read the disc.

TECHNICAL SPECIFICATIONS

* **Frequency response:** 20Hz to 20kHz

Power Supply

- 4.5V DC (through AD/DC adaptor (refer to table page 4 for details)
- 2 "AA" batteries (Duracell Ultra recommended)
- 2 "AA" rechargeable Ni-cd batteries (Recharge function on Thomson models)
- 4.5V DC (through car DC adaptor)

US Warranty

EN

What your warranty covers:

- Any defect in materials or workmanship.

For how long after your purchase:

- One year (The warranty period for rental units begins with the first rental or 45 days from date of shipment to the rental firm, whichever comes first.)

What we will do:

- Provide you with a new, or at our option, a refurbished unit.
- The exchange unit is under warranty for the remainder of the original product's warranty period.

How to make a warranty claim:

- Properly pack your unit. Include any cables, etc., which were originally provided with the product. We recommend using the original carton and packing materials.
- Include in the package evidence of purchase date such as the bill of sale. Also print your name and address and a description of the defect. Send standard UPS or its equivalent to:

Thomson multimedia Inc.
Product Exchange Centre,
11721 B Alameda Ave,
Socorro, TX 79927

- Pay any charges billed to you by the Exchange Center for service not covered by the warranty.
- Insure your shipment in case of loss of damage. Thomson accepts no liability in case of damage or loss.

- A new or refurbished unit will be shipped to you prepaid freight.

What your warranty does not cover:

- Customer instruction. (Your Owner's Manual provides information regarding operating instructions and user controls. For additional information, ask your dealer.)
- Installation and set-up service adjustments.
- Batteries.
- Damage from misuse or neglect.
- Products which have been modified or incorporated into other products.
- Products purchased or serviced outside the USA.
- Acts of God, such as but not limited to lightning damage.

How state law relates to this warranty:

- This warranty gives you specific legal rights, and you may have other rights which vary from state to state.

If you purchased your product outside the USA:

- This warranty does not apply. Contact your dealer for warranty information.

9

Canadian Warranty

EN

Thomson multimedia Ltd. warrants to the purchaser or gift recipient that if any manufacturing defect becomes apparent in this product within 1 year from the original date of purchase, it will be replaced free of charge, including return transportation.

This warranty does not include damage to the product resulting from accidents, misuse or leaking batteries.

Should your product not perform properly during the warranty period, either:

1. Return it to the selling dealer with proof of purchase for replacement,

OR

2. Remove the batteries (where applicable), and pack product complete with accessories in the original carton (or equivalent).

— Mail prepaid (with proof of purchase) and insured to:

Thomson multimedia Ltd.
6200 Edwards Blvd.,
Mississauga, Ontario,
L5T 2V7
Canada

The provisions of this written warranty are in addition to and not a modification of or subtraction from the statutory warranties and other rights and remedies contained in any applicable legislation, and to the extent that any such provisions purport to disclaim, exclude or limit any such statutory warranties and other rights and remedies, such provisions shall be deemed to be amended to the extent necessary to comply therewith.

If you are unable to find a qualified servicer for out of warranty service, you may write to:

Thomson multimedia Ltd.

P.O. Box 0944

Indianapolis, Indiana, U.S.A., 46206-0944

Attach your sales receipt to this booklet for future reference. This information is required if service is needed during the warranty period.

PURCHASE DATE

NAME OF STORE

10