

User's Manual

(en)

tiptel Ergophone 6020/6021



tiptel

Important notice

This telephone is set up for easy operation. Factory settings include only those functions which as a rule are most frequently used. These are the functions principally described in this manual.

You can switch the telephone from "Beginner mode" to "Advanced mode" via menu item "User level setting" in the "Settings" menu. Additional functions then become available.

Note: If you modify telephone settings in the "Advanced mode" setting, these changes remain available even if you later switch back to "Beginner mode".

All menu items of the main menu described in the present manual are visible in the factory settings of the device. You can mask those menu items of the main menu which you do not intend to use via menu item "Main Menu Settings" in the "Settings" menu.

Contents

| | |
|----------------------------------------------------------|-----------|
| Important notice | 1 |
| Contents..... | 3 |
| Safety notes | 7 |
| Bringing into service | 8 |
| Check packing contents..... | 8 |
| Installing the SIM card(s), memory card and battery..... | 8 |
| Switching on the telephone..... | 10 |
| Setting date and time | 10 |
| Charging the battery..... | 11 |
| Telephone controls | 12 |
| Keyboard controls | 12 |
| Controls on back side | 13 |
| Features on the front side | 13 |
| Controls on the left side | 13 |
| Features on the right side..... | 14 |
| Features on the underside | 14 |
| General operating information | 14 |
| Symbols in the display | 15 |
| Calling | 16 |
| Accepting calls | 16 |
| Rejecting calls | 16 |
| Calling with direct dialling | 16 |
| Dialling with redial function | 17 |
| Calling with speed dial | 17 |
| Dialling from contacts..... | 18 |
| Functions while calling | 18 |

| | |
|-------------------------------------------|-----------|
| Contacts | 19 |
| Options | 19 |
| Dial | 19 |
| Send message | 20 |
| Add new contact | 20 |
| Delete | 20 |
| Additional options | 21 |
| Messages (SMS) | 22 |
| View received messages | 22 |
| Sending messages | 22 |
| Writing message text | 23 |
| Additional message options | 23 |
| Silent mode | 24 |
| Call history | 25 |
| Display of missed messages | 25 |
| Camera | 26 |
| Memory medium | 26 |
| Image viewer | 26 |
| Transferring photos to the computer | 27 |
| Magnifier function | 28 |
| Radio | 29 |
| Radio options | 29 |
| Channel list | 29 |
| Auto search | 29 |
| Loudspeaker | 30 |
| Additional options | 30 |
| Recorder | 31 |
| Recorder options | 31 |
| New record | 31 |
| List | 31 |
| Settings | 31 |
| Additional options | 32 |

| | |
|---------------------------------------------------------|-----------|
| Alarm clock | 33 |
| Calculator | 34 |
| Tasks | 35 |
| Services | 36 |
| Settings | 37 |
| Phone settings..... | 37 |
| Time and date..... | 37 |
| Tone settings | 38 |
| Volume..... | 38 |
| Alert type..... | 38 |
| Language..... | 38 |
| Font size | 38 |
| Additional telephone settings | 39 |
| User level settings | 40 |
| Main menu settings | 40 |
| Security settings | 41 |
| Additional settings | 41 |
| Call settings | 41 |
| Emergency settings..... | 41 |
| Network settings..... | 42 |
| Connectivity..... | 42 |
| Factory settings | 42 |
| Connection to the computer | 43 |
| Emergency call | 44 |
| The answering machine problem..... | 45 |
| Testing the emergency call function | 45 |
| Configuring the emergency call | 46 |
| Active | 46 |
| Numbers list..... | 46 |
| Send SMS..... | 47 |
| Breaking off the emergency call..... | 47 |
| Important information on emergency call functions | 48 |

| | |
|-----------------------|-----------|
| Appendix | 49 |
| Service..... | 49 |
| Warranty | 50 |
| CE sign | 52 |

Safety notes

- Only use the telephone at locations where calling is allowed. As a rule, use of mobile phones is prohibited in hospitals, aircrafts and at filling stations.
- Do not open the device yourself, and do not attempt repairs on your own. Repairs may only be performed by qualified specialists.
- Do not expose the telephone to smoke, chemicals, humidity, dust or excessive heat (direct sunlight).
- Keep the telephone and accessories away from children.
- This telephone's speaker can be set very loud. Check volume before use to avoid damaging your hearing.
- While driving, use this telephone only with an approved hands-free set. Observe specific national legislation governing use of mobile telephones.
- If applicable, keep a 20 cm distance between the telephone and any implanted pacemaker. Immediately switch off the telephone if you feel or suspect any impairment.
- Use only the provided power supply unit, and none other.
- Use only original accessories and batteries.
- The telephone is not water-tight. Avoid contact with liquids.
- In case of emergency, do not rely exclusively on your mobile telephone's emergency call function. For technical reasons, an emergency connection cannot always be guaranteed.
- Dispose of the device and the battery according to environmental guidelines. Your local waste disposal provider offers collection points for electronic waste. Do not dispose of the device and the battery in household rubbish or in a fire.
- Please dispose of packaging materials according to local regulations.

Bringing into service

Check packing contents

Included in the scope of delivery:

- tiptel Ergophone 6020/6021 mobile telephone
- Power supply unit
- Desktop charger
- Li-Ion 3.7 V/800mAh battery pack
- Operating instructions

Installing the SIM card(s), memory card and battery

Before bringing into service, the SIM card, battery and any memory card must be installed. Neither SIM card nor memory card are included in the device scope of delivery. You can obtain the SIM card from your service provider. The Ergophone 6020/6021 supports Micro SD memory cards up to 4 GB, which can be purchased on the accessories market and in electronics shops.

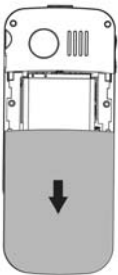

Illustration 1

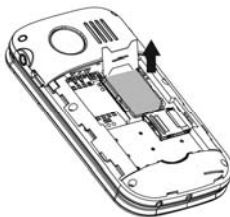

Illustration 2

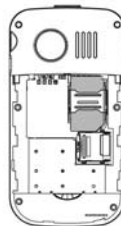

Illustration 3



Illustration 4

To insert the SIM card, any memory card and the battery, the casing cover at the back of the device must be removed. Press the casing cover while sliding it downward until it can be removed (illustration 1).

Slide the metal catch toward the top of the device, then fold open upward (illustration 2).

Carefully install the SIM card in the card holder. After the card is inserted, the metal holder is pushed forward, so that it secures the card and can no longer slide upward (Illustration 3). Exercise extra care here. When the metal holder does not slide easily, it's usually an indication that the card is not correctly inserted.

Next, the battery is inserted, which is only possible in the correct position (illustration 4).

Then replace the casing cover and slide it in the direction of the SOS button until it engages.

Note: The telephone can be operated without a memory card. In this case, however, the memory is limited. If you wish to take a lot of photos or record many vocal messages, the use of a memory card is recommended. The device supports Micro SD memory cards up to 4 GB.

Switching on the telephone



To switch on the telephone, press the red hang-up key  for 3–5 seconds.

Your SIM card PIN is then queried (if enabled for the SIM card). Enter the PIN via the keyboard, then press the OK key.



Note: In Settings → Safety Settings, you can modify the SIM card PIN and enable or disable its query.

Setting date and time

After initial switching on (and battery removal for longer periods), the telephone automatically synchronises date and time from the service provider network.

If your service provider does not support this functionality, date and time must be set manually. For this, press left display key  under "Menu", then repeatedly the "Arrow Down" key , until "Settings" is displayed. Next press the  key under the "OK" display three times to call up "Settings", then "Phone Settings", as well as "Time and Date". Next, successively select "Set time" and "Set date", and enter the current time and date with the keyboard.

Note: Date entry occurs in international format, i.e. first the year, then the month, and then the day.

You can close Settings by repeatedly pressing the  key under "Back", but also by pressing the red hang up key  once.

The correct time and date then appear in the display.

Charging the battery

Your telephone is delivered with a charger and the corresponding power supply unit. Insert the small connector of the power supply unit into the jack at the rear of the charger, then connect the power supply unit to the wall socket.

Place the telephone in its closed position in the charger; the battery now charges. During the charging process, the red battery LED at the front of the device blinks. When the charging process is complete, the battery LED goes out.

Note: Instead of charging via the charger, the power supply plug can also be connected directly to the jack on the underside of the telephone. The battery can also be charged via a computer USB jack.

Before initial operation, completely charge the battery. To preserve the battery, thereafter only place the telephone in the charger once the battery is almost empty.

Over time, battery performance diminishes. If you notice after a time that you have to recharge your telephone more frequently, replace the battery.

Telephone controls

The telephone has controls and displays on the front and back, along with the left, right and lower sides, and on the keyboard when in the open position.

Keyboard controls

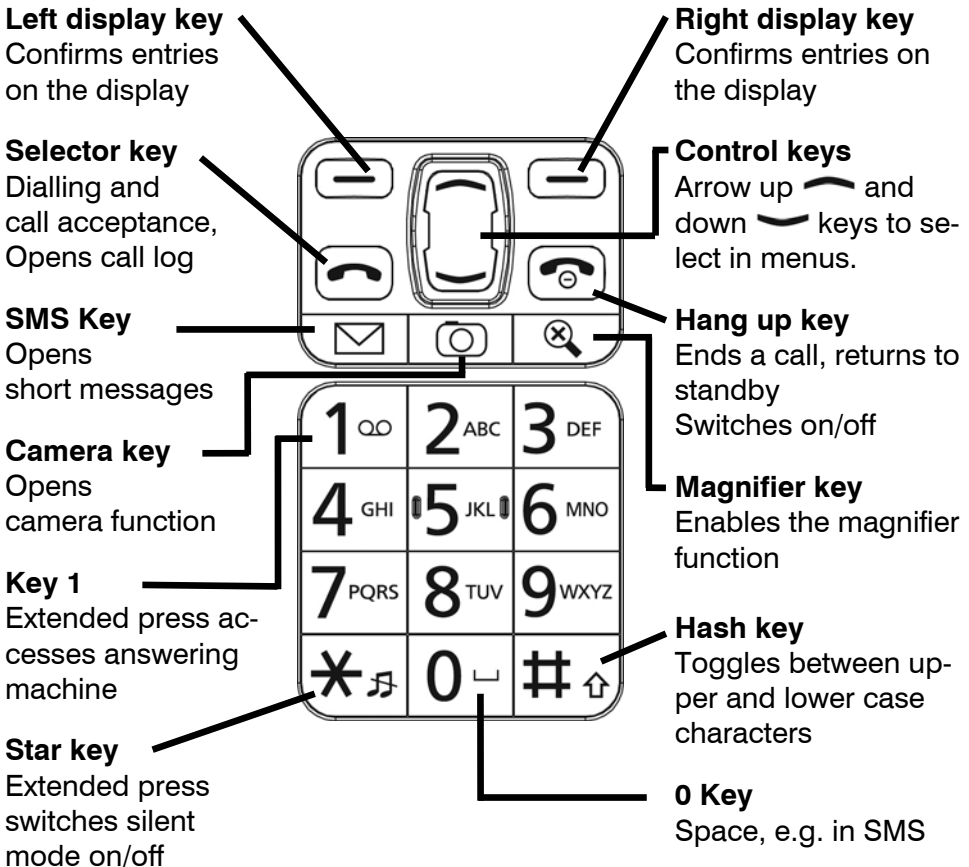

Controls on back side

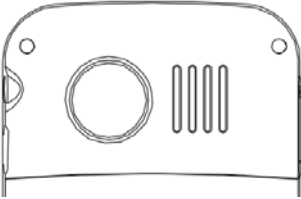

Here, you have the emergency call button and the loudspeaker.

The emergency call function is triggered if the emergency call button is pressed for about 2 seconds. You'll find a description of this function in the "Emergency call" chapter.

Features on the front side



Here, you'll find four LEDs, and above these the integrated camera.

The red LED at top left blinks when the telephone is charging. The green LED at top right blinks for incoming calls, the blue LED at bottom left for incoming short messages (SMS). Both blinking LEDs indicate calls and messages received in your absence. The LED at right bottom blinks when a configured alarm rings.

Controls on the left side

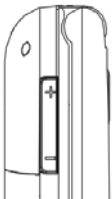

Here is a rocker switch marked with + and -.

It allows you to control the volume while calling. It also adjusts the volume of the integrated radio and recorder.

Features on the right side



On the right side, you'll find the connection jack for the headset, along with the micro USB jack.

This micro USB jack is used to charge the battery with the power supply unit or via USB cable at the computer.

Features on the underside

The underside has the contacts for the charger.

General operating information

The left and right display keys  perform varying functions according to the status of the device. The function currently available for the keys is indicated above the keys in the display.

In menus, the right display key is mostly used to break off the function, or to move back a step; the left display key confirms functions or opens the option menu

In standby, the left display key calls up the main menu, the right display key opens the contacts.

Keys  are used to select entries in menu lists.

The red hang up key  is used to end a call, reject a call and (with a long press) to switch the device on and off. Within menus, settings can be broken off with this key.

The green selector key  is used to call after entering a number, or to select a contact. If you press this key in standby, the list of the latest number is opened for redial.









Extended pressing of the  key switches silent mode on and off.

The  key allows you to toggle between upper and lower cases during text entry, e.g. for an SMS or a name into the contacts.

Symbols in the display

The wireless network signal strength is displayed at top left of the display, the battery charge status on the right.

In addition, indicators for new SMS, missed calls, enabled silent mode or alarm and connected headset can be displayed here.

| Symbol | Description |
|-------------------------------------------------------------------------------------|--------------------------------------|
|  | Indicates wireless network strength. |
|  | Battery charge status. |
|  | Unread text message(s) (SMS). |
|  | Missed call(s). |
|  | Silent profile enabled. |
|  | Silent profile disabled. |
|  | Alarm on. |
|  | Headset connected. |

Calling

Accepting calls

With an incoming call, the telephone rings (provided silent mode is not enabled) and vibrates (provided “vibration” is enabled in alert type).

The calling number appears in the display. If the caller for that number is saved in the contacts, the name of the caller is displayed instead of the number.

The call is accepted by pressing the green selector key .

With the right display key , you can disable the ringtone during the call

Rejecting calls

If you press the red hang up key  with an incoming call, the call is rejected. The caller hears the engaged tone. Instead of the red hang up key, you can press the right display key  twice.



Calling with direct dialling

For direct dialling, enter the desired call number with the numeric keys, then press the green selector key . The call is made to your desired subscriber.

Note: Don't forget that with mobile networks you must always dial a prefix. Via Menu → Settings → Phone settings → Tone settings → Keypad → Speaking keys, you can set up the telephone to announce the corresponding digit while dialling.

Dialling with redial function

If you press the green selector key  without first entering a number while the telephone is in standby, the call log is opened. It will indicate your recently dialled numbers, along with the numbers for calls you have accepted or missed.

With the  and  keys, you can scroll up and down the call log. Press the green selector key  once more to select the desired number.

Calling with speed dial



This telephone features speed dial keys on which frequently-dialled numbers can be saved.

When the phone is in standby, these speed dial keys are called up by pressing digits **2-9** for about 2 seconds. The corresponding saved number is then automatically dialled.

By extended pressing of the **1** key, you call the answering machine.

Note: To use the speed dial keys, these must first be enabled and configured in the → Call settings → Speed dial settings. This configuration is only possible in the „Advanced mode“ user levels. The answering machine number is automatically queried after extended pressing of the **1** key, if it is not already saved.

Dialling from contacts

In standby, if you press the right display key ("Contacts" in the display), contacts are called up and the first entry is displayed. With arrow keys  and , you scroll up and down.

If one of the keys is quickly pressed, also in quick succession, the first entry starting with the corresponding letter is displayed. For example, to display the first entry beginning with „L“, the  key must be pressed three times in quick succession.

Press the green selector key  to directly select the desired number.

Functions while calling

While calling, you can toggle between hands-free and receiver operation using the  display key.



With the left display key , you access the options menu with the "Mute" function (disable microphone).

In the "Advanced mode" user level, under Options, "Record" and "DTMF" are also available.

Contacts

A contact consists of a name and the corresponding call number; it structures your phone book for calling subscribers and sending short text messages.

To call contacts, in standby press the right display key. The contacts are directly opened. You can also open the contacts via the main menu, then the "Contacts" item.

All saved contacts are displayed, the first contact is selected. Using keys  and  you can select another contact within the contact list.

If you select a numerical key (where applicable, in quick succession) on the keyboard, the contact beginning with the corresponding letter is selected from the contact list. For example, if you select **6** once, the first contact beginning with the letter "M" opens. If you select **6** three times in quick succession, the first contact beginning with the letter "O" opens.

If you press the green selector key , the selected contact is called.

Options

If you press the left display key in the contact list, the options menu opens.

Dial

Dials the contact number. Instead of selecting this menu item, you can also simply press the green selector key  once the contact is open.



Send message





From the option menu, select "Send Message" to write a short message (SMS) to the contact:

Add new contact

You can create a new entry via "Add New Contact". "Name" and "Number" opens.

First, select "Name" and press the left display key  "Edit". Then enter the name of the subscriber via the numerical keys. Pressing the numerical key once selects the first letter which appears upon it; successive pressing selects the following letters.

To enter a space, press . With -you toggle between upper and lower case letters, initial letter of a word in upper case and the rest in lower case, or numerical entry only. Press the  key for a selection of special characters. Once you've finished entering the name, press the left display key, then select the "Ready" entry.

Next, select "Number" with the  key, and press the left display key . Enter the call number over the numerical keys. To insure that dialling of entries also works when you're calling on a foreign network, make sure to enter the numbers in international format, i.e. including country code. Call number 02102-4280 would thus be entered as +4921024280, with +49 as country code for Germany first, then the dialling code without the initial nought. For the + sign, press the  key twice in quick succession. Then confirm with the left display key , and select the "Done" entry.

Once the name and number are entered, press the right display key  "Done", and confirm saving the new entry.

Delete

Delete the selected contact.

Additional options



In the "Advanced mode" user level, you have the additional options of delete all contacts, copying one or more contacts and making settings for the contact memory (SIM card or telephone).

Messages (SMS)

With your telephone, you can receive and send short text messages (SMS).

View received messages

When you receive a message (SMS), it's announced to you on the display, and the blue LED with the envelop at the front of the telephone begins to blink.

Press the left display key  to get an overview of received messages; the latest message is displayed at the top. To view messages, press the left display key .

If you press the left display key while displaying the message, the Options menu opens, allowing you to reply to the sender per SMS, to call back the sender or to delete the message.

As long as you have not deleted them, received messages remain available via the "Messages" menu item from the main menu under "Inbox".

Sending messages

Besides answering a received message, you can also compose and send a message on your own.

For this, call up "Messages", then "Write Message" from the main menu. A window opens in which you can enter the message text with the keyboard.

Quickly pressing the right display key  deletes the latest entered character, extended pressing, the entire text.

When your text is ready, press the left display key  to call up the options, then select the "Send to" item.

The recipient window opens, in which you may chose, at the top, to enter the recipient number manually, or to add it from the contacts or the caller list. Selected recipients are displayed at the bottom.

To send, select the recipient, or one of the selected recipients, press the left "Options" display key , then select "Send". As additional options, you can edit or delete the selected, or all, recipients.

Note: If you wish to write a message to a recipient who is saved as a contact, you can also open the "Contacts", select the contact, then select via the left display key in the "Send message" options.

Writing message text

Write the message text with the numerical keys. Three to four letters are imprinted next to numerical keys **2** to **9**. If you press the respective key once, the first letter is displayed, twice in quick succession, the second letter, etc.

For the word „Hello“ you would thus twice press **4**, then twice **3**, then three times **5**, then three times **5** and then three times **6**.

To enter a space, press **0**. With **#**-you toggle between upper and lower case letters, initial letter of a word in upper case and the rest in lower case, or numerical entry only. Press the ***** key for a selection of special characters.

Additional message options

In the "Advanced mode" user level, besides writing text messages, you can also compose Multimedia Messages (MMS) and access incoming as well as outgoing mail, drafts, saved messages, templates and message settings for SMS and MMS.

Silent mode



You can switch the silent mode on and off via the "Silent Mode" item in the main menu. In silent mode you receive calls and messages, but the telephone does not ring. This setting should always be chosen when the phone ringing would disturb others.

Note: Enable and disable silent operation even more simply with an extended pressing of .

Call history

Pressing the green selector key  while the telephone is in standby calls up the call log, which displays all calls (dialled, received and missed calls) in a list.

You can view individual call logs for "Missed Calls", "Dialled Calls" and "Received Calls" via menu item "Call History" in the main menu.

Using the  and  keys, you can scroll through the respective call logs.



Press the green selector key  to call the chosen number.

Press the left display key to open the call log options. Here, besides dialling numbers, you can also send a message, delete the selected call or view call details.

In the "Advanced mode" user level, you can also delete entire call logs and display call durations.

Display of missed messages



If you've received calls in your absence, this is notified on your display, and the green LED with the telephone symbol at the front of the telephone blinks.

You can void the indicator with the right display key . With the left display key , you open missed calls from the missed calls log.

Camera

Open the camera function via the "Camera" item in the main menu, or directly via the camera key  on the keyboard.

After opening the camera, you'll see the image on the display. Make sure you don't cover the camera lens on the front of the device while using this function.

The integrated camera possesses a zoom function with which to magnify the object to be photographed. Press the  key to magnify the object, or the  key to reduce it.



Press the  key to take a picture. The photo is saved automatically.





If you press the left display key  while in camera mode, you can select between "Image Viewer" and "Storage".

Memory medium

Here you set whether photos are saved in the internal camera memory, or on an installed memory card. The telephone memory is limited to only a few photos. If you wish to take more photos, a memory card must be installed. The Ergophone 6020/6021 supports Micro SD memory cards up to 4 GB.

Image viewer

Select "Image Viewer" to display all saved photographs with the name and size of the file. Use the  and  keys to select an image from the list. Pressing the left display key  allows you, via the Options, to view or delete the image, to delete all files and to select the storage (phone memory or memory card) from which you wish to display the images.

When one of the images appears on the display, you can show the next with the  key, or the previous with the  key. You can delete the currently displayed image with the left display key , or end the display with the right display key .

In the "Advanced mode" user level, you also have the option of sending an image as MMS, or of using it as wallpaper for the display in standby.

Transferring photos to the computer



Photos saved with the telephone are either saved on the internal telephone memory or on an inserted memory card, depending on the setting.

You can connect the telephone to a computer via USB cable to transfer the photos onto the computer. You'll find additional information on the subject in the "Connecting to a Computer" chapter.

Magnifier function

Your telephone features an integrated magnifier, which is opened with the magnifier key  on the keyboard.



Hold the camera at the front of the device close to the object which you wish to show magnified. Make sure not to cover the camera lens.



Use the  and  keys, to represent the object as larger or smaller.

The magnifier function is switched off by pressing the red hang up key .

Radio

Your telephone features an integrated FM radio. It can be opened via the "FM Radio" item in the main menu. A headset must be connected to listen to the radio.

When you turn the radio on, the station last tuned returns. You select the previous or next saved station with the  or  key. In radio mode, you control the loudspeaker volume with the +/- rocker on the left side of the device. With the  key, you can switch playback on and off (muting).

Exit radio mode by pressing the right display key  or the red hang up key .

Call up radio options with the left display key .

Radio options

Press the left display key  to open the options in radio mode.

Channel list

Lists saved radio channels and offers the option of setting up the channels manually, or of editing/deleting channels after automatic search.

Auto search

This function searches for radio channels and saves these automatically in the channel list.

Note: With automatic search, the station list is overwritten.

Loudspeaker

With this function, in addition to the headset, sound can be reproduced over the speaker integrated in the telephone.



Additional options

You also have the option of manually entering a radio frequency via the "Advanced mode" user level.

Recorder

With the recorder you can record memos, to be saved in the device memory or on a memory card.

For this, select "Sound Recorder" from the main menu.

With the  key, you can start, pause or resume a recording. While a recording is in progress, it can also be paused and resumed with the left display key . You stop recording with the right display key . After the recording is concluded, you are prompted as to whether you wish to save it.

Recorder options

The options are available via the left display key  as long as neither recording nor playback is in progress.

New record

Starts a new recording.

List

Opens the list of saved recordings. The selected recording can be played back or deleted via Options. Playback can be paused and resumed with the  key.

Settings

In "Settings", you can select the storage for recordings (Phone memory or memory card), the file format (AMR or WAV) and the audio quality (high or low).



Note: The internal device memory is limited to only a few short recordings. If you wish to make more recordings, you should insert a memory card.
If a memory card is inserted in the telephone, set file format to "WAV" and audio quality to "high".

Additional options

In the „Advanced mode“ user level, you also have the option of sending a recording as MMS, renaming files and deleting all files simultaneously.

Alarm clock

To use your telephone as an alarm, open "Alarm" from the main menu.

Five alarms are displayed. With the  and  keys, you can select an alarm and edit its settings by pressing the left display key .

In Settings, you can switch the alarm on and off and set wake-up time, ringtone and type (ringing, vibrating, or both).

When an alarm is enabled, this is indicated with an alarm-clock symbol at top left of the display.

At wake-up, the telephone rings and/or vibrates and the display indicates the time and date. In addition, "Stop" and "Snooze", controlled with the left and right display keys , are displayed. "Stop" terminates the wake-up function. "Snooze" delays the wake-up call by about 5 minutes.



As with a conventional alarm, the device automatically turns off if you select "Stop", and must be turned back on if, for example, you wish to be woken again the next morning.

In the „Advanced mode“ user level, you also have the option of setting the alarm to ring on a daily basis, or on certain weekdays.

Calculator

To use your telephone as a pocket calculator, open "Calculator" from the main menu.

Enter the figures for the calculation via the keyboard numerals. For number of decimals, you enter a point with the  key.

Arithmetical operators +, -, x, / and = are selected with the  and  keys. The selected arithmetic operation is performed with the left display key .



Actuating the right display key  first deletes the calculation product; pressing it a second time closes the calculator.

Tasks

Over this main menu item, you can configure tasks of which the telephone can later remind you. After opening this menu item, you'll see a list of configured tasks. Via "Options", you can add new tasks and edit or delete existing tasks.

If you add a new task or edit an existing task, enter a date, time and reference.

At the programmed time, the telephone will display the date, time and reference while emitting a ringtone.

With the left display key , you confirm the task, with the right display key , you can choose to be reminded of the task again 5 minutes later.

In the „Advanced mode“ user level, in addition to adding, editing and deleting, you can view and search tasks, delete all tasks, select tasks according to date and display unfinished tasks.

When creating or editing a task, in addition to the date, time and reference, reminder time before task, automatic repeat and priority level are available.

Services

In this main menu item, services offered by your provider are available. Which services are offered depends on your service provider. There, you can also obtain a description of the functionality and costs of offered services.

Settings

With this menu item, you can perform most of your telephone settings. The settings menu features several submenus which in turn possess subcategories for settings.

We've delivered your telephone with convenient presets, so that you need only customize settings where needed and as a rule only on a case-by-case basis.

In the "Beginner mode" user level, only few setting options are available. If you switch the user setting to "Advanced mode", the telephone offers considerably more setting options. Settings which you have performed in the "Advanced mode" user level are preserved if you return to "Beginner mode".

Phone settings

Here, you can set the time, date, volumes, language and font size.

Time and date

Enter the current time and date here.

Time must be entered in international format, i.e. first the year, then the date and then the day, even if the time is represented on the display in a Day -- Month -- Year format.

If you select "Auto update of date and time" to "On", the telephone automatically draws date and time from the service provider network, while also automatically adjusting for transitions between summer and winter time and changes in time-zones while travelling. However, this service is not offered by all service providers.

In addition, setting of time and date format is available in the „Advanced mode“ user level

Tone settings

Here, you set the tones produced by the telephone for incoming calls, switching on/off of the device, folding the telephone open/closed, incoming messages and key press.

Speaking keys

A special function of this device are "Speaking Keys", which can be enabled via tone settings→ keypad. If „Speaking Keys“ is enabled, the telephone "speaks" when keys **1** to **0**, ***** and **#** are pressed on the keyboard.

Volume

Here, you set the volume for ringer and key tone.

Alert type

Here, you specify whether the telephone shall ring, vibrate, do both simultaneously, or first ring, then vibrate.

Language

Set the language of display notifications here. In the "Automatic" setting, the telephone automatically adjusts to the language of the installed SIM card.

Font size

Here, you can choose between normal and large lettering. This font setting applies to all menus and submenus. Display font sizes in standby, and lettering of both display keys  cannot be modified.

Additional telephone settings

Additional telephone settings are available via the „Advanced mode“ user level.

Ring type

Here, you can select whether the telephone signals incoming calls by ringing repeatedly, once only or with rising intensity (first quietly, then increasingly louder).

Extra tone

Here, you can enable and disable warning and connection tones.

Answer mode

Here, you can specify whether the telephone should automatically accept incoming calls when cover is opened, or if any key is pressed.

Display settings

Here, you can select your own image as display background (wallpaper) in standby, and specify whether date, time and your own number appear.

LCD backlight

Here, you can adjust the duration and brightness of display lighting.

User level settings

In the "Beginner mode" setting, for all menus and settings, the telephone only offers those functions which as a rule are actually and frequently used. Foregoing infrequently-used functions makes operating in this setting very simple.

All functions supported by the telephone remain available within all menus and settings through the "Advanced mode" settings.

If you modify settings in "Advanced mode", these changes persist even if you later switch back to "Beginner mode". Thus, if you wish to modify a setting not available in the "Beginner mode", you can temporarily enable the "Advanced mode" in order to perform the setting adjustment.

Main menu settings

The main menu offers functions for which certain users have absolutely no use. For example, if you never intend to use the alarm, tasks, or the calculator, it's not necessary that these functions should be included at all in the main menu.

Under the "Main Menu Settings" item, you thus have the ability to show/hide all main menu items, apart from "Settings".

When you open this menu item, all main menu items are displayed to be individually activated or deactivated.

However, even after deactivating items in the main menu, the corresponding functionalities remain partly available.

For example, if you deactivated "Messages" in the main menu, the telephone still receives short messages, notifies you of this, and lets you read and answer messages. If you deactivate "Contacts", for example, your contacts remain available via the right display key.

Security settings

Here, you specify whether the PIN saved on the SIM card (code number, password) should be queried when the telephone starts up; you can also modify the PIN.

What's more, in the „Advanced mode“ user level, in addition to locking the SIM card, you can set up a block on the phone.

Additional settings

In the „Advanced mode“ user level, additional complete menu items with submenus are available via the settings menu; these are not available in the "Beginner mode" setting.

Call settings

All additional settings are available here:

- Hide/Send caller ID
- Enable/disable call waiting
- Enable/disable call diversion
- Configure speed dial on keys 2-9

Emergency settings

Here, you make settings for the emergency call function. You'll find a description in the "Emergency Call" chapter.

Network settings

Here, you specify whether connection to the GSM network occurs automatically or manually, and whether a GPRS connection is always set up, or only as needed.

Connectivity

Here, you'll find the GPRS connection setting data accounts required for MMS, and you can manually transmit these to your provider.

Factory settings

Here, the telephone can be reset to factory settings. Please note that here only settings are reset; functions that you have set up, e.g. contacts, alarms or tasks, or files saved in the telephone memory, such as photos or recordings, are not deleted.

Connection to the computer

Connect the telephone's micro USB jack to your computer's USB connection. "Mass Storage" appears on the display. Press the left display key . Now, the memory integrated in your telephone and any inserted memory card is (are) displayed on your computer as new device(s) with exchangeable media.

This includes, among others, the "Photos" and "Audio" folders. The "Photos" folder contains photos taken with the camera, the "Audio" folder, voice messages saved with the recorder and recordings of telephone calls.

If you wish to use your own ringtones or background image, copy the relevant audio or image file to the telephone memory or memory card. These files are selected in the telephone as ringer tones or background images, though they are stored in the memory. We thus recommend creating a folder for such files in the memory, so as not to delete them accidentally.

Emergency call

Your telephone features an emergency call function which is triggered by pressing the SOS button at the back of the device for about 2 seconds.

If at least one emergency number has been configured and the emergency call button is enabled, the telephone initiates the emergency call when the SOS key is pressed for approximately 2 seconds.

The telephone will then emit an alarm tone and (if activated) send an SMS with an individually configurable text to the (up to 5) saved emergency number(s).

Next, the telephone will call the first of the saved emergency numbers. If the call is accepted, the telephone automatically switches to hands-free mode. If the called party hangs up, the emergency call function stops but afterwards the phone automatically answers incoming calls and switch to hands free mode.

If the call is not accepted, the telephone calls the next saved emergency number. If none of the emergency calls goes, the telephone repeats the cycle of calls to all emergency numbers three times.

While the telephone is calling one of the emergency numbers, the number is displayed; as the call occurs in hands-free mode, you can hear whether the called party picks up. While the SMS are being sent, and the calls are being attempted, the telephone continues to emit the alarm tone. Once a call goes through and the emergency number is rung, or the called party picks up, the alarm tone stops; however, it starts anew if dialling resumes.

After an outgoing emergency call (regardless of whether accepted, unsuccessful or interrupted), the telephone automatically accepts incoming calls and switches into hands-free mode. This allows contact with an incapacitated person, even if the emergency call has already

ended. To close this function the telephone must be completely turned off, then back on again.

The answering machine problem

The telephone cannot differentiate whether the emergency call is accepted by a person, an answering machine, fax machine or an automated voice system.

Should an emergency call be accepted by an answering machine, you can end the current call by quickly pressing the red hang up key . The telephone then dials the next emergency number.

Testing the emergency call function

After configuration, thoroughly test the emergency call function. This process should include both the owner of the Ergophone device and the persons whose call numbers are saved.

While testing, please consider that when making an emergency call the user of the device will experience a stressful situation. Persons receiving the emergency call should thus become familiar with using the emergency call function so as to be able to give instructions, as the case arises.

Configuring the emergency call

To configure the emergency call it must be enabled, and the emergency text and numbers must be entered.

With the telephone in standby, select the display key, next "Settings" in the main menu, then "Emergency Settings". Here, you will find all settings for configuration of the emergency call.

Note: Emergency call settings are only available in the „Advanced mode“ user level. If the emergency call has been set up in this user setting, it remains available even if the user settings have been reset to "Beginner mode".

Active

Here, you determine whether the emergency call button at the back of the device is enabled or disabled.

With the button enabled, the emergency call function is active as described. With the button disabled, the emergency call function is not available, even if you have saved the emergency numbers and text.

Numbers list

Enter your emergency numbers (up to five) under "Numbers List". In an emergency, the first number is called first, then the second, etc.

When you open the menu item, you will see the five memory fields for emergency numbers. Press the left memory key  and select the emergency number from the contacts, or enter it manually.

Under the item "Message Edit", you can modify the emergency call SMS.

Send SMS

With this menu item, you can specify whether to send an emergency SMS before dialling the emergency call numbers.

Note: If you enable the SMS for numbers of telephones which are not SMS-capable, the service provider calls the subscriber and reads him/her the SMS. This call would engage the emergency number telephone at the very moment when the mobile telephone is trying to make the emergency call. Hence, only enable sending of emergency SMS if the telephones of all emergency call numbers are capable of receiving SMS as text messages.

Breaking off the emergency call

If an emergency call has been accidentally triggered, it can be broken off by extended pressing of the hang up key .

To close the emergency call function completely, the telephone must be turned off, then back on again.

Important information on emergency call functions

- Do not rely exclusively on this emergency call function. In certain situations (e.g. no network coverage or no credit for outgoing calls), the emergency call function might not operate.
- Make sure that no answering machines are associated with emergency call numbers.
- Absolutely discuss entering of emergency call numbers with the subscribers of these numbers so that they know exactly what to do in case of emergency.
- The general emergency number for mobile networks (112) may not be entered as an emergency call number; this also applies to 110 and other official emergency numbers.
- After setting up the emergency call function, test from end to end to detect and correct any errors in configuration.
- Please note that an emergency call can be unintentionally triggered by contact with other objects, i.e. in a handbag; thus handle and transport your telephone with appropriate care while the emergency call function is enabled.

Appendix

Service

You have purchased a modern product of Tiptel.com GmbH Business Solutions. Our high-tech manufacturing facilities grant a continuous level of highest quality. If, however, problems occur or you have any questions on operating the device please contact your local dealer. During the warranty period this is your contact partner. For technical support of specialist dealers Tiptel.com GmbH Business Solutions has set up a special phone number so that they can provide you with high quality consulting service.

In case your dealer is not able to help you, you can contact Tiptel.com GmbH Business Solutions directly. First information you will find on our internet pages as shown below. In addition to that you can contact our experienced technical support staff by telephone at the times shown below:

| In Germany | In Austria | In Switzerland |
|--------------------------------------------------------------------------------------------|----------------------------------------------------|----------------------------------------------------------------|
| www.tiptel.de | www.tiptel.at | www.tiptel-online.ch |
| 08.00 to 17.00 (Mo - Fr) | 08.00 to 17.00 (Mo - Th), Fr until 15.00 | 08.00 to 17.00 (Mo - Fr) |
| Telephone 0900 100 - 84 78 35* Vanity Tel. 0900 100 - TIPTEL* *subject to charges | Telephone 02236 677 464-0, Fax 02236 677 464-21 | Telephone 044 884 01 80 Fax 044 843 13 23 |

For questions regarding your GSM connection please contact your service provider.

Warranty

Your contact partner for any warranty issues is the specialist dealer you purchased the device from. Tiptel.com GmbH will grant a warranty of 2 years from the date of handover for the material and for the manufacturing of the device.

Initially, the purchaser shall have only the right of subsequent performance. Subsequent performance entails either repair or the supply of an alternative product. Exchanged devices or parts shall become the property of the dealer.

If the subsequent performance fails, the purchaser can either demand a reduction in the purchase price or withdraw from the contract.

The purchaser shall notify the dealer immediately of any defects found. Proof of the warranty entitlement shall be furnished by standard proof of purchase (receipt or invoice).

The warranty entitlement shall expire if the purchaser or an unauthorised third party interferes with the device. Damage caused by inappropriate handling, operation, storage or by force majeure or other external influences shall not be covered by the warranty.

The warranty shall not cover any consumable material (e.g. batteries) or defects that only slightly impair the value or the usability of the device.

Claims for damage caused by transport shall be asserted to the delivery company.

Notes on settlement:

Repairs can only be conducted by the Service Department of Tiptel.com GmbH Business Solutions. We offer a 48 hours repair service which makes sure that you will usually receive your repaired device or a replacement back after 2 days plus standard shipment time. A warranty repair does not prolong the warranty period - neither for the replaced parts nor for the device. This warranty is not transferable and shall expire if the device is sold on to another party. It shall also expire if the device is interfered with by third parties or if the serial number on the device has been removed or made illegible. There is a warranty seal on the device. Please do not damage or remove this seal because otherwise your warranty will expire.

The General Terms and Conditions of Tiptel.com GmbH Business Solutions, which are part of the contract for a dealer, shall also apply. In the event of a complaint, the defective product shall be sent to the relevant Tiptel subsidiary, the importer or dealer along with a description of the defect and the proof of purchase. For warranty handling please contact your specialist dealer or send the device directly to the following address:

| In Germany | In Austria | In Switzerland |
|-----------------------------------------------------------|--------------------------------------|-----------------------------------|
| Tiptel.com GmbH Business Solutions Service | Tiptel GmbH Service | Tiptel AG Service |
| Halskestraße 1 40880 Ratingen | Ricoweg 30/B1 2351 Wiener Neudorf | Bahnstrasse 46 8105 Regensdorf |

CE sign

This device is approved for the connection and use within the analogue public telephone networks in all EC countries – according to the European Requirements. Due to technical deviations in individual countries, we cannot grant an unlimited guarantee for the successful operation at all types of telephone accesses. Tiptel hereby declares that the device complies with all fundamental requirements of the European directive 1999/5/EC. This conformity is confirmed by the CE sign on the device. Further details on the declaration of conformity can be found under the following internet address:
<http://www.tiptel.com>

Tiptel.com GmbH Business Solutions

Halskestraße 1

D - 40880 Ratingen

Tel.: 0900 100 – 84 78 35*

Vanity Tel: 0900 100 - TIPTEL*

Internet: www.tiptel.de

International:

Internet: www.tiptel.com

*(1.49 euro/min. from the fixed network of Deutsche Telekom; divergent mobile network prices are possible)

Tiptel GmbH

Ricoweg 30/B1

A - 2351 Wiener Neudorf

Tel.: 02236/677 464-0

Fax: 02236/677 464-22

E-mail: office@tiptel.at

Internet: www.tiptel.at

Tiptel AG

Bahnstrasse 46

CH - 8105 Regensdorf

Tel.: 044 - 843 13 13

Fax: 044 - 843 13 23

E-mail: tiptel@tiptel-online.ch

Internet: www.tiptel-online.ch

Tiptel B.V.

Camerastraat 2

NL – 1322 BC Almere

Telefoon: 036 – 53 666 50

Fax: 036 – 53 678 81

E-mail: info@tiptel.nl

Internet: www.tiptel.nl

Tiptel NV

Leuvensesteenweg 510 bus 4

B – 1930 Zaventem

Telefoon: 0903 99 333 (1.12 euro / min.)

Fax: 02 714 93 34

E-mail: tech@tiptel.be

Internet: www.tiptel.be

Tiptel sarl

23, avenue René Duguay-Trouin

F – 78960 Voisins-Le-Bretonneux

Tél. : 01 / 39 44 63 30

Fax: 01 / 30 57 00 29

e-mail : support@tiptel.fr

Internet : www.tiptel.fr



(de) 09/2011
EDP 4935411