

EMC Test Report

Issued Date : Jan. 28, 2008
Project No. : R0712004
Equipment : Wii CONTACTLESS CHARGER
Model Name : Wii07

Applicant : Fu Da Tong Technology Co., Ltd.
Address : 14F. -5, No. 872, Zhongzheng Rd.,
Zhonghe City, Taipei County 235, Taiwan
(R. O. C)

Tested by:
Neutron Engineering Inc. EMC Laboratory
Date of Test:
Dec. 24, 2007 ~ Jan. 25, 2008

Testing Engineer: Avery Liu for
(Peter Li)

Technical Manager: Jeff Yang
(Jeff Yang)

Authorized Signatory: Andy Chiu
(Andy Chiu)

NEUTRON ENGINEERING INC.

No. 132-1, Lane 329, Sec. 2, Palain Rd.,
Shijr City, Taipei, Taiwan
TEL : (02) 2646-5426 FAX : (02) 2646-6815



Declaration

Neutron represents to the client that testing is done in accordance with standard procedures as applicable and that test instruments used has been calibrated with the standards traceable to National Measurement Laboratory (**NML**) of **R.O.C.**, or National Institute of Standards and Technology (**NIST**) of **U.S.A.**

Neutron's reports apply only to the specific samples tested under conditions. It is manufacture's responsibility to ensure that additional production units of this model are manufactured with the identical electrical and mechanical components. **Neutron** shall have no liability for any declarations, inferences or generalizations drawn by the client or others from **Neutron** issued reports.

Neutron's reports must not be used by the client to claim product endorsement by the authorities or any agency of the Government.

This report is the confidential property of the client. As a mutual protection to the clients, the public and **Neutron-self**, extracts from the test report shall not be reproduced except in full with **Neutron's** authorized written approval.

Neutron's laboratory quality assurance procedures are in compliance with the **ISO Guide 17025** requirements, and accredited by the conformity assessment authorities listed in this test report.

Limitation

For the use of the authority's logo is limited unless the Test Standard(s)/Scope(s)/Item(s) mentioned in this test report is (are) included in the conformity assessment authorities acceptance respective.

Table of Contents	Page
1 . CERTIFICATION	6
2 . SUMMARY OF TEST RESULTS	7
2.1 TEST FACILITY	8
2.2 MEASUREMENT UNCERTAINTY	8
3 . GENERAL INFORMATION	9
3.1 GENERAL DESCRIPTION OF EUT	9
3.2 DESCRIPTION OF TEST MODES	10
3.3 BLOCK DIGRAM SHOWING THE CONFIGURATION OF SYSTEM TESTED	11
3.4 DESCRIPTION OF SUPPORT UNITS	12
4 . EMC EMISSION TEST	13
4.1 CONDUCTED EMISSION MEASUREMENT	13
4.1.1 POWER LINE CONDUCTED EMISSION	13
4.1.2 MEASUREMENT INSTRUMENTS LIST	13
4.1.3 TEST PROCEDURE	14
4.1.4 DEVIATION FROM TEST STANDARD	14
4.1.5 TEST SETUP	14
4.1.6 EUT OPERATING CONDITIONS	15
4.1.7 TEST RESULTS	16
4.2 RADIATED EMISSION MEASUREMENT	18
4.2.1 LIMITS OF RADIATED EMISSION MEASUREMENT	18
4.2.2 MEASUREMENT INSTRUMENTS LIST	19
4.2.3 TEST PROCEDURE	19
4.2.4 DEVIATION FROM TEST STANDARD	19
4.2.5 TEST SETUP	20
4.2.6 EUT OPERATING CONDITIONS	20
4.2.7 TEST RESULTS	21
4.3 HARMONICS CURRENT MEASUREMENT	23
4.3.1 LIMITS OF HARMONICS CURRENT MEASUREMENT	23
4.3.2 MEASUREMENT INSTRUMENTS LIST	23
4.3.3 TEST PROCEDURE	24
4.3.4 DEVIATION FROM TEST STANDARD	24
4.3.5 TEST SETUP	24
4.3.6 EUT OPERATING CONDITIONS	24
4.3.7 TEST RESULTS	25
4.4 VOLTAGE FLUCTUATION AND FLICKERS MEASUREMENT	28
4.4.1 LIMITS OF VOLTAGE FLUCTUATION AND FLICKERS MEASUREMENT	28
4.4.2 MEASUREMENT INSTRUMENTS LIST	28

Table of Contents	Page
4.4.3 TEST PROCEDURE	28
4.4.4 DEVIATION FROM TEST STANDARD	28
4.4.5 TESTSETUP	29
4.4.6 EUT OPERATING CONDITIONS	29
4.4.7 TEST RESULTS	30
5 . EMC IMMUNITY TEST	31
5.1 STANDARD COMPLIANCE/SERVIRITY LEVEL/CRITERIA	31
5.2 GENERAL PERFORMANCE CRITERIA	32
5.3 GENERAL PERFORMANCE CRITERIA TEST SETUP	32
5.4 ESD TESTING	33
5.4.1 TEST SPECIFICATION	33
5.4.2 MEASUREMENT INSTRUMENTS	33
5.4.3 TEST PROCEDURE	33
5.4.4 DEVIATION FROM TEST STANDARD	34
5.4.5 TEST SETUP	34
5.4.6 TEST RESULTS	35
5.4.7 PHOTO(S) SHOWN THE LOCATION(S) OF ESD EVALUATED	36
5.5 RS TESTING	37
5.5.1 TEST SPECIFICATION	37
5.5.2 MEASUREMENT INSTRUMENTS	37
5.5.3 TEST PROCEDURE	37
5.5.4 DEVIATION FROM TEST STANDARD	37
5.5.5 TEST SETUP	38
5.5.6 TEST RESULTS	39
5.6 EFT/BURST TESTING	40
5.6.1 TEST SPECIFICATION	40
5.6.2 MEASUREMENT INSTRUMENTS	40
5.6.3 TEST PROCEDURE	40
5.6.4 DEVIATION FROM TEST STANDARD	40
5.6.5 TEST SETUP	41
5.6.6 TEST RESULTS	42
5.7 SURGE TESTING	43
5.7.1 TEST SPECIFICATION	43
5.7.2 MEASUREMENT INSTRUMENTS	43
5.7.3 TEST PROCEDURE	43
5.7.4 DEVIATION FROM TEST STANDARD	44
5.7.5 TEST SETUP	44
5.7.6 TEST RESULTS	45
5.8 INJECTION CURRENT TESTING	46
5.8.1 TEST SPECIFICATION	46
5.8.2 MEASUREMENT INSTRUMENTS	46

Table of Contents	Page
5.8.3 TEST PROCEDURE	46
5.8.4 DEVIATION FROM TEST STANDARD	46
5.8.5 TEST SETUP	47
5.8.6 TEST RESULTS	48
5.9 POWER FREQUENCY MAGNETIC FIELD TESTING	49
5.9.1 TEST SPECIFICATION	49
5.9.2 MEASUREMENT INSTRUMENTS	49
5.9.3 TEST PROCEDURE	49
5.9.4 DEVIATION FROM TEST STANDARD	49
5.9.5 TEST SETUP	50
5.9.6 TEST RESULTS	51
5.10 VOLTAGE INTERRUPTION/DIPS TESTING	52
5.10.1 TEST SPECIFICATION	52
5.10.2 MEASUREMENT INSTRUMENTS	52
5.10.3 TEST PROCEDURE	52
5.10.4 DEVIATION FROM TEST STANDARD	52
5.10.5 TEST SETUP	53
5.10.6 TEST RESULTS	54
6 . EUT TEST PHOTO	55

1. CERTIFICATION

Equipment: Wii CONTACTLESS CHARGER
Brand Name: PowerHouse
Model Name: Wii07
Applicant: Fu Da Tong Technology Co., Ltd.
Date of Test: Dec. 24, 2007 ~ Jan. 25, 2008
Standards: EN 55022:2006 Class B
EN 61000-3-2:2006 Class D
EN 61000-3-3:1995+A1: 2001+A2: 2005
EN 55024:1998+A1: 2001+A2: 2003
IEC 61000-4-2: 2001
IEC 61000-4-3: 2002
IEC 61000-4-4: 2004
IEC 61000-4-5: 2001
IEC 61000-4-6: 2003+A1:2004
IEC 61000-4-8: 2001
IEC 61000-4-11: 2001

The above equipment has been tested and found compliance with the requirement of the relative standards by Neutron Engineering Inc. EMC Laboratory.
The test data, data evaluation, and equipment configuration contained in our test report (Ref No. NEI-EMC-1-R0712004) were obtained utilizing the test procedures, test instruments, test sites that has been accredited by the Authority of NVLAP and TAF according to the ISO-17025 quality assessment standard and technical standard(s).

2. SUMMARY OF TEST RESULTS

Test procedures according to the technical standards:

Emission				
Standard	Test Item	Limit	Judgment	Remark
EN 55022:2006	Conducted Emission	Class B	PASS	
	Radiated Emission	Class B	PASS	
EN 61000-3-2:2006	Harmonic Current Emission	Class A	PASS	NOTE (2)
EN 61000-3-3:1995 +A1: 2001+A2: 2005	Voltage Fluctuations & Flicker	-----	PASS	
Immunity				
EN 55024:1998+A1: 2001+A2: 2003				
Section	Test Item	Performance Criteria	Judgment	Remark
IEC 61000-4-2:2001	Electrostatic Discharge	B	PASS	
IEC 61000-4-3:2002	RF electromagnetic field	A	PASS	
IEC 61000-4-4:2004	Fast transients	B	PASS	
IEC 61000-4-5:2001	Surges	B	PASS	
IEC 61000-4-6: 2003+A1:2004	Injected Current	A	PASS	
IEC 61000-4-8:2001	Power Frequency Magnetic Field	A	PASS	
IEC 61000-4-11:2001	Volt. Interruptions Volt. Dips	B / C / C NOTE (3)	PASS	

NOTE:

- (1) " N/A" denotes test is not applicable in this Test Report.
- (2) The power consumption of EUT is less than 75W and no Limits apply.
- (3) Voltage dip: >95% reduction – Performance Criteria **B**
Voltage dip: 30% reduction – Performance Criteria **C**
Voltage Interruption: >95% reduction – Performance Criteria **C**
- (4) For client's request and manual description, the test will not be executed.

2.1 TEST FACILITY

The test facilities used to collect the test data in this report is **C01/OS01** at the location of No.132-1, Lane 329, Sec. 2, Palain Road, Shijr City, Taipei, Taiwan.

2.2 MEASUREMENT UNCERTAINTY

The reported uncertainty of measurement $y \pm U$, where expended uncertainty **U** is based on a standard uncertainty multiplied by a coverage factor of **k=2**, providing a level of confidence of approximately **95%**.

A. Conducted Measurement :

Test Site	Method	Measurement Frequency Range	U , (dB)	NOTE
C01	ANSI	150 KHz ~ 30MHz	1.94	

B. Radiated Measurement :

Test Site	Method	Measurement Frequency Range	Ant. H / V	U , (dB)	NOTE
OS-01	ANSI	30MHz ~ 200MHz	V	3.82	
		30MHz ~ 200MHz	H	3.60	
		200MHz ~ 1,000MHz	V	3.86	
		200MHz ~ 1,000MHz	H	3.94	
OS-02	ANSI	30MHz ~ 200MHz	V	2.48	
		30MHz ~ 200MHz	H	2.16	
		200MHz ~ 1,000MHz	V	2.50	
		200MHz ~ 1,000MHz	H	2.66	

3. GENERAL INFORMATION

3.1 GENERAL DESCRIPTION OF EUT

Equipment	Wii CONTACTLESS CHARGER
Brand Name	PowerHouse
Model Name	Wii07
OEM Brand/Model Name	N/A
Model Difference	N/A
Product Description	The EUT is a Wii CONTACTLESS CHARGER. Based on the application, features, or specification exhibited in User's Manual, the EUT is considered as an ITE/Computing Device. More details of EUT technical specification, please refer to the User's Manual.
Power Source	DC Voltage supplied from AC/DC adapter.
Power Rating	AC I/P 100-240V~50-60Hz, 0.3A / DC O/P 6.0V, 1.0A, 6.0W max
Connecting I/O Port(s)	Please refer to the User's Manual
Products Covered	AC/DC Adapter(Model No.: PA1008-1DU)
EUT Modification(s)	N/A

Note:

1. For a more detailed features description, please refer to the manufacturer's specifications or the User's Manual.

3.2 DESCRIPTION OF TEST MODES

To investigate the maximum EMI emission characteristics generates from EUT, the test system was pre-scanning tested base on the consideration of following EUT operation mode or test configuration mode which possible have effect on EMI emission level. Each of these EUT operation mode(s) or test configuration mode(s) mentioned above was evaluated respectively.

Pretest Test Mode	Description
Mode 1	charge

For Conducted Test	
Final Test Mode	Description
Mode 1	charge

For Radiated Test	
Final Test Mode	Description
Mode 1	charge

For Harmonics / Flicks Test	
Final Test Mode	Description
Mode 1	charge

For EMS Test	
Final Test Mode	Description
Mode 1	charge

3.3 BLOCK DIGRAM SHOWING THE CONFIGURATION OF SYSTEM TESTED

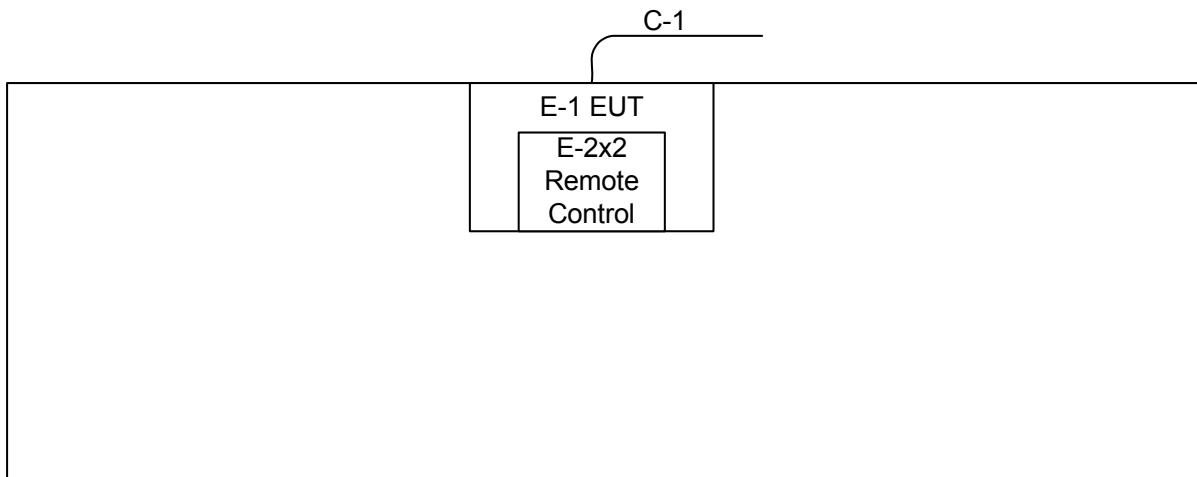

C-1 Power Cable

3.4 DESCRIPTION OF SUPPORT UNITS

The EUT has been tested as an independent unit together with other necessary accessories or support units. The following support units or accessories were used to form a representative test configuration during the tests.

Item	Equipment	Mfr/Brand	Model/Type No.	FCC ID	Series No.	Note
E-1	Wii CONTACTLESS CHARGER	PowerHouse	Wii07	VXDWII07	N/A	EUT
E-2	Remote control	Nintendo	RVL-003	POO-WC45	N/A	

Item	Shielded Type	Ferrite Core	Length	Note
C-1	NO	NO	1.5M	

Note:

- (1) The support equipment was authorized by Declaration of Conformity.
- (2) For detachable type I/O cable should be specified the length in cm in 『Length』 column.

4. EMC EMISSION TEST

4.1 CONDUCTED EMISSION MEASUREMENT

4.1.1 POWER LINE CONDUCTED EMISSION (FREQUENCY RANGE 150KHZ-30MHZ)

FREQUENCY (MHz)	Class A (dBuV)		Class B (dBuV)	
	Quasi-peak	Average	Quasi-peak	Average
0.15 -0.5	79.00	66.00	66 - 56 *	56 - 46 *
0.50 -5.0	73.00	60.00	56.00	46.00
5.0 -30.0	73.00	60.00	60.00	50.00

Note:

- (1) The tighter limit applies at the band edges.
- (2) The limit of " * " marked band means the limitation decreases linearly with the logarithm of the frequency in the range.

4.1.2 MEASUREMENT INSTRUMENTS LIST

Item	Kind of Equipment	Manufacturer	Type No.	Serial No.	Calibrated until
1	LISN	EMCO	3816/2	00042990	Jan. 25, 2008
2	Pulse Limiter	Electro-Metrics	EM-7600	112644	Nov. 27, 2008
3	Test Cable	N/A	C01	N/A	Oct. 10, 2008
4	EMI Test Receiver	R&S	ESCI	100082	Mar. 08, 2008

Remark: " N/A" denotes No Model Name , Serial No. or No Calibration specified.

4.1.3 TEST PROCEDURE

- a. The EUT was placed 0.4 meters from the horizontal ground plane with EUT being connected to the power mains through a line impedance stabilization network (LISN). All other support equipments powered from additional LISN(s). The LISN provide 50 Ohm/ 50uH of coupling impedance for the measuring instrument.
- b. Interconnecting cables that hang closer than 40 cm to the ground plane shall be folded back and forth in the center forming a bundle 30 to 40 cm long.
- c. I/O cables that are not connected to a peripheral shall be bundled in the center. The end of the cable may be terminated, if required, using the correct terminating impedance. The overall length shall not exceed 1 m.
- d. LISN at least 80 cm from nearest part of EUT chassis.
- e. For the actual test configuration, please refer to the related Item –EUT Test Photos.

4.1.4 DEVIATION FROM TEST STANDARD

No deviation

4.1.5 TEST SETUP

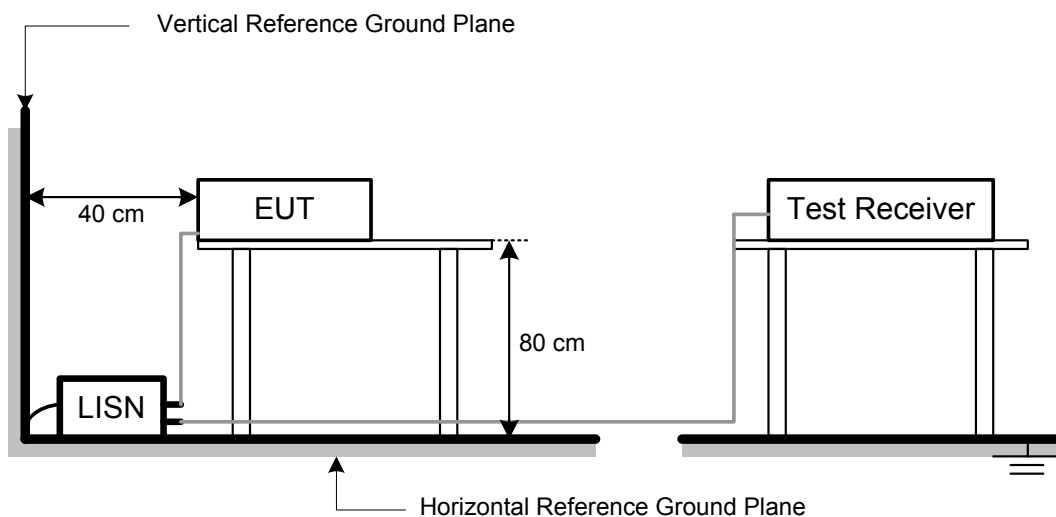

4.1.6 EUT OPERATING CONDITIONS

The EUT exercise program (EMC.exe) used during radiated and/or conducted emission measurement was designed to exercise the various system components in a manner similar to a typical use.

4.1.7 TEST RESULTS

E.U.T :	Wii CONTACTLESS CHARGER	Model Name :	Wii07
Temperature :	25 °C	Relative Humidity :	60%
Pressure :	1008 hPa	Test Voltage :	AC 230V/50Hz
Test Mode :	charge		

Freq. (MHz)	Terminal L/N	Measured(dBuV)		Limits(dBuV)		Margin (dB)	Note
		QP-Mode	AV-Mode	QP-Mode	AV-Mode		
0.24	Line	55.35	38.06	62.13	52.13	-6.78	(QP)
0.31	Line	54.26	36.08	59.96	49.96	-5.70	(QP)
0.59	Line	51.14	34.33	56.00	46.00	-4.86	(QP)
0.71	Line	52.79	34.45	56.00	46.00	-3.21	(QP)
1.68	Line	51.30	36.48	56.00	46.00	-4.70	(QP)
4.92	Line	52.83	40.13	56.00	46.00	-3.17	(QP)

Remark

- (1) Reading in which marked as QP means measurements by using are Quasi-Peak Mode with Detector BW=9KHz; SPA setting in RBW=10KHz,VBW =10KHz, Swp. Time = 0.3 sec./MHz ◦ Reading in which marked as AV means measurements by using are Average Mode with instrument setting in RBW=1MHz,VBW=10Hz, Swp. Time =0.3 sec./MHz ◦
- (2) All readings are QP Mode value unless otherwise stated AVG in column of 'Note'. If the QP Mode Measured value compliance with the QP Limits and lower than AVG Limits, the EUT shall be deemed to meet both QP & AVG Limits and then only QP Mode was measured, but AVG Mode didn't perform ◦ In this case, a " * " marked in AVG Mode column of Interference Voltage Measured ◦
- (3) Measuring frequency range from 150KHz to 30MHz ◦

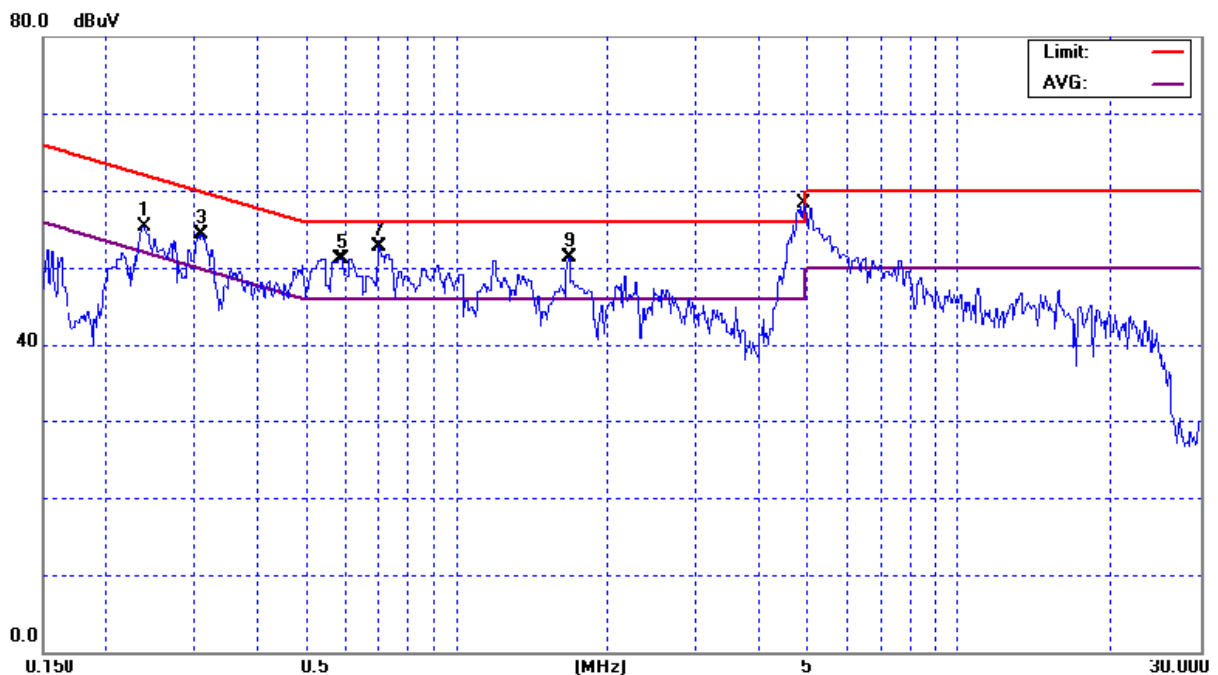

E.U.T :	Wii CONTACTLESS CHARGER	Model Name :	Wii07
Temperature :	25 °C	Relative Humidity :	60%
Pressure :	1008 hPa	Test Voltage :	AC 230V/50Hz
Test Mode :	charge		

Freq. (MHz)	Terminal L/N	Measured(dBuV)		Limits(dBuV)		Margin (dB)	Note
		QP-Mode	AV-Mode	QP-Mode	AV-Mode		
0.27	Neutral	51.59	30.26	61.21	51.21	-9.62	(QP)
0.53	Neutral	49.83	29.41	56.00	46.00	-6.17	(QP)
0.65	Neutral	48.97	28.74	56.00	46.00	-7.03	(QP)
0.92	Neutral	48.76	27.59	56.00	46.00	-7.24	(QP)
1.72	Neutral	46.28	31.27	56.00	46.00	-9.72	(QP)
4.96	Neutral	47.34	36.84	56.00	46.00	-8.66	(QP)

Remark

- (1) Reading in which marked as QP means measurements by using are Quasi-Peak Mode with Detector BW=9KHz; SPA setting in RBW=10KHz,VBW =10KHz, Swp. Time = 0.3 sec./MHz ◦ Reading in which marked as AV means measurements by using are Average Mode with instrument setting in RBW=1MHz,VBW=10Hz, Swp. Time =0.3 sec./MHz ◦
- (2) All readings are QP Mode value unless otherwise stated AVG in column of 'Note'. If the QP Mode Measured value compliance with the QP Limits and lower than AVG Limits, the EUT shall be deemed to meet both QP & AVG Limits and then only QP Mode was measured, but AVG Mode didn't perform ◦ In this case, a " * " marked in AVG Mode column of Interference Voltage Measured ◦
- (3) Measuring frequency range from 150KHz to 30MHz ◦

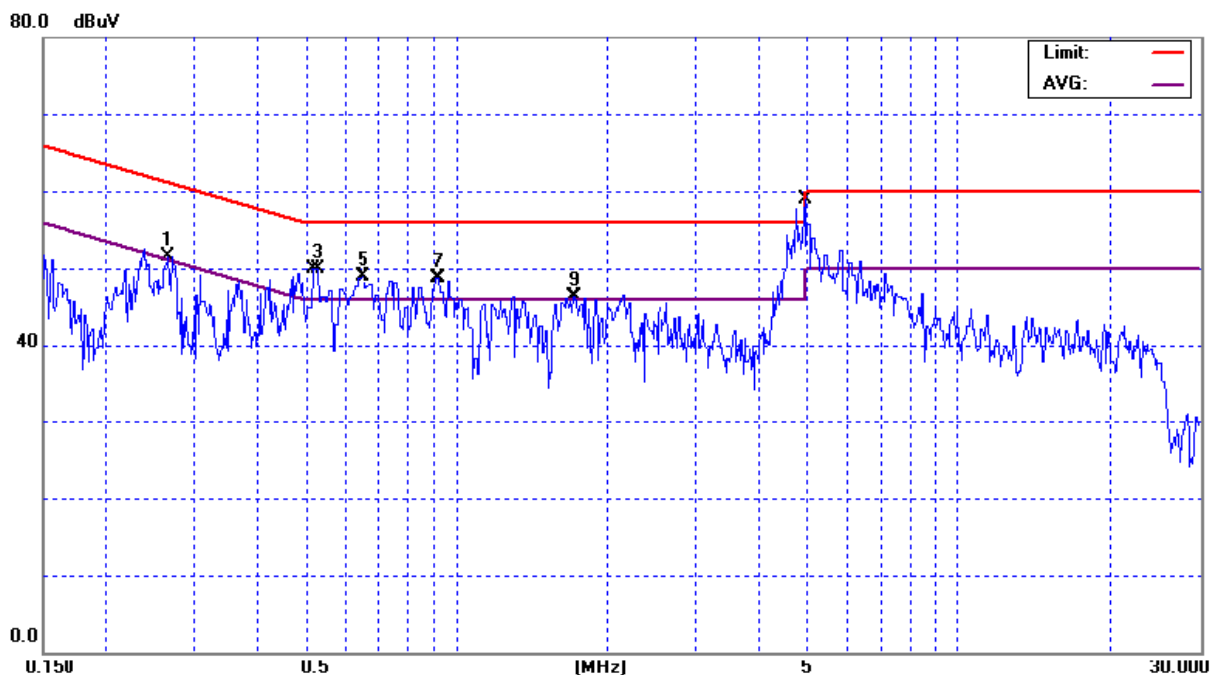

4.2 RADIATED EMISSION MEASUREMENT

4.2.1 LIMITS OF RADIATED EMISSION MEASUREMENT

FREQUENCY (MHz)	Class A (at 10m)	Class B (at 10m)
	dBuV/m	dBuV/m
30 – 230	40	30
230 – 1000	47	37

Notes:

- (1) The limit for radiated test was performed according to as following:
CISPR 22/ FCC PART 15B /ICES-003.
- (2) The tighter limit applies at the band edges.
- (3) Emission level (dBuV/m)=20log Emission level (uV/m).

4.2.2 MEASUREMENT INSTRUMENTS LIST

Item	Kind of Equipment	Manufacturer	Type No.	Serial No.	Calibrated until
1	Log-Bicon Antenna	Schwarzbeck	VULB 9160	3176	Feb. 05, 2008
2	Test Cable	N/A	10M_OS01	N/A	Oct. 10, 2008
3	Test Cable	N/A	OS01-1/-2	N/A	Oct. 10, 2008
4	Pre-Amplifier	Anritsu	MH648A(OS01)	M09961	Oct. 10, 2008
5	EMI Test Receiver	R&S	ESCI	100080	Mar. 08, 2008
6	Antenna Mast	Chance Most	CMTB-1.5	N/A	N/A
7	Turn Table	Chance Most	CMTB-1.5	N/A	N/A

Remark: " N/A" denotes No Model Name / Serial No. and No Calibration specified.

4.2.3 TEST PROCEDURE

- a. The measuring distance of at 10 m shall be used for measurements at frequency up to 1GHz. For frequencies above 1GHz, any suitable measuring distance may be used.
- b. The EUT was placed on the top of a rotating table 0.8 meters above the ground at a 3m or 10 meter open area test site. The table was rotated 360 degrees to determine the position of the highest radiation.
- c. The height of the equipment or of the substitution antenna shall be 0.8 m; the height of the test antenna shall vary between 1 m to 4 m. Both horizontal and vertical polarizations of the antenna are set to make the measurement.
- d. The initial step in collecting radiated emission data is a spectrum analyzer peak detector mode pre-scanning the measurement frequency range. Significant peaks are then marked and then Quasi Peak detector mode re-measured.
- e. If the Peak Mode measured value compliance with and lower than Quasi Peak Mode Limit, the EUT shall be deemed to meet QP Limits and then no additional QP Mode measurement performed.
- f. For the actual test configuration, please refer to the related Item –EUT Test Photos.

4.2.4 DEVIATION FROM TEST STANDARD

No deviation

4.2.5 TEST SETUP

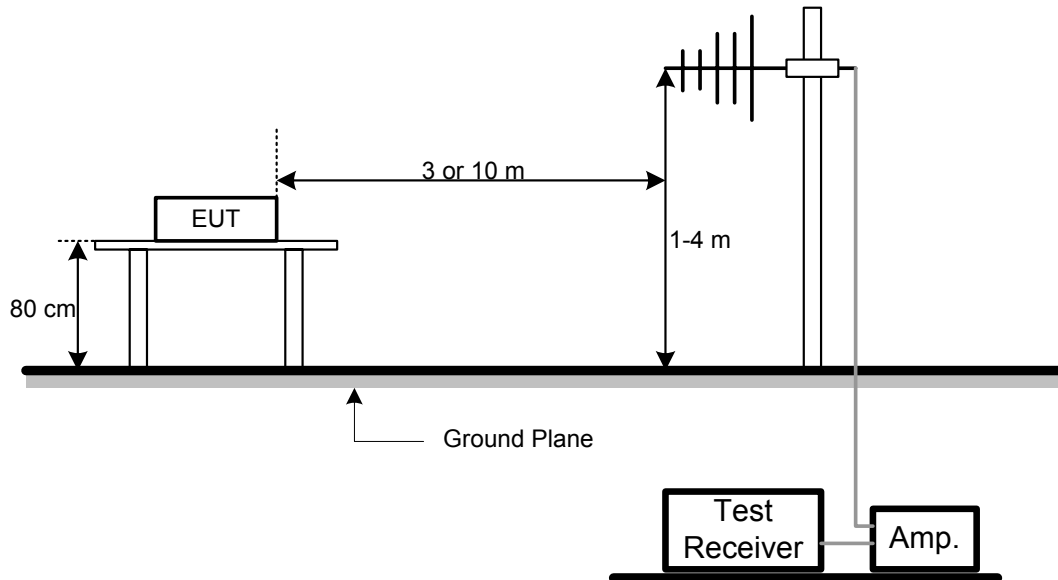

4.2.6 EUT OPERATING CONDITIONS

The EUT tested system was configured as the statements of 4.1.6 Unless otherwise a special operating condition is specified in the follows during the testing.

4.2.7 TEST RESULTS

E.U.T :	Wii CONTACTLESS CHARGER	Model Name :	Wii07
Temperature :	13 °C	Relative Humidity :	84%
Pressure :	1029 hPa	Test Voltage :	AC 230V/50Hz
Test Mode :	charge		

Freq. (MHz)	Ant. H/V	Reading(RA) (dBuV)	Corr.Factor(CF) (dB)	Measured(FS) (dBuV/m)	Limits(QP) (dBuV/m)	Margin (dB)	Note
42.60	V	27.32	-6.77	20.55	30.00	- 9.45	
56.30	V	31.42	-6.67	24.75	30.00	- 5.25	
120.30	V	31.45	-6.41	25.04	30.00	- 4.96	
149.70	V	26.15	-5.37	20.78	30.00	- 9.22	
164.00	V	25.80	-4.91	20.89	30.00	- 9.11	
203.10	V	28.45	-8.02	20.43	30.00	- 9.57	

Remark :

- (1) Reading in which marked as QP or Peak means measurements by using are Quasi-Peak Mode or Peak Mode with Detector BW=120KHz ; SPA setting in RBW=120KHz, VBW =120KHz, Swp. Time = 0.3 sec./MHz ◦
- (2) All readings are Peak unless otherwise stated QP in column of 『Note』 . Peak denotes that the Peak reading compliance with the QP Limits and then QP Mode measurement didn't perform ◦
- (3) Measuring frequency range from 30MHz to 1000MHz ◦
- (4) If the peak scan value lower limit more than 20dB, then this signal data does not how in table ◦

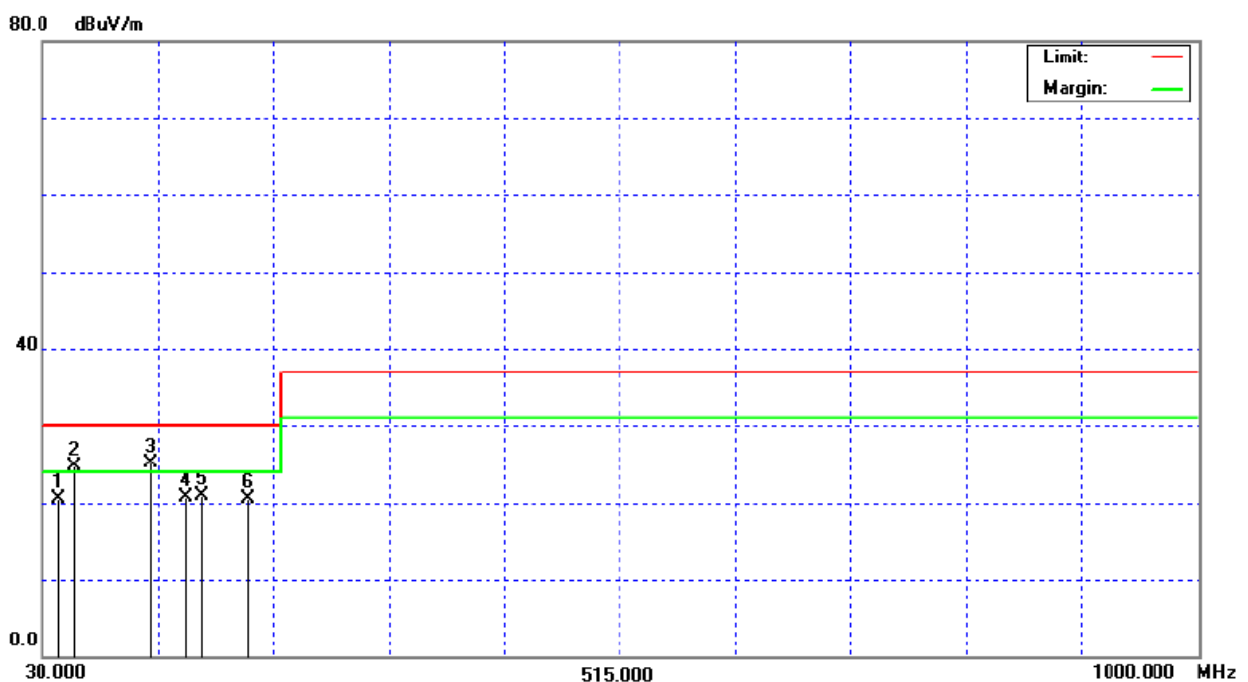

E.U.T :	Wii CONTACTLESS CHARGER	Model Name :	Wii07
Temperature :	13 °C	Relative Humidity :	84%
Pressure :	1029 hPa	Test Voltage :	AC 230V/50Hz
Test Mode :	charge		

Freq. (MHz)	Ant. H/V	Reading(RA) (dBuV)	Corr.Factor(CF) (dB)	Measured(FS) (dBuV/m)	Limits(QP) (dBuV/m)	Margin (dB)	Note
55.70	H	26.40	-6.64	19.76	30.00	- 10.24	
72.60	H	28.30	-9.10	19.20	30.00	- 10.80	
122.00	H	25.80	-6.34	19.46	30.00	- 10.54	
145.40	H	26.92	-5.43	21.49	30.00	- 8.51	
160.30	H	26.40	-4.70	21.70	30.00	- 8.30	
203.70	H	26.85	-8.02	18.83	30.00	- 11.17	

Remark :

- (1) Reading in which marked as QP or Peak means measurements by using are Quasi-Peak Mode or Peak Mode with Detector BW=120KHz ; SPA setting in RBW=120KHz, VBW =120KHz, Swp. Time = 0.3 sec./MHz ◦
- (2) All readings are Peak unless otherwise stated QP in column of 『Note』 . Peak denotes that the Peak reading compliance with the QP Limits and then QP Mode measurement didn't perform ◦
- (3) Measuring frequency range from 30MHz to 1000MHz ◦
- (4) If the peak scan value lower limit more than 20dB, then this signal data does not how in table ◦

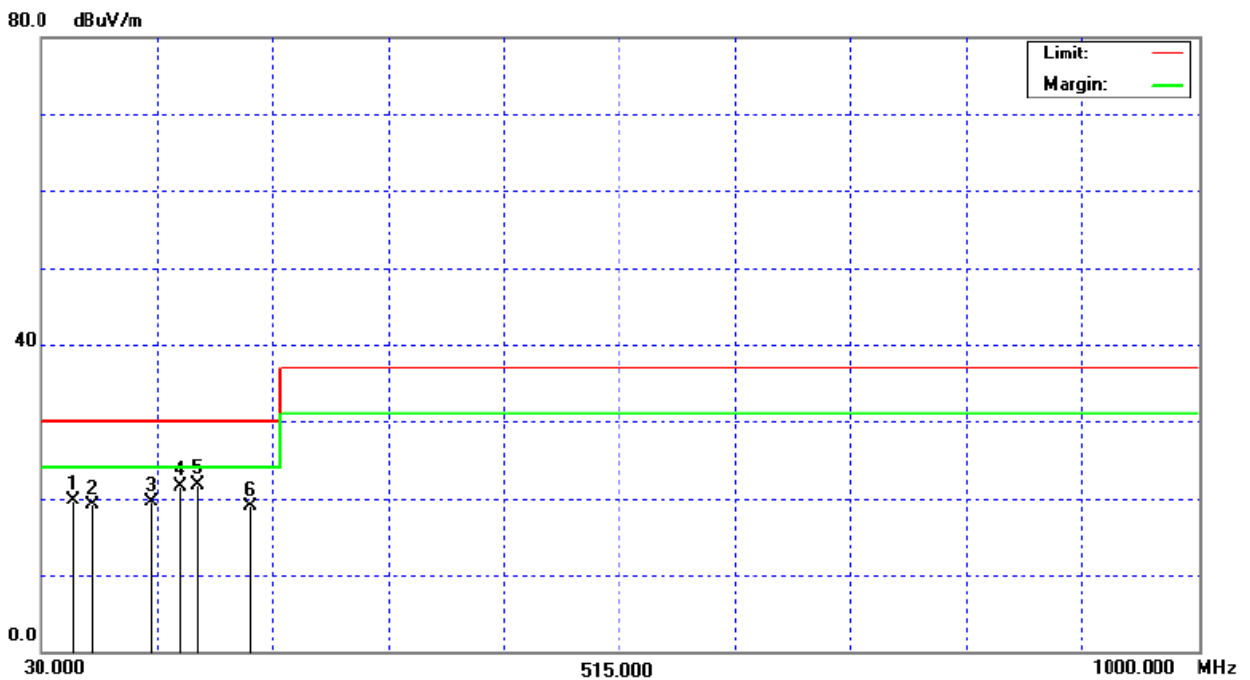

4.3 HARMONICS CURRENT MEASUREMENT

4.3.1 LIMITS OF HARMONICS CURRENT MEASUREMENT

IEC 555-2					
Table - I			Table - II		
Equipment Category	Harmonic Order n	Max. Permissible Harmonic Current (in Amperes)	Equipment Category	Harmonic Order n	Max. Permissible Harmonic Current (in Amperes)
Non Portable Tools or TV Receivers	Odd Harmonics		TV Receivers	Odd Harmonics	
	3	2.30		3	0.80
	5	1.14		5	0.60
	7	0.77		7	0.45
	9	0.40		9	0.30
	11	0.33		11	0.17
	13	0.21		13	0.12
	15 ≤ n ≤ 39	0.15 · 15/n		15 ≤ n ≤ 39	0.10 · 15/n
	Even Harmonics			Even Harmonics	
	2	1.08		2	0.30
4	0.43	4	0.15		
8	0.30				
8 ≤ n ≤ 40	0.23 · 8/n	DC	0.05		

EN 61000-3-2/IEC 61000-3-2					
Equipment Category	Max. Permissible Harmonic Current (in Amperes)	Equipment Category	Harmonic Order n	Max. Permissible Harmonic Current (in A)	Max. Permissible Harmonic Current (mA/w)
Class A	Same as Limits Specified in 4-2.1, Table - I, but only odd harmonics required	Class D	3	2.30	3.4
			5	1.14	1.9
			7	0.77	1.0
			9	0.40	0.5
			11	0.33	0.35
			13 ≤ n ≤ 39	see Table I	3.85/n

4.3.2 MEASUREMENT INSTRUMENTS LIST

Item	Kind of Equipment	Manufacturer	Type No.	Serial No.	Calibrated until
1	Harmonic & Flicker	California	PACS-1	72345	Mar, 05, 2008
2	Power Source	California	300iX	56310	Mar, 05, 2008

Remark: " N/A" denotes No Model Name / Serial No. and No Calibration specified.

4.3.3 TEST PROCEDURE

- a. The EUT was placed on the top of a wooden table 0.8 meters above the ground and operated to produce the maximum harmonic components under normal operating conditions.
- b. The classification of EUT is according to section 5 of EN 61000-3-2: 2006. The EUT is classified as follows:
 - Class A: Balanced three-phase equipment, Household appliances excluding equipment as Class D, Tools excluding portable tools, Dimmers for incandescent lamps, audio equipment, equipment not specified in one of the three other classes.
 - Class B: Portable tools. Portable tools.; Arc welding equipment which is not professional equipment.
 - Class C: Lighting equipment.
 - Class D: Equipment having a specified power less than or equal to 600 W of the following types: Personal computers and personal computer monitors and television receivers.
- c. The correspondent test program of test instrument to measure the current harmonics emanated from EUT is chosen. The measure time shall be not less than the time necessary for the EUT to be exercised.
- d. For the actual test configuration, please refer to the related item –EUT Test Photos.

4.3.4 DEVIATION FROM TEST STANDARD

No deviation

4.3.5 TEST SETUP

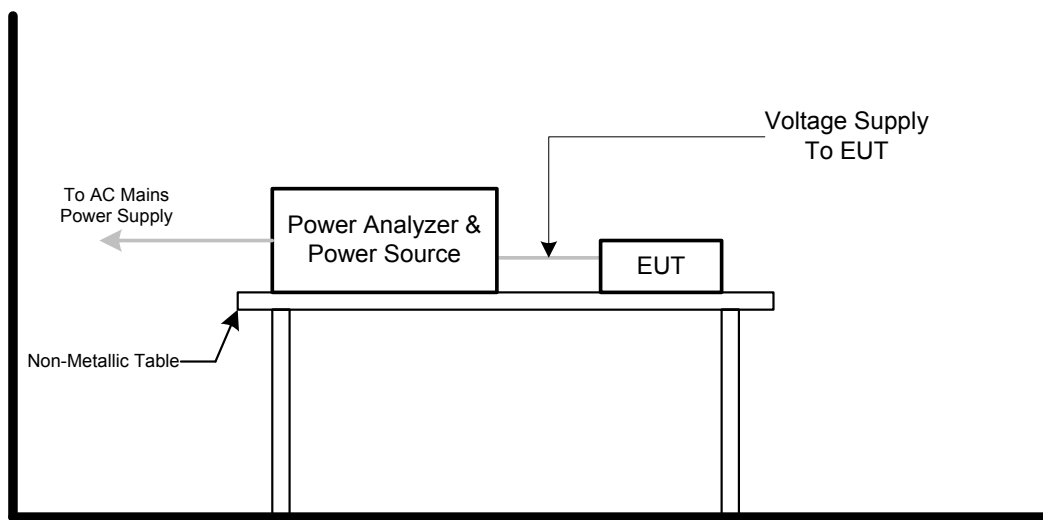

4.3.6 EUT OPERATING CONDITIONS

The EUT tested system was configured as the statements of 4.1.6 Unless otherwise a special operating condition is specified in the follows during the testing.

4.3.7 TEST RESULTS

Harmonics – Class-D per Ed. 3.0 (2005-11)Ed. 2.1(Run time) incl. inter-harmonics			
E.U.T :	Wii CONTACTLESS CHARGER	Model Name :	Wii07
Temperature :	24 °C	Relative Humidity :	44%
Pressure :	1015.4 hPa	Test Voltage :	AC 230V/50Hz
Test Mode :	charge		

Current & voltage waveforms

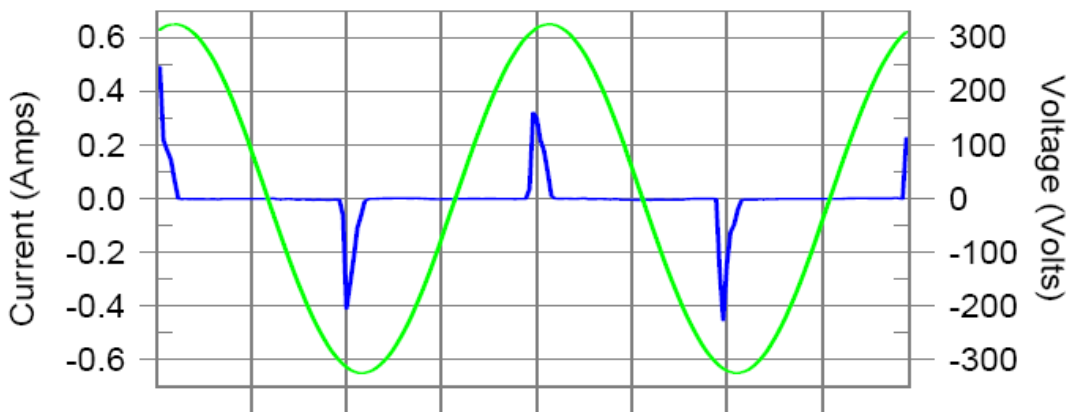

Harmonics and Class A limit line European Limits

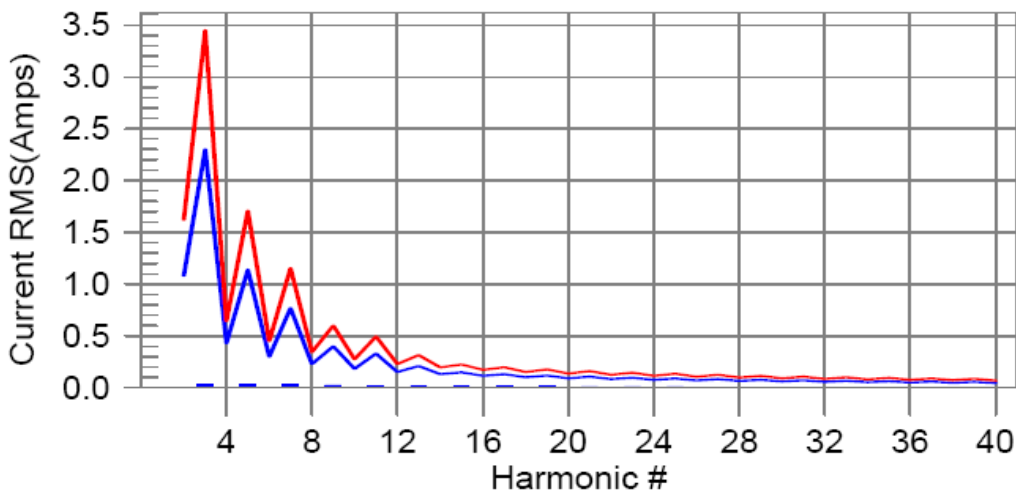

Test result: Pass Worst harmonic was #15 with 9.46% of the limit.

Current Test Result Summary (Run time)			
E.U.T :	Wii CONTACTLESS CHARGER	Model Name :	Wii07
Temperature :	24 °C	Relative Humidity :	44%
Pressure :	1015.4 hPa	Test Voltage :	AC 230V/50Hz
Highest parameter values during test:			
V_RMS (Volts):	229.96	Frequency(Hz):	50.00
I_Peak (Amps):	0.516	I_RMS (Amps):	0.082
I_Fund (Amps):	0.033	Crest Factor:	9.401
Power (Watts):	7.7	Power Factor:	0.406
Test Mode:	charge		

Harm#	Harms(avg)	100%Limit	%of Limit	Harms(max)	150%Limit	%of Limit	Status
2	0.001	1.080	0.1	0.002	1.620	0.10	Pass
3	0.025	2.300	1.1	0.032	3.450	0.92	Pass
4	0.001	0.430	0.2	0.001	0.645	0.21	Pass
5	0.024	1.140	2.1	0.030	1.710	1.77	Pass
6	0.001	0.300	0.3	0.001	0.450	0.28	Pass
7	0.022	0.770	2.9	0.028	1.155	2.42	Pass
8	0.001	0.230	0.4	0.001	0.345	0.35	Pass
9	0.020	0.400	5.1	0.025	0.600	4.19	Pass
10	0.001	0.184	0.5	0.001	0.276	0.45	Pass
11	0.018	0.330	5.6	0.022	0.495	4.45	Pass
12	0.001	0.153	0.6	0.001	0.230	0.56	Pass
13	0.016	0.210	7.8	0.019	0.315	5.98	Pass
14	0.001	0.131	0.7	0.001	0.197	0.67	Pass
15	0.014	0.150	9.5	0.016	0.225	7.03	Pass
16	0.001	0.115	0.9	0.001	0.173	0.79	Pass
17	0.012	0.132	9.3	0.013	0.199	6.62	Pass
18	0.001	0.102	1.0	0.001	0.153	0.93	Pass
19	0.011	0.118	8.9	0.011	0.178	6.33	Pass
20	0.001	0.092	1.1	0.001	0.138	1.04	Pass
21	0.009	0.107	8.6	0.010	0.161	6.04	Pass
22	0.001	0.084	1.3	0.001	0.125	1.16	Pass
23	0.008	0.098	8.4	0.009	0.147	6.08	Pass
24	0.001	0.077	1.4	0.001	0.115	1.25	Pass
25	0.007	0.090	8.2	0.009	0.135	6.34	Pass
26	0.001	0.071	1.4	0.001	0.106	1.32	Pass
27	0.007	0.083	8.1	0.008	0.125	6.62	Pass
28	0.001	0.066	1.5	0.001	0.099	1.34	Pass
29	0.006	0.078	8.0	0.008	0.116	6.83	Pass
30	0.001	0.061	1.5	0.001	0.092	1.37	Pass
31	0.006	0.073	7.8	0.007	0.109	6.82	Pass
32	0.001	0.058	1.5	0.001	0.086	1.34	Pass
33	0.005	0.068	7.4	0.007	0.102	6.67	Pass
34	0.001	0.054	1.4	0.001	0.081	1.30	Pass
35	0.004	0.064	6.9	0.006	0.096	6.33	Pass
36	0.001	0.051	1.4	0.001	0.077	1.23	Pass
37	0.004	0.061	6.4	0.005	0.091	5.87	Pass
38	0.001	0.048	1.3	0.001	0.073	1.16	Pass
39	0.003	0.058	5.8	0.005	0.087	5.36	Pass
40	0.000	0.046	0.9	0.001	0.069	0.80	Pass

Voltage Source Verification Data (Run time)			
E.U.T :	Wii CONTACTLESS CHARGER	Model Name :	Wii07
Temperature :	24 °C	Relative Humidity :	44%
Pressure :	1015.4 hPa	Test Voltage :	AC 230V/50Hz
Highest parameter values during test:			
V_RMS (Volts):	229.96	Frequency(Hz):	50.00
I_Peak (Amps):	0.516	I_RMS (Amps):	0.082
I_Fund (Amps):	0.033	Crest Factor:	9.401
Power (Watts):	7.7	Power Factor:	0.406
Test Mode:	charge		

Harm#	Harmonics V-rms	Limit V-rms	% of Limit	Status
2	0.069	0.460	14.94	OK
3	0.429	2.069	20.72	OK
4	0.021	0.460	4.53	OK
5	0.028	0.920	3.09	OK
6	0.025	0.460	5.41	OK
7	0.032	0.690	4.63	OK
8	0.016	0.460	3.56	OK
9	0.011	0.460	2.29	OK
10	0.014	0.460	3.01	OK
11	0.024	0.230	10.51	OK
12	0.015	0.230	6.56	OK
13	0.006	0.230	2.82	OK
14	0.011	0.230	4.74	OK
15	0.017	0.230	7.51	OK
16	0.017	0.230	7.43	OK
17	0.014	0.230	5.99	OK
18	0.018	0.230	7.81	OK
19	0.011	0.230	4.91	OK
20	0.014	0.230	6.03	OK
21	0.015	0.230	6.59	OK
22	0.007	0.230	3.26	OK
23	0.009	0.230	4.04	OK
24	0.007	0.230	2.94	OK
25	0.013	0.230	5.78	OK
26	0.007	0.230	3.22	OK
27	0.008	0.230	3.51	OK
28	0.005	0.230	2.38	OK
29	0.012	0.230	5.10	OK
30	0.009	0.230	3.78	OK
31	0.011	0.230	4.93	OK
32	0.005	0.230	2.32	OK
33	0.010	0.230	4.24	OK
34	0.003	0.230	1.16	OK
35	0.011	0.230	4.59	OK
36	0.004	0.230	1.79	OK
37	0.006	0.230	2.75	OK
38	0.002	0.230	1.05	OK
39	0.009	0.230	4.00	OK
40	0.006	0.230	2.39	OK

4.4 VOLTAGE FLUCTUATION AND FLICKERS MEASUREMENT

4.4.1 LIMITS OF VOLTAGE FLUCTUATION AND FLICKERS MEASUREMENT

Tests	Limits		Descriptions
	IEC555-3	IEC/EN 61000-3-2	
Pst	≤ 1.0, Tp= 10 min.	≤ 1.0, Tp= 10 min.	Short Term Flicker Indicator
Plt	N/A	≤ 0.65, Tp=2 hr.	Long Term Flicker Indicator
dc	≤ 3%	≤ 3.3%	Relative Steady-State V-Chang
dmax	≤ 4%	≤ 4%	Maximum Relative V-change
d (t)	N/A	≤ 3.3% for > 500 ms	Relative V-change characteristic

4.4.2 MEASUREMENT INSTRUMENTS LIST

Item	Kind of Equipment	Manufacturer	Type No.	Serial No.	Calibrated until
1	Harmonic & Flicker	California	PACS-1	72345	Mar, 05, 2008
2	Power Source	California	3001iX	56310	Mar, 05, 2008

Remark: " N/A" denotes No Model Name / Serial No. and No Calibration specified.

4.4.3 TEST PROCEDURE

- a. Harmonic Current Test:
Test was performed according to the procedures specified in Clause 5.0 of IEC555-2 and/or Sub-clause 6.2 of IEC/EN 61000-3-2 depend on which standard adopted for compliance measurement.
- b. Fluctuation and Flickers Test:
Tests was performed according to the Test Conditions/Assessment of Voltage Fluctuations specified in Clause 5.0/6.0 of IEC555-3 and/or Clause 6.0/4.0 of IEC/EN 61000-3-3 depend on which standard adopted for compliance measurement.
- c. All types of harmonic current and/or voltage fluctuation in this report are assessed by direct measurement using flicker-meter.
- d. For the actual test configuration, please refer to the related Item –EUT Test Photos.

4.4.4 DEVIATION FROM TEST STANDARD

No deviation

4.4.5 TESTSETUP

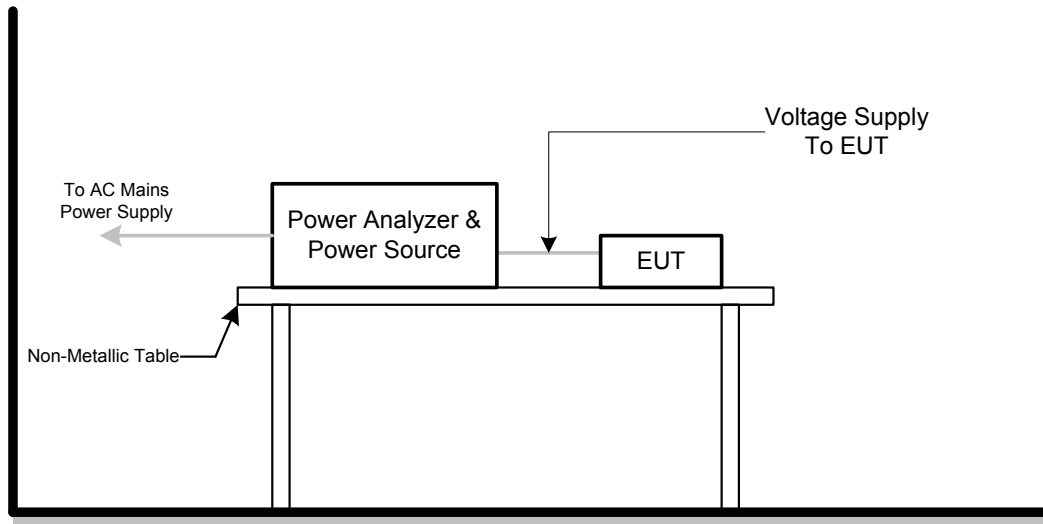

4.4.6 EUT OPERATING CONDITIONS

The EUT tested system was configured as the statements of 4.1.6 Unless otherwise a special operating condition is specified in the follows during the testing.

4.4.7 TEST RESULTS

E.U.T :	Wii CONTACTLESS CHARGER	Model Name :	Wii07
Temperature :	24 °C	Relative Humidity :	44%
Pressure :	1015.4 hPa	Test Voltage :	AC 230V/50Hz
Test Mode :	charge		

Pst. and limit line

European Limits

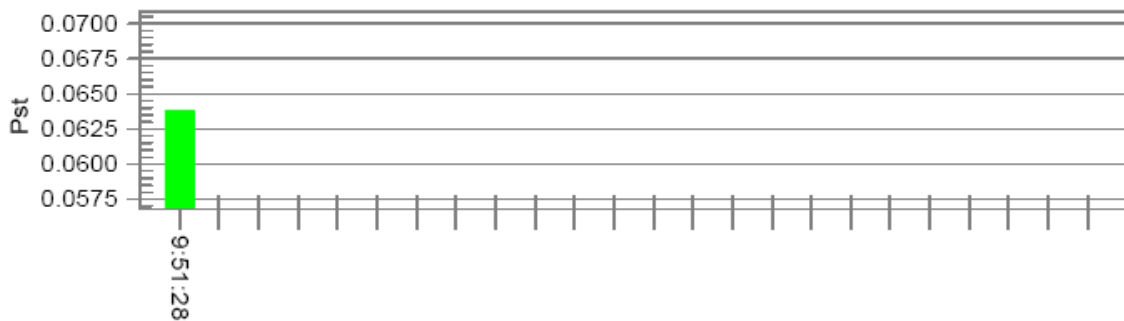

Plt and limit line

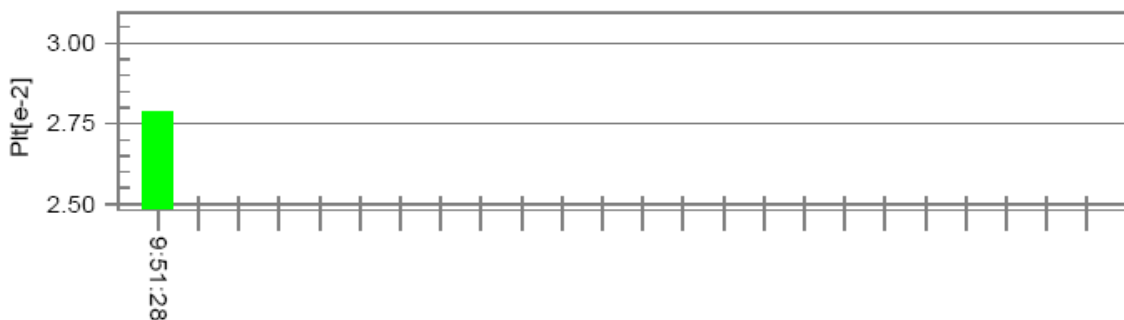

Parameter values recorded during the test:

Vrms at the end of test (Volt):	229.91		
Highest dt (%):	-0.22	Test limit (%):	3.30 Pass
Time(mS) > dt:	0.0	Test limit (mS):	500.0 Pass
Highest dc (%):	0.00	Test limit (%):	3.30 Pass
Highest dmax (%):	-0.24	Test limit (%):	4.00 Pass

5. EMC IMMUNITY TEST

5.1 STANDARD COMPLIANCE/SERVIRITY LEVEL/CRITERIA

Tests Standard No.	TEST SPECIFICATION Level	Test Mode Test Ports	Perform. Criteria	Remark
1. ESD IEC/EN 61000-4-2	8KV air discharge 4KV contact discharge	Direct Mode	B	
	4KV HCP discharge 4KV VCP discharge	Indirect Mode	B	
2. RS IEC/EN 61000-4-3	80 MHz to 1000 MHz 3V/m(rms), 1 KHz, 80%, AM modulated	Enclosure	A	
3. EFT/Burst IEC/EN 61000-4-4	1.0KV(peak) 5/50ns Tr/Th 5KHz Repetition Freq.	Power Supply Port	B	
	0.5 KV(peak) 5/50ns Tr/Th 5KHz Repetition Freq.	CTL/Signal Data Line Port	B	N/A (2)
4. Surges IEC/EN 61000-4-5	1 KV(5P/5N) 1.2/50(8/20) Tr/Th us	L-N	B	
	2 KV(5P/5N) 1.2/50(8/20) Tr/Th us	L-PE N-PE	B	N/A
5 Injected Current IEC/EN 61000-4-6	0.15 MHz to 80 MHz 3V(rms), 1KHz 80%, AM Modulated 150Ω source impedance	CTL/Signal Port	A	N/A (2)
	0.15 MHz to 80 MHz 3V(rms), 1KHz 80%, AM Modulated 150Ω source impedance	AC Power Port	A	
	0.15 MHz to 80 MHz 3V(rms), 1KHz 80%, AM Modulated 150Ω source impedance	DC Power Port	A	N/A
6. Power Frequency Magnetic Field IEC/EN 61000-4-8	50 Hz, 1A/m	Enclosure	A	
7. Volt. Interruptions Volt. Dips IEC/EN 61000-4-11	Voltage dip > 95%		B	
	Voltage dip 30%	AC Power Port	C	
	Interruption > 95%		C	

* Remark:

N/A : denotes test is not applicable in this Test Report

(1) : The EUT is a battery operating device and no any other cable connection to PC device.

(2) : Applicable only to cables which according to the manufacturer's specification supports communication on cables lengths greater than 3 m.

(3) : Applicable only to equipment containing devices susceptible to magnetic fields

5.2 GENERAL PERFORMANCE CRITERIA

According to **EN55024** standard, the general performance criteria as following:

<p>Criterion A</p>	<p>The equipment shall continue to operate as intended without operator intervention. No degradation of performance or loss of function is allowed below a performance level specified by the manufacturer when the equipment is used as intended. The performance level may be replaced by a permissible loss of performance. If the minimum performance level or the permissible performance loss is not specified by the manufacturer, then either of these may be derived from the product description and documentation, and by what the user product description and documentation, and by what the user may reasonably expect from the equipment if used as intended.</p>
<p>Criterion B</p>	<p>After the test, the equipment shall continue to operate as intended without operator Intervention. No degradation of performance or loss of function is allowed, after the application of the phenomenon below a performance level specified by the manufacturer, when the equipment is used as intended. The performance level may be replaced by a permissible loss of performance. During the test, degradation of performance is allowed. However, no change of operating state if stored data allowed to persist after the test. If the minimum performance level (or the permissible performance loss) is not specified by the manufacturer, then either of these may be derived from the product description and documentation, and by what the user may reasonably expect from the equipment if used as intended.</p>
<p>Criterion C</p>	<p>Loss of function is allowed, provided the function is self-recoverable, or can be restored by the operation of the controls by the user in accordance with the manufacturer’s instructions. Functions, and/or information stored in non-volatile memory, or protected by a battery backup, shall not be lost.</p>

5.3 GENERAL PERFORMANCE CRITERIA TEST SETUP

The EUT tested system was configured as the statements of **4.1.6** Unless otherwise a special operating condition is specified in the follows during the testing.

5.4 ESD TESTING

5.4.1 TEST SPECIFICATION

Basic Standard:	IEC/EN 61000-4-2
Discharge Impedance:	330 ohm / 150 pF
Required Performance	B
Discharge Voltage:	Air Discharge : 2kV/4kV/8kV (Direct) Contact Discharge : 2kV/4kV (Direct/Indirect)
Polarity:	Positive & Negative
Number of Discharge:	Air Discharge: min. 20 times at each test point Contact Discharge: min. 200 times in total
Discharge Mode:	Single Discharge
Discharge Period:	1 second minimum

5.4.2 MEASUREMENT INSTRUMENTS

Item	Kind of Equipment	Manufacturer	Type No.	Serial No.	Calibrated until
1	ESD Simulator	Schaffner	NSG435	1224	Jun, 21, 2008

Remark: " N/A" denotes No Model Name / Serial No. and No Calibration specified.

5.4.3 TEST PROCEDURE

The test generator necessary to perform direct and indirect application of discharges to the EUT in the following manner:

- a. Contact discharge was applied to conductive surfaces and coupling planes of the EUT. During the test, it was performed with single discharges. For the single discharge time between successive single discharges was at least 1 second. The EUT shall be exposed to at least 200 discharges, 100 each at negative and positive polarity, at a minimum of four test points. One of the test points shall be subjected to at least 50 indirect discharges to the center of the front edge of the horizontal coupling plane. The remaining three test points shall each receive at least 50 direct contact discharges. If no direct contact test points are available, then at least 200 indirect discharges shall be applied in the indirect mode. Test shall be performed at a maximum repetition rate of one discharge per second.
 - Vertical Coupling Plane (VCP):
The coupling plane, of dimensions 0.5m x 0.5m, is placed parallel to, and positioned at a distance 0.1m from, the EUT, with the Discharge Electrode touching the coupling plane. The four faces of the EUT will be performed with electrostatic discharge.
 - Horizontal Coupling Plane (HCP):
The coupling plane is placed under to the EUT. The generator shall be positioned vertically at a distance of 0.1m from the EUT, with the Discharge Electrode touching the coupling plane. The four faces of the EUT will be performed with electrostatic discharge.
- b. Air discharges at insulation surfaces of the EUT. It was at least ten single discharges with positive and negative at the same selected point.
- c. For the actual test configuration, please refer to the related Item –EUT Test Photos.

5.4.4 DEVIATION FROM TEST STANDARD

No deviation

5.4.5 TEST SETUP

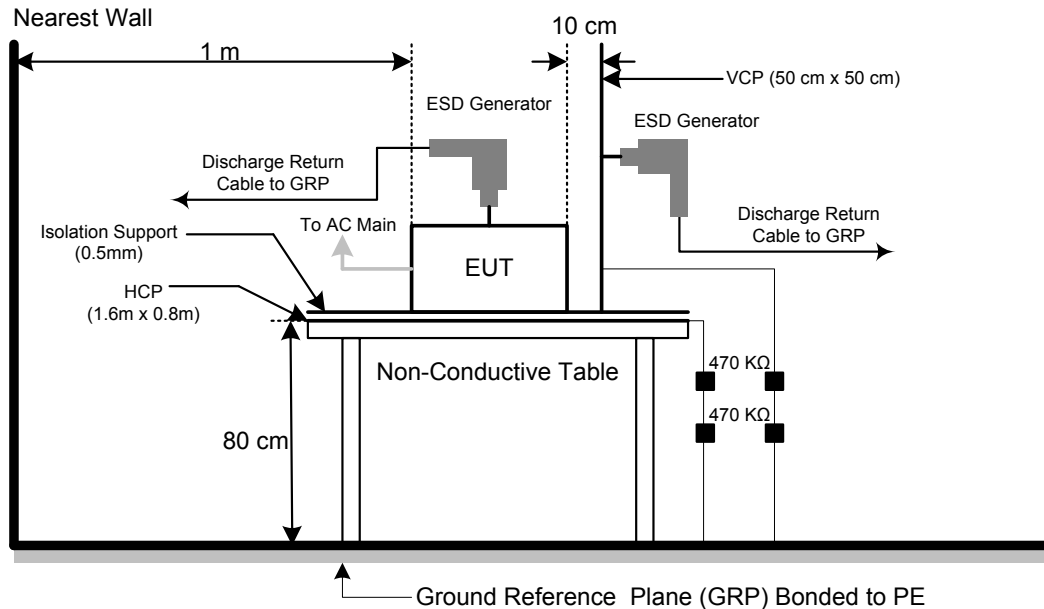

Note:

TABLE-TOP EQUIPMENT

The configuration consisted of a wooden table 0.8 meters high standing on the Ground Reference Plane. The GRP consisted of a sheet of aluminum at least 0.25mm thick, and 2.5 meters square connected to the protective grounding system. A Horizontal Coupling Plane (1.6m x 0.8m) was placed on the table and attached to the GRP by means of a cable with 940k total impedance. The equipment under test, was installed in a representative system as described in section 7 of IEC /EN 61000-4-2, and its cables were placed on the HCP and isolated by an insulating support of 0.5mm thickness. A distance of 1-meter minimum was provided between the EUT and the walls of the laboratory and any other metallic structure.

FLOOR-STANDING EQUIPMENT

The equipment under test was installed in a representative system as described in section 7 of IEC/EN 61000-4-2, and its cables were isolated from the Ground Reference Plane by an insulating support of 0.1-meter thickness. The GRP consisted of a sheet of aluminum that is at least 0.25mm thick, and 2.5meters square connected to the protective grounding system and extended at least 0.5 meters from the EUT on all sides.

5.4.6 TEST RESULTS

E.U.T :	Wii CONTACTLESS CHARGER	Model Name :	Wii07
Temperature :	24 °C	Relative Humidity :	44%
Pressure :	1015.4 hPa	Test Voltage :	AC 230V/50Hz
Test Mode :	charge		

Mode	Air Discharge								Contact Discharge							
	2KV		4KV		8KV		15KV		2KV		4KV		6KV		8KV	
Location	P	N	P	N	P	N	P	N	P	N	P	N	P	N	P	N
1	A	A	A	A	A	A										
2	A	A	A	A	A	A										
3	A	A	A	A	A	A										
4	A	A	A	A	A	A										
5	A	A	A	A	A	A										
6	A	A	A	A	A	A										
7	A	A	A	A	A	A										
8	A	A	A	A	A	A										
9	A	A	A	A	A	A										
10																
Criteria	B								B							
Result	A								N/A							
Judgment	PASS								N/A							

Mode	HCP Discharge								VCP Discharge							
	2KV		4KV		6KV		8KV		2KV		4KV		6KV		8KV	
Location	P	N	P	N	P	N	P	N	P	N	P	N	P	N	P	N
1	A	A	A	A					A	A	A	A				
2	A	A	A	A					A	A	A	A				
3	A	A	A	A					A	A	A	A				
4	A	A	A	A					A	A	A	A				
Criteria	B								B							
Result	A								A							
Judgment	PASS								PASS							

Note:

- 1) P/N denotes the Positive/Negative polarity of the output voltage.
- 2) Test condition:
Direct / Indirect (HCP/VCP) discharges: Minimum 50 times (Positive/Negative) at each point. Air discharges: Minimum 10 times (Positive/Negative) at each point.
- 3) Test location(s) in which discharge (Air and contact discharge) to be applied illustrated by photos shown in next page(s)
- 4) The Indirect (HCP/VCP) discharges description of test point as following:
1.left side 2.right side 3.front side 4.rear side
- 5) N/A - denotes test is not applicable in this test report
- 6) Criteria A: There was no change operated with initial operating during the test.
- 7) Criteria B: The EUT function loss during the test, but self-recoverable after the test.
- 8) Criteria C: The system shut down during the test.

5.4.7 PHOTO(S) SHOWN THE LOCATION(S) OF ESD EVALUATED

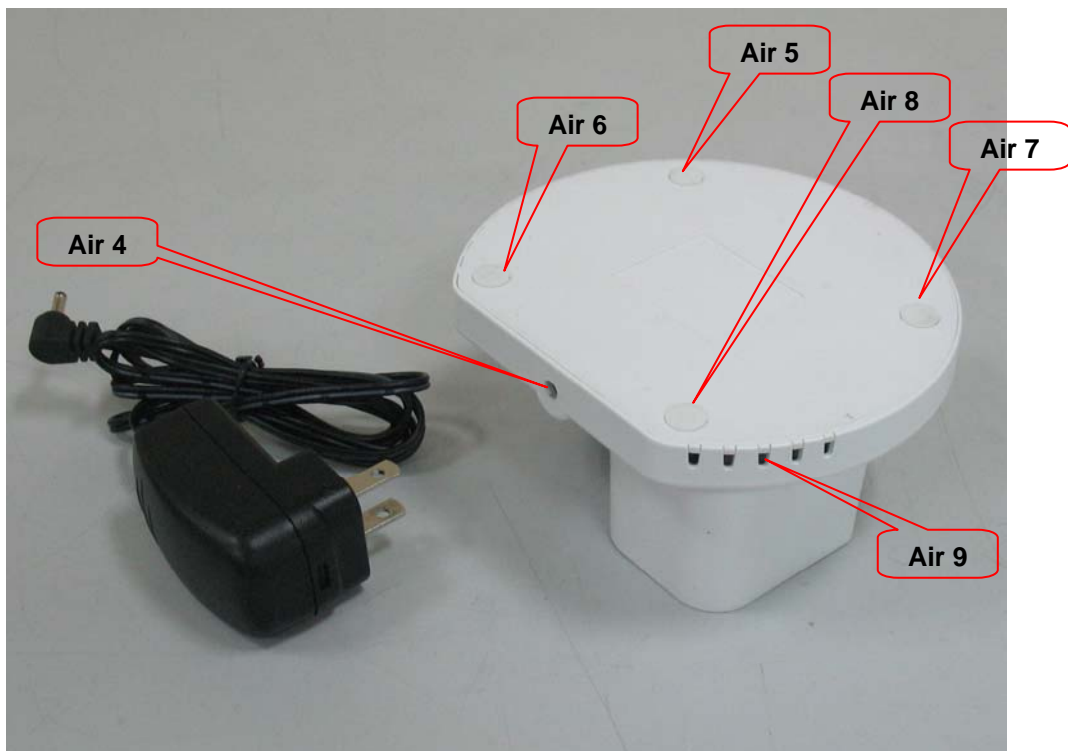

5.5 RS TESTING

5.5.1 TEST SPECIFICATION

Basic Standard:	IEC/EN 61000-4-3
Required Performance	A
Frequency Range:	80 MHz - 1000 MHz
Field Strength:	3 V/m
Modulation:	1kHz Sine Wave, 80%, AM Modulation
Frequency Step:	1% of fundamental
Polarity of Antenna:	Horizontal and Vertical
Test Distance:	3 m
Antenna Height:	1.5 m
Dwell Time:	at least 3 seconds

5.5.2 MEASUREMENT INSTRUMENTS

Item	Kind of Equipment	Manufacturer	Type No.	Serial No.	Calibrated until
1	Signal Generator	R&S	SMT 06	832080/007	Jul, 26, 2008
2	Log-Bicon Antenna	Schwarzbeck	VULB 9161	4022	Jun. 13, 2008
3	Power Amplifier	AR	150W1000M1	320946	Sep, 24. 2008

Remark: " N/A" denotes No Model Name / Serial No. and No Calibration specified.

5.5.3 TEST PROCEDURE

The EUT and support equipment, which are placed on a table that is 0.8 meter above ground and the testing was performed in a fully-anechoic chamber.

The testing distance from antenna to the EUT was 3 meters.

The other condition as following manner:

- a. The field strength level was 3V/m.
- b. The frequency range is swept from 80 MHz to 1000 MHz, with the signal 80%amplitude modulated with a 1kHz sine wave. The rate of sweep did not exceed 1.5×10^{-3} decade/s. Where the frequency range is swept incrementally, the step size was 1% of fundamental.
- c. Sweep Frequency 900 MHz, with the Duty Cycle:1/8 and Modulation: Pulse 217 Hz(if applicable)
- d. The dwell time at each frequency shall be not less than the time necessary for the EUT to be able to respond.
- e. The test was performed with the EUT exposed to both vertically and horizontally polarized fields on each of the four sides.
- f. For the actual test configuration, please refer to the related Item –EUT Test Photos.

5.5.4 DEVIATION FROM TEST STANDARD

No deviation

5.5.5 TEST SETUP

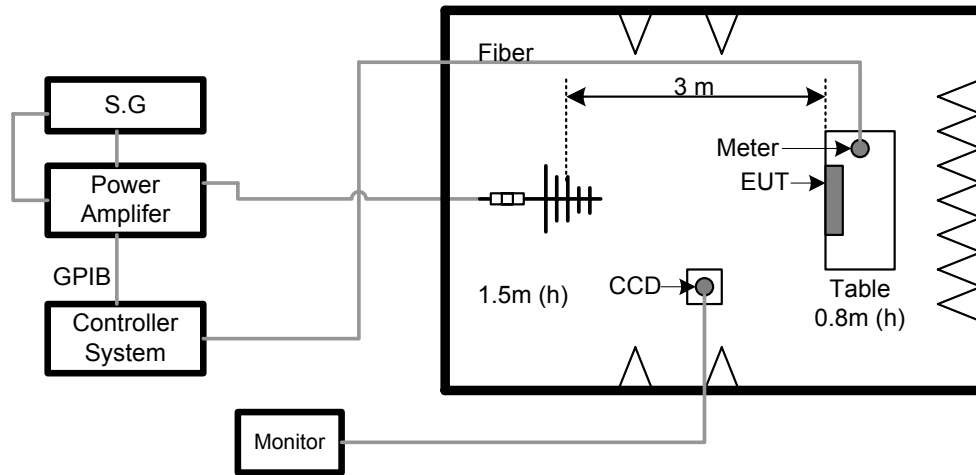

Note:

TABLE-TOP EQUIPMENT

The EUT installed in a representative system as described in section 7 of IEC/EN 61000-4-3 was placed on a non-conductive table 0.8 meters in height. The system under test was connected to the power and signal wire according to relevant installation instructions.

FLOOR-STANDING EQUIPMENT

The EUT installed in a representative system as described in section 7 of IEC/EN 61000-4-3 was placed on a non-conductive wood support 0.1 meters in height. The system under test was connected to the power and signal wire according to relevant installation instructions.

5.5.6 TEST RESULTS

E.U.T :	Wii CONTACTLESS CHARGER	Model Name :	Wii07
Temperature :	24 °C	Relative Humidity :	44%
Pressure :	1015.4 hPa	Test Voltage :	AC 230V/50Hz
Test Mode :	charge		

Frequency Range (MHz)	RF Field Position	R.F. Field Strength	Azimuth	Perform. Criteria	Results	Judgment
80MHz - 1000MHz	H / V	3 V/m (rms) AM Modulated 1000Hz, 80%	0	A	A	PASS
			90			
			180			
			270			

Note:

- 1) P/N denotes the Positive/Negative polarity of the output voltage.
- 2) N/A - denotes test is not applicable in this test report.
- 3) Criteria A: There was no change operated with initial operating during the test.
- 4) Criteria B: The EUT function loss during the test, but self-recoverable after the test.
- 5) Criteria C: The system shut down during the test.

5.6 EFT/BURST TESTING

5.6.1 TEST SPECIFICATION

Basic Standard:	IEC/EN 61000-4-4
Required Performance	B
Test Voltage :	Power Line: 1 kV Signal/Control Line: 0.5 KV
Polarity:	Positive & Negative
Impulse Frequency:	5 kHz
Impulse Wave shape :	5/50 ns
Burst Duration:	15 ms
Burst Period:	300 ms
Test Duration:	Not less than 1 min.

5.6.2 MEASUREMENT INSTRUMENTS

Item	Kind of Equipment	Manufacturer	Type No.	Serial No.	Calibrated until
1	EMC Immunity Test System	Thermo	EMCPRO PLUS	0502176	Dec, 17, 2008

Remark: " N/A" denotes No Model Name / Serial No. and No Calibration specified.

5.6.3 TEST PROCEDURE

The EUT and support equipment, are placed on a table that is 0.8 meter above a metal ground plane measured 1m*1m min. and 0.65mm thick min.

The other condition as following manner:

- a. The length of power cord between the coupling device and the EUT should not exceed 1 meter.
- b. Both positive and negative polarity discharges were applied.
- c. The duration time of each test sequential was 1 minute
- d. For the actual test configuration, please refer to the related Item –EUT Test Photos.

5.6.4 DEVIATION FROM TEST STANDARD

No deviation

5.6.5 TEST SETUP

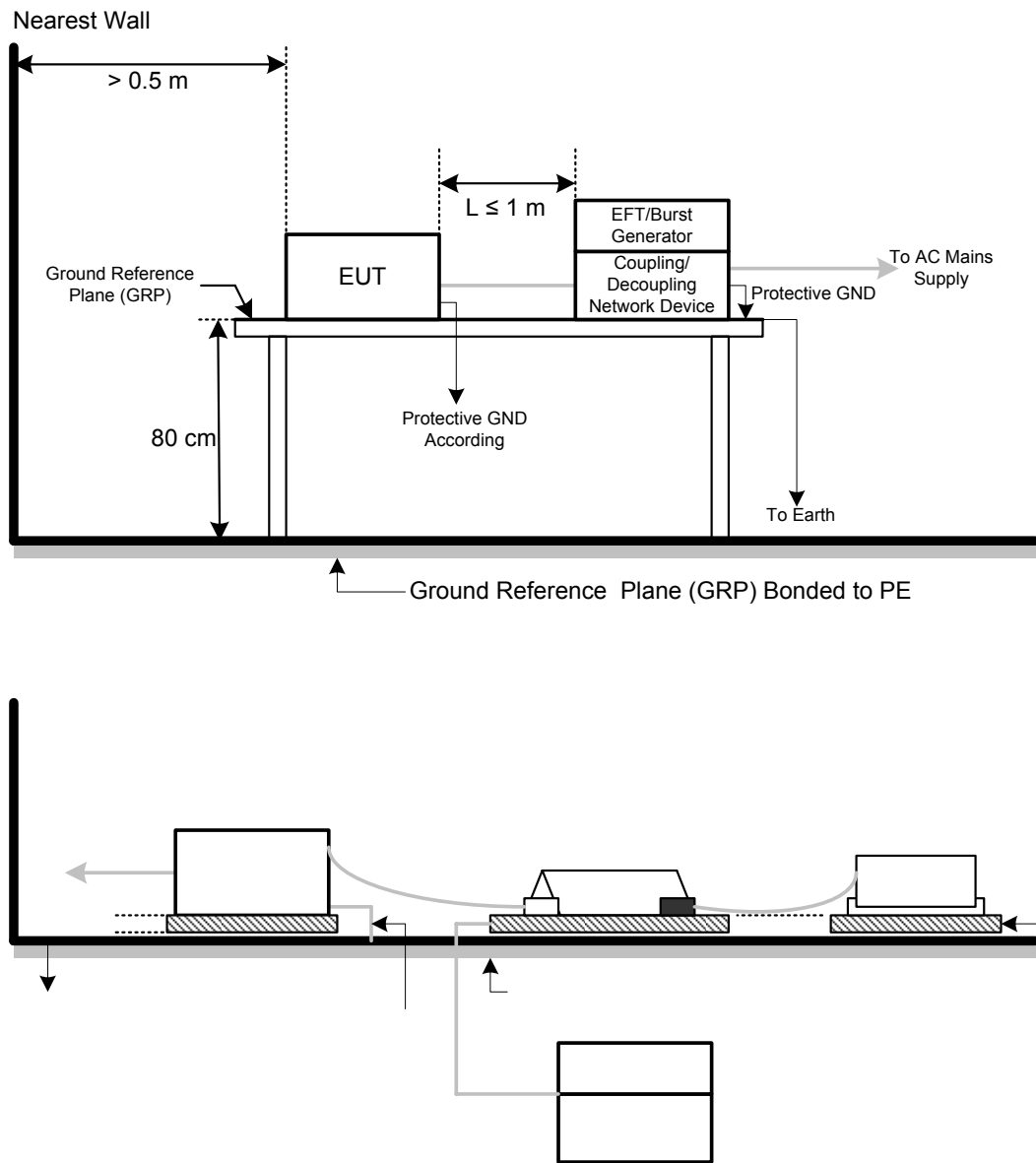

Note:

TABLE-TOP EQUIPMENT

The configuration consisted of a wooden table (0.8m high) standing on the Ground Reference Plane. The GRP consisted of a sheet of aluminum (at least 0.25mm thick and 2.5m square) connected to the protective grounding system. A minimum distance of 0.5m was provided between the EUT and the walls of the laboratory or any other metallic structure.

FLOOR-STANDING EQUIPMENT

The EUT installed in a representative system as described in section 7 of IEC/EN 61000-4-4 and its cables, were isolated from the Ground Reference Plane by an insulating support that is 0.1-meter thick. The GRP consisted of a sheet of aluminum (at least 0.25mm thick and 2.5m square) connected to the protective grounding system.

5.6.6 TEST RESULTS

E.U.T :	Wii CONTACTLESS CHARGER	Model Name :	Wii07
Temperature :	24 °C	Relative Humidity :	44%
Pressure :	1015.4 hPa	Test Voltage :	AC 230V/50Hz
Test Mode :	charge		

Mode	(X) AC Power Line		() DC Power Line		() Signal/Control Line	
Test Level	1KV		0.5KV		0.5KV	
Port(s)	Polarity	Results	Polarity	Results	Polarity	Results
Line (L)	P	B	P		P	
	N	B	N		N	
Neutral (N)	P	B	P		P	
	N	B	N		N	
Ground (PE)	P		P		P	
	N		N		N	
Signal/Control Line	P		P		P	
	N		N		N	
Criteria	B		B		B	
Result	B		N/A		N/A	
Judgment	PASS		N/A		N/A	

Note:

- 1) P/N denotes the Positive/Negative polarity of the output voltage.
- 2) N/A - denotes test is not applicable in this test report
- 3) Criteria A: There was no change operated with initial operating during the test.
- 4) Criteria B: The EUT function loss during the test, but self-recoverable after the test.
- 5) Criteria C: The system shut down during the test.

5.7 SURGE TESTING

5.7.1 TEST SPECIFICATION

Basic Standard:	IEC/EN 61000-4-5
Required Performance	B
Wave-Shape:	Combination Wave 1.2/50 us Open Circuit Voltage 8 /20 us Short Circuit Current
Test Voltage :	Power Line : 0.5 kV, 1 kV, 2 kV
Surge Input/Output:	L1-L2, L1-PE, L2-PE
Generator Source:	2 ohm between networks
Impedance:	12 ohm between network and ground
Polarity:	Positive/Negative
Phase Angle:	0 /90/180/270
Pulse Repetition Rate:	1 time / min. (maximum)
Number of Tests:	5 positive and 5 negative at selected points

5.7.2 MEASUREMENT INSTRUMENTS

Item	Kind of Equipment	Manufacturer	Type No.	Serial No.	Calibrated until
1	EMC Immunity Test System	Thermo	EMCPRO PLUS	0502176	Dec, 17, 2008

Remark: " N/A" denotes No Model Name / Serial No. and No Calibration specified.

5.7.3 TEST PROCEDURE

a. For EUT power supply:

The surge is to be applied to the EUT power supply terminals via the capacitive coupling network. Decoupling networks are required in order to avoid possible adverse effects on equipment not under test that may be powered by the same lines, and to provide sufficient decoupling impedance to the surge wave. The power cord between the EUT and the coupling/decoupling networks shall be 2meters in length (or shorter).

b. For test applied to unshielded unsymmetrically operated interconnection lines of EUT:

The surge is applied to the lines via the capacitive coupling. The coupling /decoupling networks shall not influence the specified functional conditions of the EUT. The interconnection line between the EUT and the coupling/decoupling networks shall be 2 meters in length (or shorter).

c. For test applied to unshielded symmetrically operated interconnection /telecommunication lines of EUT:

The surge is applied to the lines via gas arrestors coupling. Test levels below the ignition point of the coupling arrestor cannot be specified. The interconnection line between the EUT and the coupling/decoupling networks shall be 2 meters in length (or shorter).

d. For the actual test configuration, please refer to the related Item –EUT Test Photos.

5.7.4 DEVIATION FROM TEST STANDARD

No deviation

5.7.5 TEST SETUP

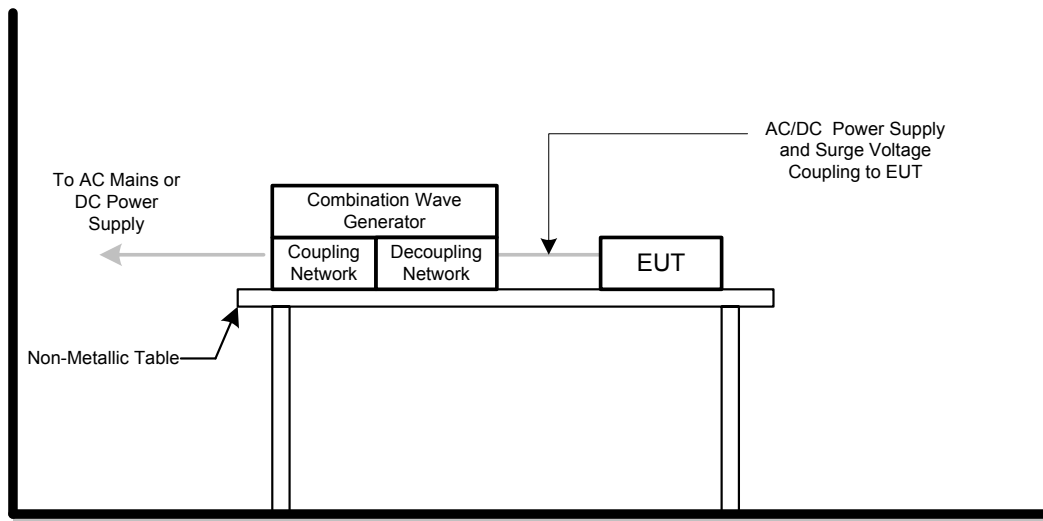

5.7.6 TEST RESULTS

E.U.T :	Wii CONTACTLESS CHARGER	Model Name :	Wii07
Temperature :	24 °C	Relative Humidity :	44%
Pressure :	1015.4 hPa	Test Voltage :	AC 230V/50Hz
Test Mode :	charge		

Wave Form EUT Ports Tested	1.2/50(8/20)Ti/Th us						Criteria	Judgment
	Polarity	Phase	Voltage					
			0.5Kv	1kV	1.5kV	2kV		
L - N	+/-	0°	A	A			B	PASS
	+/-	90°	A	A				
	+/-	180°	A	A				
	+/-	270°	A	A				
L - PE	+/-	0°					B	N/A
	+/-	90°						
	+/-	180°						
	+/-	270°						
N - PE	+/-	0°					B	N/A
	+/-	90°						
	+/-	180°						
	+/-	270°						
Signal Line (N/A)	+/-	N/A					B	N/A

Note:

- 1) Polarity and Numbers of Impulses : 5 Pst / Ngst at each tested mode
- 2) N/A - denotes test is not applicable in this Test Report
- 3) Criteria A: There was no change operated with initial operating during the test.
- 4) Criteria B: The EUT function loss during the test, but self-recoverable after the test.
- 5) Criteria C: The system shut down during the test.

5.8 INJECTION CURRENT TESTING

5.8.1 TEST SPECIFICATION

Basic Standard:	IEC/EN 61000-4-6
Required Performance	A
Frequency Range:	0.15 MHz - 80 MHz
Field Strength:	3 Vr.m.s.
Modulation:	1kHz Sine Wave, 80%, AM Modulation
Frequency Step:	1% of fundamental
Dwell Time:	at least 3 seconds

5.8.2 MEASUREMENT INSTRUMENTS

Item	Kind of Equipment	Manufacturer	Type No.	Serial No.	Calibrated until
1	Signal Generator	IFR	2023A	202301/368	Apr, 02, 2008
2	Power Amplifier	AR	75A250AM1	0320709	Sep, 24, 2008
3	CDN	FCC	FCC-801-M2 -16A	06043	Jun, 04, 2008

Remark: " N/A" denotes No Model Name / Serial No. and No Calibration specified.

5.8.3 TEST PROCEDURE

The EUT and support equipment, are placed on a table that is 0.8 meter above a metal ground plane measured 1m*1m min. and 0.65mm thick min.

The other condition as following manner:

- a. The field strength level was 3V.
- b. The frequency range is swept from 150 KHz to 80 MHz, with the signal 80%amplitude modulated with a 1kHz sine wave. The rate of sweep did not exceed 1.5×10^{-3} decade/s. Where the frequency range is swept incrementally, the step size was 1% of fundamental.
- c. The dwell time at each frequency shall be not less than the time necessary for the EUT to be able to respond.
- d. For the actual test configuration, please refer to the related Item –EUT Test Photos.

5.8.4 DEVIATION FROM TEST STANDARD

No deviation

5.8.5 TEST SETUP

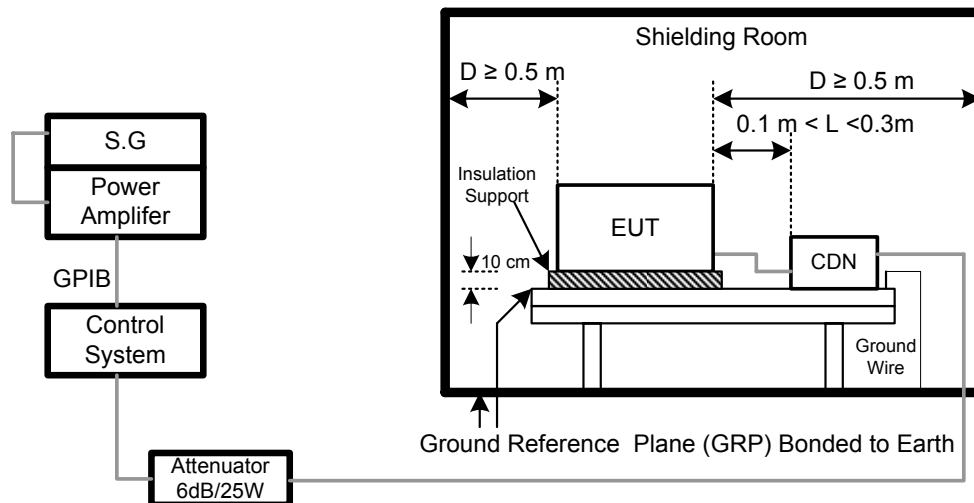

For the actual test configuration, please refer to the related Item –EUT Test Photos.

NOTE:

FLOOR-STANDING EQUIPMENT

The equipment to be tested is placed on an insulating support of 0.1 meters height above a ground reference plane. All relevant cables shall be provided with the appropriate coupling and decoupling devices at a distance between 0.1 meters and 0.3 meters from the projected geometry of the EUT on the ground reference plane.

5.8.6 TEST RESULTS

E.U.T :	Wii CONTACTLESS CHARGER	Model Name :	Wii07
Temperature :	24 °C	Relative Humidity :	44%
Pressure :	1015.4 hPa	Test Voltage :	AC 230V/50Hz
Test Mode :	charge		

Test Ports (Mode)	Freq. Range (MHz)	Field Strength	Perform. Criteria	Results	Judgment
Input/ Output AC. Power Port	0.15 ---80	3V(rms) AM Modulated 1000Hz, 80%	A	A	PASS
Input/ Output DC. Power Port	0.15 --- 80		A	N/A	N/A
Signal Line (N/A)	0.15 --- 80		A	N/A	N/A

Note:

- 1) N/A - denotes test is not applicable in this Test Report.
- 2) Criteria A: There was no change operated with initial operating during the test.
- 3) Criteria B: The EUT function loss during the test, but self-recoverable after the test.
- 4) Criteria C: The system shut down during the test.

5.9 POWER FREQUENCY MAGNETIC FIELD TESTING

5.9.1 TEST SPECIFICATION

Basic Standard:	IEC/EN 61000-4-8
Required Performance	A
Frequency Range:	50Hz
Field Strength:	1 A/m
Observation Time:	1 minute
Inductance Coil:	Rectangular type, 1mx1m

5.9.2 MEASUREMENT INSTRUMENTS

Item	Kind of Equipment	Manufacturer	Type No.	Serial No.	Calibrated until
1	Magnetic Field Test Generator	FCC	F-1000-4-8-G-1 25A	04029	Oct. 08, 2008

Remark: " N/A" denotes No Model Name / Serial No. and No Calibration specified.

5.9.3 TEST PROCEDURE

The EUT and support equipment, are placed on a table that is 0.8 meter above a metal ground plane measured 1m*1m min. and 0.65mm thick min.

The other condition as following manner:

- The equipment cabinets shall be connected to the safety earth directly on the GRP via the earth terminal of the EUT.
- The cables supplied or recommended by the equipment manufacturer shall be used. 1 meter of all cables used shall be exposed to the magnetic field.
- For the actual test configuration, please refer to the related Item –EUT Test Photos.

5.9.4 DEVIATION FROM TEST STANDARD

No deviation

5.9.5 TEST SETUP

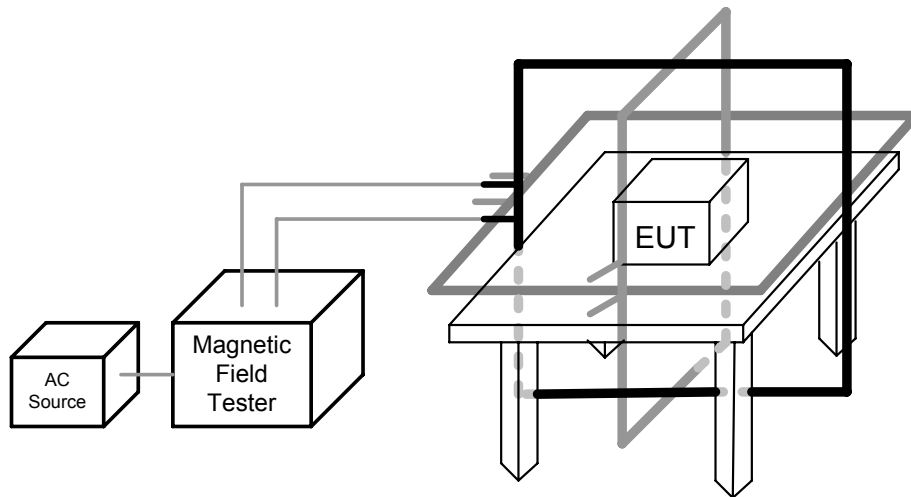

Note:

TABLE-TOP EQUIPMENT

The equipment shall be subjected to the test magnetic field by using the induction coil of standard dimension (1 m x 1 m). The induction coil shall then be rotated by 90 degrees in order to expose the EUT to the test field with different orientations.

FLOOR-STANDING EQUIPMENT

The equipment shall be subjected to the test magnetic field by using induction coils of suitable dimensions. The test shall be repeated by moving and shifting the induction coils, in order to test the whole volume of the EUT for each orthogonal direction. The test shall be repeated with the coil shifted to different positions along the side of the EUT, in steps corresponding to 50% of the shortest side of the coil. The induction coil shall then be rotated by 90 degrees in order to expose the EUT to the test field with different orientations.

5.9.6 TEST RESULTS

E.U.T :	Wii CONTACTLESS CHARGER	Model Name :	Wii07
Temperature :	24 °C	Relative Humidity :	44%
Pressure :	1015.4 hPa	Test Voltage :	AC 230V/50Hz
Test Mode :	charge		

Test Mode	Test Level	Antenna aspect	Duration (s)	Perform Criteria	Results	Judgment
Enclosure	1 A/m	X	60 s	A	A	PASS
Enclosure	1 A/m	Y	60 s	A	A	PASS
Enclosure	1 A/m	Z	60 s	A	A	PASS

Note:

- 1) N/A - denotes test is not applicable in this test report
- 2) Criteria A: There was no change operated with initial operating during the test.
- 3) Criteria B: The EUT function loss during the test, but self-recoverable after the test.
- 4) Criteria C: The system shut down during the test.

5.10 VOLTAGE INTERRUPTION/DIPS TESTING

5.10.1 TEST SPECIFICATION

Basic Standard:	IEC/EN 61000-4-11
Required Performance	B (For >95% Voltage Dips) C (For 30% Voltage Dips) C (For >95% Voltage Interruptions)
Test Duration Time:	Minimum three test events in sequence
Interval between Event:	Minimum ten seconds
Phase Angle:	0°/45°/90°/135°/180°/225°/270°/315°/360°
Test Cycle:	3 times

5.10.2 MEASUREMENT INSTRUMENTS

Item	Kind of Equipment	Manufacturer	Type No.	Serial No.	Calibrated until
1	EMC Immunity Test System	Thermo	EMCPRO PLUS	0502176	Dec, 17, 2008

Remark: " N/A" denotes No Model Name / Serial No. and No Calibration specified.

5.10.3 TEST PROCEDURE

The EUT shall be tested for each selected combination of test levels and duration with a sequence of three dips/interruptions with intervals of 10 s minimum (between each test event). Each representative mode of operation shall be tested. Abrupt changes in supply voltage shall occur at zero crossings of the voltage waveform.

5.10.4 DEVIATION FROM TEST STANDARD

No deviation

5.10.5 TEST SETUP

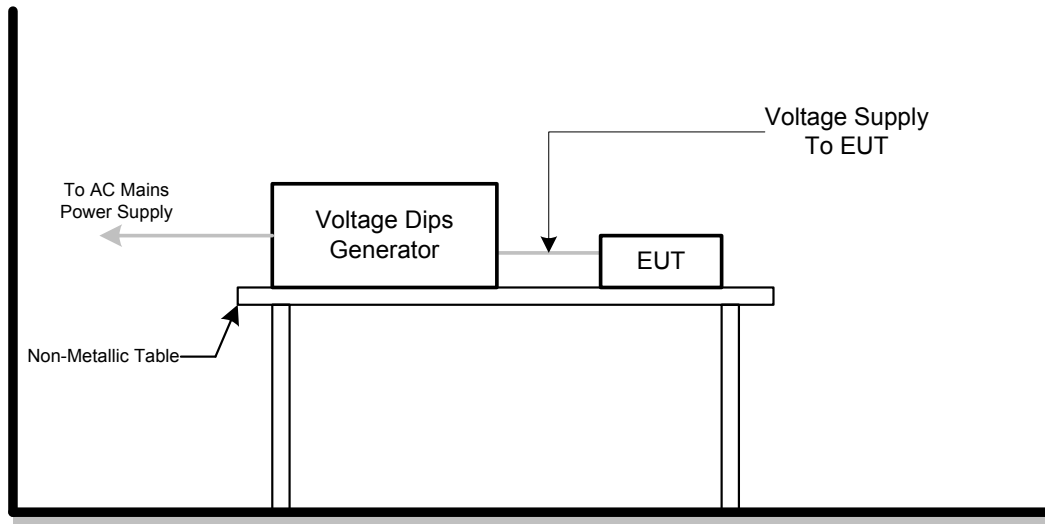

For the actual test configuration, please refer to the related Item –EUT Test Photos.

5.10.6 TEST RESULTS

E.U.T :	Wii CONTACTLESS CHARGER	Model Name :	Wii07
Temperature :	24 °C	Relative Humidity :	44%
Pressure :	1015.4 hPa	Test Voltage :	AC 230V/50Hz
Test Mode :	charge		

AC 230V/50Hz				
Voltage Reduction	Periods	Perform Criteria	Results	Judgment
Voltage dip > 95%	0.5	B	A	PASS
Voltage dip 30%	25	C	A	PASS
Interruption > 95%	250	C	B	PASS

AC 100V/50Hz				
Voltage Reduction	Periods	Perform Criteria	Results	Judgment
Voltage dip > 95%	0.5	B	A	PASS
Voltage dip 30%	25	C	A	PASS
Interruption > 95%	250	C	B	PASS

AC 240V/50Hz				
Voltage Reduction	Periods	Perform Criteria	Results	Judgment
Voltage dip > 95%	0.5	B	A	PASS
Voltage dip 30%	25	C	A	PASS
Interruption > 95%	250	C	B	PASS

Note:

- 1). N/A - denotes test is not applicable in this test report.
- 2) Criteria A: There was no change operated with initial operating during the test.
- 3) Criteria B: The EUT function loss during the test, but self-recoverable after the test.
- 4) Criteria C: The system shut down during the test.

6. EUT TEST PHOTO

Conducted Measurement Photos



Radiated Measurement Photos

