

SPACE SUBSTRATE RESISTANCE EXTRACTION USER'S MANUAL

A.J. van Genderen, N.P. van der Meijs, T. Smedes

Circuits and Systems Group
Department of Electrical Engineering
Delft University of Technology
The Netherlands

Report ET-NS 96-03

Copyright © 1996-2006 by the authors.
All rights reserved.

Last revision: June 22, 2006.

1. Introduction

1.1 Substrate Resistance Extraction

In modern analog circuits and mixed digital/analog circuits, coupling effects via the substrate can be an important cause of malfunctioning of the circuit. This problem becomes more prominent as (1) there is a trend to integrate more and more different components on a chip, (2) the decrease of wire width and increase of wire length causes the interconnect parasitics and hence the level of noise on the chip to increase, and (3) the use of lower supply voltages makes the circuits more sensitive to internal potential variations.

An example of a substrate coupling problem is given below. The figure below shows mixed-signal integrated circuit. The switching in the digital part induces potential spikes on the supply lines. These spikes are then coupled into the substrate, where they propagate to the analogue part of the circuit. There they are picked up, e.g. by the depletion capacitance of a diffused resistor or the bulk contact of a transistor. Thus, the disturbances may appear at the output of the circuit, degrading the performance or even causing malfunctioning of the circuit.

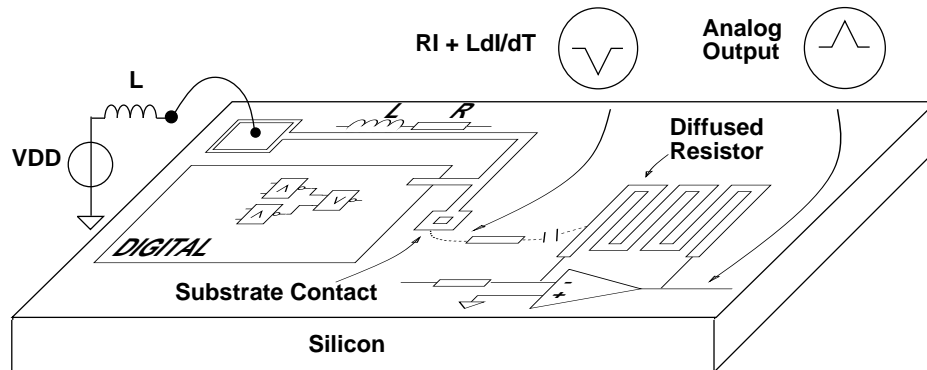

The substrate coupling effects in integrated circuits can be verified by computing the substrate resistances between all circuits parts that inject noise into the substrate and/or that are sensitive to it. The noise injectors are mainly the contacts that connect the substrate and the wells to the supply voltages. The current variations in the supply lines cause fluctuating potentials over their resistances and inductances, that are injected into the substrate via the substrate contacts and the well contacts. Other parts that may generate noise and/or that are sensitive to it are (1) the bulk connections of the transistors, (2) drain/source areas of transistors, (3) on-chip resistors and capacitors, and (4) interconnect wires that are coupled to the substrate via a (large) substrate capacitance.

This document describes how the layout-to-circuit extraction program *space* is used to extract substrate resistances of integrated circuits based upon the mask layout description

of these circuits. The substrate resistances are part of an output circuit together with the other extracted circuit components like transistors and interconnect parasitics. This circuit can then directly be used as input for a circuit simulator like SPICE in order to verify the substrate coupling effects in the circuit.

1.2 Space Characteristics

To compute substrate resistances, *space* uses one of the following methods:

- **Boundary-Element Method**
This is an numerical method that provides accurate results. However, for large circuits, this method requires a relatively large amount of memory and is not very fast. Note that this BEM method also can be combined with a FEM interconnect resistance method. For use of this BEM/FEM method, you must specify wafer configurations in the technology file.
- **Interpolation Method**
This method uses interpolation formulas to compute the substrate resistances. This method is not as accurate as the boundary-element method, but it requires less memory and is much faster. To find the parameters for the interpolation formulas, this method uses the boundary-element method for some (small) standard terminal configuration or it uses measurement results for standard configurations.

Additional, to compute substrate capacitances, *space* uses one of the following methods:

- **Boundary-Element Method** (see above)
- **RC-ratio Method**
The capacitances are found by multiplying the found substrate resistances with a constant factor (parameter "sub_rc_const").

1.3 Documentation

Throughout this document it is assumed that the reader is familiar with the usage of *space* as a basic layout-to-circuit extractor, i.e. extraction of transistors, connectivity and interconnect parasitics. This document only describes the additional information that is necessary to use *space* for substrate resistance extraction. The usage of *space* as a basic layout-to-circuit extractor is described in the following documents:

- **Space User's Manual**
This document describes all basic features of *space*. It is not an introduction to *space* for novice users, those are referred to the *Space Tutorial*.
- **Space Tutorial / Space Tutorial Helios Version**
The space tutorial provides a hands-on introduction to using *space* and the

auxiliary tools in the system that are used in conjunction with *space*. It contains several examples. The *space* tutorial *helios* version provides a similar hands-on introduction, but now from a point of view where the graphical user interface *helios* is used to invoke *space*.

- **Manual Pages**

For *space* as well as for other tools that are used in conjunction with *space*, manual pages are available describing (the usage of) these programs. The manual pages are on-line available, as well as in printed form. The on-line information can be obtained using the *icdman* program.

- **Xspace User's Manual**

This manual describes the usage of *Xspace*, a graphical X Windows based interactive visualization tool of *space*. Note, however, that a more general graphical user interface to *space* is provided by the program *helios*.

Also available:

- **Space 3D Capacitance Extraction User's Manual**

The *space* 3D capacitance extraction user's manual provides information on how *space* can be used to extract accurate 3D capacitances.

1.4 On-line Examples

Two examples are presented in this manual that are also available on-line. We will assume that the *space* software has been installed under the directory `/usr/cacd`. The examples are then found in the directories `/usr/cacd/share/demo/sub3term` and `/usr/cacd/share/demo/suboscil`.

NOTE:

The current version of *space* can only compute substrate resistance for orthogonal substrate terminals.

2. Program Usage

2.1 General

Substrate resistance extraction, using a boundary-element or an interpolation method, can be performed using one of the following versions of *space*: *space3d* (for batch mode extraction) and *Xspace* (for interactive extraction, including mesh visualization). Substrate resistance extraction using an interpolation method can also be performed using the standard version of *space* (for batch mode extraction). All of these programs can also be invoked from the GUI *helios*.

When extracting substrate resistances, *space* will always perform a flat extraction, unless the parameter *allow_hierarchical_subres* is turned on in the parameter file.

2.2 Batch Mode Extraction

In order to use the boundary-element method of *space3d* to compute substrate resistances, use the option **-B** with *space3d*. This method uses default the *makesubres* program to make the mesh and to calculate the "subres" values. When no separate *makesubres* user program exists, then a link to *space3d* is used. When you don't want to call the external *makesubres* program, you can use parameter "sub3d.internal". The above method uses a more consistent mesh, which is independent of other masks that cross the substrate terminal areas. However, when you want to use the old mesh method, use parameter "sub3d.old_mesh".

Additional, substrate capacitances can be extracted. This additional step uses the *makesubcap* program to make the mesh and to calculate the "subcap" values. It cannot be used with "sub3d.internal". To add 3D substrate capacitances, use parameter "add_sub_caps=2". To add fast substrate capacitances, use parameter "add_sub_caps=1" and set the rc-ratio parameter "sub_rc_const" to a suitable value. For example, a ratio of epsilon0 (8.855e-12) can be used. The rc-method can also be used with the interpolation method.

In order to use the interpolation method of *space3d* or *space* to compute substrate resistances, use the option **-b**. This method uses the *makedela* program to make the the delaunay triangulation.

2.3 Interactive Extraction

For substrate resistance extraction it may be helpful to use the *Xspace* visualization program. This program is not more an interactive version of the *space3d* program. But it runs *space3d* in batch mode for each new extraction. It is using a "display.out" file to show the results. The *Xspace* program runs under X Windows and uses a graphical

window to, among other things, show the boundary-element mesh that is generated by the program. Interactively, the user can select the cell that is extracted, the options that are used, and the items that are displayed.

For both methods, to display the substrate terminals, click on "DrawSubTerm" in the "Display" menu, and to display the substrate resistances that are computed, click on "DrawSubResistor" in the "Display" menu. Default, substrate terminals are drawn in their mask color. To draw only the border of substrate terminals, set the parameter "disp.fill_sub_term" to "off".

In order to use the boundary-element method of *Xspace* to compute substrate resistances, turn on "3D sub. res." in the menu "Options". To display also the 3D mesh, turn on "DrawBEMesh" (and turn off "DrawSubTerm") in the menu "Display". Optionally, to view the Greens computation, turn on "DrawGreen". Then, after selecting the name of the cell in the menu "Database", the extraction can be started by clicking on "extract" in the menu "Extract".

To preview only the mesh for substrate resistance computation using a boundary-element method, use *Xspace* as described above and also turn on "BE mesh only".

In order to use the interpolation method of *Xspace* to compute substrate resistances, turn on "inter. sub. res." in the menu "Options". To display the delaunay triangulation that is used to determine which substrate resistances are computed, turn on "DrawDelaunay" in the menu "Display".

3. Technology Description

3.1 Introduction

For substrate resistance extraction, the space element definition file should contain definitions of *substrate terminals*. Substrate terminals are conducting polygons on top of the substrate between which substrate resistances are computed. Currently, the following elements can be used to specify substrate terminals:

- contacts,
- MOS transistors,
- bipolar transistors,
- capacitances.

This is explained in more detail below.

Also the substrate conductivity and substrate resistances for typical terminal configurations are specified in the element definition file. This information is used by respectively the boundary-element method (see Section 4) and the interpolation method (see Section 5) to compute the substrate resistances.

For basic information about the development of an element definition (technology) file, see the Space User's Manual.

3.2 Substrate Terminals

Normally, when no 2D capacitance extraction is done or when a 3D capacitance extraction is done, the program shall also use the substrate terminals of not generated 2D surface capacitances. Set the following parameter "on" to omit the unused ones.

`omit_unused_sub_term` *boolean* (default: off)

Normally, all substrate terminal areas that are adjacent are merged into one substrate terminal. For the boundary-element method, substrate terminal areas that are adjacent are not merged when the terminal areas are defined by different conductor masks (via a contact or capacitance element) and the following parameter is set:

`sep_sub_term` *boolean* (default: off)

Default, each substrate terminal is modeled as an ideally conducting polygon and one node is created for the substrate terminal that is connected to the substrate resistances that are computed as well as to the element(s) that define the substrate terminal. To more accurately model distributed effects, a substrate terminal can however also be modeled by more nodes. This is achieved with the boundary-element method when the terminal areas

are defined by a conductor (via a contact or capacitance element) for which interconnect resistances are extracted, and the following parameter is set

```
sub_term_distr_<mask> boolean (default: off)
```

where <mask> is the name of the corresponding conductor mask. In this case, (1) different adjacent substrate terminal areas that result from the layout fragmentation due to the different mask combinations are not joined, and (2) for each substrate terminal area 4 or 3 nodes (depending on whether the area is a rectangle or triangle) will be created at the corners of the substrate terminal area. The nodes will connect to the nodes of resistance mesh of the conductor that defines the substrate terminal area - either via a contact or via a capacitance (depending on whether the terminal is defined via a contact or capacitance element) - as well as to the substrate resistances that are computed for the substrate terminal area.

3.3 Contacts

A contact in the element definition file specifies a substrate terminal (and hence is a substrate contact) (1) if one of the two masks that are specified with the contact is replaced by the string "@sub" or (2) if one of the two masks is replaced by the notation "%(condition_list)". In the first case, the area of the substrate terminal is defined by the area of the contact. In the second case, the area of the substrate terminal is defined by the condition list between the parentheses. The contact connects the substrate terminal to the other mask that is specified with the contact, possibly via resistances if a contact resistance is specified.

Example:

The following specifies a substrate contact that defines a substrate terminal and that directly connects the substrate terminal (contact resistance is 0) to the first metal layer "cmf".

```
contacts :
  cont_b : cca cmf !cwn !csn : cmf @sub : 0.0 # metal to sub.
```

Alternatively the contact could have been specified as follows.

```
contacts :
  cont_b : cca cmf !cwn !csn : cmf %(cca !cwn !csn) : 0.0
```

3.4 MOS Transistors

A MOS transistor in the element definition file specifies a substrate terminal (1) if the string "@sub" is used for its bulk connection or (2) if the notation "%(condition_list)" is used for its bulk connection. In the first case, the area of the substrate terminal is defined by the area of the transistor gate. In the second case, the area of the substrate terminal is

defined by the condition list between the parentheses. When the second case is used, the area specified by the condition list must have an overlap with the transistor gate area. The bulk connection of the transistor is then connected to the substrate terminal.

Example:

The following specifies a transistor that has as a bulk connection a substrate terminal. The area of substrate terminal is equal to the area of the transistor gate.

```
fets :
    nenh : cpg caa csn : cpg caa : @sub # nenh MOS
```

In the following example the area of the substrate terminal includes the transistor gate as well as the drain/source areas.

```
fets :
    nenh : cpg caa csn : cpg caa : %(caa csn) # nenh MOS
```

3.5 Bipolar Transistors

A bipolar transistor in the element definition file specifies a substrate terminal if the notation "*%(condition_list)*" is used for its bulk connection. The area of the substrate terminal is defined by the condition list between the parentheses. The area specified by the condition list must have an overlap with the transistor area. The bulk connection of the transistor is then connected to the substrate terminal.

Example:

The following specifies a bipolar transistor that has as a bulk connection a substrate terminal.

```
bjts :
    npnBW : bw wn : ver : wn bw epi : %(bw wn) # ver. NPN
```

3.6 Capacitances

A capacitance in the element definition file specifies a substrate terminal (1) if the string "@sub" is used for one of the terminal masks of the capacitance or (2) if the notation "*%(condition_list)*" is used for one of the masks. For case (1): If the capacitance is a surface capacitance, the area of the substrate terminal is defined by the area of the capacitance. The corresponding terminal of the capacitance is then connected to the substrate terminal. If the capacitance is an edge capacitance, the edge capacitance must be adjacent to a substrate terminal that is defined by another element (e.g. surface capacitance) and the corresponding terminal of the capacitance is then connected this substrate terminal. For case (2): The area of the substrate terminal is defined by the condition list between the parentheses. The area of the substrate terminal must then coincide or overlap the area of the capacitance. When substrate resistances are extracted and when no substrate terminal is recognized underneath the capacitance to substrate, the

capacitance for that part of the layout is ignored.

A capacitance that defines a substrate terminal can be either a normal (linear) capacitance or a junction capacitance.

Example:

The following specifies bottom and side-wall capacitances to the substrate of a diffusion area. They are modeled on top of the substrate (i.e. the thickness of the diffusion area is not taken into account when the substrate resistances are computed).

```
junction capacitances ndif :
    acap_na:  caa      !cpg  csn  !cwn  :  caa  @sub: 100e-6
    ecap_na:  !caa -caa  !-cpg -csn  !-cwn : -caa @sub: 300e-12
```

NOTE:

Be careful not to specify too many capacitances as capacitances with a substrate terminal. This may result in (a large number of) large substrate terminals.

NOTE:

Although well-substrate capacitances can also be modeled using the above method, this should be done carefully since the wells may define large substrate terminals (equipotential areas) on top of the substrate. The resistive coupling between the elements within a well can best be modeled by defining the well as a conductor.

Capacitances are not used as substrate terminals during substrate resistance extraction if the string (pin) "@gnd" is used instead of the string "@sub" or instead of the "%(condition_list)" notation.

3.7 Substrate Conductivity

Syntax:

```
sublayers :
    name conductivity top
    .
    .
```

Specifies the conductivity of the substrate. This information is used by the boundary-element method to compute the resistances between the substrate terminals (see Section 4). It is specified in the element definition file after the specification of the capacitances and the specification of the information that is used for 3D capacitance extraction.

In the current release, the maximum number of different substrate layers can be more than 2, when the "unigreen" method is used. For each layer, *name* is an arbitrary label that will be used for error messages etc, *conductivity* is a real number giving the conductivity of that layer in Siemens/meter, and *top* specifies (in microns) the top of the

substrate layer. The positive z direction is out of the substrate. Therefore, the value of top must be ≤ 0 . The layers are enumerated starting from the top. For the first substrate layer, top must be zero. However, for a technology file with wafer configurations for the BEM/FEM method, the first top must be equal to the specified bem_depth . If a second substrate layer is present, the bottom of the first layer is at the top of the second layer. The bottom of the last substrate layer is at minus infinity.

Example:

```
sublayers :
# name      conductivity  top
  epi        6.7          0.0
  substrate  2.0e3          -7.0
```

Note that in this release it is possible to specify a conducting back side (grounded substrate). This can be specified with a special last (2nd or 3th) sublayer with the name "metalization". A finite substrate thickness is specified with the top value. Note that the conductivity value of this entry is not used, but must hold a dummy value. However, a conductivity value for the medium above the substrate is derived from the first sublayer. This first value is default divided by 100. Another divisor can be specified with parameter "sub3d.neumann_simulation_ratio". Note, for the "unigreen" method, this parameter can be specified in the technology file (see example below).

Example:

```
sublayers :
# name      conductivity  top
  epi        6.7          0.0
  substrate  2.0e3          -7.0
  metalization dummy_value -20.0
  neumann_simulation_ratio : 1000
```

3.8 Substrate Permittivity

Syntax:

```
subcaplayers :
  name permittivity top
  .
  .
```

Specifies the relative permittivity of the substrate. This information is used by the boundary-element method to compute the capacitances between the substrate terminals (see Section 4). It is specified in the element definition file after the specification of the "sublayers" part. The top must be specified like in the "sublayers" part. In the current release, the maximum number of different subcaplayers is 2.

3.9 Typical Substrate Resistances

The interpolation method uses typical substrate resistances for standard terminal configurations to compute the substrate resistances (see Section 5). This information is specified in the element definition file, after the (possible) specification of the substrate conductivity. It consists of a list of so-called "selfsubres" entries and a list of so-called "coupsubres" entries.

```
selfsubres :
  area perimeter resistance rest
  .
  .
```

This is a list that specifies for different substrate terminals the resistance between that substrate terminal and the substrate node (see Section 5). Each entry consists of a specification of (1) *area*: the area of a substrate terminal (in square microns), (2) *perimeter*: its perimeter (in microns), (3) *resistance*: its resistance to the substrate node, and (4) *rest*: the part of the *conductance* to the substrate node (= 1/resistance to the substrate node) that is a lower bound for the conductance to the substrate node (i.e. if the conductance to the substrate node is decreased because direct coupling resistances are connected to the substrate terminal - see below - the conductance can not decrease below this value). To optimize the interpolation method, the entries should preferably be organized in groups of 3, where each second entry has an area equal to the area of the first entry and each third entry has a perimeter equal to the perimeter of the first entry (see the example below).

```
coupsubres :
  area1 area2 distance resistance decrease
  .
  .
```

This is a list that specifies for different pairs of substrate terminals the direct coupling resistance between these terminals. Each list entry consists of a specification of (1) *area1*: the area of a terminal, (2) *area2*: the area of another terminal, (3) *distance*: the minimum distance between these terminals, (4) *resistance*: the corresponding direct coupling resistance, and (5) *decrease*: the part of the direct coupling *conductance* (= 1/direct coupling resistance) that is, for each of the substrate terminals the direct coupling resistance is connected to, subtracted from the conductance to the substrate node.

Note that areas need to be specified in square microns and distances in microns.

Example:

```
selfsubres:
# resistances to substrate node
#   area   perim      r   rest
    0.48    3.2   88205.1  0.01
    0.64    3.2   81286.8  0.01
    0.64    4.0   73678.4  0.01
    1.92    6.4   44102.5  0.01
    2.56    6.4   40643.4  0.01
    2.56    8.0   36839.2  0.01
    7.68   12.8   22051.2  0.01
   10.24   12.8   20321.7  0.01
   10.24   16.0   18419.9  0.01

coupsubres:
# direct coupling resistances
#  area1   area2   dist      r   decr
    0.64    0.64    1.6   648598  0.873512
    0.64    0.64    3.2  1101504  0.925946
    0.64    0.64    6.4  1996617  0.959256
    0.64    0.64   25.6  7341756  0.988935
    2.56    2.56    3.2   324299  0.873515
    2.56    2.56    6.4   550752  0.925953
    2.56    2.56   12.8   998308  0.959253
    2.56    2.56   51.2  3670877  0.988967
```

NOTE:

The above parameters, for the interpolation method, can automatically be generated with tool *subresgen* (see "icdman subresgen").

4. The Boundary-Element Method

4.1 Introduction

The boundary-element method (BEM) allows to compute accurate substrate resistance values for a (not too large) number of substrate terminals on top of a substrate. The substrate is described by specifying the conductivity of the different substrate layers (see Section 3.7). Currently, at most two different substrate layers can be described. The thickness of the substrate is considered infinite. By default, the substrate is considered to have infinite dimensions in the horizontal direction. Optionally, also substrate edges (saw-lanes) can be taken into account.

Since there are several degrees of freedom with the boundary-element method to compute substrate resistances such as size of elements, type of shape function, etc., there are also several parameters that can be set with *space* when using the boundary-element method. A brief description of these parameters is given below. For more background information on the boundary-element method to compute substrate resistances, see [1, 2].

Besides the substrate conductivity that is specified in the space element definition file, all parameters for the boundary-element method are specified in the space parameter file (see also the Space User's Manual).

In the parameter file, lengths and distances are specified in microns and areas are specified in square microns.

All parameters that have a name starting with "sub3d." may be used without this prefix if they are included between the lines "BEGIN sub3d" and "END sub3d". E.g.

```
BEGIN sub3d
saw_dist    5
edge_dist  14
END sub3d
```

is equivalent to

```
sub3d.saw_dist    5
sub3d.edge_dist  14
```

Note that the BEM parameters for substrate capacitance calculation are default equal to the "sub3d.xxx" parameters. To specify different values, use the prefix "**subcap3d.**". However, this is not allowed for parameter "sub3d.be_window".

4.2 Substrate Edge Effects

Note that edge effects can only taken into account when using the collocation method (see parameter "sub3d.be_mode"). And only when parameter "use_multipoles" is turned "off". To use edge effects, the value of parameter "sub3d.edge_dist" must be larger than

the value of parameter "sub3d.saw_dist".

sub3d.saw_dist *distance* (default: infinity)

This parameter specifies the edge of the substrate (saw-lane). When a bounding box is assumed around the layout of the set of substrate terminals, the edge of the substrate is defined as the rectangle that extends the bounding box sub3d.saw_dist microns.

sub3d.edge_dist *distance* (default: 0)

Specifies the maximum distance to the saw-lane for an element in the layout to be influenced by the saw-lane. (Non-negative real value in microns.) For elements that are more than sub3d.edge_dist micron away from the saw-line, no edge effects are taken into account. Edge effects can generally be neglected for elements that are further away from the saw-lane than 2 times the epi-thickness.

4.3 Mesh Construction

sub3d.max_be_area *area* (no default)

This parameter specifies (in square microns) the maximum area of boundary elements that are interior elements (i.e. elements that are not along the edges of the substrate terminals). This parameter has no default and must therefore always be specified when performing 3D substrate resistance extraction.

sub3d.edge_be_ratio *float* (default: 1)

This parameter specifies the ratio between the maximum size of edge elements and the maximum size of interior elements (edge elements are elements that are along the edges of the substrate terminals, interior elements are the other elements, see also the parameter sub3d.max_be_area). To efficiently compute accurate substrate resistances it is recommended to use smaller elements near the edges of the substrate terminals. This is achieved by using for sub3d.edge_be_ratio a value smaller than 1. Because the mesh refinement is done incrementally, the size of the elements will gradually decrease towards the edges of the substrate terminals. This is also influenced by the parameter sub3d.edge_be_split.

sub3d.edge_be_split *float* (default: 0.5)

If, during mesh refinement, a quadrilateral edge element is split into two elements (see also the description of the parameter sub3d.edge_be_ratio), this parameter specifies the ratio between the size of the element that becomes an edge element and the size of the element that becomes an interior element.

sub3d.edge_be_split_lw *float* (default: 4)

During mesh refinement, this parameter is used to determine the split direction of a quadrilateral element. Interior elements are always split perpendicular to their longest

side. If the ratio between the longest side and the shortest side of an edge element does not become larger than `sub3d.edge_be_split_lw`, an edge element is split in a direction parallel to the edge direction. Otherwise, the edge element is split perpendicular to its longest side. The minimum value for `sub3d.edge_be_split_lw` is 2.

`sub3d.be_shape` *number* (default: 1)

Enforces a particular shape of the boundary element faces. Value 1 means no enforcement. Value 3 means triangular faces (is always used in "piecewise linear" mode). Value 4 means quadrilateral faces (is the default for constant shape functions; see below).

4.4 Shape and Weight Functions

`sub3d.be_mode` *mode* (default: 0c)

Specifies the type of shape functions and the type of weight functions that are used.

mode	shape function	weight method
0c	piecewise constant	collocation
0g	piecewise constant	Galerkin
1c	piecewise linear	collocation
1g	piecewise linear	Galerkin

In general, it is recommended not to use mode 1c due to its poor numerical behavior. Further, given a certain accuracy, the Galerkin method, as compared to the collocation method, allows to use larger elements. Note that the Galerkin method is more accurate than the collocation method, but it also requires more computation time.

`sub3d.mp_min_dist` *distance_ratio* (default: 2.0)

When the current- and observation-elements are not too close together, the influence matrix element linking them can be calculated much faster (2 to 20 times) using a multipole expansion than by numerical integration. This parameter specifies a threshold value of the ratio between the current-observation distance and the convergence radius of the multipole expansion: for larger distances the multipole expansion is used, for smaller distances numerical integration. Usually, a ratio of 1.5 is satisfactory. When setting the parameter to infinity, *all* influence matrix elements are calculated by numerical integration.

`sub3d.mp_max_order` *0 ... 3* (default: 2)

Specifies the highest multipole to be included in the multipole-expansion. For 0 only the monopole is included, for 1 also the dipole, and so forth. The highest implemented value is 3 (octopole), because on the one hand this typically suffices for a precision of one per mil, while on the other hand the required CPU time increases drastically with the number

of multipoles.

`use_multipoles` *boolean* (default: on)

With this parameter, you can turn "off" the multipole expansion.

4.5 Accuracy of Elastance Matrix

`sub3d.green_eps` *error* (default: 0.001)

Positive real value specifying the relative accuracy for evaluating the entries in the elastance matrix.

`sub3d.max_green_terms` *number* (default: 500)

For substrates consisting of more than one layer, more than one term (iteration) will in general be necessary to find an approximation of the Green's function such that the error in the entries in the elastance matrix is within `sub3d.green_eps` (see above). This parameter specifies the value for the maximum number of terms that may be used. The upper bound of this parameter is 500.

4.6 Window Size

`sub3d.be_window` *w* [*wy*]

Specifies the size (in micron) of the influence window. All influences between elements that are, in the horizontal direction, within a distance w will be taken into account, and all influences between elements that are more than a distance $2w$ apart will not be taken into account. If only one value is given, this value specifies the size of the window in the layout x direction and the layout y direction. If two values are given, the first value specifies the size of the window in the x direction and the second value specifies the size of the window in the y direction.

The extraction time is proportional to $O(Nw^4)$, where N is the number of elements. The memory usage of the program is $O(w^4)$. No default.

NOTE:

It is recommended not to use small window sizes for configurations consisting of a thin good conducting top substrate layer and a poorly conducting bottom substrate layer. This is because of the relatively large error that may occur.

4.7 Example Parameter File

An example of parameter settings for 3D substrate resistance extraction is as follows:

```
BEGIN sub3d
be_mode          0g    # piecewise constant galerkin
max_be_area      1.0   # microns^2
edge_be_ratio    0.05
edge_be_split    0.2
be_window        inf   # infinity
END sub3d
```

4.8 Example of 3 Substrate Terminals

The following example consists of three substrate terminals on top of a two layered substrate. To run the example, first create a project, e.g. with name "sub3term", for a "scmos_n" process with lambda equal to 0.1 micron.

```
% mkpr -l 0.1 sub3term
available processes:
process id      process name
      1         nmos
      3         scmos_n
      ...
select process id (1 - 60): 3
mkpr: -- project created --
%
```

Next, go to the project directory and copy the example source files from the directory `/usr/cacd/share/demo/sub3term` (it is supposed that demo directory has been installed under `/usr/cacd`).

```
% cd sub3term
% cp /usr/cacd/share/demo/sub3term/* .
```

The layout description is put into the database using the program `cgi`.

```
% cgi sub3term.gds
```

A top-view of the configuration is shown below (use e.g. the layout editor *dali* to inspect the layout). Coordinates are in lambda.

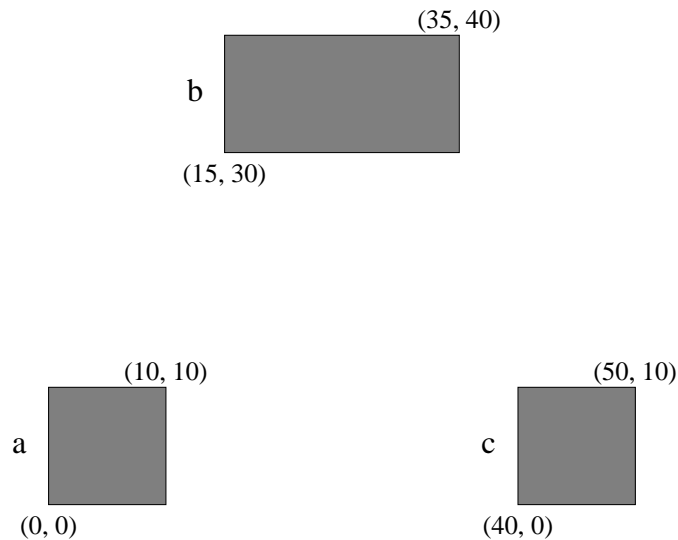

An appropriate element definition file (with name "elem.s") is as follows:

```
% cat elem.s
#
# space element definition file for metal substrate terminals
#

colors :
  cmf    blue
  @sub   pink

conductors :
# name      : condition : mask : resistivity : type
  cond_cmf  : cmf       : cmf  : 0.0         : m

contacts :
# name      : condition : lay1 lay2 : resistivity
  cont_cmf  : cmf       : cmf @sub : 0.0

sublayers :
# name      conductivity top
  epi       6.7         0.0
  substrate 2.0e3         -7.0

#EOF
%
```

To use this file with *space3d*, it has to be compiled into a file "elem.t" using *tecc*.

```
% tecc elem.s
```

The following parameter file is used for this example:

```
% cat param.p
BEGIN sub3d
be_mode          0c    # piecewise constant collocation
max_be_area      1.0   # max. size of interior elements in sq. microns
edge_be_ratio    0.05  # max. size edge elem. / max size inter. elem.
edge_be_split    0.2   # split fraction for edge elements
be_window        inf   # infinite window, all resistances
END sub3d

disp.save_prepass_image on
%
```

Then *space3d* is used in combination with the option **-B** for 3D substrate resistance extraction, as follows:

```
% space3d -v -E elem.t -P param.p -B sub3term
```

The circuit that has been extracted is retrieved in SPICE format as follows:

```
% xspice -a sub3term

sub3term

* Generated by: xspice 2.39 25-Jan-2006
* Date: 22-Jun-06 10:02:05 GMT
* Path: /users/space/sub3term
* Language: SPICE

* circuit sub3term c b a
r1 c a 1.265872meg
r2 c b 679.1891k
r3 c SUBSTR 75.86724k
r4 a b 679.1891k
r5 a SUBSTR 75.86724k
r6 b SUBSTR 49.44378k
* end sub3term

%
```

Alternatively *Xspace* can be used for extraction.

```
% Xspace -E elem.t -P param.p
```

Click button "sub3term" in the menu "Database", click button "3D sub. res." in the menu "Options", click button "DrawBEMesh" and "DrawGreen" in the menu "Display", and click "extract" in the menu "Extract" or use hotkey "e". Note, to leave the *Xspace* program, use hotkey "q". This will yield the following picture:

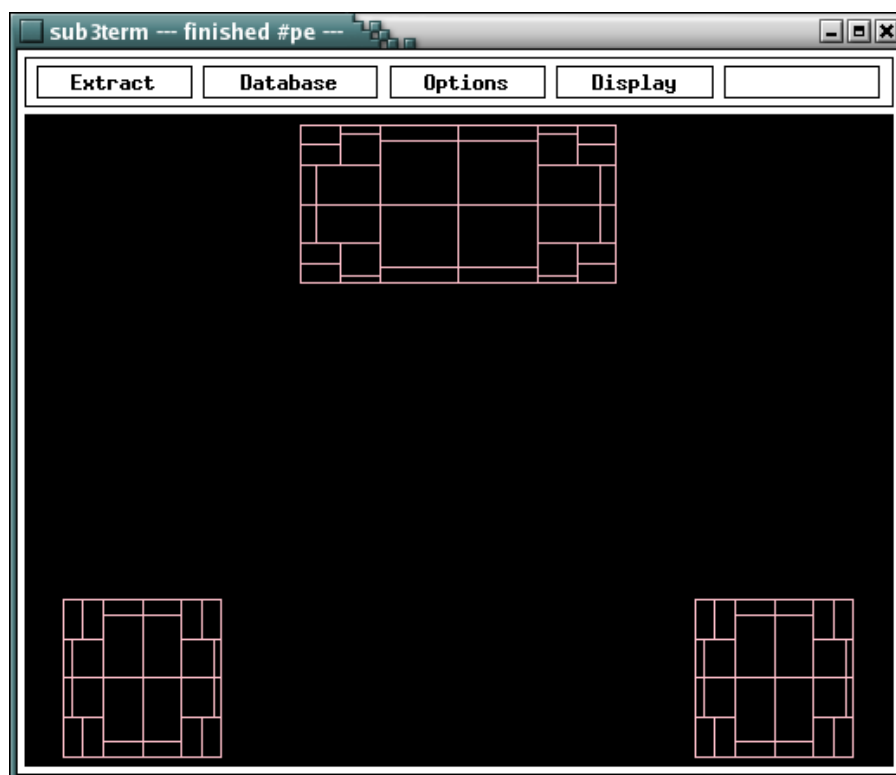

4.9 Run-time Versus Accuracy

The runtime of the program is largely dependent on the values of the parameters that are used. For example, if `sub3d.max_be_area` is decreased (smaller elements are used), the accuracy will increase but also the number of elements will increase and the computation time will become larger. The larger the size of the window, the more accurate results are obtained but also longer extraction times will occur. The Galerkin method is more accurate than the collocation method, but it also requires more computation time.

Also, substrate resistance computation for configurations consisting of 2 substrate layers may require much more computation time than the same computation for configurations consisting of 1 substrate layer. This is because the computation of the Green's functions requires much more time. In this case, the computation time can be decreased (on the penalty of some loss in accuracy) by increasing the value for the maximum error for the evaluation of the entries in the elastance matrix (`green_eps`).

4.10 Solving Problems

When the ratio between the conductivities of two different substrate layers is large, it is possible that the following warning may occur:

```
<prg>: Computation of Greens function truncated after 6 green_terms,  
      error specified by green_eps not reached (layers are 'epi' and 'epi').  
<prg>: Warning: maximum error not reached for 3.0% of the Greens functions.
```

Note that <prg> can be "space3d", "Xspace" or "makesubres".

In addition, some direct coupling resistances between substrate contacts may have a negative value. This problem occurs because the computation of the Green's function for the layered substrate with a large difference between the conductivities requires a lot of terms (iterations), and a sufficient accuracy is not obtained after the maximum number of terms has been reached (see Section 4.5). In the above case "sub3d.max_green_terms" (default 500) is not reached, because the Greens function computation is truncated after 6 green_terms. This happens when "sub3d.green_eps" divergence occurs. Set parameter "debug.print_green_terms" for more details. If you set parameter "min_divergence_term" (note: without leading "sub3d.") to a higher value (i.e. 20), then the program stops not more so often. The last warning is changed into:

```
<prg>: Warning: maximum error not reached for 0.1% of the Greens functions.
```

There are two cases that should be considered when trying to find a solution for this problem:

First the case when the conductivity of the top layer is much larger than the conductivity of the bottom layer. In this case, when the top layer is thin, a solution may be to model only the top layer as a resistive conductor and use interconnect resistance extraction only. When the top layer is thick, reasonably accurate results may be obtained by modeling the substrate by only the top layer (with infinite thickness) and omitting the bottom layer.

Second the case when the conductivity of the top layer is much smaller than the conductivity of the bottom layer. In this case a solution is often given by the fact that the resistances between the substrate contacts and the substrate node SUBSTR are accurately computed though and the (negative) coupling resistances can simply be removed from the output. Whether or not this is valid can be verified by changing the conductivity of the bottom layer. When the resistances to the SUBSTR node do not change very much, and when the absolute values of the coupling resistances remain much larger than those of the resistances to the SUBSTR node, the method is valid.

Other possible useful "debug" parameters are:

```
debug.print_cap3d_init    (default: off)  
debug.print_green_init    (default: off)  
debug.print_green_gterms  (default: off)
```

4.11 The BEM/FEM Method

By the BEM/FEM method the top of the substrate is modeled with wafer configurations. The top of the substrate is calculated by *space3d* with the interconnect resistance Finite Element Mesh calculation method, because the wafer configurations describe a sheet and contact resistor network. However, an interconnect resistance extraction option needs not to be specified. The *space3d* extractor is using the BEM/FEM method, when wafer configurations are specified. Note that the wafer configurations describe the whole cell area. Thus, the whole cell is divided in substrate terminal area's. These area's are all distributed and these area's are not merged. Also a "bem_depth" (in microns) must be specified in the technology file. On this depth the BEM substrate area is starting. Thus, the "sublayers" section must also be changed to begin on the bem_depth. Note that the total thickness of a wafer configuration must be equal to the "bem_depth", else no contact to BEM substrate can be made. Note that first contact defines the restype of the BEM substrate. For example the following wafer configurations can be specified in the technology file:

```
new : !cwn !csn : config1
new : !cwn csn : config2
new : cwn      : config3

set bem_depth 6.0 # micron

# conductivity --+ +---- thickness (microns)
#              (S/m) | | +---- nr_of_layers (≥ 1)
#              | | |
#              V V V : options ...
wafer : config1 : 1000 6.0 2 : restype=p # w1_1, w1_2
wafer : config2 : 10 1.0 2 : restype=p # w2_1, w2_2
wafer : config2 : 1000 5.0 2 : restype=p # w3_1, w3_2
wafer : config3 : 1000 6.0 2 : restype=n subconn=off # w4_1, w4_2
```

The following figure gives an explanation.

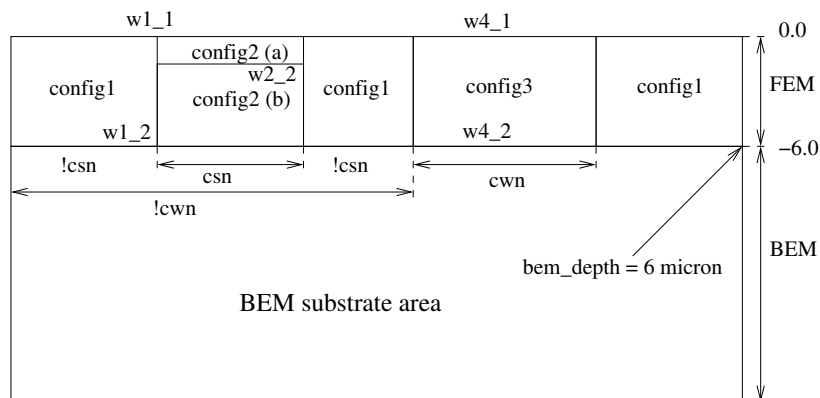

The technology compiler generates new conductors in the technology file for the wafer configurations. There are also new masks added for these conductors, but only when needed. For example, for conductor "w2_1" can the conductor number of conductor "w1_1" be used, because it is on the same height and has the same restype. Beside conductors *tecc* adds also new contact and substrate contact elements to the technology file.

4.11.1 FEM layer_sheet_res formula

```
layer_thickness = thickness / (nr_of_layers - 1)
layer_sheet_res = (1 / conductivity) / (layer_thickness * 1e-6)
```

Note that the *layer_sheet_res* of the 1st and last layer is $2 * \text{layer_sheet_res}$. Of course, the conductivity value must be greater than zero.

4.11.2 FEM layer_contact_res formula

```
layer_contact_res = (1 / conductivity) * (layer_thickness * 1e-6)
```

4.11.3 FEM nr_of_layers=1 special case

```
layer_thickness = thickness
layer_contact_res = 0
```

4.11.4 FEM viamask=mask option

Example:

```
new : cca : rbc
resize : rbc : rbc : 0.25e-6
wafer : config2 : 10 1.0 2 : viamask=rbc
```

Only on place of the viamask exists the *layer_contact_res*, else the *layer_contact_res*=0. The standard contact mask (in this case "cca") must be resized to let it work. The "rbc" mask is a new (real) mask, which is used as viamask. Because both masks exist, the tile splitting gives the following result:

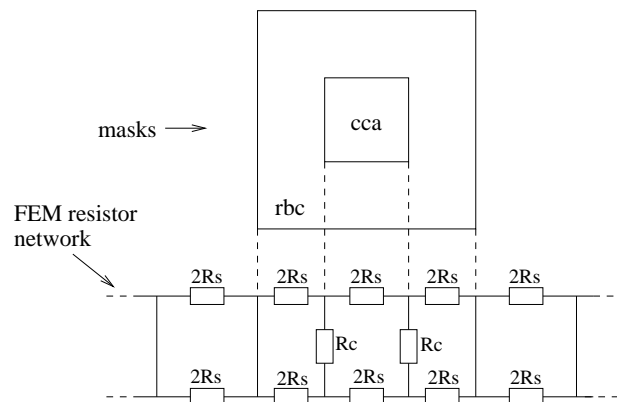

5. The Interpolation Method

5.1 Introduction

The interpolation method can quickly compute substrate resistances for large circuits. The method is illustrated by the following figure which shows a configuration of two square terminals on top of a substrate.

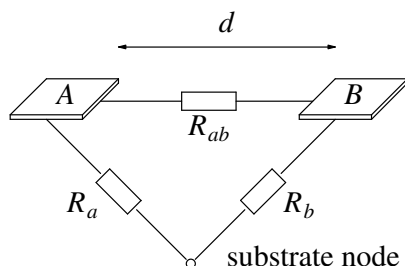

The interpolation method uses the notion of a (virtual) substrate node (default name "SUBSTR") to which all substrate terminals are directly connected via resistance (see the above figure: resistance R_a and resistance R_b connect respectively terminal A and terminal B to the substrate node). Direct coupling resistances between substrate terminals are only computed between terminals that are “neighbors” of each other (resistance R_{ab} for terminal pair A-B). The values of the resistance are computed using interpolation formulas based on area and perimeter information and based on the distances between the terminals.

5.2 Network Structure

Direct coupling resistances between substrate terminals are only computed between terminals that are “neighbors” of each other. Whether or not two terminals are neighbors is determined from a Delaunay triangulation in which the corners of the substrate terminals are the nodes of the Delaunay triangulation [3]. An example of a Delaunay triangulation for a set of substrate terminals is shown in the figure below at the left (terminals are grey).

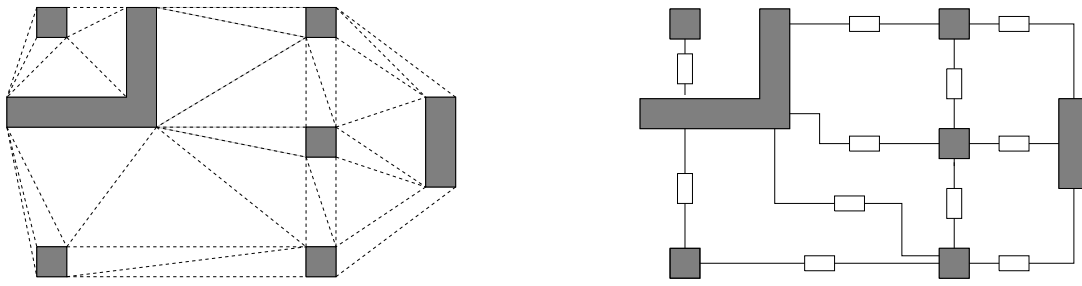

A property of the Delaunay triangulation is that it is a planar graph that connects nodes that are "neighbors" of each other. Therefore, the interpolation method computes a direct coupling resistance between two terminals if, and only if, the terminals are connected by at least one edge of the Delaunay triangulation. As a result, for the figure above at the left, direct coupling resistances are computed as shown in the figure above at the right. Recall that the terminals are also coupled to each other via the substrate node.

5.3 Resistance Computation

The resistance between a terminal A and the virtual substrate node is computed from the following formula

$$R_a = \frac{1}{G_a} = \frac{1}{L P_a^m A_a^n}$$

where P_a is the perimeter of terminal A , A_a is the area of terminal A , and L , n and m are empirical fitting parameters.

The direct coupling resistance between a terminal A and a terminal B is computed from the formula

$$R_{ab} = \frac{K d^p}{\sqrt{A_a} + \sqrt{A_b}}$$

where A_a and A_b are the areas of the terminals, d is the minimum distance between the terminals and p and K are empirical fitting parameters.

When the distance between two terminals is decreased, a part of the current between the terminals that normally flows via the substrate node will flow via the direct coupling resistance. This is modeled by subtracting a fraction of the total direct coupling conductance that is connected to a terminal from the conductance between that terminal and the substrate node.

The fitting parameters L , m , n , p and K are automatically computed by *space* from the resistance values for some typical substrate terminal configurations (see Section 3.9). These values are obtained via measurement on the chip, or by using the boundary-element method that is described in Section 4.

5.4 Determining the Parameters

The parameters for the interpolation method in the element definition file (see Section 3.9) must be determined from results for some standard terminal configurations, that are obtained using some other method. Usually this method will be the boundary-element method that can be applied by *space* (see Section 4), but also other programs can be used for this, or results from measurements on the chip can be used.

The application of the boundary-element method of *space* to find the parameters for the interpolation method, is done using the tool *subresgen* (see "icdman subresgen"). This tool automatically generates the parameters from a description of the substrate layers in a *space* element definition file. However, for completeness, it is described below how the parameters can be computed using another method.

5.4.1 Computation of *selfsubres* entries

For different terminal sizes do the following:

- For a single terminal with area A and perimeter P , compute its substrate resistance R_{sub1} to the virtual substrate node (default this node is called SUBSTR in *space*).
- Take the above single terminal and put a sufficiently wide substrate ring terminal around it at a short distance (e.g. as close as different substrate terminals can be). The substrate resistance to the virtual substrate node is now R_{sub2} .

The parameters for a line in the *selfsubres* list are then:

$$A \quad P \quad R_{sub1} \quad (1/R_{sub2})/(1/R_{sub1})$$

5.4.2 Computation of *coupsubres* entries

For different terminal sizes and different distances do the the following:

- For a single terminal with area A and perimeter P , compute its substrate resistance R_{sub1} to the virtual substrate node (this part is similar to the first part that is described above).
- For two of the above terminals at a distance D , compute the substrate resistance R_{sub3} to the virtual substrate node for each terminal, and the direct coupling substrate R_{coup} between them.

The parameters for a line in the *selfsubres* list are then:

$$A \quad A \quad D \quad R_{coup} \quad (1/R_{sub1} - 1/R_{sub3})/(1/R_{coup})$$

5.5 Example of CMOS Ring Oscillator

The following example consists of a CMOS ring oscillator. To run the example, first create a project, e.g. with name "suboscil", for a "scmos_n" process with lambda is 0.1 μ .

```

% mkpr -l 0.1 suboscil
available processes:
process id      process name
      1         nmos
      3         scmos_n
      ...
select process id (1 - 60): 3
mkpr: -- project created --
%

```

Next, go to the project directory and copy the example source files from the directory `/usr/cacd/share/demo/suboscil` (supposing a `/usr/cacd` installation).

```

% cd suboscil
% cp /usr/cacd/share/demo/suboscil/* .

```

The layout description is put into the database using the program `cgi`.

```

% cgi oscil.gds

```

Use the layout editor `dali` to view the layout:

```

% dali oscil

```

To view also the sub-cells, use the mouse, click on "DB_menu", then on "all_exp" and then on "maximum". To leave the program, click on "-return-" and "-quit-".

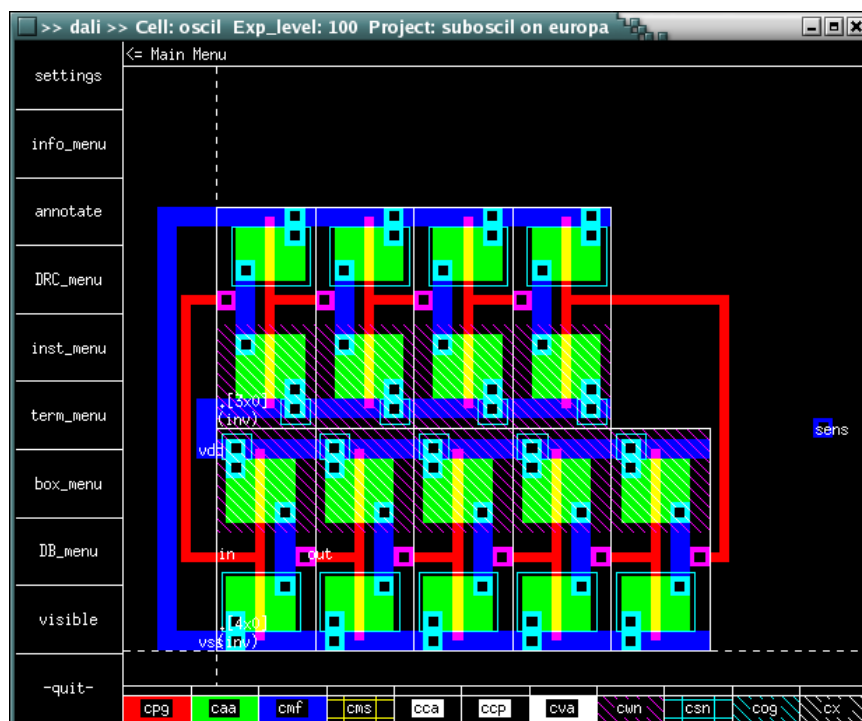

The source of the used `space` default process technology file is as follows:

```

% cat /usr/cacd/share/lib/process/scmos_n/space.def.s
# rcsid = "... space.def.s,v 1.6 2006/01/09 11:40:30 ..."
#
# space element definition file for scmos_n example process
# with transistor bulk connections and substrate terminals
# for substrate contacts and nmos bulk connections, and
# with information for 3D capacitance extraction and
# substrate resistance extraction.
#
# masks:
# cpg - polysilicon interconnect          ccp - contact metal to poly
# caa - active area                       cva - contact metal to metal2
# cmf - metal interconnect                cwn - n-well
# cms - metal2 interconnect              csn - n-channel implant
# cca - contact metal to diffusion        cog - contact to bondpads
#
# See also: maskdata

unit resistance      1      # ohm
unit c_resistance   1e-12 # ohm um^2
unit a_capacitance 1e-6   # aF/um^2
unit e_capacitance 1e-12 # aF/um
unit capacitance   1e-15 # fF
unit vdimension    1e-6   # um
unit shape         1e-6   # um

maxkeys 13

colors :
  cpg  red
  caa  green
  cmf  blue
  cms  gold
  cca  black
  ccp  black
  cva  black
  cwn  glass
  csn  glass
  cog  glass
  @sub pink

conductors :
# name : condition      : mask : resistivity : type
  cond_mf : cmf          : cmf  : 0.045       : m   # first metal
  cond_ms : cms          : cms  : 0.030       : m   # second metal
  cond_pg : cpg          : cpg  : 40          : m   # poly interconnect
  cond_pa : caa !cpg !csn : caa  : 70          : p   # p+ active area
  cond_na : caa !cpg  csn : caa  : 50          : n   # n+ active area
  cond_well : cwn        : cwn  : 0           : n   # n well

fets :
# name : condition      : gate d/s : bulk
  nenh : cpg caa  csn : cpg  caa : @sub # nenh MOS
  penh : cpg caa !csn : cpg  caa : cwn  # penh MOS

```

```

contacts :
# name      : condition          : lay1 lay2 : resistivity
cont_s      : cva cmf cms          : cmf cms   : 1    # metal to metal2
cont_p      : ccp cmf cpg          : cmf cpg   : 100  # metal to poly
cont_a      : cca cmf caa !cpg cwn !csn
              | cca cmf caa !cpg !cwn csn
              : cmf caa   : 100  # metal to active area
cont_w      : cca cmf cwn csn      : cmf cwn   : 80  # metal to well
cont_b      : cca cmf !cwn !csn   : cmf @sub  : 80  # metal to subs

junction capacitances ndif :
# name      : condition          : mask1 mask2 : capacitivity
acap_na     : caa          !cpg csn !cwn : caa @gnd : 100 # n+ bottom
ecap_na     : !caa -caa !-cpg -csn !-cwn : -caa @gnd : 300 # n+ sidewall

junction capacitances nwell :
acap_cw     : cwn          : cwn @gnd : 100 # bottom
ecap_cw     : !cwn -cwn      : -cwn @gnd : 800 # sidewall

junction capacitances pdif :
acap_pa     : caa          !cpg !csn cwn : caa cwn : 500 # p+ bottom
ecap_pa     : !caa -caa !-cpg !-csn cwn -cwn : -caa cwn : 600 # p+ sidewall

capacitances :
# polysilicon capacitances
acap_cpg_sub : cpg          !caa !cwn : cpg @gnd : 49
acap_cpg_cwn : cpg          !caa cwn : cpg cwn : 49
ecap_cpg_sub : !cpg -cpg !cmf !cms !caa !cwn : -cpg @gnd : 52
ecap_cpg_cwn : !cpg -cpg !cmf !cms !caa cwn : -cpg cwn : 52

# first metal capacitances
acap_cmf_sub : cmf          !cpg !caa !cwn : cmf @gnd : 25
acap_cmf_cwn : cmf          !cpg !caa cwn : cmf cwn : 25
ecap_cmf_sub : !cmf -cmf !cms !cpg !caa !cwn : -cmf @gnd : 52
ecap_cmf_cwn : !cmf -cmf !cms !cpg !caa cwn : -cmf cwn : 52

acap_cmf_caa : cmf          caa !cpg !cca : cmf caa : 49
ecap_cmf_caa : !cmf -cmf caa !cms !cpg : -cmf caa : 59

acap_cmf_cpg : cmf          cpg !ccp : cmf cpg : 49
ecap_cmf_cpg : !cmf -cmf cpg !cms : -cmf cpg : 59

# second metal capacitances
acap_cms_sub : cms          !cmf !cpg !caa !cwn : cms @gnd : 16
acap_cms_cwn : cms          !cmf !cpg !caa cwn : cms cwn : 16
ecap_cms_sub : !cms -cms !cmf !cpg !caa !cwn : -cms @gnd : 51
ecap_cms_cwn : !cms -cms !cmf !cpg !caa cwn : -cms cwn : 51

acap_cms_caa : cms          caa !cmf !cpg : cms caa : 25
ecap_cms_caa : !cms -cms caa !cmf !cpg : -cms caa : 54
acap_cms_cpg : cms          cpg !cmf : cms cpg : 25
ecap_cms_cpg : !cms -cms cpg !cmf : -cms cpg : 54
acap_cms_cmf : cms          cmf !cva : cms cmf : 49
ecap_cms_cmf : !cms -cms cmf          : -cms cmf : 61

lcap_cms     : !cms -cms =cms          : -cms =cms : 0.07

```

```

vdimensions :
  v_caa_on_all : caa !cpg          : caa : 0.30 0.00
  v_cpg_of_caa : cpg !caa          : cpg : 0.60 0.50
  v_cpg_on_caa : cpg caa           : cpg : 0.35 0.70
  v_cmf         : cmf               : cmf : 1.70 0.70
  v_cms         : cms               : cms : 2.80 0.70

```

```

dielectrics :
# Dielectric consists of 5 micron thick SiO2
# (epsilon = 3.9) on a conducting plane.
SiO2  3.9  0.0
air    1.0  5.0

```

```

sublayers :
# name      conductivity top
substrate  6.7          0.0

```

```

selfsubres :
# Generated by subresgen on 10:56:15 13-5-2003
#   area   perim    r    rest
0.64     3.2     81286.8  0.01 # w=0.8 l=0.8
0.64      4     73678.39  0.01 # w=0.4 l=1.6
0.48     3.2     88205.12  0.01 # w=0.4 l=1.2
2.56     6.4     40643.4   0.01 # w=1.6 l=1.6
2.56      8     36839.2   0.01 # w=0.8 l=3.2
1.92     6.4     44102.56  0.01 # w=0.8 l=2.4
10.24    12.8    20321.7   0.01 # w=3.2 l=3.2
10.24    16     18419.9   0.01 # w=1.6 l=6.4
7.68     12.8    22051.22  0.01 # w=1.6 l=4.8
40.96    25.6    10160.85  0.01 # w=6.4 l=6.4
40.96    32     9209.799   0.01 # w=3.2 l=12.8
30.72    25.6    11025.61  0.01 # w=3.2 l=9.6
163.84   51.2    5080.426  0.01 # w=12.8 l=12.8
163.84   64     4604.902  0.01 # w=6.4 l=25.6
122.88   51.2    5512.804  0.01 # w=6.4 l=19.2
655.36  102.4    2540.212  0.01 # w=25.6 l=25.6
655.36   128    2302.451  0.01 # w=12.8 l=51.2
491.52  102.4    2756.403  0.01 # w=12.8 l=38.4
2621.44  204.8    1270.106  0.01 # w=51.2 l=51.2
2621.44   256    1151.225  0.01 # w=25.6 l=102.4
1966.08  204.8    1378.201  0.01 # w=25.6 l=76.8

```

```

coupsubres :
# Generated by subresgen on 10:56:15 13-5-2003
#   area1   area2   dist    r    decr
0.64     0.64     1.6     648598  0.873512 # w=0.8 d=1.6
0.64     0.64     3.2     1101504  0.925946 # w=0.8 d=3.2
0.64     0.64     6.4     1996617  0.959256 # w=0.8 d=6.4
0.64     0.64    25.6     7341756  0.988935 # w=0.8 d=25.6
2.56     2.56     3.2     324299.1  0.873515 # w=1.6 d=3.2
2.56     2.56     6.4     550752.1  0.925953 # w=1.6 d=6.4
2.56     2.56    12.8     998307.9  0.959253 # w=1.6 d=12.8
2.56     2.56    51.2     3670877  0.988967 # w=1.6 d=51.2

```

```

10.24      10.24      6.4      162149.6  0.873515 # w=3.2 d=6.4
10.24      10.24     12.8      275376   0.925950 # w=3.2 d=12.8
10.24      10.24     25.6     499154.2  0.959259 # w=3.2 d=25.6
10.24      10.24    102.4     1835439   0.988967 # w=3.2 d=102.4
655.36     655.36     51.2     20268.69  0.873515 # w=25.6 d=51.2
655.36     655.36    102.4      34422    0.925953 # w=25.6 d=102.4
655.36     655.36    204.8     62394.28  0.959257 # w=25.6 d=204.8
655.36     655.36    819.2    229429.8  0.988985 # w=25.6 d=819.2

```

```
#EOF
```

The above element definition file also contains a description of the substrate layers but this information is not used when using the interpolation method for substrate resistance computation.

The following parameter file is used for this example:

```

% cat param.p
# rcsid = "... param.p,v 1.5 2006/06/22 10:55:09 ..."
# directory: demo/suboscil

BEGIN sub3d          # Data for the boundary-element method
be_mode              0g
max_be_area          1 # micron^2
edge_be_ratio        0.01
edge_be_split        0.2
be_window            10 # micron
END sub3d

min_art_degree       3 # Data for network reduction
min_degree           4
min_res              100 # ohm
max_par_res          20
no_neg_res           on
min_coup_cap         0.05
lat_cap_window       6.0 # micron
max_obtuse           110.0 # degrees
equi_line_ratio      1.0

disp.save_prepass_image on # Data for Xspace

```

Then *space3d* is run in flat mode with the option **-b** for interpolated substrate resistance extraction and with the option **-C** for coupling capacitance extraction, as follows:

```
% space3d -vF -P param.p -bC oscil
```

The output is a circuit description containing transistors, capacitances and substrate resistances. This output can be inspected by running *xspice* with e.g. using the option **-a** and with "oscil" as an argument.

```
% xspice -a oscil
```

Alternatively *Xspace* can be used to extract the circuit.

```
% Xspace -P param.p
```

Click button "oscil" in the menu "Database", click button "inter. sub. res." and "coupling cap." in the menu "Options", click button "DrawSubTerm", "FillSubTerm" and "DrawSubResistor" in the menu "Display", and click "extract" in the menu "Extract". This will yield the following picture:

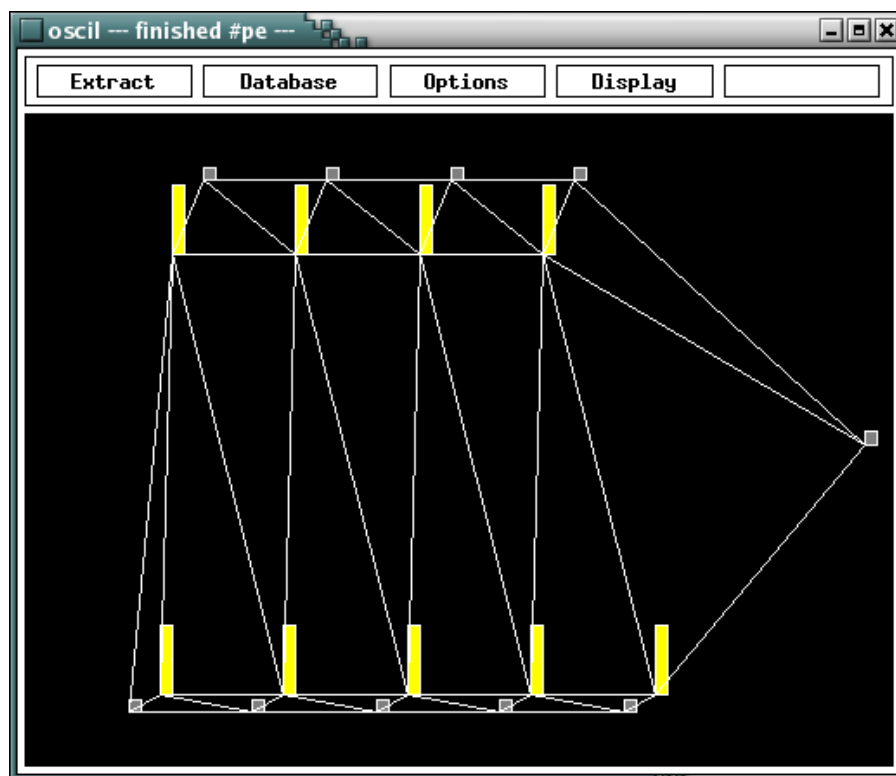

The picture shows the direct coupling resistances that are computed between the substrate contacts and the bulk connections of the n-MOS transistors. The resistances to the substrate node, that are also computed, are not shown.

If you have *spice* available, you can run a *spice* simulation to inspect the noise on the terminal "sens" that is caused by the substrate coupling effects. (Check the script "nspice" to see if *spice* is called correctly). In order to run *spice*, use the simulation interface *simeye*.

```
% simeye
```

Click on the "Simulate" menu and choice the "Prepare" item. Select in the "Circuit:" field cell name "oscil" and in the "Stimuli:" field file name "oscil.cmd" (click on it). Choice simulation "Type: spice" and click on the "Run" button. This will yield the following result:

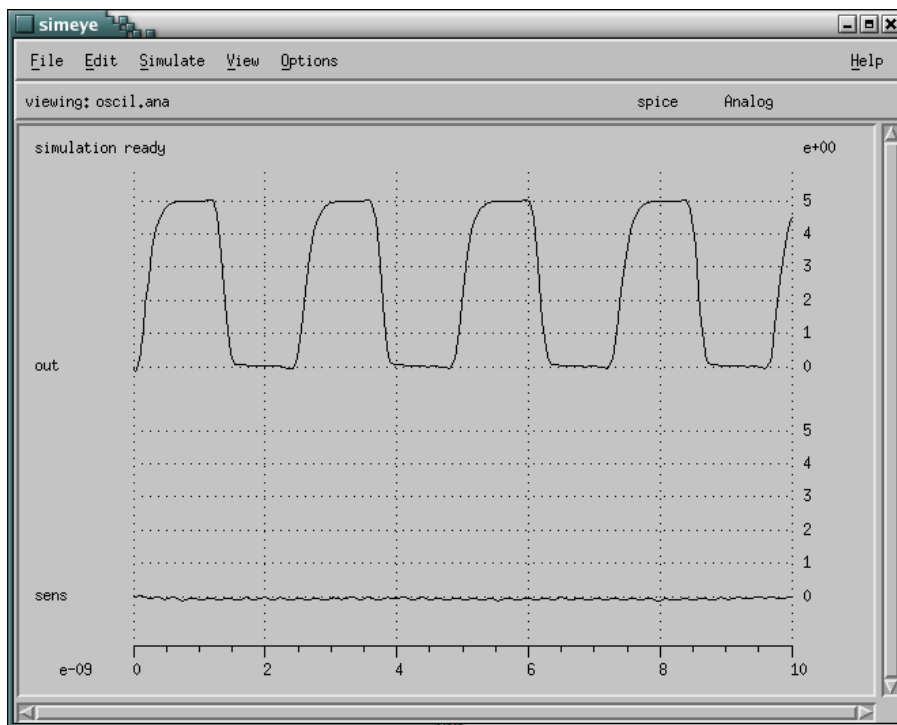

One may zoom in on the signal "sens" after clicking on the "View" menu "ZoomIn" item. Draw with the mouse a rubber box zoom in area around the signal part to zoom in. Set "Options" menu item "DetailZoomON" for detailed "ZoomIn" on one signal. To leave the program, choice item "Exit" in the "File" menu.

6. General Parameters

There are some parameters for substrate resistance extraction that can be used both with the boundary-element method and the interpolation method. These parameters are described below.

`elim_sub_node` *boolean* (default: off)

If this parameter is set, the substrate node "SUBSTR" will be eliminated after substrate resistance extraction. This option can not be used when extracting capacitances.

`elim_sub_term_node` *boolean* (default: off)

If this parameter is set, nodes corresponding to substrate terminals will be eliminated, unless they are retained because of another reason, like being connection of a transistor.

The following two parameters are useful when using *Xspace / helios*.

`disp.save_prepass_image` *boolean* (default: off)

During substrate resistance extraction, a preprocessing step is executed. If this parameter is set, the image that is generated by *Xspace / helios* during the first pass will not be erased but will also be shown during subsequent passes.

`disp.fill_sub_term` *boolean* (default: off)

When the above parameter is on, substrate terminals are drawn with their tile (mask) color. When it is off, only the border of the substrate terminals is drawn.

References

1. T. Smedes, "A Boundary-Element Method for Substrate Cross-talk Analysis," *Proc. of th ProRISC/IEEE Benelux Workshop on Circuits, Systems and Signal Processing*, Mierlo, the Netherlands, pp. 285-294 (Mar. 1995).
2. T. Smedes, N.P. van der Meijs, and A.J. van Genderen, "Extraction of Circuit Models for Substrate Cross-talk," *Proc. of the ICCAD*, San Jose, CA, USA, pp. 199-206 (Nov. 1995).
3. A. J. van Genderen, N. P. van der Meijs, and T. Smedes, "Fast Computation of Substrate Resistances in Large Circuits," *Proc. ED&TC*, Paris,(March 1996).

CONTENTS

1. Introduction.....	1
1.1 Substrate Resistance Extraction.....	1
1.2 Space Characteristics	2
1.3 Documentation.....	2
1.4 On-line Examples.....	3
2. Program Usage.....	4
2.1 General.....	4
2.2 Batch Mode Extraction	4
2.3 Interactive Extraction.....	4
3. Technology Description	6
3.1 Introduction.....	6
3.2 Substrate Terminals.....	6
3.3 Contacts.....	7
3.4 MOS Transistors	7
3.5 Bipolar Transistors	8
3.6 Capacitances	8
3.7 Substrate Conductivity.....	9
3.8 Substrate Permittivity.....	10
3.9 Typical Substrate Resistances	11
4. The Boundary-Element Method	13
4.1 Introduction.....	13
4.2 Substrate Edge Effects	13
4.3 Mesh Construction	14
4.4 Shape and Weight Functions.....	15
4.5 Accuracy of Elastance Matrix.....	16
4.6 Window Size	16
4.7 Example Parameter File.....	17
4.8 Example of 3 Substrate Terminals	17
4.9 Run-time Versus Accuracy	20
4.10 Solving Problems	21
4.11 The BEM/FEM Method.....	22
5. The Interpolation Method	24
5.1 Introduction.....	24
5.2 Network Structure	24
5.3 Resistance Computation.....	25
5.4 Determining the Parameters.....	26
5.5 Example of CMOS Ring Oscillator	26
6. General Parameters	34
References.....	35

