



Contents

Introduction

Survey - gain an overview	1-3
System structure of AC500/S500-FBP.....	1-3
AC500 system overview.....	1-4
Bus systems overview.....	1-8
Documentation overview.....	1-15
Short description of the hardware.....	1-19
Short description of the software.....	1-20
Operating and displaying.....	1-22
Services.....	1-26
Service - Control Engineering.....	1-26
Repair services and replacement devices.....	1-26
Seminars/Workshops.....	1-27
Addresses.....	1-28
Regulations concerning the appropriate and safe setup of systems and installations.....	1-29
Getting started with AC500	1-32
Important user information.....	1-32
Before starting.....	1-33
Assembling the system.....	1-36
Insertion / replacement of the Lithium battery.....	1-39
Insertion of the SD Memory Card.....	1-41
Mounting the system.....	1-42
AC500 system dimensions.....	1-48
Setting the FBP slave address.....	1-50
Status display and error indication on the AC500 CPU.....	1-52
LEDs on S500-FBP modules.....	1-56
Specifications and certifications.....	1-58
Getting started with S500-FBP	1-59
Important user information.....	1-59
Before starting.....	1-60
Assembling the system.....	1-62
Mounting the system.....	1-65
S500 system dimensions.....	1-70
Setting the FBP slave address.....	1-72
LEDs on S500-FBP modules.....	1-73
Specifications and certifications.....	1-75
Examples	1-76
Examples for introduction	1-76
Getting started.....	1-76
Examples for decentralized systems connected by network	1-96
Example: AC500 CPU PM581 as PROFIBUS-DP master and coupler DC505-FBP as PROFIBUS DP slave with FieldBusPlug PDP22-FBP.....	1-96
For AC1131 experts – connection of S500-FBP I/O module to series 90	1-122
Example: AC31 Series 90 CPU as PROFIBUS-DP master and decentralized I/O expansion using a DC505-FBP.....	1-122

Survey - gain an overview

System structure of AC500/S500-FBP

The principle system structure is shown in the following figure:

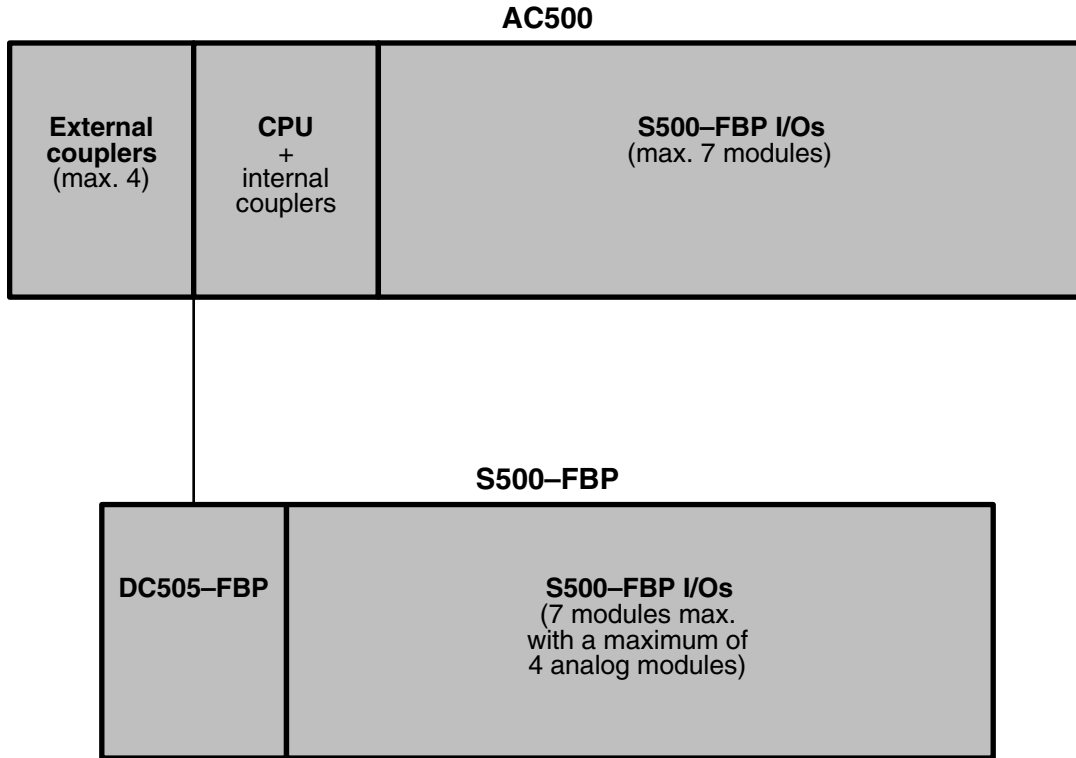

Explanation

The following electronic modules are the basic components of the AC500 system:

- CPUs of three different performance classes
- Couplers for various bus systems: Fieldbus systems PROFIBUS DP, CANopen, DeviceNet; Ethernet couplers.

Central expansion: One CPU supports direct connection of up to seven S500 FBP system I/O devices.

Decentralized expansion: Using the DC505 FBP interface module (for fieldbus systems PROFIBUS DP, CANopen, DeviceNet, Modbus RTU), up to seven S500 FBP system I/O devices can be connected (with a maximum of four analog modules).

Mechanical mounting of the electronic modules is done using CPU terminal bases (for the CPU and the couplers) and I/O terminal units (for the I/O modules), designed for snap-on mounting on a DIN rail or for screw-mounting on a mounting panel.

AC500 system overview

AC500 is a complex state-of-the-art system providing extensive automation potential for your plant.



Figure: AC500 system

The following pages provide a summary of all devices available for the AC500 system. For detailed information about the individual devices please refer to the respective hardware description.

Overview of available CPUs

Type	Order number	Description
PM571	1SAP 130 100 R0100	PM571, CPU 64kB, 24 V DC, Memory Card Slot, 2x RS-232/485 (Programming, MODBUS/CS31), 1x FBP, Display
PM571-ETH	1SAP 130 100 R0170	PM571-ETH, CPU 64kB, 24 V DC, Memory Card Slot, 2x RS-232/485 (Programming, MODBUS/CS31), 1x FBP, Display, integrated Ethernet TCP/IP
PM581	1SAP 140 100 R0100	PM581, CPU 256kB, 24 V DC, Memory Card Slot, 2x RS-232/485 (Programming, MODBUS/CS31), 1x FBP, Display
PM581-ARCNET	1SAP 140 100 R0160	PM581-ARCNET, CPU, memory 256 kB, 24 V DC, Memory Card Slot, interfaces 2 x RS-232/485 (programming, Modbus/CS31), 1 x FBP, Display, integrated coupler ARCNET
PM581-ETH	1SAP 140 100 R0170	PM581-ETH, CPU 256kB, 24 V DC, Memory Card Slot, 2x RS-232/485 (Programming, MODBUS/CS31), 1x FBP, Display, with integrated Ethernet TCP/IP coupler
PM582	1SAP 140 200 R0100	PM582, CPU, memory 512 kB, 24 V DC, Memory Card Slot, interfaces 2 x RS-232/485 (programming, Modbus/CS31), 1 x FBP, Display
PM582-ETH	1SAP 140 200 R0170	PM582-ETH, CPU, memory 512 kB, 24 V DC, Memory Card Slot, interfaces 2 x RS-232/485 (programming, Modbus/CS31), 1 x FBP, Display, integrated coupler Ethernet TCP/IP
PM591	1SAP 150 100 R0100	PM591, CPU 4MB, 24 V DC, Memory Card slot, 2x RS-232/485 (Programming, MODBUS/CS31), 1x FBP, Display
PM591-ARCNET	1SAP 150 100 R0160	PM591-ARCNET, CPU, memory 4 MB, 24 V DC, Memory Card Slot, interfaces 2 x RS-232/485 (programming, Modbus/CS31), 1 x FBP, Display, integrated coupler ARCNET
PM591-ETH	1SAP 150 100 R0170	PM591-ETH, CPU 4MB, 24 V DC, Memory Card Slot, 2x RS-232/485 (Programming, MODBUS/CS31), 1x FBP, Display, with integrated Ethernet TCP/IP Coupler

Overview of available couplers

Type	Order number	Description
CM572-DP	1SAP 170 200 R0001	CM572-DP, Communication Module PROFIBUS DP Master 12 Mb/s
CM575-DN	1SAP 170 500 R0001	CM575-DN, Communication Module DeviceNet Master
CM577-ETH	1SAP 170 700 R0001	CM577-ETH, Communication Module, Ethernet TCP/IP, with integrated 2-port switch
CM578-CN	1SAP 170 800 R0001	CM578-CN, Communication Module, CANopen Master

Overview of available CPU terminal bases

Type	Order number	Description
TB511-ARCNET	1SAP111 100 R0160	TB511-ARCNET, CPU Terminal Base AC500, 1x CPU Slot, 1x Coupler Slot, ARCNET COAX Connector
TB511-ETH	1SAP 111 100 R0170	TB511-ETH, CPU Terminal Base AC500, 1x CPU Slot, 1x Coupler Slot, Ethernet RJ45 Connector
TB521-ARCNET	1SAP 112 100 R0160	TB521-ARCNET, Terminal Base AC500, 1x CPU Slot, 2x Coupler Slots, ARCNET COAX Connector
TB521-ETH	1SAP 112 100 R0170	TB521-ETH, CPU Terminal Base AC500, 1x CPU Slot, 2x Coupler Slots, Ethernet RJ45 Connector
TB541-ETH	1SAP 114 100 R0170	TB541-ETH, CPU Terminal Base AC500, 1x CPU Slot, 4x Coupler Slots, Ethernet RJ45 Connector

Overview of available I/O modules

Type	Order Number	Description
DI524	1SAP 240 000 R0001	DI524, Digital Input Module, 32 DI, 24 V DC, 1-wire
DC522	1SAP 240 600 R0001	DC522, Digital input/output module, 16 DC, 24 V DC / 0.5 A, 2-wire
DC523	1SAP 240 500 R0001	DC523, Digital input/output module, 24 DC, 24 V DC / 0.5 A, 1-wire
DC532	1SAP 240 100 R0001	DC532, Digital Input/Output Module, 16 DI / 16 DC, 24 V DC / 0.5 A, 1-wire
DX522	1SAP 245 200 R0001	DX522, Digital Input/Output Module, 8 DI 24 V DC, 8 DO Relay, 2-wire
DX531	1SAP 245 000 R0001	DX531, Digital Input/Output Module, 8 DI, 230 V AC, 4 DO Relay, 2-wire
AI523	1SAP 250 300 R0001	AI523, Analog input module, 16 AI, U/I/Pt100, 12 Bit + sign, 2-wires
AO523	1SAP 250 200 R0001	AO523, Analog output module, 16 AO, U/I, 12 Bit + sign, 2-wires
AX521	1SAP 250 100 R0001	AX521, Analog input/output module, 4 AI / 4 AO, U/I/Pt100, 12 Bit + sign, 2-wires
AX522	1SAP 250 000 R0001	AX522, Analog Input/Output Module, 8 AI / 8 AO, U/I/Pt100, 12 Bit + sign, 2-wire

Overview of available terminal units

Type	Order Number	Description
TU515	1SAP 212 200 R0001	TU515, I/O Terminal Unit, 24 V DC, Screw Terminals
TU516	1SAP 212 000 R0001	TU516, I/O Terminal Unit, 24 V DC, Spring Terminals
TU531	1SAP 217 200 R0001	TU531, I/O Terminal Unit, 230 V AC, Relay, Screw Terminals
TU532	1SAP 217 000 R0001	TU532, I/O Terminal Unit, 230 V AC, Relay, Spring Terminals
TU551-CS31	1SAP 210 600 R0001	TU551-CS31, Bus-I/O Terminal Unit, 24 V DC, Screw Terminals
TU552-CS31	1SAP 210 400 R0001	TU552-CS31, Bus-I/O Terminal Unit, 24 V DC, Spring Terminals

Overview of available FBP interface modules

Type	Order Number	Description
DC505-FBP	1SAP 220 000 R0001	DC505-FBP, FBP-Interface Module, 8 DI / 8 DC, 24 V DC / 0,5 A, 1-wire
DC551-CS31	1SAP 220 500 R0001	DC551-CS31, Digital Input/Output-Bus Module, 8DI / 16DC 24 V DC / 0,5 A, 1-wire

Overview of available FBP terminal units

Type	Order Number	Description
TU505	1SAP 210 200 R0001	TU505, FBP Terminal Unit, Screw Terminals
TU506	1SAP 210 000 R0001	TU506, FBP Terminal Unit, Spring Terminals

Overview of available FieldBusPlugs and accessories

Type	Order number	Description
PDP22-FBP.025	1SAJ 2401 00 R1003	PDP22-FBP.025 PROFIBUS DP-V0/V1-FBP 0.25 m, modular (FieldBusPlug)
PDP22-FBP.050	1SAJ 2401 00 R1005	PDP22-FBP.050 PROFIBUS DP-V0/V1-FBP 0.5 m, modular (FieldBusPlug)
PDP22-FBP.100	1SAJ 2401 00 R1010	PDP22-FBP.100 PROFIBUS DP-V0/V1-FBP 1 m, modular (FieldBusPlug)
PDP22-FBP.200	1SAJ 2401 00 R1020	PDP22-FBP.200 PROFIBUS DP-V0/V1-FBP 2 m, modular (FieldBusPlug)
PDP22-FBP.500	1SAJ 2401 00 R1050	PDP22-FBP.500 PROFIBUS DP-V0/V1-FBP 5 m, modular (FieldBusPlug)
PDV11-FBP.0	1SAJ 924 008 R0001	Feeding connector 24 V DC, Code B-A
PDV12-FBP.0	1SAJ 924 011 R0001	Feeding connector 24 V DC, Code A-A
PDA11-FBP.050	1SAJ 924 009 R0005	Adapter M12-Dsub9-M12, cable length 0.50 m
PDA12-FBP.050	1SAJ 924 010 R0005	Adapter M12-Dsub9-M12, cable length 2 x 0.50 m
PDR11-FBP.150	1SAJ 924 007 R0001	Terminating resistor 150 Ohm

Overview of available accessories

Type	Order Number	Description
TA521	1SAP 180 300 R0001	TA521, Lithium Battery
MC502	1SAP 180 100 R0001	MC502, SD Memory Card 128 MB
TK501	1SAP 180 200 R0001	TK501, Programming Cable, D-Sub / D-Sub
TK502	1SAP 180 200 R0101	TK502, Programming Cable, Terminal Block / D-Sub
TA523	1SAP 180 500 R0001	TA523, Pluggable Marker Holder (10 pcs)
TA524	1SAP 180 600 R0001	TA524, Dummy Coupler Module
TA525	1SAP 180 700 R0001	TA525, Set of 10 white Plastic Markers
TA526	1SAP 180 700 R2001	TA526, Wall mounting accessory, 10 pcs
PS501-PROG	1SAP 190 100 R0001	PS501-PROG, Control Builder AC500, Programming Software German / English / French (CD-ROM incl. Online Help and PDF Docs)

Bus systems overview

Bus System	Short information / Web Links / Block Libraries
ARCNET	www.arcnet.com ARCNET Trade Association, USA; -> Literature -> Other Publications -> ARCNET Tutorial and Product Guide
CANopen	www.can-cia.org
DeviceNet	www.odva.org -> DEVICENET
Ethernet	www.ethermanage.com The Ethernet Library -> see 'Function Block Libraries AC500'
Modbus	www.modbus.org
PROFIBUS	www.profibus.com -> Web Based Training The PROFIBUS DP Library -> see 'Function Block Libraries AC500'

Brief information about ARCNET

ARCNET (Attached Resource Computer NETWORK)

ARCNET is an open, multi-purpose field bus solution with real-time capability. It can be used for multi-master networking and for programming the AC500 and AC31 controller series, but also for connecting additional ARCNET subscribers, e.g. PCs via an appropriate interface card (see catalog).

Topology

ARCNET is one of the few networks that can be operated in every conceivable topology. Options include bus, star, or tree topologies, or mixtures of these. This means that ARCNET can be used for a broad field of different applications.

Bus assignments

ARCNET operates on the token-passing procedure, where each subscriber has equal rights.

Configuration mechanisms

ARCNET subscribers can freely join and leave during an active runtime session. The system will automatically configure the available user database.

Security mechanisms

A 16-bit CRC is appended to every data packet, and checked by the recipient. If the token is lost, a reconfiguration routine will be initiated, and the network will automatically be restructured. Additionally, diagnostic registers are available.

Physical characteristics

ABB recommends coaxial cables as transmission medium, for direct connection to the CPU. But also twisted-pair cables or (glass, plastic) fiber-optic cables can be connected via bus converters. The line lengths that can be achieved without any intermediate amplifiers depend not only on the used medium, but also on the selected baud rate and the number of subscribers. The ranges per segment vary from approximately 120 m for a simple two-wire bus, up to 3 km for fiber-optics, in each case at 2.5 MBit/s. By providing appropriate hubs, different topologies and transmission media can be combined with each other and the transmission distance can be increased. The coaxial cables used are a type with 93 Ohm, e.g. RG 62. The permissible twisted-pair cables are specified in IEEE 802.3i-1990. At 2.5 MBit/s and with coaxial cables, for example, the maximum length of a bus segment is 300 m with eight subscribers and without a hub. With twisted-pair cables, under the same conditions, a maximum length of approximately 120 m can be achieved. The maximum transmission length depends on the number of connected subscribers. With coaxial cables, a maximum of 16 km can be achieved; with twisted-pair cables approximately 6 km, in each case at 2.5 MBit/s. The fiber-optic link provides the highest degree of interference immunity. With glass fiber-optics, distances of up to 3 km are possible at 2.5 MBit/s; with plastic fiber-optic cables only small distances of up to approximately 100 m. The baud rate plays no significant role in fiber-optic cable transmission. Here, the range can as well be extended using hubs.

Diagnostics

Detailed diagnostic messages for rapid trouble-shooting are shown on the CPU display or can be called using the programming tool.

ARCNET – the functionality at a glance

- Guaranteed collision-free data transmission, guaranteed response times and real-time capability thanks to token-passing
- Large network dimensions: network length 300 m, with amplifier max. 16 km
- Secure, thanks to checksums in the data packet and handshake protocol between transmitter and receiver
- Variable network structure: bus, tree and star topologies are possible, plus any desired mixtures of them
- Variable networking media, coaxial cables, twisted-pair cables and fiber-optic cables can be mixed
- Automatic subscriber log-on and log-off; the network automatically incorporates new stations in the ring and cancels them as well
- Master-master access: the subscriber that holds the token is the master. With up to 255 masters at the same network
- Data transmission rate of max. 2.5 MBit/s
- ARCNET is configured and programmed using the AC500 Control Builder engineering tool

Brief information about CANopen and DeviceNet

CANopen (Controller Area Network) and DeviceNet

The CANopen protocol was originally developed for the European automotive industry to replace expensive cabling with an affordable system. Today, it is also used in the field of automation for transmitting process data between control systems, decentralized I/O modules, drives, valves, etc. CAN features a high level of transmission security, since large portions of the monitoring mechanisms have been implemented directly in the CAN chip. DeviceNet and CANopen utilize the physical structure and the data transport mechanisms of CAN (Controller Area Network). The difference lies in the transmission protocols. DeviceNet and CANopen can be used correspondingly for the AC500 and AC31 controller series and for field-bus-neutral FBP devices (decentralized I/Os and intelligent switching devices), via the CANopen-FBP plug connector.

Data transmission

Two types of message have been defined: I/O data transfer and direct link. I/O data transfer is used for time-critical process data, while the direct link can be, for example, used for diagnostic messages.

Bus access for subscribers

The connection ID with the lower address has higher priority on the bus. Data is transmitted by the source, while the sinks (i.e. receivers of the data) have likewise been specified during the configuration phase.

CANopen

The bus operates on the master/slave principle with one master and up to 127 slaves. A shielded twisted-pair cable is used, according to ISO 11898. Cable lengths and transmission rates: from max. 40 m at 1 MBit/s to 1000 m at 20 kBit/s.

DeviceNet

The bus operates on the multi-master and/or the master/slave principle, with up to 64 bus subscribers. Two types of shielded twisted-pair cables are used: trunk cable for the main line and drop cable for the branch line.

Transmission rate	125 Kbit/s	250 Kbit/s	500 Kbit/s
Max. cable length of trunk line Trunk cable	500 m (1610 ft)	250 m (820 ft)	100 m (328 ft)
Max. cable length of trunk line Drop cable	100 m (328 ft)	100 m (328 ft)	100 m (328 ft)
Max. cable length per branch line Trunk cable/Drop cable	6 m (20 ft)	6 m (20 ft)	6 m (20 ft)
Max. cable length total branch line Trunk cable/Drop cable	156 m (512 ft)	78 m (256 ft)	39 m (128 ft)

Diagnostics

Detailed diagnostic messages for rapid trouble-shooting are shown on the CPU display or can be called using the programming tool. In addition, the device status is indicated at the communication module by four LEDs.

Brief information about CS31 field bus

CS31 (Communication Serial Field Bus, developed by ABB in 1989) for continuity and migration

CS31 is a proprietary master/slave field bus. It is characterized by simple handling, easy configuration, and inexpensive installation. The COM1 interface of the AC500 can be configured as a CS31 field bus master.

Communication

Is handled using polling, i.e. the master sends a request to the slave and then receives the response. The CS31 operating mode of COM1 is set using the engineering tool.

Topology

Multi-point line, RS485, approved without branch lines. A system consists of one master and up to 31 slaves. The maximum cable length is 500 m, or 2 km with an amplifier. Slaves are primarily decentralized input/output modules with integrated CS31 bus connection.

Data transmission

Is performed at 187.5 kB/s. Each telegram has an 8-bit CRC appended. The telegrams enable process data (input/output data) to be written and read.

Transmission medium

Primarily a twisted-pair, shielded cable with terminators. Other transmission media: fiber-optic cables via a converter (glass fibers max. 3 km, plastic max. 100 m), contact lines, slip rings (bus length max. 50 m) and data photocells.

Diagnostics

Detailed diagnostic messages for rapid trouble-shooting are shown on the CPU display or can be called using the programming tool.

Brief information about Ethernet

Ethernet

Ethernet operates with a data rate of 10 MBit/s and as Fast-Ethernet with 100 MBit/s. Ethernet utilizes the producer/consumer model. This means that every station possesses equal rights. While it is transmitting, all other stations listen in and accept the data directed to them. Bus access is regulated by the CSMA/CD procedure (Carrier-Sense Multiple-Access with Collision Detection), where each station may autonomously transmit when the bus is free. If a collision occurs, if two stations begin to transmit simultaneously, both of them will stop transmission and wait for a randomly determined time before they transmit again. Ethernet defines the Layers 1 (Physical Link) and 2 (Data Link) of the OSI model.

The AC500 supports transmission and reception of data using TCP/IP and/or UDP/IP. Further application layers can be implemented by subsequent loading. Simultaneous operation of TCP/IP, UDP/IP and application layer is also assured. The IP, TCP, UDP, ARP, RP, BOOTP, and DHCP protocols are supported as a standard feature, as application layer Modbus/TCP.

Topology

Star- or ring-shaped using Ethernet hub or switch.

Data transmission

Max. 10 MB/s with 10 Base T and max. 100 MB/s with Fast-Ethernet.

Transmission media

Twisted-pair cables with RJ45 connector. The maximum cable length is 100 m for 100 MB/s.

Diagnostics

Detailed diagnostic messages for rapid trouble-shooting are shown on the CPU display or can be called using the programming tool. In addition, the device status is indicated at the communication module by four LEDs.

Brief information about Modbus

Modbus® RTU (developed by Modicon in 1979)

Modbus® RTU is an open master/slave protocol, and can be easily implemented on serial interfaces. Numerous automation systems have Modbus® RTU interfaces as standard or optional features, and are thus easily able to communicate with the AC500 via its integrated COM1 and COM2 interfaces (RS232 or RS485). The Modbus® is used not only in industrial applications, but also in building installations, in energy optimization systems, for long-distance data transmission and for linking up operator panels.

Communication

By polling, i.e. the master transmits a request to the slave and then receives the response. Both interfaces COM1 and COM2 can operate simultaneously as Modbus interfaces. The Modbus operating mode of an interface is set using the engineering tool.

Topology

Point-to-point via RS232 or multi-point via RS485. With RS232, a maximum of one master and one slave is possible, while with RS485 one master and a maximum of 31 slaves can be operated. The maximum cable length is 15 m with RS232 and 1.2 km with RS485.

Data transfer

Max. 187.5 kB/s. Each telegram has a 16-bit CRC appended. The telegrams permit process data (input/output data) to be written and read, either individually or in groups. The data are packed in the RTU format.

Transmission media

May vary. One widely used option is the RS485 bus physics, a twisted-pair, shielded cable with terminators.

Diagnostics

Detailed diagnostic messages for rapid trouble-shoot-ing are shown on the CPU display or can be called using the programming tool.

Brief information about PROFIBUS DP

PROFIBUS DP (Process Field Bus - Decentral Periphery)

PROFIBUS DP is an open, high-speed and widely-used field bus. It provides multi-master and master-slave communication in the field area. This field bus can accordingly be used for AC500 and AC31 control system series and for field-bus-neutral FBP devices (decentralized I/Os and intelligent switching devices) via the PROFIBUS-FBP connector.

Communication

The masters rule data traffic on the bus. When in possession of the bus access authorization (token), the masters can transmit data without an external request. The passive devices, known as slaves, do not receive any bus access rights; they acknowledge messages received, or respond to a query from a master. Baud rates from 9.6 kBaud to 12 MBaud are supported. A maximum of 126 devices can be operated on the bus.

Data exchange

This is handled predominantly in cyclical mode between master and slave. The requisite communication functions have been specified by the PROFIBUS DP basic functions in accordance with EN 50170. Each master has full write and read access to its assigned slaves, but only read access to the slaves assigned to other bus masters. There is no direct data exchange between masters. Acyclical services (DP-V1) for parameterization and diagnostics between master and slave are also available. This is performed in parallel to the master's cyclical user data traffic.

PROFIBUS DP – the functionality at a glance

- Max. 126 subscribers via amplifier and max. 32 subscribers (master/slaves) per bus segment
- Data transmission rate from max. 12 MBit/s with a cable length of 100 m, up to 93.75 kBit/s with 1200 m
- Multi-master or master/slave communication. Bus access of the masters using token
- Connection of the master CPU and the associated communication module via a 9-pole SUB-D plug connector. Connection of slaves (CPU, I/Os and intelligent switching devices) via FieldBusPlug
- The system cable is a shielded twisted-pair line or a fiber-optic cable; transmission standard EIA RS485

Diagnostics

Detailed diagnostic messages for rapid trouble-shooting are shown on the CPU display or can be called using the programming tool. In addition, the device status is indicated at the communication module by four LEDs.

Documentation overview

The documentation consists of six parts:

- **CoDeSys programming system** - Describes the functionality of the programming software
- Target system - **Documentation of the AC500 system**
- **CoDeSys libraries**
- **CoDeSys visualization**
- **CoDeSys HMI**
- **CoDeSys license management**

CoDeSys programming system

Section	Comment
A brief introduction to CoDeSys	<ul style="list-style-type: none"> - Explanation of the acronym 'CoDeSys' - Software functionality - Components of a project - Programming languages - Debugging
We write a little program	<ul style="list-style-type: none"> - Controlling a traffic signal unit - Visualizing a traffic signal unit
The individual components	<ul style="list-style-type: none"> - Main window and functions - Options for project organization - Object handling (blocks, data types, visualizations, resources) - Editing functions - Online functions - Explanation of the help system
Editors in CoDeSys	<ul style="list-style-type: none"> - General - Declaration editor for the variables - Pragma instructions for controlling the compilation process - Text editor for instruction list and structured text - Graphical editors for sequential function chart, ladder diagram, function block diagram and free-graphic function block diagram editor
The resources	<ul style="list-style-type: none"> - PLC configuration - Global variables - Alarm configuration - Library manager - Logging (chronological recording of actions during online session) - Task configuration - Watch and recipe manager - Workspace (image of the project options set) - Target system settings - Target specific resources
ENI revision control	ENI (engineering interface for accessing an external project database from the programming system)
IEC operators and additional norm-extending functions	<ul style="list-style-type: none"> - Arithmetic operators (ADD, MUL, SUB, ...) - Bitstring operators (AND, OR, XOR, NOT) - Bitshift operators (SHL, SHR, ROL, ROR) - Selection operators (SEL, MAX, MIN, LIMIT, MUX) - Comparison operators (GT, LT, LE, GE, EQ, NE) - Address operators (ADR, ADRINST, BITADR, content operator) - Calling operator (CAL) - Type conversions - Numeric operators (ABS, SQRT, LN, LOG, ...) - Initialization operator (INI)

Section	Comment
Operands in CoDeSys	<ul style="list-style-type: none"> - Constants - Variables - Addresses - Functions
Data types in CoDeSys	<ul style="list-style-type: none"> - Standard data types - Defined data types
Overview of operators and library blocks	
Command line / command file commands	<ul style="list-style-type: none"> - Commands provided when CoDeSys is started - Command set for building a command file (Cmdfile)
Use of keyboard	<ul style="list-style-type: none"> - Operating CoDeSys using the keyboard only - Key combinations
Siemens import (not available)	Commands for importing blocks and variables from Siemens STEP5 files
DDE communication	Using the DDE interface (Dynamic Data Exchange)
Keywords in CoDeSys	Reserved keywords in CoDeSys (ABS, ACOS, ADD, ...)
CoDeSys files	Files generated by CoDeSys
Compiler errors and warnings	Information about possible error and warning messages displayed in the message window during project compilation.

Documentation for the AC500 system

Section	Comment
Introduction	<ul style="list-style-type: none"> - Overview: Here you can gain an overview of the AC500 system. This section provides further useful information. - First steps when working with AC500 and S500-FBP; examples - For AC1131 experts
Your tasks - Documentation from the user's point of view	<ul style="list-style-type: none"> - Engineering company - Sales and export - Control cabinet building and construction - Commissioning - Program creation - Operation, service and maintenance - Training and education - Callcenter, helpline
AC500 hardware	<ul style="list-style-type: none"> - System data - CPU terminal bases and terminal units - CPUs - Communication modules - CS31 modules - FBP interface modules - Digital input and output modules - Analog input and output modules - Accessories
S500-FBP hardware (system description)	<ul style="list-style-type: none"> - System data and system structure - Terminal units - FBP interface modules - Digital input and output modules - Analog input and output modules - Accessories

Section	Comment
Block libraries	<ul style="list-style-type: none"> - System libraries - Modbus library - Series 90 AC500 library - ASCII communication library - CS31 library - Ethernet library - PROFIBUS DP library - CANopen library - DeviceNet library - DC541 library
System technology	<ul style="list-style-type: none"> - Basic units - Couplers - I/O modules
OPC	OPC (Object Linking and Embedding) for Project Control - a standardized interface for accessing process data

CoDeSys libraries

Section	Comment
'Standard.lib' library	Standard library
'util.lib' library	Various blocks, e.g. for BCD conversion, bit/byte functions, etc.
'AnalyzationNew.lib' library	Analysis of expressions
CoDeSys system libraries	Depends on the target system

CoDeSys visualization

Section	Comment
Creating a visualization object	A CoDeSys project block. The project block contains a set of visualization elements and can have specific properties as one complete object
Inserting visualization elements	E.g. rectangle, curve, button, etc.
Positioning visualization elements	Selecting, copying, modifying, etc. of visualization elements
Configuring the visualization, visualization elements or visualization objects	<ul style="list-style-type: none"> - Configuring the visualization - Overview - Configuring selected elements using configuration dialogs - Summarizing graphical elements to one visualization object which can have specific parameters assigned
Visualization in online mode	With operation by keyboard (configurable)
Visualizations in libraries	Storage of visualizations in libraries
System variables within the visualization	Implicitly created system variables for programming visualizations
Possible key combinations	For operation by keyboard

CoDeSys HMI

Section	Comment
Overview	Runtime system for execution of visualizations
Installation, starting and operation	<ul style="list-style-type: none">- Program which has to be purchased and installed separately- Notes regarding start from command line- Operation by keyboard/mouse via visualization elements

CoDeSys license management (not available)

Section	Comment
Overview	License management using the tool
Creating a module which is subject to licensing	Using the command 'File -> Save as -> Edit License Information dialog'

Short description of the hardware

Example of an AC500 system.

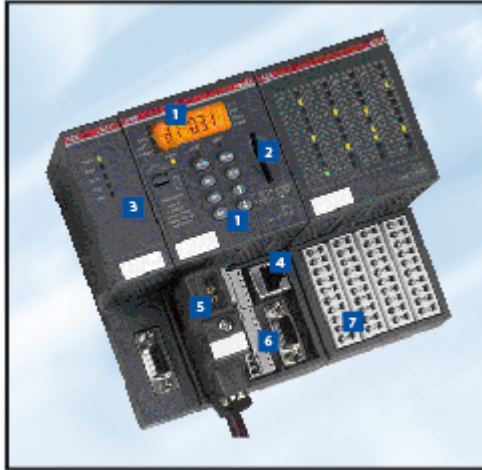

1. Back-lighted LCD display and keypad
2. SD card slot
3. Plug-in communication modules (1 to max. 4)
4. Optionally with integrated Ethernet or ARCNET
5. FBP interface (for slave)
6. Two serial interfaces for programming, ASCII, Modbus or CS31 field bus (master)
7. Expandable by up to seven local I/O modules

Figure: AC500 system, module arrangement beginning from the left: communication module, CPU, I/O module

CPUs

Available in three performance classes:

- PM571 (64kB memory, 2 RS-232/485 interfaces - programming, MODBUS/CS31 (COM1), 1 x FBP)
- PM581 or PM582 (256kB or 512kB memory, 2 RS-232/485 interfaces - programming, MODBUS/CS31 (COM1), 1 x FBP)
- PM591 (4MB memory, 2 RS-232/485 interfaces - programming, MODBUS/CS31 (COM1), 1 x FBP)

All three types are also available with an integrated Ethernet coupler (TCP/IP).

Communication modules

For connection to standard field bus systems and integration into existing networks.

Ethernet coupler supporting the protocols TCP/IP, UDP/IP and Modbus TCP.

Coupler for fieldbus systems – PROFIBUS DP, DeviceNet and CANopen.

Up to four communication modules in any desired combination are allowed at one CPU.

The CPU terminal base

For easy plug-in mounting of a CPU and one, two or four communication modules (three types available accordingly).

The I/O modules

Digital and analog in different versions. Can be simply plugged onto the terminal units – for local expansion of the CPU (max. seven modules) and decentralized expansion via the FBP interface (max. seven modules, thereof max. four analog modules). Flexible use thanks to configurable channels.

The I/O terminal units

Multi-purpose usage for both digital and analog I/Os, for 1, 2 and 3-wire designs. Enable simple prewiring without electronics. For 24 V DC and 230 V AC, optionally for spring or screw-type terminals.

The FBP interface module

With embedded digital I/Os and a field-bus-neutral interface for connecting the chosen FBP connector. For decentralized expansion by up to seven I/O modules.

The SD card

The SD memory card is used for the following purposes: Backup of user data, storage of the user program, storage of the project's source code, update of the internal CPU firmware.

Short description of the software

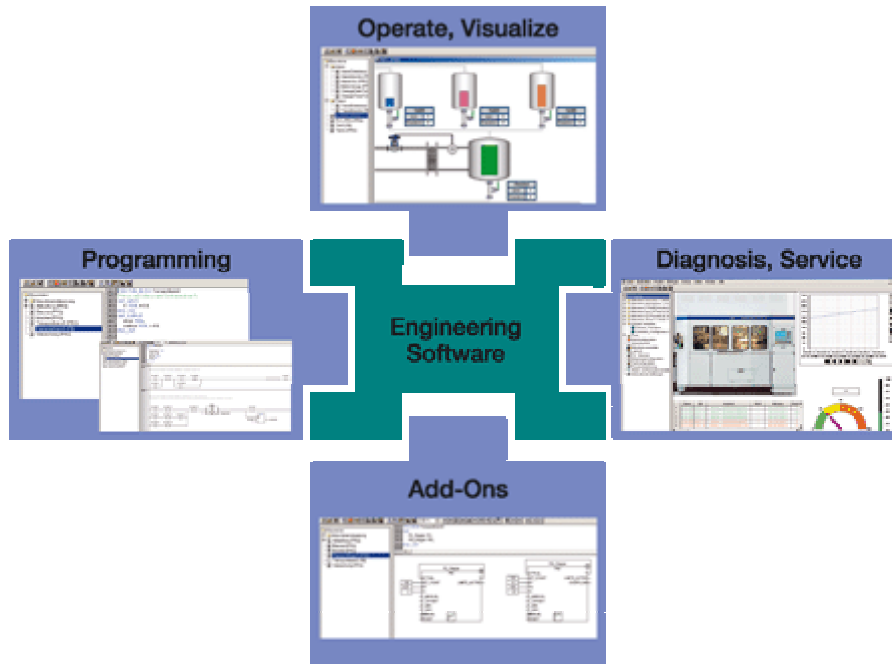

Programming in conformity with IEC 61131-3

AC500 Control Builder provides the following functionalities:

- Five standardized programming languages: Function Block Diagram (FBD), Instruction List (IL), Ladder Diagram (LD), Structured Text (ST), Sequential Function Chart (SFC)
- Free graphical function chart (CFC)
- Debugging functions for the program test: Single step, Single cycle, Breakpoint

Offline simulation

IEC 61131-3 commands can be simulated without a PLC being connected, including the relevant malfunctions. After the program test, the application can be downloaded to the control system.

Sampling trace

Timing diagrams for process variables and storage of data in a ring buffer with event trigger.

Recipe management and watch lists

Values of selected variables are displayed. Pre-defined values can be assigned to variables which can then be downloaded to the control system all at once ("Write recipe"). Ongoing values from the control

system can also be pre-assigned for reading into the Watch and Recipe Manager, and stored in memory there ("Read recipe). These functions are also helpful, for example, for setting and entering control parameters.

Visualization

Includes color change, moving elements, bitmaps, text display, allows input of setpoint values and display of process variables read from the PLC, dynamic bar diagrams, alarm and event management, function keys and ActiveX elements.

Configurators of the communication interfaces

Integrated field bus configurator SYCON.net for PROFIBUS DP, CANopen, DeviceNet, Ethernet, Modbus and CS31.

Open interfaces

DDE and OPC.

Programming

Serial or via Ethernet or ARCNET networks.

Engineering interface

Provides access from the programming system to an external project database in which the program source code of one or several automation projects is managed. Optionally, a version control system, such as Visual Source Safe, can be used in order to ensure data consistency of the program code for several different users and projects.





- Comprehensive libraries.
- Windows 32-bit standard.
- Operating systems Windows 2000 and XP.

Operating and displaying

The AC500 offers as well an extensive range of products for communication between operator and machine. There are many different displays to choose from, which satisfy application-specific demands regarding required operator actions and information density.





Users can communicate with the AC500s CPUs via the various operator panels, read and write access on device data is possible. Configuration is quick and easy to perform, using the same software for all devices (programming software CPsoft, 1SBS 260 283 R1001). Commands and programming languages are identical for all devices. With regard to frequently harsh conditions at the place of installation, all operator panels fulfill IP65 protection at the front. Operator panels and automation devices are linked either simply via serial interfaces, or in case of complex applications via Ethernet, Modbus or PROFIBUS DP.

Overview of CP500 operator panels - part 1

					
Type	CP501	CP502	CP503	CP511	CP512
Order Number	1SBP 260 170 R0101	1SBP 260 171 R0101	1SBP 260 172 R0101	1SBP 260 173 R0101	1SBP 260 174 R0101
Display type	STN LCD with backlight	STN LCD with backlight	STN LCD with backlight	STN LCD with backlight	B/W STN LCD with backlight
Representation	Text	Text	Text	Grafic and text	Grafic and text
Display size	2 lines x 16 characters	2 lines x 20 characters	4 lines x 20 characters	240 x 64 pixels (5.2")	240 x 128 pixels (5.3")
Display area W x H (mm)	55,7 x 11,0	73,5 x 11,5	70,4 x 20,8	127,2 x 33,9	120,0 x 64,0
Text height (mm)	5	5	5	variable	variable
LEDs			5 (2 colors)	16 (2 colors)	16 (2 colors)
Function keys	4	3	5	8	16 (8 with labeling strip)
Web functions				x	x
Buzzer				x	x
Alarm management			1 group	4 groups	4 groups
Time channel		x	x	x	x
Real-time clock		x	x	x	x
Trend curves				real-time	developing of values
Data logger					
Recipe management		x	x	x	x
Report printing		x	x	x	x
Password protection		8 levels	8 levels	8 levels	8 levels
Multilanguage support		x	x	x	x
Application memory	16 kB Flash	64 kB Flash	64 kB Flash	400 kB Flash	400 kB Flash
Power supply	24 V DC	24 V DC	24 V DC	24 V DC	24 V DC
Current consumption	200 mA	150 mA	150 mA	450 mA	450 mA
Ambient temperature	0 - 50 °C	0 - 50 °C	0 - 50 °C	0 - 50 °C	0 - 50 °C

Type	CP501	CP502	CP503	CP511	CP512
Communication interfaces	RS232 or RS422	RS232, RS422 RS485 (of which 2 at the same time)	RS232, RS422	RS232, RS422	RS232, RS422
Expansion slots	-	-	-	1	1
Degree of protection front cover	IP65	IP65	IP65	IP65	IP65
Dimensions W x H x D (mm)	104 x 69 x 38	142 x 100 x 29	147 x 163,5 x 38	211 x 198 x 69	214 x 232 x 87
Weight (kg)	0.2	0.5	0.7	1.5	1.4

Overview of CP500 operator panels - part 2

					
Type	CP513	CP551	CP552	CP554	CP555
Order Number	1SBP 260 175 R0101	1SBP 260 176 R0101	1SBP 260 177 R0101	1SBP 260 178 R0101	1SBP 260 179 R0101
Display type	TFT 256 Color LCD with backlight	Touch B/W STN with backlight	16 grey levels Touch LCD with backlight	TFT 256 Color touch LCD	TFT 256 Color touch LCD
Representation	Grafic and text	Grafic and text	Grafic and text	Grafic and text	Grafic and text
Display size	320 x 240 Pixel	320 x 240 Pixel	320 x 240 Pixel	320 x 240 Pixel	640 x 480 Pixel
Display area W x H (mm)	115,2 x 86,4	78,0 x 58,5	115,2 x 86,4	115,2 x 86,4	211,2 x 158,4
Text height (mm)	variable	variable	variable	variable	variable
LEDs	16 (2 colors)				
Function keys	16 (8 with labeling strip)				
Web functions	x	x	x	x	x
Buzzer	x	x	x	x	x
Alarm management	16 groups	4 groups	5 groups	5 groups	11 groups
Time channel	x	x	x	x	x
Real-time clock	x	x	x	x	x
Trend curves	developing of values	developing of values	developing of values	developing of values	developing of values
Datalogger	x	x	x	x	x
Recipe management	x	x	x	x	x
Report printing	x	x	x	x	x
Password protection	8 levels	8 levels	8 levels	8 levels	8 levels
Multilanguage support	x	x	x	x	x
Application memory	400 kB Flash	400 kB Flash	400 kB Flash	400 kB Flash	1600 kB Flash
Power supply	24 V DC	24 V DC	24 V DC	24 V DC	24 V DC
Current consumption	550 mA	450 mA	400 mA	450 mA	1 A
Ambient temperature	0 - 50 °C	0 - 50 °C	0 - 50 °C	0 - 50 °C	0 - 50 °C
Communication interfaces	RS232, RS422	RS232, RS422 RS485, Ethernet (of which 2 at the same time)	RS232, RS422 RS485 (of which 2 at the same time)	RS232, RS422 RS485 (of which 2 at the same time)	RS232, RS422
Expansion slots	2	-	1	1	2
Degree of protection front cover	IP65	IP65	IP65	IP65	IP65
Dimensions W x H x D (mm)	276 x 198 x 89	138 x 100 x 30	200 x 150 x 69	200 x 150 x 69	290 x 250 x 105
Weight (kg)	1.7	1.4	1.5	1.5	3.3

Services

Service - Control Engineering

ABB operates a Technical Support Center to assist with even the most difficult of problems.

- Consultation by phone (Helpline)
- Failure analysis and removal at the machine/installation

In order to provide the customer with qualified assistance, customers are requested to provide the following:

- Provide all required application documentation and information.
- Provide access (if required) to the system being examined.
- Assign key individuals to assist as required.

For inquiries and orders, please contact:

ABB STOTZ-KONTAKT GmbH
Dept. STO/CPT, Control Engineering Helpline
Eppelheimer Straße 82
D-69123 Heidelberg

Postfach 10 16 80
D-69006 Heidelberg

Phone +49 6221 701-1444
Telefax +49 6221 701-1382

E-mail: desst-helpline.desto@de.abb.com

For further information about control engineering please also refer to our Internet Website
<http://www.abb.de/stotzkontakt>.

Repair services and replacement devices

The following services are also covered by our activities:

- Delivery of replacement devices
- Repair of defective devices and systems

Please contact your responsible sales office for your inquiry.

Seminars/Workshops



We also offer seminars and workshops to support you in planning, commissioning and operation of Advant Controller AC500 controls. Please contact:

ABB STOTZ-KONTAKT GmbH
Dept. STO/VPS
Eppelheimer Straße 82 Postfach 10 16 80
D-69123 Heidelberg D-69006 Heidelberg
Phone +49 6221 701-1202 or -1205
Telefax +49 6221 701-1361
E-mail: Dieter.Druschke@de.abb.com or Heinrich.Happle@de.abb.com

If desired, we also offer seminars at the customer's facility. Please find detailed information in our seminar brochure. You can order this brochure from the address given above or from every ABB STOTZ-KONTAKT GmbH office or you can download it from our Internet website (PDF file, see the following link).

Please send your enrolment directly to ABB STOTZ-KONTAKT GmbH using the address given above or via Internet (<http://www.abb.de/stotzkontakt> -> Schulungen und Seminare -> Seminare).

If necessary, it is also possible to arrange the seminar contents according to the customer's wishes. Depending on the special requirements, the training can be held in Heidelberg or at any other location favored by the customer. We are pleased to prepare an individual offer for you according to your special requirements.

Addresses

ABB STOTZ-KONTAKT GmbH

P.O. Box 10 16 80

D-69006 Heidelberg

Telephone: ++49 62 21 / 701-0

Telefax: ++49 62 21 / 701-729

<http://www.abb.de/stotz-kontakt>

ABB Entrelec - Control Division

184, rue Léon Blum

F-69100 Villeurbanne / France

Telephone: ++33 (0) 4 72 35 35

Telefax: ++33 (0) 4 72 35 12

<http://www.abb.com/lowvoltage>

Regulations concerning the appropriate and safe setup of systems and installations

Apart from the basic „Regulations for the Setting up of Power Installations“ DIN VDE* 0100 and for „The Rating of Creepage Distances and Clearances“ DIN VDE 0110 Part 1 and Part 2 the regulations „The Equipment of Power Installations with Electrical Components“ DIN VDE 0160 in conjunction with DIN VDE 0660 Part 500 have to be taken into due consideration.

To insure project success and to insure that all systems are properly and safely installed, the customer must be familiar and proficient with the following standards and must comply with their directives:

- Working & Process Machinery: DIN VDE 0113 Part 1 & Part 200
- Close proximity to dangerous voltages: DIN VDE 0106 Part 100
- Protection against direct contact: DIN VDE 0160, DIN VDE 0110 Part 1

The user has to guarantee that the devices and the components belonging to them are mounted following these regulations. For operating the machines and installations, other national and international relevant regulations, concerning prevention of accidents and using technical working means, also have to be met.

Advant Controller Devices are designed according to: IEC 1131 Part 2 under overvoltage category II per DIN VDE 0110 Part 2.

For direct connection of AC Category III overvoltages provide protection measures for overvoltage category II according to IEC-Report 664/1980 and DIN VDE 0110 Part 1.

Equivalent standards:

DIN VDE 0110 Part 1 ↔ IEC 664

DIN VDE 0113 Part 1 ↔ EN 60204 Part 1

DIN VDE 0660 Part 500 ↔ EN 60439-1 ↔ IEC 439-1

All rights reserved to change design, size, weight, etc.

* VDE stands for „Association of German Electrical Engineers“.

Safety technical instructions

Please read!

General

Completely safe installation and starting up and problemfree functioning of the devices at their work location can be ensured by observing the following instructions.

Qualified personnel

Both the control system AC500 and other components in the vicinity are operated with dangerous contact voltages. Touching parts, which are under such voltages, can cause grave damage to health.

In order to avoid such risks and the occurrence of material damage, everyone involved with the assembly, starting up and servicing must possess pertinent knowledge of the following:

- the automation technology sector,
- dealing with dangerous voltages,
- using standards and regulations, in particular VDE, accident prevention regulations and regulations concerning special ambient conditions (e.g. areas potentially endangered by explosive materials, heavy pollution or corrosive influences).



Use as directed

Properly installed systems that are "used as directed" and properly conform with the applicable codes, regulations and sound engineering principles pose no risks or dangers to health.

"Used as directed" implies that the devices are installed, maintained and operated in accordance with appropriate ABB manuals & documents.

No liability is assumed for the direct or indirect consequences of the improper use, improper application or inadequate maintenance of these devices.

Risk reduction instructions

	Protect the devices from dampness, dirt and damage during transport, storage and operation!
	Do not operate devices outside of the specified, technical data!

Trouble-free functioning cannot be guaranteed outside of the specified data.

	Operate the control system only in an enclosed housing (switch cabinet)!
---	---

Due to their construction (degree of protection IP 20 according to EN 60529) and their connection technology, the devices are suitable only for operation in enclosed housings (switch cabinets).



Earth the devices!

The earthing (switch cabinet earthing, PE) is supplied both by the mains connection (or 24 V supply voltage) and via DIN rail.

The DIN rail must be connected to the earth before the device is subjected to any power. The earthing may be removed only if it is certain that no more power is being supplied to the control system.

In the description for the devices (operating manual or AC500 system description), reference is made at several points to earthing, electrical isolation and EMC measures. One of the EMC measures consists of discharging interference voltages into the earthing via Y-type capacitors. Capacitor discharge currents must basically be able to flow off to the earthing (in this respect, see also VBG 4 and the relevant VDE regulations).

In the description, special attention must be paid to designs using electrical isolation, earthing and EMC measures for the reasons stated. For more information see Target System -> AC500/S500-FBP -> Hardware AC500 -> System data -> General considerations for EMC-conforming assembly and construction.

The earthing concept of these busses apply to the connection to external bus systems.



Connection of the supply voltage

The supply voltage (or mains connection) terminal block must only be plugged in or withdrawn with the power off!

The same applies to the terminal blocks of input or output channels (e.g. relay outputs) if they are operated with dangerous contact voltages.



Do not open live devices!

The devices work with voltages with which contact must be avoided under all circumstances. Therefore they must not be opened when live. The same applies to the networking interfaces.

Lifting up the cover of the battery compartment to exchange the battery module is not construed as opening in this context.

 **Do not obstruct the ventilation for cooling!**

The ventilation slots on the upper and lower side of the devices must not be covered by wiring, cable ducts and things like that.

 **Run signal and power wiring separately!**

Signal and supply lines (power cables) must be laid out so that no malfunctions due to capacitive and inductive interference can occur (EMC).

 **Precautions against wiring short-circuits and breakages**

Connection plans and user software must be created so that all technical safety aspects, legal regulations and standards are observed. In practice, possible shortcircuits and breakages must not be able to lead to dangerous situations. The extent of resulting errors must be kept to a minimum.

 **Use only ABB approved lithium battery modules!**

At the end of the battery's lifetime, always replace it only with a genuine battery module.

 **Never short-circuit or operate lithium batteries with the polarities reversed!**

They are likely to overheat and explode. Avoid chance short circuiting and therefore do not store batteries in metal containers and do not place them on metallic surfaces. Escaping lithium is a health hazard.

 **Never charge lithium batteries!**

Lithium batteries are primary cells and cannot be recharged. Attempts to charge lithium batteries lead to overheating and possible explosions.

 **Dispose of lithium batteries environmentally consciously!**

Do not open lithium batteries and never throw them into fires (risk of explosion). Do not dispose of along with the household rubbish but in an environmentally conscious manner, in accordance to local-authority regulations.

Additional notes

 **ATTENTION**

Avoidance of electrostatic charging

Electrostatic charging can cause internal defects of the devices and impair the proper function. Observe the following rules when handling the system:

- Touch an earthed object in order to discharge the electrostatic charging.
- Wear a suitable earthed strap around your wrist.
- Do not touch any connections or pins on the printed circuit boards.
- Do not touch any circuits inside the devices.
- If available, use a work place which is equipped with suitable electrostatic discharge.
- In order to avoid electrostatic charging, the devices must only be stored when packed in suitable packaging material.

Minimum clearances: Refer to target system - AC500/S500-FBP -> Introduction -> Getting Started -> Getting Started with AC500 -> Assembling the system

ABB STOTZ-KONTAKT GmbH Heidelberg

Getting started with AC500

Important User Information



Solid state equipment has operational characteristics differing from those of electromechanical equipment. Because of this difference, and also because of the wide variety of uses for solid state equipment, all persons responsible for applying this equipment must satisfy themselves that each intended application of this equipment is acceptable.

In no event will ABB be responsible or liable for indirect or consequential damages resulting from the use or application of this equipment.

The examples and diagrams in this manual are included solely for illustrative purposes. Because of the many variants and requirements associated with any particular installation, ABB cannot assume responsibility or liability for actual use based on the examples and diagrams.

No patent liability is assumed by ABB with respect to use of information, circuits, equipment, or software described in this manual.

Throughout this manual we use notes to make you aware of safety considerations.

 WARNING	Identifies information about practices or circumstances that can cause an explosion in a hazardous environment, which may lead to personal injury or death, property damage, or economic loss.
 IMPORTANT	Identifies information that is critical for successful application and understanding of the product.
 ATTENTION	Identifies information about practices or circumstances that can lead to personal injury or death, property damage, or economic loss. Attentions help you: <ul style="list-style-type: none"> • identify a hazard • avoid a hazard • recognize the consequence
SHOCK HAZARD	Labels may be located on or inside the device to alert people that dangerous voltage may be present.
SHOCK HAZARD	Labels may be located on or inside the device to alert people that surfaces may have dangerous temperatures.

Environment and Enclosure Information

 ATTENTION	<p>Environment and Enclosure</p> <p>This equipment is intended for use in a Pollution Degree 2 industrial environment, in overvoltage Category II applications (as defined in IEC publication 60664-1), at altitudes up to 2000 meters without derating.</p> <p>This equipment is considered Group 1, Class A industrial equipment according to IEC/CISPR Publication 11. Without appropriate precautions, there may be potential difficulties ensuring electromagnetic compatibility in other environments due to conducted as well as radiated disturbance.</p> <p>This equipment is supplied as "open type" equipment. It must be mounted within an enclosure that is suitably designed for those specific environmental conditions that will be present and appropriately designed to prevent personal injury resulting from accessibility to live parts. The interior of the enclosure must be accessible only by the use of a tool. Subsequent sections of this publication may contain additional information regarding specific enclosure type ratings that are required to comply with certain product safety certifications.</p> <p>See NEMA Standards publication 250 and IEC publication 60529, as applicable, for explanations of the degrees of protection provided by different types of enclosure. Also, see the appropriate sections in this publication, as</p>
--	---

well as the S500 User's manual for additional installation requirements pertaining to this equipment.

Before starting

Use this document as a guide for installing and powering-up your AC500 PLC. You should already be familiar with the system components.

How to handle AC500 components

 ATTENTION	Preventing Electrostatic Discharge This equipment is sensitive to electrostatic discharge, which can cause internal damage and affect normal operation. Follow these guidelines when you handle this equipment: <ul style="list-style-type: none">• Touch a grounded object to discharge potential static.• Wear an approved grounding wrist strap.• Do not touch connectors or pins on component boards.• Do not touch circuit components inside the equipment.• If available, use a static-safe workstation.• When not in use, store the equipment in appropriate static-safe packaging.
--	---

Make sure that you have all the components you need

To use the AC500 PLC (in our example CPU PM581-ETH) you should use at least the following parts:

Part Number	Designation
1SAP 1121 00 R0170	TB521-ETH Terminal Base for CPU with 2 coupler slots
1SAP 1401 00 R0170	PM581-ETH CPU
1SAP 1806 00 R0001	TA524 Dummy coupler module to cover the unused coupler slots
1SAP 1802 00 R0001	TK501 Programming Cable D-Sub / D-Sub

Optional:

Part Number	Designation
1SAP 1803 00 R0001	TA521 Lithium Battery
1SAP 1801 00 R0001	MC502 Memory SD-Card

You can use the following components to add additional I/O modules:

If you want use the following component(s):
<ul style="list-style-type: none"> to connect a digital 24 VDC sensor or actuator to the CPU ... 	DI524 (32 DI), DC522 (16DC), DC523 (24DC), DC532 (16DI/16DC) or DX522 (8DI/8 DO-R) with the corresponding terminal unit with screw or spring connection TU515/516 or TU531/532
<ul style="list-style-type: none"> to connect a 115-230 VAC sensor or actuator to the CPU ... 	DX531 (8DI 115-230 V AC / 4 DO-R) + corresponding Terminal Unit TU531/532 with screw or spring technology
<ul style="list-style-type: none"> to connect an analog 24 VDC sensor or actuator to the CPU ... 	AI523 (16AI U/I/PT100), AO523 (16AO), AX521 (4AI/4AO U/I/PT100) or AX522 (8AI/8AO U/I/PT100) + corresponding Terminal Unit TU515/516
<ul style="list-style-type: none"> to label the I/O channels ... 	TA523 (Pluggable Marking Holder) + TA525 Set of Plastic Markers

The following components are recommended for fieldbus communication:

If you want use the following component(s):
<ul style="list-style-type: none"> the system to act as a master on PROFIBUS DP, DeviceNet or CANopen fieldbuses ... 	CM572-DP for PROFIBUS DP, CM575-DN for DeviceNet or CM578-CN for CANopen
<ul style="list-style-type: none"> the system to act as a slave on PROFIBUS DP, DeviceNet or CANopen fieldbuses ... 	FieldBusPlug standard plugs like PDP22-FBP (PROFIBUS DP slave) or DNP21-FBP (DeviceNet) or other one's
<ul style="list-style-type: none"> to exchange data via the network ... 	CM577-ETH to achieve Ethernet TCP/IP communication with integrated 2-ports switch

System planning

Consider the following when planning your AC500 system:

- The AC500 PLC consists of a CPU Terminal Base TB5xx (from 1 to 4 coupler slots) and a pluggable CPU. Three different CPU classes are offered: from PM571 with 64kB memory up to PM591 with 4MB memory; available also with integrated Ethernet coupler.
- Proper CPU Terminal Base selection requires that sufficient slots are available for all current or future network and fieldbus communication modules (e.g. Ethernet, ARCNET, PROFIBUS, etc.) if required.
- Up to 4 communication couplers can be connected to the CPU through the dedicated CPU terminal base.
- All types of external communication couplers can be used together in the same time but only up to 4 external couplers in total (e.g. a mix of coupler types like Ethernet + Ethernet + Profibus DP + CANopen, etc ...).
- The total number of communication couplers (internal + external) is limited to 5.
- The CPU terminal base is always the left-most device in the system.
- An external 24 Vdc power supply has to be provided to the CPU Cluster; the additional I/O modules have to be installed to the right of the PLC module.
- The AC500 PLC module supports as many as 7 local I/O expansion modules.
- An additional process power supply has to be provided for the I/Os of each module. Each I/O expansion module can be powered with its own power supply (for isolation purposes) or the same power supply can also be used.
- One FieldBusPlug can be plugged directly into an AC500 PLC cluster

Steps for installation

√		Installation step:	Further information:
<input type="checkbox"/>	1	Snap the AC500 PLC Terminal Base onto DIN Rail or wall-mount with screws.	
<input type="checkbox"/>	2	Snap the additional Terminal Units for I/O modules onto DIN Rail (optional) or screw them (wall mounting).	
<input type="checkbox"/>	3	Make the sensor/actuator wire connections according to the dedicated Electronic module you want to use. Provide external process power supply as required.	(*)
<input type="checkbox"/>	4	If required, make the fieldbus connections according to the dedicated master coupler module you want to use.	(*)
<input type="checkbox"/>	5	Plug the appropriate electronic and I/O modules in the correct locations (CPU module, communication couplers on TB, and eventually also I/O modules onto dedicated TUs).	
<input type="checkbox"/>	6	Install the battery and the memory SD card; this is optional and the CPU is able to run without them.	
<input type="checkbox"/>	7	If required, make the FBP fieldbus slave connection according to the chosen FBP and use the dedicated FBP accessories (cables, master cable to M12, line termination, power supply connector, etc...).	(**)
<input type="checkbox"/>	8	If required, plug the FBP-Plug on the M12 connector located on the CPU Terminal Base of the AC500 PLC.	
<input type="checkbox"/>	9	Connect a programming cable (e.g. TK501 in COM2/PLC and COM1/PC; TK502 is necessary for COM1/PLC) on the PC and on the AC500 PLC.	
<input type="checkbox"/>	10	Set the power on (process power supply first and PLC power supply).	
<input type="checkbox"/>	11	If required, set the an address for the integrated Ethernet communication interface by using the front face LCD Display + keyboard of the CPU module (see the dedicated chapter of the user's manual).	
<input type="checkbox"/>	12	Install the AC500 Control Builder programming software on your PC. If required, also copy the appropriate EDS/GSD files into the Fieldbus configurator (AC500 Control Builder) to manage the possible fieldbus slave modules connected to the AC500 master couplers.	(*)
<input type="checkbox"/>	13	Program the hardware configuration.	

(*) Refer to the AC500 hardware description for proper wiring and addressing information.

(**) Refer to the Installation Instructions for the particular FBP devices. Follow appropriate fieldbus practices outline by the conventions and standards of each protocol used in the system.

Assembling the system



WARNING

The AC500 modules are not designed for removal or insertion under power. Because of unforeseeable consequences, it is not allowed to plug or unplug modules with the power being ON.

Disconnecting the FBP or any powered modules while energized in a hazardous location could result in an arc, which could create a flammable ignition resulting in a fire or explosion.

Be sure that power is removed and that an area has been thoroughly checked to insure that flammable materials are not present prior to proceeding.

Using S500 I/O Modules

The S500 I/O modules could be used either directly connected to an AC500 CPU (central expansion) or together with an FBP Interface Module DC505-FBP + an FBP (PROFIBUS DP, DeviceNet, etc.) as decentralized expansion.

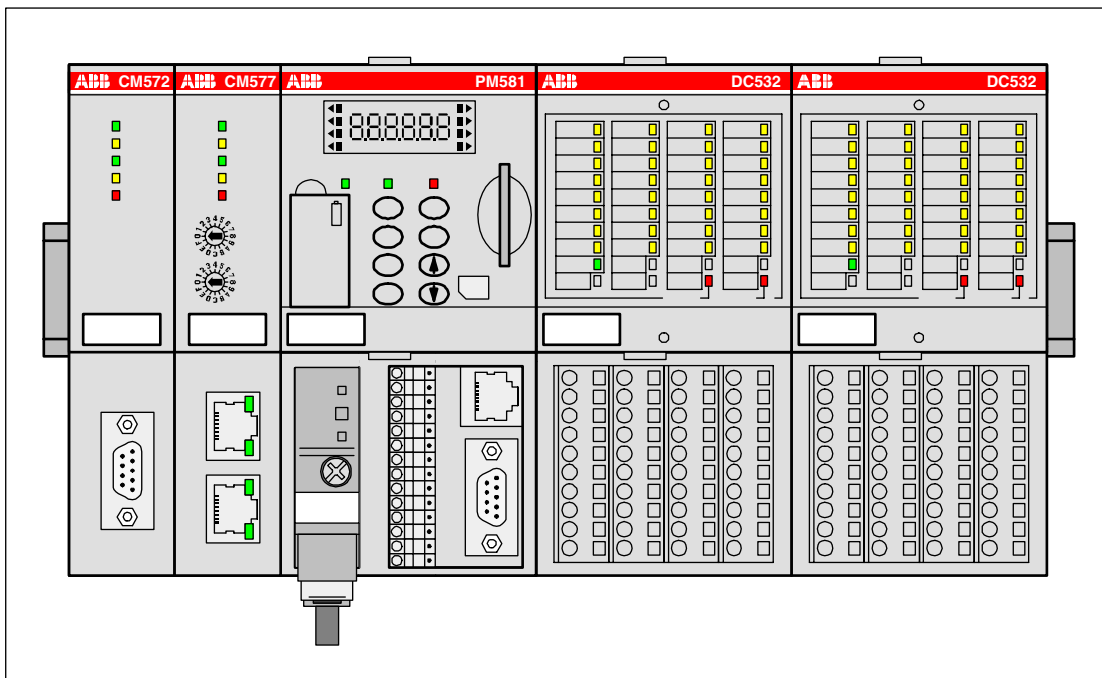

Figure: S500 I/O modules directly connected to an AC500 CPU (central I/O expansion)

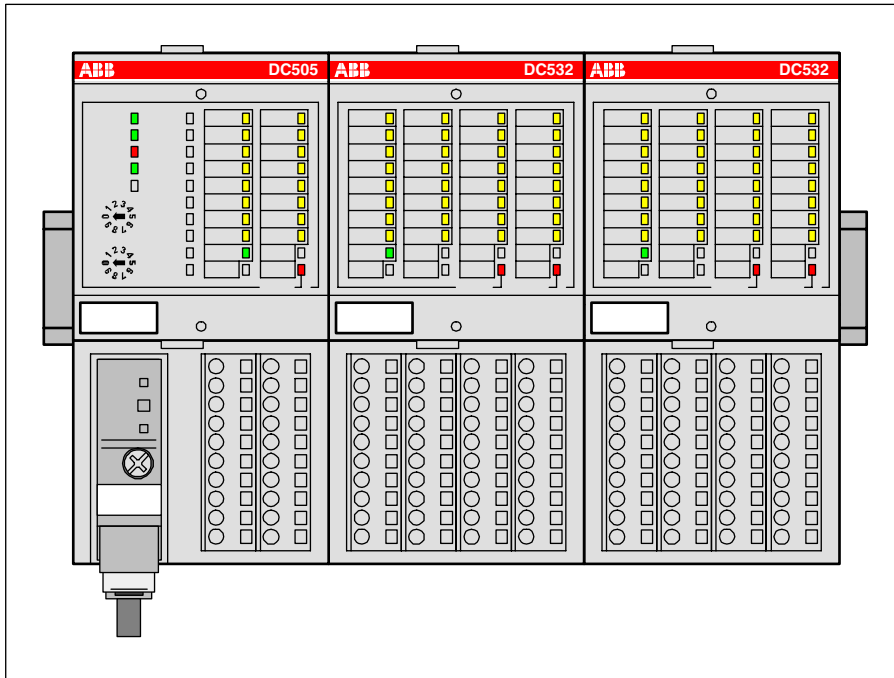

Figure: S500 I/O modules connected to an FBP Interface Module DC505-FBP with an FBP (decentralized expansion)

Minimum spacing

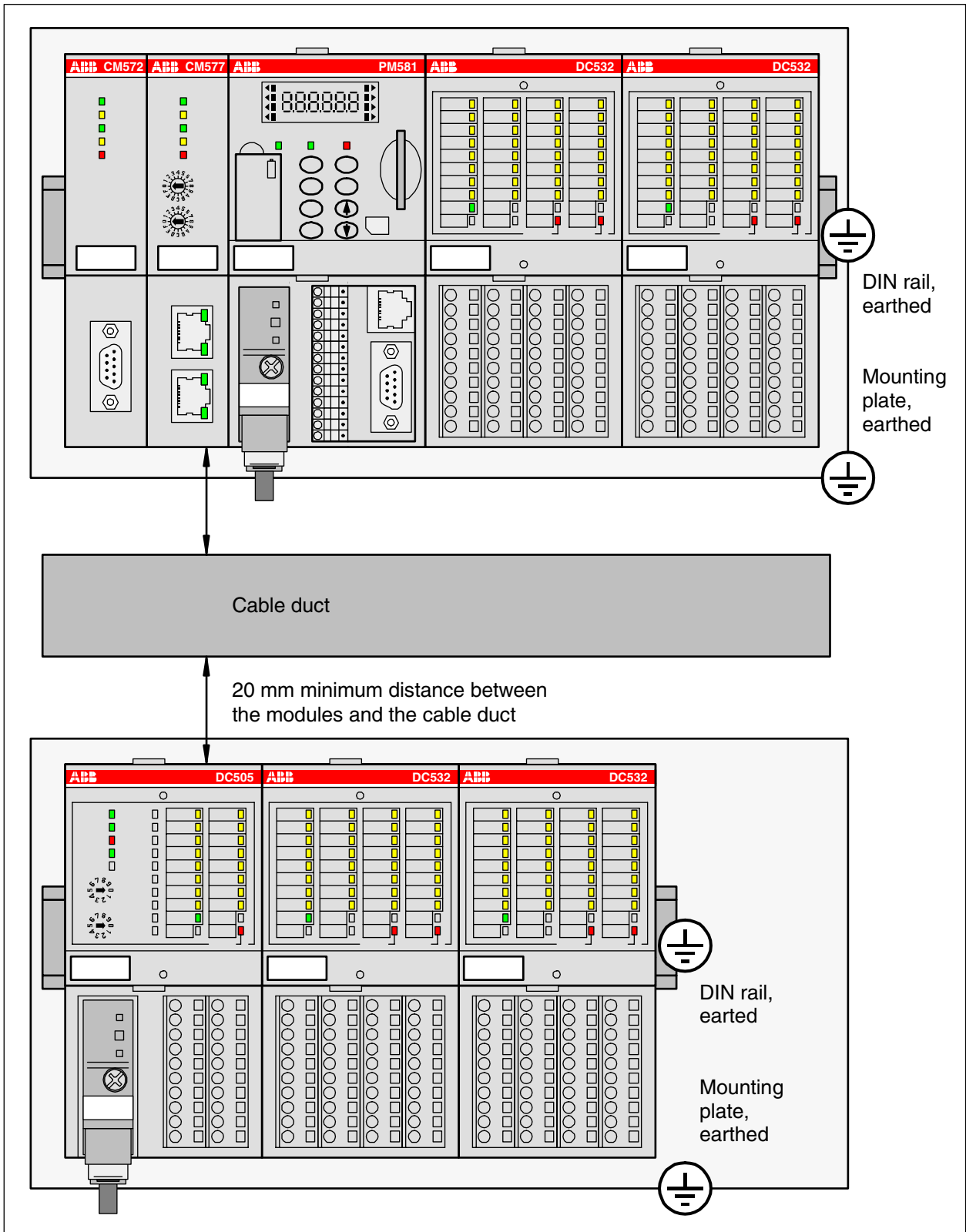

Figure: AC500/S500 module mounting into cabinets

Maintain spacing from enclosure walls, wireways, adjacent equipment, etc. Allow minimum 20 mm (1 in.) of space on all sides, as shown. This provides ventilation and electrical isolation.



Important: Horizontal mounting is highly recommended. Vertical mounting is possible, however, derating consideration should be made to avoid problems with poor air circulation and the potential for excessive temperatures (see also the AC500 system data, operating and ambient conditions, for reduction of ambient temperature).



Note: By vertical mounting, always place an end-stop terminal block (e.g. type BADL, P/N: 1SNA399903R0200) at the bottom and on the top of the modules to properly secure the modules.

By high vibration applications and horizontal mounting, we also recommend to place end-stop terminals at the right and left side of the device to properly secure the modules, e.g. type BADL, P/N: 1SNA399903R0200.

Insertion / replacement of the Lithium battery

The CPU is shipped without a battery. Please order the TA521 lithium battery separately. The battery is used to retain data stored in the user's RAM and in the Real Time Clock. Although the CPU can be used without any battery, it is recommended to install it to avoid process data loss.

The CPU monitors the battery status. A low battery error is output before the battery condition becomes critical (about 2 weeks before). After the error message appears, the battery should be replaced as soon as possible.



ATTENTION

The TA521 Lithium Battery is the only one, which can be used with AC500 CPUs.

The following procedures describe the insertion / replacement of the Lithium battery.

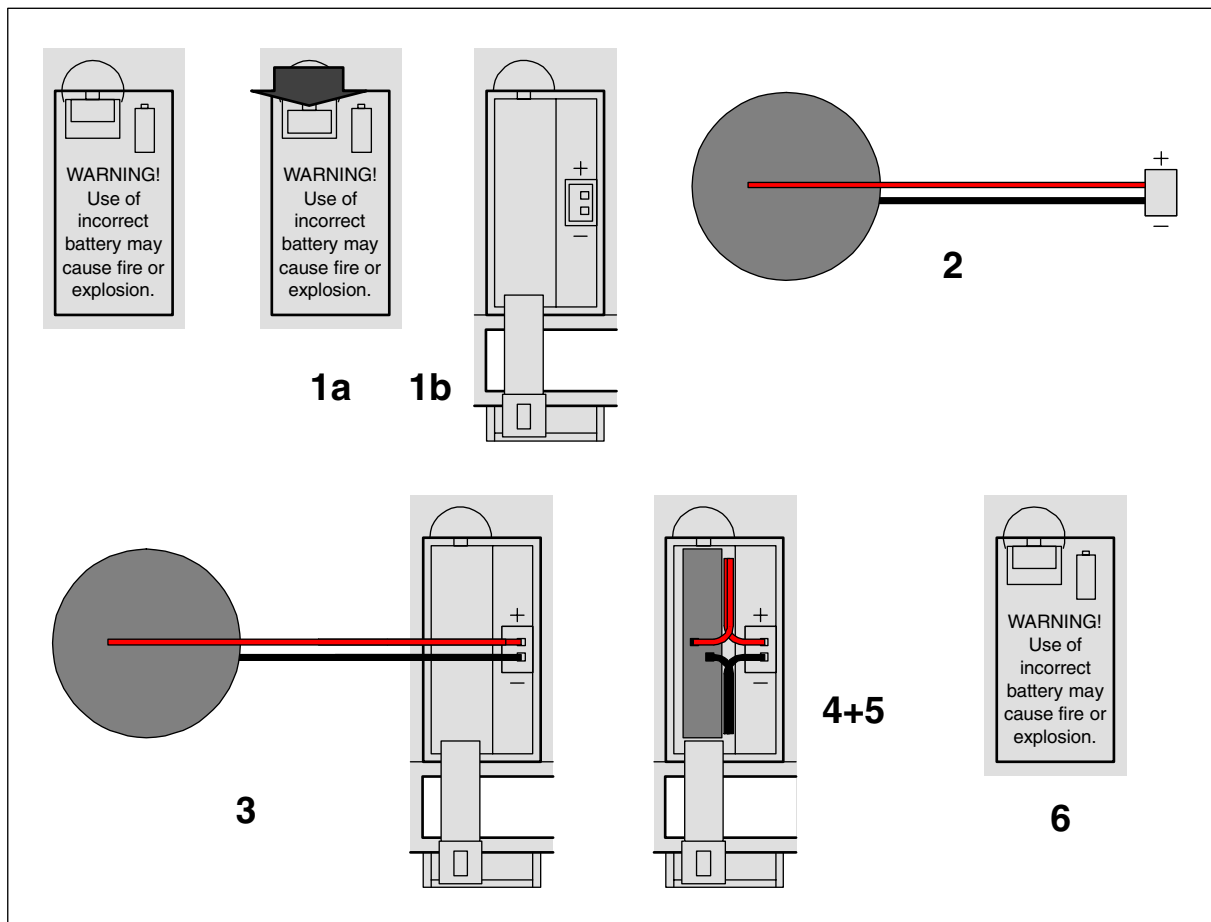



Figure: Insertion / replacement of the Lithium battery

Insertion of the battery:

1. Open the battery compartment by inserting a fingernail in the small locking mechanism, press it down and slip down the door. The door is attached to the front face of the CPU and cannot be removed!
2. Remove the TA521 battery from its package and hold it by the small cable.
3. Insert the battery connector into the small connector port. The connector is keyed to find the correct polarity (red = plus pole = above).
4. Bend the cable and insert first the cable and then the battery into the compartment, push it until it reaches the bottom of the compartment.
5. Arrange the cable in order not to inhibit the door to close.
6. Pull-up the door and press until the locking mechanism snaps.

 NOTICE	In order to prevent data losses or problems, the battery should be replaced after 3 years of utilisation or at least as soon as possible after receiving the "Low battery Warning" indication. Don't use a battery older than 3 years for replacement. Do not keep batteries too long in stock.
---	---

Replacement of the battery:

 ATTENTION	In order to avoid any data losses (if needed), the battery replacement should be done with the system under power. Without battery and power supply there is no data buffering possible.
--	--

1. Open the battery compartment by inserting a fingernail in the small locking mechanism, press it down and slip down the door. The door is attached to the front face of the CPU and cannot be removed.
2. Remove the old TA521 battery from the battery compartment by pulling it by the small cable. Remove then the small connector from the socket, do this best by lifting it out with a screwdriver (see photo).



3. Follow the previous instructions to insert a new battery.

 ATTENTION	Lithium batteries must not be re-charged, not be disassembled and not be disposed of in fire. They must be stored in a dry place. Exhausted batteries must be recycled to respect the environment.
--	--

Please refer to chapter "Hardware/Accessories/TA521" for the technical data sheet of the Lithium battery TA521.

Insertion of the SD memory card

AC500 CPUs are supplied without an SD Memory Card. It therefore must be ordered separately. The SD Memory Card is used to back-up user data and store user programs or project source codes as well as to update the internal CPU firmware. AC500 CPUs can be operated with and without SD Memory Cards.

The CPU uses a standard file system, which allows the MC502 SD Memory card to be read with a standard memory card reader.



ATTENTION

The use of memory cards other than the MC502 SD Memory Card is prohibited. ABB is not responsible nor liable for consequences resulting from use of unapproved memory cards.



ATTENTION

In operation, the plugged-in SD Memory Card withstands vibrations up to 1 g. Without using an SD Memory Card, the CPU itself withstands vibrations up to 4 g.

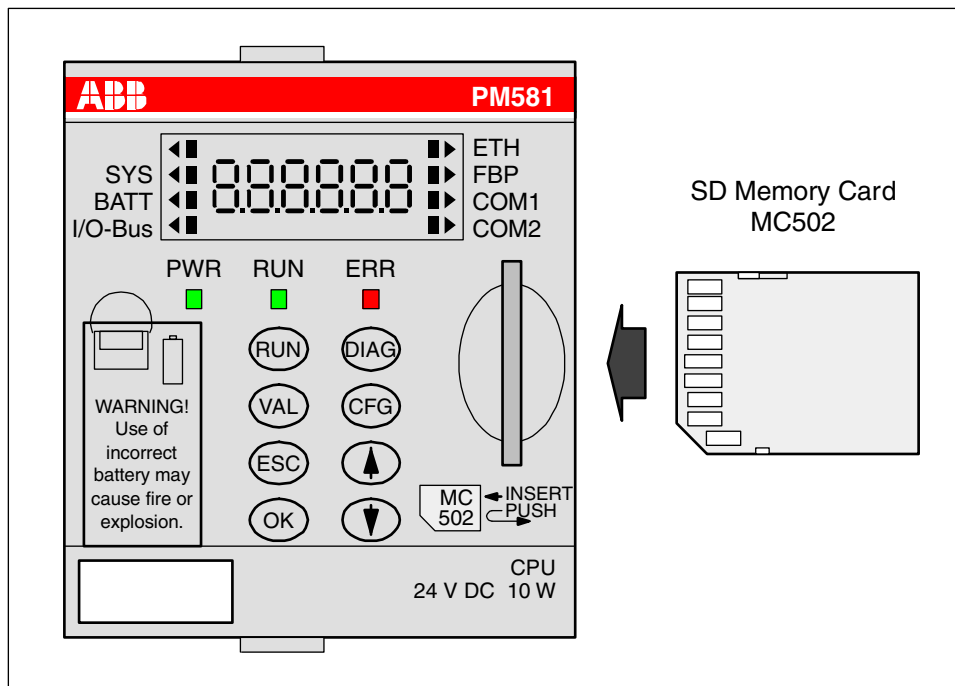

Figure: Insertion of the SD Memory Card

To insert the SD Memory Card, follow the procedure shown below.

1. Remove the SD Memory Card from its package.
2. Insert the memory card into the opening of the front face of the CPU with the memory card aligned as shown above (contacts are visible on the left side, bevelled edge below).
3. Push on the card until it moves forward, then release your pressure, the SD card comes slightly backward and it locks into the SD card slot.

Removing the SD Memory Card

To remove the card, first push on the card until it moves forward (that unlocks the card), then release your pressure, the card will go forward out of the slot and can be easily removed.

The technical data sheet for the SD Memory Card can be found in the chapter "Hardware / Accessories / SD Memory Card MC502".

Mounting the System



ATTENTION

During panel or DIN rail mounting of all devices, be sure that all debris (metal chips, wire strands, etc.) is kept from falling into the controller. Debris that falls into the controller could cause damage while the controller is energized.

Mounting and Demounting of the Terminal Base, the Terminal Unit and the Electronic Modules

Mounting on DIN rail

Step 1: Install the 7.5 mm or 15 mm DIN Rail

Step 2: Snap the AC500 Terminal Base (TB5xx)

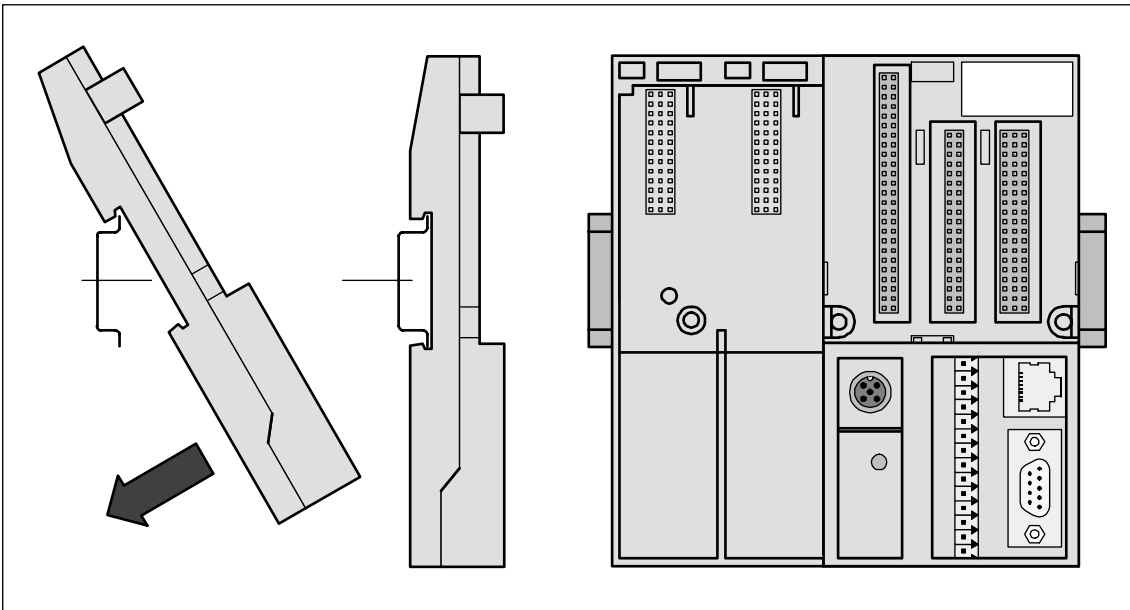

Figure: Mounting of the AC500 Terminal Base (TB5xx)

The AC500 Terminal Base will be placed on top of the DIN Rail and then snapped on the bottom. Follow the reverse order to disassembly.

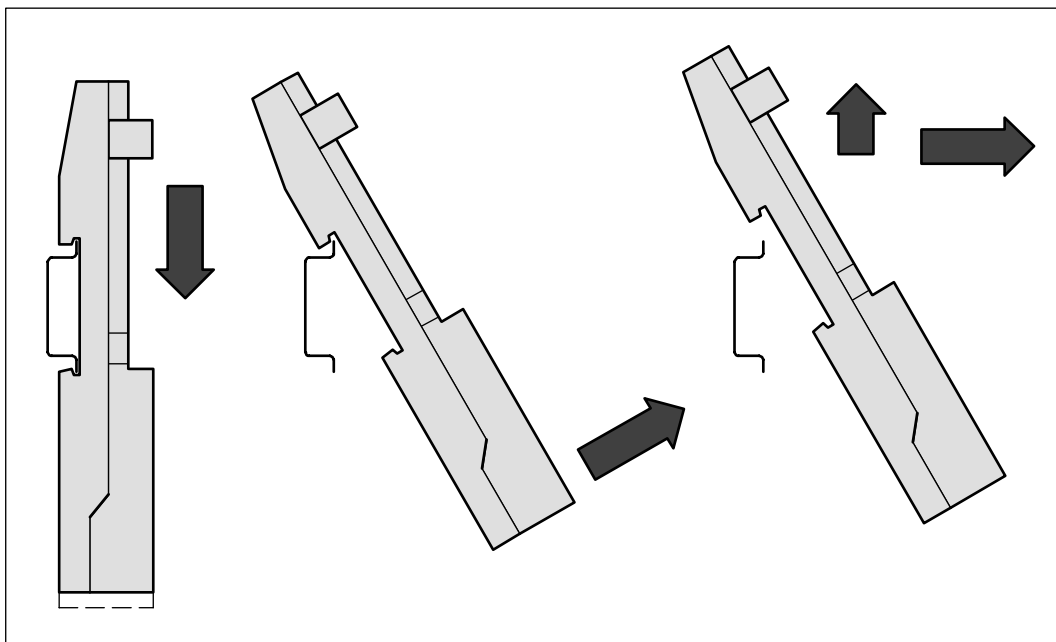

Figure: Disassembly of the CPU Terminal Base (TB5xx) or Terminal Unit (TU5xx)

Step 3: Mounting of the I/O Terminal Unit (TU515, TU516, TU531 or TU532) to the CPU Terminal Base

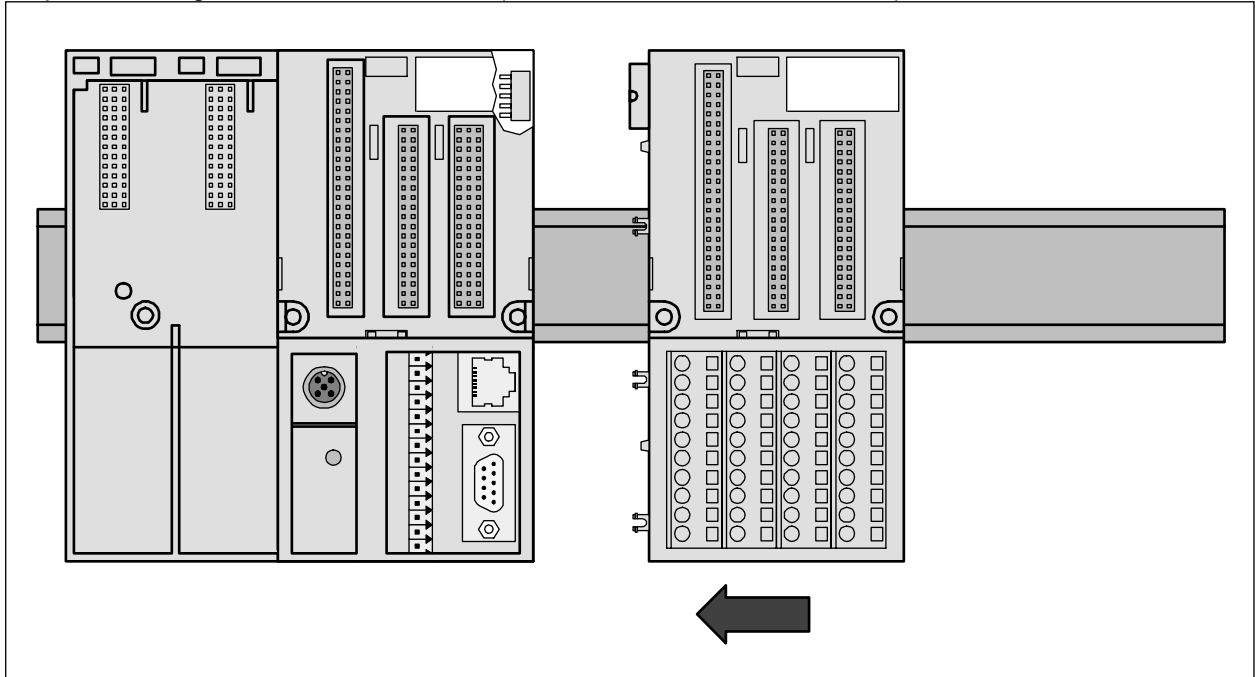

Figure: I/O Terminal Unit assembly (TU515, TU516, TU531 or TU532)

The I/O Terminal Unit is snapped into the DIN rail in the same way as the Terminal Base. Once secured to the DIN rail, slide the I/O unit to the left until it fully locks into place creating a solid mechanical and electrical connection.

Up to 7 I/O Terminal Units could be combined with a CPU Terminal Base.



ATTENTION

When attaching the CPU Terminal Base and I/O modules, make sure the bus connectors are securely locked together to ensure proper electrical connection.

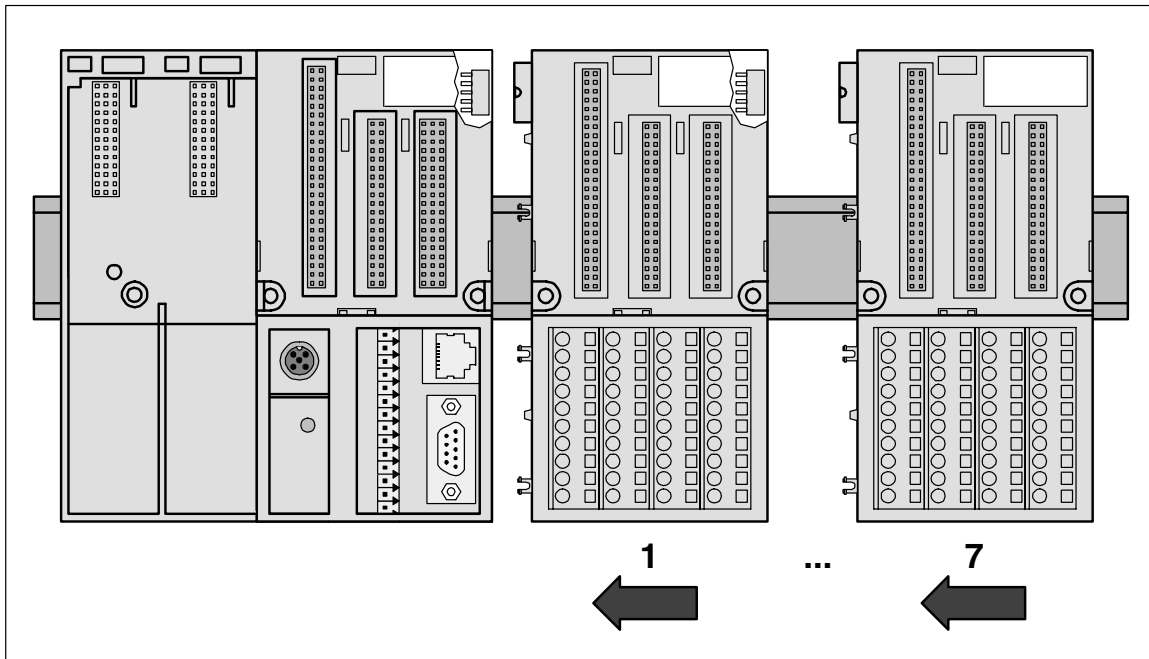

Figure: Maximum configuration (1 CPU Terminal Base plus 7 I/O Terminal Units)

Disassembly of a Terminal Unit

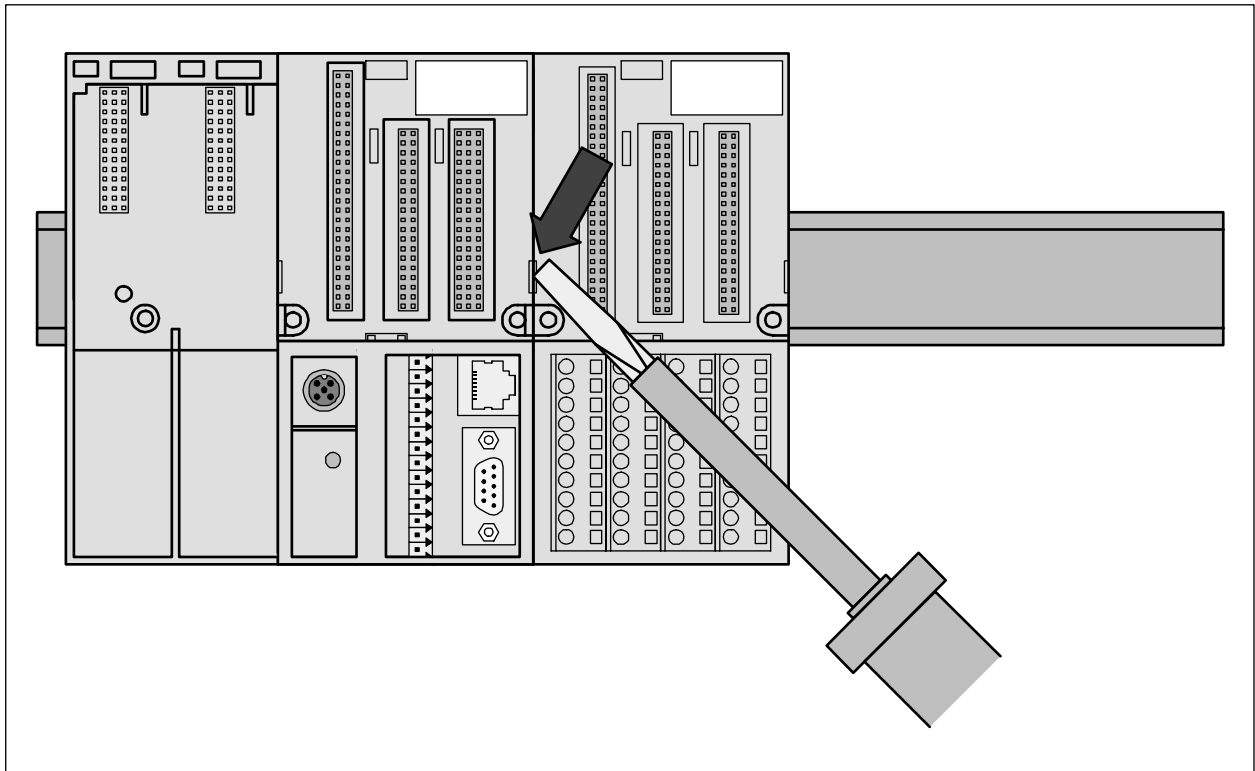

Figure: CPU Terminal Base (TB5xx) or I/O Terminal Unit disassembly (TUxx)

A screwdriver is inserted in the indicated place to separate the Terminal Units.

Step 4: CPU or Electronic Module assembly

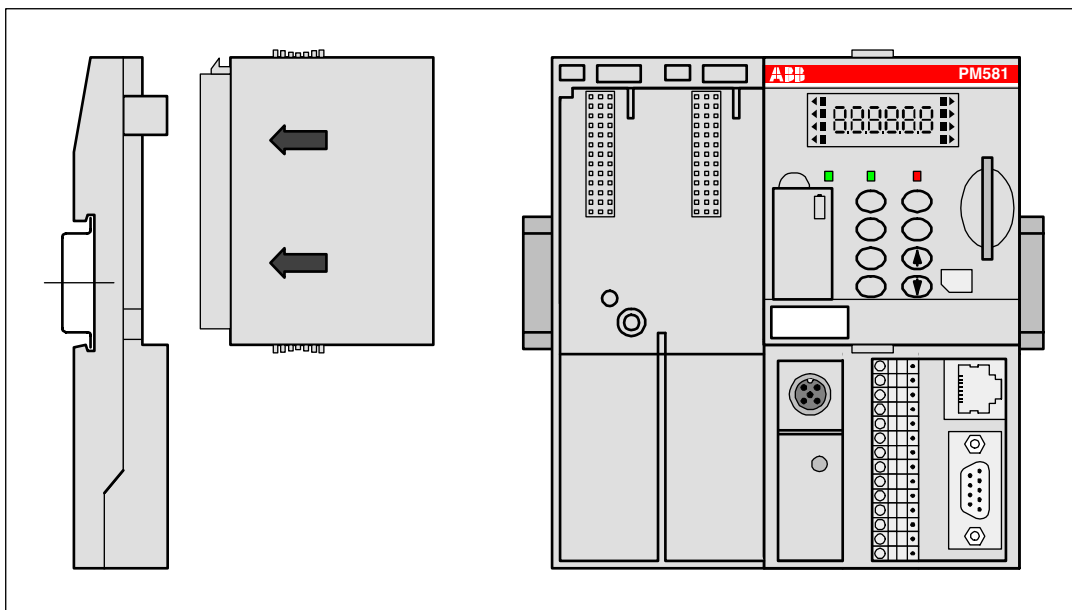

Figure: Mounting of the CPU (PM5xx) on a Terminal Base (TB5xx), in the same way as I/O modules on Terminal Units

The CPU or I/O module will be plugged on the dedicated Terminal Base / Terminal Unit. And will be locked in place. The disassembly is done in reverse order.

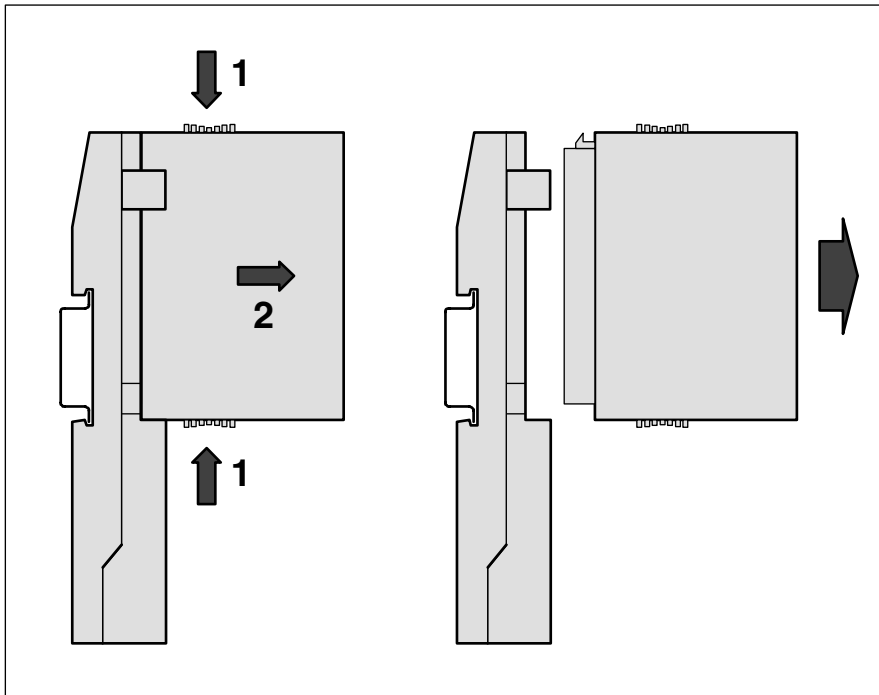

Figure: CPU / I/O Module disassembly

For disassembly, press top and bottom, then pull out the CPU / I/O module.

Step 5: Communication Couplers on Terminal Base assembly

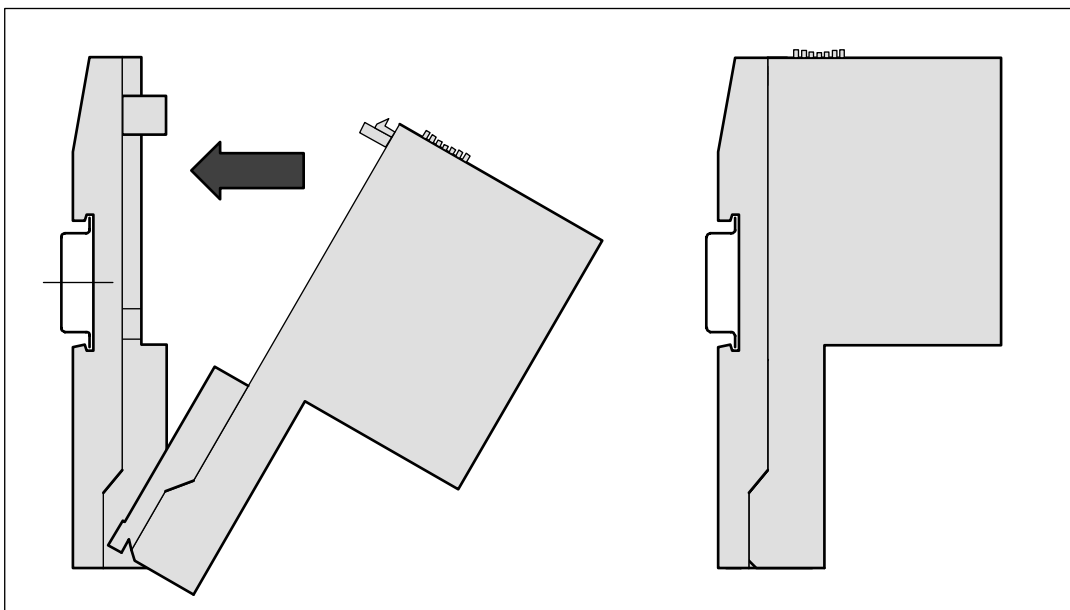

Figure: Mounting of a communication coupler (CM5xx) on a CPU Terminal Base (TB5xx)

First insert the bottom nose of the communication Coupler module into the dedicated holes of the Terminal Base and then rotate the coupler until it will be plugged on the dedicated Terminal Base slot, push to be sure that the connection is well done. It will be locked in place.

The disassembly is done in reverse order.

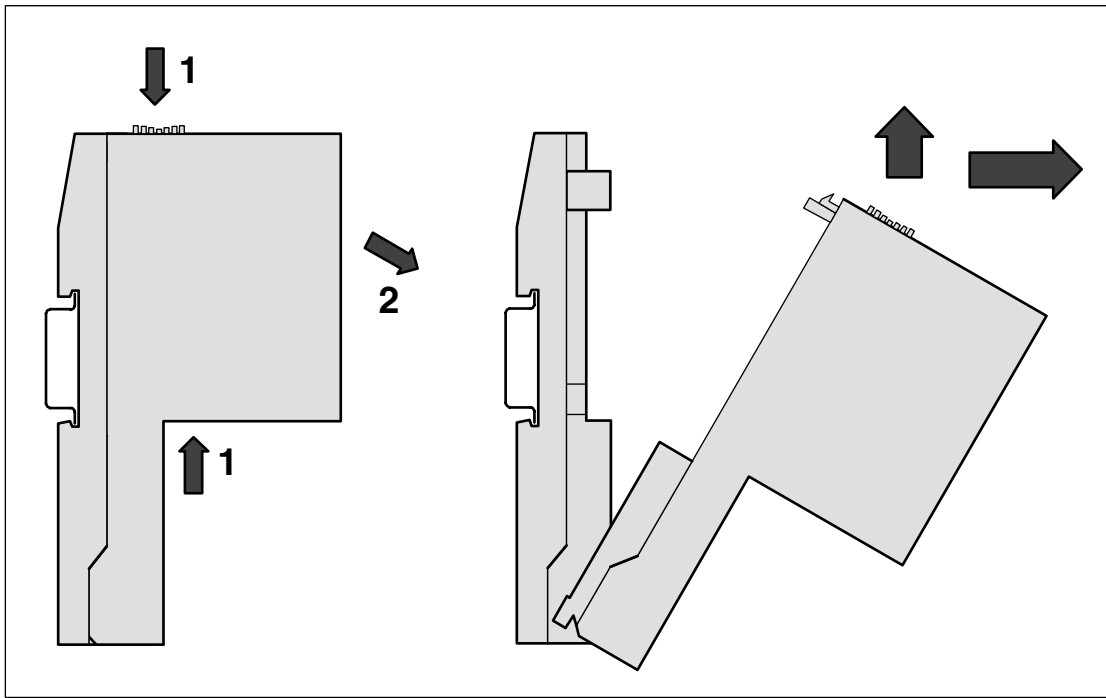

Figure: Communication coupler module disassembly

Disassembly: Press Top and Bottom, then rotate the coupler module and pull it out.

Panel mounting

If the CPU Terminal Base should be mounted with screws, Wall Mounting Accessories TA526 must be inserted at the rear side first. These plastic parts prevent bending of the Terminal Base while screwing on. TB511 needs one TA526, TB521 and TB541 need two TA526.

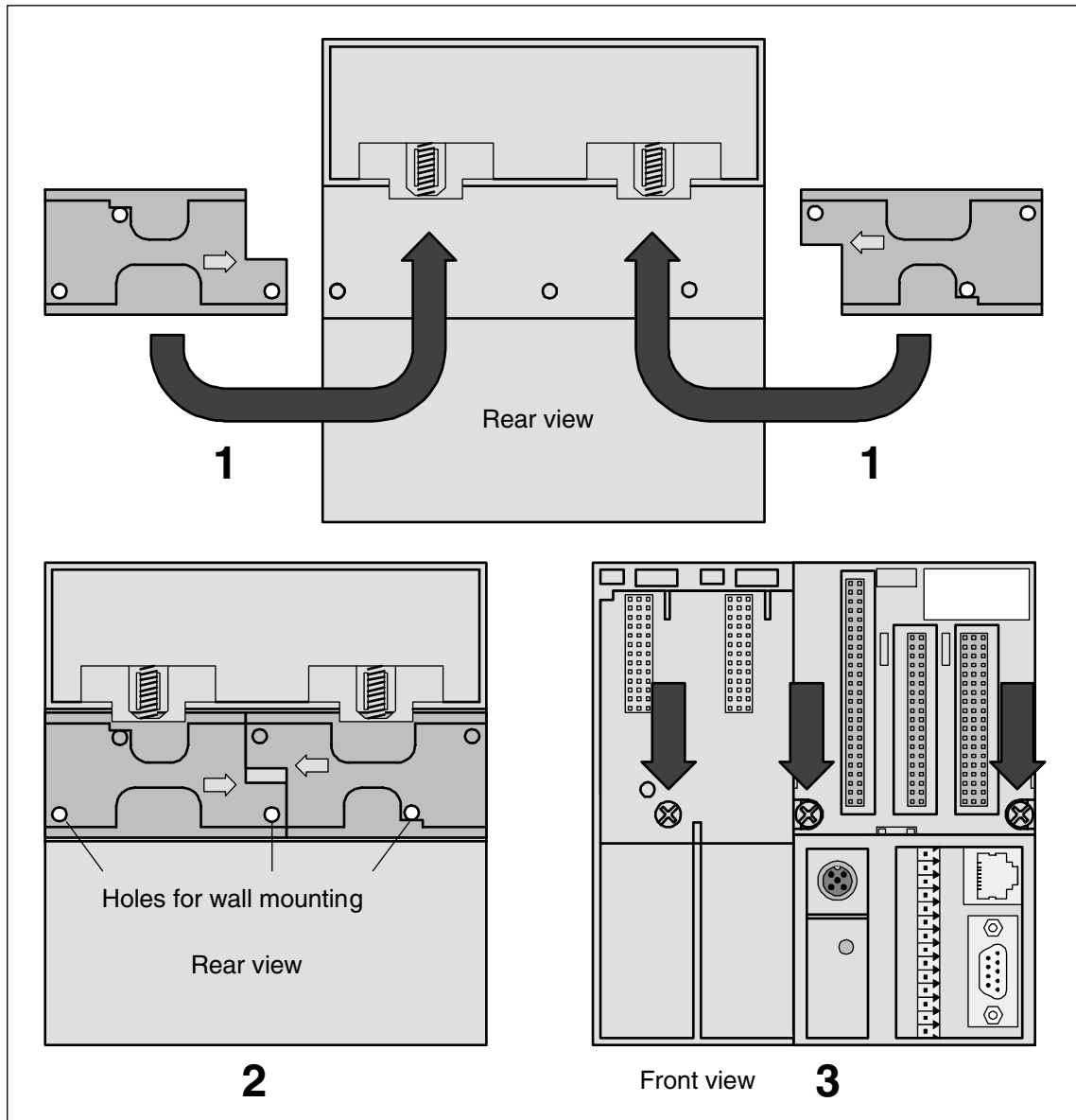

Figure: Fastening with screws of the Terminal Base TB521-ETH (as an example)

1 The two Wall Mounting Accessories TA526 are snapped on the rear side of the CPU Terminal Base like DIN rails. The arrows point to the middle of the CPU Terminal Base. One TA526 is turned by 180°.

2 Two accessories for wall mounting inserted

3 CPU Terminal Base, fastened with screws. Use two screws per module (three for the TB). Use M4 or #8 pan head screws. Mounting screws are required on every module.

By wall mounting, the CPU Terminal Base is earthed through the screws. It is necessary that

- the screws have a conductive surface (e.g. steel zinc-plated or brass nickel-plated)
- the **mounting plate is earthed**
- the screws have a good electrical contact to the mounting plate

The following procedure allows you to use the assembled modules as a template for drilling holes in the panel. Due to module mounting hole tolerance, it is important to follow these procedures:

1. On a clean work surface, assemble no more than three modules (e.g. one TB + two TUs).
2. Using the assembled modules as a template, carefully mark the center of all module-mounting holes on the panel.
3. Return the assembled modules to the clean work surface, including any previously mounted modules.
4. Drill and tap the mounting holes for the recommended M4 or #8 screw.
5. Place the modules back on the panel and check for proper hole alignment.
6. Attach the modules to the panel using the mounting screws.

TIP: If mounting more modules, mount only the last one of this group and put the others aside. This reduces remounting time during drilling and tapping of the next group.

7. Repeat steps 1 to 6 for any remaining modules.

Grounding considerations

This product is designed to be mounted to a well-grounded mounting surface such as a metal panel. Additional grounding connections from the AC500 mounting tabs or DIN rail (if used), are not required unless the mounting surface cannot be grounded. Refer to appropriate Chapter of the S500-FBP User's Manual, for additional information.

 ATTENTION	<p>This product is grounded through the DIN rail to chassis ground. Use zinc plated yellow-chromate steel DIN rail to assure proper grounding. The use of other DIN rail materials (e.g. aluminium, plastic, etc.) that can corrode, oxidize, or are poor conductors, can result in improper or intermittent grounding.</p>
--	---

AC500 System dimensions

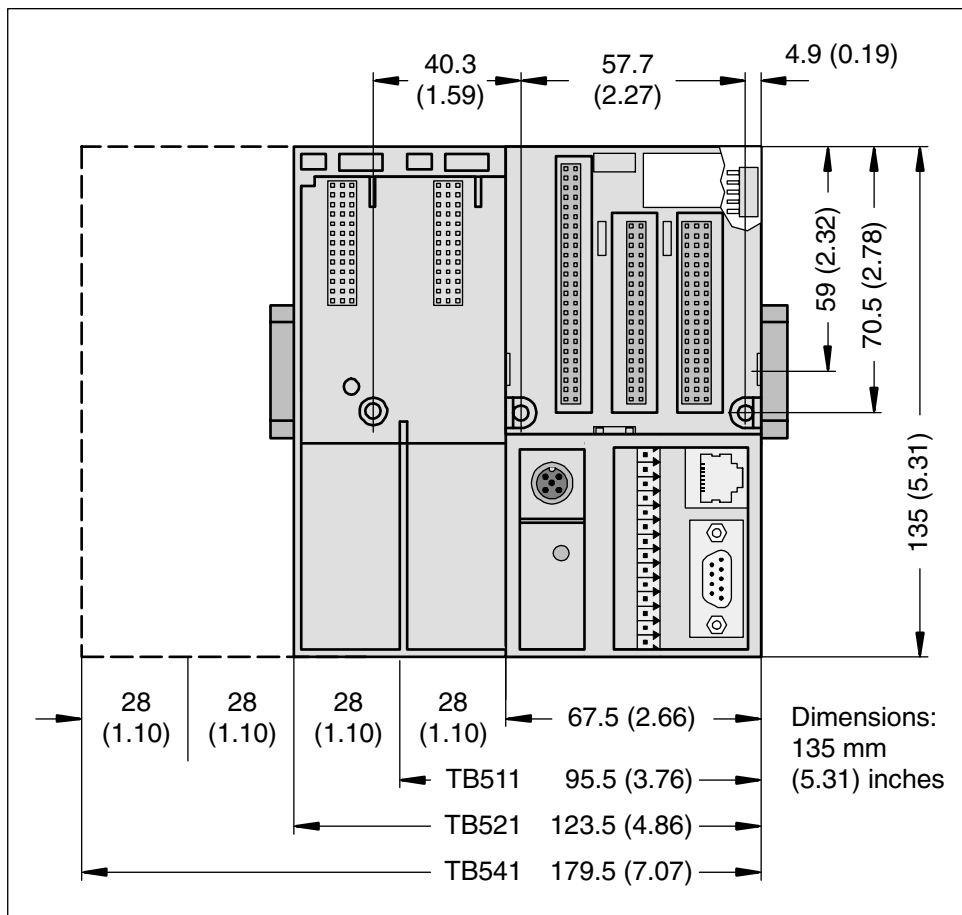

Figure: Dimensions of the CPU Terminal Bases (front view)

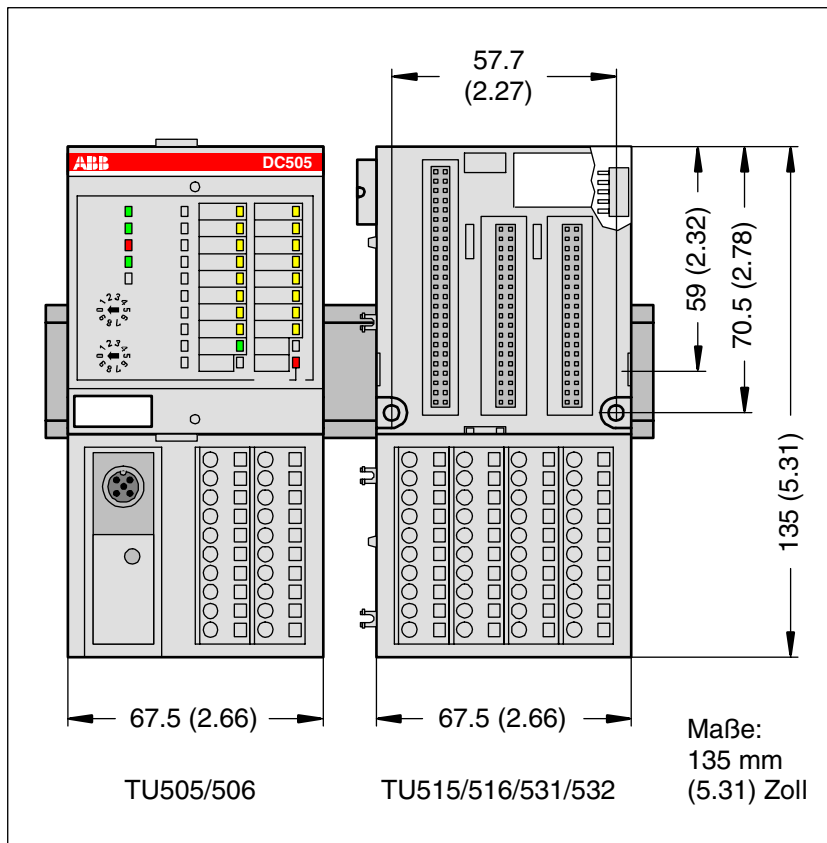
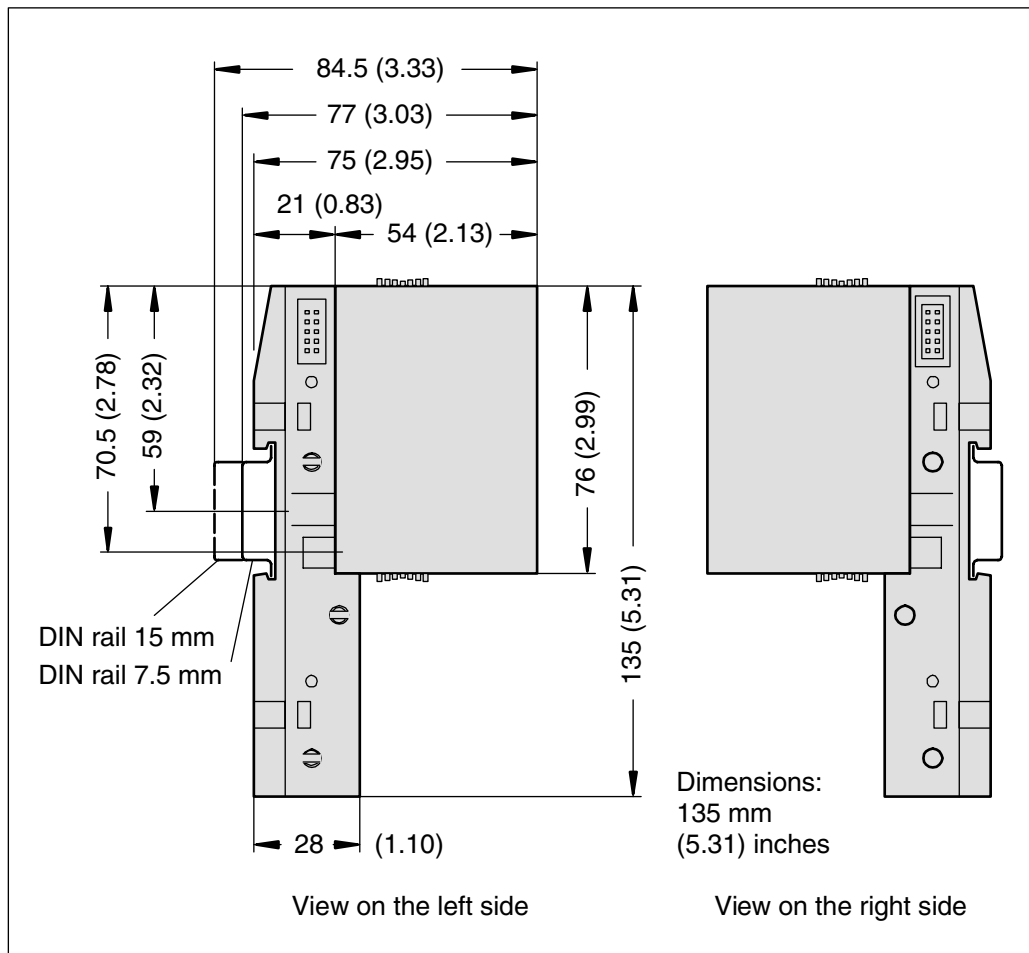

Figure: Dimensions of the Terminal Unit (front view)



Note: All dimensions are in mm (in.). Hole spacing tolerance: ± 0.4 mm (0.016 in.)

Setting of the Slave Address of the FBP plug onto the AC500 CPU (if needed, but not recommended)

Normally the FBP slave address is set using the AC500 Control Builder. Nevertheless it is possible to set this address using the CPU.

The FieldBusPlug must have a properly assigned slave module address. The AC500 CPU gives them an address at system power-up. The address can be set with the use of the display and the pushbutton on the top of the module.

! Attention: The **local** setting of an FBP address by means of pushbuttons and display has a higher priority than an FBP address configured by the AC500 Control Builder!

The locally set address replaces the address configured by the software.

It is highly recommended to be extremely careful when modifying the address locally, because it has high influence on the behaviour of the application.

Up to 99 addresses can be then set with the display.

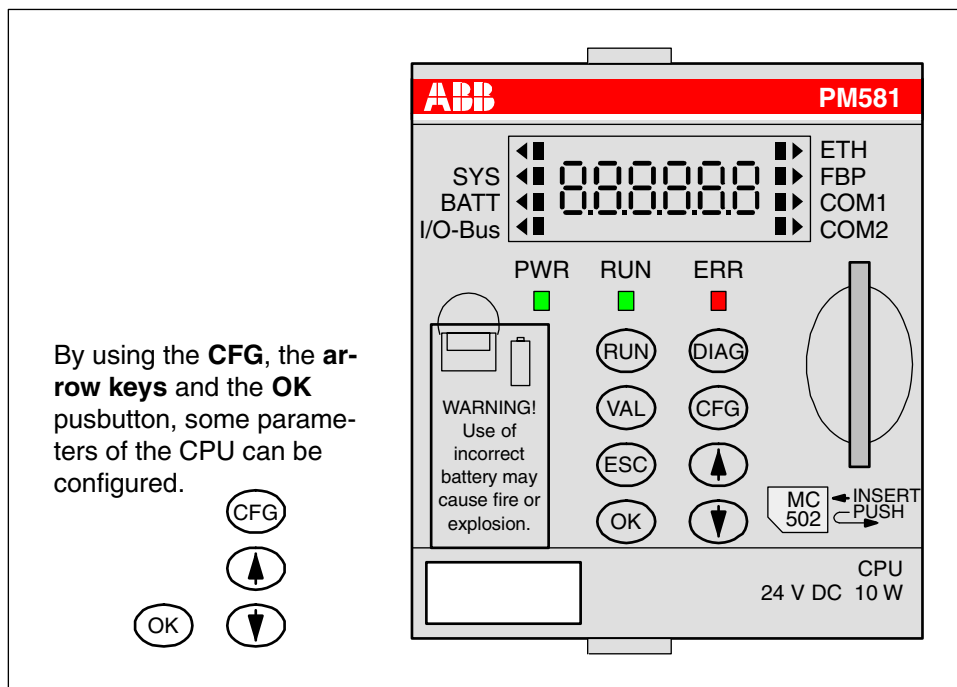









Figure: Configuration on the CPU

To configure the FBP address, please follow the procedure described below:

<p>1. First select the item to be configured by pressing the CFG key, the CPU changes to configuration mode and a small triangle is displayed on the LCD on the first right up position of the display beside the ETH inscription and the already configured address is displayed.</p> <p>Press one time more the CFG key to move the triangle to the position below "FBP". The FBP is then selected, and the current address is shown.</p>		<p>SYS BATT I/O-Bus</p> <p>Ad-000</p> <p>ETH FBP COM1 COM2</p>
<p>2. Press then the arrow keys UP or DOWN to increase or decrease the address, the modified value blinks to indicate that it differs from the previously stored one.</p>	 	<p>SYS BATT I/O-Bus</p> <p>Ad-002</p> <p>ETH FBP COM1 COM2</p>
<p>3. Once the desired address is reached, press OK to accept and quit or only ESC to exit the menu without saving the changes. The CPU status is then displayed run/Stop.</p>	 or 	<p>SYS BATT I/O-Bus</p> <p>run</p> <p>ETH FBP COM1 COM2</p>

 ATTENTION	<p>If the FBP address set on the AC500 CPU module is different from those assigned into the Fieldbus configurator software of the Master device for that station, the station could not be accessed and the complete Fieldbus could not work properly or be completely down!</p>
 ATTENTION	<p>The modified address will only be valid after a Power OFF / Power ON!</p>

A AC500 CPU equipped with a FieldBusPlug is always a slave device on the bus. To act as a master, a AC500 CPU should be equipped with master couplers (e.g CM572-DP for PROFIBUS DP).

Make the Connection of the FieldBusPlug to the Fieldbus Master Device

The FieldBusPlug module has to be connected to the master device and the power supply has to be provided. Please use the dedicated accessories to the FBP used for the desired Fieldbus.

Refer to the FBP documentation for the installation instructions.

Status display and error indication on the AC500 CPU

All AC500 CPUs have LEDs and a LC Display for indicating operating statuses and errors. The following drawing shows the front face of a AC500 CPU.

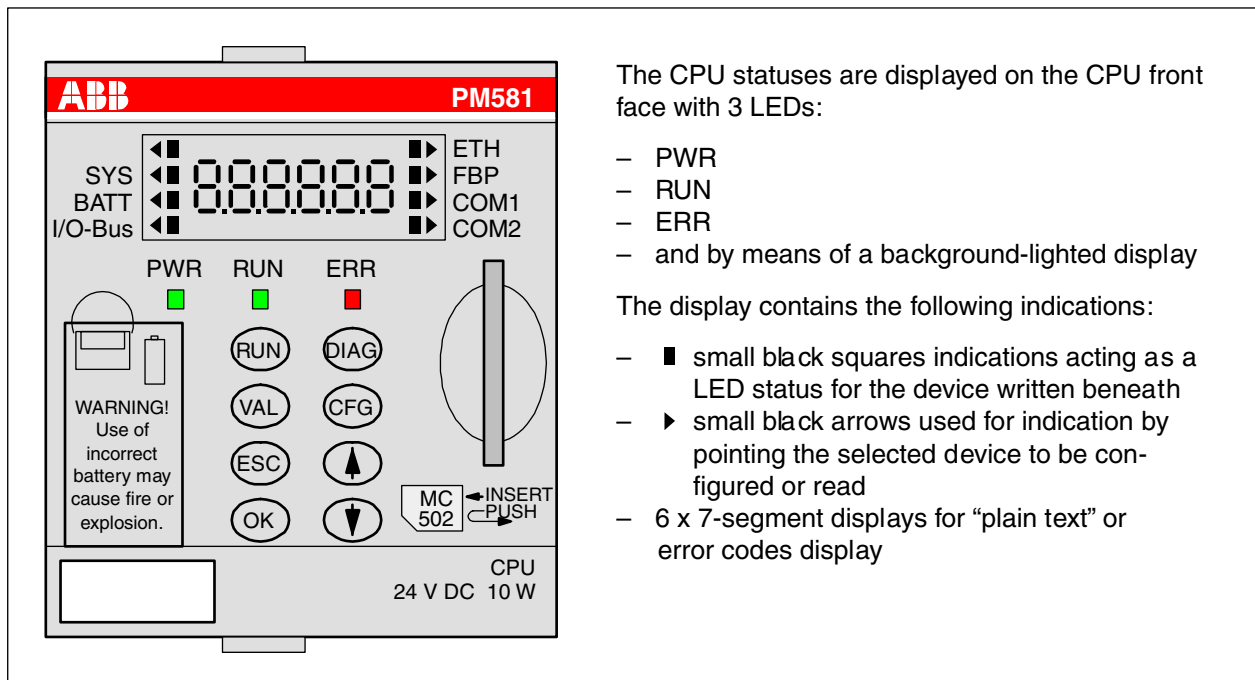

The CPU statuses are displayed on the CPU front face with 3 LEDs:

- PWR
- RUN
- ERR
- and by means of a background-lighted display

The display contains the following indications:

- ■ small black squares indications acting as a LED status for the device written beneath
- ► small black arrows used for indication by pointing the selected device to be configured or read
- 6 x 7-segment displays for "plain text" or error codes display

Figure: Front face of a AC500 CPU

The display's background lighting is normally switched off. The status of the CPU is shown as plain text "run" or "Stop", which reflects the operating status of the CPU program.

By pressing one of the dialog keys "**RUN, DIAG, CFG or VAL**", the background lighting is turned ON and the desired function is performed.

In case of a function error, the display background lighting is also switched on and an error code is displayed.

The meanings of the LEDs and the LCD display are listed in the following table:

AC500 CPU module LEDs

LED	Status	Color	LED = ON	LED = OFF	LED flashes
PWR	24 V DC power supply is provided	green	voltage is present	voltage is missing	--
RUN	activity status	green	CPU is in RUN mode	CPU is in STOP mode	If flashes fast (4 Hz): The CPU is reading/writing the SD card, indicates together with the blinking error LED that the CPU is writing the internal Flash EEPROM. If flashes slow (1 Hz): The firmware update from the SD card is finished without errors.
ERR	error indication	red	An error has occurred. The error type and code is displayed in the LC Display. The error codes can be shown by means of the DIAG and OK keys.	No errors are encountered or only warnings (E4 errors). This is configurable (by error 2 - 4, the LED behaviour is configurable).	Flashing fast (4 Hz): Indicates together with RUN a firmware update process and a Flash EEPROM write.
■	Working activity of the beneath described device (e.g. top right of the display ETH communication line).	black	Device is present and OK (e.g. the battery is present and OK).	No activity or device not present	Flashing according to the device activity, e.g. when data exchange on ETH, COM1, etc... communication lines.
► or ◄	Indicates the selected device to be read or configured. Acts as a cursor moving with the arrow ▲▼ keys	black	Points out the selected device of which the name is written beneath (e.g. top right of the display ETH communication line).	No device selected	--

Displaying error messages (error codes) on the AC500 CPU

When an error occurs, the red error LED goes on and an error message is displayed in the LC Display.

By pressing the **DIAG** key, the complete error code can be shown and an acknowledgement of the error can be performed.

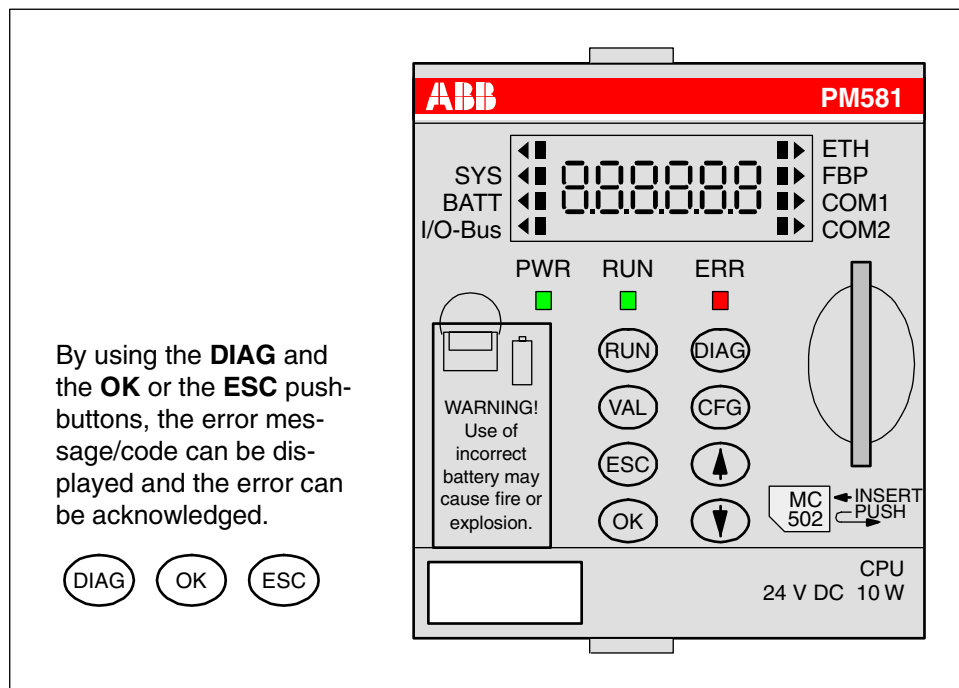

Figure: Error display on the CPU

The AC500 CPU can display various errors according to the error classes. The following error classes are possible. The reaction of the CPU is different for each type of error.

Error class	Type	Meaning	Example
E1	Fatal error	A safe function of the operating system is no longer guaranteed.	Checksum error in the system Flash or RAM error
E2	Severe error	The operating system is functioning without problems, but the error-free processing of the user program is no longer guaranteed.	Checksum error in the user Flash, independent of the task duration
E3	Light error	It depends on the application, if the user program should be stopped by the operating system or not. The user should decide, which reaction is necessary.	Flash could not be programmed, I/O module has failed.
E4	Warning	Error in the periphery (e.g. I/O) which only can have influence in the future. The user should decide the reaction to provide.	Short-circuit at an I/O module, the battery is exhausted or not inserted.



Note: The error messages are displayed as error codes using the Control Builder software (via PLC browser). Errors are displayed as text in the status line of the Control Builder software or with function blocks for diagnosis.

How an error message is built-up in the display

An error always consists of an Error Class (E1 to E4, see the previous table) and a number (0 to 63) which indicates the identifier of the error for direct error recognition. Moreover, there are further four detailed error codes from d1 to d4 which define the error in detail:

E1...E4 = 00...63 (error identifier)	e.g. wrong value, checksum error, short-circuit, exhausted or missing battery, etc. which is directly displayed in the LCD
-> d1 = 000...015	indicates the component which has sent the error (coupler, CPU, COM1, FBP, IO-Bus, etc.)
d2 = 000...255	defines the faulty device within the component
d3 = 000...030	defines the part of the module with an error (slot)
d4 = 000...031	defines the channel within the module

Example of an error display for an exhausted battery

To display the complete error codes, please follow the procedure described below:

The CPU is running. The display only shows the RUN status and the background lighting is OFF.

When an error occurs, the red ERR LED goes on. An error message is output after pressing the **DIAG** key and, for example, the screen shown to the right displays "E4=008". According to the error level, E1 to E4 can be displayed.

In this example, "**E4=008**" is a warning (**E4**) and "**008**" means "Empty/Missing".

By pressing on the **DIAG** button, the LCD background lighting is turned ON, the error codes can be displayed to achieve more (deeper) diagnostic. The display shows "d1=009" (detail level 1) and "009" indicates that the CPU has sent the error.

By pressing **DIAG** one more time, the display shows "d2=022" (detail level 2) and "022" indicates that the device type = battery.

By pressing **DIAG** one more time, the display shows "d3=031" (detail level 3) and "031" means "no module type" (= device itself).

By pressing **DIAG** one more time, the display shows "d4=031" (detail level 4) and "031" means "no channel" (= device itself).

By pressing **OK**, the error is acknowledged and the display returns to the normal state. ESC returns to the normal state without acknowledging the error!

SYS
BATT
I/O-Bus

◀

run

ETH
FBP
COM1
COM2

SYS
BATT
I/O-Bus

◀

E4-008

ETH
FBP
COM1
COM2

DIAG

SYS
BATT
I/O-Bus

◀

d1-009

ETH
FBP
COM1
COM2

DIAG

SYS
BATT
I/O-Bus

◀

d2-022

ETH
FBP
COM1
COM2

DIAG

SYS
BATT
I/O-Bus

◀

d3-031

ETH
FBP
COM1
COM2

DIAG

SYS
BATT
I/O-Bus

◀

d4-031

ETH
FBP
COM1
COM2

OK
or
ESC

SYS
BATT
I/O-Bus

◀

run

ETH
FBP
COM1
COM2

Figure: Example of an error display for an exhausted battery

Please refer to the Error Code list for further information. See the AC500 user manual.

LEDs on S500-FBP modules

All S500 modules have LEDs for the display of operating statuses and error messages. They indicate:

LED	Meaning	Color	LED = ON	LED = OFF	LED flashes
Input	digital input	yellow	input = ON	input = OFF	--
	analog input	yellow	brightness depends on the value of the analog signal		--
Output	digital output	yellow	output = ON	output = OFF	--
	analog output	yellow	brightness depends on the value of the analog signal		--
UP	process voltage 24 V DC via terminal	green	voltage is present	voltage is missing	--
PWR	24 V DC via FBP	green	voltage is present	voltage is missing	--
S-ERR	Sum Error	red	serious error, data exchange is stopped, depends on the behaviour of the master	no error	error (e.g. error on one channel, data exchange is not stopped)
FBP	FBP communication	green	communication between FBP and FBP Interface Module is running	communication between FBP and FBP Interface Module is broken	during initialization
I/O-Bus	I/O-Bus communication	green	communication between FBP Interface Module and the I/O modules is running	no communication between FBP Interface Module and the I/O modules	error on one I/O expansion module (e.g. one output short-circuited)
CH-ERR1	Channel Error, error messages in groups (digital or analog inputs and outputs combined into the groups 1, 2, 3, 4)	red	serious error within the corresponding group	no error	error on one channel of the corresponding group (e.g. one output short-circuited)
CH-ERR2		red			
CH-ERR3		red			
CH-ERR4		red			
CH-ERR*)	Module Error	red	error within the I/O module	--	--
*) All of the LEDs CH-ERR1 to CH-ERR4 (as far as they exist) light up together					

For the meaning of the different LEDs and their behaviour when the system is running, please refer to the S500 System Data of the S500 User's manual for further information.

FBP LEDs – PROFIBUS DP

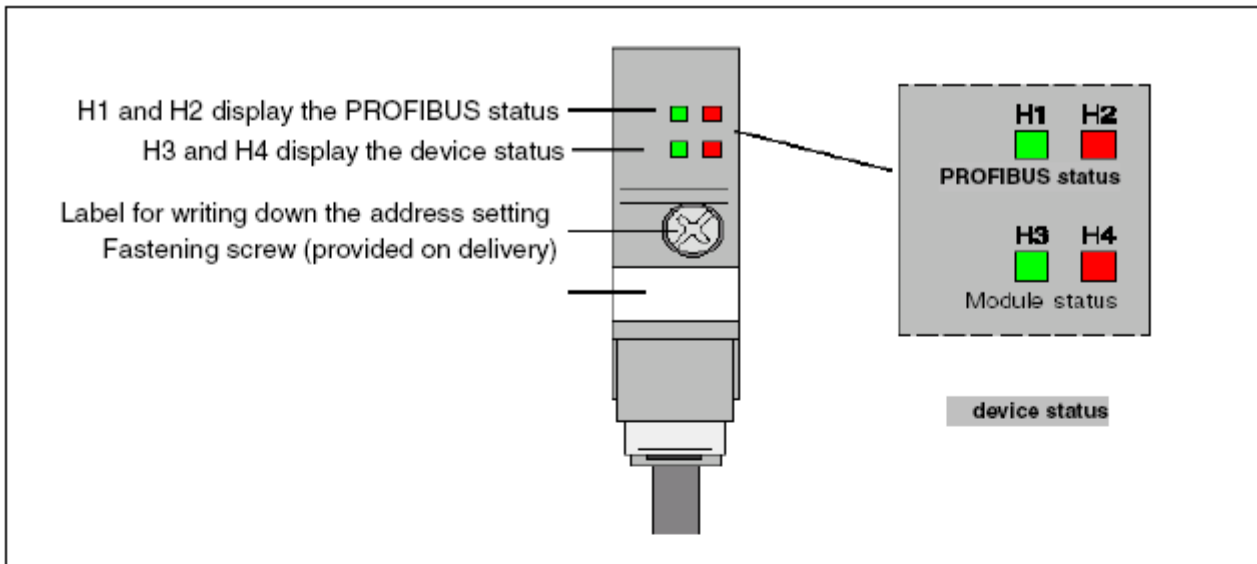

Meaning of the LEDs

PROFIBUS status		Device status		Status / Cause
LED green H1	LED red H2	LED green H3	LED red H4	
off	off	off	off	Power supply is missing
On	flashes			Possible errors: - No connection to the bus master, e.g. PROFIBUS not operating. - The PDP21 / PDP22 has a slave address that is not configured in the bus master. - Parameter length and slave address are correct but I/O configuration of the slave does not meet the configuration sent by the bus master.
flashes	On			The device parameters received from The bus master are formal incorrect, e.g. of other length.
off	On			Connection to the bus master is interrupted longer than the time-out set by the bus master before interruption.
On	off			Normal data exchange to the PROFIBUS DP master.
		On	off	Normal data exchange to the terminal device.
flashes	flashes	flashes	flashes	Plug is under self-test during power-up
		flashes	off	Plug is waiting for configuration data, to be sent from the device (number of input/output bytes, number of parameter bytes, internal baud rate etc.). Note: If no data has been sent by the terminal device within 3 s, the plug switches to the parallel mode.
		off	flashes	Error: can be remedied, e.g. connection to the terminal device is broken.
		off	On	Error: cannot be remedied, e.g. incorrect checksum in the flash. Exchange plug.

AC500 Modules Specifications

Please refer to the AC500 User's Manual chapter System Data.

AC500 Modules Certifications

Please refer to the AC500 User's Manual chapter System Data.

Getting Started with S500-FBP

Important user information



Solid state equipment has operational characteristics differing from those of electromechanical equipment. Because of this difference, and also because of the wide variety of uses for solid state equipment, all persons responsible for applying this equipment must satisfy themselves that each intended application of this equipment is acceptable.

In no event will ABB be responsible or liable for indirect or consequential damages resulting from the use or application of this equipment.

The examples and diagrams in this manual are included solely for illustrative purposes. Because of the many variants and requirements associated with any particular installation, ABB cannot assume responsibility or liability for actual use based on the examples and diagrams.

No patent liability is assumed by ABB with respect to use of information, circuits, equipment, or software described in this manual.

Throughout this manual we use notes to make you aware of safety considerations.

 WARNING	Identifies information about practices or circumstances that can cause an explosion in a hazardous environment, which may lead to personal injury or death, property damage, or economic loss.
 IMPORTANT	Identifies information that is critical for successful application and understanding of the product.
 ATTENTION	Identifies information about practices or circumstances that can lead to personal injury or death, property damage, or economic loss. Attentions help you: <ul style="list-style-type: none"> • identify a hazard • avoid a hazard • recognize the consequence
SHOCK HAZARD	Labels may be located on or inside the device to alert people that dangerous voltage may be present.
SHOCK HAZARD	Labels may be located on or inside the device to alert people that surfaces may have dangerous temperatures.

Environment and Enclosure Information

 ATTENTION	<p>Environment and Enclosure</p> <p>This equipment is intended for use in a Pollution Degree 2 industrial environment, in overvoltage Category II applications (as defined in IEC publication 60664-1), at altitudes up to 2000 meters without derating.</p> <p>This equipment is considered Group 1, Class A industrial equipment according to IEC/CISPR Publication 11. Without appropriate precautions, there may be potential difficulties ensuring electromagnetic compatibility in other environments due to conducted as well as radiated disturbance.</p> <p>This equipment is supplied as "open type" equipment. It must be mounted within an enclosure that is suitably designed for those specific environmental conditions that will be present and appropriately designed to prevent personal injury resulting from accessibility to live parts. The interior of the enclosure must be accessible only by the use of a tool. Subsequent sections of this publication may contain additional information regarding specific enclosure type ratings that are required to comply with certain product safety certifications.</p> <p>See NEMA Standards publication 250 and IEC publication 60529, as applicable, for explanations of the degrees of protection provided by different types of enclosure. Also, see the appropriate sections in this publication, as</p>
--	--

well as the S500 User's manual for additional installation requirements pertaining to this equipment.

Before starting

Use this document as a guide for installing and powering-up your S500-FBP Interface Module. You should already be familiar with the system components.

How to handle S500-FBP components

 ATTENTION	<p>Preventing Electrostatic Discharge</p> <p>This equipment is sensitive to electrostatic discharge, which can cause internal damage and affect normal operation. Follow these guidelines when you handle this equipment:</p> <ul style="list-style-type: none"> • Touch a grounded object to discharge potential static. • Wear an approved grounding wrist strap. • Do not touch connectors or pins on component boards. • Do not touch circuit components inside the equipment. • If available, use a static-safe workstation. • When not in use, store the equipment in appropriate static-safe packaging.
--	---

Make sure that you have all the components you need

To use the S500-FBP Interface Module you should use at least the following parts:

Part Number	Designation
1SAP220000R0001	DC505-FBP, Interface Module with 8DI/8DC 24 V DC
1SAP210000R0001 or 1SAP212000R0001	TU505, FBP Terminal Unit with screw or TU506, FBP Terminal Unit with spring
See the FBP Catalog	FieldBusPlug module with desired Fieldbus protocol

You may also use these components with the S500-FBP Interface:

If you want to:	Then use this component:
<ul style="list-style-type: none"> • connect a 24 V dc digital sensor or actuator to the device 	DI524 (32 DI), DC522 (16DC), DC523 (24DC), DC532 (16DI/16DC) or DX522 (8DI/8 DO-R) with the corresponding terminal unit with screw-type or spring connection TU515/516 or TU531/532
<ul style="list-style-type: none"> • connect a 115-230 V AC digital sensor or actuator to the device 	DX531 (8DI 115-230 V AC / 4 DO-R) + corresponding Terminal Unit TU531/532 with screw or spring technology
<ul style="list-style-type: none"> • connect a 24 V DC analog sensor or actuator to the device 	AI523 (16AI U/I/PT100), AO523 (16AO), AX521(4AI/4AO U/I/PT100) or AX522 (8AI/8AO U/I/PT100) + corresponding Terminal Unit TU515/516
<ul style="list-style-type: none"> • Label the I/O Channels 	TA523 (Pluggable marking holder) + TA525 Markers for marking holder.

System planning

Consider the following when planning your S500-FBP system:

- The S500-FBP controller is always the left-most module in the system.
- The FieldBusPlug delivers the power supply for the FBP interface module DC505 and the connected I/O bus; the additional I/O modules have to be installed to the right of the FBP Interface Module.
- The DC505-FBP Interface module supports as many as 7 I/O expansion modules.
- An additional process power supply has to be provided for the I/Os of each module. Each I/O expansion module can be powered with its own power supply (isolation purpose) or the same power supply can also be used.
- One FieldBusPlug can be used in a S500-FBP cluster.

Installation steps

√		Installation step:	Further information
<input type="checkbox"/>	1	Snap the FBP Terminal Unit onto DIN Rail or screw it (wall mounting)	
<input type="checkbox"/>	2	Snap the additional Terminal Units for I/O modules onto DIN Rail (optional) or screw them (wall mounting)	
<input type="checkbox"/>	3	Make the sensor/actuator wire connections according to the dedicated Electronic module you want to use (see dedicated pages), connect also a Process Power supply to the modules.	
<input type="checkbox"/>	4	Plug the different Electronic modules in the right place (FBP Interface module on TU, and eventually also I/O modules onto dedicated TUs)	
<input type="checkbox"/>	5	Make the FBP fieldbus connection acc. to the chosen FBP and use the dedicated FBP accessories (cables, master cable to M12, line termination, power supply connector, etc...)	(*)
<input type="checkbox"/>	6	Plug the FBP-Plug on the M12 connector located on the Terminal Unit of the S500-FBP Interface Module	
<input type="checkbox"/>	7	Set the correct address onto the FBP Interface Module (rotary switches)	
<input type="checkbox"/>	8	Install the appropriate EDS/GSD files into the Fieldbus configurator (for use with AC31 or AC500 Control Builder) or use a dedicated Fieldbus Configurator tool using GSD/EDS configuration files of your Master device	
<input type="checkbox"/>	9	Set the power on (process power supply first and FBP power supply)	
<input type="checkbox"/>	10	Start the communication	

(*) Refer to the Installation Instructions of the used FBP device.

Assembling the System



WARNING

The S500-FBP modules are not designed for removal or insertion under power. Because of unforeseeable consequences, it is not allowed to plug or unplug modules with the power being ON.

If you connect or disconnect the FBP plug while power is applied to this module or the wiring while the process power supply is on, an electrical arc can occur. This could cause an explosion in hazardous location installations.

Be sure that power is removed or area is non-hazardous before proceeding.

Using S500 I/O Modules

The S500 I/O modules could be used either directly connected to an AC500 CPU (central expansion) or together with an FBP Interface Module DC505-FBP + an FBP (PROFIBUS DP, DeviceNet, etc.) as decentralized expansion.

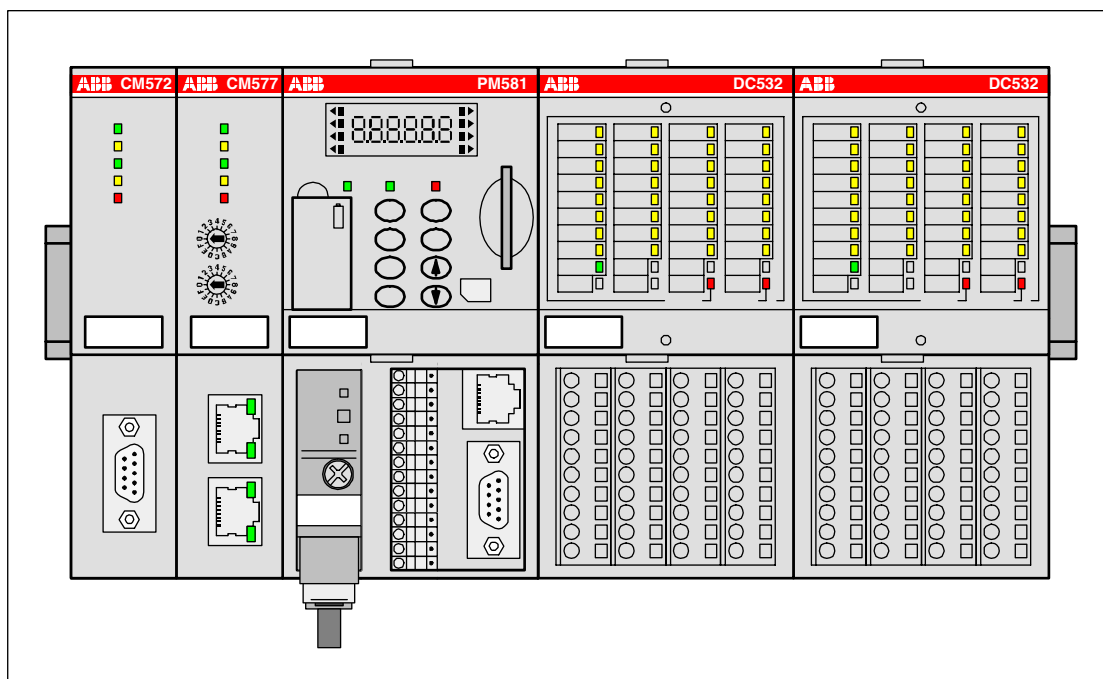

Figure: S500 I/O modules directly connected to an AC500 CPU (central I/O expansion)

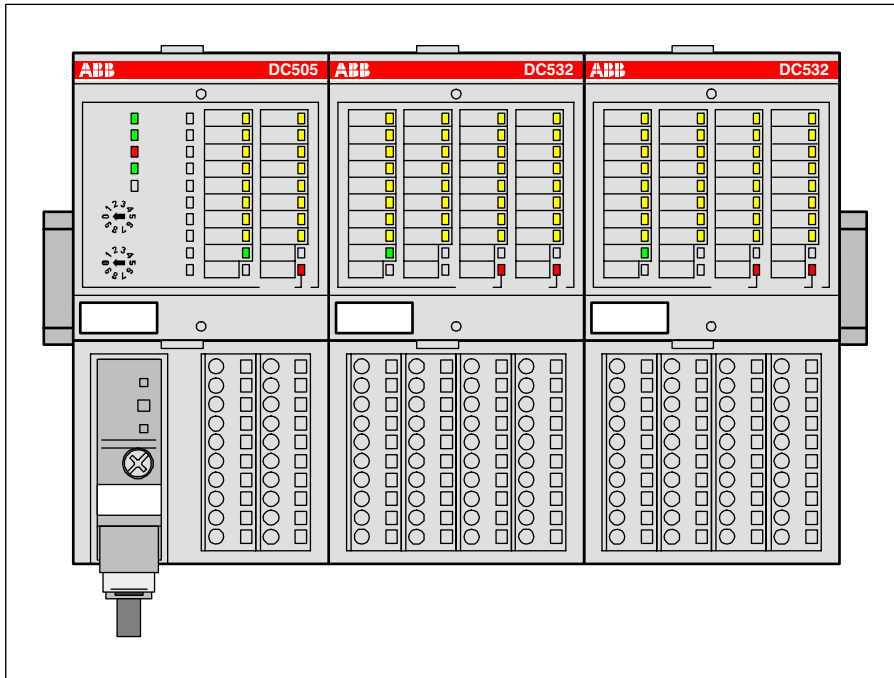

Figure: S500 I/O modules connected to an FBP Interface Module DC505-FBP with an FBP (decentralized expansion)

Minimum spacing

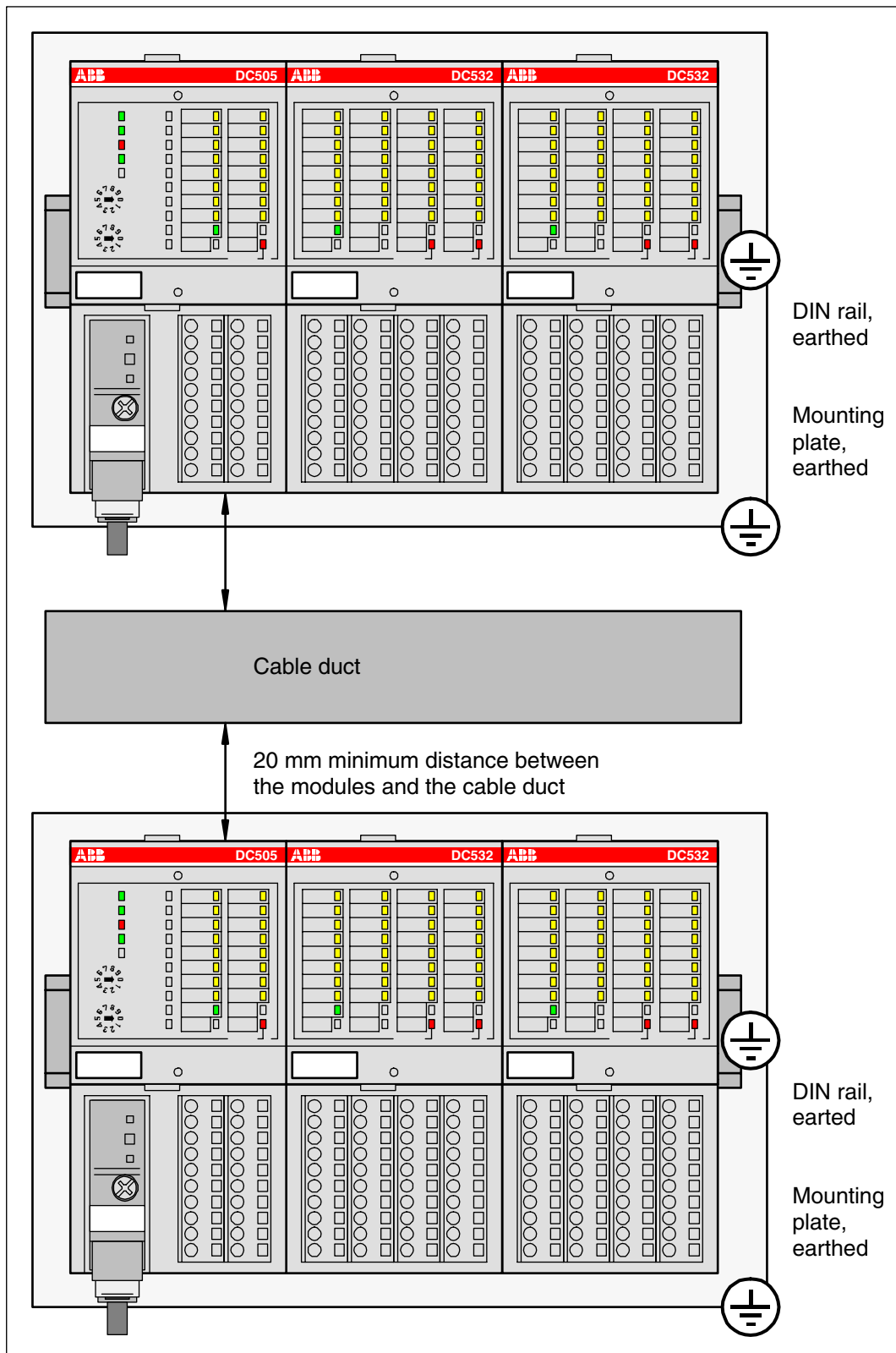

Figure: AC500/S500 module mounting into cabinets

Maintain spacing from enclosure walls, wireways, adjacent equipment, etc. Allow minimum 20 mm (1 in.) of space on all sides, as shown. This provides ventilation and electrical isolation.



Important: Horizontal mounting is highly recommended. Vertical mounting is possible, however, derating consideration should be made to avoid problems with poor air circulation and the potential for excessive temperatures (see also the AC500 system data, operating and ambient conditions, for reduction of ambient temperature).



Note: By vertical mounting, always place an end-stop terminal block (e.g. type BADL, P/N: 1SNA399903R0200) at the bottom and on the top of the modules to properly secure the modules.

By high vibration applications and horizontal mounting, we also recommend to place end-stop terminals at the right and left side of the device to properly secure the modules, e.g. type BADL, P/N: 1SNA399903R0200.

Mounting the System



ATTENTION

During panel or DIN rail mounting of all devices, be sure that all debris (metal chips, wire strands, etc.) is kept from falling into the controller. Debris that falls into the controller could cause damage while the controller is energized.

Mounting and Demounting of the Terminal Unit and Electronic Module

Mounting on DIN rail

Step 1: Install the 7.5 mm or 15 mm DIN Rail

Step 2: Snap the FBP-Terminal Unit (TU505 or TU506)

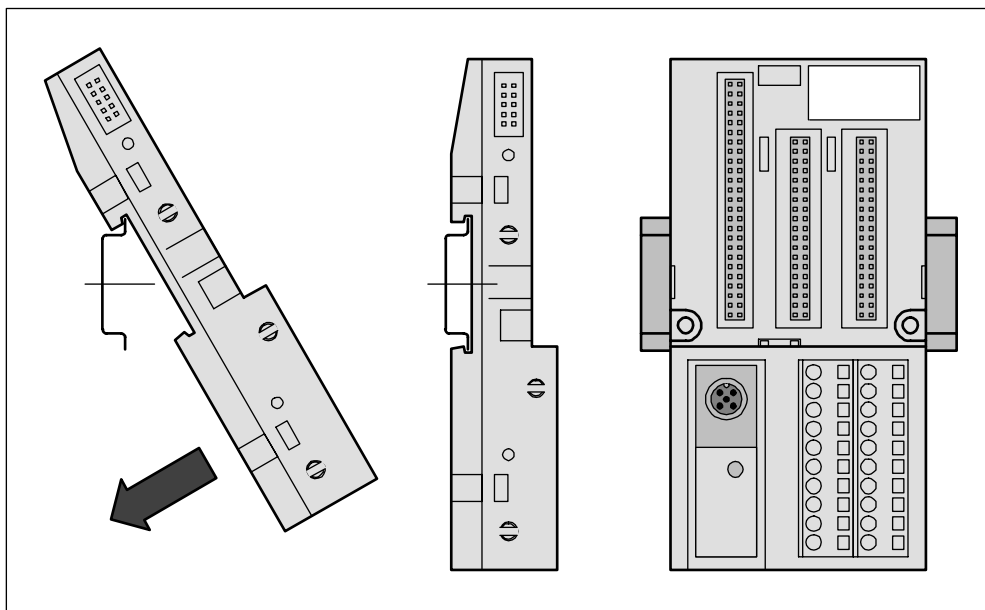

Figure: Mounting of the FBP Terminal Unit (TU505 or TU506)

The FBP Terminal Unit will be placed on top of the DIN Rail and then snapped on the bottom. Follow the reverse order to disassembly.

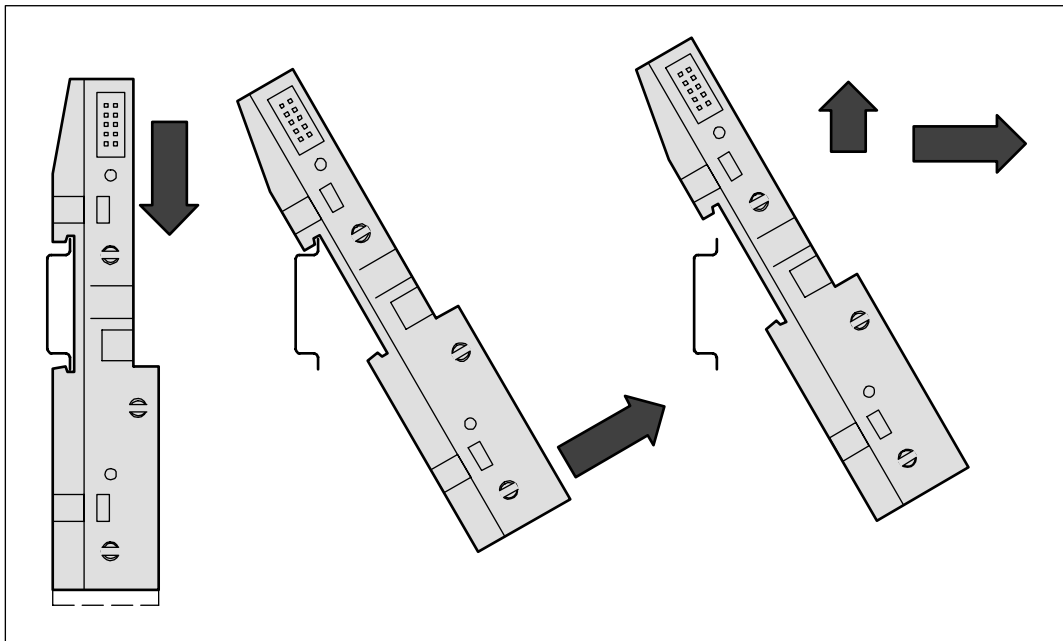

Figure: Disassembly of the FBP Terminal Unit (TU505 or TU506)

Step 3: Mounting of the I/O Terminal Unit (TU515, TU516, TU531 or TU532)

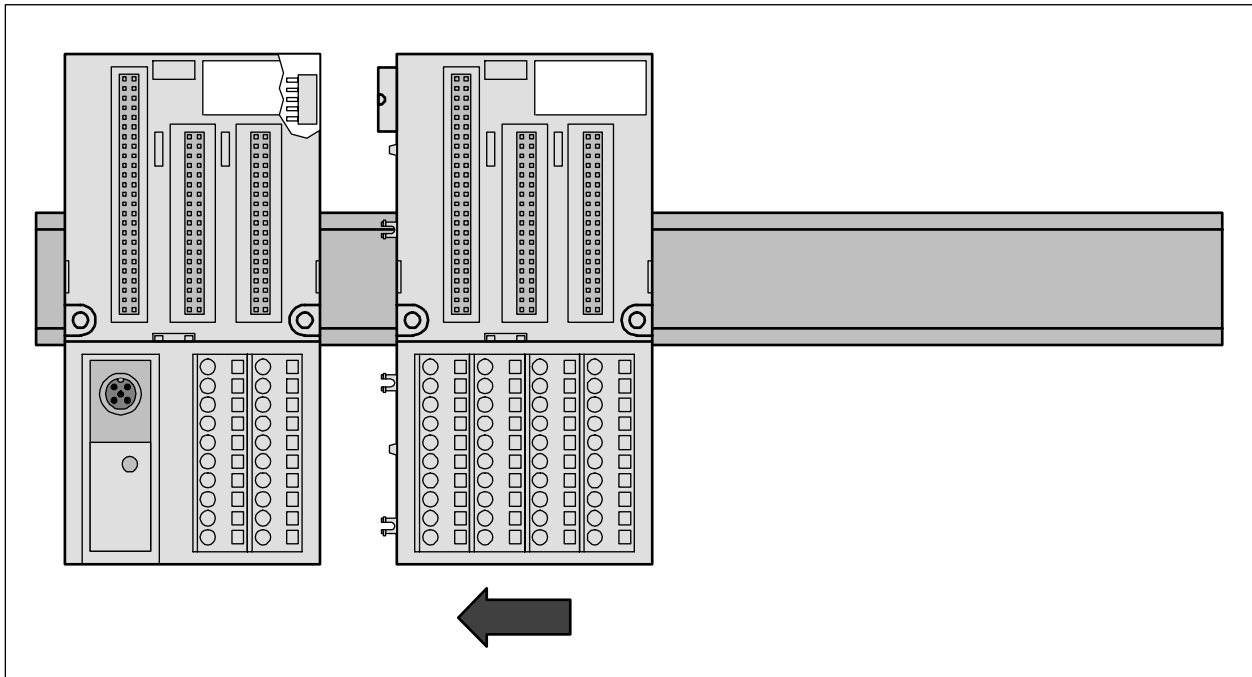

Figure: I/O Terminal Unit assembly (TU515, TU516, TU531 or TU532)

The I/O Terminal Unit is installed on the DIN rail in the same way as the FBP Terminal Unit. Once secured on the DIN rail, slide the I/O unit to the left until it fully locks into place creating a solid mechanical and electrical connection.

Up to 7 I/O Terminal Units could be combined with a FBP Terminal Unit.

 ATTENTION	<p>When attaching the FBP, FBP Interface and I/O modules, make sure the bus connectors are securely locked together to ensure proper electrical connection.</p>
--	---

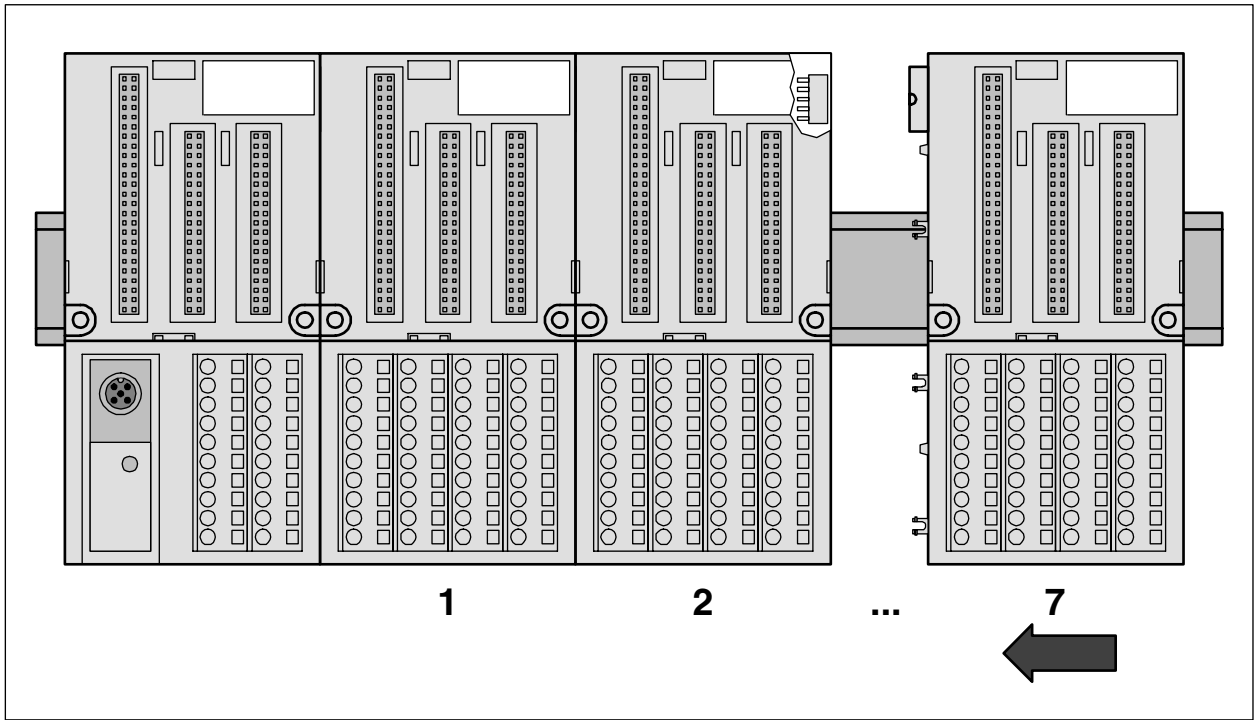

Figure: Maximum configuration (1 FBP Terminal Unit plus 7 I/O Terminal Units)

Disassembly of a Terminal Unit

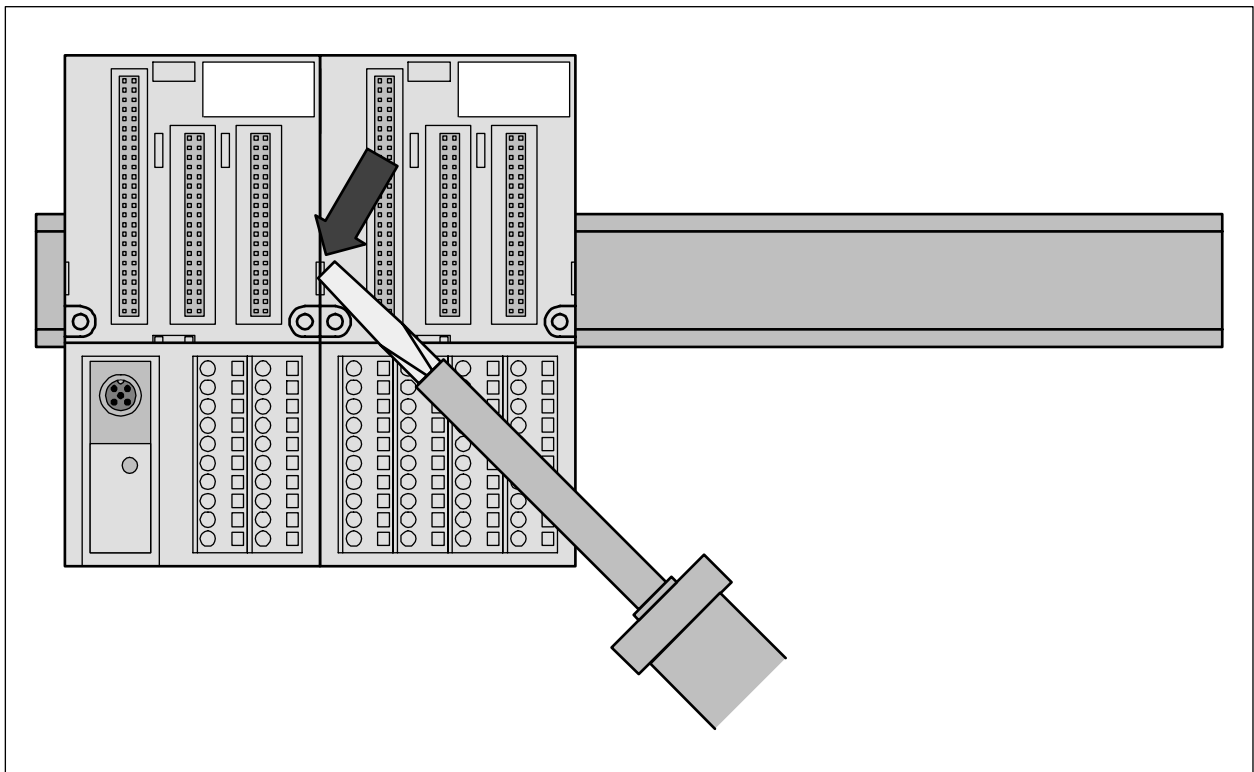

Figure: I/O Terminal Unit disassembly (TU515, TU516, TU531 or TU532)

A screwdriver is inserted in the indicated place to separate the Terminal Units.

Step 4: Module assembly

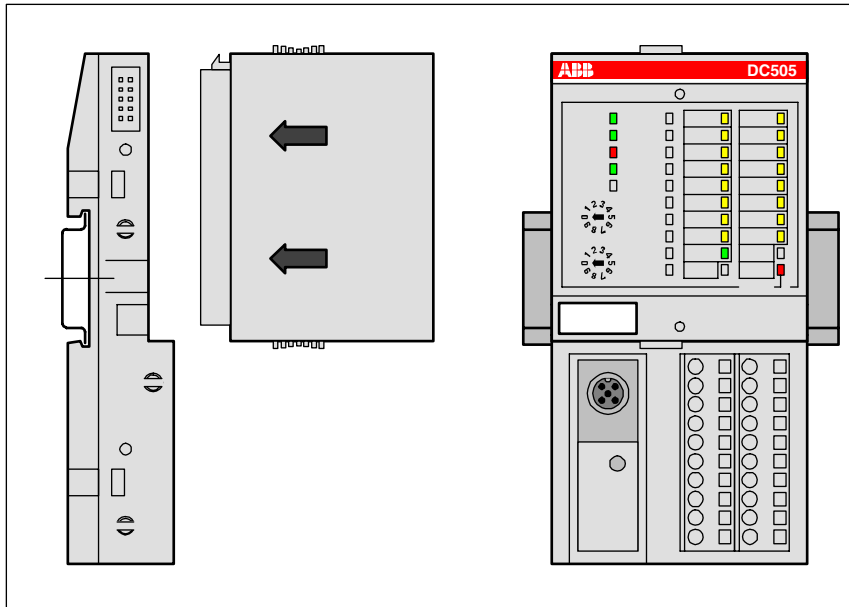

Figure: Mounting of the module

The module will be plugged on the Terminal Unit. And will be locked in place.

The disassembly is done in reverse order.

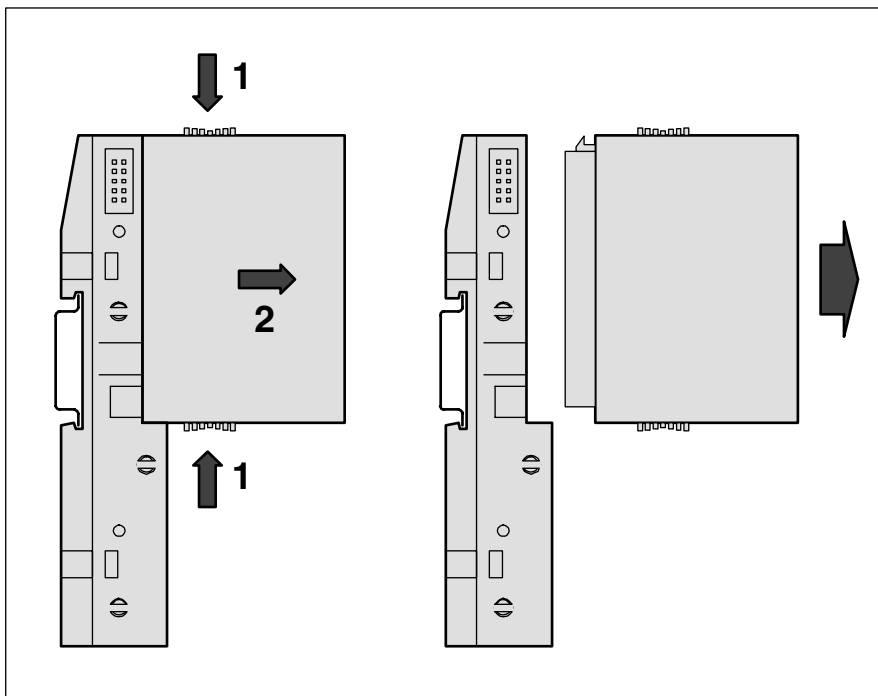

Figure: Module disassembly

For disassembly, press top and bottom, then pull out the module.

Panel mounting

If the Terminal Unit should be mounted with screws, a Wall Mounting Accessory TA526 must be inserted at the rear side first. This plastic part prevents bending of the Terminal Unit while screwing on.

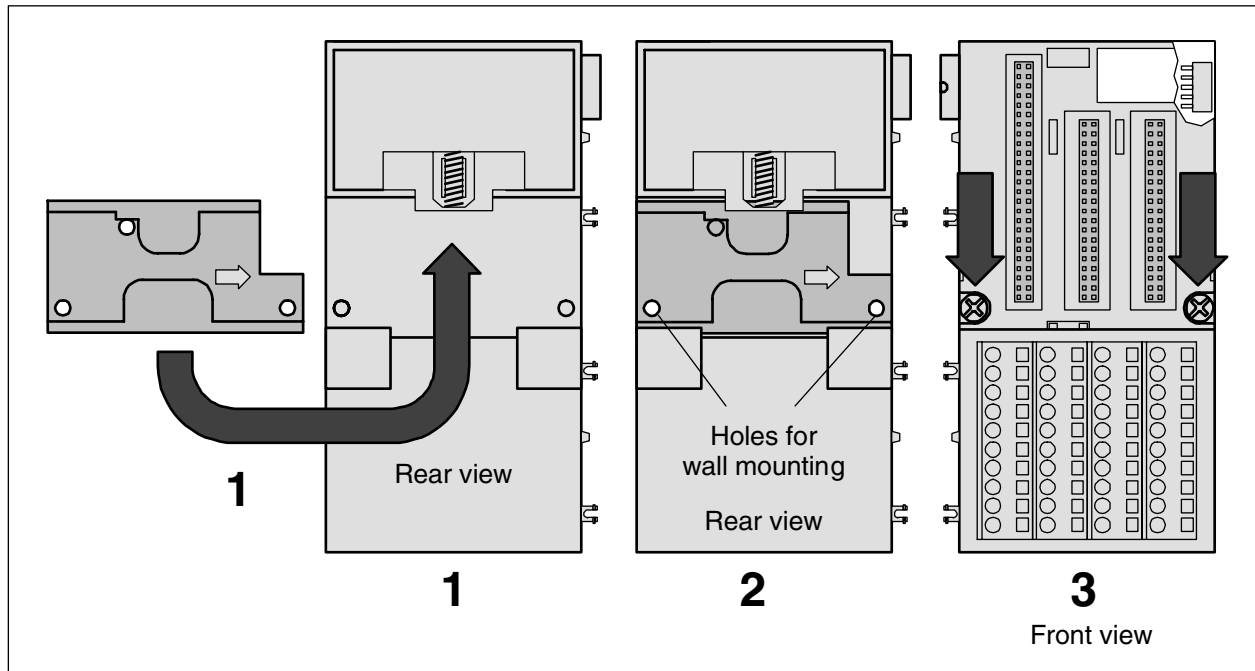

Figure: Fastening with screws of the Terminal Unit TU516 (as an example)

1 The Wall Mounting Accessory TA526 is snapped on the rear side of the Terminal Unit like a DIN rail. The arrow points to the right side.

2 Accessory for wall mounting inserted

3 Terminal Unit, fastened with screws. Use two screws per module. Use M4 or #8 pan head screws. Mounting screws are required on every module.

By wall mounting, the Terminal Unit is earthed through the screws. It is necessary that

- the screws have a conductive surface (e.g. steel zinc-plated or brass nickel-plated)
- the **mounting plate is earthed**
- the screws have a good electrical contact to the mounting plate

The following procedure allows you to use the assembled modules as a template for drilling holes in the panel. Due to module mounting hole tolerance, it is important to follow these procedures:

1. On a clean work surface, assemble no more than three modules.
2. Using the assembled modules as a template, carefully mark the center of all module-mounting holes on the panel.
3. Return the assembled modules to the clean work surface, including any previously mounted modules.
4. Drill and tap the mounting holes for the recommended M4 or #8 screw.
5. Place the modules back on the panel and check for proper hole alignment.
6. Attach the modules to the panel using the mounting screws.

TIP: If mounting more modules, mount only the last one of this group and put the others aside. This reduces remounting time during drilling and tapping of the next group.

7. Repeat steps 1 to 6 for any remaining modules.

Grounding considerations

This product is designed to be mounted to a well-grounded mounting surface such as a metal panel. Additional grounding connections from the S500 mounting tabs or DIN rail (if used), are not required unless the mounting surface cannot be grounded. Refer to appropriate Chapter of the S500-FBP User's Manual, for additional information.



ATTENTION

This product is grounded through the DIN rail to chassis ground. Use zinc plated yellow-chromate steel DIN rail to assure proper grounding. The use of other DIN rail materials (e.g. aluminium, plastic, etc.) that can corrode, oxidize, or are poor conductors, can result in improper or intermittent grounding.

S500 system dimensions

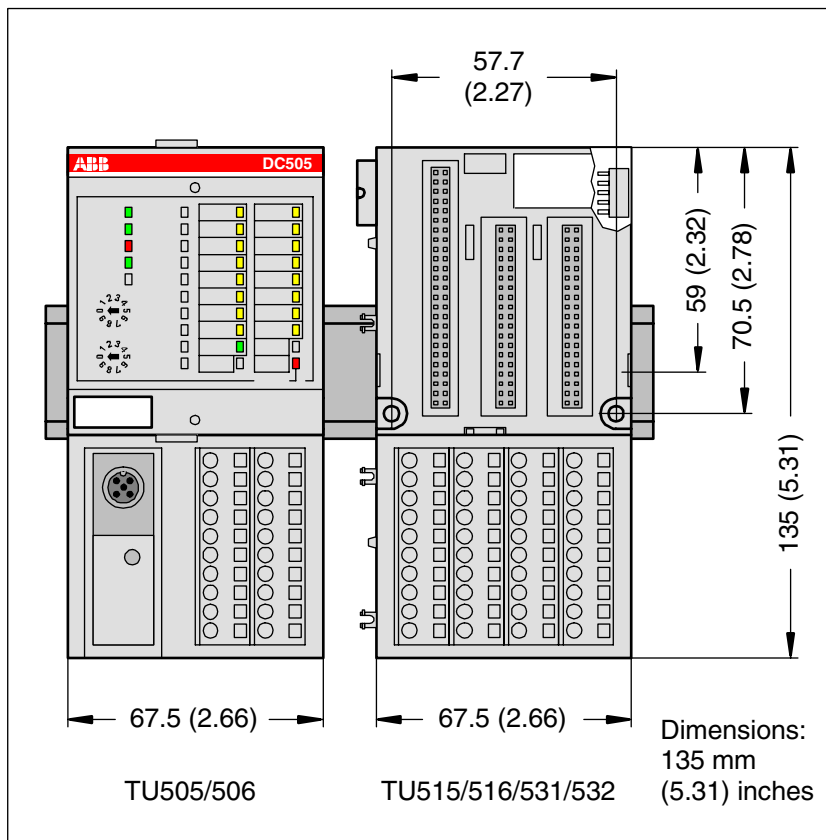

Figure: Dimensions of the Terminal Unit (front view)

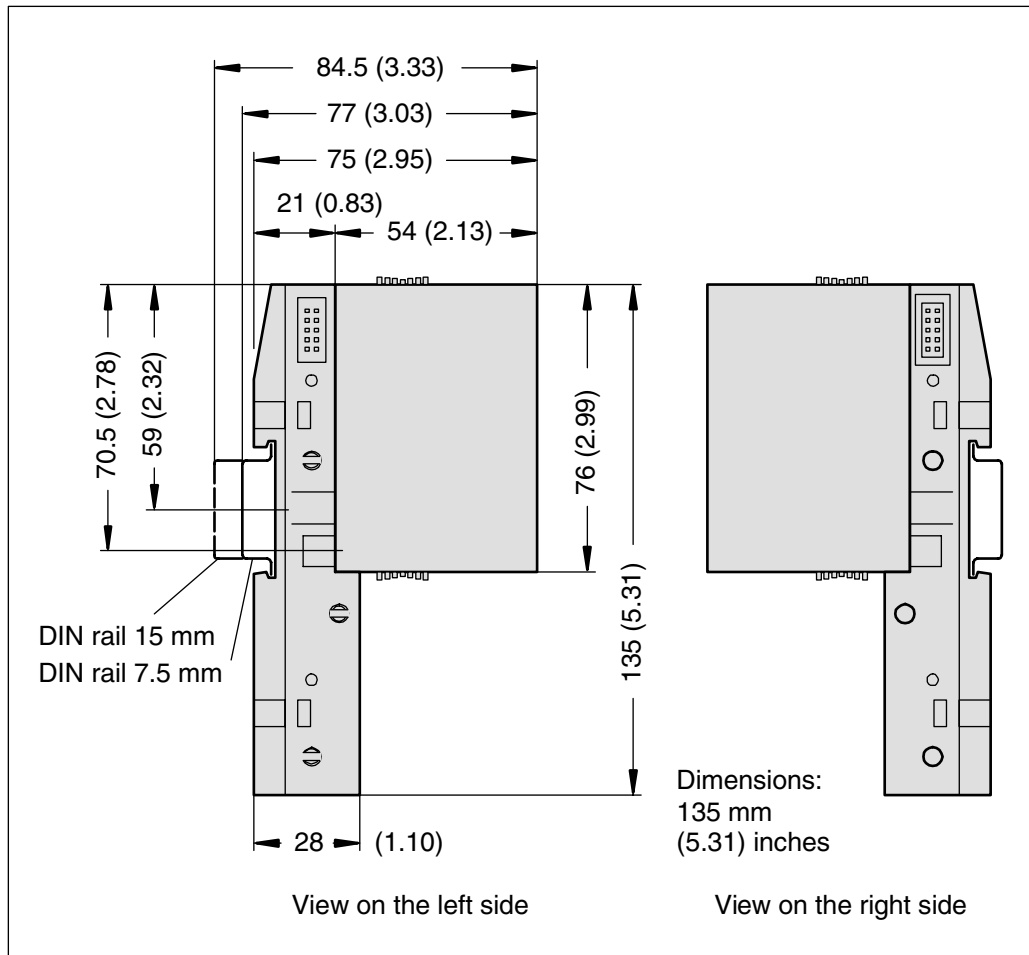

Figure: Dimensions of the Terminal Unit with module (lateral view)

Note: All dimensions are in mm (in.). Hole spacing tolerance: ± 0.4 mm (0.016 in.)

Setting of the slave address of the FBP plug onto the S500-FBP interface module

The FieldBusPlug needs to get an address to be used into a fieldbus as a slave module. The S500-FBP Interface Module gives them an address at power-up of the system. The address should be set according to 2 rotary switches located on the top of the module.

Up to 99 addresses can be then set with the switches.

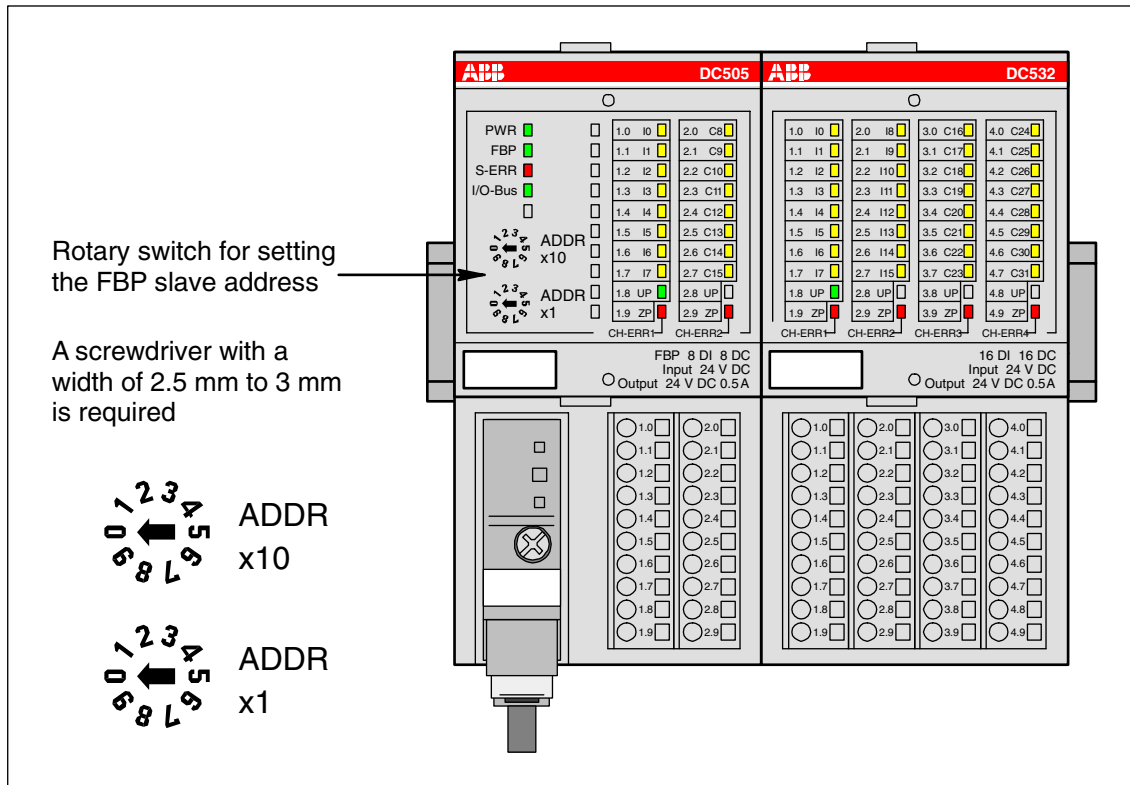

Figure: Setting the FBP slave address

The two rotary switches labelled ADDR x 1 and ADDR x 10 are used to assign an address to the FieldBusPlug.

For example: to assign the address 25 to the station, turn the rotary switch ADDR_{x10} to the position 2 and the ADDR_{x1} to the position 5, then the resulting address is $2 \times 10 + 5 \times 1 = 25$.

Same example but for the address 6: turn the ADDR_{x10} to 0 and the ADDR_{x1} to 6, then the resulting address is $0 \times 10 + 6 \times 1 = 6$.



ATTENTION

If the address set on the FBP Interface Module is different from those assigned into the Fieldbus configurator software of the Master device for that station, the station could not be accessed and the complete fieldbus could not work properly or be completely down!

Make the Connection of the FieldBusPlug to the Fieldbus Master Device

The FieldBusPlug module has to be connected to the master device and the power supply has to be provided. Please use the dedicated accessories to the FBP used for the desired Fieldbus.

Refer to the FBP documentation for the installation instructions.

LEDs on S500-FBP modules

All S500 modules have LEDs for the display of operating statuses and error messages. They indicate:

LED	Meaning	Color	LED = ON	LED = OFF	LED flashes
Input	digital input	yellow	input = ON	input = OFF	--
	analog input	yellow	brightness depends on the value of the analog signal		--
Output	digital output	yellow	output = ON	output = OFF	--
	analog output	yellow	brightness depends on the value of the analog signal		--
UP	process voltage 24 V DC via terminal	green	voltage is present	voltage is missing	--
PWR	24 V DC via FBP	green	voltage is present	voltage is missing	--
S-ERR	Sum Error	red	serious error, data exchange is stopped, depends on the behaviour of the master	no error	error (e.g. error on one channel, data exchange is not stopped)
FBP	FBP communication	green	communication between FBP and FBP Interface Module is running	communication between FBP and FBP Interface Module is broken	during initialization
I/O-Bus	I/O-Bus communication	green	communication between FBP Interface Module and the I/O modules is running	no communication between FBP Interface Module and the I/O modules	error on one I/O expansion module (e.g. one output short-circuited)
CH-ERR1	Channel Error, error messages in groups (digital or analog inputs and outputs combined into the groups 1, 2, 3, 4)	red	serious error within the corresponding group	no error	error on one channel of the corresponding group (e.g. one output short-circuited)
CH-ERR2		red			
CH-ERR3		red			
CH-ERR4		red			
CH-ERR*)	Module Error	red	error within the I/O module	--	--
*) All of the LEDs CH-ERR1 to CH-ERR4 (as far as they exist) light up together					

For the meaning of the different LEDs and their behaviour when the system is running, please refer to the S500 System Data of the S500 User's manual for further information.

FBP LEDs – PROFIBUS DP

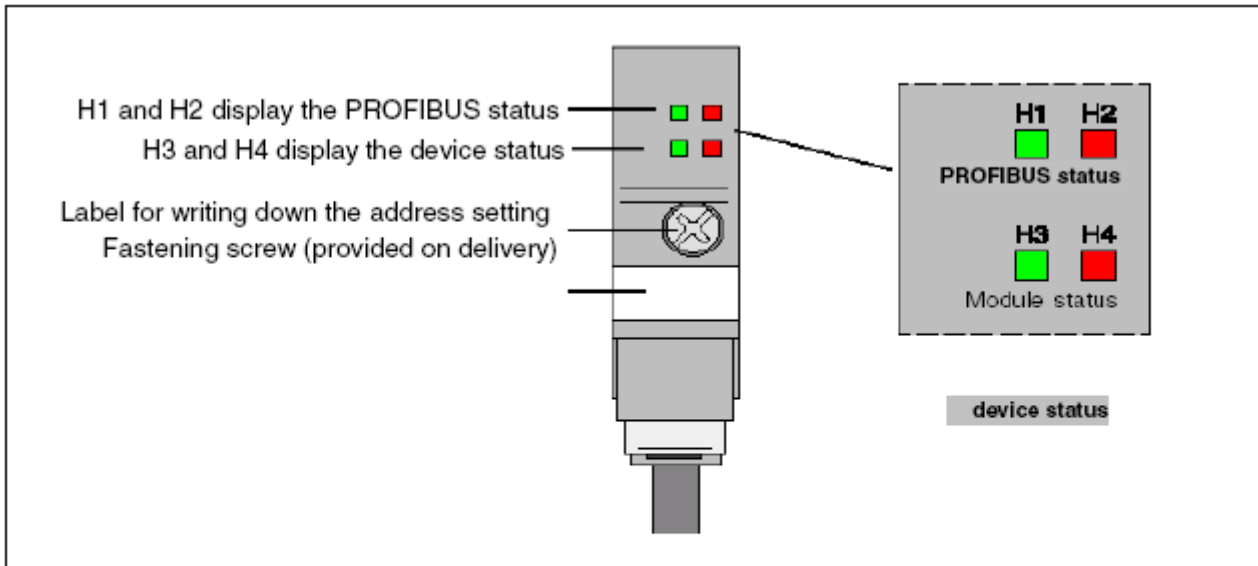

Meaning of the LEDs

PROFIBUS status		Device status		Status / Cause
LED green H1	LED red H2	LED green H3	LED red H4	
off	off	off	off	Power supply is missing
On	flashes			Possible errors: - No connection to the bus master, e.g. PROFIBUS not operating. - The PDP21 / PDP22 has a slave address that is not configured in the bus master. - Parameter length and slave address are correct but I/O configuration of the slave does not meet the configuration sent by the bus master.
flashes	On			The device parameters received from The bus master are formal incorrect, e.g. of other length.
off	On			Connection to the bus master is interrupted longer than the time-out set by the bus master before interruption.
On	off			Normal data exchange to the PROFIBUS DP master.
		On	off	Normal data exchange to the terminal device.
flashes	flashes	flashes	flashes	Plug is under self-test during power-up
		flashes	off	Plug is waiting for configuration data, to be sent from the device (number of input/output bytes, number of parameter bytes, internal baud rate etc.). Note: If no data has been sent by the terminal device within 3 s, the plug switches to the parallel mode.
		off	flashes	Error: can be remedied, e.g. connection to the terminal device is broken.
		off	On	Error: cannot be remedied, e.g. incorrect checksum in the flash. Exchange plug.

S500-FBP Modules Specifications

Please refer to the S500 User's Manual chapter System Data.

S500-FBP Modules Certifications

Please refer to the S500 User's Manual chapter System Data.

Examples

Examples for introduction

Getting started

We will introduce you to the system using a simple example.

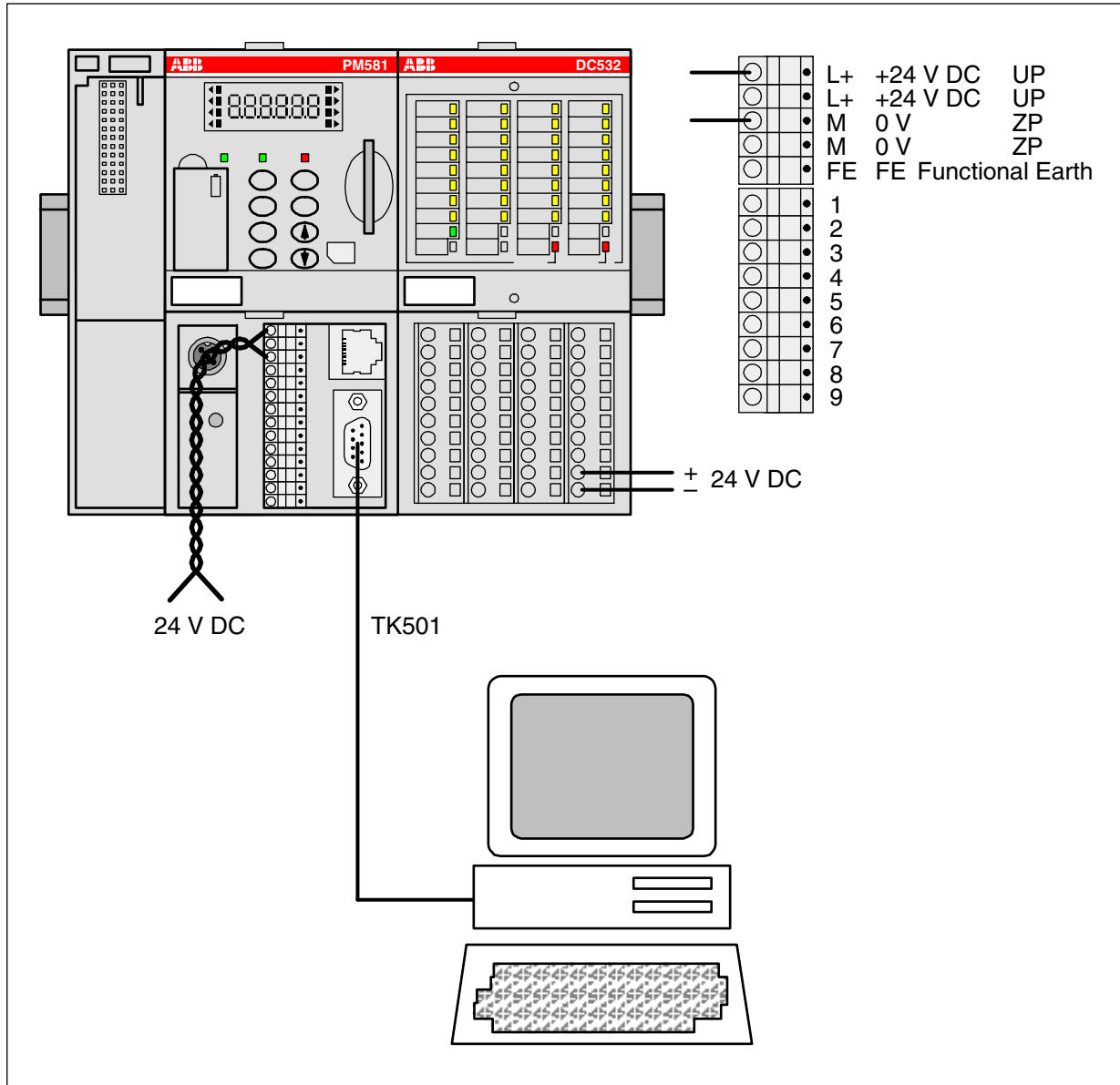

The following components are required for this example:

- One basic unit (e.g. PM581) and one terminal base (e.g. TB511-ETH).
- One digital I/O module DC532 (DX522 or DX531 as an alternative) and one I/O terminal unit (e.g. TU516).
- One 24 VDC power supply.
- A PC with the programming software PS501 installed.
- One cable (TK501) to connect the PC to the basic unit.

Task: Assign an input signal to an output.

In this example, we are using the programming language FBD.

Preparations

- Connect the PM581 controller to 24 V DC. Connect the DC532 I/O module to 24 V DC. Connect the COM2 interface of the controller to the COM1 interface of the PC or use an USB RS-232 converter and connect it to the USB interface of the PC.
- Start the PS501 software. The project last edited is opened. If necessary, close this project by selecting "File/Close".
- Familiarize yourself with the **main window** of the software.

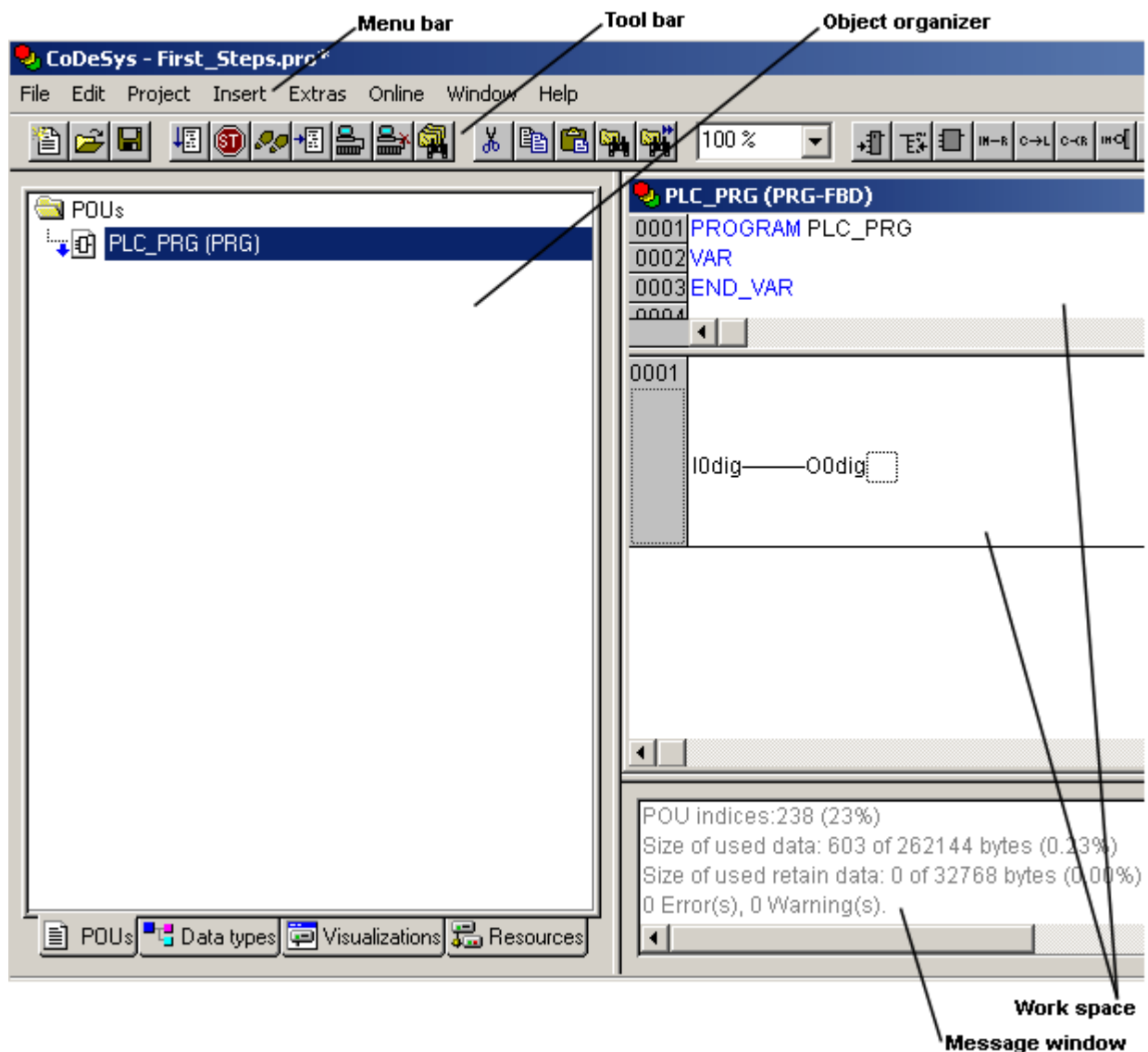

ATTENTION

For a correct operation of the system, it is important to completely specify (configure) the device configuration in the programming software. Otherwise the system will bring up corresponding error messages! In case of errors, please refer to the chapter "System Technology / Diagnosis System in AC500" for required information.

Creating a new project

Select "File/New".

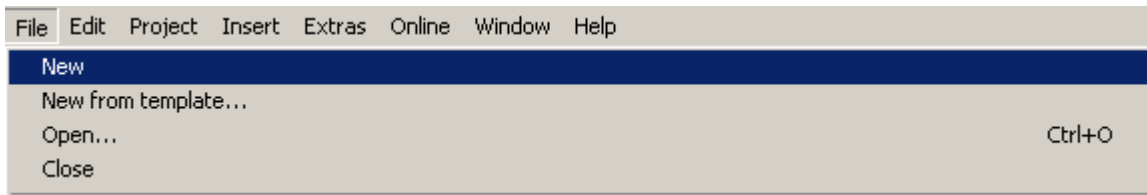

Select the desired CPU in the appearing window. In our example, select **PM581**.

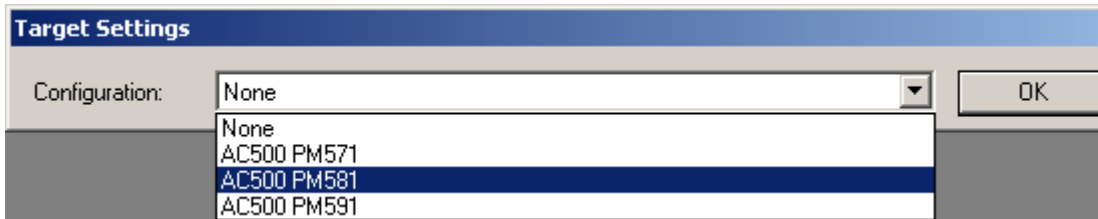

In the appearing window confirm with **OK**.

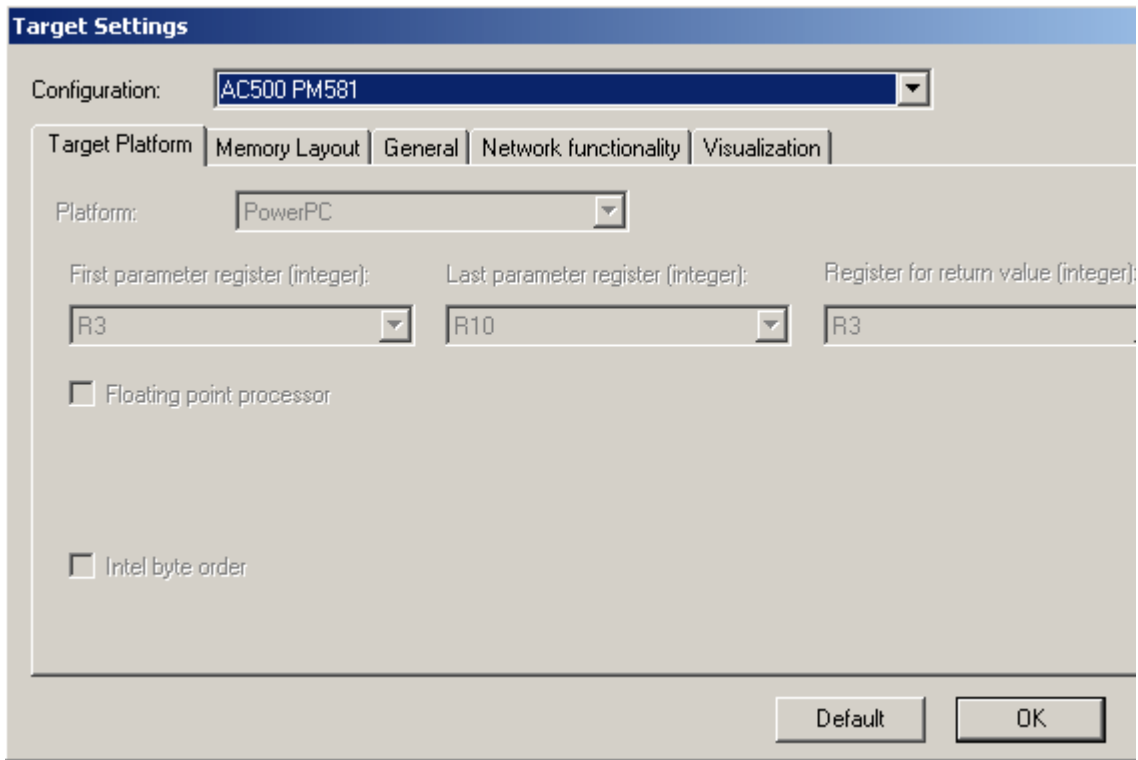

A window appears where you can select the POU name, type and language. For the name and the type keep the settings "PLC_PRG" and "Program". Select "FBD" for the language and confirm with "OK".

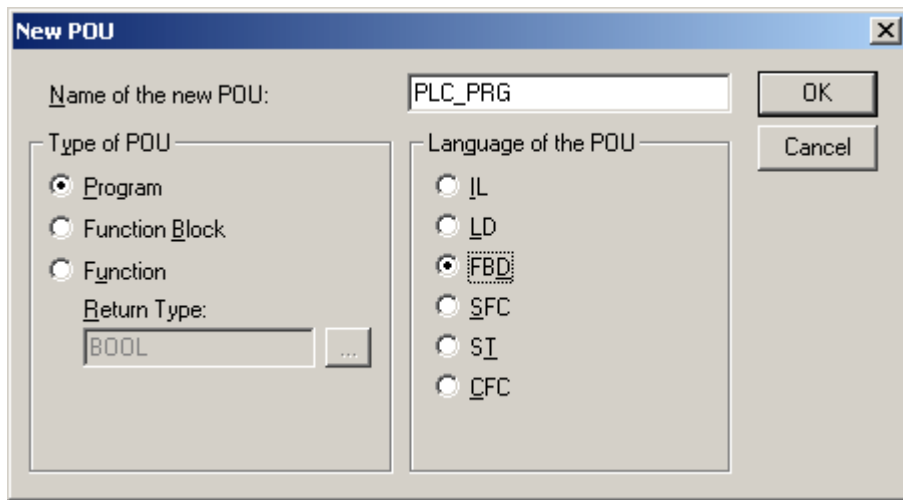

You have now opened a new project.

Note: All necessary libraries are loaded automatically.

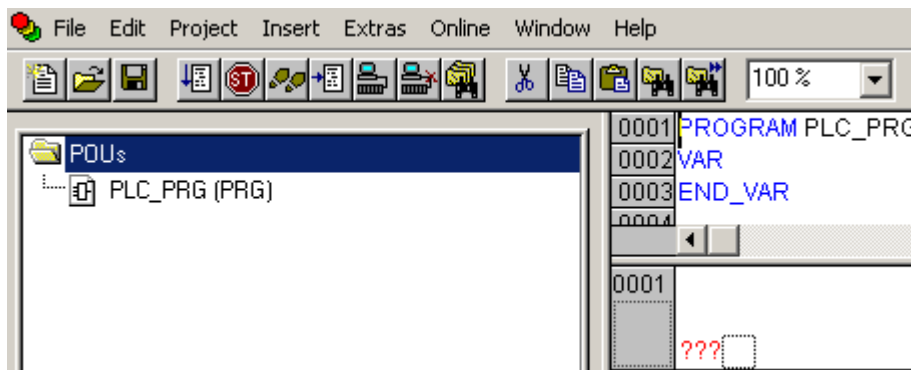

Saving the project to the PC

First of all save the project by selecting the menu item "File/Save as".

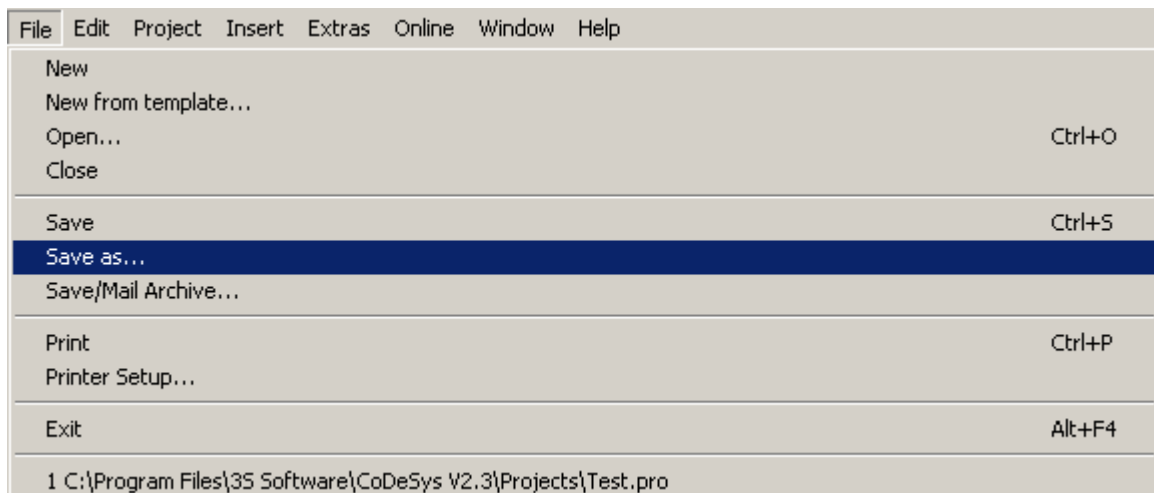

Select the desired directory and enter the project name. Complete your input with "Save".

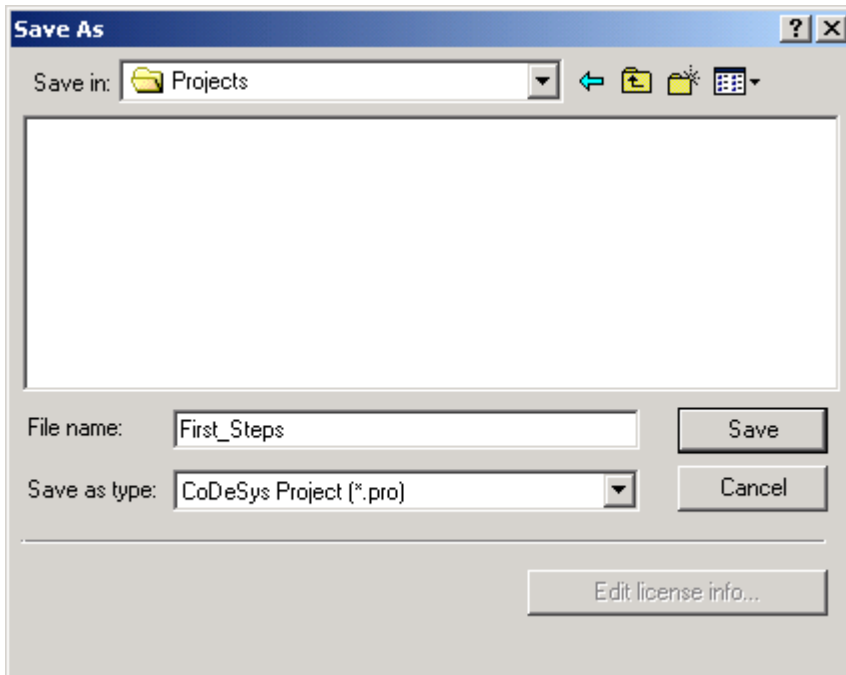

In our example the project is saved under the name "First_Steps" to the folder "Projects". The file extension "pro" is automatically created by the software.

Specifying the hardware configuration

The software has to be informed about the hardware configuration, i.e. the hardware configuration has to be specified in the software (e.g. the I/O devices). Click on  Resources.

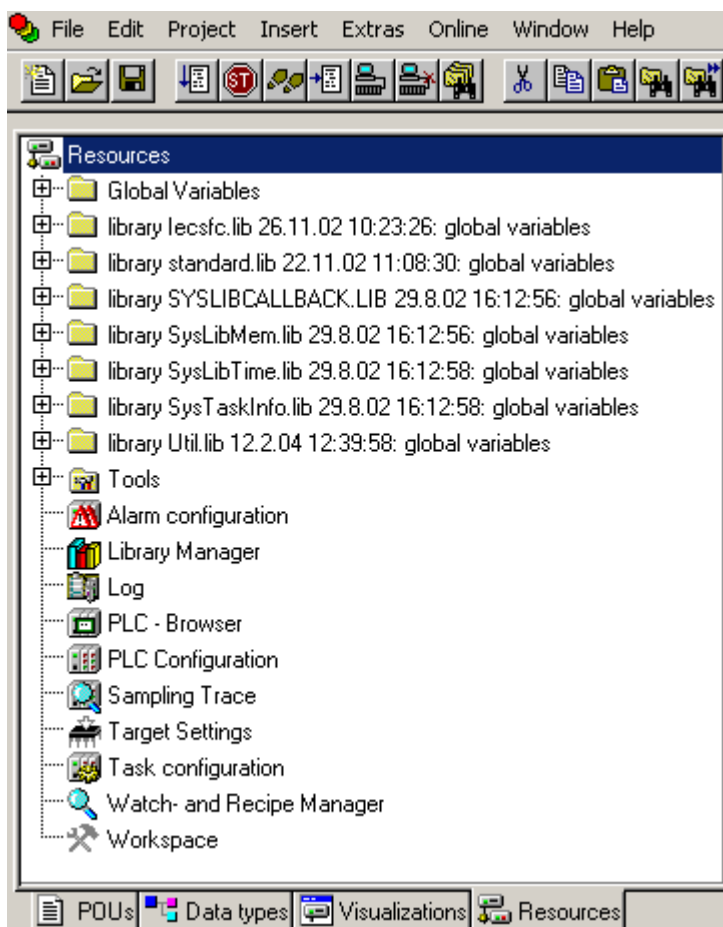

Double click the object "PLC Configuration". If the AC500 folder in the PLC configuration tree is closed, click on the  symbol.

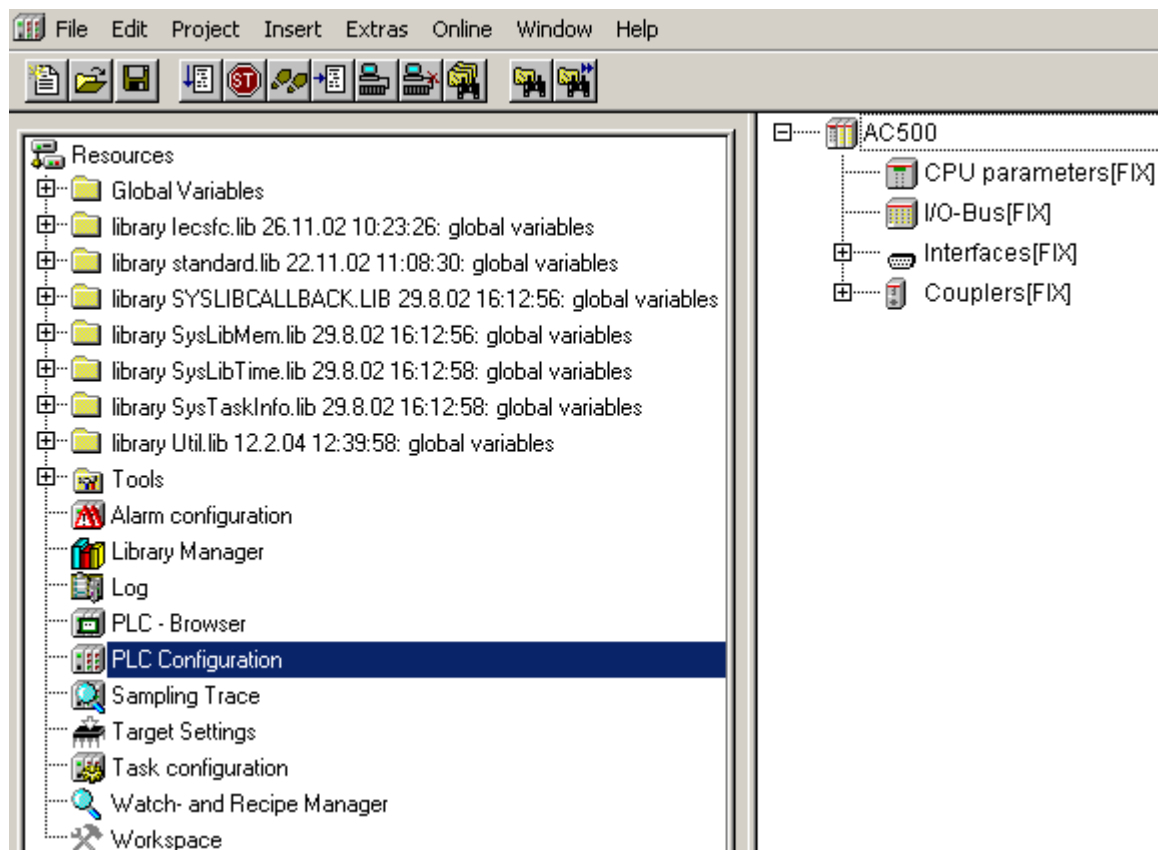

Click on "I/O-Bus[FIX]" and then press the right mouse button.

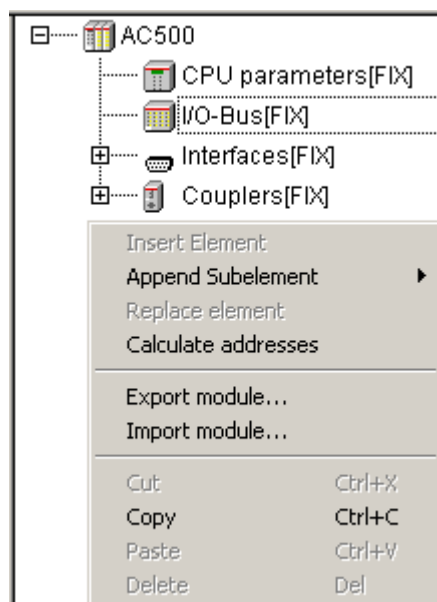

Select "Append Subelement" -> "DC532" (or the I/O module You use).

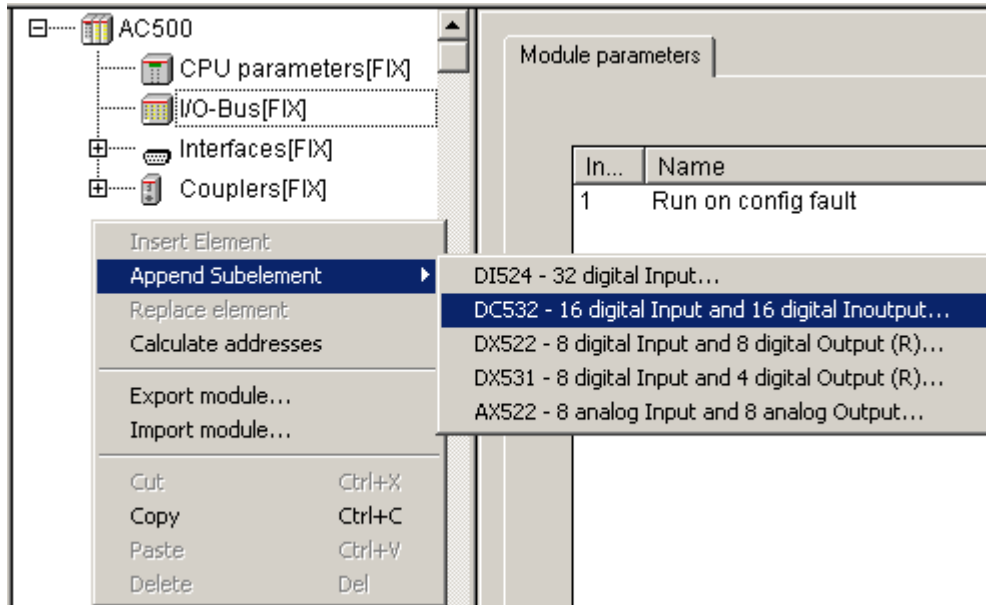

Configuring the digital I/O module DC 532

Configuring the I/O parameters

Click on Resources. Double click the object "PLC Configuration". By clicking on the I/O symbol, the module parameters are displayed and can be changed. Example for DC532: The input delay is changed from 8 ms (default) to 1 ms.

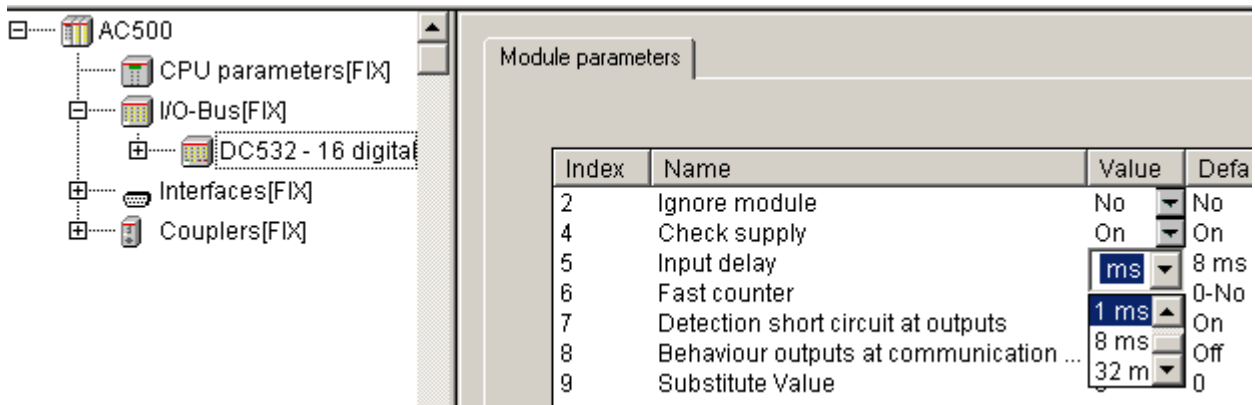

This way you can also configure the inputs and outputs of the S500-FBP interface module DC505-FBP in order to use them as decentralized inputs and outputs.

First click on the  symbol in front of the entry "DC532" and then click on this symbol in front of the entry "Digital Inputs 0-15[FIX]". The I/O address mapping in the CPU is displayed:

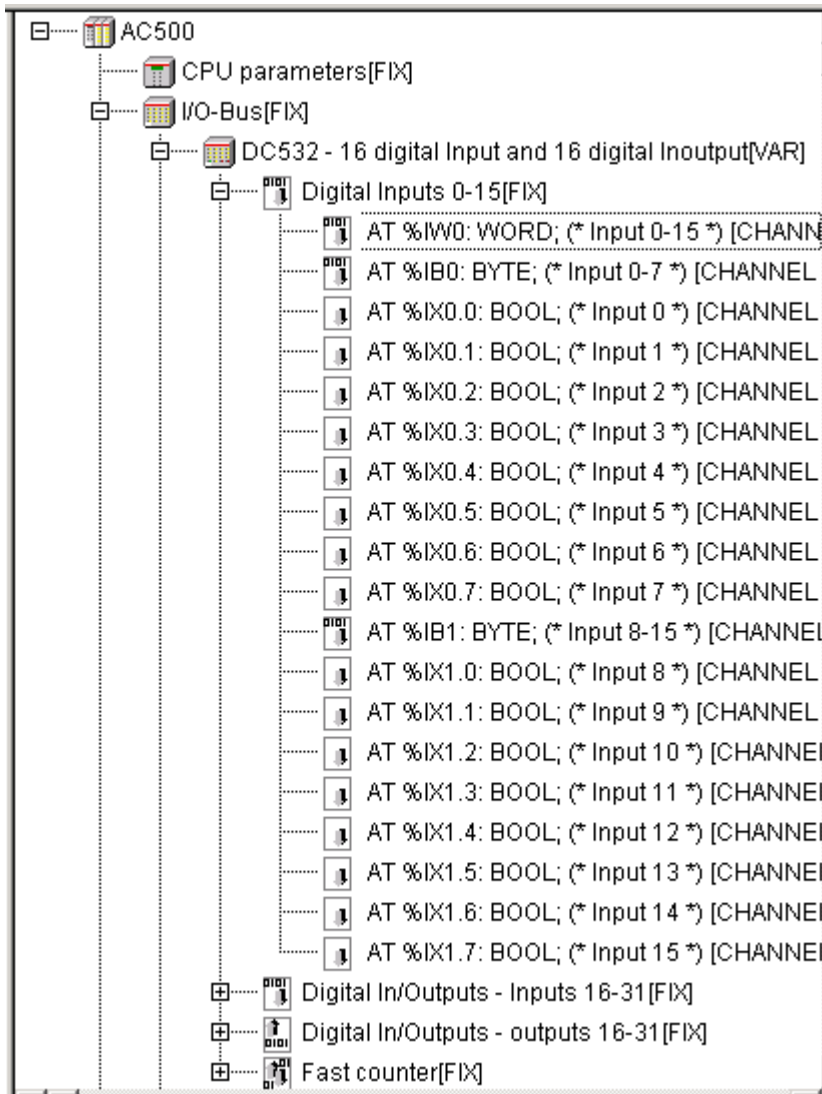

In our example, it is possible to access the digital inputs of the DC532 module as word using the address %IW0 (simultaneous access to the 16 inputs I0...I15) or as bytes (inputs 0 - 7 using the address %IB0, inputs I8 - I15 using the address %IB1) or as individual bits (addresses %IX0.0 to %IX0.7 for inputs I0 - I7 or %IX1.0 to %IX1.7 for the inputs I8 - I15).

 **ATTENTION**

In our example, the DC532 I/O expansion module used has digital inputs and also digital configurable inputs/outputs. These configurable I/Os are displayed in the I/O mapping either as inputs or as outputs according to how the channel will be used by the user!

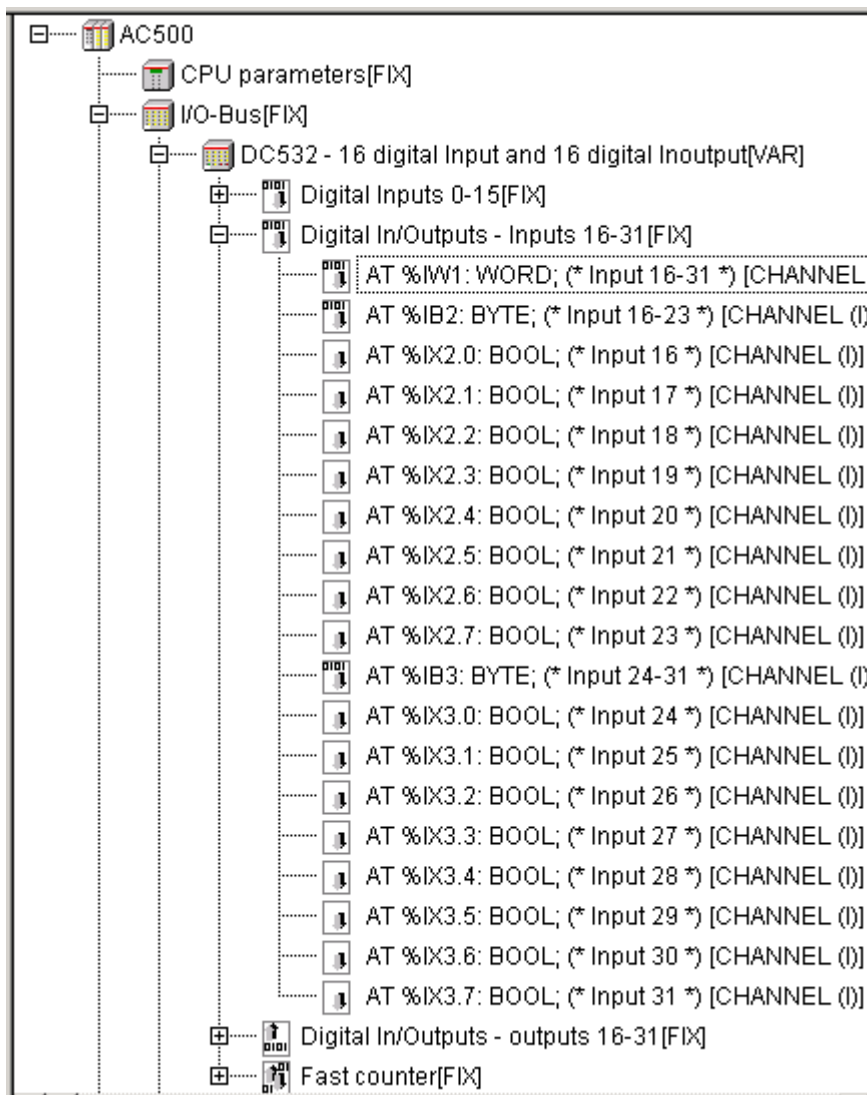

The I/Os will have the following CPU addresses in the CPU mapping table:

Channels	Address in the mapping / programming software	Comment
Digital inputs 0-15	%IW0	All the 16 digital inputs combined as Word from the DC532 module
Digital inputs 0-7	%IB0	All the 8 first digital inputs combined as Byte
Digital inputs 8-15	%IB1	All the 8 following digital inputs combined as Byte
Single digital input 0 to single digital input 7	%IX0.0 to %IX0.7	Single digital input as a bit for the input 0 to the input 7
Single digital input 8 to single digital input 15	%IX1.0 to %IX1.7	Single digital input as a bit for the input 8 to the input 15
Digital configurable inputs 16-31	%IW1	All the 16 digital configurable I/Os as inputs in combined as Word from the DC532 module
Digital configurable inputs 16-23	%IB2	All the 8 following digital configurable I/Os as inputs combined as Byte
Digital configurable inputs 24-31	%IB3	All the 8 following digital configurable I/Os as inputs combined as Byte
Single digital configurable input 16 to single digital configurable input 23	%IX2.0 to %IX2.7	Single digital configurable I/Os as input as a bit for the input 16 to the input 23
Single digital configurable input 24 to single digital configurable input 31	%IX3.0 to %IX3.7	Single digital configurable I/Os as input as a bit for the input 24 to the input 31
Digital configurable outputs 16-31	%QW0	All the 16 digital configurable I/Os as outputs combined as Word from the DC532 module
Digital configurable outputs 16-23	%QB0	All the 8 following digital configurable I/Os as outputs combined as Byte
Digital configurable outputs 24-31	%QB1	All the 8 following digital configurable I/Os as outputs combined as Byte
Single digital configurable output 16 to single digital configurable output 23	%QX0.0 to %QX0.7	Single digital configurable I/Os as output as a bit for the output 16 to the output 23
Single digital configurable output 24 to single digital configurable output 31	%QX1.0 to %QX1.7	Single digital configurable I/Os as output as a bit for the output 24 to the output 31

For more details concerning the I/O mapping, please refer to the AC500 User's manual.

Symbolic names for I/Os

In our example we use one digital input and one digital output. We want to label them with symbolic names. Proceed as follows: Click on the  symbol in front of "DC532" in order to display the I/O configuration:

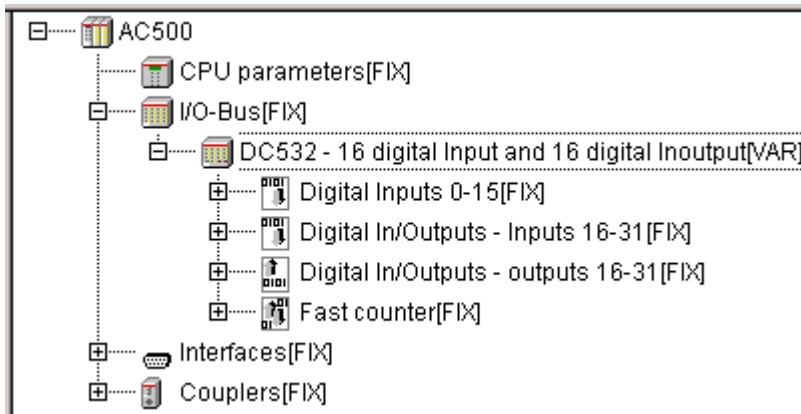

Now define a symbolic name for the digital input (digital input 0) as follows. First click on the  symbol in front of "Digital Inputs 0-15[FIX]":

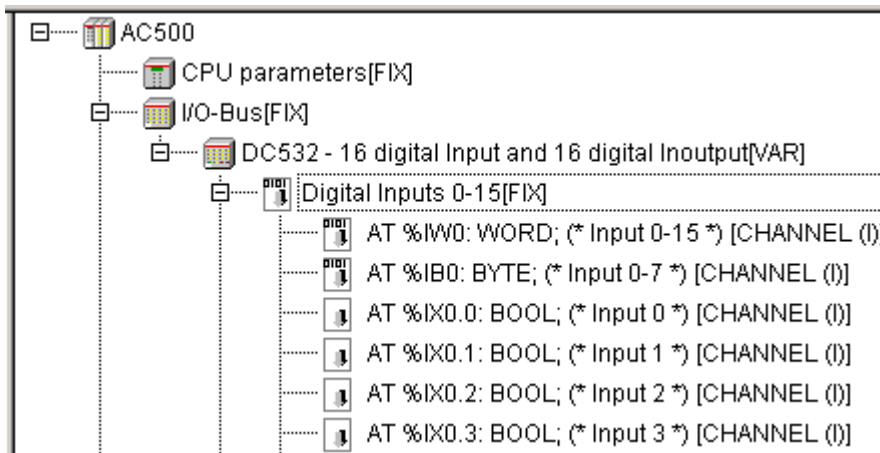

In the line of input 0, click twice on "AT". Then enter the symbolic name, e.g. I0dig.

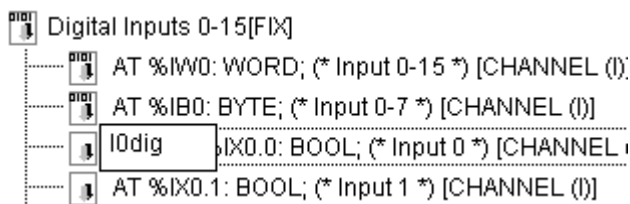

Complete your input by pressing the <Enter> key (displayed entry: I0dig AT %IX0.0 ...). Now the program can access this input by its symbolic name. Using the same procedure, we then have to label the digital output with a symbolic name. Click on the  symbol in front of the entry "Digital In/Outputs - outputs 16-31 [FIX]".

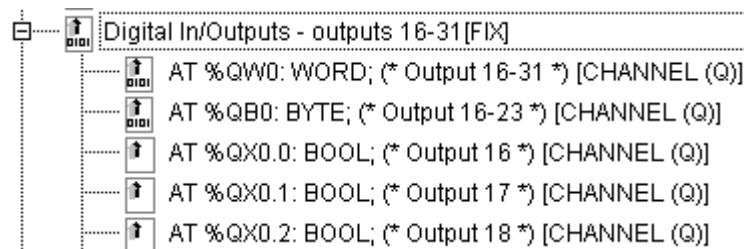

In the line of output 16, click twice on "AT". Then enter the symbolic name, e.g. O0dig, and complete your input by pressing <Enter>.

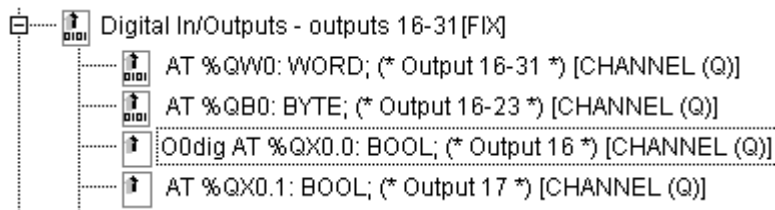

Opening the Function Block Diagram editor

From the Resources we now want to switch to the Function Block Diagram editor: Click on the POU\$ tab and then double click on the entry PLC_PRG (PRG). The Function Block Diagram editor is opened.

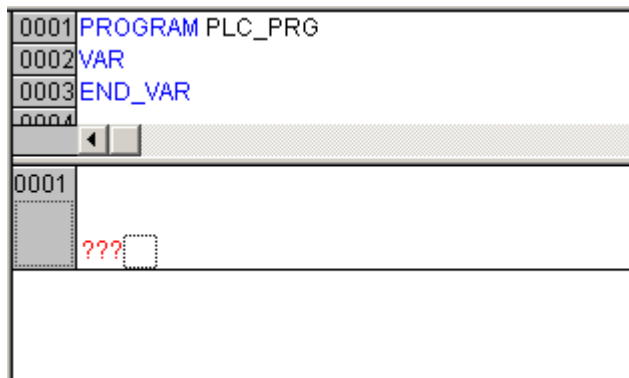

Position the mouse cursor into the insertion mark of network "0001" and press the right mouse button. Select "Assign".

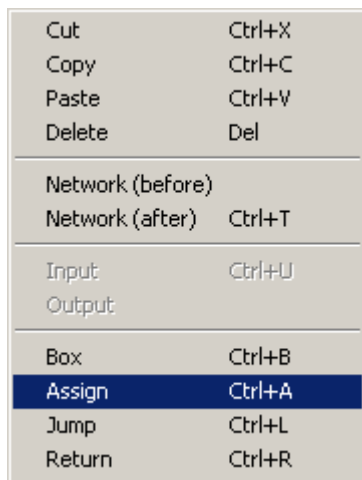

The display is as follows:

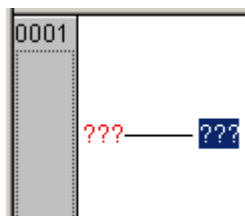

Now we have to enter the symbolic names previously assigned to the input and the output. Click on the left-hand question marks (???) and press <F2>. The Help Manager appears. Select "System Variables".



Select "I0dig" and confirm with "OK". Proceed in the same way for the output. At the end, click into the free area of network "0001".

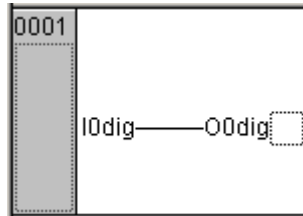

Compiling the project

The definition of the project is now completed and the project can be built. For this purpose, select the menu item "Project/Rebuild all".

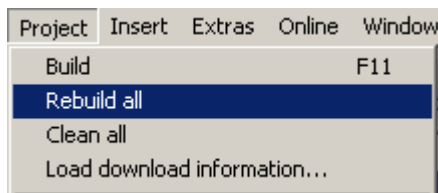

If no errors were detected, the message "0 errors, 0 warnings" is displayed in the message box.

Setting the communication parameters

In order to establish the connection between the PLC and the PC, the communication parameters have to be set. We are using the COM2 interface of the PLC and the COM1 interface of the PC or the COM interface of the PC assigned by the USB RS-232 converter. Switch to the Resources tab. Double click the object "PLC Configuration". In the configuration tree, click on the symbol in front of the "Interfaces[FIX]" element.

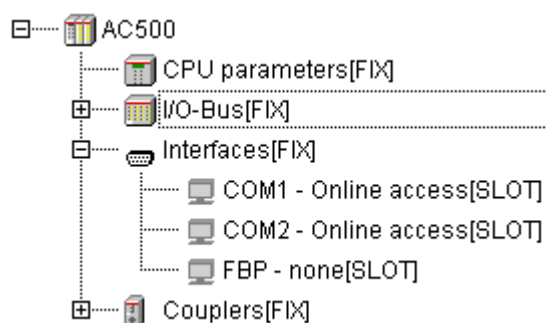

Click on the entry "COM2 - Online access[SLOT]" in order to display the default values of the PLC's COM2 interface.

Module parameters

Index	Name	Value	Default	Min.	Max.
11	Baudrate	19200	19200		
12	Parity	none	none		
13	Data bits	8	8		
14	Stop bits	1	1		

Then we have to define the PC interface settings. Select the menu item "Online/Communication Parameters".

Online	Window	Help
Login		Alt+F8
Logout		Ctrl+F8
Download		
Run		F5
Stop		Shift+F8
Reset		
Reset (cold)		
Reset (original)		
Toggle Breakpoint		F9
Breakpoint Dialog		
Step over		F10
Step in		F8
Single Cycle		Ctrl+F5
Write Values		Ctrl+F7
Force Values		F7
Release Force		Shift+F7
Write/Force-Dialog		Ctrl+Shift+F7
Show Call Stack...		
Display Flow Control		
Simulation Mode		
Communication Parameters...		

In the "Communication Parameters" dialog, click on the "Gateway" button and then select the entry "Local" from the "Connection" list box in the appearing dialog. Then confirm your settings with "OK".

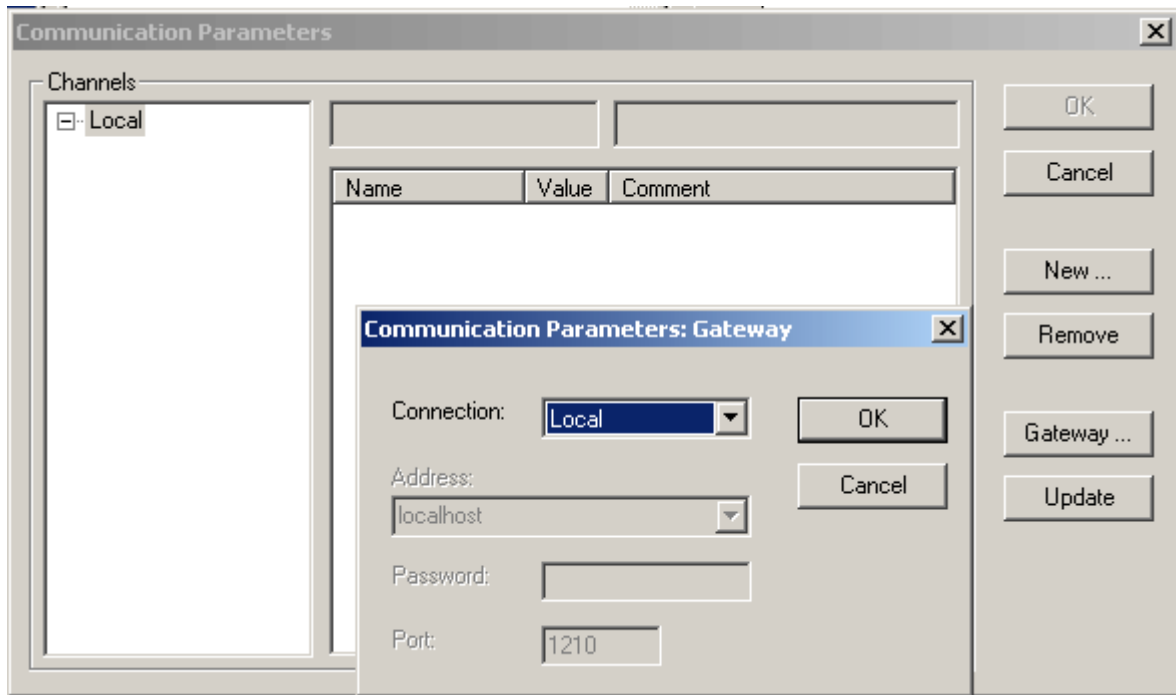

Now the "Communication Parameters" dialog displays the PC interface. Press the "New" button. Enter any name for the new channel, e.g. COM1_PC, and select "Serial [RS232]" for the "Device" (driver).

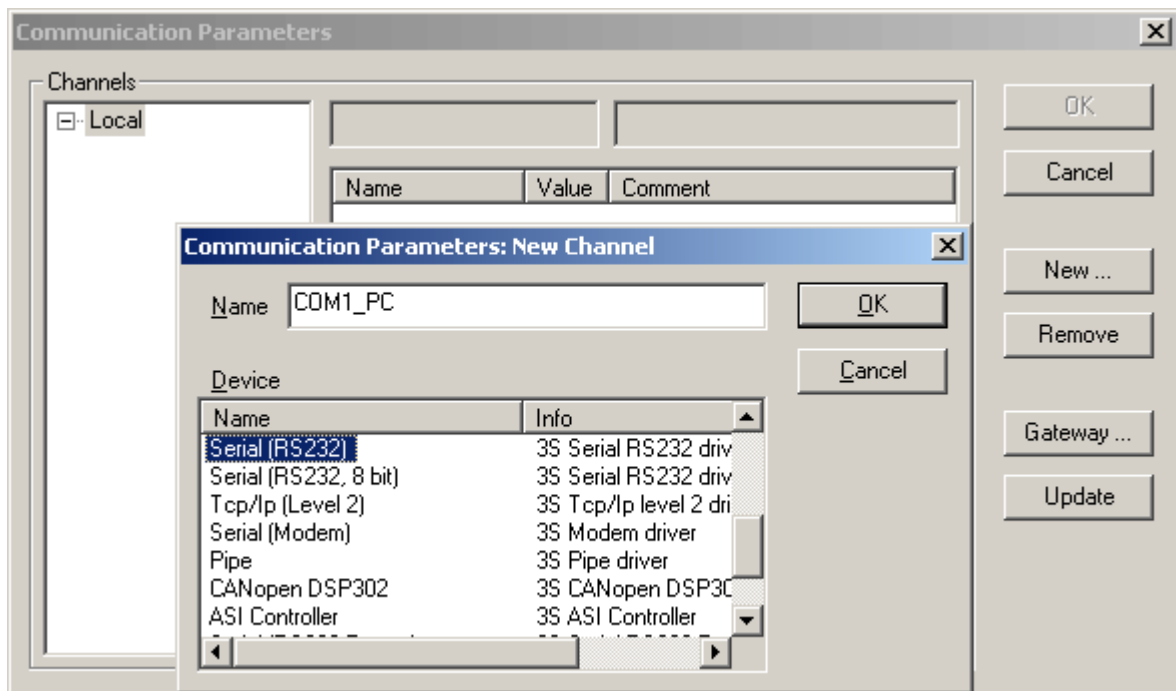

Confirm your settings with "OK".

Now we have to specify the corresponding parameters in the "Communication Parameters" dialog. Specify the serial interface of the PC with the parameter "Port": double click on the value of "Port", possibly several times. Click on the "Baudrate" value and then double click the value until "19200" is displayed. Proceed in the same way to change the "Motorola byteorder" setting from "No" to "Yes". Confirm your settings with "OK".

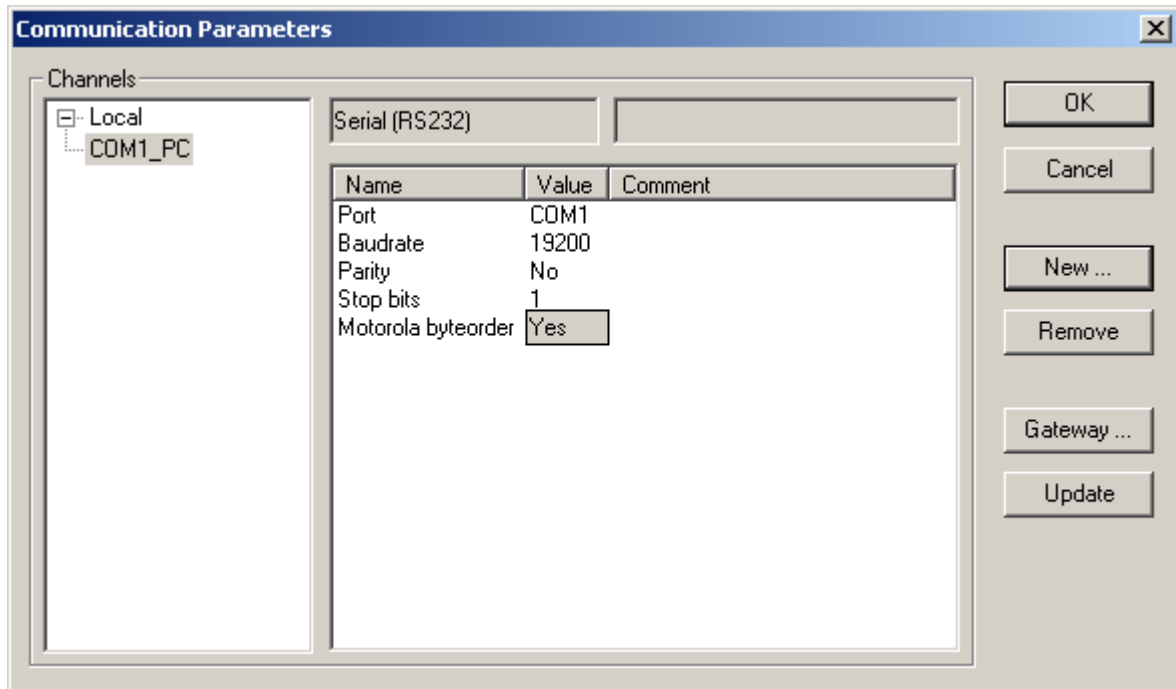

Testing the program with PLC hardware connected

Proceed as follows to test the program with PLC hardware connected:

Downloading the program to the PLC

First we have to load the program to the controller. To do this, select the menu item "Online/Login".

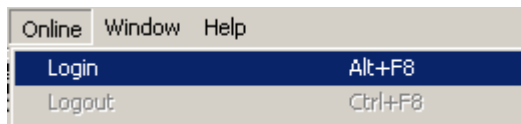

The software checks whether the project on the PLC is identical to the project on the PC. If the PLC does not yet contain a user program, the message "No program available in the controller. Should the new program be loaded" is displayed. If the project on the PLC differs from the project on the PC, the following message is displayed:

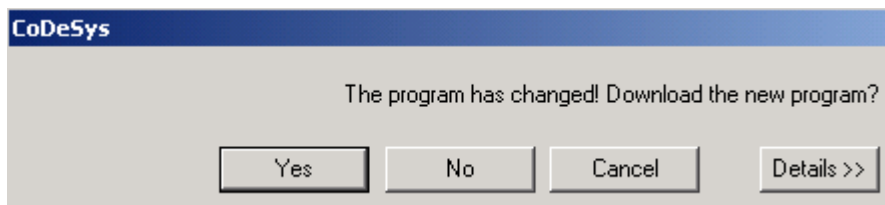

Select "Yes". Then the program is downloaded from the PC to the PLC. When starting the download process, the PLC changes to the STOP mode.

Now we are going to store our program in the Flash memory of the PLC to protect it against voltage breakdown. To do so, select "Online/Create boot project".

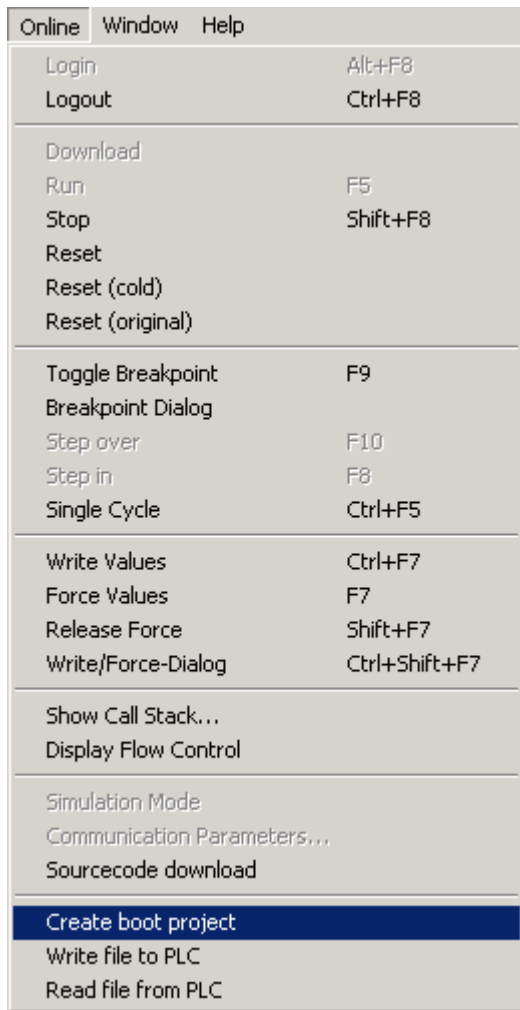

Starting the program

Now we want to run the program. Select the menu item "Online/Run":

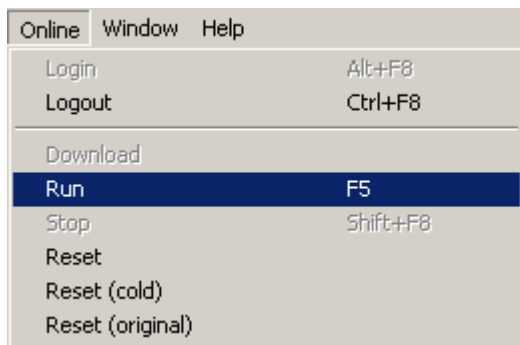

In order to test the program we are going to force input I0dig to TRUE: Double click to the input "I0dig":

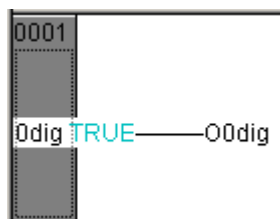

In order to set this value permanently, the Force function has to be used. With this function, the user defined value is set in the runtime system each time at the beginning and at the end of the program cycle.

Online	Window	Help
Login		Alt+F8
Logout		Ctrl+F8
Download		
Run		F5
Stop		Shift+F8
Reset		
Reset (cold)		
Reset (original)		
Toggle Breakpoint		
Breakpoint Dialog		F9
Step over		F10
Step in		F8
Single Cycle		Ctrl+F5
Write Values		
Force Values		Ctrl+F7
Release Force		F7
Write/Force-Dialog		Shift+F7
		Ctrl+Shift+F7

This way, the input is assigned to the output (i.e. set to TRUE) in each program cycle. The CoDeSys software displays the TRUE state in blue color (the FALSE state is displayed in black).

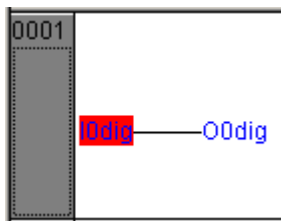

This way, the input I0dig is assigned to output O0dig.

Note: The status of the I/Os can also be displayed in the PLC configuration. Click on  Resources. Double click on “PLC configuration”.

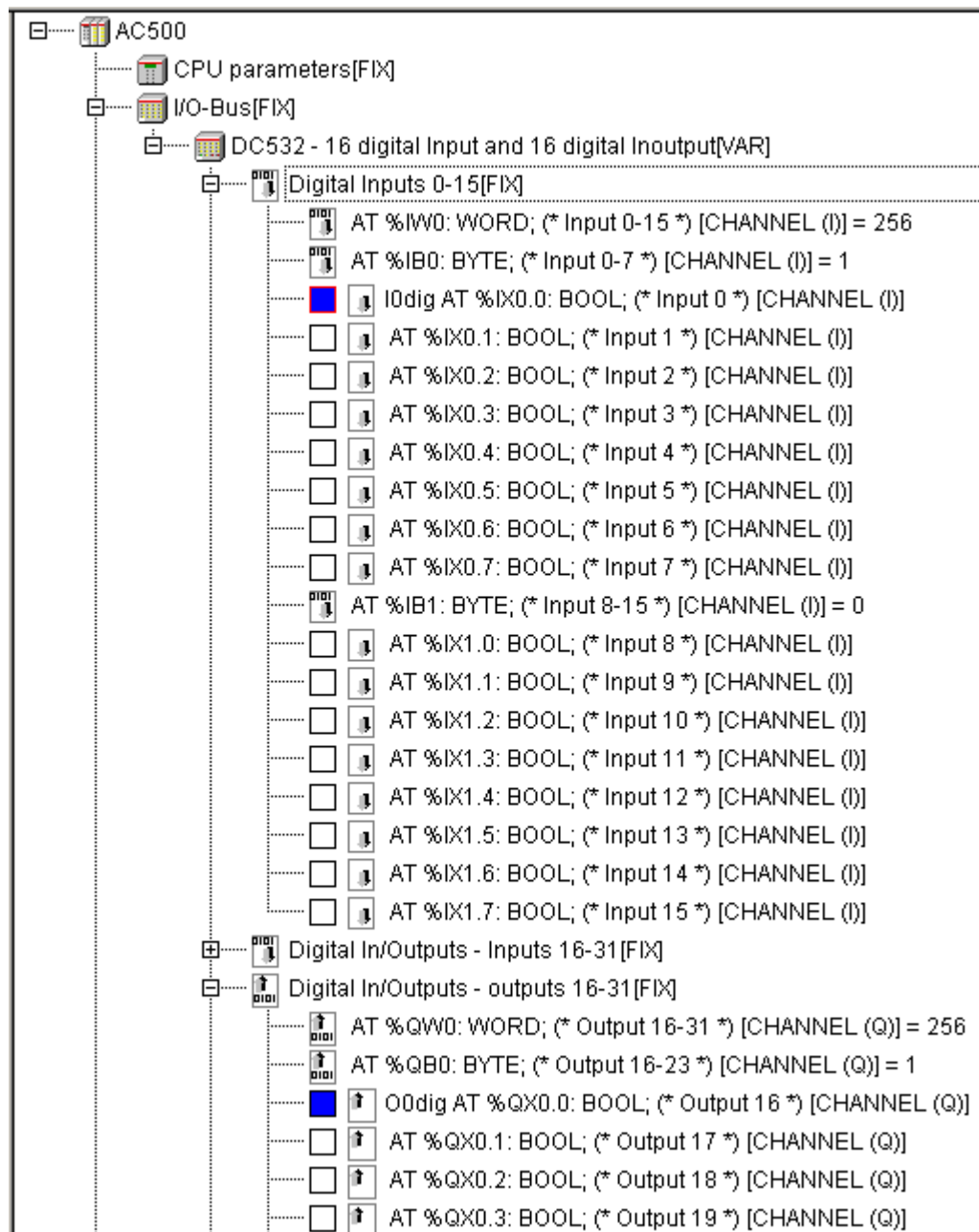

Using "Online/Logout", the connection to the PLC is disconnected and the Force function is canceled. To exit the CoDeSys software, select the menu item "File/Exit".

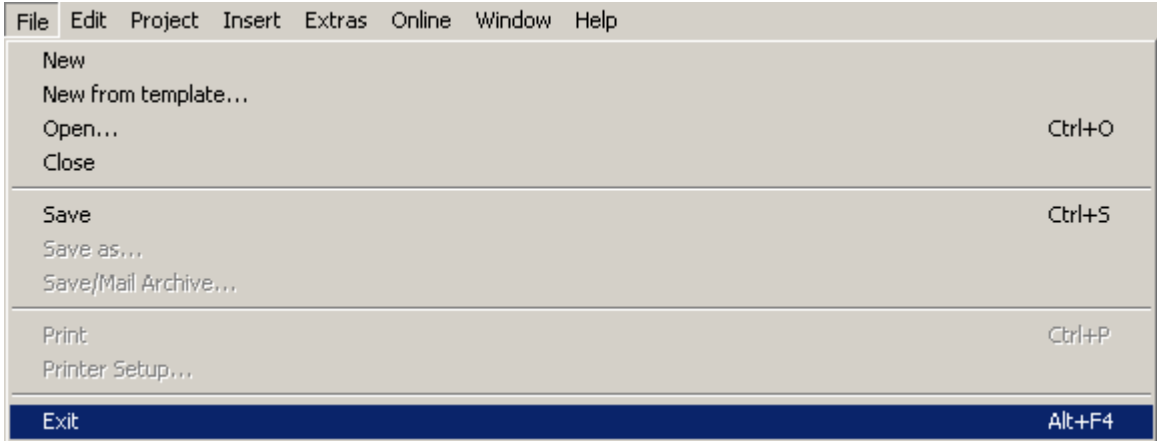

Examples for decentralized systems connected by network

On principle, the configuration of decentralized systems connected by network is done in two steps:

- The CPU has to be informed about which couplers are assigned to it (internal and/or external couplers).
- The couplers have to be informed about which peripheral devices are connected to them.

This is done using the tool SYCON.net (opened via the tab Resources -> Tools -> SYCON.net). This tool is also used to create the variables lists for the individual peripheral devices. The symbolic names created therein are directly (online) made available for the programming software. Thus, these created variables are located in the Global Variables folder.

Example with an AC500 CPU PM581 as PROFIBUS DP Master and a DC505-FBP as PROFIBUS DP slave with a FieldBusPlug PDP22-FBP

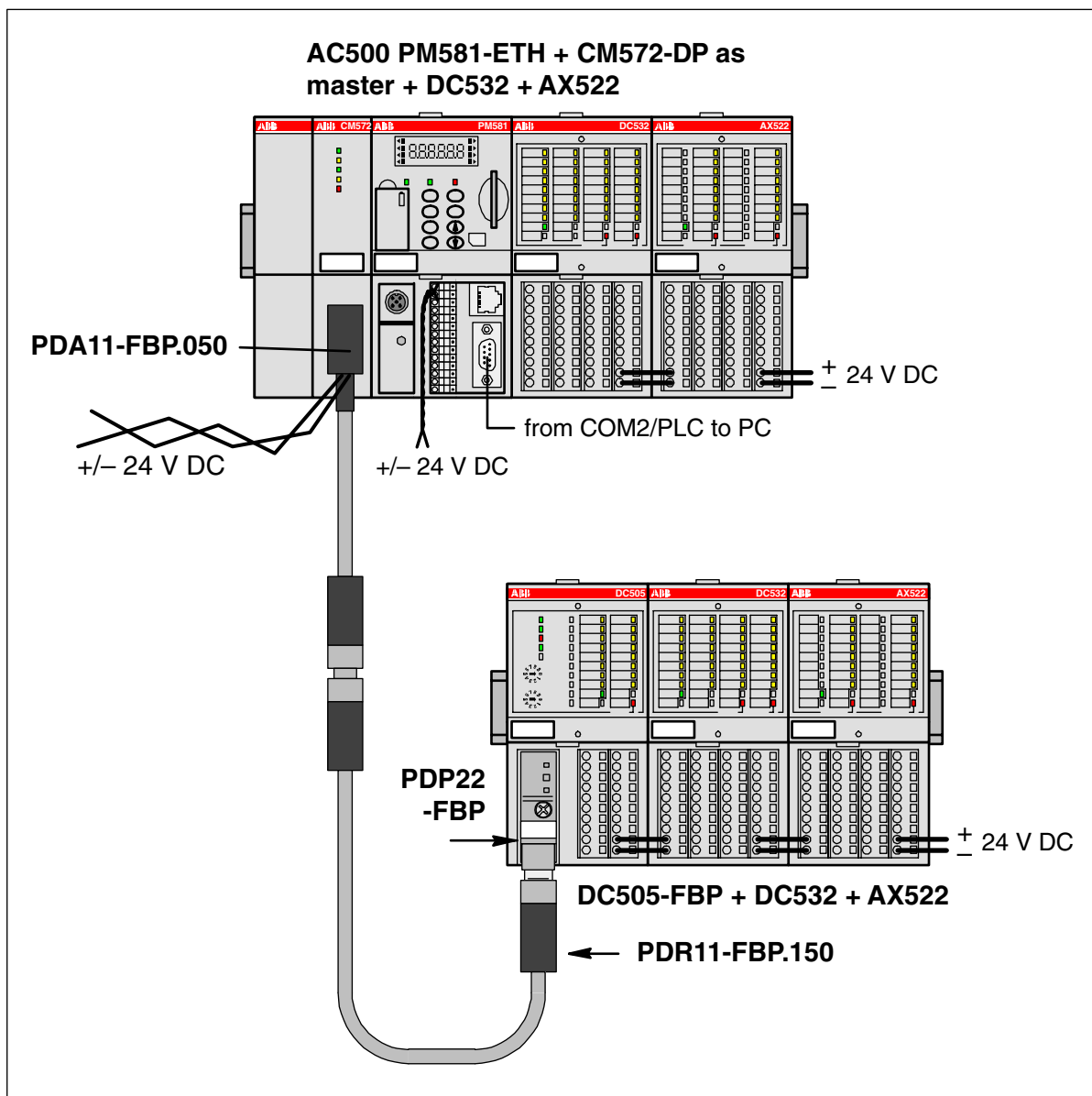



Figure: Example with an AC500 CPU as PROFIBUS DP master and a DC505-FBP as PROFIBUS DP slave. Note: "to PC" – either COM1 interface of PC, directly, or corresponding COM interface of PC, allocated via USB RS-232 converter.

The following example will guide you through the installation and the configuration of a small PROFIBUS DP fieldbus using an AC500 PLC as PROFIBUS DP master and a S500-FBP remote I/O station with a modular FBP.

This example could be used as starting point to develop your own application.

 ATTENTION	Refer to the dedicated User's manuals or Installation guides of the FieldBusPlug and the AC500 PLCs and programming software.
--	---

Needed products

	amount	product description	order number
<input checked="" type="checkbox"/>	1	PM581-ETH, CPU	1SAP 1401 00 R0170
<input checked="" type="checkbox"/>	1	CM572-DP, Communication Module PROFIBUS DP Master 12 Mb/s	1SAP 170 200 R0001
<input checked="" type="checkbox"/>	1	TB521-ETH, CPU Terminal Base AC500, 1x CPU Slot, 2x Coupler Slots, Ethernet RJ45 Connector	1SAP 1121 00 R0170
<input checked="" type="checkbox"/>	1	TA524, Dummy Coupler Module	1SAP 1806 00 R0001
<input checked="" type="checkbox"/>	1	TK501, Programming Cable, D-Sub / D-Sub	1SAP 1802 00 R0001
<input checked="" type="checkbox"/>	1	PDA11-FBP.050, Adapter M12-Dsub9-M12, cable length 0.50 m (field bus + power supply)	1SAJ 9240 09 R0005
<input checked="" type="checkbox"/>	1	PDP22-FBP.050 PROFIBUS DP-V0/V1-FBP 0.5 m, modular (FieldBusPlug)	1SAJ 2401 00 R1005
<input checked="" type="checkbox"/>	1	PDR11-FBP.150 Terminating resistor 150 Ohm	1SAJ 9240 07 R0001
<input checked="" type="checkbox"/>	1	DC505-FBP with 8DI/8DC	1SAP 2200 00 R0001
<input checked="" type="checkbox"/>	2	DC532 with 16DI/16DC	1SAP 2401 00 R0001
<input checked="" type="checkbox"/>	2	AX522 with 8AI/8AO	1SAP 2500 00 R0001
<input checked="" type="checkbox"/>	1	TU506, FBP Terminal Unit, Spring Terminals	1SAP 2100 00 R0001
<input checked="" type="checkbox"/>	4	TU516, I/O Terminal Unit, 24 V DC, Spring Terminals	1SAP 2120 00 R0001
<input checked="" type="checkbox"/>	1	GSD file for FBP module	ABB_091F.GSD
<input checked="" type="checkbox"/>	1	PS501-PROG, Control Builder AC500, Programming Software	1SAP 1901 00 R0001

Before starting with the following example, please:

- Use the previous installation instructions to assemble and mount the system, also refer to the dedicated Users manual of the PROFIBUS DP FBP, S500-FBP and AC500 PLCs.
- Make the wiring and provide supply power to the system (process supply) and to the FieldBusPlug (use dedicated accessory, e.g. PDA11-FBP.050 which allows connecting a PROFIBUS DP master with a 9 pins D-Sub and provides power supply for the FBP through a M12 connector).
- Set the slave address of the FBP to 2 with the front rotary switches of the S500 FBP-Interface module (chosen for this example; see also S500-FBP Getting started).
- Install the AC500 Control Builder programming software for AC500 PLCs
- Install the SYCON.net fieldbus configurator
- Install GSD and EDS files
- Connect the programming cable TK501 from the PC to the AC500 PLC
- Review all of the hardware instructions for your specific system to be sure you have completed all of the required preliminary steps prior to beginning the system configuration with the AC500 Control Builder programming software.
- Power up the system

Starting the programming software

Start the AC500 Control Builder programming software. Select "File/New" to create a new project.

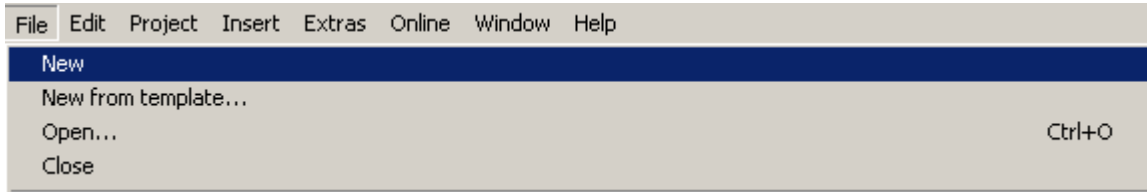

Select the desired CPU in the appearing window. In our example, select **PM581**.

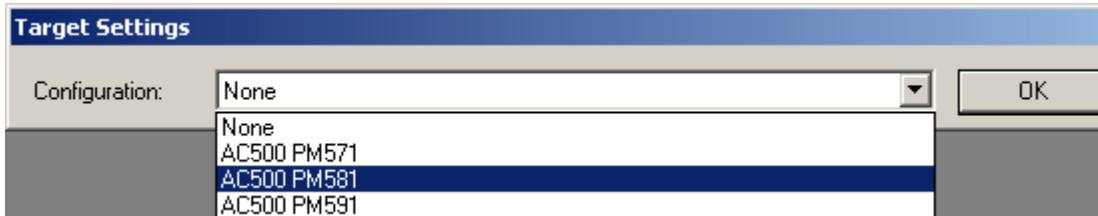

In the appearing window confirm with "OK".

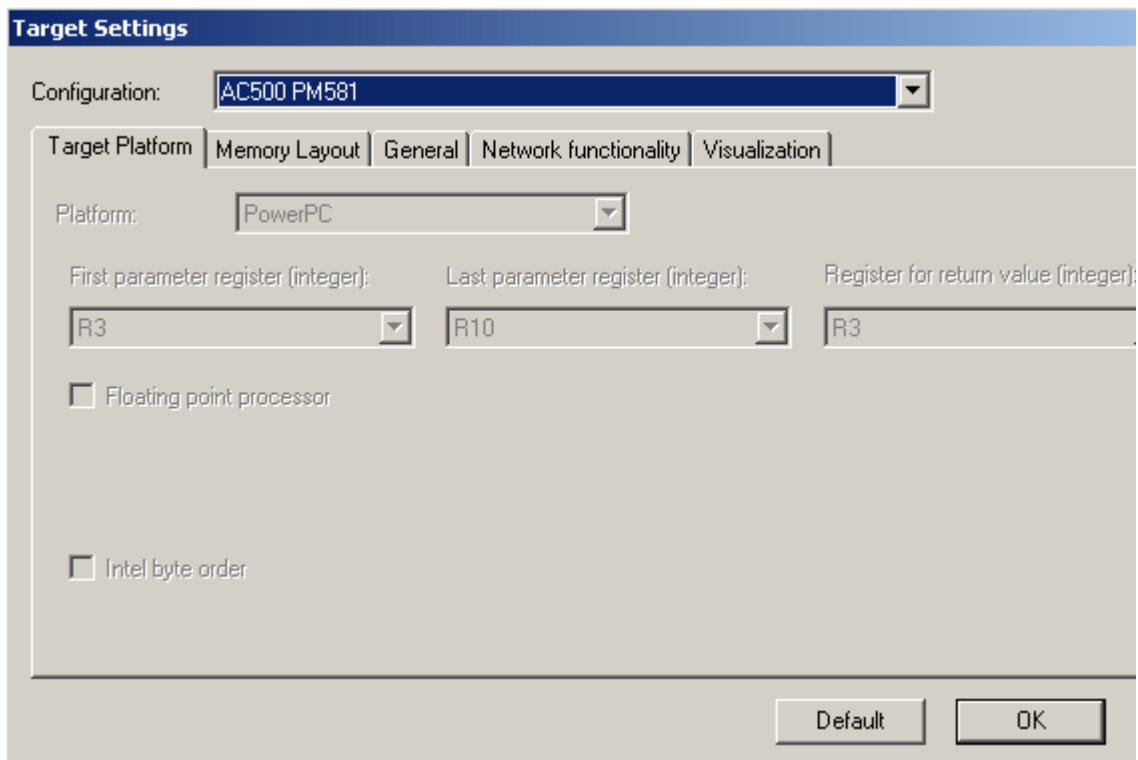

A window appears where you can select the POU name, type and language. For the name and the type keep the settings "PLC_PRG" and "Program". Select "ST" for the language and confirm with "OK".

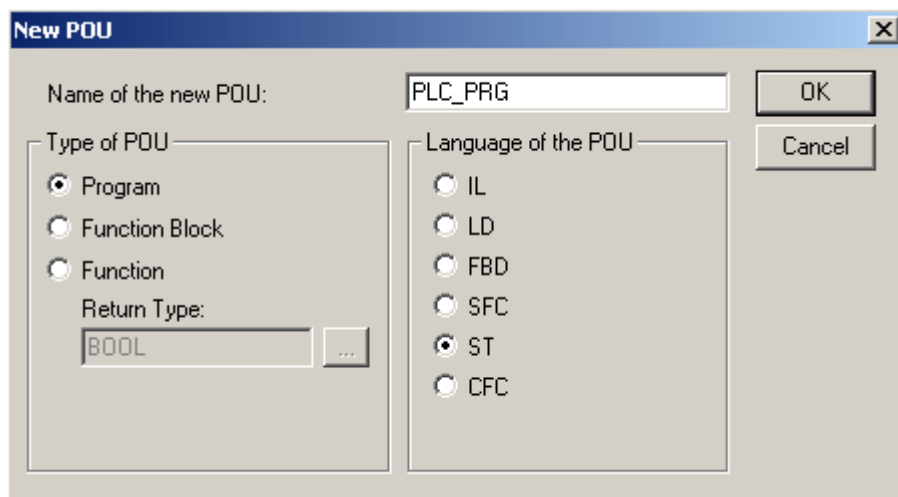

The ST editor is opened.

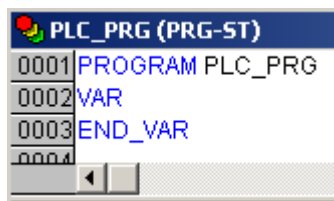

First, save the project under a specific name. Select the menu item "File/Save as".

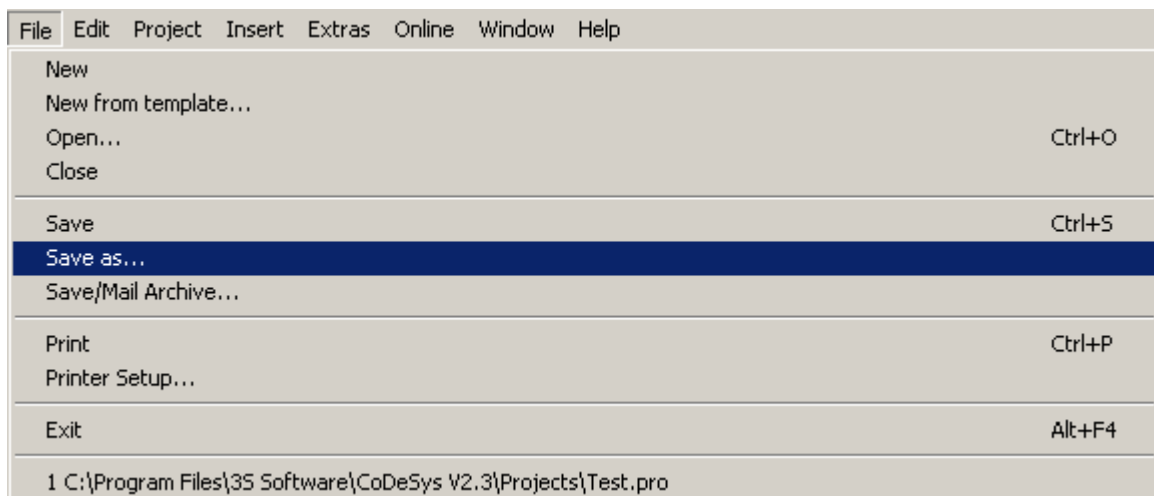

Select the desired directory and enter the project name (in our example: "Test3"). Complete your input with "Save".

Specifying the hardware configuration

The software has to be informed about the hardware configuration, i.e. the hardware configuration has to be specified in the software. Click on  Resources.

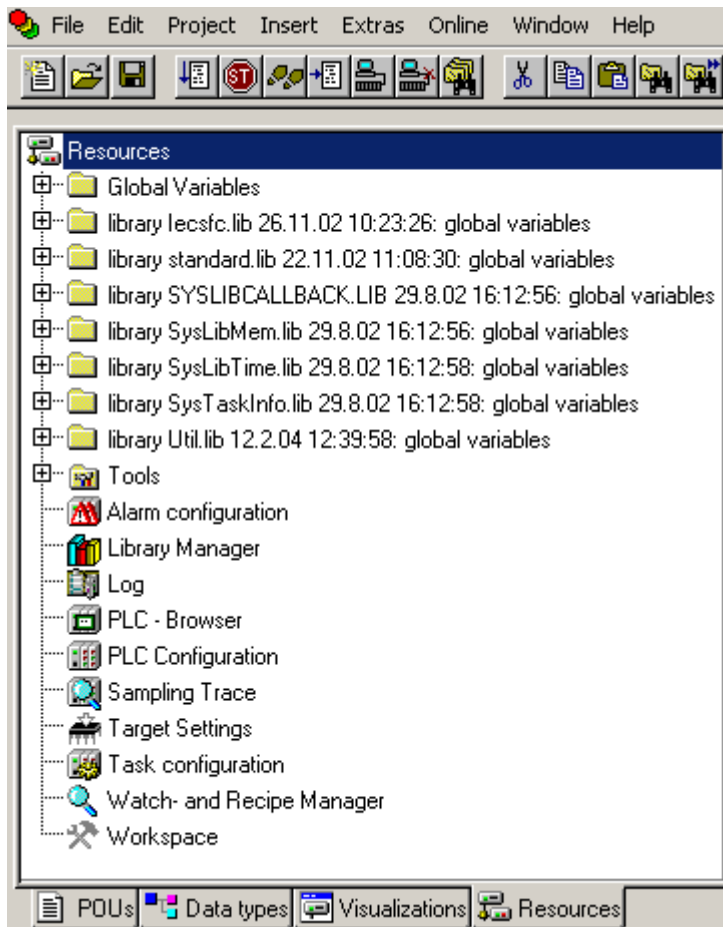

Double click the object "PLC Configuration". If the AC500 folder in the PLC configuration tree is closed, click on the  symbol.

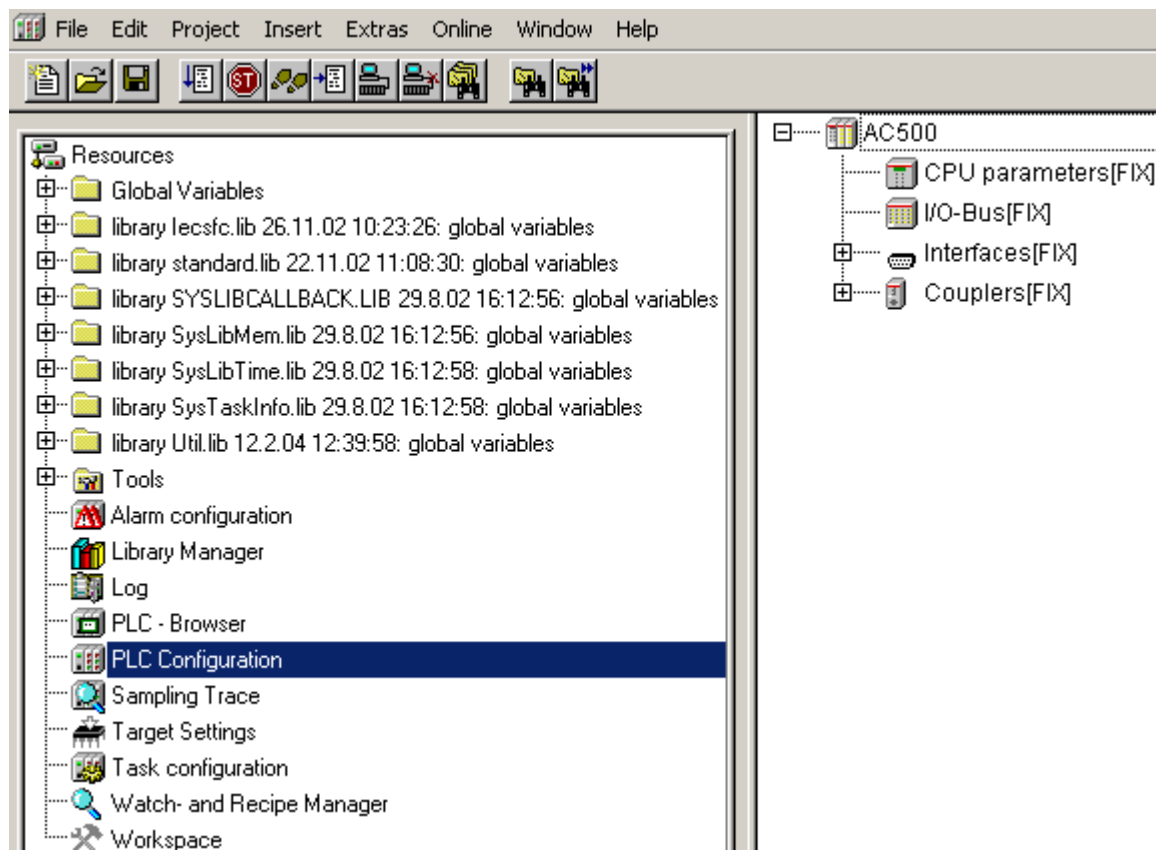

First the I/O devices connected directly to the I/O bus of the CPU will be entered: Click on "I/O-Bus[FIX]" and then press the right mouse button.

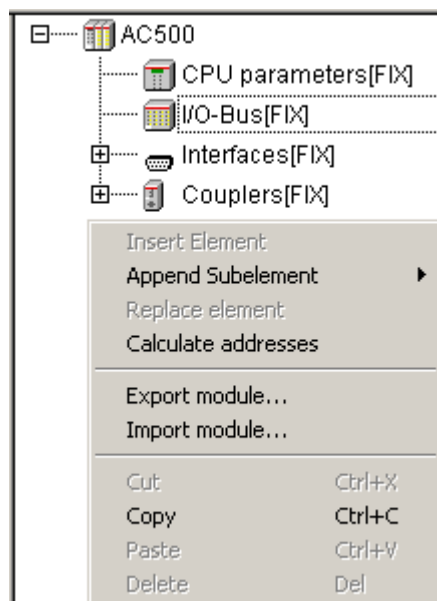

Select "Append Subelement" -> "DC532".

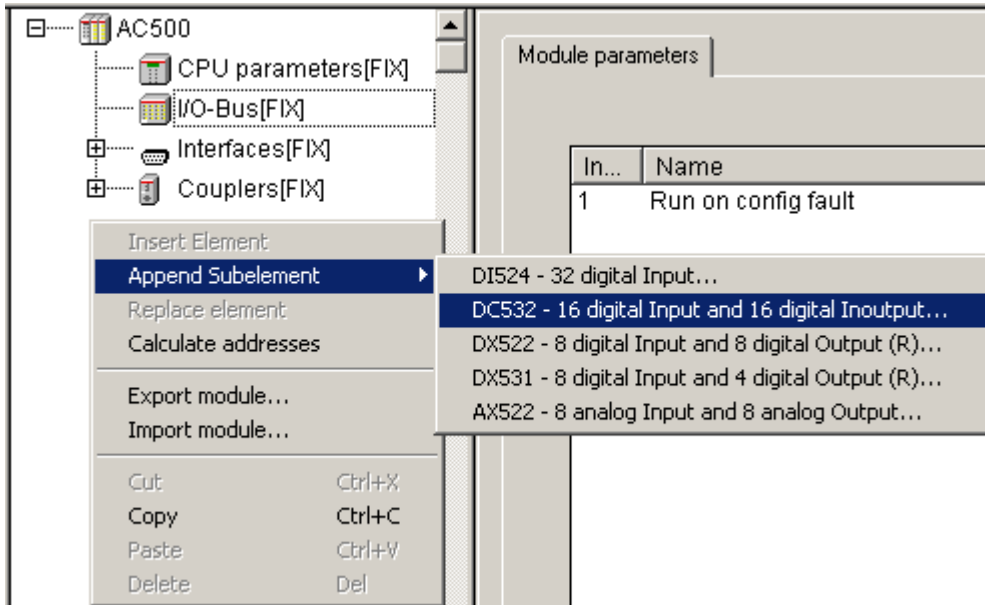

Repeat this procedure to append the analog module AX522.

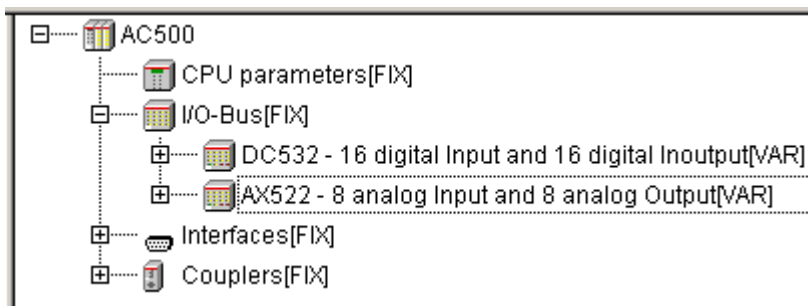
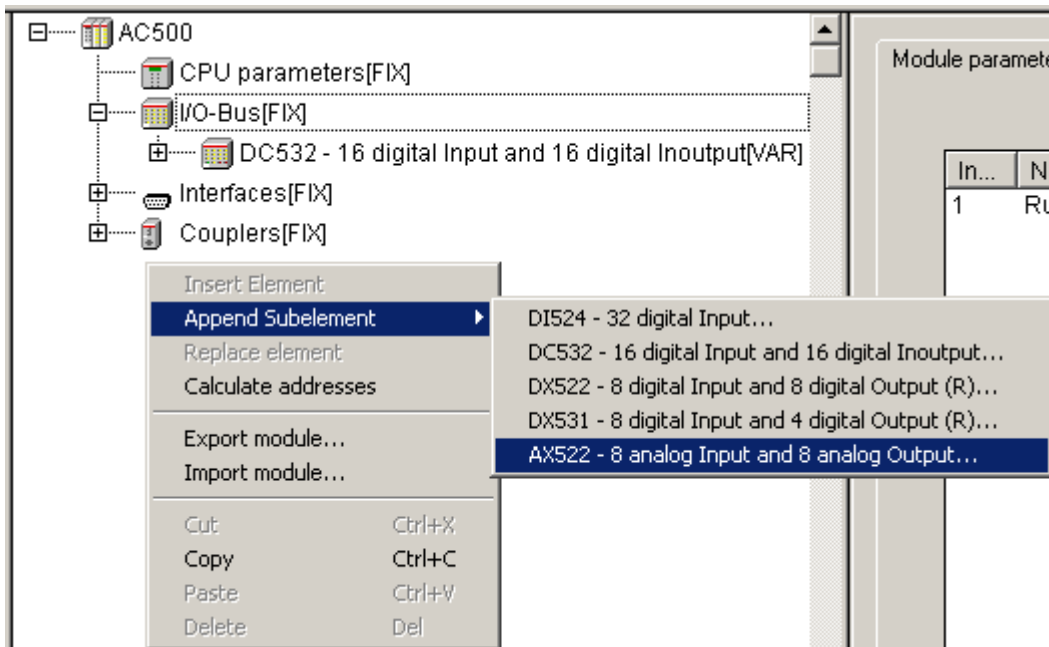

Now we are going to append the PROFIBUS DP communication module. In the configuration tree, click on "Couplers[FIX]" and then press the right mouse button. Select **Append Subelement -> CM572** and then click to append the element.

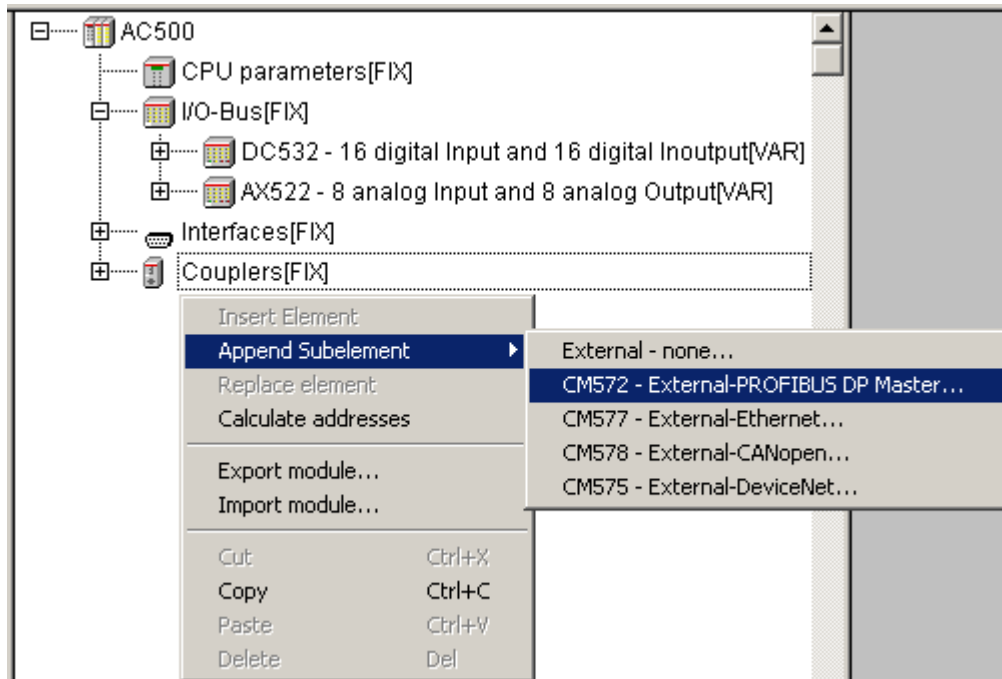

The coupler is appended to the tree. As the CPU also comprises an integrated Ethernet coupler we are going to replace 'Couplers – Internal none' by an Ethernet coupler.

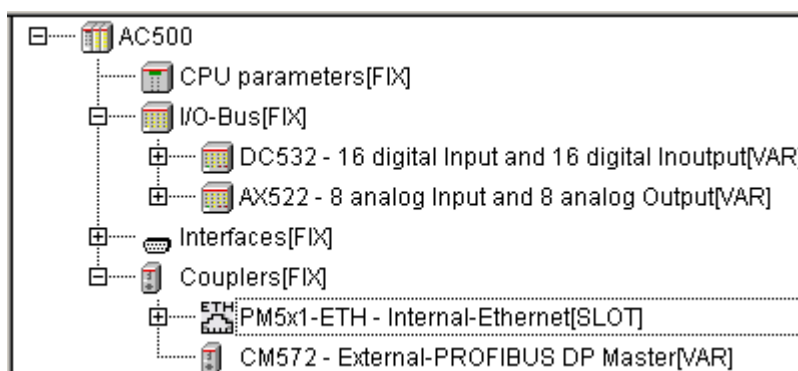
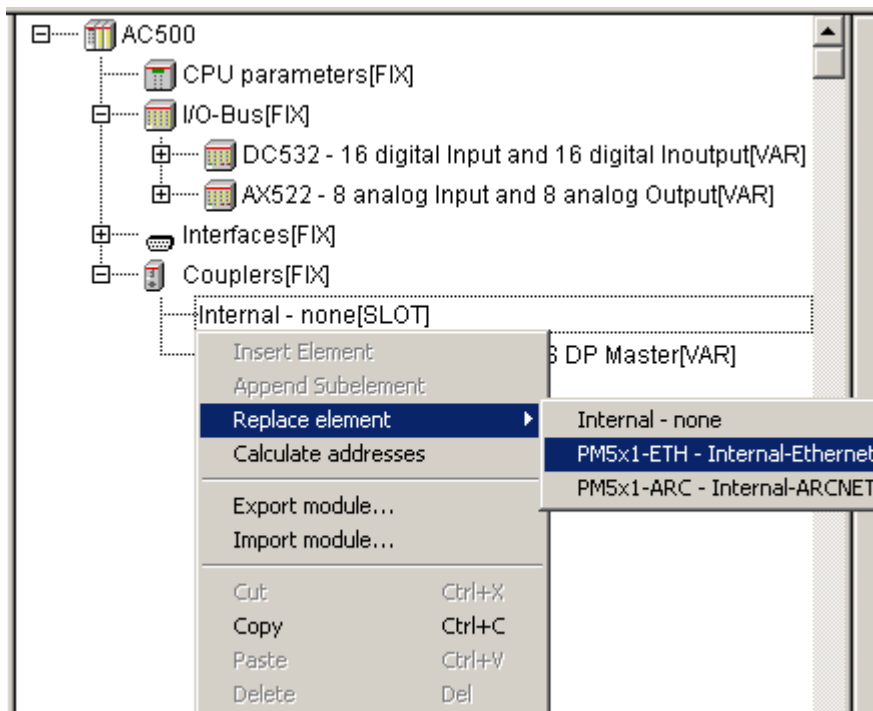

Configuring the decentralized S500-FBP I/O station using the SYCON.net fieldbus configurator

Now we are going to configure the decentralized S500-FBP I/O station. Proceed as follows:

- In the left-hand window, click on the  symbol in front of the **Tools** entry. Then double click the entry **SYCON.net**.
- The SYCON.net fieldbus configurator is opened. Using this configurator, you can configure the decentralized I/O station.

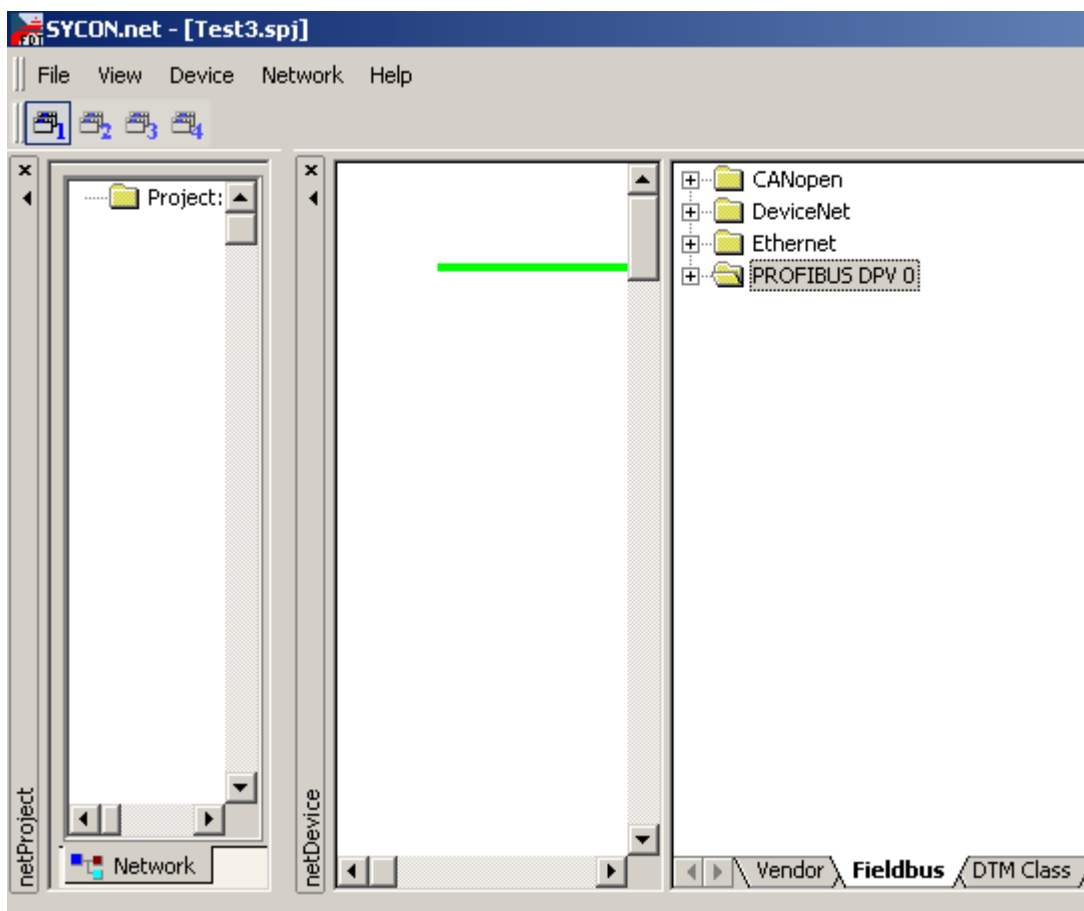
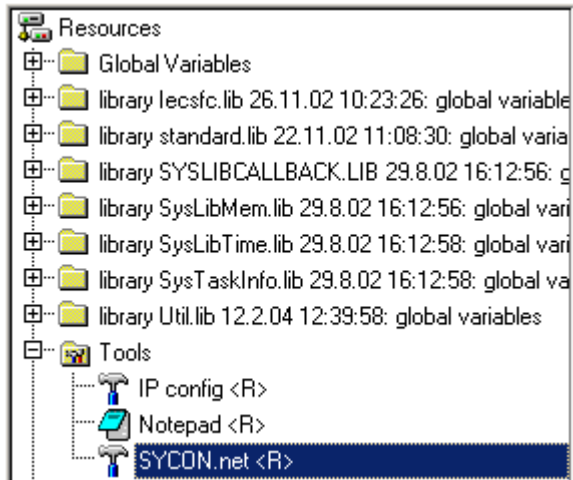

In the "Fieldbus" tab, open the folder 'PROFIBUS DPV 0' by clicking on the  symbol. Do the same with file "Master". With the left mouse button, click on CM572-DPM. Keep the left mouse button pressed and drag the object into the left window to append it to the green line (this line represents the connection to the CPU). Release the left mouse button.

In the appearing window, leave the "Board No. 1" unchanged (counting mode: CPU-internal coupler = Board No. 0, first coupler left of the CPU = Board No. 1, second coupler = Board No. 2).

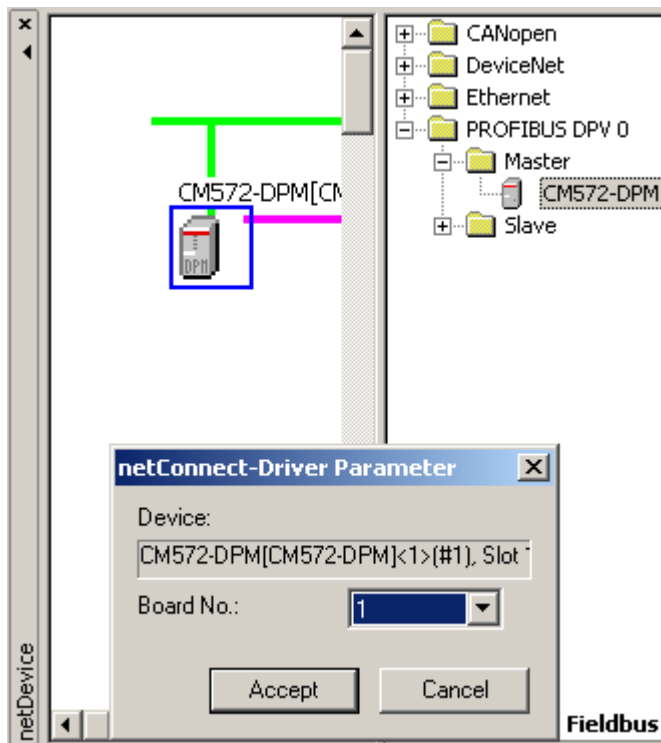

Click on "Accept". The coupler is now connected to the CPU.

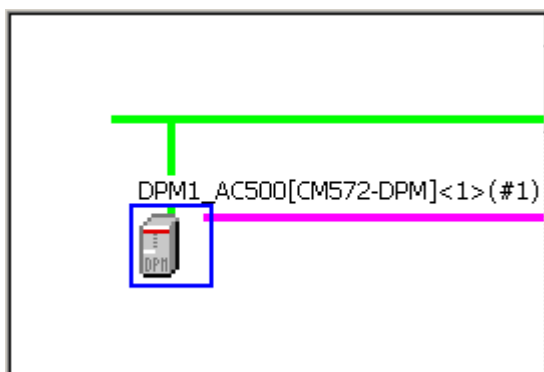

Recommendation: You can choose the symbolic coupler name according to your plant (mark coupler with left mouse button; the coupler is displayed with a blue rectangle; press right mouse button -> symbolic name. Example for symbolic name: DPM1_AC500).

The parameter settings of the communication coupler can be easily modified by double clicking on the coupler symbol (surrounded by a blue line). A window opens - click on "Configuration -> Bus Parameters". With that you can change the parameters.

Bus Parameters

Profile: PROFIBUS DP

Bus Parameters

Baud Rate: 12000 kBit/s Station Address: 1

Slot Time: 1000 tBit Target Rotation Time: 33430 tBit

Min. Station Delay Time: 11 tBit = 2.7858 ms

Max. Station Delay Time: 800 tBit GAP Actualization Factor: 10

Quiet Time: 9 tBit Max. Retry Limit: 4

Setup Time: 16 tBit Highest Station Address (HSA): 126

Bus Monitoring

Data Control Time: 120 ms Override slave specific Watchdog Control Time

Min. Slave Interval: 2000 µs Watchdog Control Time: 20 ms

Calculated Timing

Tid1: 76 ms

Tid2: 800 ms

Auto Clear ON

Values marked with this symbol should be adjusted to changes in the topology. **Adjust**

OK Cancel Apply Help

Change the desired parameters and then click **OK**.

The same procedure is used to append a slave to the PROFIBUS DP master CM572-DPM. Open the "Slave" folder in the "Fieldbus" tab. Drag the PROFIBUS DP FieldBusPlug PDP22-FBP (DPV1 modular) into the left-hand window to append it to the purple line (this line represents the PROFIBUS DP fieldbus).

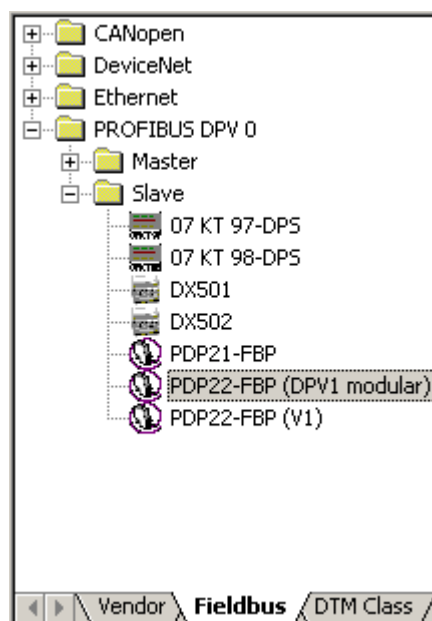

The FieldBusPlug slave is now appended to the PROFIBUS DP line. The symbolic name has been changed to DPS2_FBP_S500.

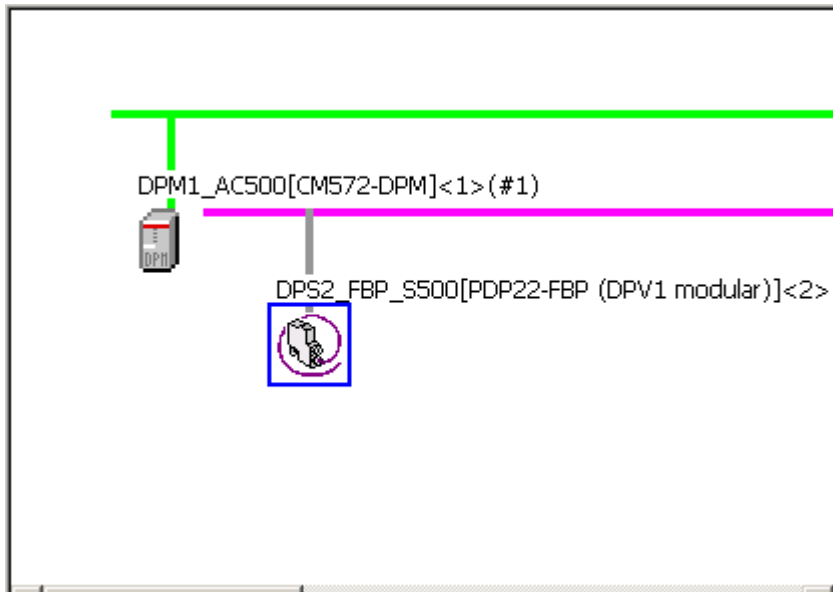

The slave has to be correctly software configured and mapped to precisely match the true hardware configuration. Double click on the PDP22-FBP symbol to open a new configuration window. In this window the hardware configuration is described and some parameter settings can be defined.

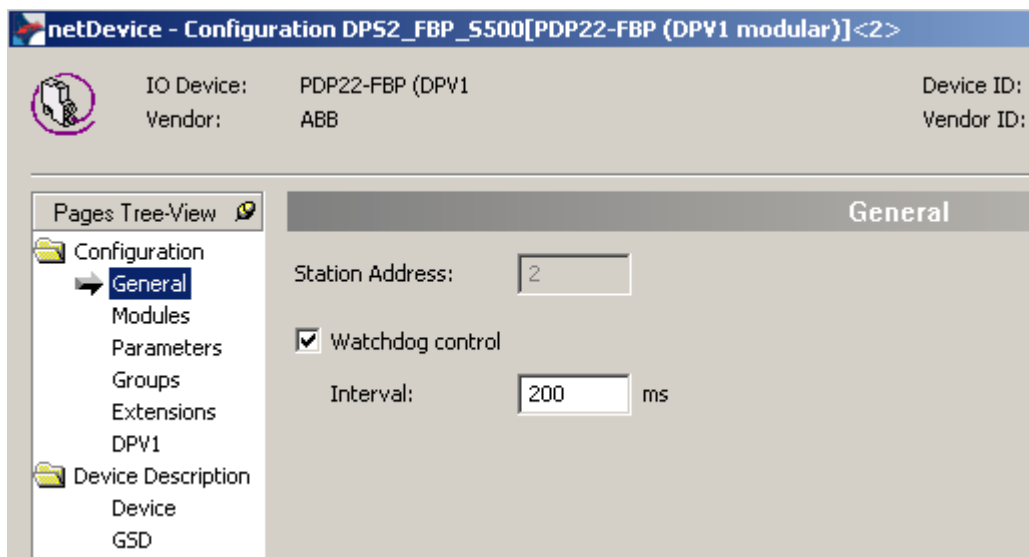

The slave station has to be set up. Click on "Configuration -> Modules" in the 'Pages Tree View'. First select the FBP interface module DC505-FBP from the list of available modules. Click on "Append". Thus the selected module is added to the list of configured modules.

Modules		
Available Modules:		
Module name	Module Configuration Identifier	
DC505-FBP	0x11,0x20	
DI524	0x13	
DC532	0x13,0x21	
DX531	0x10,0x20	
DX522	0x10,0x20	
AX522	0x57,0x67	
AC522	0x57,0x67	
AI523	0x5f	
		<input type="button" value="Insert"/> <input type="button" value="Append"/>
Configured Modules:		
Slot	Module name	Module Configuration Identifier
1	DC505-FBP	0x11,0x20
Length of input/output data: 3 bytes (max. 488 bytes)		<input type="button" value="Remove"/>
Length of input data: 2 bytes (max. 244 bytes)		
Length of output data: 1 bytes (max. 244 bytes)		
Number of modules: 1 (max. 8)		



ATTENTION

The order of the modules in the list of configured modules must match the actual order of hardware modules. Otherwise, the decentralized station and the network cannot work properly!

Repeat this procedure to append the modules DC532 and AX522. Then, the list of configured modules looks as follows:

Modules		
Available Modules:		
Module name	Module Configuration Identifier	
DC505-FBP	0x11,0x20	
DI524	0x13	
DC532	0x13,0x21	
DX531	0x10,0x20	
DX522	0x10,0x20	
AX522	0x57,0x67	
AC522	0x57,0x67	
AI523	0x5f	
<input type="button" value="Insert"/> <input type="button" value="Append"/>		
Configured Modules:		
Slot	Module name	Module Configuration Identifier
1	DC505-FBP	0x11,0x20
2	DC532	0x13,0x21
3	AX522	0x57,0x67
Length of input/output data: 41 bytes (max. 488 bytes) <input type="button" value="Remove"/>		
Length of input data: 22 bytes (max. 244 bytes)		
Length of output data: 19 bytes (max. 244 bytes)		
Number of modules: 3 (max. 8)		

Proceed as follows to configure the module parameters. Click on "Configuration -> Parameters". Select the corresponding module from the list.

Parameters	
Module:	<input type="text" value="Common"/> <input type="text" value="Common"/> <input type="text" value="DC505-FBP"/> <input type="text" value="DC532"/>
Display mode:	<input type="text" value="Hexadecimal"/>
Parameters:	<input type="text" value="Block-Parameter"/> <input type="text" value="Diagnosis Format"/>
Name	Value
Block-Parameter	Use Block-Parameters
Diagnosis Format	DPV0 Diagnosis Format

Click on the corresponding module.

The available parameters are displayed.

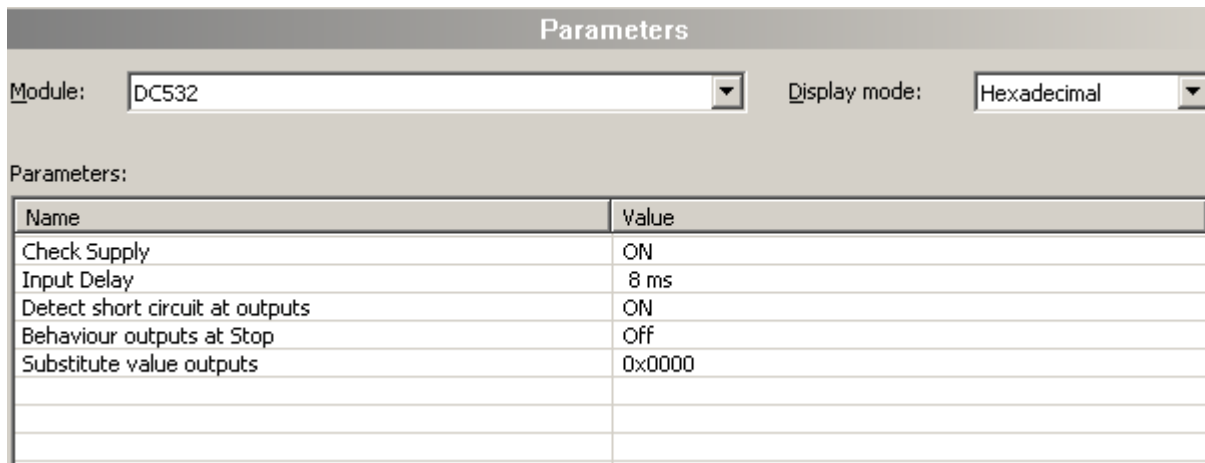

Parameters

Module: DC532 Display mode: Hexadecimal

Parameters:

Name	Value
Check Supply	ON
Input Delay	8 ms
Detect short circuit at outputs	ON
Behaviour outputs at Stop	Off
Substitute value outputs	0x0000

Example: Changing the input delay of the module DC532.

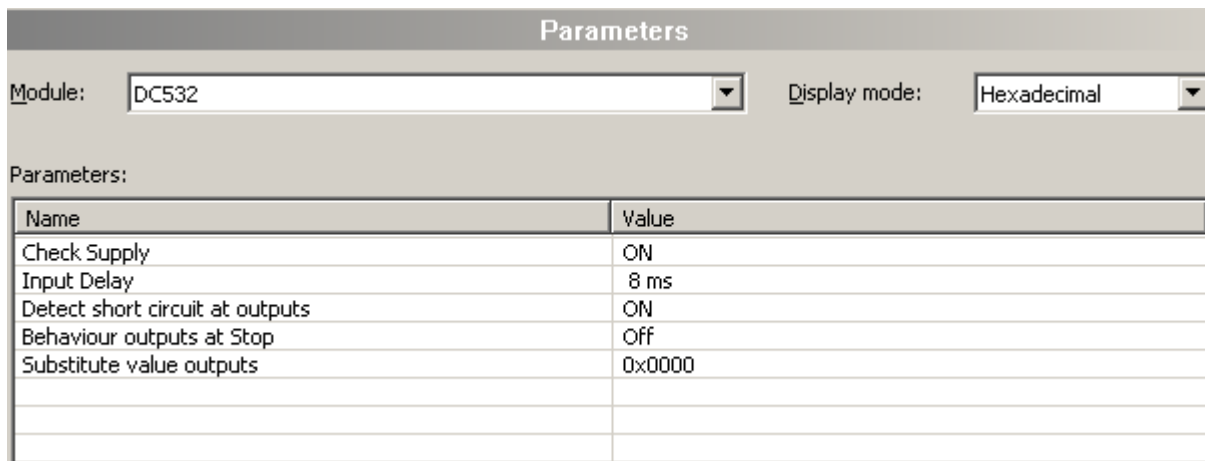

Parameters

Module: DC532 Display mode: Hexadecimal

Parameters:

Name	Value
Check Supply	ON
Input Delay	8 ms
Detect short circuit at outputs	ON
Behaviour outputs at Stop	Off
Substitute value outputs	0x0000

Highlight the line of the desired parameter: move the cursor to that line and press the left mouse button. Double click with the left mouse button onto the highlighted line. Click with the left mouse button on  to display the values available. Select the desired value by clicking with the left mouse button on that value. Click with the left mouse button into the area with the empty lines. Thus the change has been adopted.

After you have changed all the desired parameters, click on **OK** to exit the parameter configuration.

The configuration of the fieldbus modules is finished. Now the names of the communication variables used for data exchange between coupler and CPU program have to be specified. Proceed as follows to specify the variables (these variables are automatically forwarded to the AC500 Control Builder software in order to have them available there):

The upper part of the netConnect area contains a tree structure showing the master communication coupler CM572-DPM and the slave PDP22-FBP (DPV1 modular) with the sorted list appended. Click on the  symbol in front of the entry PDP22-FBP to open this branch of the tree. For each I/O module, a separate folder is displayed containing the corresponding data exchange variables.

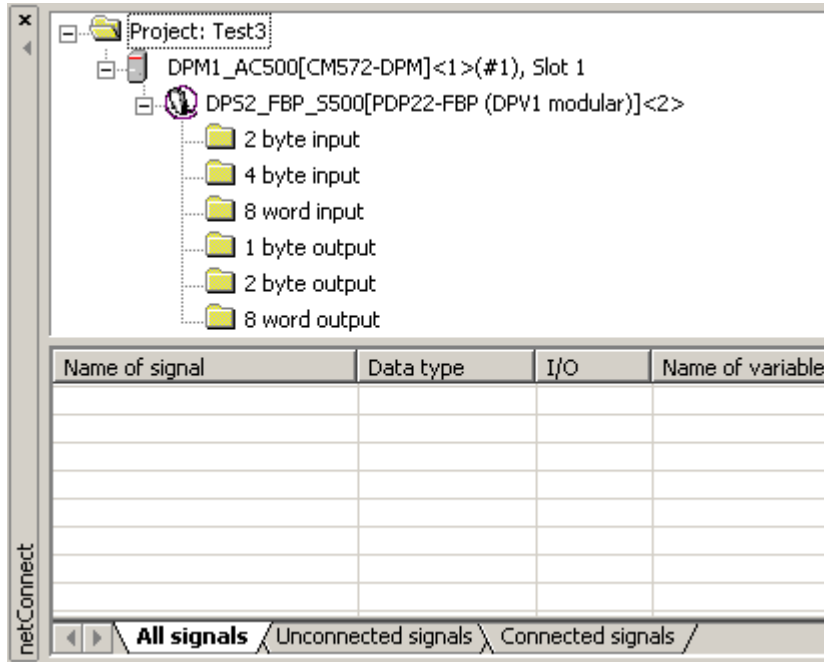

Click on the first folder **2 byte input**. This folder represents the digital inputs of the DC505-FBP module (8 DI + 8 DC as input). The corresponding variables are listed in the appended list (with **Name of signal**, **Data type**, **I/O** identifier (I = input, O = output) and **Name of variable** (can be entered)).

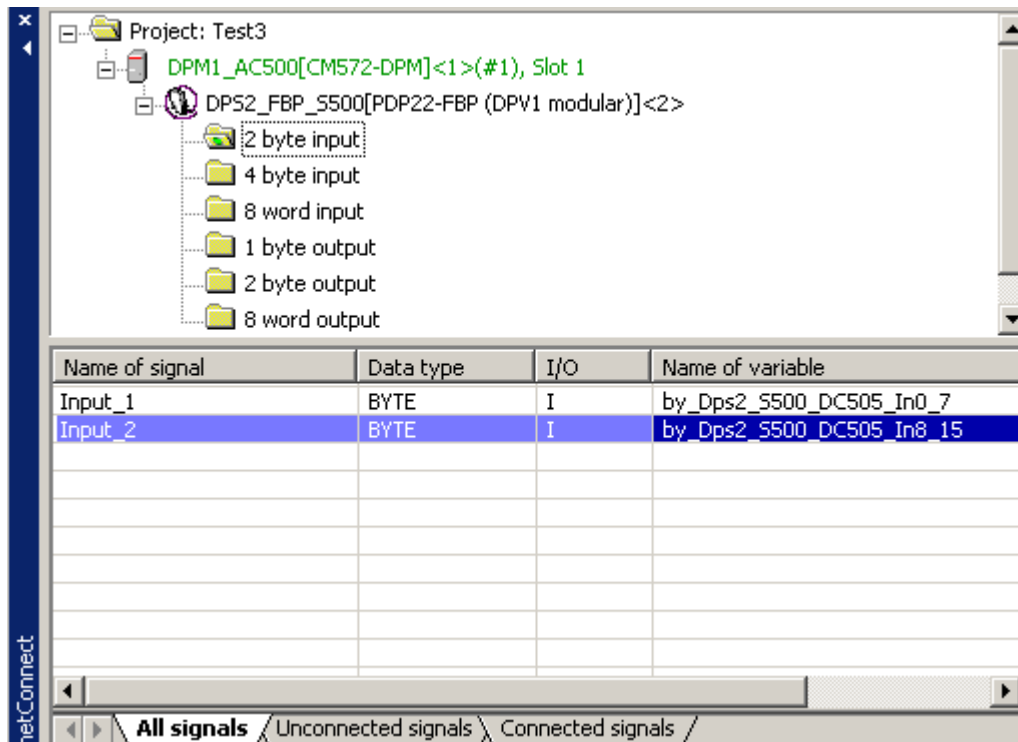

Enter a corresponding **“Name of variable”** for each **“Name of signal”**. To do this, double click into the **Name of variable** field of the corresponding signal. Enter the desired variable name and press the <Enter> key to complete your entry. These names are used in the AC500 Control Builder software. In our example, we use the following system for the variable name:
bytePROFIBUSDpslaveAddress2_S500(system)_DC505(device)_Input8_to15 (by - byte; b - bit; w - word).

Recommendation: For the planning of your plant we recommend to use symbolic names according to your plant.

Assign a name to each variable. For the 8 DC (as outputs) of the DC505-FBP module:

Name of signal	Data type	I/O	Name of variable
Output_1	BYTE	O	byDps2_S500_DC505_Out8_15

For the 16 DI + 16 DC (as inputs) of the DC532 module:

Name of signal	Data type	I/O	Name of variable
Input_1	BYTE	I	byDps2_S500_DC532_In0_7
Input_2	BYTE	I	byDps2_S500_DC532_In8_15
Input_3	BYTE	I	byDps2_S500_DC532_In16_23
Input_4	BYTE	I	byDps2_S500_DC532_In24_31

For the 8 analog outputs of the analog module AX522:

The screenshot shows the 'netConnect' window. The project tree on the left is expanded to show the following structure:

- Project: Test3
 - DPM1_AC500[CM572-DPM]<1>(#1), Slot 1
 - DPS2_FBP_S500[PDP22-FBP (DPV1 modular)]<2>
 - 2 byte input
 - 4 byte input
 - 8 word input
 - 1 byte output
 - 2 byte output
 - 8 word output

Below the tree is a table with the following data:

Name of signal	Data type	I/O	Name of variable
Output_1	WORD	O	wDps2_S500_AX522_Out1
Output_2	WORD	O	wDps2_S500_AX522_Out2
Output_3	WORD	O	wDps2_S500_AX522_Out3
Output_4	WORD	O	wDps2_S500_AX522_Out4
Output_5	WORD	O	wDps2_S500_AX522_Out5
Output_6	WORD	O	wDps2_S500_AX522_Out6
Output_7	WORD	O	wDps2_S500_AX522_Out7
Output_8	WORD	O	wDps2_S500_AX522_Out8

At the bottom of the window, there are navigation buttons and tabs labeled 'All signals', 'Unconnected signals', and 'Connected signals'.

After completion of the variables configuration, the fieldbus configuration is finished.

Store the project via "File -> Save".

Loading the configuration from SYCON.net to the coupler

Now the configuration has to be loaded from SYCON.net to the coupler CM572-DP. Proceed as follows:
In the netDevice window, click on the coupler to highlight it with a blue frame:

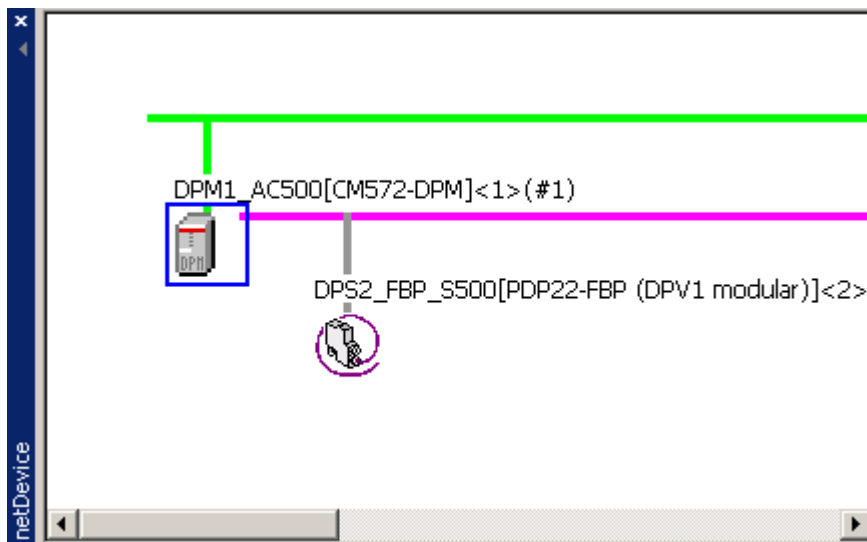

Double click on the coupler icon and select "Settings -> Driver -> 3S Gateway Driver".

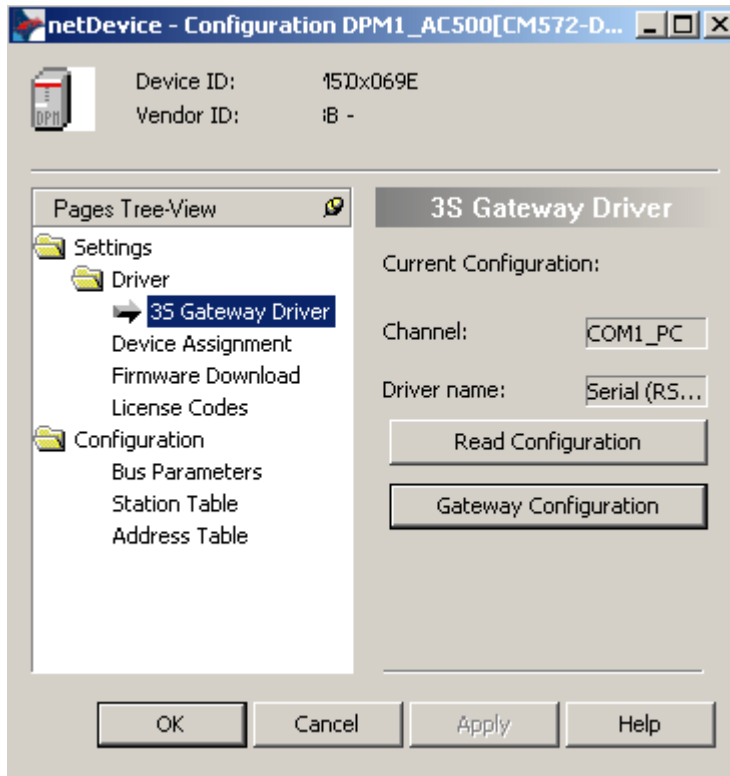

Select "Gateway Configuration".

In the Communication Parameters window, you can set the parameters for the communication between the PC and the PLC (port: serial interface of the PC).

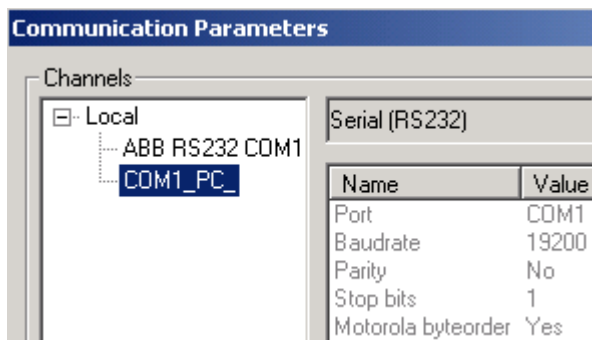

The coupler entry CM572-DPM is now highlighted in green, indicating that the connection is established:

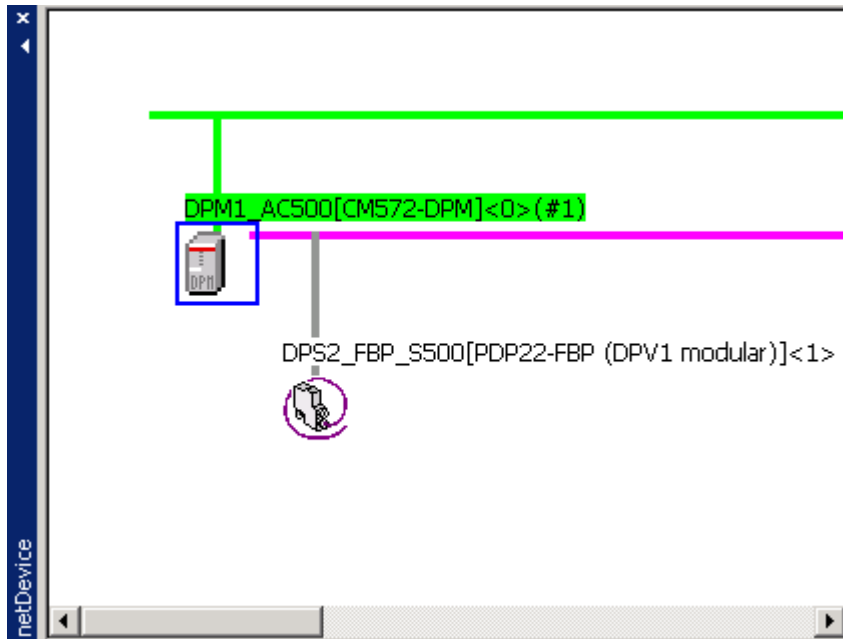

Press the right mouse button and select "Download".

ATTENTION: To do this the CPU must be in 'Stop' state.

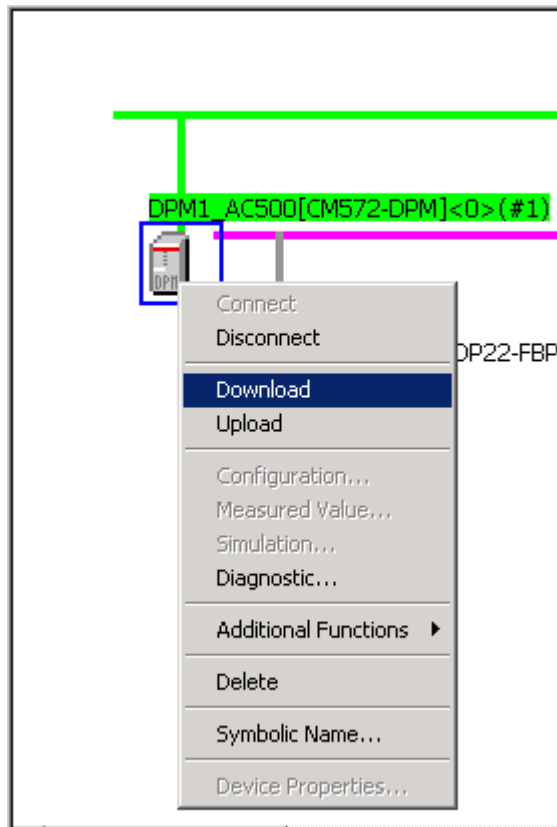

A safety inquiry is displayed. Confirm with "Yes".

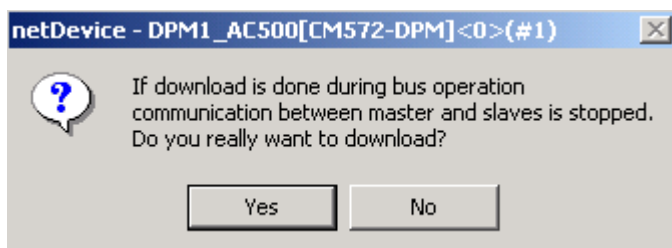

This downloads the configuration to the coupler. Progress of data transfer is displayed.

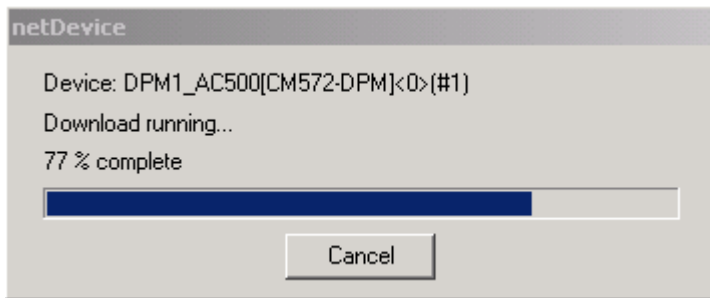

After the download is completed, SYCON.net has to be disconnected. Press the right mouse button and select "Disconnect".

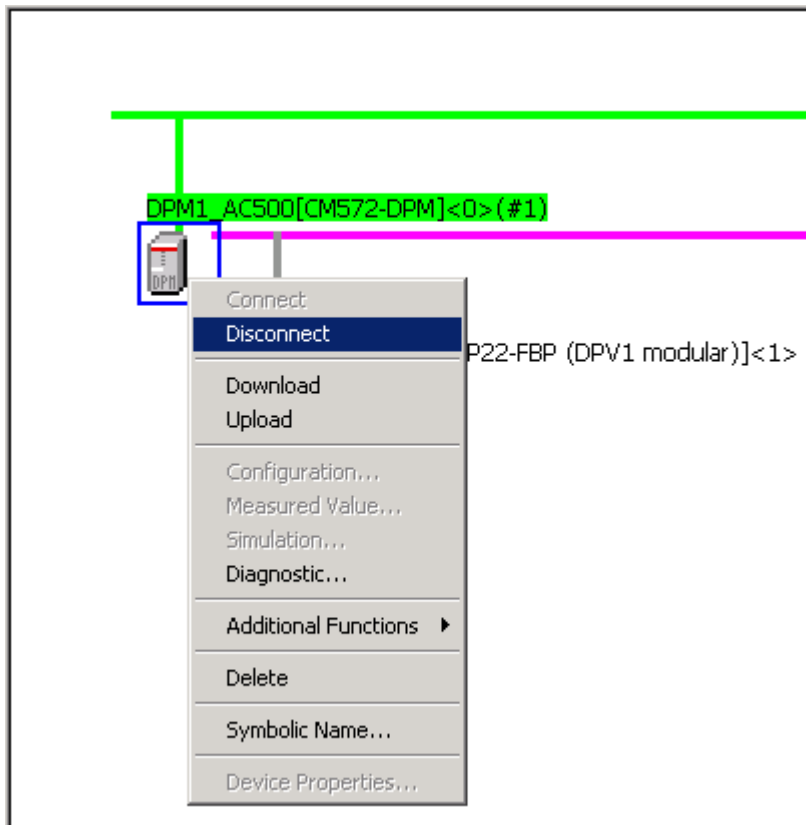

In SYCON.net, the configuration has to be saved to a file. The system adopts the project name (in our example: "Test3"). Select "File/Save".

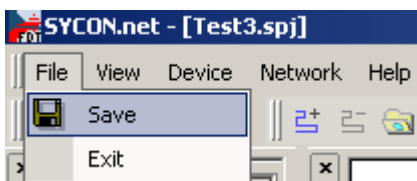

Exit SYCON. Select "File/Exit".



Return to the AC500 Control Builder by clicking on the  button in the Windows task bar on the bottom of the screen.

The AC500 Control Builder software is opened again and the fieldbus variables are automatically transferred to the **Global Variables** list of the programming software.

Open the Global Variables in the "Resources" tab. Double click on **Slot 1 <R>**. The previously configured variables are displayed and available in the programming software.

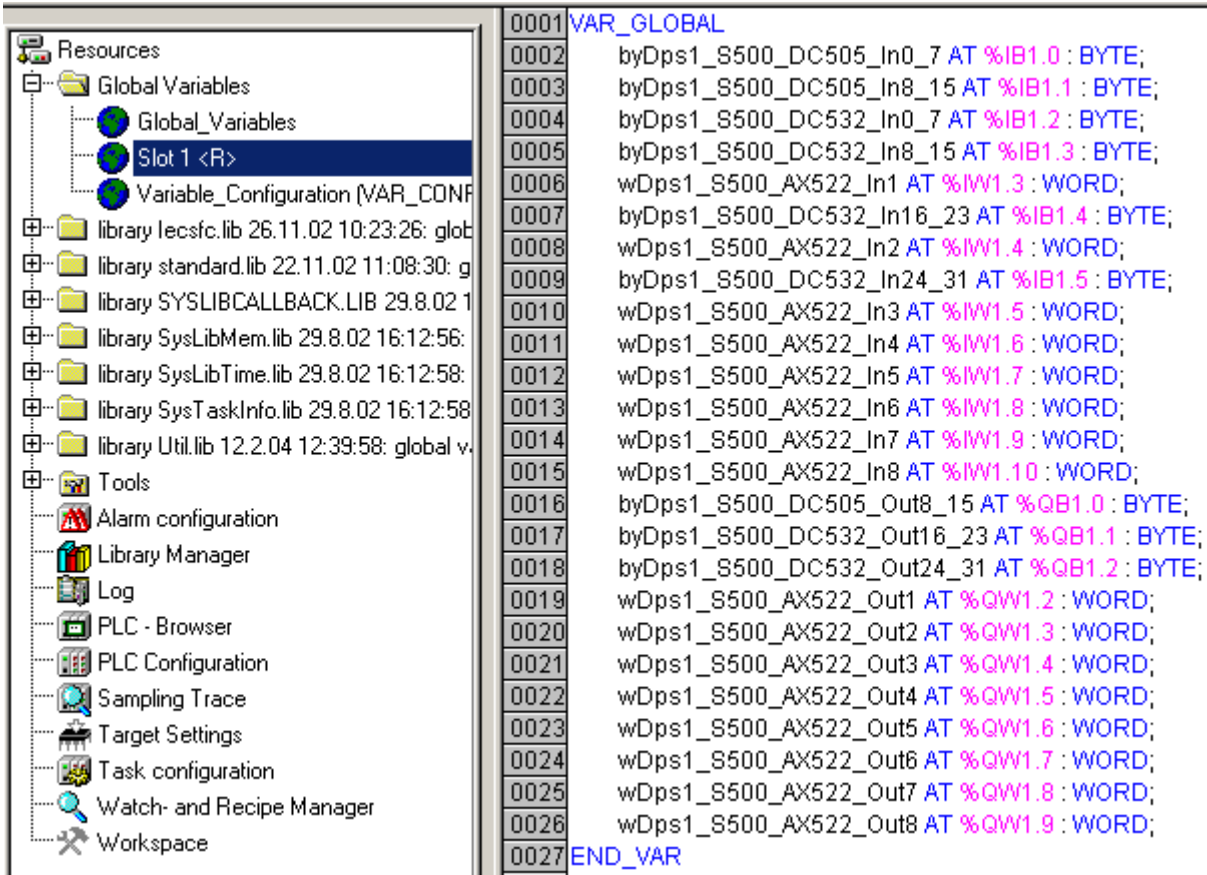

0001	VAR_GLOBAL
0002	byDps1_S500_DC505_In0_7 AT %IB1.0 : BYTE;
0003	byDps1_S500_DC505_In8_15 AT %IB1.1 : BYTE;
0004	byDps1_S500_DC532_In0_7 AT %IB1.2 : BYTE;
0005	byDps1_S500_DC532_In8_15 AT %IB1.3 : BYTE;
0006	wDps1_S500_AX522_In1 AT %IW1.3 : WORD;
0007	byDps1_S500_DC532_In16_23 AT %IB1.4 : BYTE;
0008	wDps1_S500_AX522_In2 AT %IW1.4 : WORD;
0009	byDps1_S500_DC532_In24_31 AT %IB1.5 : BYTE;
0010	wDps1_S500_AX522_In3 AT %IW1.5 : WORD;
0011	wDps1_S500_AX522_In4 AT %IW1.6 : WORD;
0012	wDps1_S500_AX522_In5 AT %IW1.7 : WORD;
0013	wDps1_S500_AX522_In6 AT %IW1.8 : WORD;
0014	wDps1_S500_AX522_In7 AT %IW1.9 : WORD;
0015	wDps1_S500_AX522_In8 AT %IW1.10 : WORD;
0016	byDps1_S500_DC505_Out8_15 AT %QB1.0 : BYTE;
0017	byDps1_S500_DC532_Out16_23 AT %QB1.1 : BYTE;
0018	byDps1_S500_DC532_Out24_31 AT %QB1.2 : BYTE;
0019	wDps1_S500_AX522_Out1 AT %QW1.2 : WORD;
0020	wDps1_S500_AX522_Out2 AT %QW1.3 : WORD;
0021	wDps1_S500_AX522_Out3 AT %QW1.4 : WORD;
0022	wDps1_S500_AX522_Out4 AT %QW1.5 : WORD;
0023	wDps1_S500_AX522_Out5 AT %QW1.6 : WORD;
0024	wDps1_S500_AX522_Out6 AT %QW1.7 : WORD;
0025	wDps1_S500_AX522_Out7 AT %QW1.8 : WORD;
0026	wDps1_S500_AX522_Out8 AT %QW1.9 : WORD;
0027	END_VAR

Testing the system

In order to test the system, we are going to create a small user program according to the procedure used in the Getting Started example. We are using the ST programming language (structured text). The program should read an input of the decentralized station (DC505-FBP) and output the value to the DC532 device located next to the CPU. The output byte %QB0 at DC532 (located next to the CPU) is named with the symbolic name by_AC500_DC532_Out16_23.

The program looks as follows:

```

0001 PROGRAM PLC_PRG
0002 VAR
0003 END_VAR
0004
0001 by_AC500_DC532_Out16_23 := byDps1_S500_DC505_In0_7;
0002
0003

```

The input byte with the variable name byDps1_S500_DC505_In0_7 (signals I0 to I7 at DC505) is read and applied to the output byte by_AC500_DC532_Out16_23 (signals C16 to 23 at DC532).

New GSD file(s)

 Note	<p>If you install additional GSD files to the installation of the Control Builder CD's GSD files they have to be added to the device catalog of SYCON.net. To do this apply subsequent procedure.</p> <p>The GSD files have to be copied to the corresponding directory beforehand (\ProgramFiles\HilscherGmbH\SYCONnet\ABBPBGenericSlaveDTM\GSD).</p> <p>Attention: Handling of GSD files only works that way in case of an empty project!</p>
---	---

Click on  Resources. Open the 'Tools' folder. Double click on the entry SYCON.net.

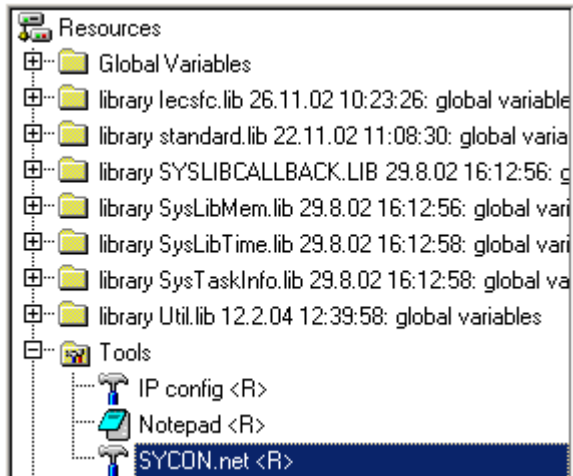

Click into the window next to netDevice and select "Network/Device Catalog..." from the menu.

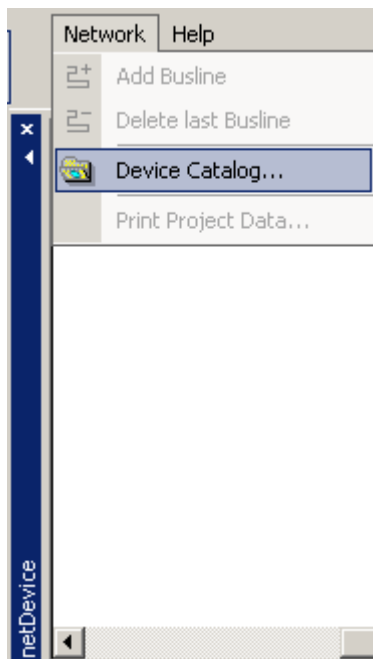

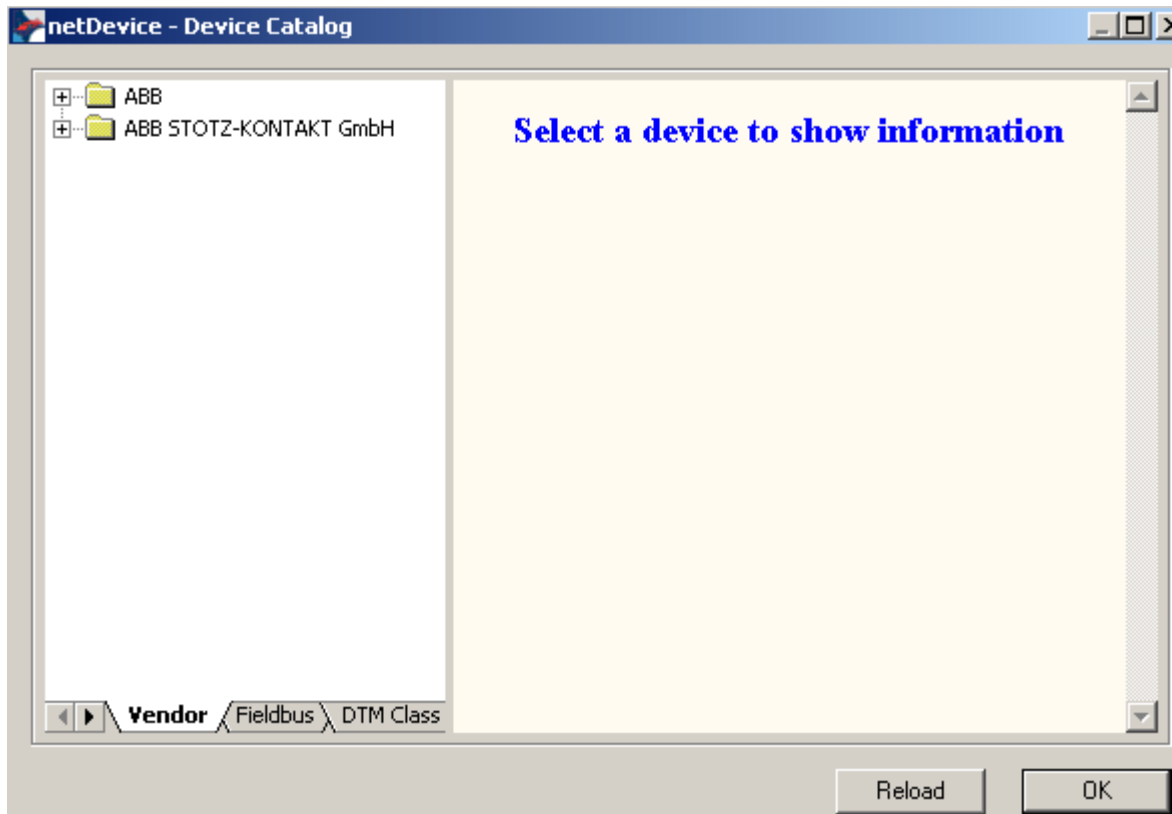

Click on **Reload**. This integrates the new GSD file. Click on OK and close SYCON.net.

For AC1131 experts – connection S500-FBP I/O module to series 90

Example with an AC31 Series 90 CPU as PROFIBUS DP Master and a DC505-FBP as remote I/Os

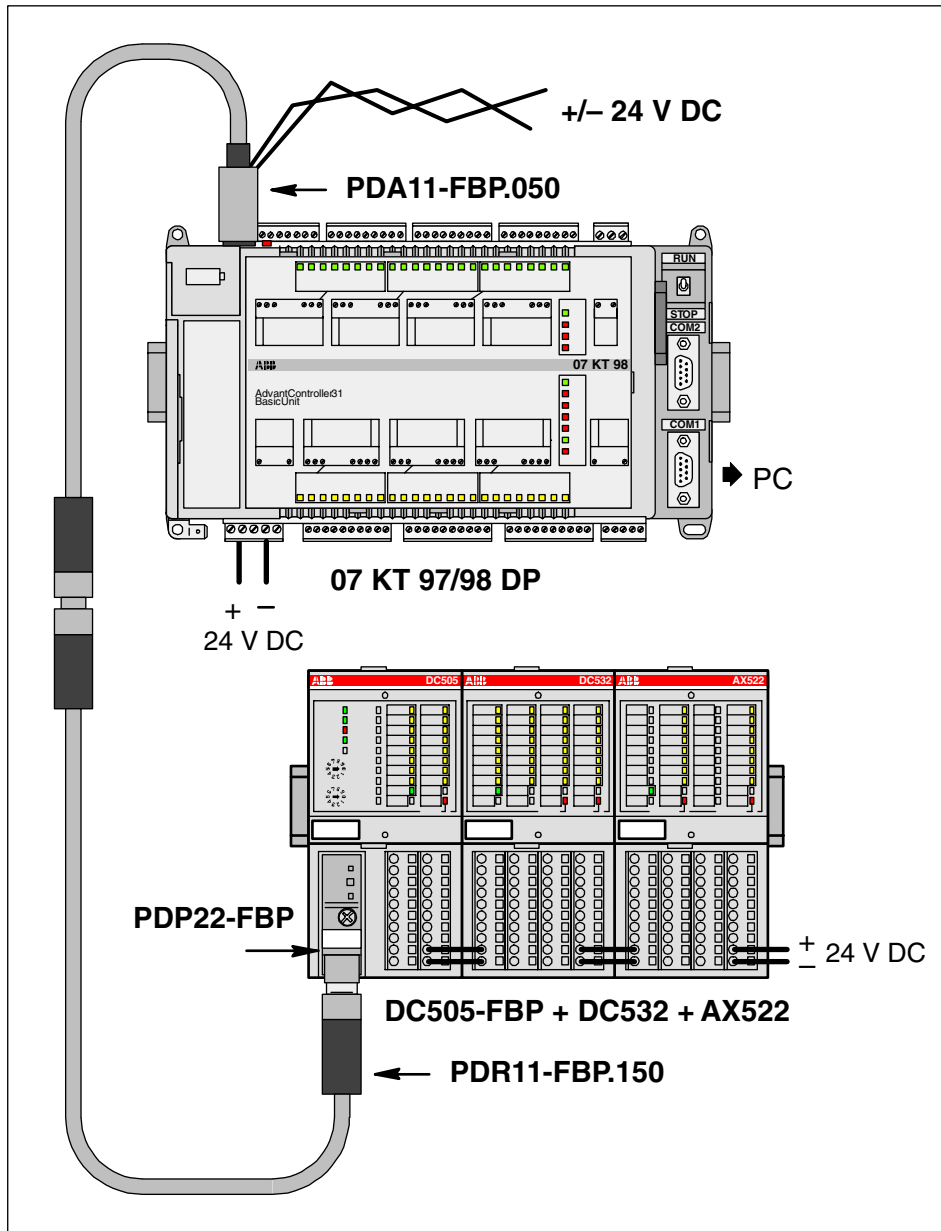

Figure: Example with an AC31 series 90 CPU as PROFIBUS DP master and a DC505-FBP as remote I/Os

The following example will guide you through the installation and the configuration of a small PROFIBUS DP fieldbus using an AC31 PLC as PROFIBUS DP Master and a S500-FBP remote I/O station with a modular FBP.

This example could be used as starting point to realize your own application.



ATTENTION

Refer to the dedicated User's manuals or Installation guides of the FieldBusPlug and the AC31 PLCs and programming software.

Needed products

	Quantity	Product description	Order number
<input checked="" type="checkbox"/>	1	CPU 07 KT 97/98 with PROFIBUS DP here: 07 KT 97 with Ethernet and PROFIBUS DP coupler	GJR5 2530 00 R0272
<input checked="" type="checkbox"/>	1	Programming cable 07 SK 90	GJR5 2502 00 R0001
<input checked="" type="checkbox"/>	1	PDA11-FBP.050 adapter for FBP, power supply and field bus	1SAJ 9240 09 R0005
<input checked="" type="checkbox"/>	1	PDP22-FBP.050 PROFIBUS DP-V0/V1-FBP 0.5 m, modular (field bus plug)	1SAJ 2401 00 R1005
<input checked="" type="checkbox"/>	1	PDR11-FBP.150 terminating resistor	1SAJ 9240 07 R0001
<input checked="" type="checkbox"/>	1	DC505-FBP with 8DI/8DC	1SAP 2200 00 R0001
<input checked="" type="checkbox"/>	1	DC532 with 16DI/16DC	1SAP 2401 00 R0001
<input checked="" type="checkbox"/>	1	AX522 with 8AI/8AO	1SAP 2500 00 R0001
<input checked="" type="checkbox"/>	1	TU506 FBP terminal unit for FBP interface	1SAP 2100 00 R0001
<input checked="" type="checkbox"/>	2	TU516 I/O terminal unit for I/O modules	1SAP 2120 00 R0001
<input checked="" type="checkbox"/>	1	GSD file for FBP modules	ABB_091F.GSD
<input checked="" type="checkbox"/>	1	Programming software 907 AC 1131	GJP5 2070 00 R0102

Before starting:

- Use the previous installation instructions to assemble and mount the system, also refer to the dedicated User's manual of the PROFIBUS DP FBP and AC31 series 90 PLC.
- Make the wiring and provide power supply to the system (process supply) and to the FieldBusPlug (use dedicated accessory, e.g. PDA11-FBP.050 which allows to connect a PROFIBUS DP master with a 9-pin D-Sub and provide power supply for the FBP through an M12 connector).
- Set the slave address of the FBP to 1 with the front rotary switches of the S500-FBP module (see Getting Started with S500-FBP, "Setting the FBP slave address").
- Install the AC1131 programming software for AC31 PLCs
- If you want to configure the fieldbus using the fieldbus configurator software 907 FB 1131, install this software. As an alternative, you can also use the fieldbus configurator included in the programming software.
- If you want to use the fieldbus configurator 907 AC 1131 for configuration, copy the PROFIBUS GSD file ABB_091F.GSD to the folder \Program Files\AC1131\FB1131\Fieldbus\PROFIBUS\GSD. If you want to configure the fieldbus using the fieldbus configurator included in the programming software, copy the GSD file to the folder \Program Files\AC1131\Library\PLCConf.
- Connect the PC (COM1) to the AC31 CPU (COM1) using the programming cable 07 SK 90.
- Connect the CPU to the DC505-FBP module via the FieldBusPlug.
- Switch on voltage.
- Perform the steps given in the following instructions.

Variant A: Configuration using the fieldbus configurator included in the programming software

First, we have to specify the hardware. Click on **Resources**. Double click the object "PLC Configuration". Click on "Hardware Configuration". Press the right mouse button. Select "Append Subelement/DP Master...".

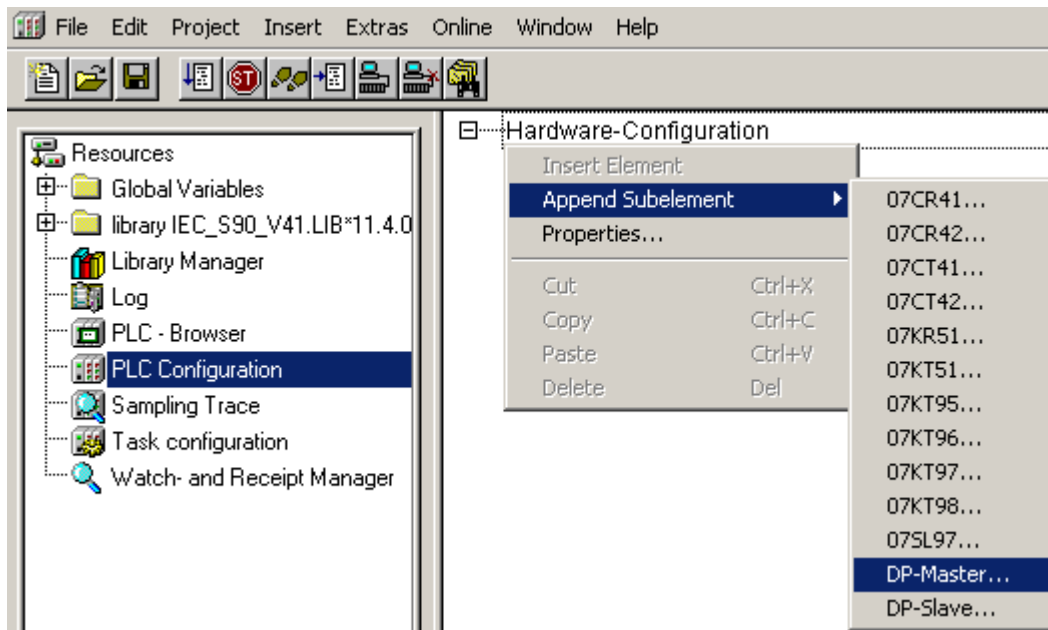

Set the "Card number" in the appearing window. The following rule applies: The slot number (= card number) can be gathered from the identification number of the CPU. Furthermore, we can also determine the coupler form the identification number. The following applies:

- GJR5 253x 00 Rxyyz with
y = slot number = card number = 1
z = slot number = card number = 2
- Furthermore, the following code applies to y and z: 2=PROFIBUS DP / 5=DeviceNet / 6=ARCNET / 7=Ethernet / 8=CANopen / 9=Interbus
- For our example: CPU with identification number R0272 -> slot number 1 -> Ethernet; slot number 2 -> PROFIBUS DP
- Since we are using the PROFIBUS coupler in our example, the resulting card number is 2.

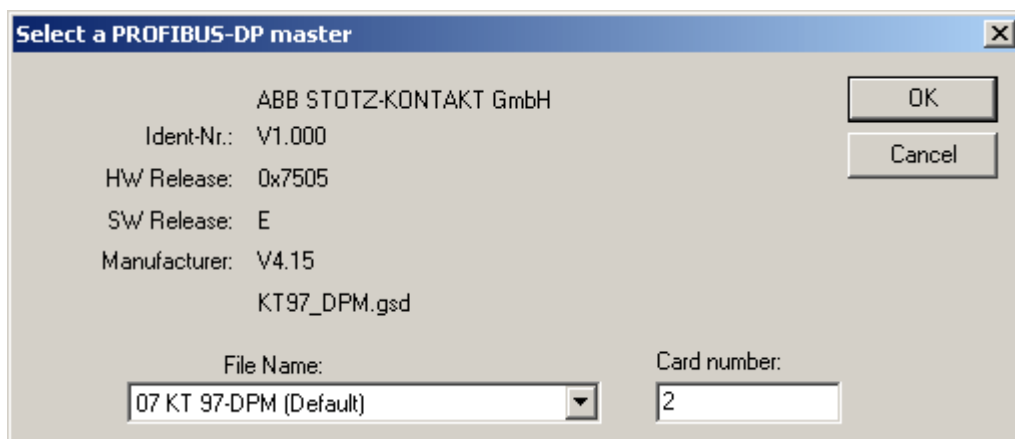

Confirm with "OK".

Press the right mouse button and select "Append DP Slave".

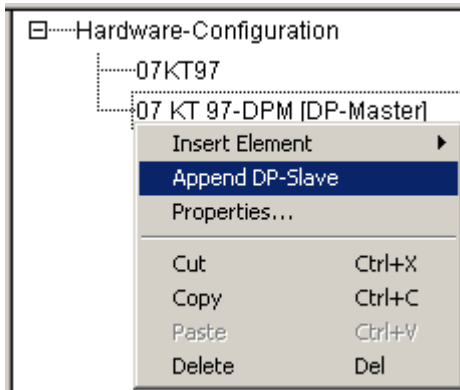

In the appearing window, select "PDP22-FBP (DPV1 modular) (Default)" in the File Name list box.

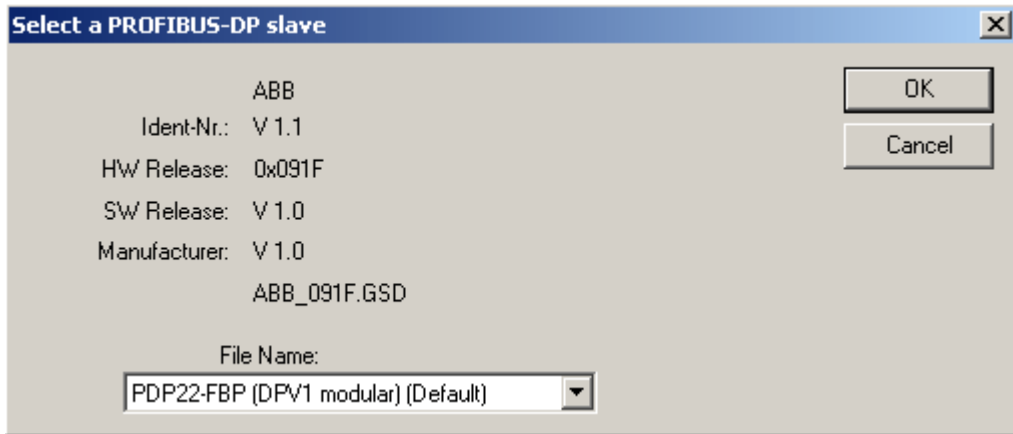

Confirm with "OK".

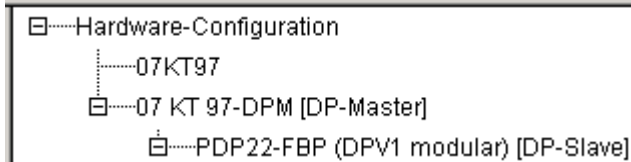

Click on the entry "PDP22-FBP (DPV1 modular)". Press the right mouse button and select "Properties".

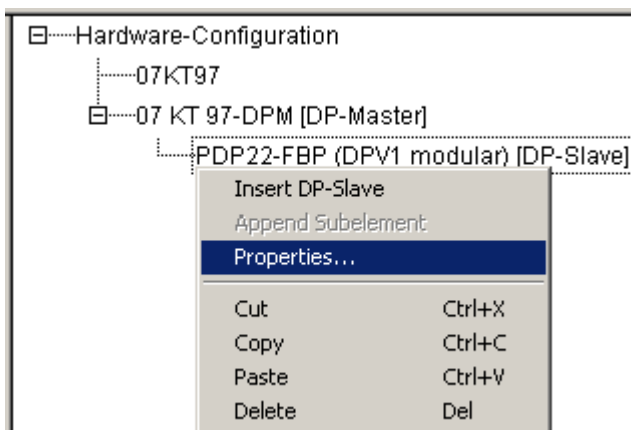

Select "Input/Output". Click on the entry DC505-FBP in the left-hand window and then click on "Select >>". Proceed in the same way for DC532 and AX522.

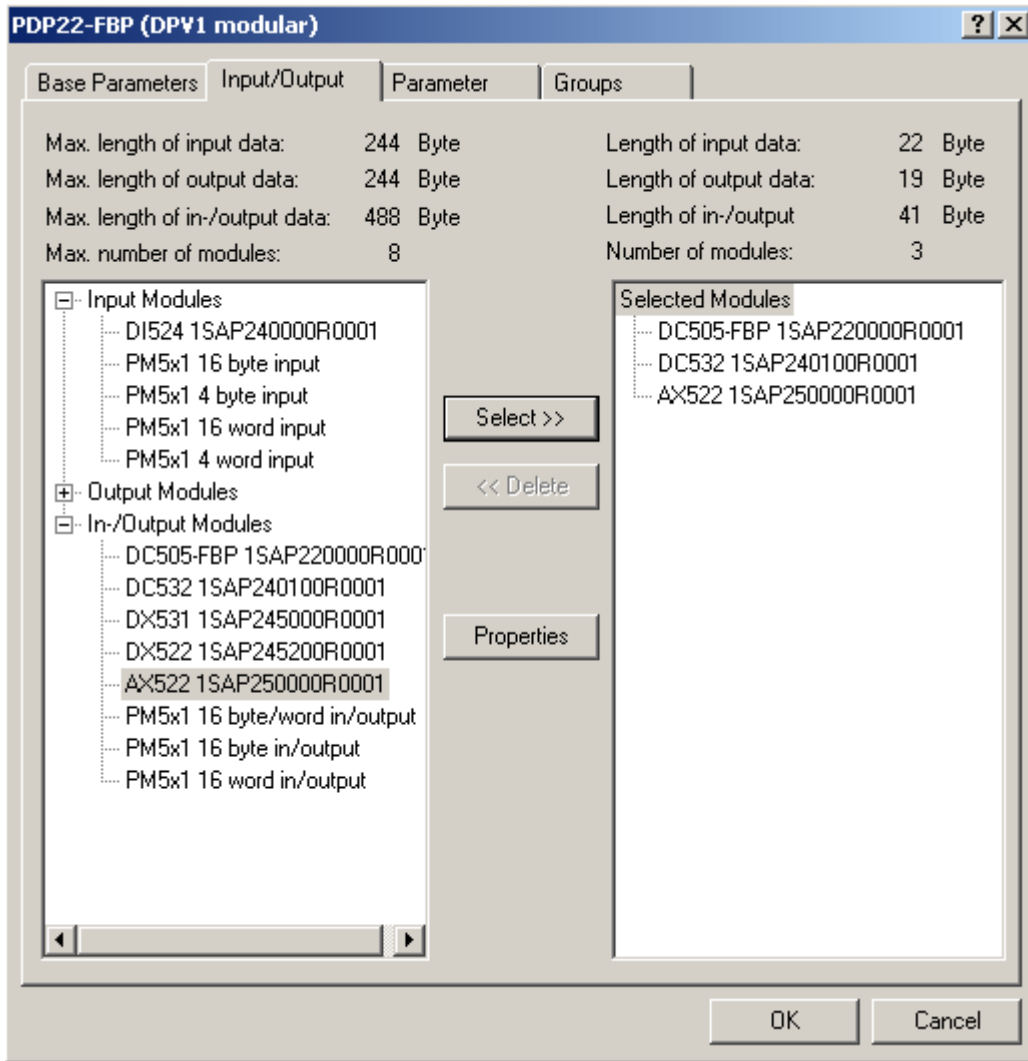

Click on "OK". The hardware is now specified.

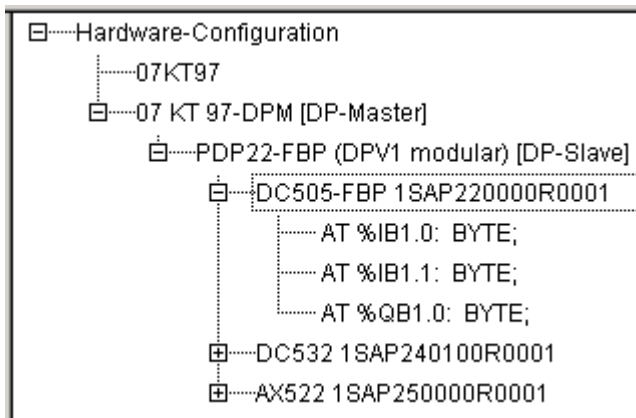

When a user program is loaded to the CPU, the configuration data of the coupler (the data are a definite element of a project) are loaded as well. The operating system of the PLC transfers the configuration data to the coupler. In addition, the configuration data can be saved together with the user program in the Flash memory of the controller. The configuration data stored in the Flash memory are automatically loaded the next time the power is switched on.

Variante B: Configuration using the fieldbus configurator software FB1131

Start the fieldbus configurator software 907 FB 1131 and select "File -> New". A window appears where you can select a fieldbus system.

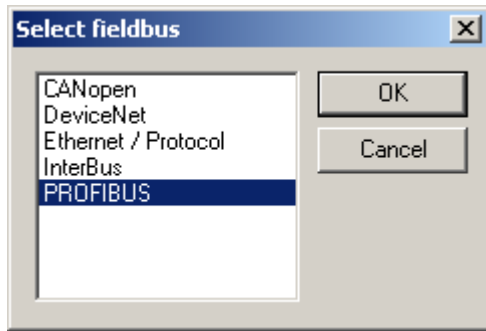

Select **PROFIBUS** and click on **OK**. Now you have to configure the master.

Select **Insert -> Master** from the menu bar. The mouse pointer changes to an arrow with an 'M'. Left click with the mouse on that position on the screen where you want to place the DP Master. Another window appears.

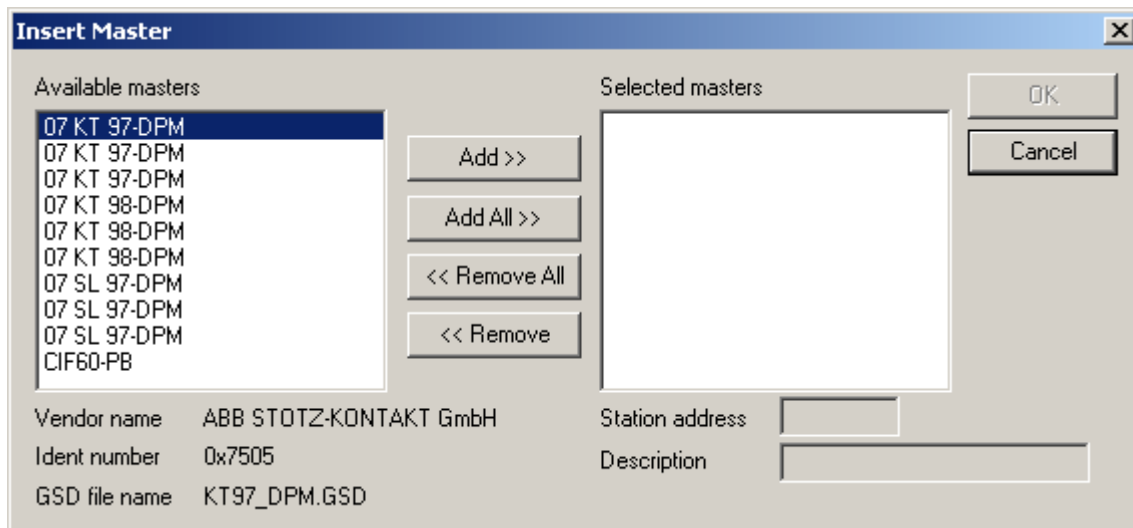

In this window, select **07KT97 DPM** and click on **Add >>** to add the selected master to the network. The selected master is now displayed on the right-hand side of the window. You can change the default address of the master and enter a comment in the 'Description' field.

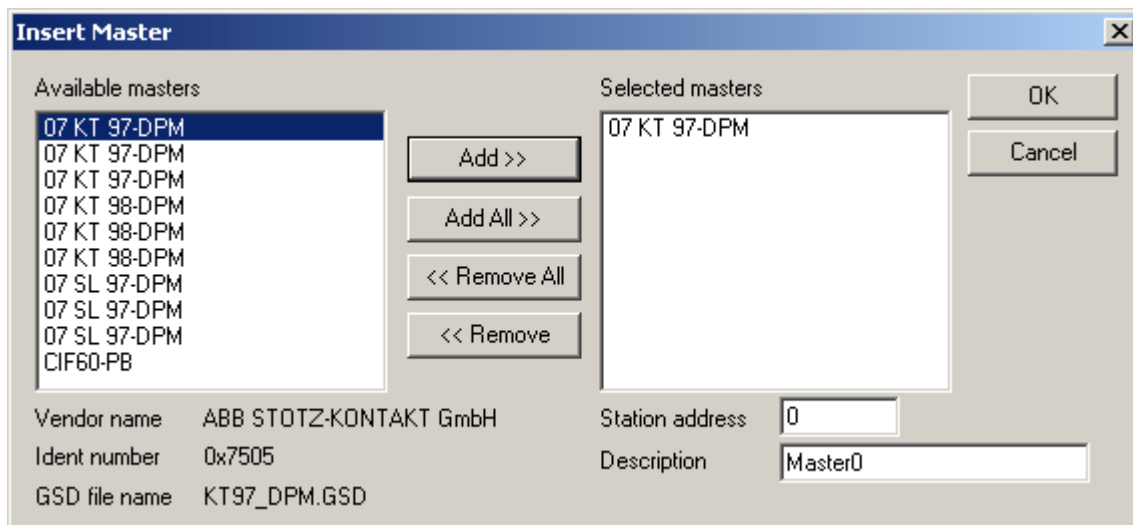

Click on **OK** and continue.

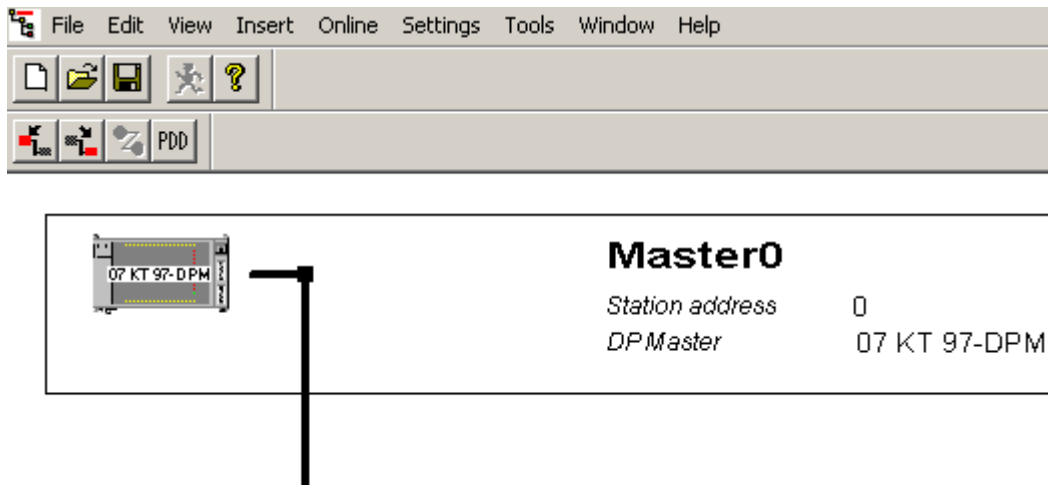

Now append a slave to the PROFIBUS DP line. Click below the master surrounded by a frame. A rectangle indicates the area where the slave will be inserted.

Select **Insert -> Slave** from the menu bar.

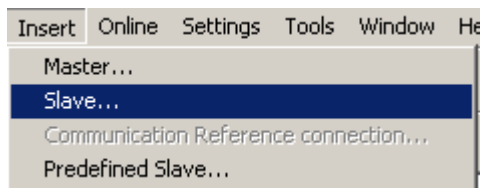

The mouse pointer changes to an arrow with an 'S'. Proceed as already described for the master in order to place the slave. A new window appears.

Left click with the mouse on that position on the screen where you want to place the Slave. Another window appears. Scroll down in the left-hand area and select **PDP22-FBP (DPV1 modular)** as the slave. Then click on **ADD >>**. Your selection is displayed on the right-hand side of the window.

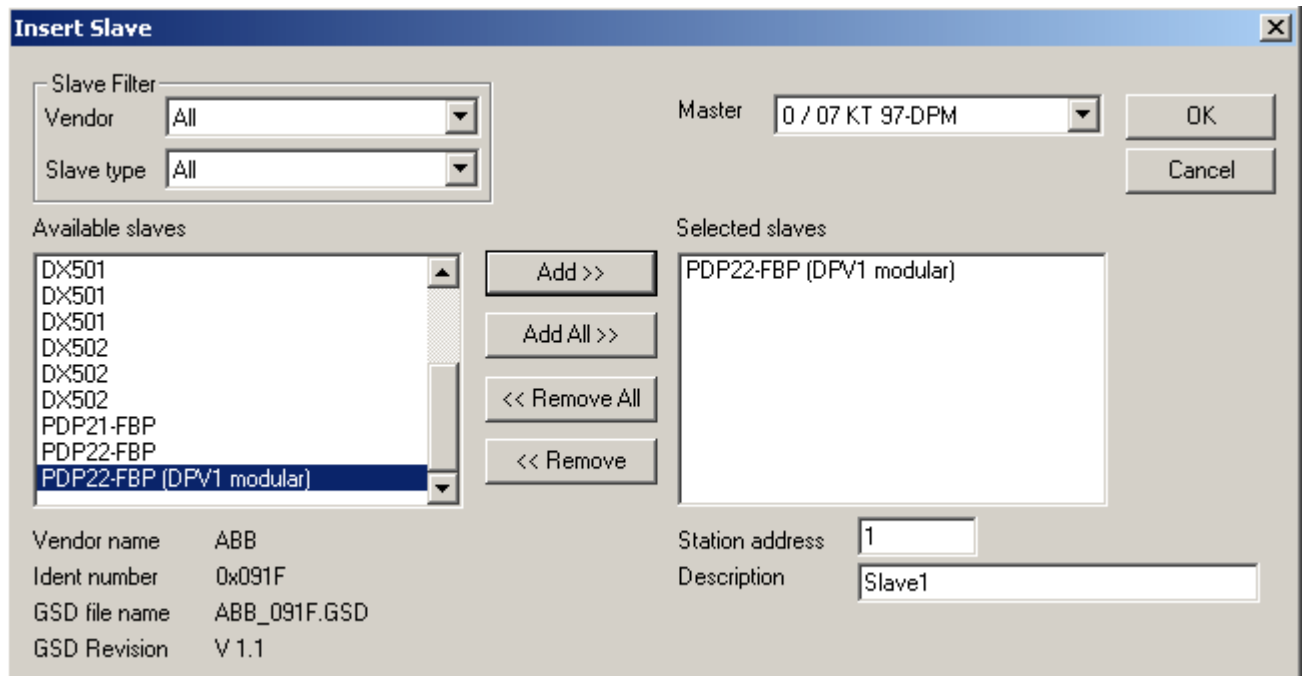

In this window, you can also change the default station address and enter a description for the device. Then click on **OK**.

The configured fieldbus is displayed.

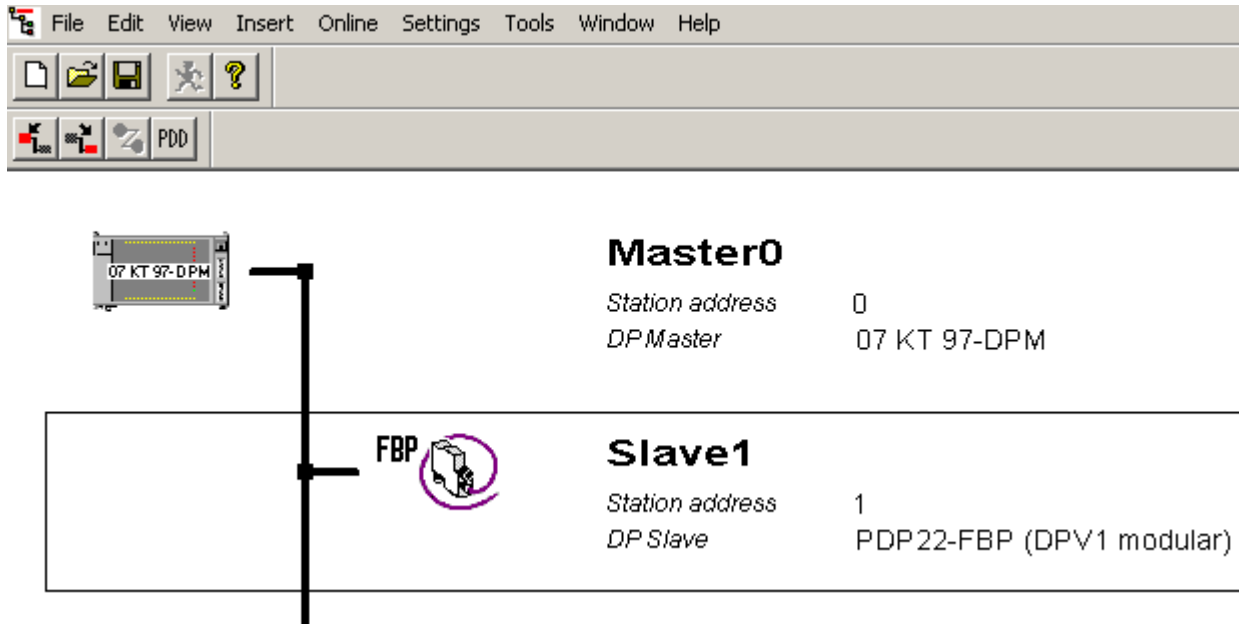

Double click inside of the rectangle surrounding the slave in order to configure the slave. A new window named **Slave Configuration** appears.

Slave Configuration

General

Device: PDP22-FBP (DPV1 modular) Station address: 1

Description: Slave1

Activate device in actual configuration

Enable watchdog control GSD file: ABB_091F.GSD

Max. length of in-/output data	488 Byte	Length of in-/output data	3 Byte
Max. length of input data	244 Byte	Length of input data	2 Byte
Max. length of output data	244 Byte	Length of output data	1 Byte
Max. number of modules	8	Number of modules	1

Module	Inputs	Outputs	In/Out	Identifier
DC505-FBP 1SAP220000R0001	2 Byte	1 Byte		0x11, 0x20
DI524 1SAP240000R0001	4 Byte			0x13
DC532 1SAP240100R0001	4 Byte	2 Byte		0x13, 0x21
DX531 1SAP245000R0001	1 Byte	1 Byte		0x10, 0x20

Slot	Idx	Module	Symbol	Type	I Addr.	I Len.	Type	O Addr.	O Len.
0	1	DC505-FB	Module1	IB	0	2			
0	2	DC505-FB	Module1				QB	0	1

Assigned master: Station address 0, Master0, 0 / 07 KT 97-DPM

Actual slave: Station address 1, Slave1, 1 / PDP22-FBP (DPV1 moc)

Buttons: OK, Cancel, Parameter Data..., DPV1 Settings..., Append Module, Remove Module, Insert Module, Predefined Modules, Symbolic Names

The modular station has to be configured in order to specify the used hardware. First, select the FBP interface module **DC505-FBP** (list of available modules ('Module' column) in the window shown above; the selected module is highlighted by a rectangle). Click on **Append Module** to insert it into the list of configured modules.

The following information is given for the selected modules: Slot number (Slot), module type (Module) and definition of the input bytes/words IB/IW and the output bytes/words QB/QW. Then we have to specify the expansion modules of the used hardware. In our example this is a digital input/output module **DC532** and an analog input/output module **AX522**.

After you have added all required modules into the configuration list, click on **OK** to apply the configuration.

Slave Configuration

General

Device: PDP22-FBP (DPV1 modular) Station address: 1

Description: Slave1

Activate device in actual configuration

Enable watchdog control GSD file: ABB_091F.GSD

Max. length of in-/output data: 488 Byte Length of in-/output data: 41 Byte

Max. length of input data: 244 Byte Length of input data: 22 Byte

Max. length of output data: 244 Byte Length of output data: 19 Byte

Max. number of modules: 8 Number of modules: 3

Module	Inputs	Outputs	In/Out	Identifier
DX531 1SAP245000R0001	1 Byte	1 Byte		0x10, 0x20
DX522 1SAP245200R0001	1 Byte	1 Byte		0x10, 0x20
AX522 1SAP250000R0001	8 Word	8 Word		0x57, 0x67

Slot	Idx	Module	Symbol	Type	I Addr.	I Len.	Type	Q Addr.	Q Len.
0	1	DC505-FB Module1		IB	0	2			
0	2	DC505-FB Module1					QB	0	1
1	1	DC532 Module2		IB	0	4			
1	2	DC532 Module2					QB	0	2
2	1	AX522 Module3		IW	0	8			
2	2	AX522 Module3					QW	0	8

Assigned master: Station address 0, Master 0, 0 / 07 KT 97-DPM

Actual slave: Station address 1, Slave 1, 1 / PDP22-FBP (DPV1 moc)

Buttons: OK, Cancel, Parameter Data..., DPV1 Settings..., Append Module, Remove Module, Insert Module, Predefined Modules, Symbolic Names

Call the address table before you specify the parameter data (via **View -> Address Table**) in order to update the addresses of the input/output variables.

If you want to change the device parameters of the slave, select the device entry to highlight it by a rectangle. Press the right mouse button and select **Parameter Data** from the context menu.

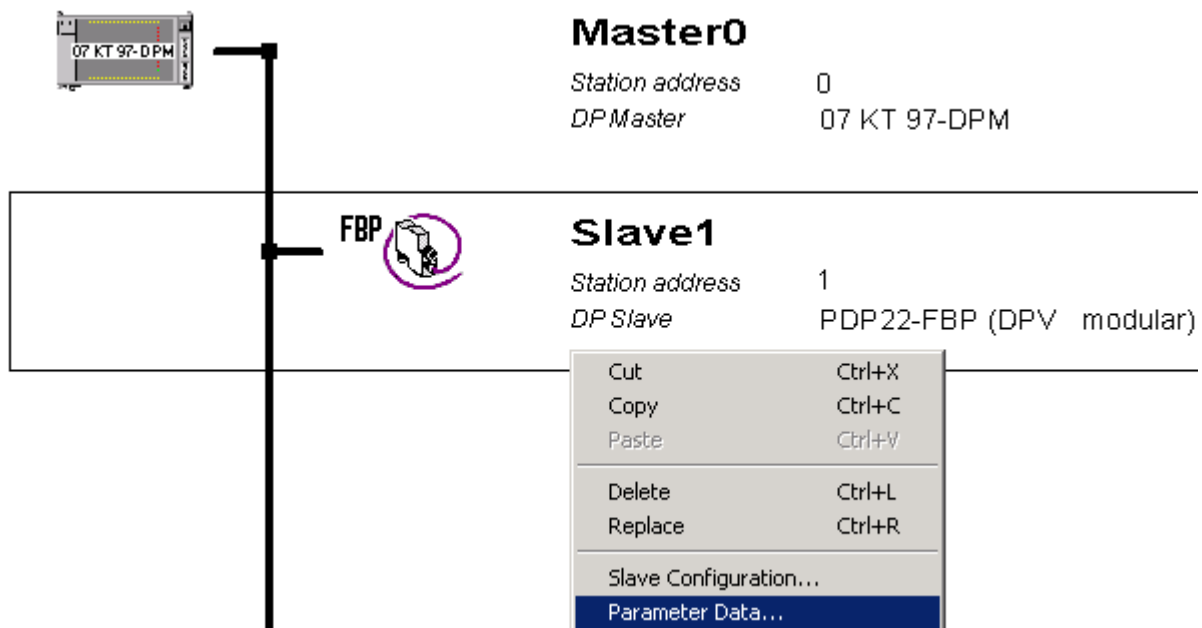

A new window appears, showing all PROFIBUS DP parameters:

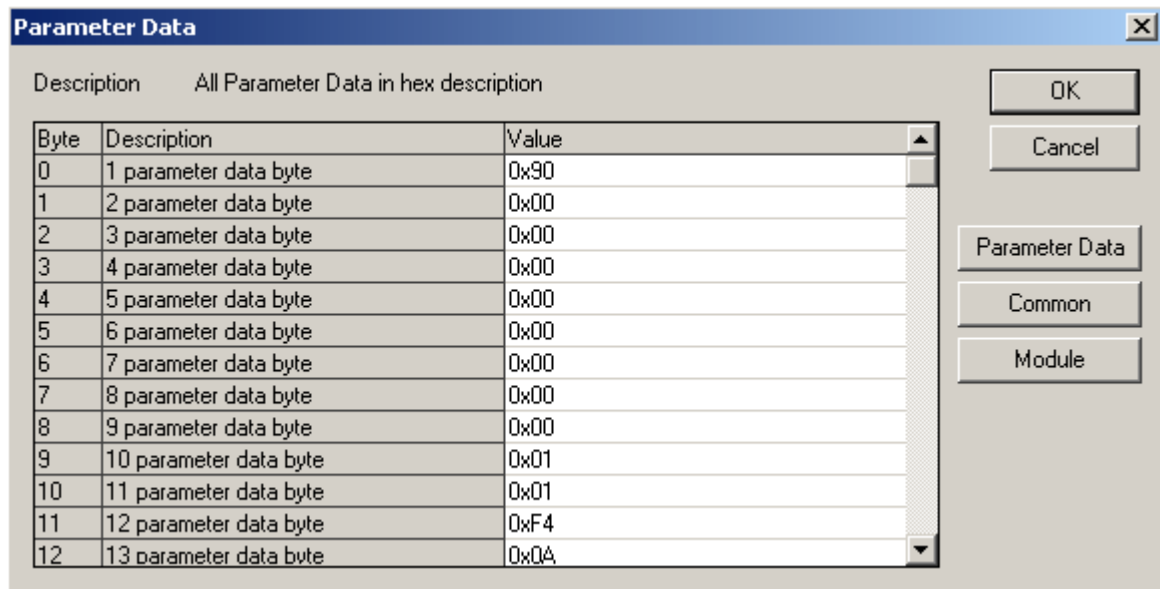

For instance, click on **Module** if you want to change the delay time of all inputs of the module DC532.

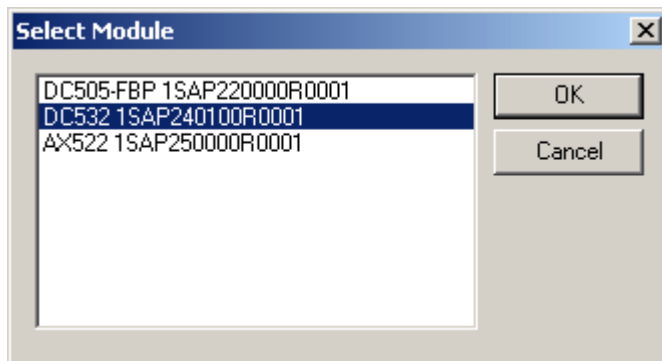

Select **dc532 1sap240100r0001** and click on **OK**. The corresponding module parameters are displayed and can be changed now.

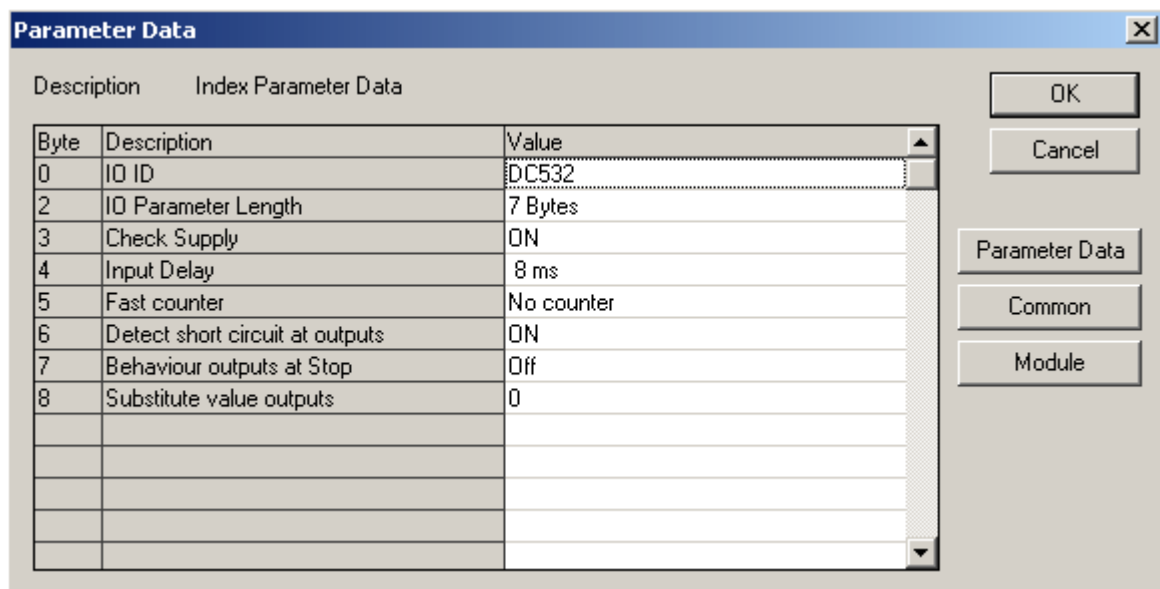

Example: In order to change the delay time of the inputs, double click on **Input Delay**.

A new window appears, showing all available values. Select the desired value, e.g. 1 ms, and click on **OK**.

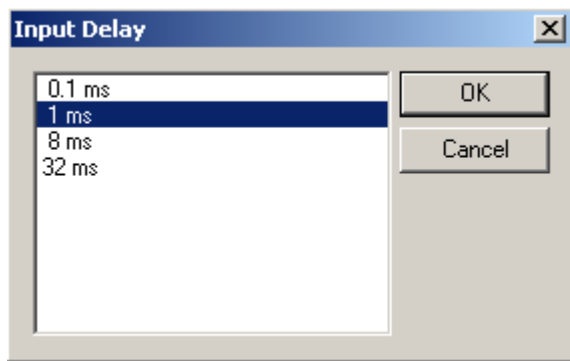

The new value is applied.

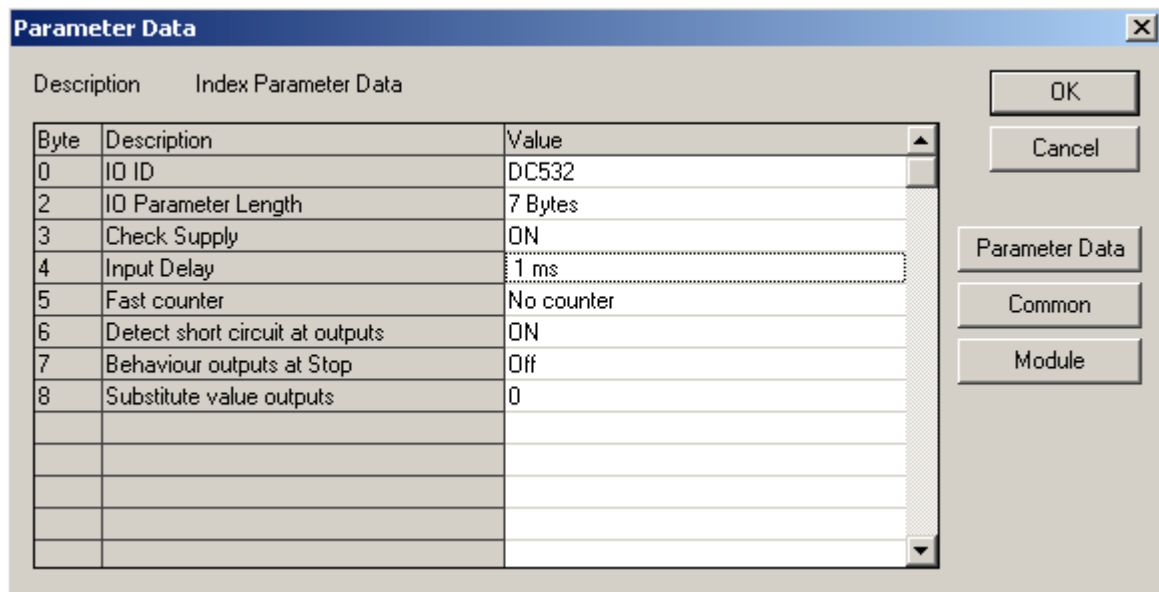

After you have changed all the desired parameters, click on **OK** to exit the parameter configuration. The following configuration is displayed:

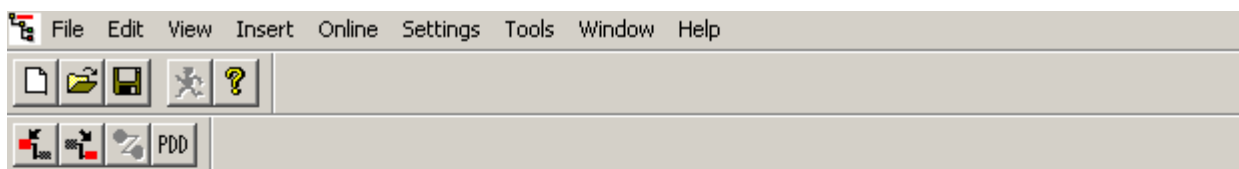

In order to test the configured fieldbus, the configuration has to be downloaded to the master. Select the master (click on the master to highlight it by a surrounding rectangle). Select the menu item **Online -> Download**.



Select **3S Gateway Driver** as gateway for the download to the CPU coupler and click on **OK**.

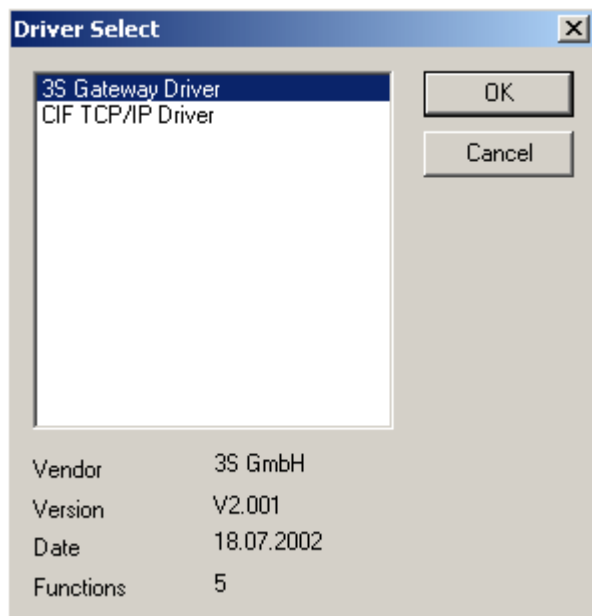

A new window named **3S Gateway Driver Assignment** is opened for setting the gateway parameters for the address assignment of the DP coupler in the CPU (this is only done when the gateway is used the first time).

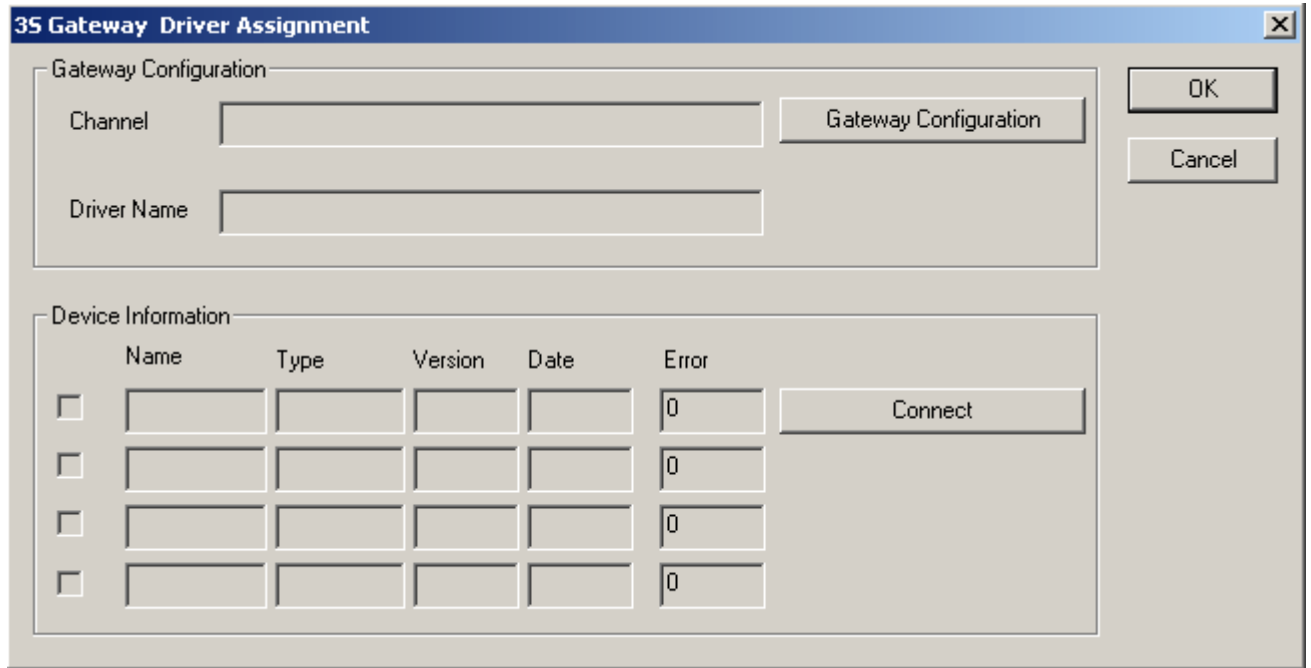

Click on **Gateway Configuration** and then select the default channel **COM1_PC** in the appearing window.

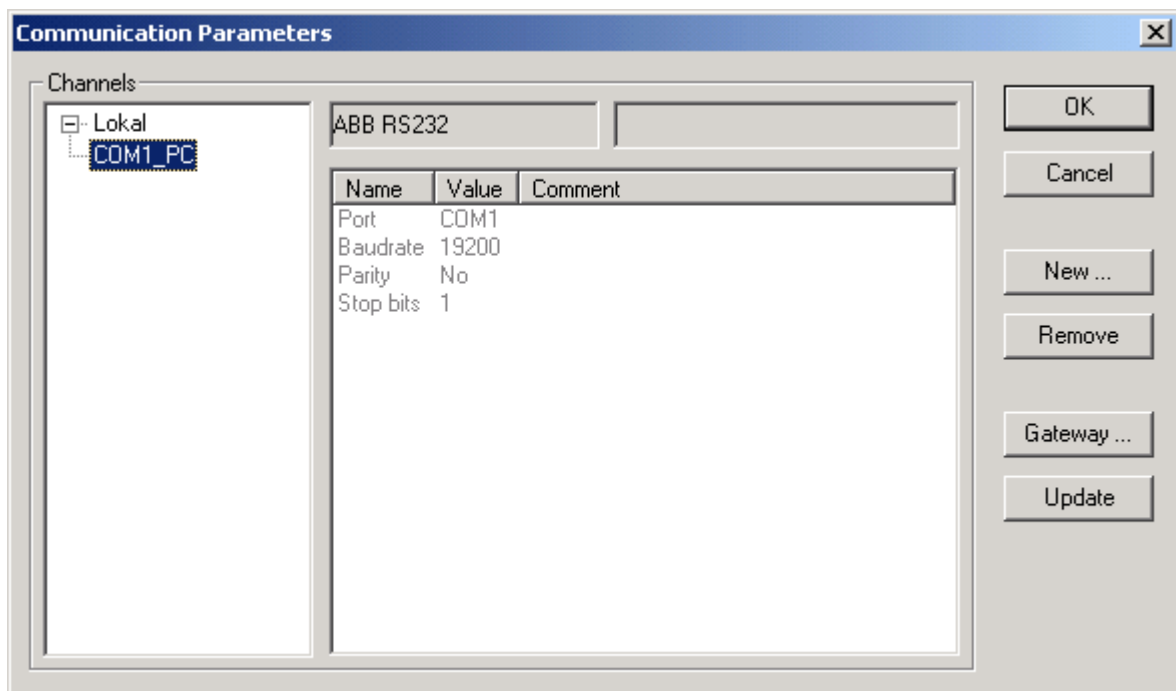

Apply the selection by clicking on **OK**.

The window is closed and the software tries to establish the connection via the gateway. If the connection establishment is successful, the couplers are displayed in the **Device Information** area.

Device Information						Connect
	Name	Type	Version	Date	Error	
Slot 0 <input type="checkbox"/>	ENOMB	PM5x1ETH	T01.030a	07.07.05	0	
Slot 1 <input type="checkbox"/>	DPM	CM572-DP	T01.097	24.02.05	0	
Slot 2 <input type="checkbox"/>					403	
Slot 3 <input type="checkbox"/>					403	
Slot 4 <input type="checkbox"/>					403	

Click into the field next to the coupler name to select the desired coupler (DPM) and confirm with **OK**.

To perform the download, select the menu item **Online -> Download**. A safety inquiry is displayed. Answer with **Yes**. The configuration is then transferred to the controller.

The address data used can be displayed using the menu item **View -> Address Table**.

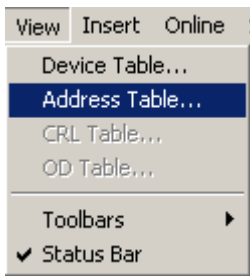

The digital inputs can be accessed via IB0 to IB5, the digital outputs via QB0 to QB2 and the analog outputs via QW3 to QW11.

Address Table												
Station address		0		0 / 07 KT 97-DPM				OK				
Description		Master0										
Addr.	Slot	Idx.	Device	Module	Symbol name	IType	I Addr.	I Len.	OType	O Addr.	O Len.	
2	0	1	PDP22-FBP (DPV1	DC505-FBP	Module1	IB	0	2				
2	0	2		DC505-FBP	Module1				QB	0	1	
2	1	1		DC532	Module2	IB	2	4				
2	1	2		DC532	Module2				QB	1	2	
2	2	1		AX522	Module3	IW	6	8				
2	2	2		AX522	Module3				QW	3	8	

Sort according to station addresses Sort according to data addresses Address Overview...

Testing the system

In order to test the system, we are going to create a small user program. We are using the programming language FBD. The program should read an input of the decentralized station (DC505-FBP) and output the value at the CPU. The program looks as follows:

```
0001 PROGRAM PLC_PRG
0002 VAR
0003 END_VAR
0004
0001
%IB2.0 — %QB124
```

The first byte on the DC505-FBP is read at address %IB2.0 and output at the CPU via the address %QB124 (outputs A62,00 to A62,07).