

Kramer Electronics, Ltd.



USER MANUAL

Models:

RC-8RK, *Universal Room Controller*

RC-8RKL, *Universal Room Controller*

Contents

1	Introduction	1
2	Getting Started	1
3	Overview	1
4	Your Universal Room Controller	3
5	Using Your Universal Room Controller	7
5.1	Operating the RC-8RK	10
5.2	An Example of Operating the RC-8RK	11
5.3	Using the Macro Buttons	11
5.4	Using the Internal Web Page	12
6	Technical Specifications	13

Figures

Figure 1:	RC-8RK and RC-8RKL Front Panels	3
Figure 2:	RC-8RK and the RC-8RKL Rear Panel	4
Figure 3:	RC-8RK and the RC-8RKL Lower Rear Panel	5
Figure 4:	RC-8RK and the RC-8RKL Upper Rear Panel	6
Figure 5:	RC-8RK and the RC-8RKL Rear Side Panel	6
Figure 6:	Example of a Typical RC-8RK / RC-8RKL Configuration	8
Figure 7:	Example of a Typical RC-8RK Setup in the Lecture Auditorium	9
Figure 8:	RC-8RK Labels Setup	10
Figure 9:	RC-8RK Operation Example	11
Figure 10:	Internal Web Page Front Panel	12

Tables

Table 1:	RC-8RK and RC-8RKL Front Panel Features	3
Table 2:	RC-8RK and the RC-8RKL Rear Panel Features	4
Table 3:	RC-8RK and the RC-8RKL Lower Rear Panel Features	5
Table 4:	RC-8RK and the RC-8RKL Upper Rear Panel Features	6
Table 5:	RC-8RK and the RC-8RKL Rear Side Panel Features	6
Table 6:	Connection Scheme (for the example in Figure 6)	8
Table 7:	The Commands Configuration	10
Table 8:	Technical Specifications of the Universal Room Controller Series	13

1 Introduction

Welcome to Kramer Electronics! Since 1981, Kramer Electronics has been providing a world of unique, creative, and affordable solutions to the vast range of problems that confront the video, audio, presentation, and broadcasting professional on a daily basis. In recent years, we have redesigned and upgraded most of our line, making the best even better! Our 1,000-plus different models now appear in 11 groups¹ that are clearly defined by function.

Congratulations on purchasing your Kramer **RC-8RK** and/or **RC-8RKL**², which are designed to let an instructor enter a multimedia classroom and operate an A/V system with ease. The package includes the following items:

- **RC-8RK** or **RC-8RKL**²
- One 3.5mm to IR emitter control cable
- This user manual³
- Configuration software

2 Getting Started

This user manual is written for the end user. Refer to the separate online RC Configuration and Installation Guide for details of how to install and configure the Universal Room Controller⁴

We recommend that you:

- Review the contents of this user manual
- Use Kramer high performance high resolution cables⁵

3 Overview

Kramer's 2 Gang wall plates: **RC-8RK** and **RC-8RKL** are a unique series of highly versatile controller interfaces that act as an all-in-one extended remote control panel for control of A/V equipment—especially projectors and associated equipment—in any room (such as classrooms, boardrooms, or

1 GROUP 1: Distribution Amplifiers; GROUP 2: Switchers and Matrix Switchers; GROUP 3: Control Systems; GROUP 4: Format/Standards Converters; GROUP 5: Range Extenders and Repeaters; GROUP 6: Specialty AV Products; GROUP 7: Scan Converters and Scalers; GROUP 8: Cables and Connectors; GROUP 9: Room Connectivity; GROUP 10: Accessories and Rack Adapters; GROUP 11: Sierra Products

2 The RC-8RKL has larger-sized buttons

3 Download up-to-date Kramer user manuals from the Internet at this URL: <http://www.kramerelectronics.com>

4 That provides information about how to set up the system. This online guide may well be updated on a regular basis. For the latest online guide, go to <http://www.kramerelectronics.com>

5 The complete list of Kramer cables is on our Web site at <http://www.kramerelectronics.com>

auditoriums). They streamline operations and simplify control by integrating audio, video, and computer-video sources into a centralized system.

The **RC-8RK** and **RC-8RKL** include:

- An Ethernet port for configuration and control¹
- Configurable buttons to set up any supported² command
- A color select switch for selecting the buttons' color
- A brightness switch for selecting the intensity of the selected buttons' color and a backlight switch for setting a low intensity backlight when the unit is not active³
- Two bidirectional RS-232 wired serial ports, for universal display (for example, projectors) and switcher control, and one RS-485 serial port
- Two relays for the simplified and centralized control of room functions (such as lighting, closing blinds, screen settings, and so on)
- Two IR control ports
- An IR-learner for the customized control of external sources, receiving the IR commands from different remote transmitters without the need for an external IR remote control unit
- Macro mode operation, for programming up to 15 commands with the press of a single button. They have a total of 120 commands
- Support for firmware upgrade

To achieve the best performance:

- Connect only good quality connection cables, thus avoiding interference, deterioration in signal quality due to poor matching, and elevated noise-levels (often associated with low quality cables)
- Avoid interference from neighboring electrical appliances and position your Kramer Universal Room Controllers away from moisture, excessive sunlight and dust



Caution – No operator-serviceable parts inside unit.

Warning – Use only the Kramer Electronics input power wall adapter that is provided with this unit⁴.

Warning – Disconnect power and unplug unit from wall before installing or removing device or servicing unit.

¹ Of up to five machines with unique IP addresses

² To be configured by the system integrator only

³ So that if the room is dark, the buttons are still visible to the instructor

⁴ For example: model number AD2512C, part number 2535-000251

4 Your Universal Room Controller

Figure 1 and Table 2 define the **RC-8RK** and **RC-8RKL** front panels:

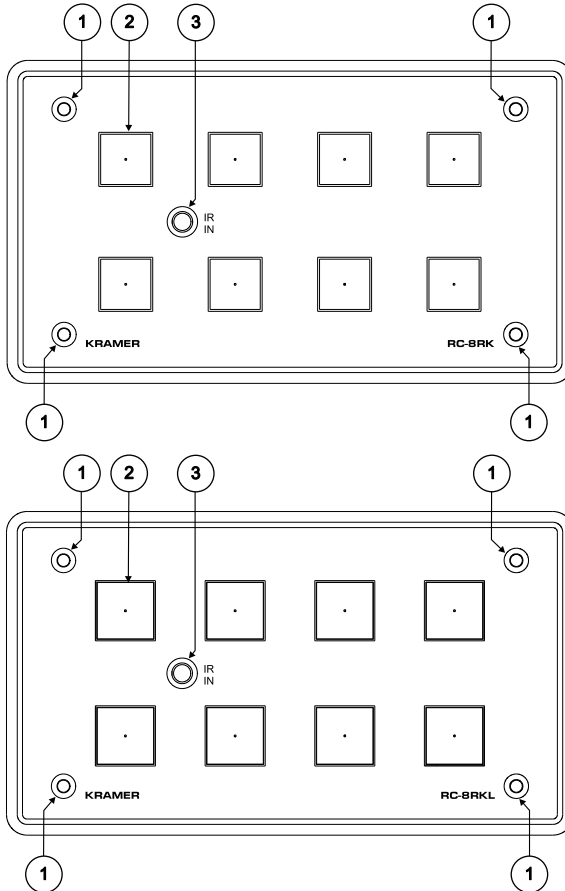

Figure 1: RC-8RK and RC-8RKL Front Panels

Table 1: RC-8RK and RC-8RKL Front Panel Features

#	Feature	Function
1	Mounting holes (4)	For fastening the controller in place
2	Configurable Buttons (Macro Buttons)	Control the room and the A/V equipment (from 1 to 8)
3	IR IN Receiver	Accepts IR remote commands (for the IR-learner feature)

Figure 2 and Table 2 define the RC-8RK / RC-8RKL (identical) rear panel:

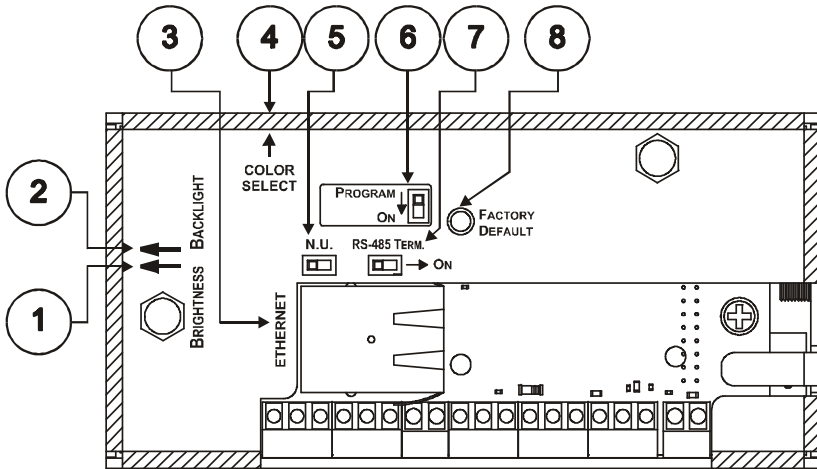

Figure 2: RC-8RK and the RC-8RKL Rear Panel

Table 2: RC-8RK and the RC-8RKL Rear Panel Features

#	Feature	Function
1	BRIGHTNESS Indication Arrow	Brightness indication to increase the brightness of the buttons ¹
2	BACKLIGHT Indication Arrow	Backlight indication to set the backlight illumination for when the unit is not active
3	ETHERNET Port	Connects to a PC or other controller via computer networking
4	COLOR SELECT Indication Arrow	Color select indication for selecting the button color ²
5	N.U Switch	Not used
6	PROGRAM Switch	Switch to OFF for normal operation; to ON for firmware upgrade
7	RS-485 TERM. Switch	Switch to ON for RS-485 line termination
8	FACTORY DEFAULT Button	Press to return to the factory default settings, including all the configured buttons and the network settings ³

1 See Table 5

2 See Table 4

3 Including the factory default IP number: 192.168.1.39 (an IP number is a device's numerical address as expressed in the format specified in the Internet Protocol)

Figure 3 and Table 3 define the **RC-8RK** and **RC-8RKL** lower rear panel:

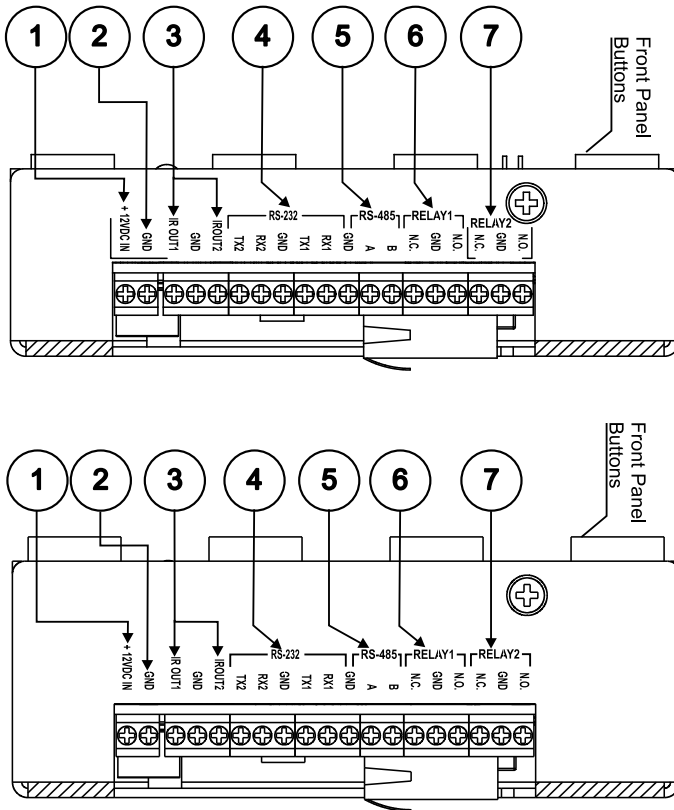

Figure 3: RC-8RK and the RC-8RKL Lower Rear Panel

Table 3: RC-8RK and the RC-8RKL Lower Rear Panel Features

#	Feature	Function
1	+12VDC IN PIN	Connects (+) to the connector for powering the unit
2	GND PIN	Connects (-) to the Ground
3	IR OUT1 PIN	Connect to an IR emitter cable
	GND PIN	
	IR OUT2 PIN	
4	RS-232 Terminal Block Connector (1 and 2)	Connect to the RS-232 connector on the AV equipment or a PC or other Serial Controller
5	RS-485 Terminal Block Connector	Connect to the RS-485 detachable terminal block on a switcher or PC
6	RELAY1	Connect each relay to a room item (such as lighting, screen settings, blinds, and so on) ¹
7	RELAY2	

¹ See the examples in Figure 6

Figure 4 and Table 4 define the **RC-8RK** and **RC-8RKL** upper rear panel:

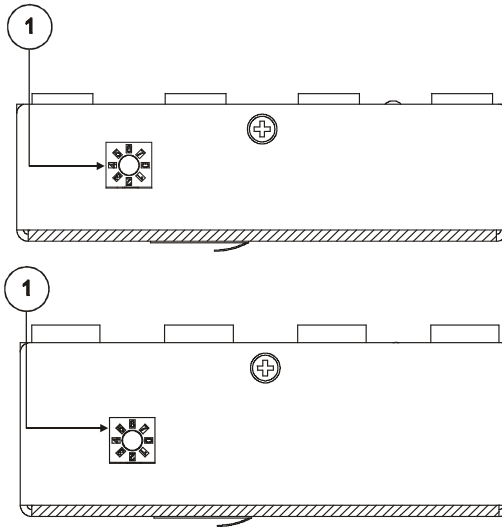

Figure 4: RC-8RK and the RC-8RKL Upper Rear Panel

Table 4: RC-8RK and the RC-8RKL Upper Rear Panel Features

#	Feature	Function			
1	COLOR SELECT Switch	Rotate to select the buttons' color:			
		1 for red	2 for blue	3 for green	4 for yellow
		5 for pale blue	6 for pink	7 for white	8 for no color

Figure 5 and Table 5 define the **RC-8RK** and the **RC-8RKL** rear side panel:

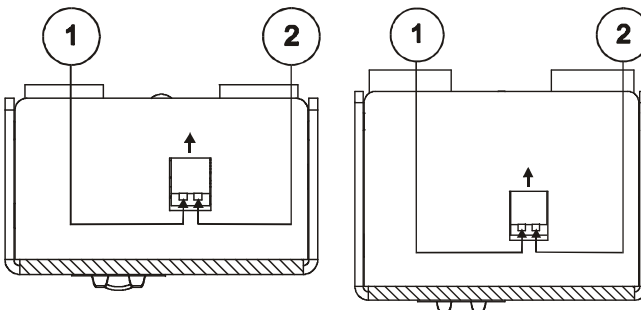

Figure 5: RC-8RK and the RC-8RKL Rear Side Panel

Table 5: RC-8RK and the RC-8RKL Rear Side Panel Features

#	Feature	Function
1	BRIGHTNESS Switch	Slide up to decrease the brightness of the buttons
2	BACKLIGHT Switch	Slide up to set backlight illumination for easier operation in a dark room

5 Using Your Universal Room Controller¹

This user manual is applicable once the unit is installed and configured². The installation process is not detailed in this user manual³, and includes:

- Setting up the labels on the buttons, according to your specific requirements⁴
- Hardware installation
- Connecting the inputs and the display
- Configuration via the Windows®-based configuration software and/or the IR learner

The universal room controller is very easy to use, as the example in Figure 6 and Table 6 defines⁵:

1 From this section on, all the information is relevant to the RC-8RK and RC-8RKL units, unless noted otherwise

2 By authorized Kramer technical personnel or by an external system integrator

3 Refer to the separate online “RC Configuration and Installation Guide” at <http://www.kramerelectronics.com>

4 It is recommended to place labels on the buttons prior to installing the unit, as this involves removing the face plate

5 Your RC-8RK/RC-8RKL was installed and configured to suit your specific requirements. This example describes how to setup one of an unlimited number of available setups for the system

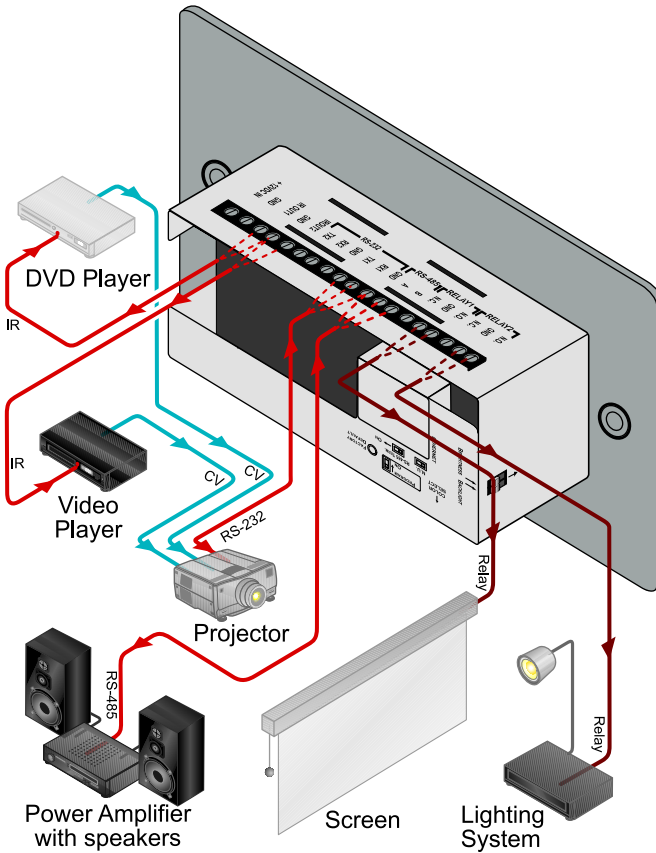

Figure 6: Example of a Typical RC-8RK / RC-8RKL Configuration

Table 6: Connection Scheme (for the example in Figure 6)

This connector:	Controls:
RELAY2	The lights
RELAY1	The screen
RS-485 Terminal Block Connector	A power amplifier (and speakers)
RS-232 (TX1, RX1) Terminal Block Connector	A projector ¹
IR OUT1 PIN ²	A DVD player
IR OUT2 PIN ²	A video player

1 The second RS-232 port can be used to control another A/V unit or an LCD

2 Connected via the IR emitter cable. IR OUT1 and IR OUT2 can each be connected to identical machines and still be controlled separately

Figure 7 shows the **RC-8RK** built into a podium that is located in a lecture auditorium. An overhead projector and screen, speakers, lights; and a cabinet with a VCR, a DVD and an amplifier inside, are all controlled via the **RC-8RK**. The presenter's laptop is located on the podium, next to where the **RC-8RK** is mounted. It is also controlled by the **RC-8RK** and is used for presentations, slide shows and so on.

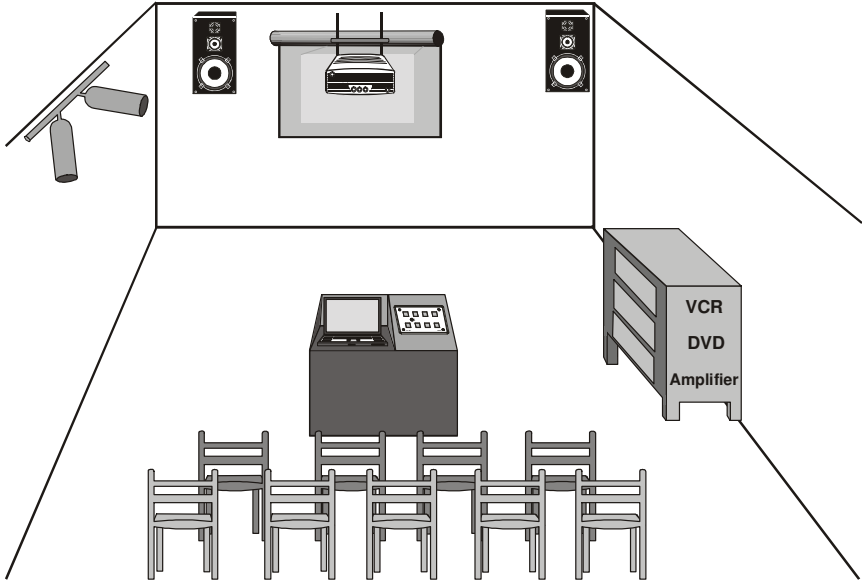

Figure 7: Example of a Typical RC-8RK Setup in the Lecture Auditorium

5.1 Operating the RC-8RK

In the following example¹ that is illustrated in Figure 8, the **RC-8RK** is labeled with specific functions and each button is programmed² to perform several tasks³ as defined in Table 7.

Each button may be assigned with up to 15 commands.

Table 7: The Commands Configuration

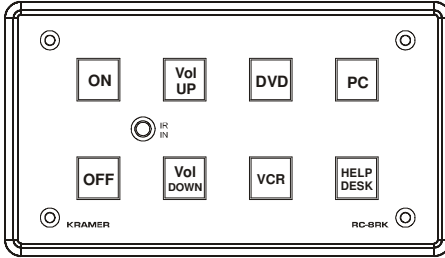

Figure 8: RC-8RK Labels Setup

The Label	The Macro Sequence
ON	<ul style="list-style-type: none"> • Power up the projector • Power up the power amplifier • Power up the DVD player • Power up the video player • Roll down the projector screen • Turn on the speakers • 1 minute delay [for the projector to heat up] • Turn lights off • The projector selects the PC input
OFF	<ul style="list-style-type: none"> • Turn lights on • Power down the projector • Power down the power amplifier • Stop the DVD player • Power down the DVD player • Stop the video player • Power down the video player • Roll up the projector screen • Turn off the speakers
DVD	<ul style="list-style-type: none"> • Stop the video player • The projector selects the DVD input • Play the DVD
VCR	<ul style="list-style-type: none"> • Stop the DVD • The projector selects the VCR input • Play the VCR
PC	<ul style="list-style-type: none"> • Stop the DVD • Stop the VCR • The projector selects a PC input
Vol UP	<ul style="list-style-type: none"> • Power amplifier volume up
Vol DOWN	<ul style="list-style-type: none"> • Power amplifier volume down
HELP DESK	<ul style="list-style-type: none"> • Call for technical assistance

¹ This is only one example among numerous possibilities, each button can be configured as required

² By the technical installer

³ A macro sequence, including up to 15 commands per button, carried out one after the other

5.2 An Example of Operating the RC-8RK

Figure 9 shows an operating example:

Operating Example

The presenter places the laptop on the podium and connects it to the PC input.
The lecture includes a short introduction by the presenter, a slide show presentation via the laptop, a DVD program, more slides, a video film, and some final slides to conclude the lecture. Following the introduction, the presenter presses the RC-8RK



<div style="border: 1px solid black; padding: 2px; margin-bottom: 5px; width: 30px; margin: 0 auto;">ON</div> <div style="border: 1px solid black; padding: 2px; margin-bottom: 5px; width: 30px; margin: 0 auto;">DVD</div> <div style="display: flex; justify-content: space-between; width: 30px; margin: 0 auto;"> <div style="border: 1px solid black; padding: 2px; margin-bottom: 5px; width: 15px;">Vol UP</div> <div style="border: 1px solid black; padding: 2px; margin-bottom: 5px; width: 15px;">Vol DOWN</div> </div> <div style="border: 1px solid black; padding: 2px; margin-bottom: 5px; width: 30px; margin: 0 auto;">PC</div> <div style="border: 1px solid black; padding: 2px; margin-bottom: 5px; width: 30px; margin: 0 auto;">VCR</div> <div style="border: 1px solid black; padding: 2px; margin-bottom: 5px; width: 30px; margin: 0 auto;">PC</div> <div style="border: 1px solid black; padding: 2px; margin-bottom: 5px; width: 30px; margin: 0 auto;">OFF</div>	<p>Turn on the projector, DVD player, video player and receiver, roll down the screen, turn off the lights and start the slide show via the laptop</p> <p>Select the DVD input on the projector and play the DVD</p> <p>Adjust the speakers' audio volume throughout the lecture</p> <p>Select the PC input on the projector and resume the slide show</p> <p>Select the VCR input on the projector and show the video film¹</p> <p>Select the PC input on the projector and show the last few slides of the presentation</p> <p>Turn on the lights, power down the projector, DVD player, video player and receiver, roll up the screen and turn off the speakers</p>
---	---

Figure 9: RC-8RK Operation Example

5.3 Using the Macro Buttons

Pressing any button initiates a macro sequence¹, during which the button blinks (as programmed by the system integrator).

If during the macro sequence the button blinks faster than usual², this indicates that a malfunction has been detected³ and the **RC-8RK** exits the macro sequence.

¹ The macro sequence can be carried out instantly or can take a while, depending on the delay times included in the sequence

² Six times per second, as compared with twice per second during normal operation

³ For example, a faulty DVD player

To solve the problem, summon technical help¹

If you want to stop a macro sequence, press and hold that button for 5 seconds. The sequence will come to an end. You can resume operation by pressing any of the buttons². The unit will carry out the macro sequence commands from the beginning.

5.4 Using the Internal Web Page

The internal Web page can be used to remotely operate the **RC-8RK** via the Ethernet.

To control your **RC-8RK** via the internal Web page, do the following:

1. Type the unit's IP number³ in the Address bar of your browser (or type any link defined by the system integrator).
The **RC-8RK** front panel is displayed on your screen (see Figure 10).
2. Press the on-screen buttons to control the unit.

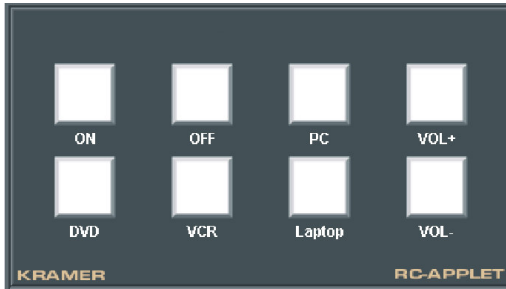

Figure 10: Internal Web Page Front Panel

¹ In this example, press the HELP DESK button

² Including the button you kept pressed to stop the macro sequence

³ The default IP number is 192.168.1.39, and may be changed by the system integrator

6 Technical Specifications

Table 8 defines the technical specifications:

Table 8: Technical Specifications¹ of the Universal Room Controller Series

PORTS:	2 RS-232 on terminal block connectors; 1 RS-485 on terminal block connectors; 1 ETHERNET RJ-45 port
OUTPUTS:	2 relays on terminal block connectors (30V AC or DC, 2A, 60VA maximum); 2 IR emitters on terminal block connectors
POWER SOURCE:	RC-8RK : 12V DC, 140mA; RC-8RKL : 12V DC, 240mA
DIMENSIONS:	15.1cm x 3.2cm x 8.6cm (5.94" x 1.26" x 3.39", W, D, H)
WEIGHT:	0.3kg (0.67lbs) approx.
ACCESSORIES:	Kramer 3.5mm to IR Emitter Control Cable (C-A35/IRE-10), power supply, two extra M3x5 screws, Java based control software (internal), Windows®-based Kramer control software
OPTIONS:	Kramer 3.5mm to IR Emitter Control Cable (C-A35/IRE-10), 15-meter and 20-meter IR emitter extension cables

¹ Specifications are subject to change without notice

LIMITED WARRANTY

Kramer Electronics (hereafter *Kramer*) warrants this product free from defects in material and workmanship under the following terms.

HOW LONG IS THE WARRANTY

Labor and parts are warranted for seven years from the date of the first customer purchase.

WHO IS PROTECTED?

Only the first purchase customer may enforce this warranty.

WHAT IS COVERED AND WHAT IS NOT COVERED

Except as below, this warranty covers all defects in material or workmanship in this product. The following are not covered by the warranty:

1. Any product which is not distributed by Kramer, or which is not purchased from an authorized Kramer dealer. If you are uncertain as to whether a dealer is authorized, please contact Kramer at one of the agents listed in the Web site www.kramerelectronics.com.
2. Any product, on which the serial number has been defaced, modified or removed, or on which the WARRANTY VOID IF TAMPERED sticker has been torn, reattached, removed or otherwise interfered with.
3. Damage, deterioration or malfunction resulting from:
 - i) Accident, misuse, abuse, neglect, fire, water, lightning or other acts of nature
 - ii) Product modification, or failure to follow instructions supplied with the product
 - iii) Repair or attempted repair by anyone not authorized by Kramer
 - iv) Any shipment of the product (claims must be presented to the carrier)
 - v) Removal or installation of the product
 - vi) Any other cause, which does not relate to a product defect
 - vii) Cartons, equipment enclosures, cables or accessories used in conjunction with the product

WHAT WE WILL PAY FOR AND WHAT WE WILL NOT PAY FOR

We will pay labor and material expenses for covered items. We will not pay for the following:

1. Removal or installations charges.
2. Costs of initial technical adjustments (set-up), including adjustment of user controls or programming. These costs are the responsibility of the Kramer dealer from whom the product was purchased.
3. Shipping charges.

HOW YOU CAN GET WARRANTY SERVICE

1. To obtain service on you product, you must take or ship it prepaid to any authorized Kramer service center.
2. Whenever warranty service is required, the original dated invoice (or a copy) must be presented as proof of warranty coverage, and should be included in any shipment of the product. Please also include in any mailing a contact name, company, address, and a description of the problem(s).
3. For the name of the nearest Kramer authorized service center, consult your authorized dealer.

LIMITATION OF IMPLIED WARRANTIES

All implied warranties, including warranties of merchantability and fitness for a particular purpose, are limited in duration to the length of this warranty.

EXCLUSION OF DAMAGES

The liability of Kramer for any effective products is limited to the repair or replacement of the product at our option. Kramer shall not be liable for:

1. Damage to other property caused by defects in this product, damages based upon inconvenience, loss of use of the product, loss of time, commercial loss; or
2. Any other damages, whether incidental, consequential or otherwise. Some countries may not allow limitations on how long an implied warranty lasts and/or do not allow the exclusion or limitation of incidental or consequential damages, so the above limitations and exclusions may not apply to you.

This warranty gives you specific legal rights, and you may also have other rights, which vary from place to place.

NOTE: All products returned to Kramer for service must have prior approval. This may be obtained from your dealer.

This equipment has been tested to determine compliance with the requirements of:

- EN-50081: "Electromagnetic compatibility (EMC);
generic emission standard.
Part 1: Residential, commercial and light industry"
- EN-50082: "Electromagnetic compatibility (EMC) generic immunity standard.
Part 1: Residential, commercial and light industry environment".
- CFR-47: FCC* Rules and Regulations:
Part 15: "Radio frequency devices
Subpart B Unintentional radiators"

CAUTION!

- Servicing the machines can only be done by an authorized Kramer technician. Any user who makes changes or modifications to the unit without the expressed approval of the manufacturer will void user authority to operate the equipment.
- Use the supplied DC power supply to feed power to the machine.
- Please use recommended interconnection cables to connect the machine to other components.
* FCC and CE approved using STP cable (for twisted pair products)



For the latest information on our products and a list of Kramer distributors, visit our Web site: www.kramerelectronics.com, where updates to this user manual may be found. We welcome your questions, comments and feedback.



Caution

Safety Warning:

Disconnect the unit from the power supply before opening/servicing.



Kramer Electronics, Ltd.

Web site: www.kramerelectronics.com

E-mail: info@kramerelectronics.com

P/N: 2900-000425 REV 1