

# T800

Handbook

Visual Supervisor



## Declaration of Conformity

<b>Manufacturer's name:</b>	<b>Eurotherm Limited</b>
<b>Manufacturer's address:</b>	<b>Faraday Close, Worthing, West Sussex, BN13 3PL, United Kingdom</b>
<b>Product type:</b>	<b>Visual Supervisor</b>
<b>Models:</b>	<b>T800 (small frame) Status level Q36 and above T800 (large frame) Status level Q16 and above</b>
<b>Safety specification:</b>	<b>EN61010-1</b>
<b>EMC emissions specification:</b>	<b>EN61326</b>
<b>EMC immunity specification:</b>	<b>EN61326 Industrial</b>

Eurotherm Limited hereby declares that the above products conform to the safety and EMC specifications listed. Eurotherm Limited further declares that the above products comply with the EMC Directive 89 / 336 / EEC amended by 93 / 68 / EEC, and also with the Low Voltage Directive 73 / 23 / EEC.

Signed: William Davis Dated: 15th July 04

Signed for and on behalf of Eurotherm Limited  
William Davis  
(General Manager)



IA249986U430 Issue 2 Jly 04

© 2004 Eurotherm Limited

All rights are strictly reserved. No part of this document may be reproduced, modified, or transmitted in any form by any means, nor may it be stored in a retrieval system other than for the purpose to act as an aid in operating the equipment to which the document relates, without the prior written permission of Eurotherm limited.

Eurotherm Limited pursues a policy of continuous development and product improvement. The specifications in this document may therefore be changed without notice. The information in this document is given in good faith, but is intended for guidance only. Eurotherm Limited will accept no responsibility for any losses arising from errors in this document.



# VISUAL SUPERVISOR

## HANDBOOK

### LIST OF CHAPTERS

<b>Section</b>	<b>Page</b>
1 INSTALLATION .....	1- 1
2 GETTING STARTED .....	2 - 1
3 OPERATION .....	3 - 1
4 MANAGEMENT .....	4 - 1
5 CUSTOMISING .....	5 - 1
6 MODBUS COMMUNICATIONS .....	6 - 1
7 PROFIBUS COMMUNICATIONS .....	7 - 1
8 ADMINISTRATIVE FUNCTIONS .....	8 - 1
9 REMOTE ACCESS .....	9 - 1
10 PREVENTIVE MAINTENANCE .....	10 - 1
A SPECIFICATION .....	A - 1
B ORDERING INFORMATION .....	B - 1
C REFERENCE .....	C - 1

### EFFECTIVITY

This manual refers to instruments fitted with software version number V5

### RELATED MANUALS

The Setpoint Program Editor Handbook .....	HA261134U005 Issue 1A
The UserScreen Editor Handbook .....	HA260749U005 Issue 1A
The LIN Blocks Reference Manual .....	HA082375U003 Issue 7
LINtools 2000 On-line user guide .....	RM263001U055 Issue N/A
The LIN/ALIN Installation and User Guide .....	HA082429U005 Issue 2
The 2500 Controller User Manual .....	HA027773 Issue 2
The iTools User Manual .....	HA026179 Issue 2

*All registered and unregistered trademarks are properties of their respective holders.*

## LIST OF CONTENTS

Section	Page
SAFETY NOTES .....	1 - 1
SYMBOLS USED ON THE EQUIPMENT LABELLING .....	1 - 2
PREVENTIVE MAINTENANCE .....	1 - 2
<b>Chapter 1: INSTALLATION .....</b>	<b>1 - 3</b>
1.1 UNPACKING .....	1 - 3
1.2 MECHANICAL INSTALLATION .....	1 - 4
1.2.1 Current units .....	1 - 4
1.2.2 Large-frame units (pre mid-June 2002) .....	1 - 4
1.3 ELECTRICAL INSTALLATION .....	1 - 8
1.3.1 Rear panel layout and connector pinouts .....	1 - 8
1.3.1.1 MASTER/SLAVE COMMS SOCKETS .....	1 - 10
1.3.1.2 ALIN (ARCNET) SOCKETS .....	1 - 11
1.3.1.3 PROFIBUS CONNECTORS .....	1 - 11
1.3.1.4 BAR CODE READER/CREDIT CARD SCANNER .....	1 - 12
1.3.1.5 PARALLEL PRINTER PORT .....	1 - 12
1.3.1.6 SERIAL PRINTER PORT .....	1 - 12
1.3.1.7 ETHERNET (100/10 BASE-T) CONNECTOR .....	1 - 13
1.3.1.8 USB CONNECTOR .....	1 - 13
1.3.2 Signal wiring, visual supervisor to 2500 I/O units .....	1 - 14
CONNECTORS AND CABLES .....	1 - 14
1.3.3 Signal wiring: Configuration port .....	1 - 14
1.3.3.1 VISUAL SUPERVISOR TO CONFIGURATION PC .....	1 - 14
1.3.3.2 2500 TO PC RUNNING ITOOLS .....	1 - 16
1.3.3.3 2500 TO PC RUNNING ITOOLS, VIA TALKTHROUGH .....	1 - 16
1.3.4 Permanent link to a PC running SCADA .....	1 - 16
1.3.5 Cable schedule .....	1 - 17
1.3.6 Supply voltage wiring .....	1 - 18
1.3.6.1 AC SUPPLY .....	1 - 18
1.3.6.2 DC SUPPLY .....	1 - 19
1.3.6.3 FUSE REPLACEMENT (SMALL FRAME UNITS) .....	1 - 20
1.3.6.4 FUSE REPLACEMENT (LARGE FRAME UNITS) .....	1 - 21
1.4 SWITCHING COMMUNICATIONS PARAMETERS .....	1 - 22
1.4.1 Small frame units .....	1 - 22
1.4.2 Large frame units .....	1 - 23
1.5 GETTING FIRST ACCESS .....	1 - 24
1.6 SETTING THE CLOCK .....	1 - 24
1.7 MANUAL SELF TESTS .....	1 - 24
1.7.1 Battery test .....	1 - 24
1.7.2 Relay/LED test .....	1 - 25
1.7.3 Reset instrument .....	1 - 25
<b>Chapter 2: GETTING STARTED .....</b>	<b>2 - 1</b>
2.1 SWITCH-ON AND THE OPENING DISPLAY .....	2 - 1
2.1.1 Switch on .....	2 - 1
2.1.2 The user interface .....	2 - 1
2.1.3 The standard interface .....	2 - 1
2.1.3.1 DISPLAY PANES .....	2 - 2
2.1.3.2 NAVIGATION KEYS .....	2 - 3
2.1.3.3 KEYBOARD OPERATION .....	2 - 4
2.1.4 The opening display .....	2 - 5
2.2 THE MAIN PANE .....	2 - 6
2.2.1 Information display .....	2 - 6
2.2.2 Information entry .....	2 - 6

## LIST OF CONTENTS (Cont.)

Section	Page
2.3 THE POP-UP MENU .....	2 - 7
2.4 THE PROGRAM PANE .....	2 - 8
2.4.1 Displaying program status .....	2 - 8
WITH NO PROGRAM LOADED .....	2 - 8
WITH A PROGRAM LOADED .....	2 - 8
2.4.2 Programmer menu access .....	2 - 8
2.5 THE PROGRAMMER MENU .....	2 - 9
2.6 THE ALARM PANE .....	2 - 10
2.6.1 Alarm state indication .....	2 - 10
ACTIVE MESSAGE DISPLAY .....	2 - 11
2.6.2 Responding to alarms .....	2 - 11
DO NOTHING .....	2 - 11
ALARM HISTORY PAGE .....	2 - 11
TWO LINE DISPLAY .....	2 - 12
ALARM ACKNOWLEDGEMENT .....	2 - 12
2.7 LOGGING PANE .....	2 - 13
2.8 ACCESS PANE .....	2 - 13
2.8.1 Gaining access .....	2 - 13
2.8.1.1 STANDARD ACCESS .....	2 - 13
2.8.1.2 USER ID ACCESS METHOD .....	2 - 16
2.9 THE FLOPPY DISK .....	2 - 16
2.10 CREATING A DATABASE AUTOMATICALLY .....	2 - 17
2.10.1 Running Auto database create .....	2 - 18
PROGRAMMER .....	2 - 18
LOGGING .....	2 - 18
LOOPS .....	2 - 18
I/O .....	2 - 18
2.10.2 Database creation .....	2 - 19
2.10.3 Database renaming .....	2 - 19
<b>Chapter 3: OPERATION .....</b>	<b>3 - 1</b>
3.1 RUNNING A PROGRAM .....	3 - 1
3.1.1 Running a program now .....	3 - 1
3.1.2 Running from a point .....	3 - 3
3.1.3 Scheduling a program .....	3 - 4
3.1.3.1 SPECIFYING THE PROGRAM START DATE .....	3 - 5
3.1.3.2 SPECIFYING THE PROGRAM START TIME .....	3 - 5
3.1.3.3 CHANGING THE NUMBER OF ITERATIONS (RUNS) .....	3 - 6
3.1.4 Segment skip .....	3 - 7
3.1.4.1 SEGMENT TRANSITION CONSEQUENCES .....	3 - 7
FROM DWELL, SET OR SEVO (SP OR PV) TO ANY OTHER TYPE .....	3 - 7
FROM RAMP TO SET .....	3 - 7
FROM RAMP TO DWELL .....	3 - 7
FROM RAMP TO END (STARTING VALUES) .....	3 - 7
FROM RAMP TO COMPLETE (INFINITE DWELL) .....	3 - 7
TO RAMP FROM ANY OTHER TYPE .....	3 - 7
3.2 HOLDING AND ABORTING A PROGRAM .....	3 - 8
3.2.1 Holding a program .....	3 - 8
3.2.2. Aborting a program .....	3 - 8
3.3 MONITORING A PROGRAM .....	3 - 9
3.3.1 The monitor facility .....	3 - 9
3.3.2 The preplot facility .....	3 - 10
STANDARD DISPLAY MODE .....	3 - 10
REVIEW MODE .....	3 - 10

## LIST OF CONTENTS (Cont.)

Section	Page
3.4 LOGGING DATA .....	3 - 11
3.4.1 Types of files .....	3 - 11
ASCII .....	3 - 11
BINARY .....	3 - 11
UHH .....	3 - 11
3.4.2 Name types .....	3 - 11
TEXT .....	3 - 11
HOURLY .....	3 - 11
DAILY .....	3 - 11
SEQUENCE .....	3 - 11
3.4.3 Floppy disk .....	3 - 12
3.4.4 Training sequence .....	3 - 12
MONITOR .....	3 - 13
OFF-LINE .....	3 - 13
MANAGE .....	3 - 13
GROUPS .....	3 - 13
3.4.5 The Manage facility .....	3 - 14
ARCHIVE EXPORT .....	3 - 15
3.4.6 Data integrity .....	3 - 15
3.5 ALARMS / MESSAGE RESPONSE .....	3 - 16
TIME REPRESENTATION .....	3 - 16
3.5.1 Alarm history page .....	3 - 16
TWO LINE DISPLAY .....	3 - 17
FILTER KEYS .....	3 - 17
ACK KEY .....	3 - 18
ARCHIVE .....	3 - 18
3.5.2 Alarm/Message Acknowledgement .....	3 - 18
ALARMS .....	3 - 18
MESSAGES .....	3 - 18
3.5.3. Adding notes to alarm history .....	3 - 18
3.5.4 Alarm history archive .....	3 - 19
3.5.5 Alarm summary page .....	3 - 19
3.5.6 Event Log .....	3 - 20
TWO LINE DISPLAY .....	3 - 20
3.6 AREA AND GROUP DISPLAYS .....	3 - 21
3.6.1 Overview .....	3 - 21
TREND DISPLAYS .....	3 - 21
ALARM INDICATION .....	3 - 21
3.6.2 Function block faceplates .....	3 - 23
TWO-CHANNEL ANALOGUE INPUT (AI2) MODULE .....	3 - 23
ANALOGUE OUTPUT MODULES .....	3 - 23
DIGITAL INPUT MODULES .....	3 - 24
DIGITAL OUTPUT MODULES .....	3 - 24
RAMP FACEPLATES .....	3 - 25
LOOP FACEPLATES .....	3 - 26
PID FACEPLATES .....	3 - 27
3.6.3 Display modes .....	3 - 27
FACEPLATE DISPLAY .....	3 - 28
NUMERIC DISPLAY .....	3 - 28
VERTICAL BARGRAPH .....	3 - 28
HORIZONTAL BARGRAPH .....	3 - 29
VERTICAL TREND WITH FACEPLATE .....	3 - 29
VERTICAL TREND - FULL WIDTH .....	3 - 31
HORIZONTAL TREND WITH FACEPLATE .....	3 - 31
HORIZONTAL TREND - FULL WIDTH .....	3 - 32



## LIST OF CONTENTS (Cont.)

Section	Page
3.7 DOWNLOADING RECIPES .....	3 - 33
RECIPE SET SELECTION .....	3 - 34
3.7.1 Download procedure .....	3 - 34
LOADING THE RECIPE .....	3 - 34
SELECTING A RECIPE LINE .....	3 - 35
SELECTING A RECIPE .....	3 - 35
3.7.2 Monitoring the recipe .....	3 - 35
RECIPE STATUS PAGE .....	3 - 35
RECIPE MONITOR PAGE .....	3 - 36
3.8 BATCHES .....	3 - 37
3.8.1 Batch loading .....	3 - 37
3.8.2 Recipe selection .....	3 - 37
3.8.3 Batch customising .....	3 - 37
3.8.4 Batch initiation .....	3 - 38
3.8.5 Batch monitoring .....	3 - 38
3.8.6 Batch Hold .....	3 - 38
3.8.7 Batch Abort .....	3 - 38
3.8.8 Batch Create .....	3 - 39
<b>Chapter 4: MANAGEMENT .....</b>	<b>4 - 1</b>
4.1. EDITING A PROGRAM .....	4 - 1
4.1.1 INTRODUCTION .....	4 - 1
4.1.1.1 CREATING A PROGRAM .....	4 - 1
4.1.1.2 EDITING A PROGRAM .....	4 - 1
4.1.2 Program Editor Page access .....	4 - 3
4.1.3 Changing a setpoint .....	4 - 4
4.1.3.1 CHANGING RAMP TYPE .....	4 - 4
TERMINOLOGY .....	4 - 4
TO CHANGE THE TYPE OF RAMP .....	4 - 5
4.1.3.2 CHANGING SETPOINT VALUE .....	4 - 6
4.1.4 Changing a segment .....	4 - 7
4.1.4.1 CHANGING SEGMENT IDENTIFIER .....	4 - 7
4.1.4.2 CHANGING SEGMENT DURATION .....	4 - 8
4.1.5 Inserting/deleting segments .....	4 - 8
4.1.5.1 INSERTING A (NULL) SEGMENT .....	4 - 8
4.1.5.1 INSERTING A (NULL) SEGMENT (CONT.) .....	4 - 9
4.1.5.2 DELETING A SEGMENT .....	4 - 9
4.1.6 Changing hold back properties .....	4 - 9
4.1.6.1 CHOOSING THE SETPOINT .....	4 - 10
4.1.6.2 CHANGING HOLD BACK MODE .....	4 - 10
4.1.6.3 CHANGING HOLDBACK VALUES .....	4 - 10
4.1.7 Changing program properties .....	4 - 11
4.1.7.1 CHANGING PROGRAM NAMES .....	4 - 11
4.1.7.2 CHANGING RATE UNITS .....	4 - 12
4.1.7.3 CHOOSING END-OF-RUN ACTION .....	4 - 12
4.1.7.4 CHANGING DEFAULT ITERATIONS .....	4 - 13
4.1.8 Changing setpoint names .....	4 - 13
4.1.9 Segment timing display .....	4 - 14
4.2 LOGGING GROUPS OF DATA .....	4 - 15
4.2.1 Log initiation .....	4 - 15
4.2.1.1 LOG CONFIGURATION .....	4 - 16
4.3 MANAGING AN APPLICATION .....	4 - 18
4.3.1 Application summary page .....	4 - 19
4.3.2 Application manager page .....	4 - 19
4.3.3 Stopping an application .....	4 - 20
4.3.4 Saving application data .....	4 - 21

## LIST OF CONTENTS (Cont.)

Section	Page
4.3.5 Unloading an application .....	4 - 21
4.3.6 Loading or loading and running an application .....	4 - 22
4.3.6.1 APPLICATION SELECTION .....	4 - 22
4.3.6.2 APPLICATION LOADING .....	4 - 22
4.3.7 Deleting an application .....	4 - 22
4.3.8 Displaying application diagnostics .....	4 - 23
4.3.9 Function block manager .....	4 - 23
4.3.9.1 ALPHA-NUMERIC BLOCK DISPLAY .....	4 - 26
4.3.9.2 FUNCTION BLOCK DETAILS .....	4 - 27
4.4 CONTROLLING ACCESS .....	4 - 27
4.4.1 First-time access .....	4 - 28
4.4.2 Editing the passwords .....	4 - 28
4.4.3 User ID system .....	4 - 30
4.4.3.1 CHANGING TO THE USER ID SYSTEM .....	4 - 30
4.4.3.2 USER ID MANAGEMENT .....	4 - 31
4.5 SETTING UP AND RE-SETTING THE INSTRUMENT .....	4 - 35
4.5.1 Editing communications parameters .....	4 - 35
4.5.1.1 SOFTWARE PARAMETER EDITING .....	4 - 36
4.5.1.2 HARDWARE CHANGES .....	4 - 36
4.5.1.3 PROTOCOLS AVAILABLE .....	4 - 37
4.5.1.4 TALK-THRU .....	4 - 37
4.5.1.5 ETHERNET .....	4 - 38
4.5.2 Setting the start-up strategy .....	4 - 39
HOT/COLD START CRITERIA .....	4 - 39
4.5.2.1 START-UP STRATEGY PAGE .....	4 - 39
4.5.2.2 CHANGING START-UP VALUES .....	4 - 40
4.5.3 Resetting the clock .....	4 - 41
4.5.3.1 CLOCK SETUP PAGE ACCESS .....	4 - 41
4.5.3.2 CHANGING DATE AND TIME .....	4 - 41
TIME CHANGING .....	4 - 42
4.5.4 Changing language and date/time formats .....	4 - 42
4.5.4.1 LANGUAGE .....	4 - 43
4.5.4.2 DATE FORMAT .....	4 - 43
4.5.4.3 TIME FORMAT .....	4 - 43
4.5.5 Setting up the panel display .....	4 - 44
4.5.5.1 ACCESS TO THE PANEL SETUP PAGE .....	4 - 44
4.5.5.2 DISPLAY BRIGHTNESS SETTINGS .....	4 - 45
4.5.5.3 TIME-OUTS .....	4 - 45
4.5.5.4 DATA ENTRY .....	4 - 45
4.6 CLONING AN INSTRUMENT .....	4 - 46
4.6.1 Accessing the cloning page .....	4 - 46
4.6.2 Cloning application data .....	4 - 47
4.6.2.1 EXPORTING APPLICATION DATA .....	4 - 47
4.6.2.2 IMPORTING APPLICATION DATA .....	4 - 47
4.6.3 Cloning system (instrument) data .....	4 - 48
4.6.3.1 SELECTING SYSTEM DATA .....	4 - 48
4.6.3.2 EXPORTING SYSTEM DATA .....	4 - 48
4.6.3.3 IMPORTING SYSTEM DATA .....	4 - 48
4.6.4 Cloning both application and system data (ALL) .....	4 - 49
4.7 FILE MANAGER .....	4 - 50
4.7.1 Stopping the application .....	4 - 50
4.7.2 Calling the file manager .....	4 - 50
4.7.3 File Copy and Delete .....	4 - 51
4.7.4 Reloading the application .....	4 - 52

## LIST OF CONTENTS (Cont.)

Section	Page
4.8 RECIPE MANAGEMENT .....	4 - 52
4.8.1 Creating recipe files .....	4 - 52
4.8.2 Recipe editing .....	4 - 52
4.8.2.1 ADD RECIPE LINE .....	4 - 52
4.8.2.2 ADD A VARIABLE .....	4 - 53
4.8.2.3 TAG REFERENCES .....	4 - 53
4.8.2.4 RECIPE VALUE .....	4 - 53
4.8.2.5 ADDING A RECIPE .....	4 - 53
4.8.2.6 DELETING RECIPES .....	4 - 53
4.8.2.7 SAVING RECIPES .....	4 - 53
4.8.2.8 RECIPE FILE PROPERTIES .....	4 - 54
4.8.3 Capturing a Recipe .....	4 - 54
4.9 OEM FEATURES .....	4 - 55
4.9.1 Intellectual Property Right Protection (IPRP) .....	4 - 55
4.9.1.1 MODIFYING IPRP SETTINGS .....	4 - 55
<b>Chapter 5: CUSTOMISING .....</b>	<b>5 - 1</b>
5.1 INTRODUCTION .....	5 - 1
5.1.1 The dictionaries .....	5 - 1
5.1.2 Panel navigation and database names .....	5 - 2
5.2 THE SYSTEM TEXT DICTIONARY .....	5 - 2
5.2.1 File structure .....	5 - 2
5.2.2 Editing system text .....	5 - 3
5.2.3 New language versions .....	5 - 3
5.2.4 The dictionary .....	5 - 3
5.2.5 Panel customisation using the dictionary .....	5 - 26
5.2.6 Alarm/event customisation using the dictionary .....	5 - 27
5.3 THE ERROR TEXT DICTIONARY .....	5 - 28
5.3.1 Editing error messages .....	5 - 29
5.3.2 Creating new language error text .....	5 - 29
PROCEDURE .....	5 - 29
5.4 THE EVENT TEXT DICTIONARY .....	5 - 30
5.4.1 Editing Event Messages .....	5 - 34
5.4.2 Creating new language error text .....	5 - 34
PROCEDURE .....	5 - 34
5.4.3 EVENT PRIORITIES .....	5 - 34
5.5 THE USER TEXT DICTIONARY .....	5 - 35
5.6 THE PROGRAMMER TEXT DICTIONARY .....	5 - 35
5.7 PANEL NAVIGATION .....	5 - 36
5.7.1 The Panel Navigation file .....	5 - 36
5.7.1.1 THE VERSIONS .....	5 - 36
5.7.1.2 Auditor option versions .....	5 - 40
5.7.2 Editing the _default.pnl file .....	5 - 43
5.7.3 Line types .....	5 - 44
5.7.3.1 PANEL AGENT DECLARATION .....	5 - 44
5.7.3.2 PANEL DRIVER DECLARATION .....	5 - 45
5.7.3.3 HOME PAGE DECLARATION .....	5 - 46
5.7.3.4 ROOT PAGE DECLARATION .....	5 - 46
5.7.3.5 INITIAL PAGE DECLARATION .....	5 - 46
5.7.4 Agent types .....	5 - 47
5.8 DATABASE NAMES .....	5 - 49
5.8.1 Function block names .....	5 - 49
5.8.2 Alarm names .....	5 - 49
5.8.3 Enumerations .....	5 - 50
TAGS .....	5 - 50

## LIST OF CONTENTS (Cont.)

Section	Page
5.9 FORM FILES .....	5 - 51
5.9.1 Report forms .....	5 - 51
5.9.1.1 UYF FILE ENTRIES .....	5 - 52
5.9.2 Alarm forms .....	5 - 55
5.9.2.1 EXAMPLE .....	5 - 55
5.10 RECIPE FILES .....	5 - 56
5.10.1 Basic Recipe File .....	5 - 56
5.10.1.1 FILE HEADER .....	5 - 56
5.10.1.2 TITLE LINE .....	5 - 57
5.10.1.3 VARIABLE LINES .....	5 - 57
5.10.1.4 BASIC FILE EXAMPLE .....	5 - 57
5.10.2 More complex files .....	5 - 58
5.10.2.1 MULTI-LINE FILES .....	5 - 58
5.10.2.2 FILES WITH OPTIONAL CAPTURE VARIABLES .....	5 - 58
5.10.2.3 FILES WITH OPTIONAL MONITOR VARIABLES .....	5 - 59
5.11 WRITABLE DICTIONARY .....	5 - 59
5.12 THE RECIPE DICTIONARY .....	5 - 60
5.13 THE BATCH DICTIONARY .....	5 - 61
5.14 BATCH FILES .....	5 - 62
5.14.1 File Header .....	5 - 62
5.14.2 Batch Phases .....	5 - 63
5.15 BAR CODE READER FILES .....	5 - 64
5.15.1 Overview .....	5 - 64
PATTERN DELIMITER .....	5 - 64
5.15.2 Literal text .....	5 - 65
EMPTY STRINGS .....	5 - 65
5.15.3 Dictionary text .....	5 - 66
5.15.4 LIN database variables .....	5 - 66
SYSTEM VARIABLES .....	5 - 67
ENUMERATIONS .....	5 - 67
5.15.5 Number of characters .....	5 - 68
5.15.6 Number of decimal places .....	5 - 68
5.15.7 Formatting attributes .....	5 - 68
5.15.8 User actions .....	5 - 69
<b>Chapter 6 MODBUS .....</b>	<b>6 - 1</b>
6.1 MODBUS GATEWAY .....	6 - 1
6.1.1 Overview of the Modbus gateway .....	6 - 1
6.1.1.1 MAIN FEATURES .....	6 - 1
6.1.1.2 FUNCTIONAL DESCRIPTION .....	6 - 1
6.1.1.3 MODBUS/JBUS FUNCTION CODES SUPPORTED .....	6 - 2
6.1.2 Principles of operation .....	6 - 2
6.1.2.1 REFRESH RATES AND TIMING INFORMATION .....	6 - 3
6.1.2.2 MEMORY USE AND REQUIREMENTS .....	6 - 5
6.1.2.3 DATA CONVERSION .....	6 - 6
6.1.3 Using the diagnostic table .....	6 - 7
6.1.3.1 INTERNAL DIAGNOSTIC REGISTERS .....	6 - 7
6.1.3.2 MODBUS TABLE STATUS AND CONTROL REGISTERS .....	6 - 7
6.1.3.3 SLAVE MODE DIAGNOSTIC TABLE REGISTERS .....	6 - 8
6.1.4 Diagnostic function codes .....	6 - 8
6.1.5 Modbus exception responses .....	6 - 9
6.1.5.1 SLAVE MODE ERROR CODES .....	6 - 9
6.1.6 Notes on Modbus/JBUS implementation .....	6 - 9
6.1.6.1 MODBUS (AEG-MODICON) .....	6 - 9
6.1.6.2 JBUS .....	6 - 10
6.1.6.3 OTHER PRODUCTS .....	6 - 10

## LIST OF CONTENTS (Cont.)

Section	Page
6.1.7 MODBUS/JBUS Interface performance figures .....	6 - 10
6.1.7.1 UPDATE PERIOD .....	6 - 10
6.1.7.2 SERIAL LINK CYCLE TIME .....	6 - 10
6.1.7.3 SCANNING PERIOD AND RESPONSE TIME .....	6 - 10
6.1.7.4 TRANSIT TIME ON SERIAL LINK .....	6 - 10
6.2 MODBUS DCM .....	6 - 11
6.2.1 Introduction .....	6 - 11
6.2.2 DCMs available .....	6 - 11
6.2.2.1 LOOP BLOCKS: .....	6 - 11
6.2.2.2 RAMP BLOCKS .....	6 - 11
6.2.2.3 I/O MODULE BLOCKS .....	6 - 11
6.2.2.4 I/O CHANNEL BLOCKS .....	6 - 12
6.2.2.5 USER WIRING BLOCKS .....	6 - 12
6.2.2.6 USER ALARM BLOCKS .....	6 - 12
6.2.2.7 PARAMETER BLOCKS .....	6 - 12
6.2.2.8 INSTRUMENT/DIAGNOSTIC BLOCKS .....	6 - 12
6.2.3 The .UYM File .....	6 - 13
6.2.3.1 EXAMPLE .....	6 - 14
6.2.3.2 SCALING .....	6 - 14
6.2.3.3 COMMENTING .....	6 - 14
<b>Chapter 7 PROFIBUS .....</b>	<b>7 - 1</b>
7.1 INTRODUCTION .....	7 - 1
7.2 DEVOLVED CONTROL MODULES .....	7 - 1
7.2.1 Introduction .....	7 - 1
7.2.2 DCMs available .....	7 - 2
7.2.2.1 LOOP BLOCKS .....	7 - 2
7.2.2.2 RAMP BLOCKS .....	7 - 2
7.2.2.3 I/O MODULE BLOCKS .....	7 - 2
7.2.2.4 I/O CHANNEL BLOCKS* .....	7 - 2
7.2.2.5 USER WIRING BLOCKS .....	7 - 2
7.2.2.6 USER ALARM BLOCKS .....	7 - 2
7.2.2.7 PARAMETER BLOCKS .....	7 - 3
7.2.2.8 INSTRUMENT/DIAGNOSTIC BLOCKS .....	7 - 3
7.3 THE .uyf FILE .....	7 - 3
7.3.1 COMMENTING .....	7 - 4
7.4 INSTALLATION .....	7 - 5
7.4.1 Wiring .....	7 - 5
7.4.1.1 EARTHING THE SHIELD .....	7 - 5
7.4.1.2 NETWORK WIRING .....	7 - 5
7.4.1.3 CABLE TYPE .....	7 - 5
7.4.1.4 MAXIMUM BAUD RATE .....	7 - 5
7.4.2 Adding the unit to the network .....	7 - 8
7.5 TROUBLESHOOTING .....	7 - 8
7.5.1 No communications .....	7 - 8
7.5.2 Intermittent failure to communicate .....	7 - 8
7.5.3 Data format or parameter seems incorrect .....	7 - 8
7.5.4 Communication seems slow .....	7 - 9
7.6 GLOBAL COMMANDS .....	7 - 9
7.7 OPERATION .....	7 - 9
7.7.1 I/O Data transfer limits .....	7 - 9
7.7.2 Data format .....	7 - 10
7.8 GSD Files .....	7 - 10
7.8.1 Specific keywords .....	7 - 10

## LIST OF CONTENTS (Cont.)

Section	Page
<b>Chapter 8: ADMINISTRATIVE FUNCTIONS</b> .....	<b>8 - 1</b>
8.1 NETWORK AUDIT TRAIL .....	8 - 1
8.1.1 Modes .....	8 - 2
8.1.2 CONFIGURATION (PROVIDER) .....	8 - 2
CONSUMER SELECTION .....	8 - 2
AUDIT TRAIL FILTERING .....	8 - 2
PARAMETERS .....	8 - 2
8.1.3 User ID control .....	8 - 3
SECURITY ACCESS DISPLAY PAGE .....	8 - 3
EXPIRES .....	8 - 5
SCREEN KEYS .....	8 - 5
8.2 ELECTRONIC SIGNATURES .....	8 - 10
8.2.1 Enabling electronic signatures .....	8 - 10
8.2.2 Signature Configuration .....	8 - 11
ACCESS LEVELS .....	8 - 11
<b>Chapter 9: REMOTE ACCESS</b> .....	<b>9 - 1</b>
9.1 FTP .....	9 - 1
9.1.1 FTP logon .....	9 - 1
TIMEOUT .....	9 - 1
9.1.2 File system .....	9 - 1
9.1.3 Archive File Transfer .....	9 - 1
<b>Chapter 10: PREVENTIVE MAINTENANCE</b> .....	<b>10 - 1</b>
10.1 LARGE FRAME FAN/BATTERY REPLACEMENT .....	10 - 1
10.1.1 Fan replacement .....	10 - 2
10.1.2 Battery replacement .....	10 - 3
10.2 SMALL FRAME FAN/BATTERY REPLACEMENT .....	10 - 3
10.2.1 Fan replacement .....	10 - 4
10.2.2 Battery replacement .....	10 - 4
10.3 BATTERY REPLACEMENT (OLDER UNITS) .....	10 - 5
10.4 TOUCH SCREEN CALIBRATION .....	10 - 6
<b>Appendix A: TECHNICAL SPECIFICATION</b> .....	<b>A - 1</b>
GENERAL SPECIFICATION .....	A - 1
COMMUNICATIONS SPECIFICATION .....	A - 3
FUNCTION BLOCKS SUPPORTED .....	A - 4
<b>Appendix B: ORDERING INFORMATION</b> .....	<b>B - 1</b>
<b>Appendix C: REFERENCE</b> .....	<b>C - 1</b>
C1 ASCII CODES .....	C - 1
C2 GLOSSARY .....	C - 2
C3 COSHH Statement .....	C - 4
C3.1 LITHIUM-THIONYL CHLORIDE BATTERY CELLS .....	C - 4
<b>Index</b> .....	<b>i - 1</b>

---

**SAFETY NOTES**

---

**WARNING**

Any interruption of the protective conductor inside or outside the apparatus, or disconnection of the protective earth terminal is likely to make the apparatus dangerous under some fault conditions. Intentional interruption is prohibited.

---

**CAUTION**

For direct current (dc) supply units, local lightning protection must be fitted if the dc power supply unit is located more than 30 metres from the visual supervisor(s) it is supplying.

---

Note: in order to comply with the requirements of safety standard BS EN61010, the equipment shall have one of the following as a disconnecting device, fitted within easy reach of the operator, and labelled as the disconnecting device:





- a. A switch or circuit breaker which complies with the requirements of IEC947-1 and IEC947-3
  - b. A separable coupler which can be disconnected without the use of a tool
  - c. A separable plug, without a locking device, to mate with a socket outlet in the building.
- 

1. Before any other connection is made, the protective earth terminal shall be connected to a protective conductor. The supply voltage cable must be terminated in such a way that, should it slip, or be pulled out, the Earth wire would be the last wire to become disconnected.
2. For high voltage units, the supply fuse within the power supply is not replaceable. If it is suspected that the fuse is faulty, the manufacturer's local service centre should be contacted for advice. Instructions for replacing the fuse for low voltage, dc supply, units are given in [section 1.3.6.3](#), below.
3. Whenever it is likely that safety earth protection has been impaired, the unit shall be made inoperative, and secured against accidental operation. The manufacturer's nearest service centre should be contacted for advice.
4. Any adjustment, maintenance and repair of the opened apparatus under voltage, should be avoided as far as possible and, if inevitable, shall be carried out only by a skilled person who is aware of the hazard involved.
5. Where conductive pollution (e.g. condensation, carbon dust) is likely, adequate air conditioning/filtering/sealing etc. must be installed in the equipment enclosure.
6. Signal and supply voltage wiring should be kept separate from one another. Where this is impractical, shielded cables should be used for the signal wiring.
7. The equipment is designed for process monitoring and supervision in an indoor environment. If the equipment is used in a manner not specified by the manufacturer, the protection provided by the equipment might be impaired.
8. The battery within the unit must not be short circuited. When exhausted, the battery must be disposed of in accordance with local regulations for lithium thionyl-chloride (Li-SOCI<sub>2</sub>) cells.
9. When connecting a USB device, it must be plugged directly into the visual supervisor. The use of extension USB leads may compromise the unit's ESD compliance.
10. There are no specific insulation requirements for external circuitry.

\* A full definition of 'Hazardous' voltages appears under 'Hazardous live' in BS EN61010. Briefly, under normal operating conditions, hazardous voltages are defined as being > 30V RMS (42.2V peak) or > 60V dc.

**SYMBOLS USED ON THE EQUIPMENT LABELLING**

One or more of the symbols below may appear as a part of the unit's labelling.

	Refer to the manual for instructions
	Protective earth
	This instrument for ac supply only
	This instrument for dc supply only
	Risk of electric shock

**PREVENTIVE MAINTENANCE**

Details of preventive maintenance procedures are given in chapter 10 of this manual.



## CHAPTER 1: INSTALLATION

This chapter is intended for use by those responsible for the installation and commissioning of the instrument and consists of the following sections:

- 1.1 Unpacking
- 1.2 [Mechanical installation](#)
- 1.3 [Electrical installation](#)
- 1.4 [Setting up Communications](#)
- 1.5 [Getting first access](#)
- 1.6 [Setting the clock.](#)
- 1.7 [Manual self-tests](#)

### 1.1 UNPACKING

The unit is despatched in a special pack designed to protect it during transit.

If the outer box of the pack shows signs of damage, please open it immediately and examine the instrument. If there is evidence of damage, contact the manufacturer's local representative for instructions. Do not operate the instrument in the meantime.

If the outer box is not damaged, remove the instrument from its packing with all accessories and documentation. Once the unit has been installed, store any internal packing with the external packing in case of future despatch.

---

Note: For large frame units manufactured prior to mid-June 2002, the information given for small frame units applies.

---

## 1.2 MECHANICAL INSTALLATION

### 1.2.1 Current units

1. Check that the mounting panel is no thicker than 25mm (typically for wood or plastic) and no thinner than 2mm (for steel), and that it meets the maximum panel mounting angle figure given in figure 1.2a/1.2b.
2. In the panel, cut an aperture 138mm x 138mm (small frame) or 281mm x 281mm (large frame). If more than one instrument is to be mounted in the panel, the recommended minimum spacings are as shown in figure 1.2a/1.2b.
3. From the front side of the mounting panel, insert the instrument (rear end first) through the aperture.
4. Support the rear of the instrument so that the seal is flat against the front of the panel.
5. For installations that will not be subject to vibration, insert two panel clamps into any opposing pair of the four groups of rectangular apertures at the sides of the case (either the top and bottom pair, or the left and right pair). For installations subject to vibration (often referred to as 'seismic' versions), use both pairs — that is, four clamps.
6. Tighten the screws of the clamps sufficiently to hold the unit firmly in position. *IMPORTANT:* Do not use excessive force to tighten the screws. It could distort the case and render the instrument inoperative.

### 1.2.2 Large-frame units (pre mid-June 2002)

---

**Caution**

**The nuts mentioned in step 3 are essential. If they are not fitted, the display screen will be damaged.**

---

1. Check that the mounting panel is no thicker than 25mm (typically for wood or plastic) and no thinner than 2mm (for steel), and that it meets the maximum panel mounting angle figure given in figure 1.2a.
2. In the panel, cut an aperture 281mm x 281mm. If more than one instrument is to be mounted in the panel, the recommended minimum spacings are as shown in figure 1.2c
3. Loosely fix the four clamps to their mounting spigots, ensuring a nut is located between each screw head and its clamp (figure 1.2c). Ensure that none of the clamps protrudes 'outside' the instrument bezel. Insert the studs (with locking nuts) provided into the clamps (if this has not already been done).
4. Insert the unit into the aperture from the front of the panel, using the four mounting guides to centre it.
5. Rotate the clamps to (approximately) the positions shown in figure 1.2c, and fully tighten the clamp securing screws.
6. Secure the instrument to the panel by tightening the studs. Once the unit is secure, tighten the locking nuts to retain the studs.

1.2 MECHANICAL INSTALLATION (Cont.)

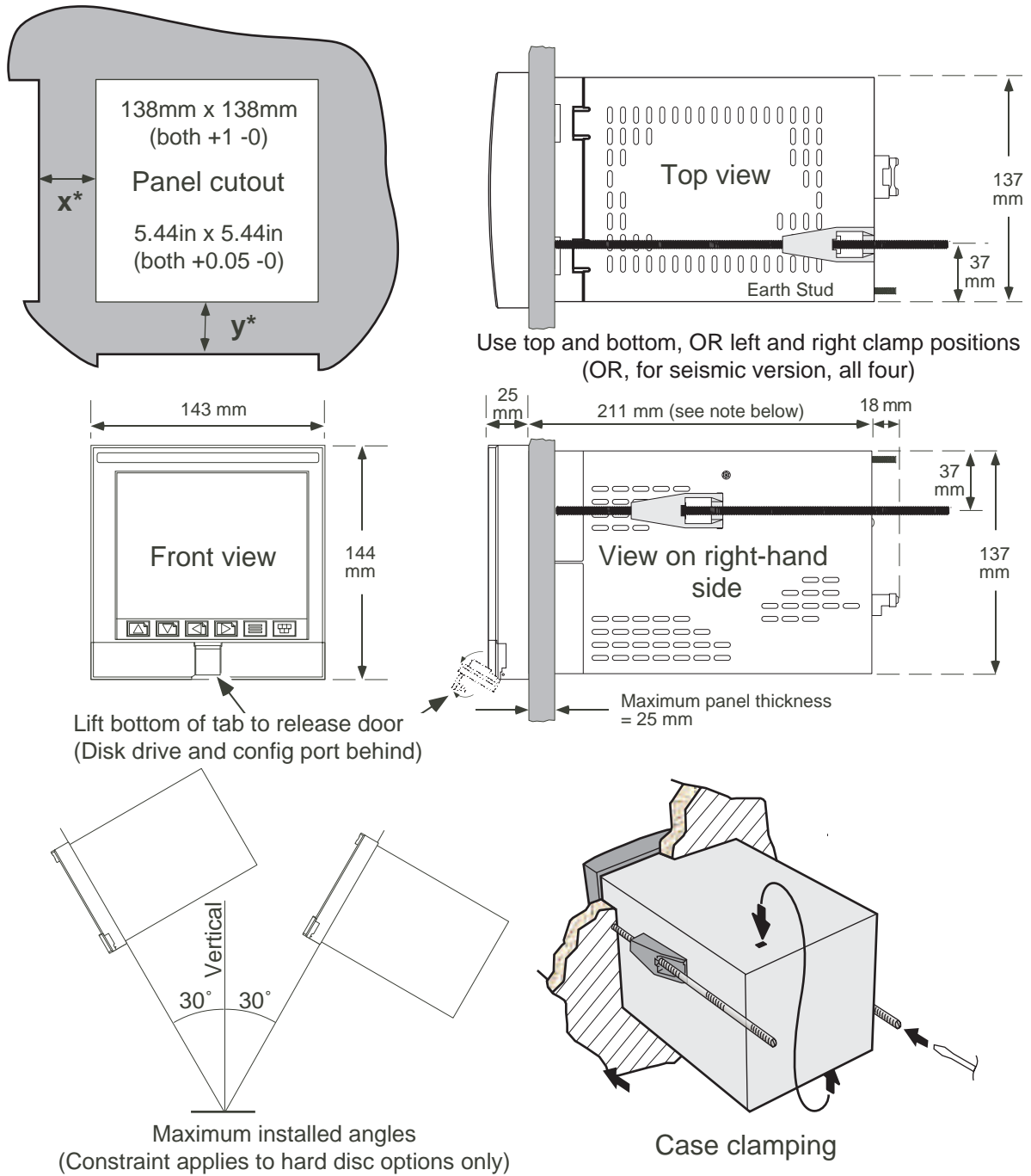

Lift bottom of tab to release door  
(Disk drive and config port behind)

Maximum installed angles  
(Constraint applies to hard disc options only)

Case clamping

Minimum recommended inter-unit spacing		
Clamp position	x*	y*
Top and bottom	7.5 mm	14 mm
Left and right	14 mm	7.5 mm

Figure 1.2a Small-frame unit mechanical installation

Note: 211mm dimension was 187mm for units with status levels prior to Q36.

1.2 MECHANICAL INSTALLATION (Cont.)

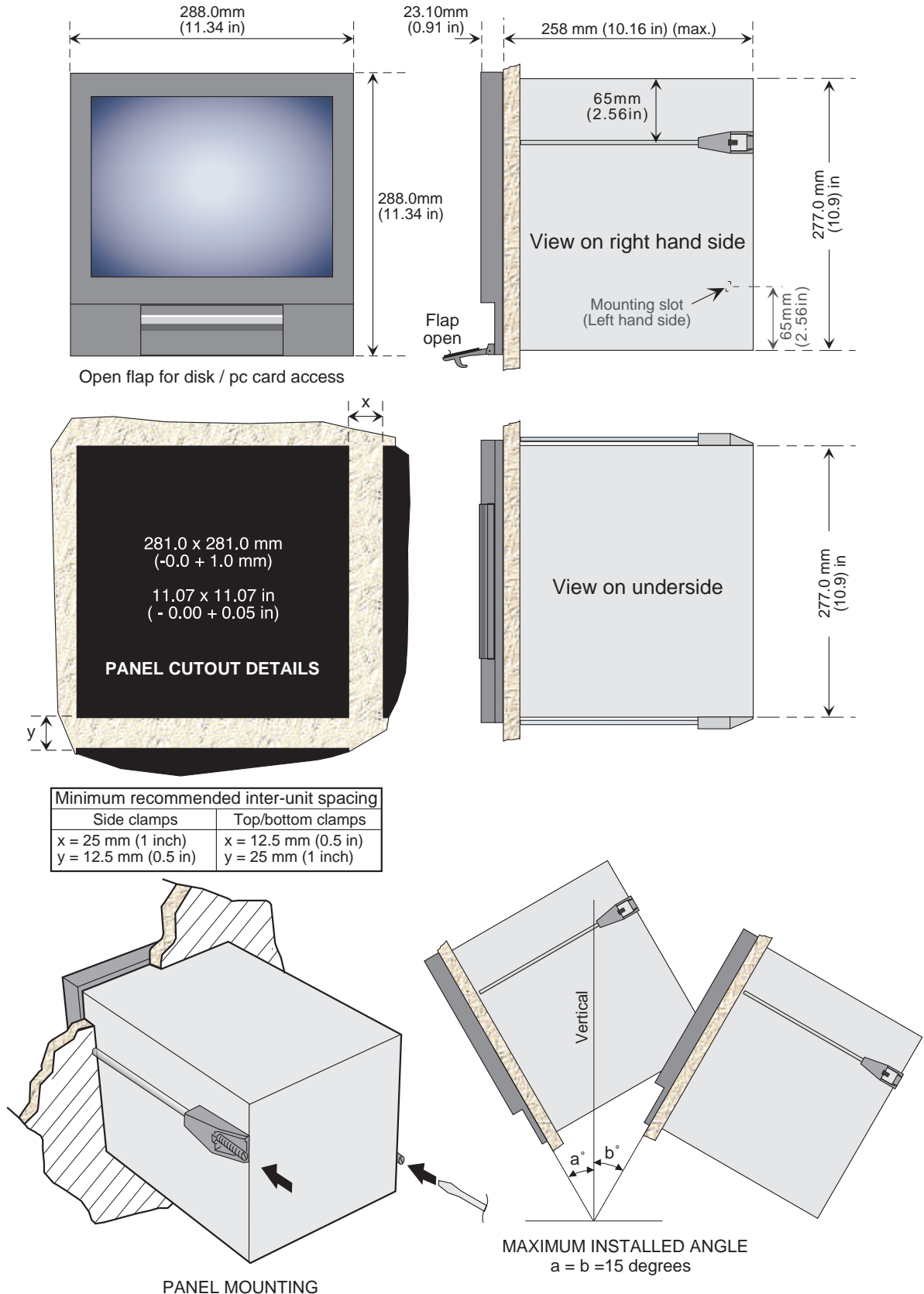

Figure 1.2b Large-frame unit mechanical installation - current design

1.2 MECHANICAL INSTALLATION (Cont.)

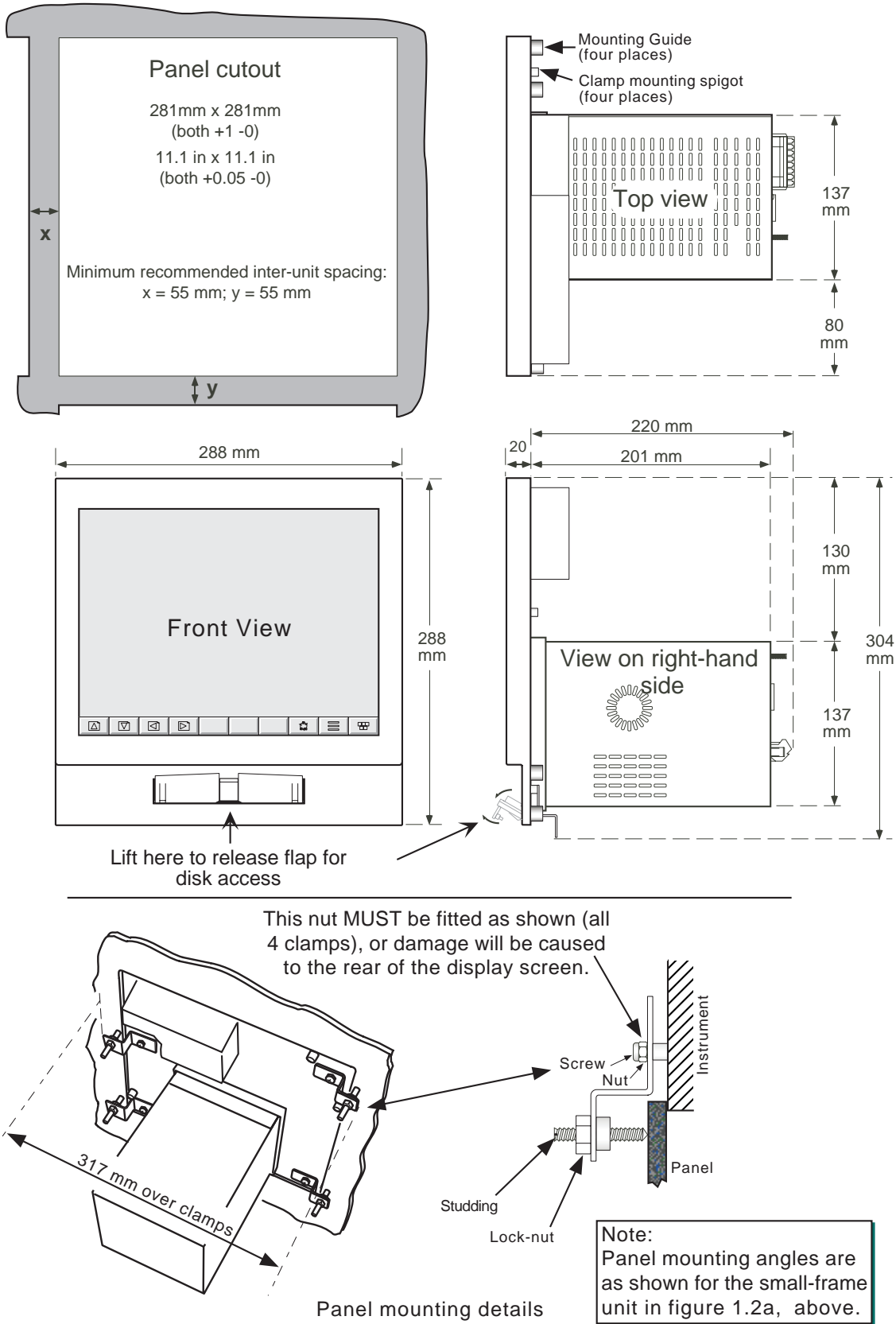

Figure 1.2c Large-frame unit mechanical installation (pre mid-June 2002)

### 1.3 ELECTRICAL INSTALLATION

Note: Before carrying out any wiring, please read the Safety Notes preceding this chapter.

This section consists of:

- 1.3.1 Rear panel layout and connector pinouts
- 1.3.2 Operational signal cabling
- 1.3.3 Configuration signal cabling
- 1.3.4 Cabling from a Visual Supervisor to a controlling PC running SCADA
- 1.3.5 Cable schedule.
- 1.3.6 Supply voltage wiring

Note: For large frame units manufactured prior to mid-June 2002, the information given for small frame units applies.

#### 1.3.1 Rear panel layout and connector pinouts

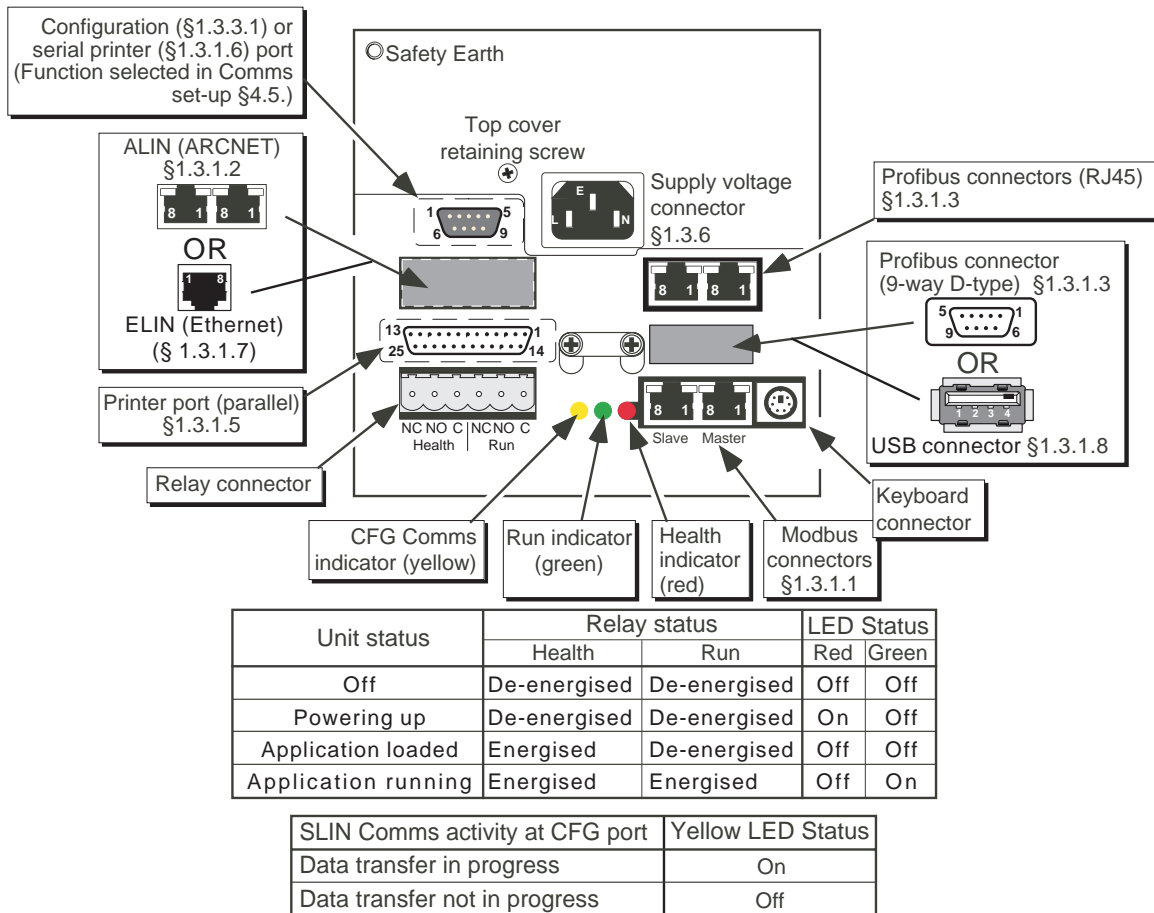
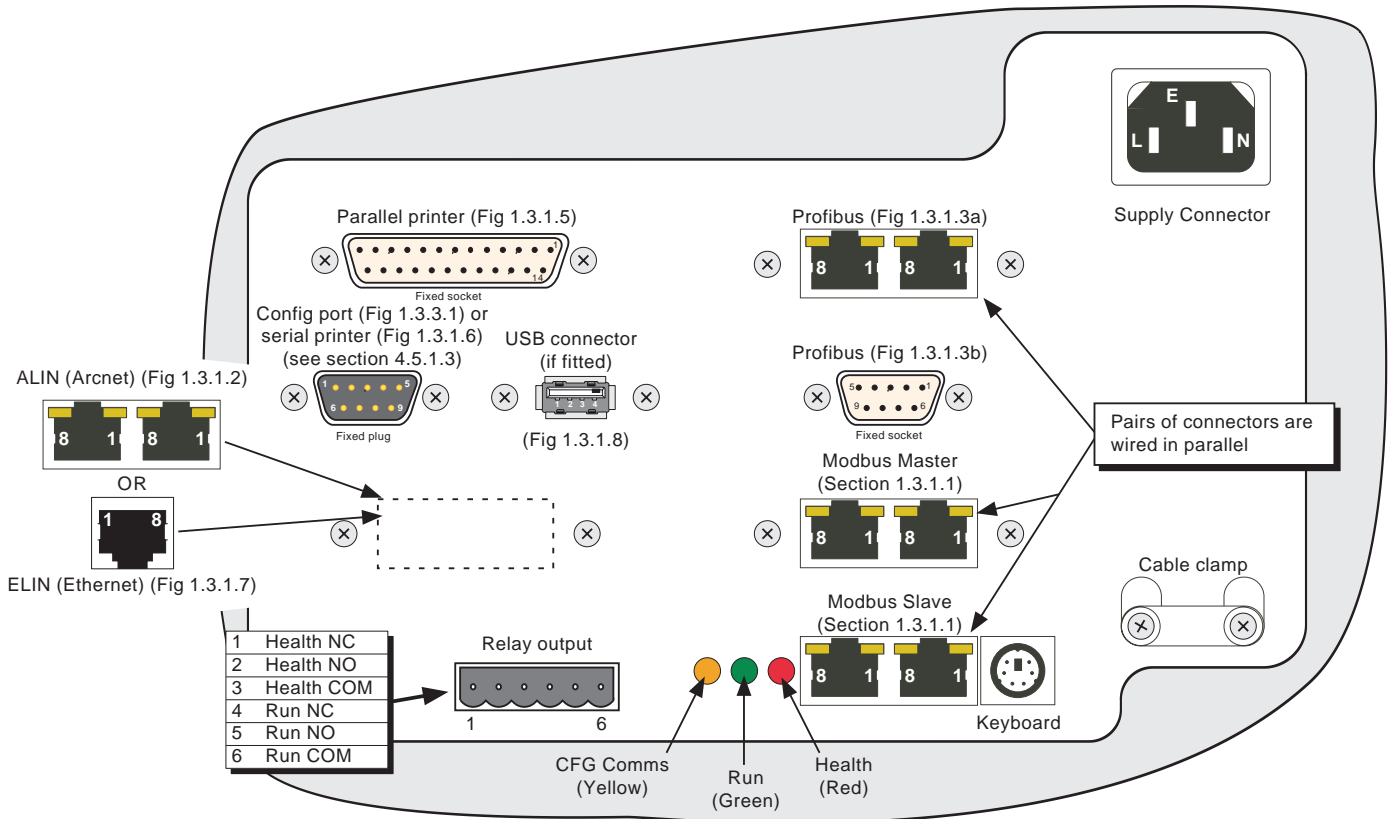

Figure 1.3.1a Rear panel details (small frame units)

#### Caution

When connecting the power cable, ensure that it is properly secured in the cable clamp, leaving a loop only just long enough to permit the connector to mate at 90 degrees to the rear panel. If the loop is too short, the connector may not mate correctly, leading to early failure. If too much cable is left in the loop, or if the loop is left unclamped the connector can be disconnected accidentally. In either case loss of any associated process control will ensue.

1.3.1 REAR PANEL LAYOUT AND CONNECTOR PINOUTS (Cont.)



Unit status	Relay status		LED Status	
	Health	Run	Red	Green
Off	De-energised	De-energised	Off	Off
Powering up	De-energised	De-energised	On	Off
Application loaded	Energised	De-energised	Off	Off
Application running	Energised	Energised	Off	On

SLIN Comms activity at CFG port	Yellow LED Status
Data transfer in progress	On
Data transfer not in progress	Off

Figure 1.3.1b Rear panel details (large frame units)

**Caution**

When connecting the power cable, ensure that it is properly secured in the cable clamp, leaving a loop only just long enough to permit the connector to mate at 90 degrees to the rear panel. If the loop is too short, the connector may not mate correctly, leading to early failure. If too much cable is left in the loop, or if the loop is left unclamped the connector can be disconnected accidentally. In either case loss of any associated process control will ensue.

1.3.1.1 MASTER/SLAVE COMMS SOCKETS

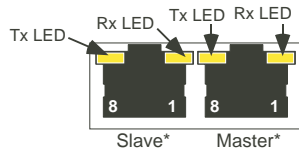

\*Note: Master/Slave designation applies only to small frame units. Large frame units have separate pairs of master and slave connectors.

MASTER SOCKET PIN OUT			
Pin	EIA422	EIA485	Core colour
1	Rx -	Data -	White/Orange
2	Rx +	Data +	Orange
3	0 volts	0 volts	White/Green
4	Not used	Not used	Blue
5	Not used	Not used	White/Blue
6	0 Volts	0 Volts	Green
7	Tx -	Not used	White/Brown
8	Tx +	Not used	Brown

SLAVE SOCKET PIN OUT			
Pin	EIA422	EIA485	Core colour
1	Tx -	Data -	White/Orange
2	Tx +	Data +	Orange
3	0 volts	0 volts	White/Green
4	Not used	Not used	Blue
5	Not used	Not used	White/Blue
6	0 Volts	0 Volts	Green
7	Rx -	Not used	White/Brown
8	Rx +	Not used	Brown

Shroud/screen, connected to the unit safety earth

Figure 1.3.1.1 Master and Slave Comms connector pinouts

Notes:

1. Core colours vary from cable manufacturer to cable manufacturer, so those listed above might not apply to your particular cable. Where doubt exists the pin numbers and associated signal names in figure 1.3.1.1 should be regarded as definitive.
2. Connectors labelled 'Master' may be user configured as slaves, and connectors labelled 'Slave' may be configured by the user as masters. In either case, the pinouts remain unaltered from those shown above which refer to Masters and Slaves, as labelled.



### 1.3.1.2 ALIN (ARCNET) SOCKETS

To facilitate the 'daisy-chaining' of instruments, these sockets (located as shown in [figure 1.3.1a/b above](#)), are wired in parallel with each another. Figure 1.3.1.2, below, shows the pinouts for these connectors.

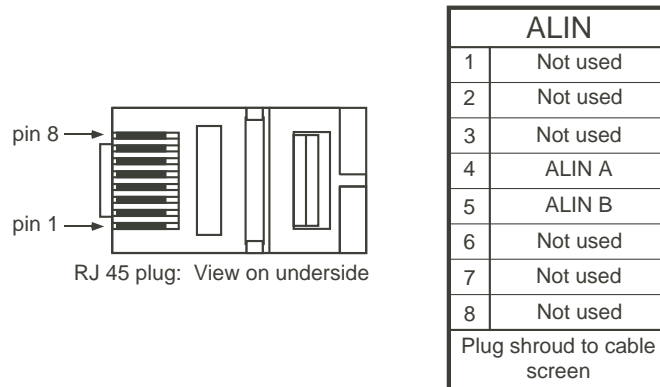

Figure 1.3.1.2 ALIN Pinout

### 1.3.1.3 PROFIBUS CONNECTORS

#### RJ45 CONNECTORS

To facilitate the 'daisy-chaining' of instruments, these sockets (located as shown in [figure 1.3.1a/b above](#)), are wired in parallel with each other. Figure 1.3.1.3a, below, shows the pinouts for these connectors.

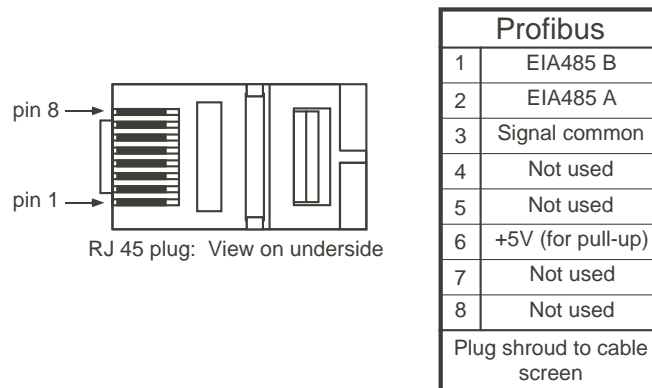

Figure 1.3.1.3a Profibus pinout (RJ45)

#### D-TYPE CONNECTOR

A single 9-way D-type socket can be fitted instead of the pair of RJ45 connectors. Figure 1.3.1.3b shows the pinout for the mating plug.

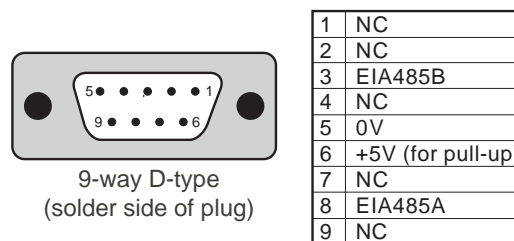

Figure 1.3.1.3b Profibus pinout (9-way D-type)

Note: A document "Installation Guidelines for Profibus Networks" (HA261788) is available from the Manufacturer to help those using Category 5 cable in a Profibus installation,

### 1.3.1.4 BAR CODE READER/CREDIT CARD SCANNER

These items are connected to the unit using the Keyboard (KBD) connector at the rear of the unit (figure 1.3.1a/b above).

### 1.3.1.5 PARALLEL PRINTER PORT

A parallel printer port can be provided at the rear panel of the instrument as shown in figure 1.3.1a/b above. Figure 1.3.1.5 shows the pinout for the mating plug.

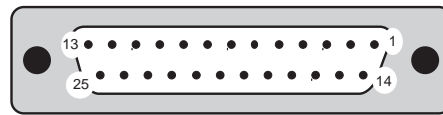

25-way D-type  
(Solder side of plug)

1	Strobe	14	Auto Feed
2	DB0	15	Error / Fault
3	DB1	16	Printer initialisation
4	DB2	17	Select
5	DB3	18	Ground
6	DB4	19	Ground
7	DB5	20	Ground
8	DB6	21	Ground
9	DB7	22	Ground
10	Acknowledge	23	Ground
11	Busy	24	Ground
12	Paper end	25	Ground
13	Select		

Figure 1.3.1.5 Pinout for parallel printer port

### 1.3.1.6 SERIAL PRINTER PORT

A serial printer port can be provided at the rear panel of the instrument as shown in figure 1.3.1a/b above. Figure 1.3.1.6 shows the pinout for the mating socket.

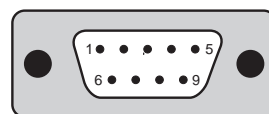

9-way D-type  
(solder side of socket)

1	DCD
2	RXD
3	TXD
4	DTR
5	0V
6	DSR
7	RTS
8	CTS
9	RI

Figure 1.3.1.6 Pinout for serial printer port

### 1.3.1.7 ETHERNET (100/10 Base-T) CONNECTOR

If the Ethernet option has been specified, a single RJ45 connector replaces the ALIN connector pair. The pinout is as shown in figure 1.3.1.7, below.

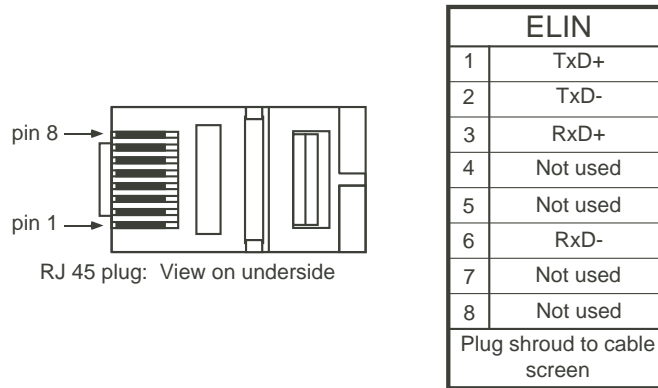

Figure 1.3.1.7 Ethernet (ELIN) connector pinout.

### 1.3.1.8 USB CONNECTOR

A single USB connector may be fitted at the rear panel. This may be used only for the connection of USB Bulk storage devices ('memory sticks'). The connector pinout is given below, in figure 1.3.1.8.

**Note:** Compliance with EMC directives cannot be guaranteed if the Bulk Storage Device is connected using an extension cable.

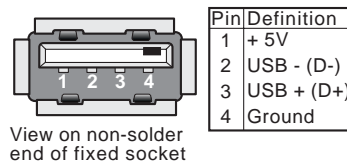

Figure 1.3.1.8 USB connector pinout

## 1.3.2 Signal wiring, visual supervisor to 2500 I/O units

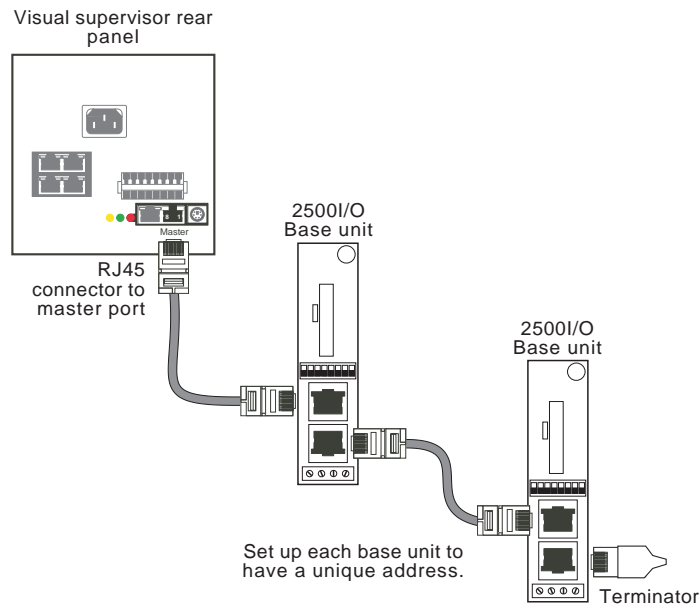

Figure 1.3.2. Visual Supervisors to 2500 wiring

### CONNECTORS AND CABLES

All connectors are RJ45. For a fixed, permanent installation, cables should be a low-loss type (Eurotherm part no. S9508-5/2RJ45/xxx/- , where xxx is the length in metres, with an implicit decimal point as in 'xx.x', and a maximum of 99.9 metres). For a temporary set-up, cables can be general purpose types. See 1.3.5. [Cable schedule](#) for details. Pin-out details for the cable and connector going into the slave Comms port on the 2500 are given in the 2500 User Manual.

## 1.3.3 Signal wiring: Configuration port

### 1.3.3.1 VISUAL SUPERVISOR TO CONFIGURATION PC

The configuration port is located behind the cover flap on the front panel, below the screen (figures 1.2a, 1.2b, 1.2c).

To open the flap and reveal the port, pull the bottom of the centre tab towards you.

It will click open, allowing you to open the flap downward from the top.

To close the flap, push it up, hook the top of the tab behind the lip of the casing, and push the bottom of the tab shut.

The cable schedule for these runs constitutes [section 1.3.5](#).

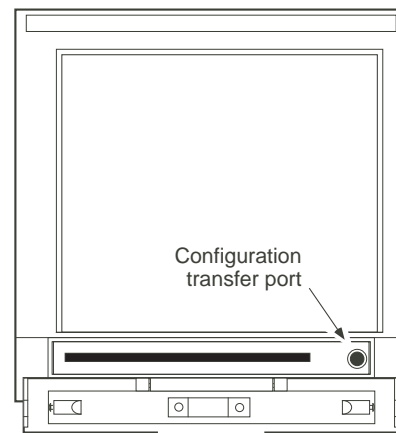

Fig 1.3.3.1a Configuration Transfer port location (Small frame unit shown - large frame units are similar)

1.3.3.1 VISUAL SUPERVISOR TO CONFIGURATION PC (Cont.)

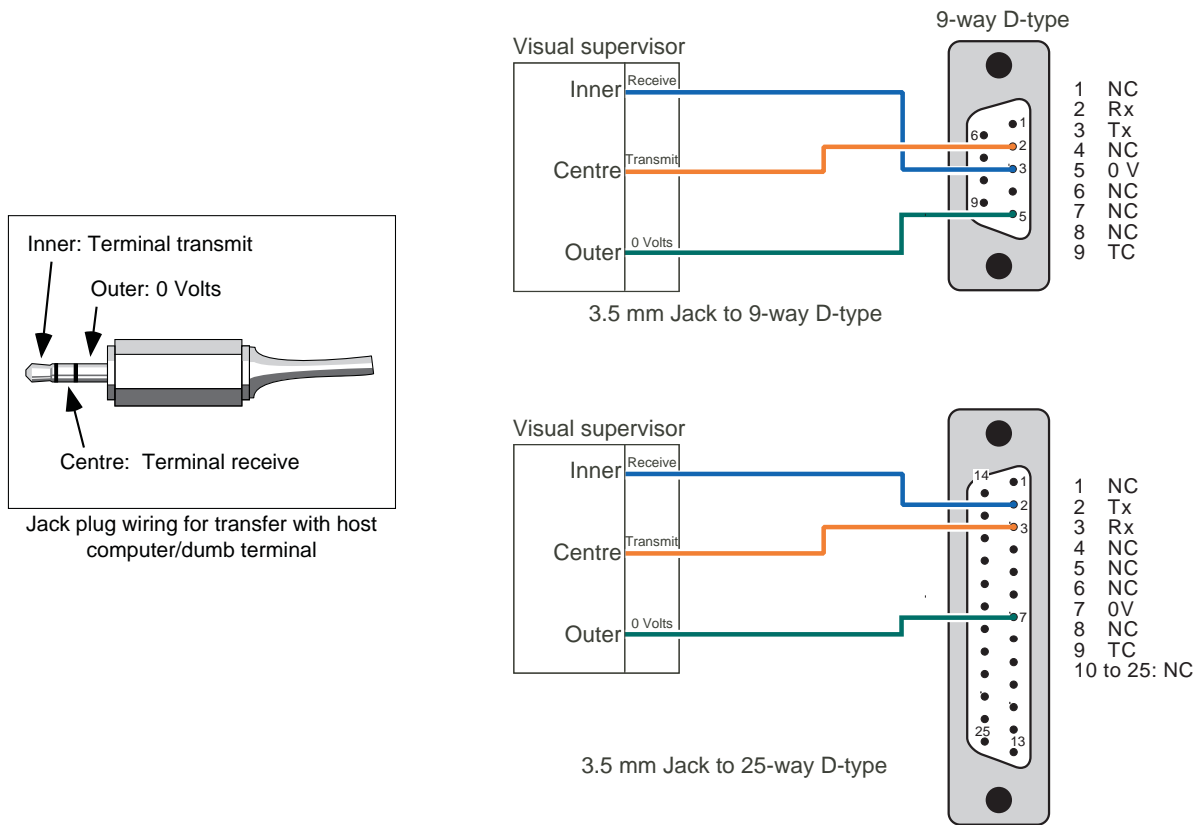

Fig 1.3.3.1b: 3.5mm jack plug to D-type socket (Visual Supervisor to PC)

As an alternative to the jack socket connection at the front of the instrument, a nine-way D-type plug can be fitted as shown in figure 1.3.1a/b above. The pinout for the mating socket is shown in figure 1.3.3.1c, below.

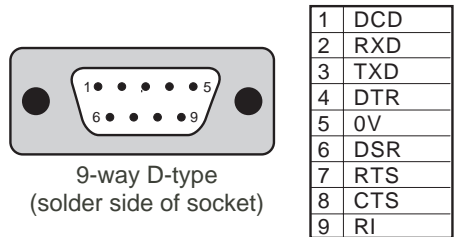

Figure 1.3.3.1c Pin out for rear panel configuration connector.

### 1.3.3.2 2500 TO PC RUNNING iTOOLS

The cable schedule for these runs constitutes [section 1.3.5](#).

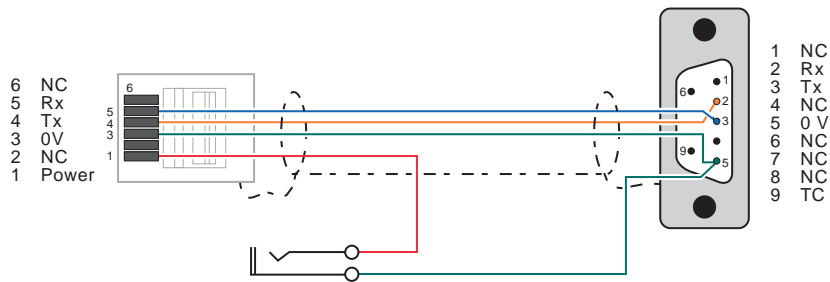

Figure 1.3.3.2a: RJ11 to 9-pin D-type socket (2500 to PC):

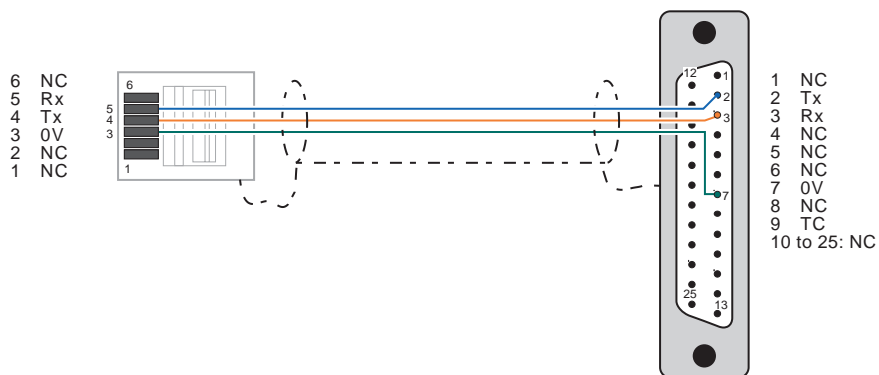

Fig 1.3.3.2b: RJ11 to 25-pin D-type socket (2500 to PC):

### 1.3.3.3 2500 TO PC RUNNING iTOOLS, VIA TALKTHROUGH

Refer to Chapter 4, section 4.5.1

### 1.3.4 Permanent link to a PC running SCADA

To be issued later

### 1.3.5 Cable schedule

For an operational system:

Figure No	Cable Run	Part Numbers
1.3.2	Modbus I/O Network Visual Supervisor to 2500 and 2500 to 2500	Low loss fixed installation: S9508-5/2RJ45/xxx/- where xxx =length  General purpose: AMP557827-2 4 feet AMP557827-4 8 feet AMP557827-5 12 feet VIDEK 8961-1 1 metre VIDEK 8961-2 2 metre VIDEK 8961-10 10 metre

For a system under configuration:

Figure No	Visual supervisor	PC	Part Numbers
1.3.3.1b	3.5mm Jack (Configuration port)	9-way D-type socket	DN247979
	3.5mm Jack (Configuration port)	25-way D-type socket	To be issued later

Figure No	2500 I/O	PC	Part Numbers
1.3.3.2a	RJ11 config port	9-way D-type socket	DN026484
1.3.3.2b	RJ11 config port	25-way D-type socket	To be issued later

## 1.3.6 Supply voltage wiring

### 1.3.6.1 AC SUPPLY

As detailed in the 'Important information' leaflet (HA261376U007) supplied with the instrument, the suitable supply voltage range for the unit is 85 to 246 V ac. It is recommended that an external fuse (3 Amp type T) be fitted in the line.

The power cord is terminated using an IEC socket to mate with the plug fitted at the rear of the instrument as shown in figure 1.3.6.1, below.

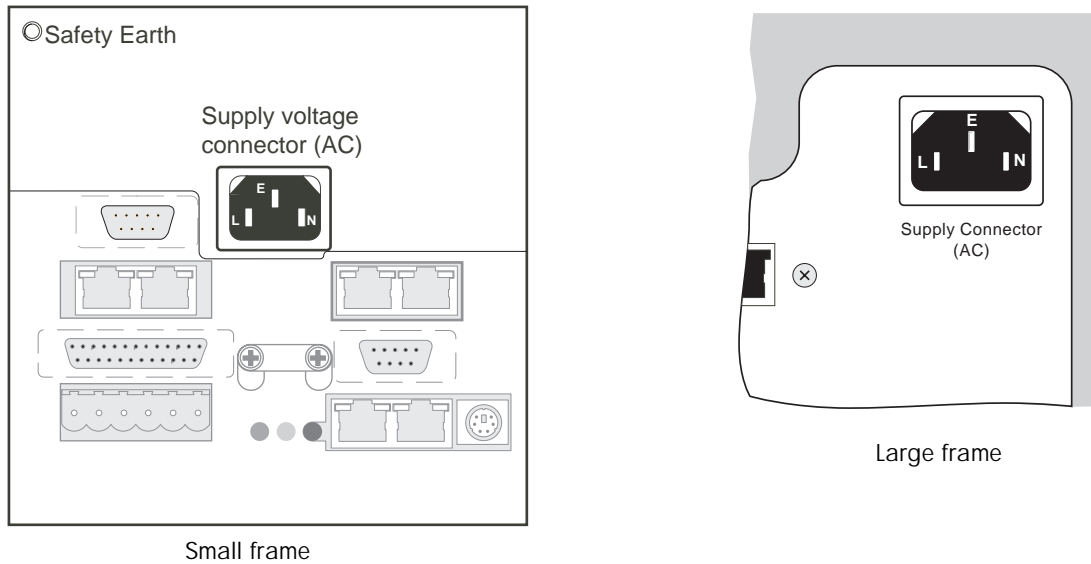

Figure 1.3.6.1 AC supply connector (not drawn to the same scale)



### 1.3.6.2 DC SUPPLY

DC power is applied to one or both connectors at the rear of the instrument (figure 1.3.6.2). The instrument draws current from whichever supply has the higher voltage. When the two supplies are within  $\pm 0.7$  Volts of one another, current is drawn from both supplies.

#### Warning

Voltages of greater than 50V (peak), relative to the safety earth potential, must never be applied to any of the dc input terminals (positive or negative), as under such circumstances, the unit may become hazardous to the touch.

Note: In order to ensure compliance with EMC directives, local lightning protection must be fitted if the dc power supply unit is located more than 30 metres away from the Visual Supervisor(s) it is supplying.

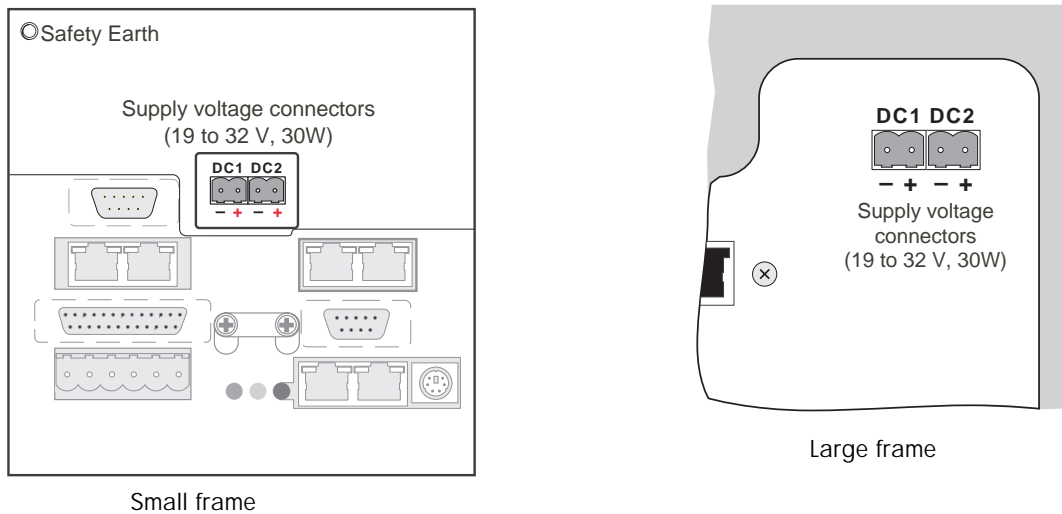

Figure 1.3.6.2a DC supply connector locations (not drawn to the same scale)

It is recommended that external 2 Amp fuses are fitted in each positive supply line, as indicated in figure 1.3.6.2b, below.

Note: It is not recommended that a single dc supply source is connected to both connectors

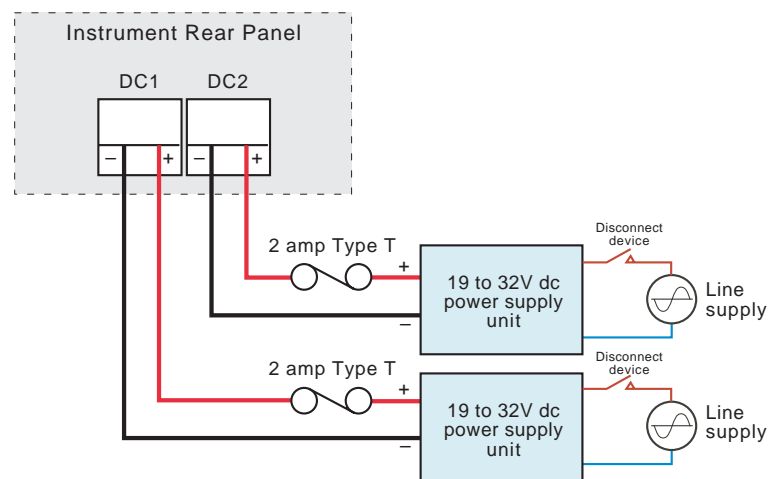

Figure 1.3.6.2b suggested dc supply fusing

### 1.3.6.3 FUSE REPLACEMENT (small frame units)

#### Warning

As hazardous voltages are generated by the power supply board, the internal fuse may be replaced only with the supply voltage isolated, and by trained personnel who are aware of the potential hazard.

Note: This procedure refers to low voltage, dc supply units only. For high voltage units, it is not recommended that the fuse be replaced by the user. The instrument manufacturer or the local agent or service centre should be contacted for advice. See Appendix A for supply voltage definitions.

1. Isolate the instrument from supply power
2. Remove the top cover of the unit by undoing the retaining screws and lifting the cover off as indicated below. The figures below show different versions of the small frame unit. Retain all fixings for use in re-assembly. For current instruments, screws A are Torx T8 screws. Some previous versions used cross-head screws.
3. Replace the fuse (Part Number CH280252), located on the PSU board as shown in figure 1.3.6.3b
4. Re-fit the top cover.

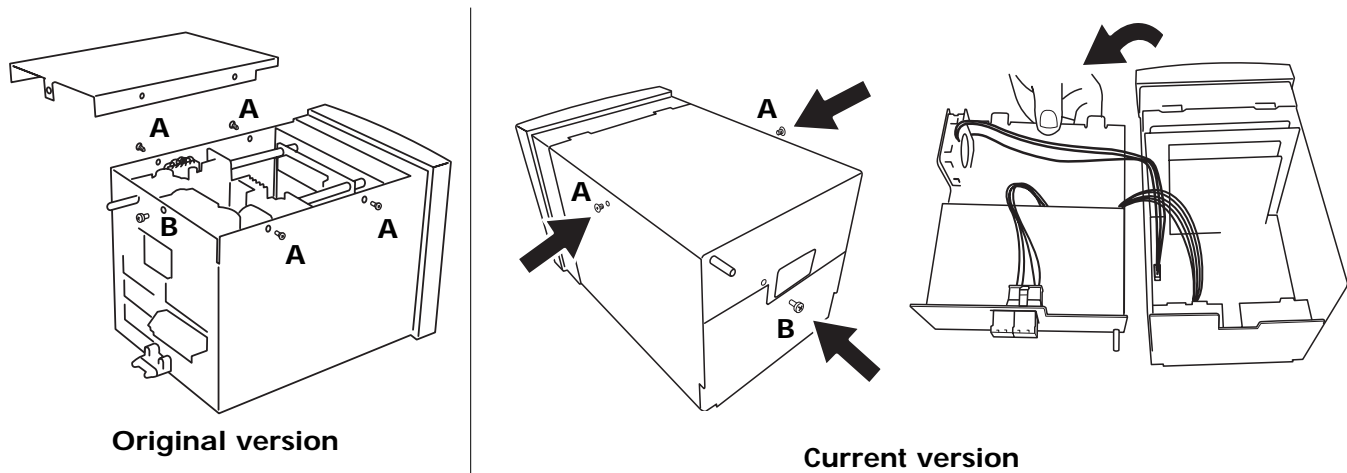

Figure 1.3.6.3a Top cover removal

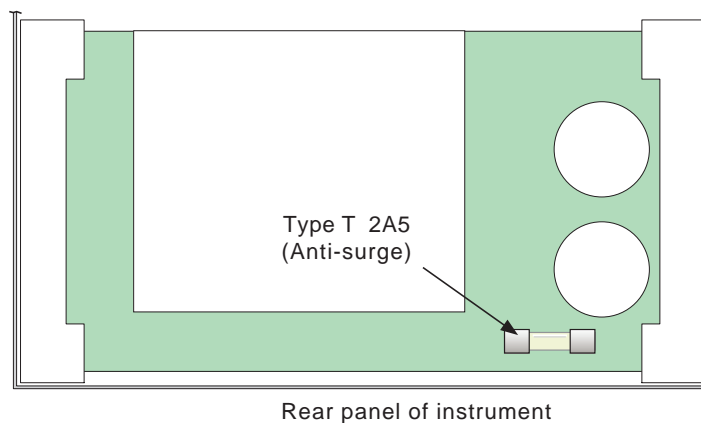

Figure 1.3.6.3b DC Fuse location  
(view on top of the rear part of the instrument)

### 1.3.6.4 FUSE REPLACEMENT (large frame units)

#### Warning

As hazardous voltages are generated by the power supply board, the internal fuse may be replaced only with the supply voltage isolated, and by trained personnel who are aware of the potential hazard.

Note: This procedure refers to low voltage, dc supply units only. For high voltage units, it is not recommended that the fuse be replaced by the user. The instrument manufacturer or the local agent or service centre should be contacted for advice. See Appendix A for supply voltage definitions.

Note: For units manufactured prior to June 2002, follow the instructions for Small frame units in section 1.3.6.3, above

1. Isolate the instrument from supply power.
2. Release the combined top/rear cover by removing the four countersunk screws marked 'A' in figure 1.3.6.4a, and the pan-head screws ('B' and 'C'). All these fixings should be retained for use in re-assembly. For current instruments, screws 'A' are T8 Torx headed screws. Previous versions used cross-head screws. For previous versions, items 'C' were two-part plastic rivets.
3. Once all the fixings have been removed, the cover can be removed by lifting its bottom edge upwards and outwards (figure 1.3.6.4b).
4. As shown in figure 1.3.6.3c, disconnect the harnesses connecting the electronics card cage to the display (the inverter harness, the display flexi-cable and the touch screen flexi cable).
5. As shown in figure 1.3.6.3c, undo the two screws securing the card cage to the chassis.
6. The card cage can now be rotated out of the chassis to reveal the power supply with its fuse (figure 1.3.6.3d).
7. Replace the fuse (Part Number CH280252), located on the PSU board as shown in figure 1.3.6.4d

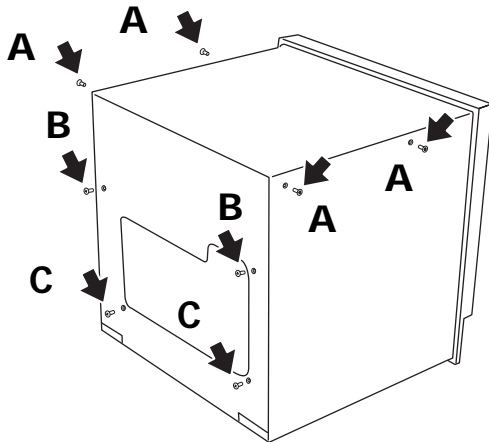

Figure 1.3.6.4a Remove cover fixings

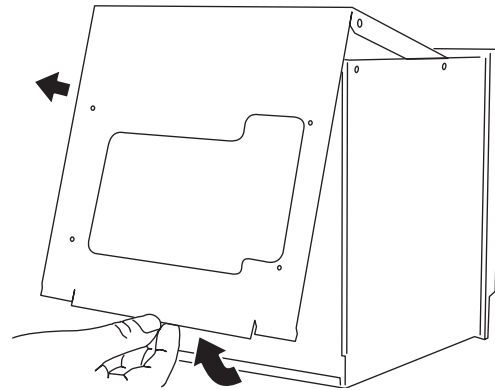

Figure 1.3.6.4b Remove cover

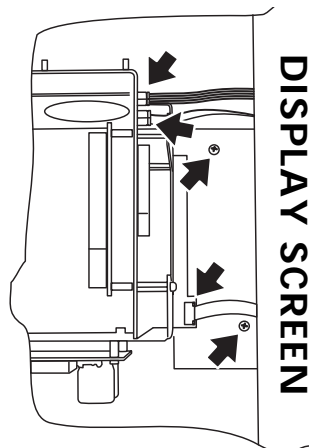

Figure 1.3.6.4c  
Disconnect harnesses; Undo securing screws

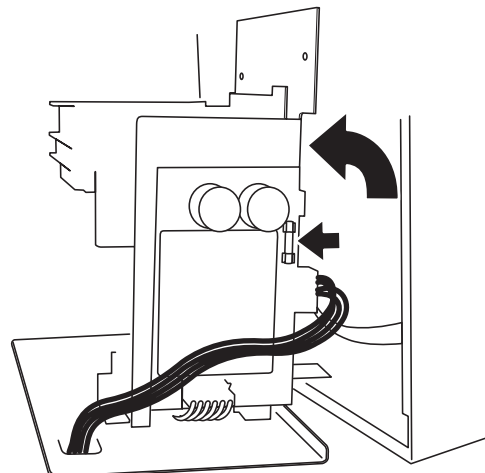

Figure 1.3.6.4d Fuse location

## 1.4 SWITCHING COMMUNICATIONS PARAMETERS

For MODBUS comms only, this section shows how to swap between 5-wire and 3-wire communications. This is accomplished by setting links on the interconnect board within the instrument. Section 4.5.1 details the setting of Communications parameters such as Baud rate, parity etc. All fixings should be retained for use in re-assembly.

### 1.4.1 Small frame units

- 1 Isolate the unit from supply power.

To remove the lid (see figure 1.3.6.3a, above)

- 2 Remove the four screws securing the top cover to the side panels. These may be pozidriv or (for later instruments) Torx T8 headed screws..
- 3 At the top of the rear panel, securing a tab, there is a larger pan-headed Posidriv screw. Unscrew this.
- 4 Lift the lid up and off. The power supply is visible below, at the back.

To release the power supply

- 5 In each side panel, about 4 cm below the rear screw removed at step 3, there are two similar countersunk Posidriv screws. Unscrew these (four screws in all).
- 6 Lift out the power supply, and hang it on the left hand side panel (viewed from the rear of the instrument), taking care not to tension the connecting cables.

To release the relay board

- 7 In the back panel, immediately to each side of the relay connector (viewed from the outside), there are two pan-headed Posidriv screws. Unscrew these.
- 8 In the right-hand side of the relay board (viewed from the rear of the instrument), there is a Posidriv screw that fixes the board to a standoff underneath. Unscrew this.
- 9 Holding the relay board with the tips of your fingers, gently disengage it from the relay connector. This can be awkward, but persist until the relay board is sufficiently disengaged for it to be lifted clear.
- 10 Place the relay board to one side. The interconnect board is visible below, with the jumper sockets just beyond and to each side of the Modbus connector.

To insert the appropriate jumper(s)

- 11 Determine visually, whether figure 1.4.1, or figure 1.4.2 (later instruments) applies.
12. Remove and insert the jumper(s) in accordance with the table associated with the relevant figure.
13. Re-assembly is the reverse of part of the above procedure, steps 9 to 2.
14. Finally, with no application loaded, bring up the Comms Setup page and press the Option menu ‘HARDWARE’ button. In the Comms Setup display, Row 2 will update to show the new configuration.

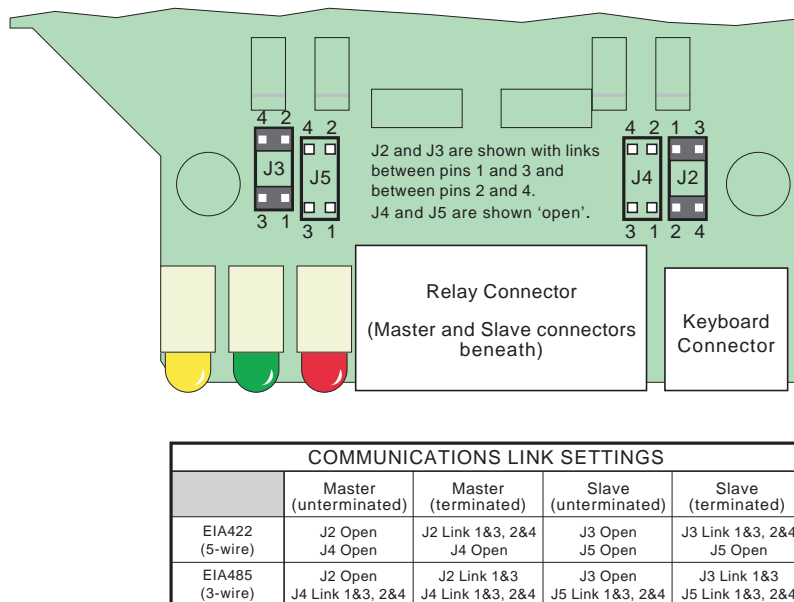

Figure 1.4.1 Location of Comms jumpers on the interconnect board

### 1.4.2 Large frame units

Note: For units manufactured prior to mid June 2002, please follow the instructions given or the small frame unit in section 1.4.1, above. Figure 1.4.1 always applies for these units.

1. Isolate the instrument from supply power.
2. Release the combined top/rear cover by removing the four countersunk screws marked 'A' in figure 1.3.6.4a, and the pan-head screws ('B' and 'C'). All these fixings should be retained for use in re-assembly. For current instruments, screws 'A' are T8 Torx headed screws. Previous versions used cross-head screws. For previous versions, items 'C' were two-part plastic rivets.
3. Once all the fixings have been removed, the cover can be removed by lifting its bottom edge upwards and outwards (figure 1.4.2b).

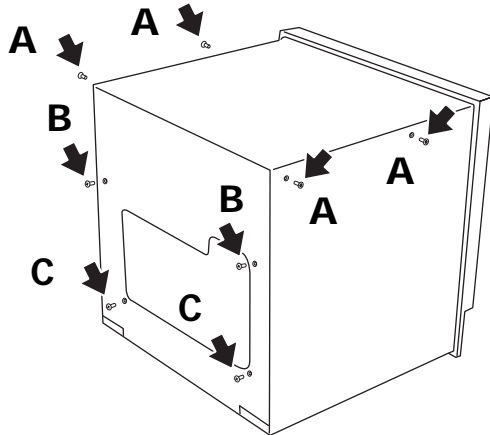

Figure 1.4.2a Remove cover fixings

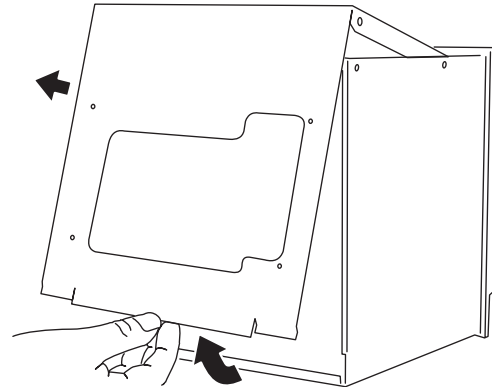

Figure 1.4.2b Remove cover

4. The links are located on the main circuit board (the 'interconnect' board) and are shown in figure 1.4.2b. If Profibus connectors are fitted, it may be convenient to remove these (two screws each) to gain access to the links.
5. Remove and insert the links in accordance with the table in figure 1.4.2b.
6. Re-assemble the unit.
7. Finally, with no application loaded, bring up the Comms Setup page and press the Option menu 'HARDWARE' button. In the Comms Setup display, Row 2 will update to show the new configuration.

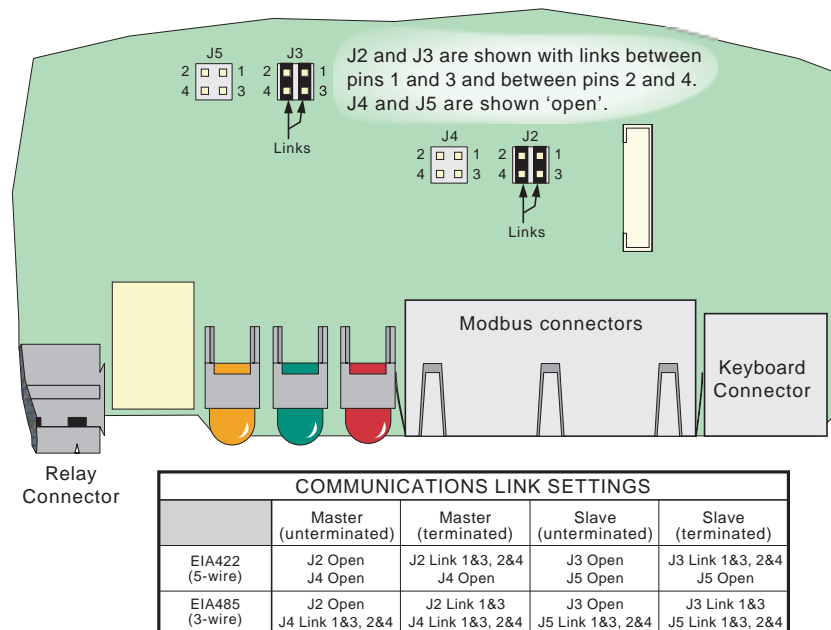

Figure 1.4.2c Link locations

## 1.5 GETTING FIRST ACCESS

### Engineers

Follow the instructions in Section 2.8 Gaining access.

### Commissioning Engineers and Operators

For first-time access, there is no password for Commissioning Engineer level or Operator level. In its place, just press the green Return key below the keypad.

## 1.6 SETTING THE CLOCK

Setting the clock for the first time is the same as re-setting it. Follow the instructions in Chapter 4 Management, section 4.5.3 Re-setting the clock.

## 1.7 MANUAL SELF TESTS

Self test facilities are provided to check the Relay/LED operation and to display the battery status. A reset facility is also available.

---

**Note:** The Self test facilities are available only if all applications have been unloaded. For details of how to unload an application, see Chapter 4 section 4.3

---

With all applications unloaded, the 'TEST' menu is accessed from the main menu as shown in figure 1.7 below.

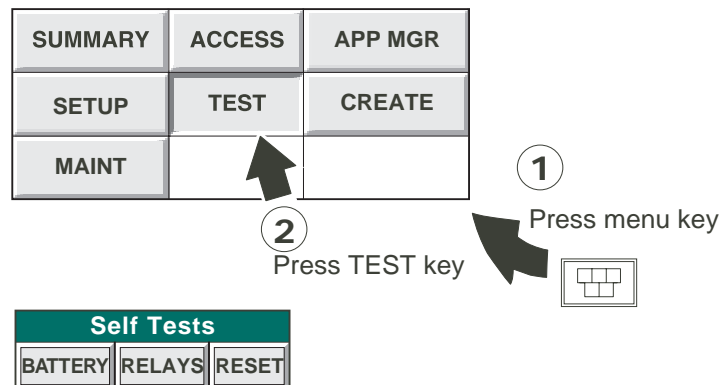

Figure 1.7 Test menu access

### 1.7.1 Battery test

Touching the 'Battery' key calls the battery test display as shown in figure 1.7.1 below. Touching the 'Force' key causes a re-test.

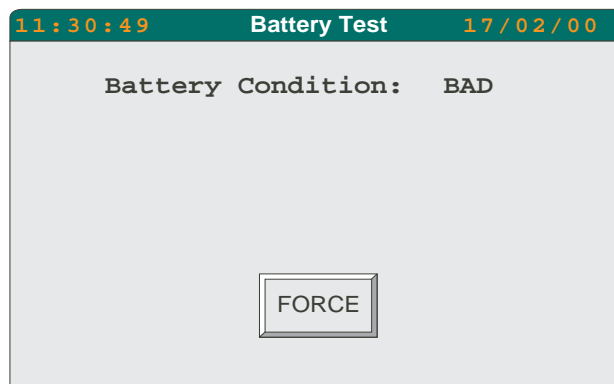

Figure 1.7.1 Battery Test display

## 1.7.2 Relay/LED test

Touching the 'Relay' key causes the relay test page to be displayed (figure 1.7.2), showing the current status of the Health and Run relays and of the Comms LED. The current settings can be overridden by touching the status area (e.g. CLOSED) of the required item and selecting a setting from the pick-list.

Any changes are reversed on leaving the page.



Figure 1.7.2 Relay Test display page

## 1.7.3 Reset instrument

Touching this key causes the instrument to re-initialise itself as if being powered down, then up again.

To carry out the reset, touch OK. If reset is not required, quit the page by touching the menu key.

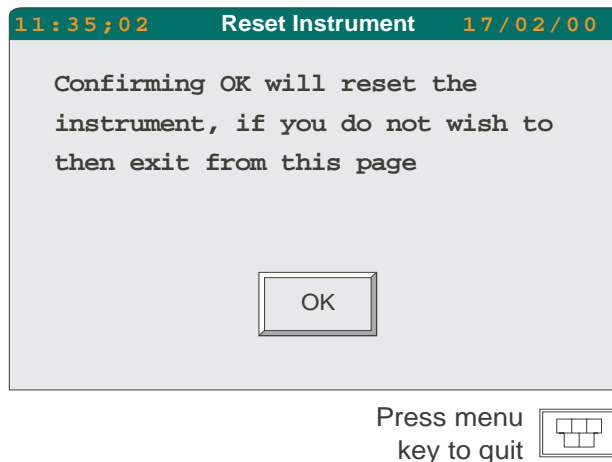

Figure 1.7.3 Reset instrument display

This page is deliberately left blank



## CHAPTER 2: GETTING STARTED

This chapter is for all prospective users of the instrument, including those responsible for installing and commissioning it.

The chapter consists of the following sections:

- 2.1 Switch-on, and the opening display, including the [navigation keys](#)
- 2.2 [The Main pane: information entry and display](#)
- 2.3 [The Pop-up menu](#)
- 2.4 [The Program pane](#)
- 2.5 [The Programmer menu](#)
- 2.6 [The Alarm pane](#)
- 2.7 [The Logging pane](#)
- 2.8 [The Access pane](#)
- 2.9. [The floppy disk](#)
- 2.10 [Creating a database automatically.](#)

### 2.1 SWITCH-ON AND THE OPENING DISPLAY

#### 2.1.1 Switch on

The Instrument is not fitted with a power switch, so the switch-on arrangements depend upon the particular installation. After switch-on, the screen will remain blank for a few seconds before brightening, then, after approximately 15 seconds, an opening display appears that fills most or all of the screen area.

If this opening display fails to appear:

1. check that there is a power supply
2. check with the Commissioning Engineer that the instrument powered up faultlessly when he or she last left it.

After this, if the problem is still unresolved, recall the Commissioning Engineer.

#### 2.1.2 The user interface

The user interface is open to customisation, either before operation or with the instrument taken out of service. For example the opening page (called the Home page) can differ, other pages can be changed, and 'User pages' ('User screens') can be added. The size of the panes can differ, the legends on the buttons can differ, and indeed the buttons need not exist at all. In the extreme the entire architecture of the interface can differ.

Chapters 2 to 4 of this manual describe the system of menus and pages supplied by the manufacturer, before any customisation by the user. This menu system is called the Standard Interface. Chapter 5 describes how to customise this Standard Interface, if required.

#### 2.1.3 The standard interface

The Standard Interface consists of a number of display 'panes' and a group of 'Navigation' keys as described below. Figure 2.1.3a shows a large-frame (SVGA) unit; figure 2.1.3b a small-frame (1/4 VGA) unit. (These drawings are not to the same scale).

### 2.1.3.1 DISPLAY PANES

**The main pane**

This area contains the keys, menus, pick-lists, dialogue boxes, windows and pages that make up the standard menu system of the Visual Supervisor.

**The program pane**

This displays information about the state of the program that is currently loaded or running.

**The alarm pane**

This displays alarm signals and messages.

**The logging pane**

For SVGA units only, touching this area calls the logging menu to the main pane. The logging pane does not appear on 1/4VGA units.

**The access pane**

For SVGA units only, displays the currently logged-in user. Touching this area calls the access menu to the main pane. The access pane does not appear on 1/4VGA units.

**The recipe pane**

For SVGA units, fitted with the recipe software option only, this pane shows the status of the current recipe line. See chapters 3 and 4 for details of the recipe application.

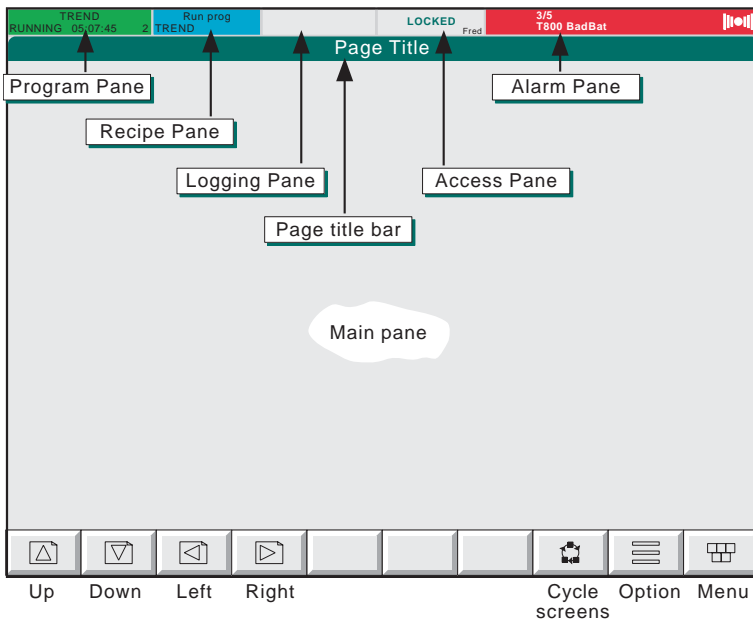

Figure 2.1.3a SVGA screen layout

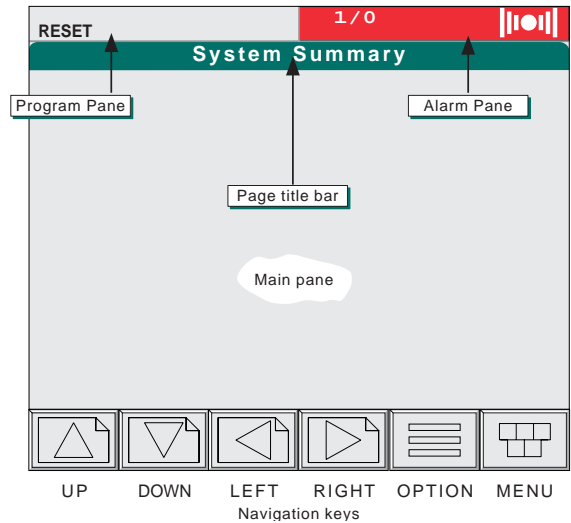

Figure 2.1.3b 1/4 VGA screen layout

### 2.1.3.2 NAVIGATION KEYS

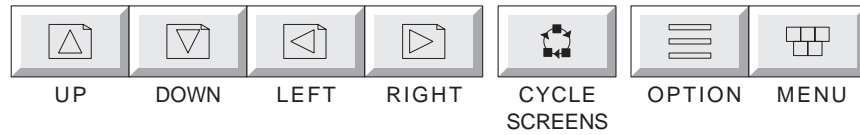

Figure 2.1.3.2 The Navigation keys

These touch-sensitive printed keys at the bottom of the screen carry the following functions:

UP	Goes up one level of menu hierarchy
DOWN	Goes down one level or cycles the screen according to context
LEFT	Jumps across (left) in the hierarchy, at the same level. Also moves forward (left) between successive pages of tabular data. Action depends upon context.
RIGHT	Jumps across (right) in the hierarchy, at the same level. Also moves back (right) between successive pages of tabular data. Action depends upon context.
CYCLE SCREENS	For SVGA displays only, this key allows the ways in which information is displayed to be scrolled through. The cycle screens key does not appear with 1/4VGA screen units - its function is carried out by the Down key.
OPTION	Brings up a menu, or an extra set of keys, for options specific to the page on display
MENU	Brings up the main (top-level) Pop-up menu of the hierarchy

### 2.1.3.3 KEYBOARD OPERATION

It is possible to set up the unit to use a keyboard, or keypad, as a supplement to the touch screen. See section 4.5.1 for details.

If the unit is so configured, then a cursor appears on the screen. The cursor normally points upwards, but inverts when 'pointing' at the navigation keys on a 1/4 VGA unit. The cursor can be moved by a number of means, depending on the type of keyboard, as described below. The touch screen remains active, so it is possible to use both keyboard and touch methods to provide optimum ease of operation.

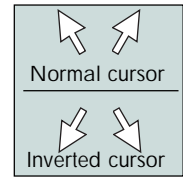

#### TYPES OF KEYPAD

1. Cursor keys, plus 'Enter'. Allows the cursor to be moved around the screen, using the cursor keys, with the Enter key being used to 'touch' the screen (i.e. this operates as a simple 'point and click' interface)
2. Cursor keys, numeric keys and 'Enter'. As described above, but the numeric keypad can be used to jump from one touch-sensitive area to another ('Num Lock' not active), or as numeric entry keys ('Num Lock' active)

Functions with 'Num Lock' not active:

Home Moves the cursor to the 'Menu' key.

End Moves the cursor to the last touch-sensitive area on the screen.

PgUp Moves the cursor to the next touch-sensitive area.

PgDn Moves the cursor to the previous touch-sensitive area.

Del Clears numeric values (equivalent to using the pop-up 'C' key).

Ins Moves the cursor to the pop-up 'Enter' key.

Functions with 'Num Lock' active

0 to 9 used to make numeric entries

. decimal point, used to make numeric entries

- toggles the sign of the entered value.

3. Function keys, (plus the above). This allows the keyboard function keys to mimic the instrument navigation keys, as shown in figure 2.1.3.3. The keys are described in section 2.1.3.2, above.

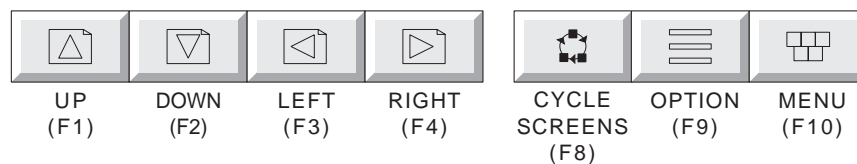

Figure 2.1.3.3 Function key operation

4. Full PC Keyboard. In addition to the above functions, this allows direct entry of text strings etc. The <esc> key closes an open pop-up, without 'entering' any edited data. The <←> (back arrow) key performs a 'back-space' function during text entry.

## 2.1.4 The opening display

Note: if the system has been configured with an overview screen, then the opening display will be that overview screen - refer to section 3.6.

The opening display of the Standard Interface is the System Summary page depicted in figure 2.1.4, below.

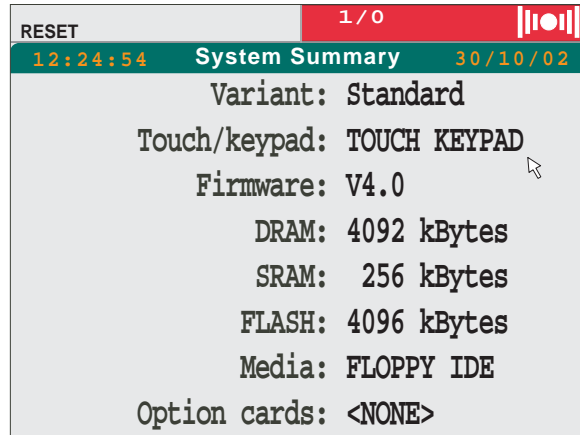

Figure 2.1.4 System Summary page

The System Summary page confirms the order options that were specified for this instrument. For versions 2.7 onwards, operation of the 'down' or 'cycle screens\*' key calls a second page which shows which software options are fitted. These two pages can be cycled through using the 'down' or 'cycle screens' key.

\*Note: The cycle screens key is available only on the SVGA version of the instrument.

Initially the opening display is 'Locked'. In this state, the only interactive items are the right-most of the navigation keys - the Menu key, and, for the SVGA version of the instrument only, the ACCESS pane. Operation of the menu key causes the opening 'Pop-up' menu of the Standard Interface to appear (section 2.3). Operation of the ACCESS pane calls the Security access page as described in section 2.8 of this manual. This allows the display to be unlocked using an appropriate password or an ident.

## 2.2 THE MAIN PANE

The Main pane is the display area for collecting information from the user by means of keys, menus, pick-lists, dialogue boxes and windows; and for displaying information to the user by means of dialogue boxes, windows, panes and pages.

### 2.2.1 Information display

The Standard Interface is a menu system whose structure is hierarchical like a family tree. At the top is the Pop-up menu which offers a choice of submenus as depicted below.

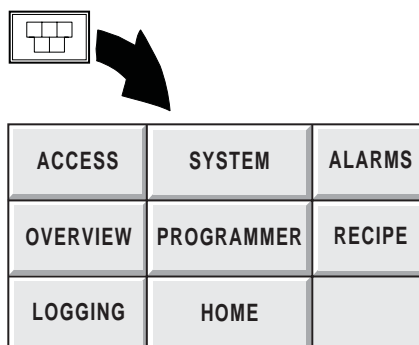

Figure 2.2.1 The Standard Interface: top level

ACCESS, SYSTEM and ALARMS appear on every instrument; others appear only if configured. Of these, PROGRAMMER and Recipe are the most frequently used.

Below this menu level, there are usually two or three further levels of functions overall that give users successively more detailed control of different aspects of programs, applications, and the instrument itself.

### 2.2.2 Information entry

Information entry is by touching areas on the screen with a finger, the eraser end of a pencil or similar. Hard, sharp or pointed implements such as pens, keys and fingernails must never be used or damage will be caused to the touch screen.

There are two main areas of the screen:

- 1 The Main pane, which displays the keys, menus, pick-lists, dialogue boxes and fields of the Standard Interface
- 2 The row of touch-sensitive keys near the bottom of the screen.

The keys and other items of the Standard Interface are not all touch-sensitive, and those that are sensitive ('active') are not active all the time. You can tell which items are active at any time by their pale yellow background, and you can tell which active item was the last one you selected by its bright yellow background.

## 2.3 THE POP-UP MENU

**NOTE:** In the following description of the Pop-up menu, and indeed of all the screen displays throughout this manual, it is important to note that almost everything is open to customisation. On any particular instrument the legends on the buttons can be different from those shown here, indeed the buttons need not exist at all, and in fact the whole architecture of the interface can differ.

Throughout this manual what is called the Standard Interface is described. This is generated by the manufacturer, before any customisation by the user. This is not the same as the Minimum Interface, which is generated by the minimum configuration necessary for the instrument to function.

The Minimum Interface Pop-up menu consists of three panes: ACCESS, SYSTEM and ALARMS. With the display 'Locked' - that is, before a password is entered and access gained, only ACCESS and SYSTEM are active.

However, most users will operate the Standard Interface. This features five more panes: PROGRAMMER, LOGGING, OVERVIEW, RECIPE and HOME/USER SCREENS. In this case, with the display locked, ACCESS, SYSTEM, OVERVIEW and HOME/USER SCREENS will be active. Other (i.e. non-active) keys are distinguishable by having their text in white.

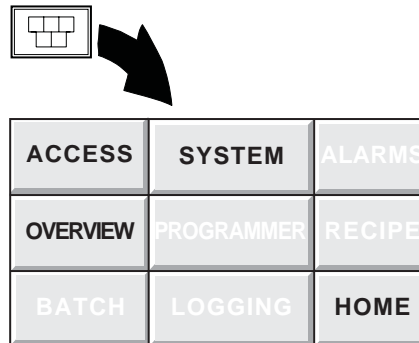

Figure 2.3. The 'Standard' Pop-up menu, display locked

From this menu, without a password, menu systems can be explored and information displayed. The SYSTEM, OVERVIEW and USER SCREENS displays are view-only at this locked stage; only ACCESS will respond fully to menu and key selections, to grant access as described in [Section 2.8 \(Gaining access\)](#).

The functions of each pane:

ACCESS	With a valid password, this pane is the gateway to the functions-sets below that are needed to do the job.
SYSTEM	is the gateway to the system functions of the instrument (that is, the instrument-specific and application-specific functions, as opposed to the program-specific functions).
ALARMS	is the gateway to the alarm functions.
PROGRAMMER	If configured, this is the gateway to the programming (Engineer) functions of editing setpoint programs. This key is also the gateway to the operational (Operator) functions of loading, running, pausing and aborting setpoint programs.
RECIPE	If configured, this allows access to the recipe monitoring and editing functions.
BATCH	If configured, this provides a means by which batches can be loaded, started and monitored.
LOGGING	If configured, this is the gateway to the data logging functions
OVERVIEW	If configured, this provides an overview of the function blocks in the database, with information about each.
HOME/USER SCREENS	If configured, this returns you to the Home page. The Home page may be a single page, or it may be the root page of a user-written hierarchy of pages. If HOME/USER SCREENS is not configured, the System Summary page acts as a default Home page, displayed after a timeout.

Of the two or three further levels in the hierarchy, all are available to Engineers, but only some are available to Operators and Commissioning Engineers. This helps to improve usability, by hiding those facilities which are not currently required.

## 2.4 THE PROGRAM PANE

SAMPLE	RUNNING	SAMPLE
RUNNING 14:18:23 1	14:18:23	Segment 1

Figure 2.4 A typical Program pane displays

Located at the top left of the screen, this area (which varies in appearance according to instrument type, and options fitted) has two functions:

- 1 To display data about the status (state) of the program currently running, if any
- 2 As a touch pad, to call the Programmer menu directly.

### 2.4.1 Displaying program status

#### WITH NO PROGRAM LOADED

When there is no program loaded, the Program pane is white, and blank except for the word 'RESET'.

#### WITH A PROGRAM LOADED

In the example shown in figure 2.4 the program pane reports the following:

- 1 that a program called SAMPLE is loaded,
- 2 that it is Running,
- 3 that it is expected to complete at 14hr 18mins 23secs
- 4 that the name of the segment currently running is '1'.

Generally, a loaded program can be in one of six states, reported on the Program pane: Run, Hold, Held Back, Idle, Complete and Error.

Alone among these, Held Back is not under the control of the user. Programs adopt the Held Back state automatically when a process value (PV) falls too far behind the setpoint (SP) value. What happens is that the program holds the SP constant (holds it back). A constant SP is called a 'dwell'.

With the program in Run state, the Program pane is green, and displays the following data:

- 1 The name of the program;
- 2 The program status (e.g. Running)
- 3 The estimated time or date of completion of the program
- 4 The name of the segment currently running.

The pane is similar with the program in Hold state, except that the Program pane is yellow, and has the word 'HELD' instead of 'RUNNING'.

The program pane for the Held Back state, is similar to the 'HELD pane except that 'HELD BACK' appears instead of 'HELD'.

In Idle state, the Program pane is white and displays the word 'IDLE' and the time is displayed as ??:?:??. There is no current segment.

In Complete state, the Program pane is pale blue, with the word 'COMPLETE' displayed.

In Error state, the Program pane is red, with the word 'ERROR' (for example, provoked by a COMMS breakdown) displayed.

### 2.4.2 Programmer menu access

With access granted, the Programmer menu is called either by touching the Program Pane.or by pressing the printed Menu key below the screen, and then the PROGRAMMER key in the resulting Pop-up menu.



## 2.5 THE PROGRAMMER MENU

Broadly, the Programmer menu combines the programming functions (for the Engineer) of editing programs, with the operational functions (for the Operator) of loading, scheduling, running, monitoring, pausing and aborting programs. With the display locked, or with it unlocked but no program loaded, only PROGRAMS and SCHEDULE appear.

Programmer		
MONITOR	PROGRAMS	SCHEDULE
PREVIEW	PRE-PLOT	EDIT
RUN	HOLD	ABORT
RUN FROM	SKIP	

Figure 2.5a The Programmer menu, display locked

With the display unlocked and a program loaded, the full menu appears:

Programmer		
MONITOR	PROGRAMS	SCHEDULE
PREVIEW	PRE-PLOT	EDIT
RUN	HOLD	ABORT
RUN FROM	SKIP	

Figure 2.5b The Programmer menu, display unlocked

Some of the buttons are greyed out because - taking the example shown above where the program either has yet to be run or has just been aborted - these keys are not currently required.

MONITOR	Displays text details of the program currently loaded.
PROGRAMS	Loads a new program from those available in the instrument's flash memory.
SCHEDULE	Runs a program at a future time and date, repeating a specific number of times if necessary.
PREVIEW	PREVIEW is a graphical version of EDIT (below). With a program loaded, it displays its profile, so that Engineers can check it before running it. They can display the target values for the variables at any point in time, by moving a vertical cursor along a horizontal time-base.
PRE-PLOT	PRE-PLOT is a graphical version of MONITOR (above), but extended, showing a plot of both target and actual variables. A vertical cursor at the centre of the display marks the current time and the display moves from right to left past it, showing on the left the actual values of the process variables (PVs), setpoints and digital outputs, and on the right the required (target) setpoint profile.
EDIT	Enables Engineers to edit, and Operators to view, the setpoints of the current program displayed in a table.
RUN	Runs a program from the start, or re-starts a program after a Hold from the point where it paused.
HOLD	Stops a program running, and holds it paused at that point.
ABORT	Switches a program from 'Hold' state to 'Idle'.
RUN FROM	Starts or re-starts a process from a specified time-into-program.

These are the functions most frequently used in normal operation.

## 2.6 THE ALARM PANE

The Alarm pane appears at the top right-hand corner of the screen and is used to display any alarm signals (triggered by abnormal conditions detected in the process under control), instrument alarms etc.



Figure 2.6 A typical Alarm pane display

(In this particular example, BADBAT means that voltage delivered by the battery has fallen below its operational threshold).

In general, there are four possible types of alarm annunciation as summarised in table 2.6.1 below. The question mark symbol on a flashing orange/black background means that there is a new message to be investigated as described in 'ACTIVE MESSAGE DISPLAY' below.

Alarms can be set to be latching or non-latching (auto acknowledging). Latching alarms are annunciated until acknowledged; auto-acknowledge alarms are annunciated until the alarm trigger returns to a non-alarm state. Decisions on which conditions should trigger an Auto-Ack Alarm rather than an Acknowledge Alarm (latching alarm) are made during configuration.

### 2.6.1 Alarm state indication

Alarm state is active or inactive, acknowledged or not. An alarm is triggered (becomes active) when the value it is monitoring moves outside a pre-set value or range of values. It becomes inactive when the signal returns to within the preset value or range of values. These values are set up during configuration.

Alarm indicators flash until the alarm has been acknowledged, at which time they become illuminated steadily. To acknowledge an alarm, the alarm pane can be touched, followed by 'ACK'. (Access permission needs to be set.)

Indication	Definition
Flashing Red/Black	One or more active alarms are present, one or more of which have not been acknowledged.
Steady Red	One or more active alarms are present, all of which have been acknowledged.
Flashing White black	One or more unacknowledged alarms were active, but have now returned to their non-active states.
Steady White	There are no active alarms present and there are no non-active, unacknowledged alarms present.

Table 2.6.1 Alarm annunciation summary

*In summary:*

If the indication is red an active alarm is present and if it is flashing it has not been acknowledged.

*In more detail:*

Flashing red/black means that there is at least one abnormal condition that requires attention, and at least one active alarm has not been acknowledged.

Flashing white/black means there has been at least one abnormal condition, which has now returned to normal, without being acknowledged.

Steady red means there is at least one abnormal condition that requires attention, all of which have been acknowledged, either manually or automatically

Steady white means that there are no current active or inactive/unacknowledged alarms.

### 2.6.1 ALARM STATE INDICATION (Cont.)

The Alarm pane gives a summary of all alarms, not information about a particular alarm. For instance, if the pane is flashing red, it means that there is at least one current unacknowledged alarm which may or not be the one displayed in the alarm pane.

In order to gain more details, the alarm history display can be referred to (section 2.6.2).

### ACTIVE MESSAGE DISPLAY

In addition to the normal alarm displays described above, a further alarm icon, in the form of a question mark on a orange/black flashing ground, may appear at the left side of the alarm pane as shown in figure 2.6, above. If this indicator appears, there are one or more messages to be acknowledged or reviewed. Further details of these messages are to be found in section 3.8 of this manual

### 2.6.2 Responding to alarms

There are four possible responses to an alarm:

- 1 Do nothing
- 2 Get more information, by bringing up the Alarm History page, which is a list of past and current alarms and events
- 3 Acknowledge the alarm, by bringing up the Alarm window and pressing a pane
- 4 Report and then remedy the abnormal condition.

### DO NOTHING

Doing nothing is acceptable when the light just shows steady white. This indicates that a non-serious abnormal condition did exist but it has now returned to normal, and that it has been acknowledged.

Doing nothing is also acceptable with a steady red indication that is not the result of its having been manually acknowledged. In this case, the alarm will have been triggered by an Auto-Ack alarm, which does not require active intervention but will give information about a slightly abnormal condition.

### ALARM HISTORY PAGE

Figures 2.6.2a and b show the alarm history page for SVGA and 1/4VGA versions of the instrument respectively (not drawn to the same scale). The major difference is the 'ACK' column which appears only in the SVGA version.

TYPE		ACTIVE	CLEAR	ACK
ENGINEER	Log On	29/10/00 05:55:03	-----	-----
2500/7	Comms	29/10/00 05:08:51	-----	-----
Database	Started	29/10/00 04:08:51	-----	-----
T800	BadBat	29/10/00 04:08:51	-----	29/10/00 05:59:26
Database	Loaded	29/10/00 05:08:51	-----	-----

Figure 2.6.2a. Alarm History page (SVGA)

TYPE		ACTIVE	CLEAR
ENGINEER	Access	16/02 11:46	-----
2500/7	Comms	16/02 11:45	-----
Database	Started	16/02 11:45	-----
Database	Loaded	16/02 11:44	-----

Figure 2.6.2b Alarm history page (1/4 VGA)

## 2.6.2 ALARM HISTORY PAGE (Cont.)

The Alarm History page displays a list of alarm conditions and Events, showing when they occurred, and if appropriate, when they were cleared or acknowledged (large frame (SVGA) versions only). Events and other items which are not clearable or which cannot be acknowledged display ----- in the Clear and ACK columns.

The Alarm History record starts in the first instance from when the instrument is powered up for the first time. Thereafter it is preserved through any automatic restarts called hot starts (see section 4.5.2 Setting the Start-up strategy); but the record is lost and a new one started whenever a new application database is loaded.

The Standard model of the instrument can retain and display a total of 250 alarms or Events. The Enhanced model can hold up to 500 alarms or Events. Once these limits are exceeded the oldest item in each case is deleted when a new addition is made to the list.

### TWO LINE DISPLAY

Operation of the down arrow key toggles between single-line and double-line working. Single line working is as described above, and as shown in figures 2.6.2a/b. When in two-line working, each alarm has a second line showing one or two User IDs.

For units without the Auditor option, one ID is displayed (in parenthesis), and this ID is that of the user who was logged on at Event time (figure 2.6.2c).

12:36:59		Alarm History		30/10/02	
TYPE	ACTIVE	CLEAR			
Database Restart	30/10 12:35	----	----		
	(Fred)				
Database Resumed	30/10 12:35	----	----		
	(Fred)				
T800 BrownOu	30/10 12:35	30/10	12:35	----	----
	(Fred)				
Database Started	30/10 12:25	----	----		
	(Fred)				
Database Loaded	30/10 12:24	----	----		
	(Fred)				

Figure 2.6.2c Two-line history display (1/4 VGA screen)

For units with the Auditor option:

- If the event did not need signing, then one ID is displayed (in parenthesis), and this ID is that of the user who was logged on at Event time (figure 2.6.2c).
- If the event was signed, one ID is displayed, and this ID is that of the user who signed for the action.
- If the event was authorised, two IDs are displayed, the first (left-most) ID is that of the user who signed for the action, the second is that of the authoriser.
- If a text reason for the event is given, when signing, then this (max. 16-character) text string also appears, E.G.:

Database Loaded	30/10	12:35	----	----
New database	Fred	ADMIN		

### ALARM ACKNOWLEDGEMENT

Unacknowledged alarms are made evident by the flashing of the alarm pane, and a flashing background in the alarm history page.

It is recommended that an alarm is acknowledged before any attempt is made to rectify the cause of the alarm. Alarms are acknowledged by calling the 'Alarms' menu box (either by touching the alarm pane, or by touching the menu key, then the 'ALARMS' key) and operating the ACK key.

## 2.7 LOGGING PANE

This area is displayed only by SVGA versions of the instrument. Touching this area calls the logging menu shown below. The logging function allows data to be saved to floppy disk as described in section 3.4 of this manual. That section also shows how to access the logging menu from the menu key.

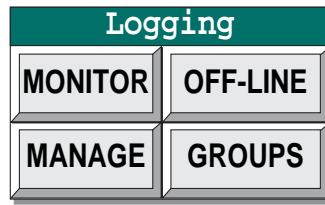

Figure 2.7 Logging menu

## 2.8 ACCESS PANE

This area is displayed only by SVGA versions of the instrument. Touching this area calls the first of the access pages described in 'Gaining access' below. This is an alternative to using the menu key followed by 'ACCESS' as described below.

### 2.8.1 Gaining access

There are two methods of gaining access to the instrument configuration, the standard system described in section 2.8.1.1 below, and the User ID method described in Section 2.8.1.2. The instrument is supplied with the standard access system in operation, but it can be converted (irreversibly) to the User ID version as described in section 4.4 of this manual. For units fitted with the 'Auditor' option, see also section 8.

#### 2.8.1.1 STANDARD ACCESS

For the Visual Supervisor there are nominally three types of users: Operators, Commissioning Engineers, and Engineers.

Each of these three types has what is known as a level of access to the facilities of the instrument, based upon the needs of the job, and they gain access to that level by typing in a password. The level of access is fixed for each type of user. That is to say, all Operators share the same password to their level of access; all Commissioning Engineers share the same password to their level of access; and all Engineers share the same password to their level of access. The Engineer-level password gives access to every facility in the instrument. Only from Engineer-level can passwords be changed.

The hierarchy of levels is LOCKED (lowest), OPERATOR (next lowest), COMMISSION (middle), ENGINEER (highest). You need a password to change up levels, but not to change down. No password is needed for Locked. What follows are step-by-step instructions on how to navigate the menu system to get access to your level of facilities. The assumption is that you have your password ready. Passwords are set and re-set by the Engineer. For first-time access, immediately after commissioning, Section 4.4 (Controlling Access) should be referred to.

**2.8.1.1 STANDARD ACCESS (Cont.)**

1. With the instrument powered up, press the right-most of the keys below the screen, the menu key  
 In the Main pane the restricted version of the pop-up menu (figure 2.3) appears.  
 The program pane shows RESET on a white background, indicating that there is no program loaded.
- 2 Press ACCESS

2

Press ACCESS key

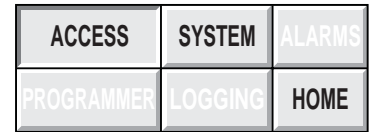

1



Press menu key

The Security Access page appears.

- 3 Press the field showing LOCKED on yellow, opposite 'New Level'.

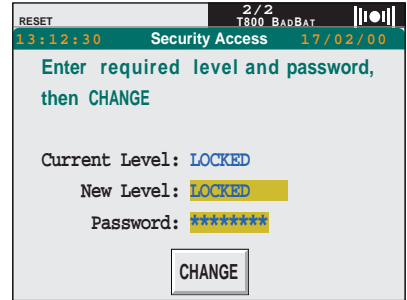

In the left half of the screen a pick-list of the access levels appears:

- LOCKED
- OPERATOR
- COMMISSION
- ENGINEER.

- 4 Select a level -Operator for example.

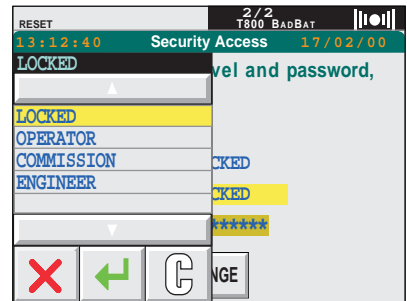

The background highlights yellow, confirming the choice:

5. Press the Return key (the green bent arrow) ←

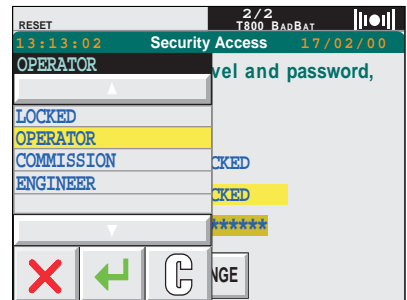

### 2.8.1.1 STANDARD ACCESS (Cont.)

The pick-list disappears, revealing the full Security Access page again, showing the selected level (OPERATOR, COMMISSION or ENGINEER) in the New Level field, on yellow.

- 6 Press the Password field (shown as asterisks on pale yellow)

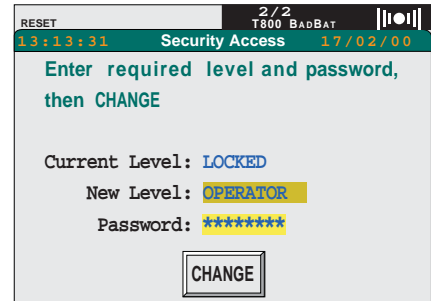

A 'qwerty' keyboard display appears, with a cursor flashing under the first character-space in the black confirmation bar at top left.

- 7 If the password contains characters not visible on this display, press the 'up-arrow' at bottom left to view others available. A numeric/symbol keyboard appears. A further operation of the Up Arrow calls a keyboard of accented lower-case letters. A final operation returns the original keyboard to the display. In entering the password as described in step 8 below, the characters can be selected from all three keyboards as required

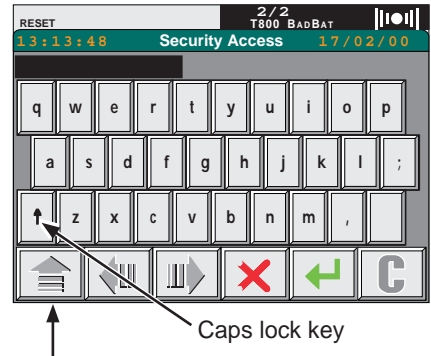

Use up-arrow key to select alternative keyboards

- 8 Enter the first character of the password. It appears in the black confirmation bar at top left, and the cursor moves under the next space. Enter the next character, and so on. Erroneous characters can be deleted by positioning the cursor under the relevant character and pressing the 'C' key. Alternatively, to return to the Security Access page, press the 'red cross' key.



- 9 When the confirmation bar shows the correct password, press the Return key.

The Security Access page reappears, unchanged from step 6.

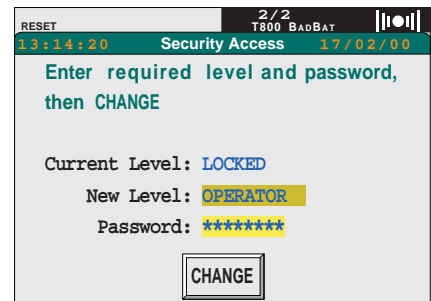

10. Press CHANGE

The display blanks momentarily, and returns showing the selected level (OPERATOR, ENGINEER or COMMISSION) in the Current Level field as well as the new level field.

If not, an incorrect password must have been entered. Check that the password is correct for the level selected in step 4, and then repeat from step 3 onward.

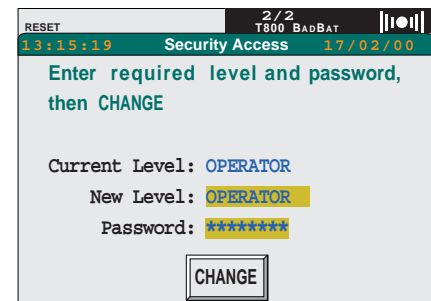

### 2.8.1.2 USER ID ACCESS METHOD

In order to gain access using this system, a 'User Identity' is entered, instead of an access level, before the password is entered. User ID, access level and password are all entered as described in section 4.4.3.

To access the Security Access page, either touch the logging pane (SVGA units only), or touch the menu key then the ACCESS key as described in Section 2.8.1.1 above.

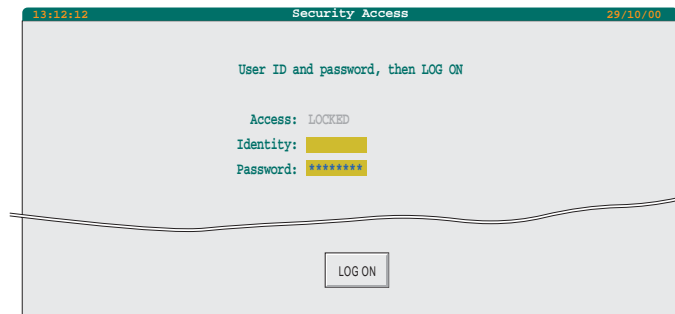

Figure 2.8.1.2 Security access page (SVGA)

The user identity and password can now be entered by touching each yellow area in turn and using the resulting keyboard to enter the relevant character strings. Once this has been completed, the LOG ON key is operated.

If the instrument fails to respond with the relevant access level, either the Identity or the Password has been incorrectly entered.

---

**Note:** The character strings are case sensitive e.g. Identity 'Fred' is different from identity 'FRED'.

---

## 2.9 THE FLOPPY DISK

A floppy disk (MS-DOS-formatted, 1.44MB) runs in the drive behind the flap on the front panel. It can be used for loading and saving programs, for logging (recording) data, or for updating the application database (with new user screens, for example, or foreign language files).

To access the disk drive, lift the bottom of the central tab upwards and outwards. This centre tab can now be used to pull the flap downward from the top. Insert the disk, close the flap, and secure it by hooking the top of the central tab under the lip of the casing, and pressing the bottom of the tab shut.

---

**Notes:**

- 1 Always use a newly-formatted disk. Disks that have previously been used for other purposes should not be used.
  - 2 Disks used for logging should be replaced after one month's use.
  - 3 Floppy disks should not be removed during data transfer.
  4. The instrument will not format an unformatted disk.
  5. Folders (directories) must not be placed on the disk.
-



## 2.10 CREATING A DATABASE AUTOMATICALLY

For a definition of 'database', see 'LIN database' in the Glossary.

A valid LIN database must be present in order for the instrument to control a process.

The normal way to create a database is to build one by selecting from a suite of function blocks using LINTools running on a PC (see 'The LIN Blocks Reference Manual', HA082375U003), and then downloading or importing it into the instrument.

This topic describes a fast-track approach, by creating a database automatically using the resident Auto Database Create facility. This is intended to produce a 'first-pass' database, to enable novice users to get started quickly. It is not intended to generate the final database.

What the facility does is to look at the instruments connected on the Modbus master communication line (primarily 2500 Controllers) and then to create a database that will operate with those instruments.

Broadly, the process is as follows:

- 1 Connect up all configured 2500s (up to a maximum of 8 on Modbus nodes 1-8 only)
- 2 Set up the Modbus master communications settings to match those of the 2500s (as described in Section 4.5.1 Editing Communications parameters)
- 3 If necessary, unload any existing application using the Application Manager (as described in Section 4.3.5. Unloading an application)
- 4 Run the Auto Database Create facility, as described next.

---

### Notes when using Profibus

- 1 If the unit is configured as a Profibus master, then the automatic database creation function will create function blocks for instruments located on the Profibus network (not the Modbus network)
  - 2 For Profibus use, the node number of the Instrument must be greater than eight to avoid any potential clash with a slave node.
  - 3 Only series 2500 I/O controllers will be identified
-

## 2.10.1 Running Auto database create

With no application loaded, press the Menu key.

The seven-pane version of the pop-up menu appears (If an application has just been unloaded, the background will be the Application Manager page instead of the System Summary.)

Press CREATE.

The opening page of Auto Database Create is displayed. This page allows each of the five options presented to be set to YES or NO. (All the options toggle between YES and NO when selected.)

If the database is to include a Setpoint Programmer, 'Programmer' should be set to 'YES' (see below).

If data is to be logged to a floppy disk, 'Logging' should be selected 'YES' If you want to view or monitor PID in connected 2500s, select YES to 'Loops'.

If 2500 I/O is to be viewed, 'I/O Modules' (for most efficient communications), or 'I/O Channels' (for most detailed information) should be selected 'YES'. It is not recommended to select both 'YES'

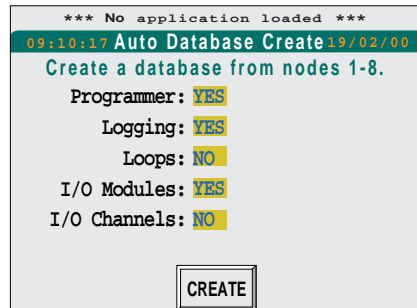
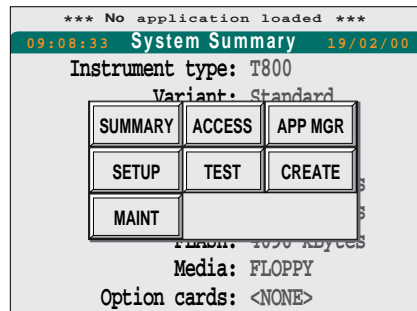

### PROGRAMMER

Selecting 'Programmer' to 'Yes' results in the following:

- 1 A Pre-Plot display is set up.
- 2 If one does not already exist, a sample program file (a .UYS file when SAVED) is created, which has the same name as the saved database. More details in Chapter 5.
- 3 A display group for the program is set up.

### LOGGING

Setting logging to 'YES' sets up logging to a single ASCII file for all the program variables for the auto-created .UYS file. More details are to be found in Chapters 3 and 4.

### LOOPS

Setting Loops to 'YES' sets up a display group for all loops.

### I/O

Setting I/O to 'YES'

- 1 Uses the definition of I/O required by the 2500 to determine what I/O is to be set up.
- 2 Sets up display groups for the I/O.

## 2.10.2 Database creation

Once all the options have been set, the CREATE key should be pressed. After some seconds of activity while the database is being created, the screen displays a summary of how many nodes have been found, how many blocks have been created, how many loops exist, and how many I/O modules have been found. The number of I/O modules should correspond to the number of 2500s connected. To rename the file, see section 2.10.3 below; to save the database, press SAVE; to retry, press CANCEL.

In addition to the above, if the relevant options are fitted, the following components will be created:

Option	Feature
Printer (Serial or parallel)	Block for standard printer output of all alarms to the print device
Reader	A block for reading bar-codes (unconfigured)
Recipe	Blocks for a single production line recipe
Batch	Blocks for a single batch controller. In addition, a basic batch file (suffix .UYB), plus recipe file (.UYR) and (if the option is fitted) a report file (.UYF) for a batch report.

Note: Operation of the CREATE key also creates an empty Modbus Slave Gateway file (.GWF) (if one does not already exist), to enable 'TalkThru'. More details are to be found in Chapter 4.

## 2.10.3 Database renaming

If the database filename is to be edited, the yellowed field should be touched, and the filename edited using the alphanumeric keyboard that pops up. This editing process is the same as that described in section 2.8 above.

After editing is complete, the green return key is pressed.

The summary page reappears showing the new name.

To save the database, press SAVE; to retry, press CANCEL.

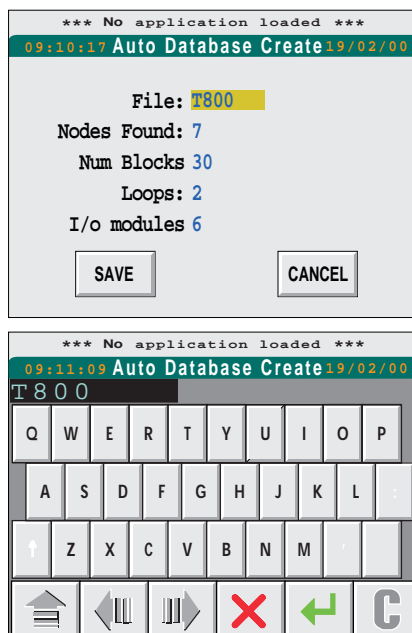

This page is deliberately left blank

## CHAPTER 3: OPERATION

The tasks in this chapter all require at least the ‘Operator’ level of access to the instrument.

The chapter consists of the following sections:

- 3.1 [Running a program](#)
- 3.2 [Holding and aborting a program](#)
- 3.3 [Monitoring a program](#)
- 3.4 [Logging data](#)
- 3.5 [Responding to alarms](#)
- 3.6 [Area and group displays.](#)
- 3.7 [Downloading recipes](#)

All the descriptions assume that access at Operator level has already been gained as described in Section 2.8 above. If, at any point, the display shows results that differ from those that the instructions tell you to expect, then the Menu key at the bottom of the screen can be operated to call the Pop-up menu and the beginning of the task or another facility if required.

### 3.1 RUNNING A PROGRAM

There are three ways to run a program, depending upon requirements:

1. RUN. Runs the entire program now
2. RUN FROM. Runs the program now, but from a specified point, after its start.
3. SCHEDULE. Runs the entire program at a specified time.

#### 3.1.1 Running a program now

1. In the row of navigation keys at the bottom of the screen, press the Menu key to call the Pop-up menu.

The Program pane displays RESET if there is no program loaded at the moment, or IDLE if a program has already been selected.

2. Select PROGRAMMER.

The Programmer window appears, offering two choices: PROGRAMS and SCHEDULE.

3. Select PROGRAMS.

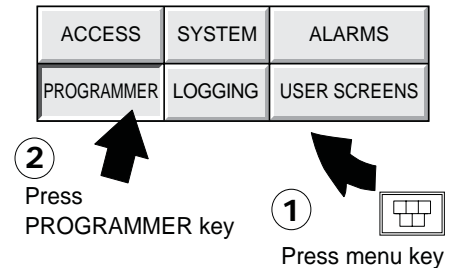

Programmer		
MONITOR	PROGRAMS	SCHEDULE
PREVIEW	PRE-PLOT	EDIT
RUN	HOLD	ABORT
RUN FROM	SKIP	

### 3.1.1 RUNNING A PROGRAM NOW (Cont.)

The Load/Save Program page\* appears, prompting for a file name. To the left of the page title is the current time, and to the right is the current date.

\* Note: Up to four setpoint programs can be supported simultaneously. Where more than one such program is running, the load/save screen (shown at the top of this page) has an additional field 'Id'. This field can take the value 1, 2, 3 or 4 to identify which programmer is to run this program.

All display pages refer to the program associated with the currently selected 'Id'.

For any particular programmer display page, the identical page for other valid Ids can be scrolled-through, using the right and left arrow keys.

4. Press the yellowed field of question marks.

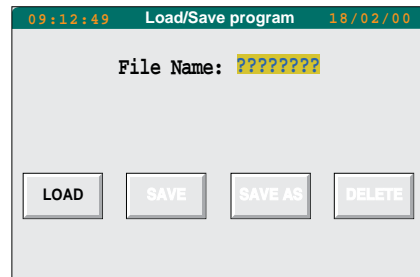

On the left side of the screen a pick-list (vertical menu) appears, showing the programs that the instrument currently holds. If necessary, the scroll bar at the bottom of list can be used to reveal more.

5. Press the name of the required program. The background of the selected program's name changes to yellow.
6. Press the Return key (the green arrow)

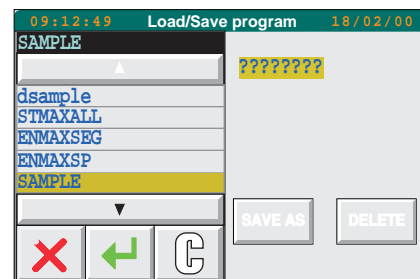

The pick-list disappears and the Load/Save Program page now shows the name of the selected program on a yellow background.

7. Press the LOAD key

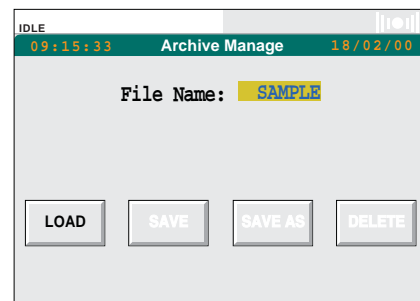

The full Programmer menu appears. With no program running, HOLD and ABORT are greyed out. The Program pane reads IDLE on a white background, showing the program is loaded but idling, not running.

8. Press RUN

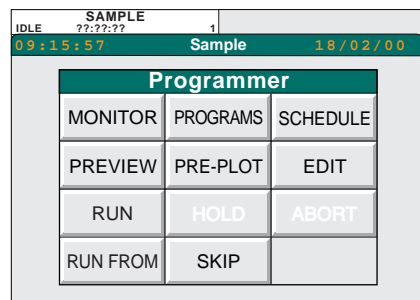

The Program pane changes to green, with status RUNNING. The expected time of completion and the number of the segment currently executing are also displayed.

The program is now running.

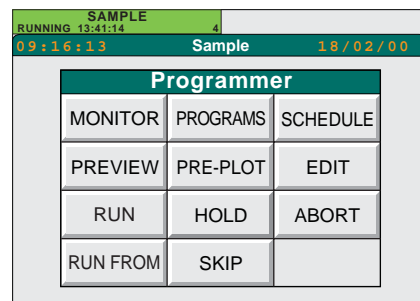

### 3.1.2 Running from a point

Running a program from a point means running a new program from a user-specified point after its start point.

The first seven steps are the same as in 3.1.1 Running a program now, above.

8. Press the RUN FROM key at bottom left.

The 'Run From' page appears, headed with the name of the program just loaded.

The 'Duration' field shows how long the program will take to complete.

The 'Run From' field is waiting for a time-into-program value to be entered, from which the program run is to be started. Initially, the Run From field is set at the default of 00:00:00 (the start) so, under the Segment header below it, the segment name is 1, the first.

The 'Time Through' field shows at what time through the segment the program will start.

9. Press the yellowed 'Run From' field.

In the left part of the display a numeric keyboard appears. At the top a confirmation bar shows the current 'Run From' time as 00:00:00 (hh:mm:ss), with a cursor blinking under the first '0'.

- 10 From the keyboard, key in the required 'Run From' time (in this example 01:45:00).

- 11 Press the green Return arrow

The keyboard disappears to reveal the full Run From page. If the selected time starts running the program from beyond the first segment, the 'Name' and 'Time Through' fields will show different values.

- 12 To run the program now, press the RUN key

The main display reverts to the Programmer menu.

The Program pane changes to green, showing RUNNING, the time of completion, and the segment number.

The program is now running, from the specified point.

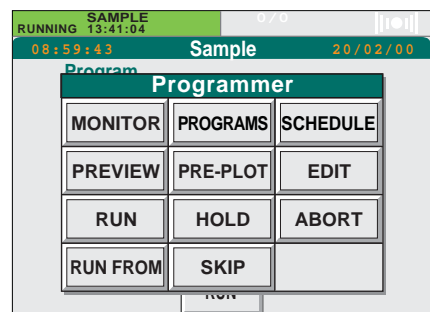
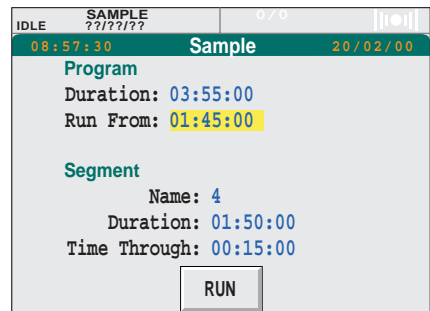
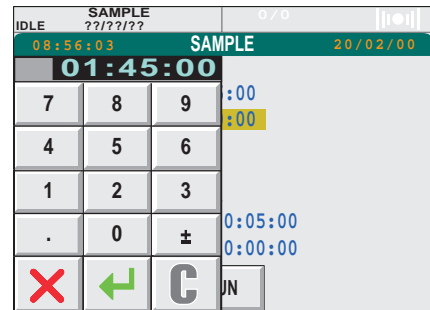
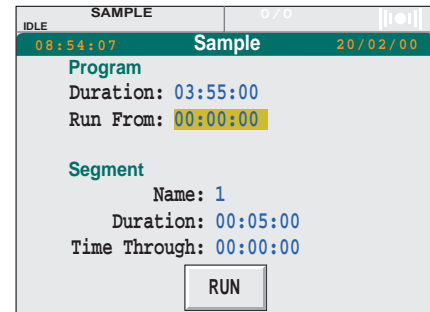
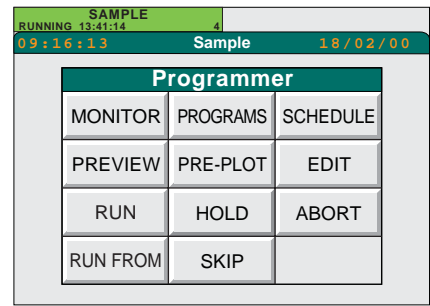

### 3.1.3 Scheduling a program

Scheduling a program means setting a time at which it will start to run automatically.

If another program is running at the scheduled start time, the scheduled program will be delayed and started later. The late start is recorded in the Alarm History.

1. In the row of navigation keys at the bottom of the screen, press the Menu key.
2. Select PROGRAMMER. from the pop-up menu that appears

With no program running, the Programmer menu which appears, has just two options: PROGRAMS and SCHEDULE.

3. Select SCHEDULE.

The Schedule Program page appears, prompting for information about the program to be scheduled.

4. Press the File Name field.

The left side of the screen shows a pick-list of the programs that the instrument holds.

5. Select the required program.

The background of the program name changes to yellow.

6. Press the Return key (the green arrow)

The pick-list disappears, and the File Name field shows the name of the selected program.

The program is now ready for scheduling.

**Note:** If the program is to run immediately after the currently-running program ends, the Start Date and Start Time can be left undefined, as shown here.

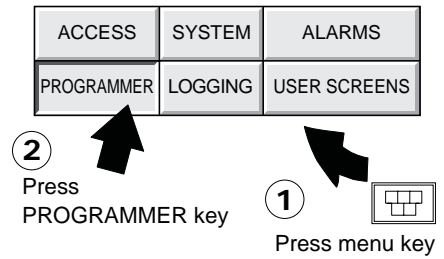

Programmer		
MONITOR	PROGRAMS	SCHEDULE
PREVIEW	PRE-PLOT	EDIT
RUN	HOLD	ABORT
RUN FROM	SKIP	

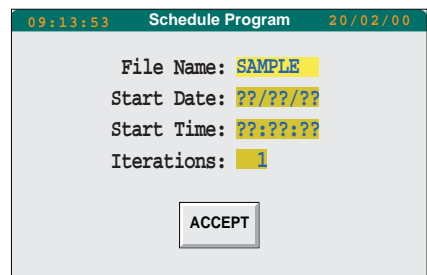
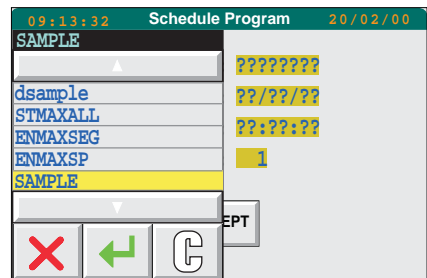
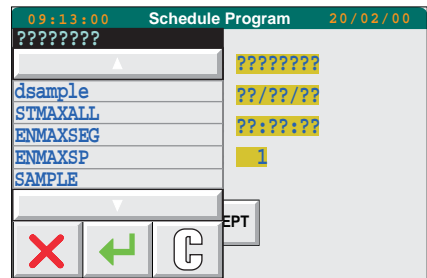
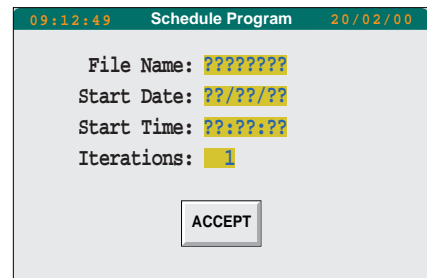



### 3.1.3 SCHEDULING A PROGRAM (Cont.)

#### 3.1.3.1 SPECIFYING THE PROGRAM START DATE

7. Press the Start Date field.

The left side of the screen shows a numeric keyboard, with a cursor flashing under the first number-space in the black confirmation bar at the top.

8. Key in the required date, in the format set for your instrument (ask your Engineer).

After the first digit has been keyed-in, the cursor moves under the space for the next one, and so on.

The last-entered character can be deleted, by pressing the 'C' key. To abort the whole date-entry process and return to the full Schedule Program page, press the red cross key.

9. When you've finished and the confirmation bar shows the date, in the correct format, press the Return key.

The keyboard disappears and the Schedule Program page now shows the specified date in the Start Date field.

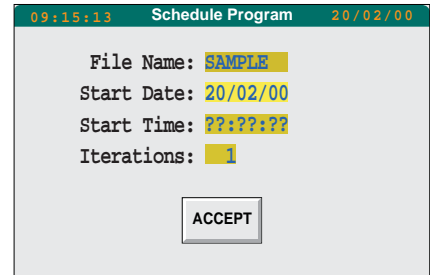
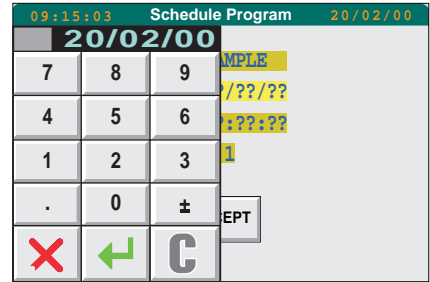
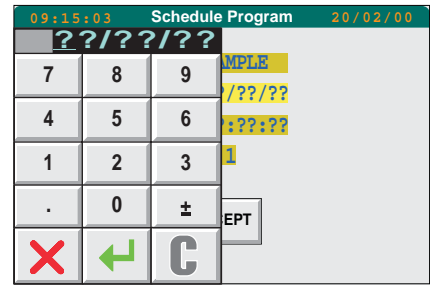

#### 3.1.3.2 SPECIFYING THE PROGRAM START TIME

- 10 Press the Start Time field.

The numeric keyboard reappears

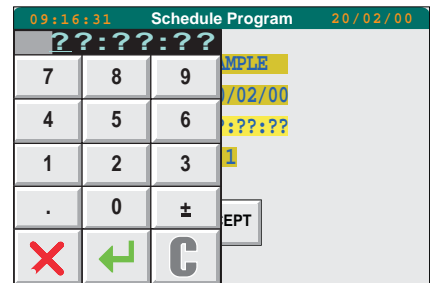

- 11 Key in the time in the format hh:mm:ss.

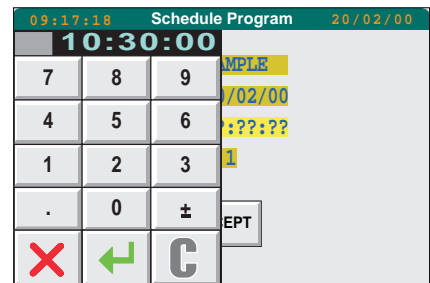

12. When time entry is complete and the confirmation bar shows the time in the correct format, press the Return key.

The keyboard disappears and the Schedule Program page now shows the specified time in the Start Time field.

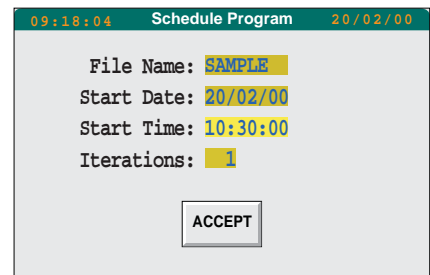

### 3.1.3 SCHEDULING A PROGRAM (Cont.)

#### 3.1.3.3 CHANGING THE NUMBER OF ITERATIONS (RUNS)

- 13 In the Iterations field, press the '1'

The numeric keyboard reappears.

09:18:20 Schedule Program 20/02/00

7	8	9	MPLE
4	5	6	/02/00
1	2	3	:30:00
.	0	±	1
X	←	C	EPT

- 14 Key in the required number of runs, and press the Return key.

To change the entered value, the 'C' key and red cross key operate as described in step 8.

If the program is to repeat continuously until further notice, press '0'.

09:18:32 Schedule Program 20/02/00

7	8	9	MPLE
4	5	6	/02/00
1	2	3	:30:00
.	0	±	1
X	←	C	EPT

15. The Schedule Program page displays the specified number of iterations.

The program is now scheduled.

09:18:58 Schedule Program 20/02/00

File Name: SAMPLE  
 Start Date: 20/02/00  
 Start Time: 10:30:00  
 Iterations: 0 (Continuous)

ACCEPT

### 3.1.4 Segment skip

Skipping a program segment causes the program to stop running its current segment and start running the next segment immediately.

Skip is initiated from the Programmer menu.

Programmer		
MONITOR	PROGRAMS	SCHEDULE
PREVIEW	PRE-PLOT	EDIT
RUN	HOLD	ABORT
RUN FROM	SKIP	

Press  
SKIP key

#### 3.1.4.1 SEGMENT TRANSITION CONSEQUENCES

##### From dwell, set or sevo (SP or PV) to any other type

These transitions are 'safe' and provide a bumpless transition of SP from one segment to the next. The program finishes early.

##### From ramp to set

Not Bumpless. The ramp is terminated early. The resulting bump is larger or smaller than that programmed depending on the direction of the ramp compared with the SET.

##### From ramp to dwell

Almost bumpless, with the SP being servoed to the current working SP at time of Skip. Usually results in a slight bump in the opposite sense to that of the preceding ramp.

From ramp to ramp

1. Same direction; Same Rate  
The ramp continues to the new target SP at the same rate. Combined duration is the same as if unskipped.
2. Same direction; Second Rate higher than the first  
At Skip, the SP starts ramping at the new rate. Overall duration is less.
3. Same direction; Second Rate lower than the first  
At Skip, the SP starts ramping at the new rate. Overall duration might be greater.
4. Opposite directions.  
At Skip, the SP immediately changes ramp direction and it is likely that the previously programmed peak or trough will not be reached. It is also likely that the SP will reach the new target sooner than expected and in such a case, unless a further Skip is performed, the SP will dwell until the next segment starts.

##### From ramp to end (Starting values)

Not bumpless. Same effect as if the Program is aborted.

##### From ramp to complete (infinite dwell)

Not bumpless. Terminates the ramp and steps to the final target setpoint.

##### To ramp from any other type

1. Ramp-at-rate. Rate is maintained.
2. Time-to-target. Duration is maintained,

## 3.2 HOLDING AND ABORTING A PROGRAM

The Hold facility has two uses:

- 1 for Operators to halt a program when a problem arises in the process under control, and to hold the program at that point while attempts are made to fix the problem
- 2 for Engineers to make on-line changes to a running program.

This chapter is for Operators, and so the following deals with the first situation.

### 3.2.1 Holding a program

1. With a program running, and the full Programmer menu displayed (as at [step 8 in 3.1.1](#). Running a program), press HOLD.

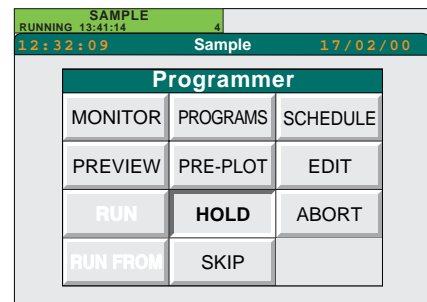

The Program pane changes to yellow and reports HELD.

The estimated time of completion starts incrementing in seconds.

Left of the page title is the current time. To view the time-into-program you should use the MONITOR facility ([section 3.3, below](#)).

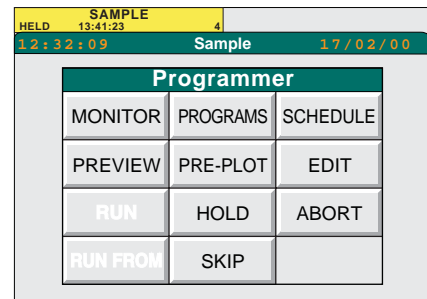

For most processes there will now be time available for solving the problem, before the pause itself starts causing new problems. The time available will depend upon the process. If the attempts to fix the problem are successful, the program is usually continued from that point using RUN (see [section 3.1.1](#) Running a program now). If the attempts are unsuccessful, the program is usually aborted, as described in 3.2.2 below.

### 3.2.2. Aborting a program

Starting from the end of 3.2.1. Holding a program, press ABORT.

The Program pane changes to white and reports IDLE.

The program is now idling, which means that it is still loaded in short-term memory but not being run. At this point the same program can be again from the start, or a new program run (see [section 3.1.1](#) Running a program now).

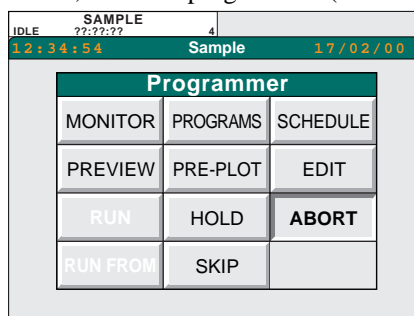

### 3.3 MONITORING A PROGRAM

There are two ways of monitoring a program as it's running:

1. Viewing a textual/numeric display, generated by the Monitor facility
2. Viewing a graphical display, generated by the Pre-plot facility.

MONITOR displays text and numeric information about the program, as a list.

PREPLOT displays a graphic profile of the target and actual process variables (PVs).

Generally, MONITOR is used when precise values are needed; PREPLOT is used to provide an overview.

#### 3.3.1 The monitor facility

With a program running and the Programmer menu displayed (step 8 in section 3.1.1 Running a program now), press MONITOR.

The Current Program page appears, displaying the following information about the program as it is running (most of the fields are self-explanatory):

##### PROGRAM

Name: Program name  
Status: Run, Hold, Held Back, Idle, Error, Complete.  
Duration: Running time, start to finish  
Completion: Time of completion of current run (assuming no interruptions)  
Iteration: Number of current run / number of runs requested.

##### SEGMENT

Name: Segment name (usually a number)  
Time Remaining: Time remaining to completion of the current segment (decrementing second by second).

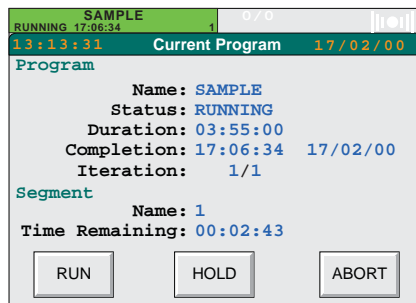

### 3.3.2 The preplot facility

#### STANDARD DISPLAY MODE

With the Programmer menu displayed and a program running (see [step 8](#) in [section 3.1.1](#). Running a program now), press PREPLOT.

A display appears, showing a profile of the target and the actual PVs moving slowly (perhaps imperceptibly) from right to left past a vertical cursor at the centre of the screen.

*Note: The trend resolution is such, that short duration events (in particular zero duration spikes), will not be visible.*

The cursor marks the current time.

The actual PVs, SPs and digital outputs are to the left of the cursor and the target SPs are to the right.

With the same program loaded but not running (Idle), the display shown opposite appears, showing the profiles programmed for the four variables.

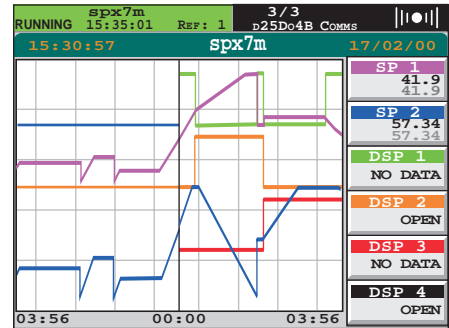

Figure 3.3.2a  
Preplot display - program running.

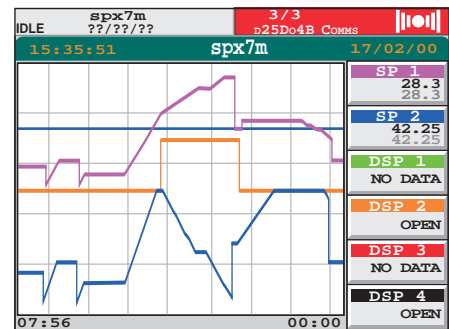

Figure 3.3.2b  
Preplot display - program idle

#### REVIEW MODE

Operation of the option key calls the Option bar, which contains two keys - VIEW and LIVE. Operation of the VIEW key, causes the page to re-draw, with zoom and pan controls as shown in figure 3.3.2c below. This screen contains only the program traces, not the target profile.

To enter Review Mode, allowing the history of the program to be traced, the pan/zoom controls are adjusted, or the trace is touched. Once in Review Mode, the traces on the screen are no longer updated. (This is purely a display function; the program continues to run as normal.)

To leave review mode, and return to the 'live' zoom/pan display, the LIVE key beneath the zoom slider, or the LIVE key in the option bar should be operated.

To return to the normal pre-plot display, the option bar 'VIEW' key should be operated.

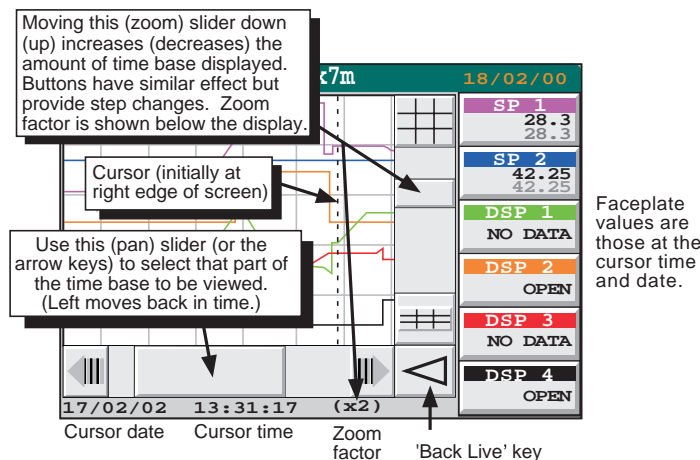

Figure 3.3.2c Review mode controls

## 3.4 LOGGING DATA

This section describes how incoming data can be logged (archived) to an archive device.

### 3.4.1 Types of files

The selection of file type (ASCII, Binary, UHH) is made in the Logging Groups window, described in section 4.2, below.

#### ASCII

This is a text file that is human-readable, and which can be imported into standard spreadsheets. Files of this type have extensions of the following type: .ASC, .AS1 to .AS9 or .A01 to .A99.

#### BINARY

This is a tamper-proof non human-readable format which can be interpreted only by the Review software package. Files of this type have extensions of the following type: .PKD, .PK1 to .PK9 or .P01 to .P99.

#### UHH

This format, available only with 'Enhanced' instruments is another non human-readable file format, which, wherever possible should be used in preference to the Binary format described above, as it is more efficient and allows more data to be extracted by Review software. Like the Binary format, UHH files can be interpreted only by Review software. UHH files have Sequence file names (see below) and the extension .UHH. If 'Hourly' or 'Daily' is selected, then new UHH sequence files are created at hour or day boundaries respectively.

### 3.4.2 Name types

The selection of name type (Text, Hourly, Daily, Sequence) is made in the Logging Groups window, described in section 4.2, later in this document.

#### TEXT

A Text file is a continuous file that starts when logging starts and stops when logging stops. The file must have an 8-character file name with the usual MS-DOS constraints; the instrument adds the file type suffix .asc or .pkd.

#### HOURLY

Hourly means that the instrument automatically parcels the archive into files of one-hour length. For the sequence of files that result, the user supplies the first two letters of the file name(s) and the instrument assigns the last six to indicate the time (month hour day) that the recording started for that particular file. For example, were 'Monday' to be typed-in, then a file name for an hourly-type file might be 'mo010323', which would mean that archive started at the beginning of hour 23 of day 3 of month 1.

#### DAILY

Daily is similar to Hourly. The instrument parcels the recording into files that start at the beginning of each day (midnight) and run for 24 hours. The user supplies the first four letters of the file set and the instrument supplies the last four (month day).

#### SEQUENCE

With Sequence filenames, only the first two characters are supplied by the user, the remainder of the file name being automatically appended by the instrument as a six digit number, starting at 000001. This number is incremented each time a new file of this form is created.

### 3.4.3 Floppy disk

Before logging starts, a floppy disk must be inserted. The floppy disk runs in the drive behind the flap on the front panel. To insert a disk, the bottom of the tab in the centre of the flap is pulled outwards. When it clicks open, the flap can be rotated downward from the top.

Insert the disk, close the flap, secure it by hooking the top of the tab under the lip of the casing, and press the bottom of the tab shut.

To ensure maximum integrity of data, the following rules, regarding the use of floppy disks for logging data, should be observed:

1. Only new, formatted floppy disks may be used for logging
2. Disks used for logging should not be used for recording other types of data.
3. Replace floppy disks after one month.
4. Floppy disks must never be ejected whilst logging is in progress
5. Always terminate logging by using the OFF-LINE facility (see MONITOR, below).
6. Folders (directories) must never be placed on disks.

### 3.4.4 Training sequence

This section describes how to start recording, view the contents of the disk, stop recording, change the disk, and start recording again.

1. Press the Menu key below the screen. The Pop-up menu appears.
2. Press LOGGING  
(The instrument can be configured to start logging immediately at this point, but if that has not been done, the MONITOR page needs to be accessed as described below).

The Logging menu appears, with four choices: MONITOR, OFF-LINE, MANAGE, and GROUPS.

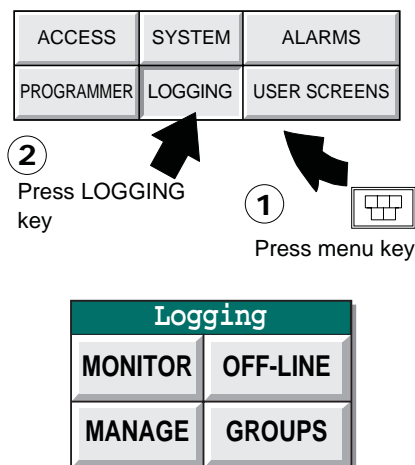



### 3.4.4 TRAINING SEQUENCE (Cont.)

#### MONITOR

Allows the user to start and stop logging, and to determine how much space is left on the disk. The 'Files' field shows the number of files present on the archive device, against the maximum number permitted. If the number of files present exceeds the maximum, this represents a disk full condition which will invoke any deletion strategy configured in the LOGDEV block.

Note: For internal archives, file size is limited to either 1/32 of the size of the internal archive, or to 1 MB, whichever is the smaller.

#### OFF-LINE

Used exclusively to stop recording, usually to change a disk.

#### MANAGE

Used to delete files from the disk. For internal archives, Manage also is used to export files to a removable device. See section 3.4.4 below.

#### GROUPS

Allows the user to set up the instrument to log groups of data. Operators can view Groups data, but not change it. For more information turn to Chapter 4, section 4.2, Logging groups of data.

3. To start logging or to view the contents of the disk, press MONITOR. The Logging Monitor page appears, displaying disk information.
4. To start logging, press 'OFF' in the Logging field. A pick-list appears, allowing 'OFF', 'ON' or 'On Event' to be selected. 'ON' followed by 'return' causes archiving to start
5. To stop logging temporarily in order to change a disk, press OFFLINE. The Logging Off-line page appears. For about five seconds it shows 'Disk: Active', indicating that the instrument is still recording. 'Active' then changes to 'Flushing', indicating that data is being flushed from RAM to the disk. Finally 'Flushing' changes to 'Off-line', confirming that the disk is now off-line (not recording).
6. Remove the disk and insert a new one.
7. To re-start recording, press MONITOR. Recording resumes immediately and the Logging Monitor page reappears
8. To stop logging permanently in this session, press 'ON' in the Logging field and select 'OFF' from the pick list, followed by 'Enter'.

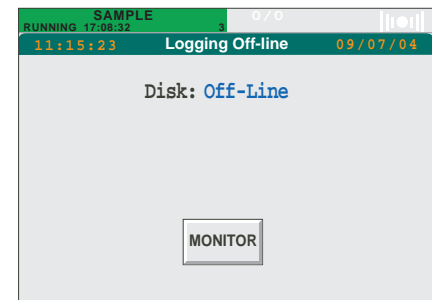
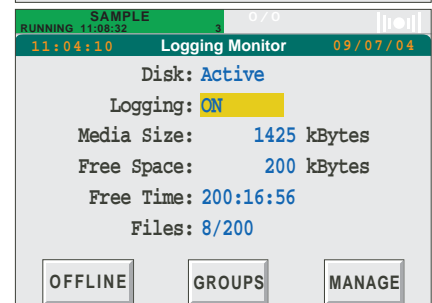
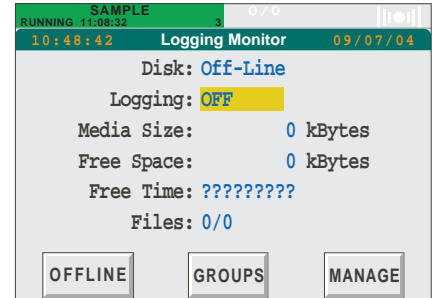

### 3.4.5 The Manage facility

The MANAGE facility allows deletion of files from the disk. For internal archive devices, it also allows the export of files to a removable storage device.

Example: From the Logging Monitor page it is clear that the disk is getting full but all the data from this run is required to be contained on one disk, and it is not desirable to change disk in mid-run. The MANAGE facility is used to delete enough unwanted files (usually the oldest ones) to make space for the remainder of the run, as follows:

- From the Logging Monitor page, press MANAGE.  
After a short delay, the Archive Manage page appears, displaying information about the file currently recording:  
File Type: ASCII or PACKED.  
File Name: In the format: 8-char name.typ. For example, 'as010323.asc'  
File Size: Number of kBytes.  
Media Size: Capacity of the disk (1.44MB)  
Free Space: kBytes of free space left  
Free Time: hh:mm:ss.

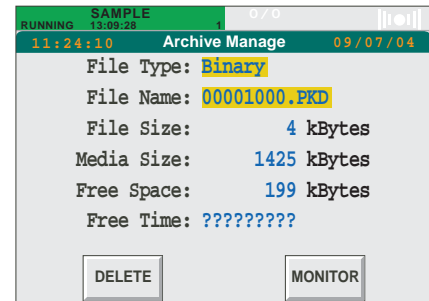

- To return to the Logging Monitor page, press the MONITOR key.
- To select a file to delete, press the yellowed File Name field.
- On the left of the screen a pick-list of file names appears. Files currently open for logging do not appear.
- Select the file to be deleted.
- Press the Return key.
- The pick-list disappears and the Archive Manage page shows the selected file name. Press DELETE.

The file is deleted.

To return to the Logging Monitor page, press the MONITOR key.

### 3.4.5 THE MANAGE FACILITY (Cont.)

#### ARCHIVE EXPORT

The ability to export files to a removable device, such as a floppy disk or 'Memory stick' is provided from the 'Archive Manage' page. Export device 'A' is the floppy disk; Export device 'B' is the USB Bulk Storage Device (Memory stick). Exported (copied) files are not deleted from the internal archive.

Export	This pushbutton causes the currently displayed file to be copied to the floppy disk or USB device, as selected.
Export all	This pushbutton causes all files in the internal archive to be copied to the floppy disk or USB device. If the device becomes full during archive, a message appears asking the user to fit a new disk.

If a file to be exported has the same name as one already on the storage device, the following occurs:

- If the file is identical, the file will not be exported, but be marked as 'skipped'.
- If the new file is longer than the one on the storage device, but has the same initial data, it will be exported to replace the existing file.
- If neither a. nor b. are true, the user is prompted for a decision.

During export, the screen is normally 'locked' to the Archive Manage page. Setting 'Page Locked' to 'No', causes normal screen navigation to be restored, with the export continuing as a background task. Once export is complete a message appears to tell the user that the disk may be removed. Any other export messages also appear at the user's current display page.

The user may return to the Archive manage page at any time.

---

Note: The large frame unit displays an 'archiving in progress' icon at the top of the screen. The icon consists of a disk shape with an inward pointing arrow to the left. The arrow, and the upper central portion of the disk shape, flash green during export.



---

### 3.4.6 Data integrity

Although the Visual Supervisor is designed to maintain logged data in a secure manner in the event of sudden loss of power, it is not always possible to guarantee that no data will be lost, or that any data record currently being written will be complete.

Such problems will be minimised if logging is stopped prior to a controlled power down. Logging can be stopped by turning logging off in LOGGING/MONITOR or by using the STOP button in SYSTEM/APPLN/APP MGR.

### 3.5 ALARMS / MESSAGE RESPONSE

Section 2.6, above, describes the alarm pane and the way in which it is used by the instrument to annunciate alarm, event and message occurrence. The sections below describe the alarm history page, and how to acknowledge alarms, events and messages.

#### TIME REPRESENTATION

If time synchronisation is configured, then the date and time of a cached block are the date and time of alarm/event occurrence at the originating block, and are displayed as DD/MM HH:MM. If it is not certain that the original block's instrument has its own clock synchronised, then the date and time of detection of the alarm or event will be used, and these are displayed as DD\*MM HH\*MM.

#### 3.5.1 Alarm history page

To display the alarm history page, either

1. Press the Menu key below the screen, then press ALARMS in the pop-up menu , or
2. Press the Alarm pane

The Alarms menu appears. The name of the current alarm condition is displayed in the Alarm pane.

3. Press HISTORY

The Alarm History page, depicted in figure 3.5.1a, below, appears.

ACCESS	SYSTEM	ALARMS
OVERVIEW	PROGRAMMER	RECIPE
BATCH	LOGGING	

Alarms		
ACK	ACK ALL	HISTORY
SUMMARY	LOG	NOTE
ARCHIVE	MESSAGES	

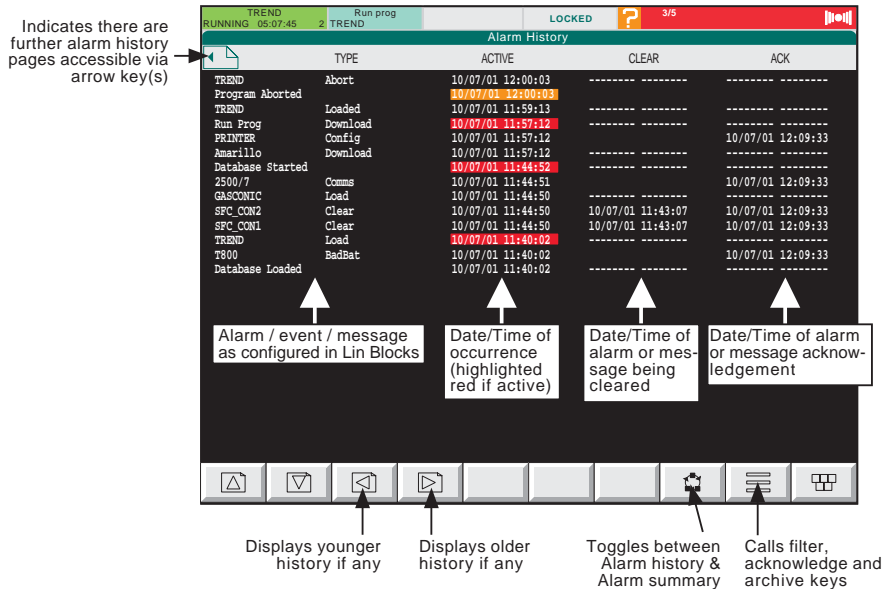

Figure 3.5.1a alarm history display (SVGA version)to log (archive)

Information is arranged in a number of columns as shown above. (The figure shows the SGVA version; the 1/4VGA version is similar but does not have the 'Ack' column or the 'Cycle screens' key.) The CLEAR and ACK columns contain one of the following:

1. Dashed lines (for events - defined as one-off occurrences which, by their nature are not 'Clearable').
2. Blank paces (for alarms or messages that are still active).
3. Time and date (showing when the item ceased to be active or was acknowledged).

### 3.5.1 ALARM HISTORY DISPLAY (Cont.)

For brevity, ‘Alarms’, ‘Events’ and ‘Messages’ are all referred to as ‘events’ in the following description.

As can be seen from figure 3.5.1 above, the alarm history displays a list of events that have occurred since the data-base was loaded\*, giving the date and time of occurrence, and where appropriate, the time of clearing and (for SVGA units only) time of acknowledgement. Where more ‘events’ have occurred than can be displayed on one page, a ‘page turn’ symbol appears at the top left of the page. Table 3.5.1, below, shows the various symbols which can appear.

\*Note: For a ‘standard’ instrument, 250 ‘events’ can be listed before new events cause the oldest events to be discarded. For the enhanced version of the instrument, this limit is 500 ‘events’.

	Use right arrow key to view earlier events
	Use right arrow key to view earlier events or left arrow key to view later events
	Use left arrow key to view later events

Table 3.5.1 Page turn symbol interpretation

It is possible to limit (filter) the display of ‘events’ in a number of ways, so that only those items of current interest are included in the list. To achieve this, the ‘Option’ key at the bottom of the display is pressed, to cause the option bar to be displayed (figure 3.5.1b). This contains not only ‘filter’ keys, but also ARCHIVE and ACK(nowledge) keys.

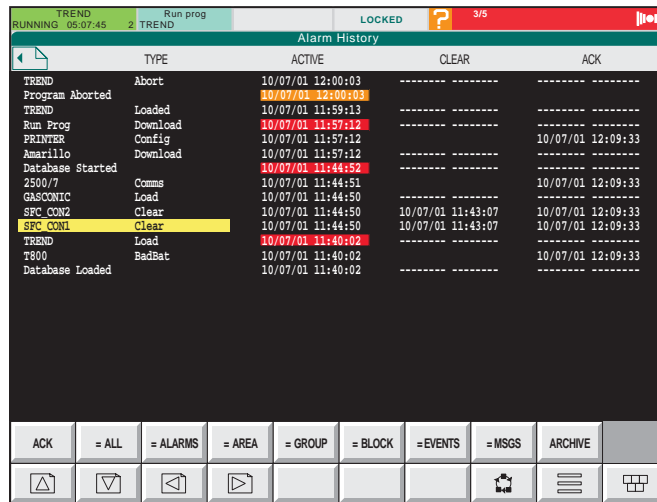

Figure 3.5.1b Alarm history display with option bar.

### TWO LINE DISPLAY

As described in section 2.6.2, above, operating the down arrow key toggles between single line working, (e.g. as shown in figure 3.5.1, above), and two line working where the second line is used to display the operator ID of the user who was logged on at the time of the alarm. See figure 2.6.2c for an example.

### FILTER KEYS

- ALL Displays all Alarms and Events.
- = ALARMS Displays only Alarms.
- = EVENTS Displays only Events.
- = AREA If an Alarm name is touched (highlights yellow), then pressing =AREA causes only those alarms configured to be in the same ‘Area’ as the highlighted alarm to be displayed.
- = GROUP As for =AREA, but for Group.
- = BLOCK As for =AREA, but for function block.
- = MSGS Displays only messages

### 3.5.1 ALARM HISTORY DISPLAY (Cont.)

#### ACK KEY

Pressing this key acknowledges (after confirmation) all current, unacknowledged (i.e. flashing) alarms. Touching an alarm name (highlights yellow) before pressing ACK, causes just that alarm to be acknowledged.

#### ARCHIVE

Allows the alarm history to be archived to disk as described in section 3.5.4 below.

### 3.5.2 Alarm/Message Acknowledgement

#### ALARMS

Alarms can be acknowledged the following ways:

1. Press the Menu key below the screen. In the pop-up menu which appears, press 'ALARMS', then press ACK to acknowledge the displayed alarm, or 'ACK ALL' to acknowledge all current unacknowledged alarms.
2. Press the Alarm Pane. In the pop-up menu which appears press ACK to acknowledge the displayed alarm, or 'ACK ALL' to acknowledge all current unacknowledged alarms.
3. From the option bar in the Alarm History page (Section 3.5.1) or the Alarm summary page (section 3.5.5), press the ACK key.

#### MESSAGES

Some messages are cleared by the system itself without operator intervention. In such cases, entries appear in the Alarm history page CLEAR column, but not in the acknowledge column (large frame units only). All message indication stops.

For other messages, touching the alarm pane, or operating the Menu/Alarms/Messages key displays the latest message in a pop-up window. Subsequent operation of the OK button for this window, both clears and acknowledges the message.

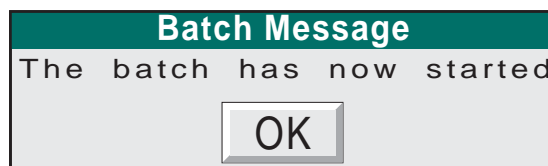

### 3.5.3. Adding notes to alarm history

The NOTE facility allows an operator-defined text message to be added to the alarm history as follows:

In the Alarms menu press NOTE

The Add Note window appears.

To enter the note, press the yellowed field, then key in a string of (max.) 16 characters at the pop-up keyboard, followed by 'Enter'.

To abandon the note before completion, press CANCEL.

When the message is complete, press OK. The note is added to the alarm history, where it is displayed along with its time of entry.

Alarms		
ACK	ACK ALL	HISTORY
SUMMARY	LOG	NOTE
ARCHIVE	MESSAGES	

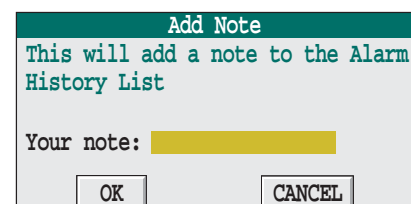

### 3.5.4 Alarm history archive

The ARCHIVE facility permits the current alarm history to be saved in ASCII format to floppy disk.

Note: In order to avoid the possibility of loss of logging data it is strongly recommended that archiving is performed with normal logging turned off.

1. In the Alarms menu, press ARCHIVE

The Alarm Archive window appears.

The File Name field shows the default of YYMMDDHH.ALH, which the instrument supplies automatically. To change this name, press the field to get the keyboard display, and enter a new name.

The file extension is always .ALH, (not editable).

2. To abandon the name before completion, press CANCEL.
3. When the correct name has been entered, press OK.

If required the 'Date Format' field can be edited in a similar fashion.

The format options (Date Time, Spreadsheet and Integer) are described in sections 4.2.1 and 4.5.4.

Alarms		
ACK	ACK ALL	HISTORY
SUMMARY	LOG	NOTE
ARCHIVE	MESSAGES	

Alarm Archive	
Archive to disk the alarm history	
File Name:	99072009.ALH
Date Format:	Date Time
<input type="button" value="OK"/> <input type="button" value="CANCEL"/>	

### 3.5.5 Alarm summary page

This provides an alternative way of displaying only those alarms which are currently active (acknowledged or not) and previously active alarms which are now cleared but which have not been acknowledged.

To display the alarm summary page, either press the SUMMARY key in the Alarm menu, or, for SVGA units only, the cycle screens key can be used to toggle between Alarm History and Alarm Summary display pages.

Operating the Option key calls an option bar like that described in [section 3.5.1](#) for the alarm history display, except that it includes only ACK, ALL, AREA, BLOCK and GROUP keys.

Alarms		
ACK	ACK ALL	HISTORY
SUMMARY	LOG	NOTE
ARCHIVE	MESSAGES	

13:54:05		Alarm Summary		14/02/00	
TYPE	ACTIVE	CLEAR			
T800	BadBat	14/02/99 08:13:21			
2500/7	Comms	14/02/99 08:13:21			

Figure 3.5.5 Alarm summary access

Note: Initially, the display shows only the highest priority alarm in each block. Operation of the down arrow key at the bottom of the screen causes the display to change such that it shows all alarms. A further operation of the keys returns to the single alarm/block display, and so on.

### 3.5.6 Event Log

The event log page is accessed either a) by operating the 'Log' key in the alarm menu, or b) by operating the EVT LOG key in the root menu (only with no application loaded). The page displays the alarms and events that have been output to trend displays, printers or log files. This data is lost on power cycling.

Alarms		
ACK	ACK ALL	HISTORY
SUMMARY	LOG	NOTE
ARCHIVE	MESSAGES	

16:14:23		Event Log		30/10/02	
30/10	16:00	ACTIVE	Shift	DigA15	
30/10	14:30		TREND	Abort	
30/10	14:20		TREND	Finish	
30/10	14:19		TREND	Skip	
30/10	14:17		TREND	Resume	
30/10	14:16		TREND	Held	
30/10	14:16		TREND	Skip	
30/10	14:12		TREND	Skip	
30/10	14:11		TREND	Resume	
30/10	14:10		TREND	Held	
30/10	14:08		TREND	Skip	

Figure 3.5.6 Event log display - single line display mode

#### TWO LINE DISPLAY

The down arrow key can be used to toggle between single line and two line display. The two line display adds a second line to each event, used to display text that would not fit onto the single line display.



## 3.6 AREA AND GROUP DISPLAYS

### 3.6.1 Overview

As a part of configuration (Lintools), an 'area' page can be defined which can contain up to sixteen 'groups'. Each group can contain up to 16 points, where each point represents a function block. The area page contains group 'faceplates' which, when any one is touched displays that group's first six point faceplates. For the 1/4VGA unit, if there are more than six points in the group, a slider control appears at the right side of the display to allow access to hidden points. To return to the area display, the up-arrow key is pressed.

If a point faceplate is touched a 'close-up' of the faceplate appears giving further information about the point, the nature of this extra information depending on the type of faceplate.

To return to the group display, the up arrow key can be used. To return to the area display, the up arrow key can be used twice, or the menu key can be pressed, followed by 'Overview'.

---

**Note:** If only one group is configured, the area page does not appear.

---

To access the area page, the menu key is pressed, followed by operation of the 'Overview' key as shown in figure 3.6.1a.

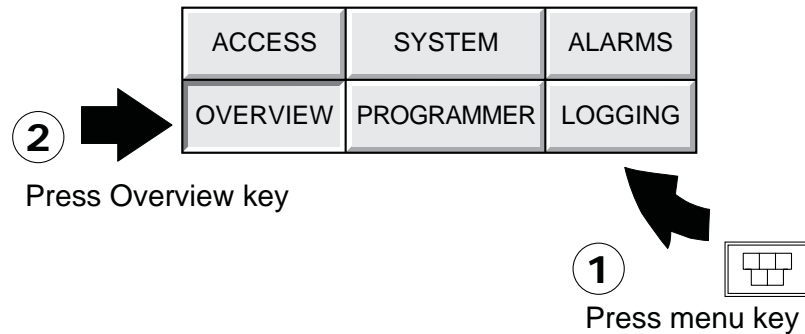

Figure 3.6.1a Access to 'area' page.

Figure 3.6.1b shows typical area, group and point displays. A selection of typical point displays is given in section 3.6.2 below.

### TREND DISPLAYS

Operation of the down arrow key (or cycle screens key for SVGA units), whilst in group display mode, calls one of up to four trend displays - Horizontal, Vertical, Full width horizontal, Full width vertical. In each case, it is possible to enter review mode, allowing historical data to be viewed. [Section 3.6.3](#), below gives more details.

### ALARM INDICATION

Alarm annunciators take a variety of forms, and cover different groups of points or function blocks, but all operate the same 'protocol' as follows:

Indicator colour	Definition
Unfilled	No active alarm.
Black	There was an active alarm which returned to its non-active state before it was acknowledged.
Steady red	There is an active alarm that has been acknowledged.
Flashing red	There is an active alarm that has not been acknowledged.

For more details of alarms including acknowledgement see the preceding section ([Section 3.5](#)) of this chapter.

3.6.1 OVERVIEW (Cont.)

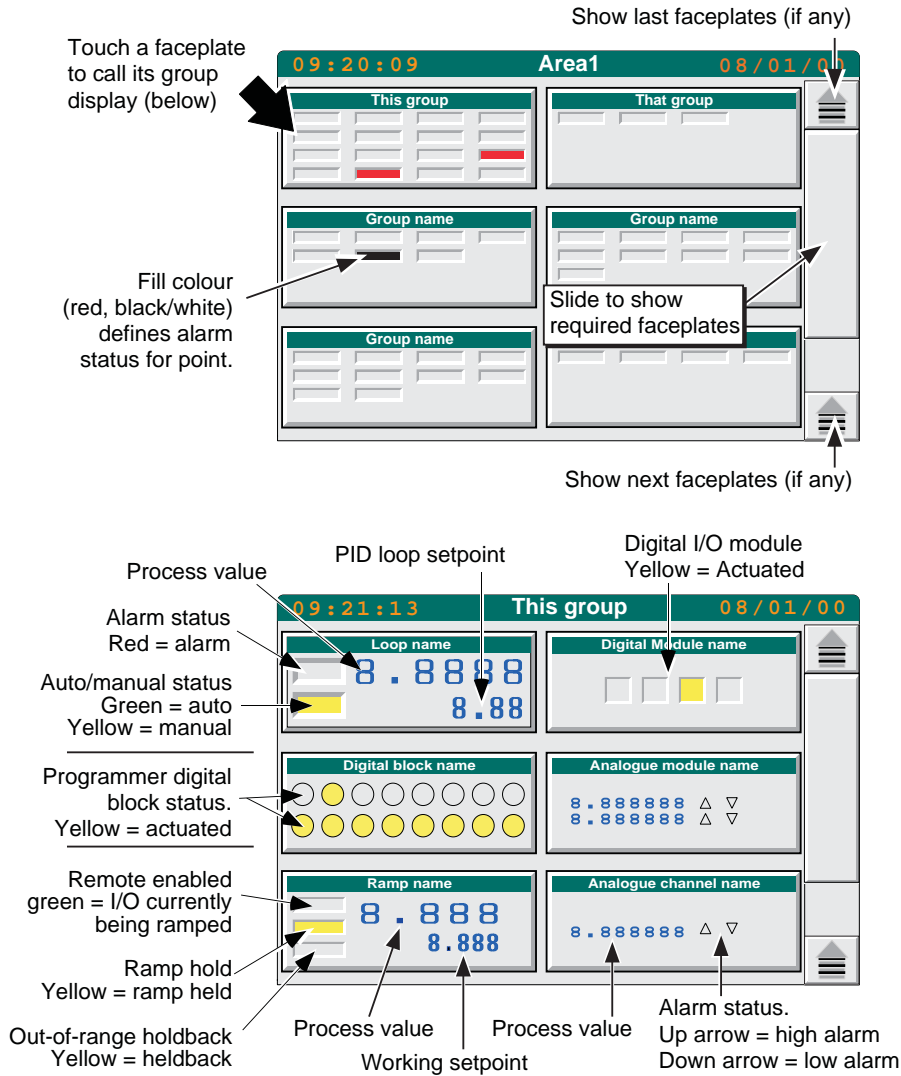

Figure 3.6.1b Typical area and group displays

Note: The vertical sliders/push-buttons appear only for 1/4VGA unit displays

### 3.6.2 Function block faceplates

The following section shows typical function block faceplates, called to the display by touching the relevant faceplate in the group display (figure 3.6.1b, above).

#### TWO-CHANNEL ANALOGUE INPUT (AI2) MODULE

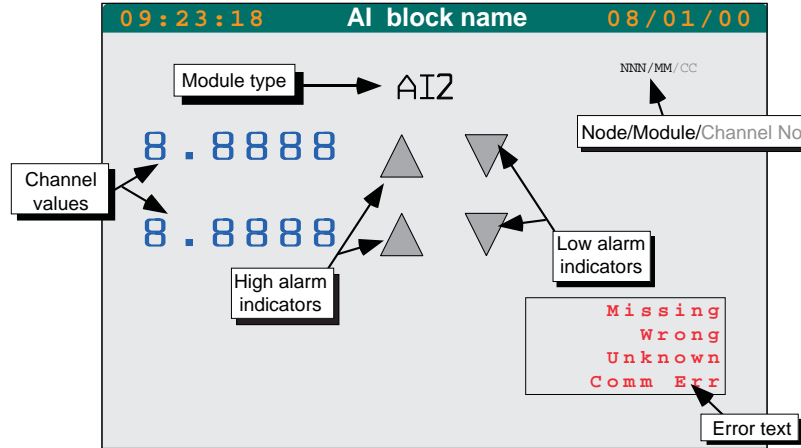

Figure 3.6.2a AI2 module faceplate

Module type	Displays the type of module fitted, in this case a two-channel analogue input board (AI2). Three (AI3) and four (AI4) input modules are also available.	
Node/Module/Channel	Shows the system address (node number) of the I/O unit and the slot number of the module (For example if the I/O unit has a system address (node number) of 2, and this is the module in slot 3, then this display will be 2/03.) Should this be a single channel display, then /1 or /2 would be appended at the end to show which channel this is within the module (e.g. 2/03/2).	
Channel values	Shows the last known process values associated with the input channels being displayed.	
Alarm indicators	One high and one low indicator per channel, acting as described in <a href="#">Section 3.6.1</a> above.	
Error text	Missing	I/O module not detected
	Wrong	The I/O module is not of the correct type
	Unknown	The module type is not recognised
	Comm Err	There is a communications problem within the I/O unit.

#### ANALOGUE OUTPUT MODULES

As AI2 above, except the module type is AO2, and there are no alarm indicators. Analogue output modules are available only as two channel units.

3.6.2 FUNCTION BLOCK FACEPLATES (Cont.)

DIGITAL INPUT MODULES

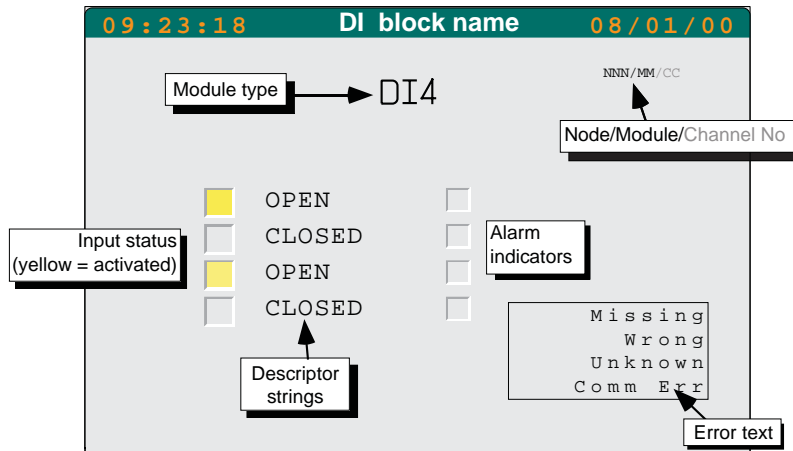

Figure 3.6.2b DI4 module faceplate

Module type	Displays the type of module fitted, in this case a four-channel digital input unit (DI4). Six (DI6) and eight (DI8) input modules are also available.	
Node/Module/Channel	Shows the system address (node number) of the I/O unit and the slot number of the module (For example if the I/O unit has a system address (node number) of 5, and this is the module in slot 11, then this display will read 5/11.) Should this be a single channel display, then /1 to /4 (or /8) would be appended at the end to show which channel this is within the module (e.g. 5/11/3 for channel 3).	
Input status	Shows whether each input is active (filled yellow) or not active (unfilled).	
Descriptor text	Eight-character strings describing active and non-active states of the inputs	
Alarm indicators	One indicator per channel, acting as described in section 3.6.1.1 above.	
Error text	Missing	I/O module not detected
	Wrong	The I/O module is not of the correct type
	Unknown	The module type is not recognised
	Comm Err	There is a communications problem within the I/O unit.

DIGITAL OUTPUT MODULES

As for DI4 above, except the module type is DO4, and there are no alarm indicators. Digital output modules are available only as four channel units.

3.6.2 FUNCTION BLOCK FACEPLATES (Cont.)

RAMP FACEPLATES

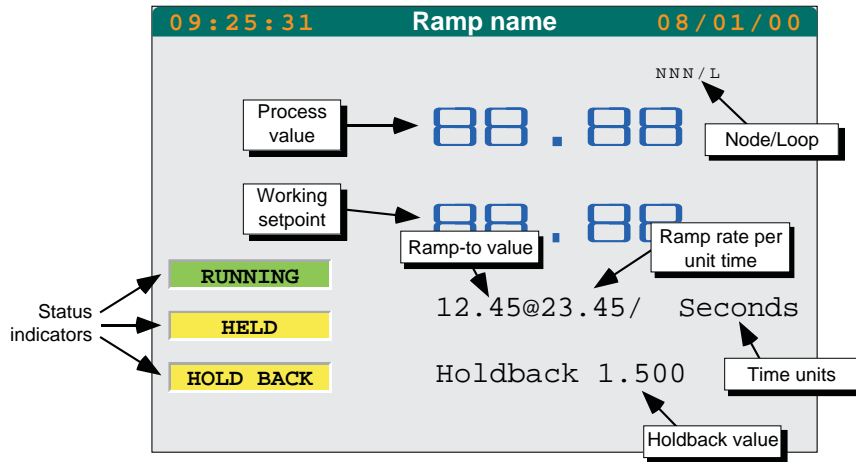

Figure 3.6.2c Ramp faceplate

Node/Loop	Shows the system address (node number) of the I/O unit and the ramp number.
Process value	Shows the last known process value associated with the ramp
Working setpoint	Shows the last known working setpoint value associated with the ramp.
Status indicators	<p><b>RUNNING</b> Shows that the associated I/O channel is being ramped. Filled green when active, otherwise unfilled, with no text .</p> <p><b>HELD</b> When filled (yellow), this shows that the ramp demand is held to allow the process to 'catch up'; otherwise unfilled, with no text .</p> <p><b>HOLDBACK</b> When filled (yellow), this shows that the holdback value has been exceeded; otherwise unfilled, with no text .</p>
Ramp-to value	Shows the value to which the process variable is to ramp.
Ramp rate per unit time	Shows how quickly the ramping is to take place, in the time units defined (seconds in this case).
Time units	Shows the time units set for the ramp rate.
Holdback value	The 'safe' band (associated with this ramp), within which the process value may fall, without triggering a holdback.

## 3.6.2 FUNCTION BLOCK FACEPLATES (Cont.)

## LOOP FACEPLATES

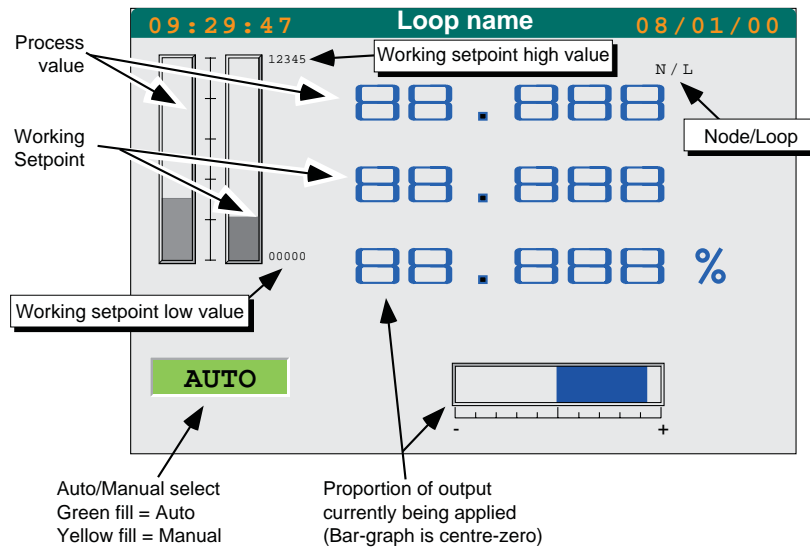

Figure 3.6.2d Loop faceplate

Node/Loop	Shows the system address (node number) of the I/O unit and the ramp number.
Process value	Shows the last known process value associated with the loop
Working setpoint	Shows the last known working setpoint value associated with the loop.
Working setpoint high (low) values	Indicates the limits of working setpoint range,
Auto.manual select	If the permission access allows it, the mode can be changed from AUTO to MANUAL using this key and associated pop-up menu. AUTO text appears on a green fill; MANUAL appears on a yellow fill.
Output percentage	Shows the current percentage of full scale of the output. Output can be bi-polar giving (for example) a positive value for a heating cycle and a negative value for a cooling cycle.

### 3.6.2 FUNCTION BLOCK FACEPLATES (Cont.)

#### PID FACEPLATES

Displays a process style faceplate for PID, PID\_LINK and PID\_CONN function blocks.

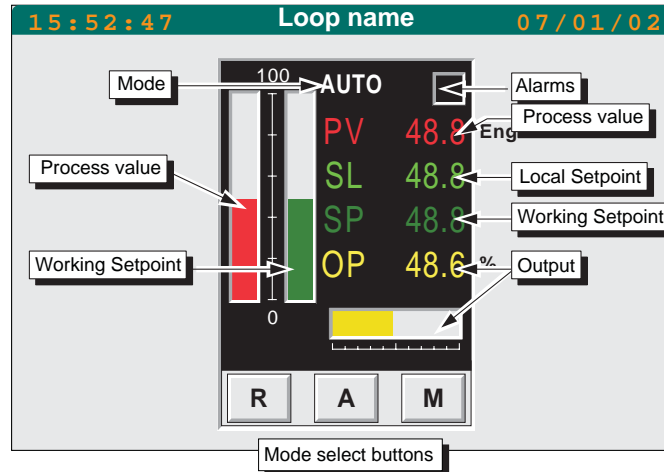

Figure 3.6.2e PID faceplate

Process value	Shows the last known process value associated with the loop
Working setpoint	Shows the last known working setpoint value associated with the loop.
Local setpoint	Shows the last known value for the local setpoint value associated with the loop.
Output percentage	Shows the current percentage (0 to 100%) of full scale of the output.
Mode	Shows the current mode (Auto, Manual or Remote)
Alarm	The alarm beacon is red if the block is in alarm. The beacon is continuously red if the alarm has been acknowledged, or flashes if unacknowledged.
Mode select	These buttons allow the mode to be selected as 'R' (Remote), 'A' (Auto) or 'M' (Manual).

### 3.6.3 Display modes

Group data can be displayed in a number of formats, as listed below. When a group is touched, in the [area display](#) (section 3.6.1 above), it will appear in the format last used. Other modes are scrolled-to by means of the down arrow key. The display modes are described below in the order in which they appear after a power up. This order is:

1. User screen (if one has been set up) (not described here)
2. Faceplate display
3. [Numeric](#)
4. [Vertical bargraph](#)
5. [Horizontal bargraph](#)
6. [Vertical trend with point faceplates](#)
7. [Vertical trend - full width - without faceplates](#)
8. [Horizontal trend with point faceplates](#)
9. [Horizontal trend - full width - without faceplates](#)

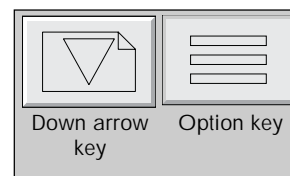

Each of the above-mentioned displays supplies a real-time display of point data. By using the option key, then 'VIEW', trend displays become trace-history displays. In such displays, real-time trending stops (although it is still held in the database for later display), and using various control sliders, the history of the traces can be displayed at a selectable magnification.

### 3.6.3 DISPLAY MODES (Cont.)

#### FACEPLATE DISPLAY

This display shows the contents of the group as what are called ‘faceplates’. This particular display is fully described in the Overview (section 3.6.1 above). To scroll to the next display mode, touch the down arrow key or (for SVGA units only), the Cycle Screens key.

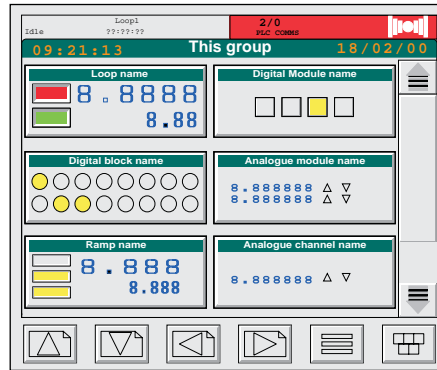

Use down arrow to change view

Figure 3.6.3a Faceplate display mode

#### NUMERIC DISPLAY

This shows point values as seven segment displays, with faceplates.

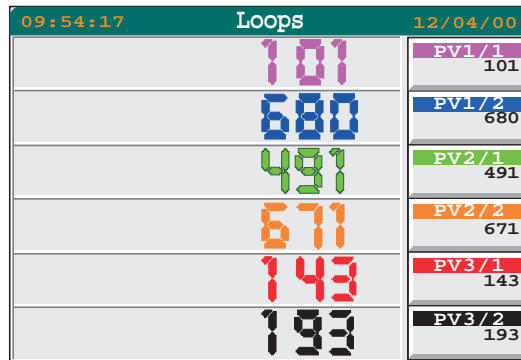

Figure 3.6.3b Numeric display mode

#### VERTICAL BARGRAPH

This mode shows the current point values as vertical bars with faceplates. The height of each bar is proportional to the current value of its associated point. Zero and full scale values appear to the left of the bars.

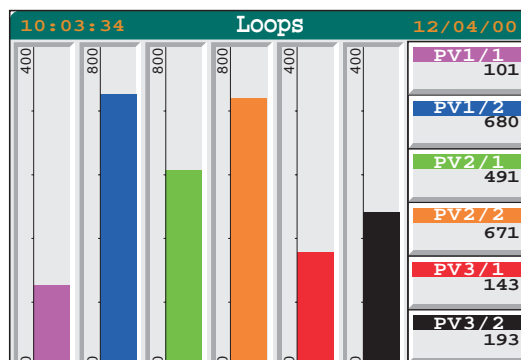

Figure 3.6.3c Vertical bargraph display mode



### 3.6.3 DISPLAY MODES (Cont.)

#### HORIZONTAL BARGRAPH

This mode shows the current point values as horizontal bars with faceplates. The length of each bar is proportional to the current value of its associated point. Zero and full scale values appear below the bars.

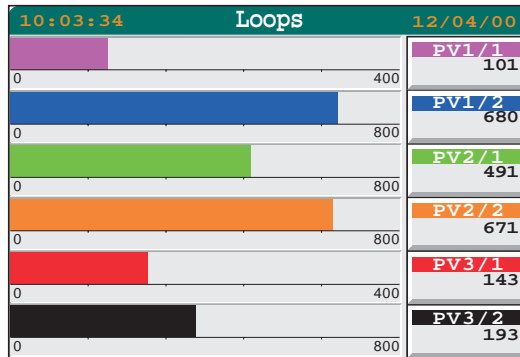

Figure 3.6.3d Horizontal bargraph display mode

#### VERTICAL TREND WITH FACEPLATE

##### Standard display

This view displays points as though they are being traced on a chart which is rolling downwards. The latest data is at the top of the display, and the extent of the data shown on the screen is displayed, at the bottom left of the screen, in hours and minutes.

For 1/4 VGA (SVGA) displays Only the faceplates associated with the first six (16) group items can be displayed. Where there are more than six (16) trends, these are plotted without faceplate. As a part of the group's configuration, it is possible to re-order the group contents to define which faceplates are displayed.

The colour bar at the top of each faceplate is that of its associated trend.

##### Scroll bar display

An alternative view can be obtained by pressing the option key to display the options bar, then pressing 'VIEW'. This calls the scroll bar display shown in figure 3.6.3f below. If no further action is taken, trend data will continue to update normally.

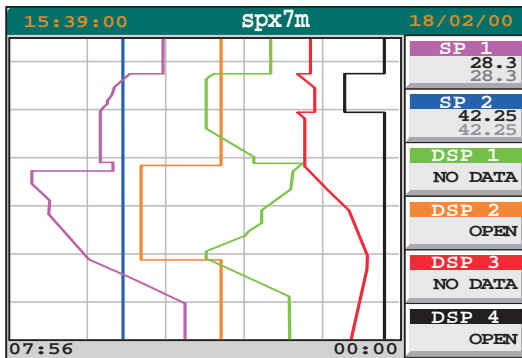

Figure 3.6.3e Vertical trend with faceplates

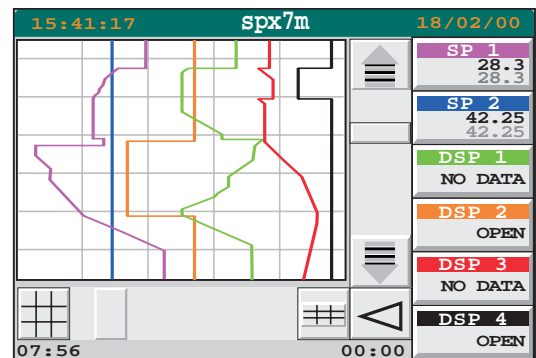

Figure 3.6.3f Vertical trend with scroll bars

### 3.6.3 DISPLAY MODES (Cont.)

#### VERTICAL TREND WITH FACEPLATE (Cont.)

##### Review mode

It is possible to enter review (trace history) mode by

- Touching the screen in either the Standard or the scroll bar displays described above or the full-width display described below.
- Using the slider or push-button controls in the scroll bar display
- Touching the slide area between the slider and a push button.

Although data is still read and stored in 'trace history' by the instrument, the traces remain static on the screen (unless the 'zoom' or 'pan' controls are used).

The Option/Live keys or the 'Back Live' key are used to return to the standard/scroll bar display

- CURSOR** On entry to review mode a cursor is located at the top of the screen. The cursor is repositioned either by touching it a dragging it to the position required, or by touching the screen at the desired point (or a combination of both), The exact temporal position of the cursor is shown at the bottom of the screen, and the values shown in the faceplates are those at the cursor time and date.
- ZOOM** These controls allow the amount of data displayed on the screen to be varied, either continuously, using the slider, or in steps (using the keys). The expansion/contraction of the trends is centred on the cursor position.
- PAN** These controls allow a particular section of the trend history to be selected for display. The length of this displayed section is determined by the zoom setting.

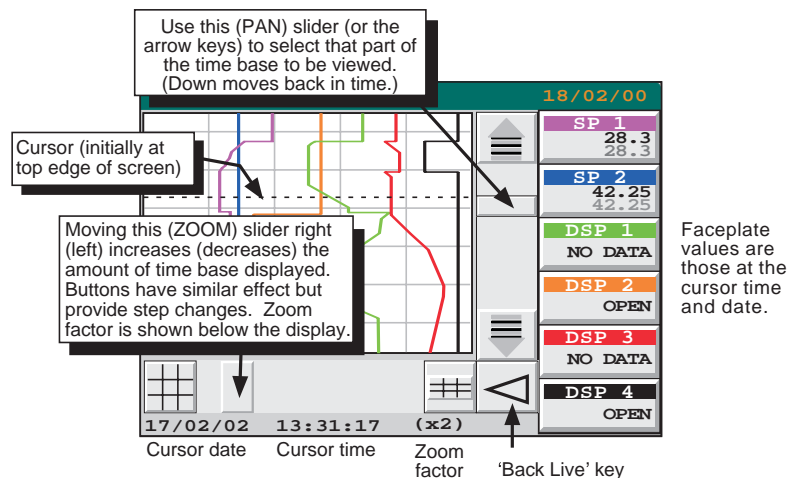

Figure 3.6.3g Trend review controls

### 3.6.3 DISPLAY MODES (Cont.)

#### VERTICAL TREND - FULL WIDTH

This view fills the width of the screen, with no faceplates displayed. Review mode is as described above.

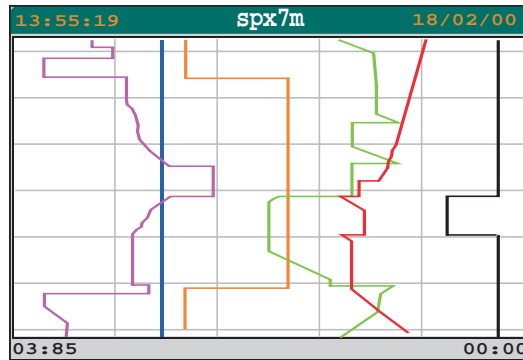

Figure 3.6.3h Vertical full width display mode

#### HORIZONTAL TREND WITH FACEPLATE

The horizontal trend displays are similar to the vertical trend displays. The main difference (apart from the length of data displayed and that the traces move from right to left) is the swapping of the Pan and Zoom control locations in Trend review mode.

Latest data is the right hand edge of the screen

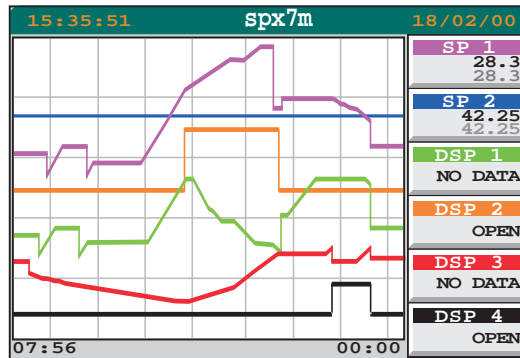

Figure 3.6.3j Horizontal trend with faceplates

### 3.6.3 DISPLAY MODES (Cont.)

#### HRIZONTAL TREND WITH FACEPLATE (Cont.)

##### Review mode

The section describing ‘Vertical trend with faceplate’, above, gives full details of review mode.

The Cursor appears at the right hand edge of the screen for horizontal traces.

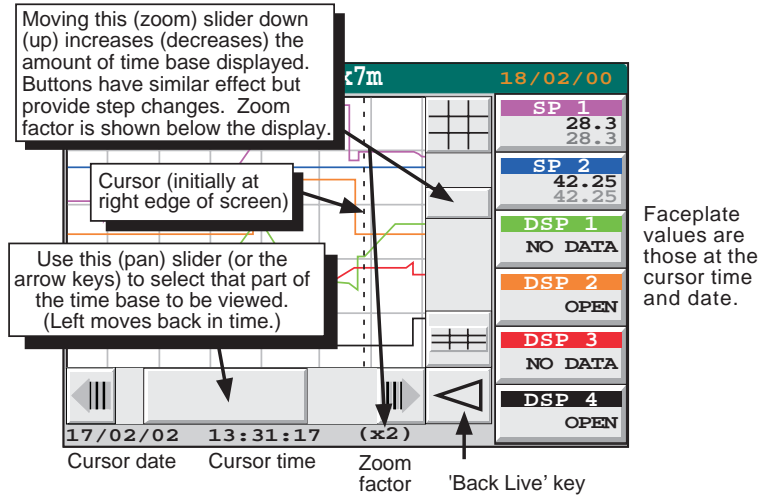

Figure 3.6.3k Trend review controls

#### HORIZONTAL TREND - FULL WIDTH

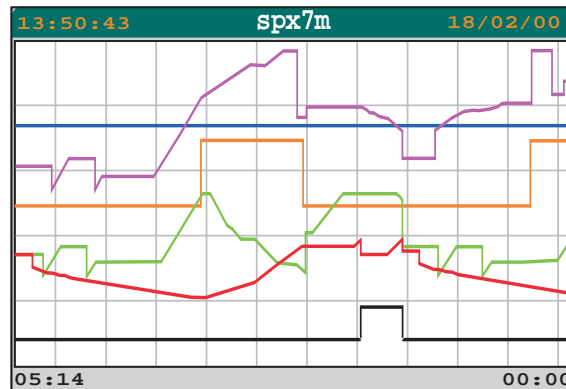

Figure 3.6.3m Horizontal full width

### 3.7 DOWNLOADING RECIPES

A recipe set consists of sets of instructions (recipes) for controlling between one and eight identical production facilities. The examples below use paint mixers as an illustration of the four types of recipe available.

1. The simple recipe. This file contains references to a single set of equipment and a single set of values to be applied to the equipment (e.g. orange paint)
2. The multi-recipe. This file contains references to a single set of equipment and multiple sets of values to be applied to that equipment (e.g. orange, purple and brown paint.)
3. A multi-line recipe. This file contains a single set of values that may be applied, simultaneously, to up to four sets of equipment (e.g. orange paint to line 1, orange paint to line 2, orange paint to line 3.)
4. A multi-line, multi-recipe. This file contains multiple values that may be applied, simultaneously, to up to four sets of equipment. (e.g. orange paint to line 1, purple paint to line 2, brown paint to line 3, green paint to line 4.)

Figure 3.7a shows a simplistic view of example 4, and figure 3.7b, a sample recipe page.

**Notes:**

- 1 In cases 1 and 2 above, there is only a single line, so references to 'lines' do not appear in the user interface.
- 2 The number of recipe files that can be loaded simultaneously depends on the application. The number of files that can be loaded is defined by the number of sets (each with a separate ID). If only one set or ID is configured, then references to set IDs do not appear at the user interface.

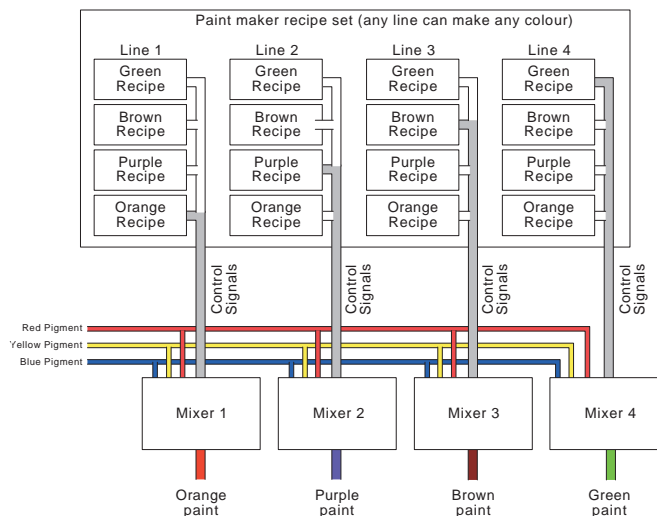

Figure 3.7a Four paint-mixer set

09:12:21		PAINT			23/11/00	
RCP	Orange	Purple	Brown			
red pigment	50.0	50.0	35.0			
blue pigment	0.0	50.0	35.0			
yellow pigment	50.0	0.0	30.0			

Figure 3.7b Sample recipe edit page

### 3.7.1 Download procedure

1. Select a recipe set ID (only if multiple recipe sets are supported).
2. Load a recipe file
3. Select a recipe line (only if multiple lines are supported)
4. Select a recipe (only if the file contains multiple recipes)
5. Download the recipe.

#### RECIPE SET SELECTION

- 1 From the main menu, select RECIPE

ACCESS	SYSTEM	ALARMS
OVERVIEW	PROGRAMMER	RECIPE
LOGGING	HOME	

Figure 3.7.1a Main menu

- 2 From the resulting pop-up menu, select RECIPES

Recipe		
RECIPES	STATUS	MONITOR
EDIT	DOWNLOAD	ABORT

Figure 3.7.1b Recipe menu

3. The Recipe Load/Save page appears with the recipe set ID and name of any currently loaded recipe file, or, if none, lines of question marks.

To select a new set or recipe file, touch the ID or Filename area and select the required item from the picklist which then appears. Alternatively, the various available selections can be scrolled through, using the left/right arrow keys at the bottom of the display.

15:18:42	Load/Save Recipe	09/11/00
Id: ????????		
File name: ????????		
LOAD	SAVE AS	DELETE
CREATE		

#### LOADING THE RECIPE

Once the required file has been selected, operation of the load button will call the recipe menu (figure 3.7.1b). The recipe can now be loaded by operation of the DOWNLOAD key. If, however, it is necessary to select a particular recipe line, or if it is necessary to select one recipe from a number in the file, the STATUS button should be operated to display the Recipe Status page.

**Note:** The contents of the status page is context dependent, so it is unlikely that it will contain exactly the same fields as shown in the figures below.

### 3.7 DOWNLOADING RECIPES (Cont.)

#### SELECTING A RECIPE LINE

If more than one line is present in a recipe set, it is possible to select which is to be the current line to which the recipe is to be downloaded. With the Recipe Status page displayed, (figure 3.7.1d), touch the yellowed Line field and select a new line from the resulting pick list. Alternatively, the down-arrow key at the bottom of the screen can be used to scroll through the available items. The file can now be downloaded by pressing the DOWNLOAD key.

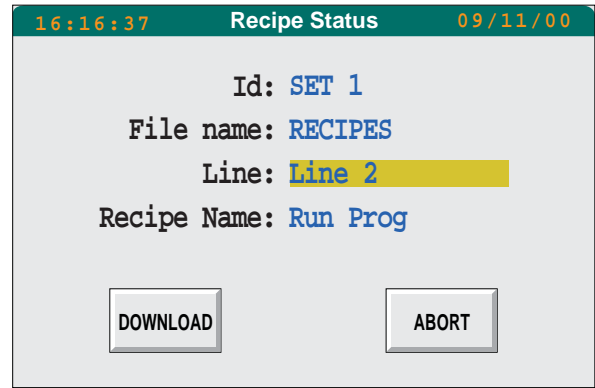

Figure 3.7.1d Status page for multi-line recipes

#### SELECTING A RECIPE

If more than one recipe is present in a file, then it is possible to select which recipe is to be the current one. With the Recipe Status page selected (figure 3.7.1e), a touch on the recipe field will call a pick list from which the required item can be selected. The recipe can now be downloaded using the DOWNLOAD key.

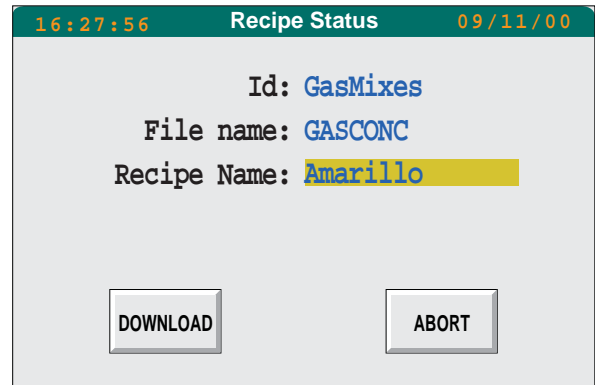

Figure 3.7.1e Status page for recipe selection

### 3.7.2 Monitoring the recipe

A recipe can be monitored from the Recipe Status screen, and from the Recipe Monitor screen.

#### RECIPE STATUS PAGE

The recipe status screen contains the File name and the Recipe name, and any one or more of the following fields:

Set ID

Line

Status (if downloaded)\*

Time/date of last download

\* Status can be any one of the following:

DOWNLOADING - if a download is in progress

COMPLETE - if the latest download was completed successfully

FAILED - if the previous download was unsuccessful or aborted.

### 3.7.2 MONITORING THE RECIPE (Cont.)

#### RECIPE MONITOR PAGE

This page is called from the Recipe menu (figure 3.7.1b) by touching the MONITOR key. The monitor page gives recipe values in tabular form as shown below.

As can be seen, the following columns are displayed:

- RCP            The recipe variables
- SP             The value held in the recipe file for each variable.
- SP (Live)     The current live database values for each variable. Where the SP and SP(Live) values differ, the value is highlighted in red, providing a useful diagnostic should a recipe download fail.
- PV             Optional values monitored in conjunction with the recipe. Might not be present on any recipe file.
- Capture       Optional values that would be captured if a recipe CAPTURE is performed. Might not be present on any recipe file.

The screenshot shows a software interface for monitoring a recipe. At the top, there is a status bar with 'TREND RUNNING 05:07:45', '2 TREND', 'Run prog', 'Fred', and '3/5'. Below this is a table titled 'Alarm History' with columns: RCP, SP, SP(Live), PV, and CAPTURE. The table lists various chemical compounds with their corresponding values. The 'SP(Live)' column contains red text, indicating a difference from the 'SP' column. At the bottom of the screen, there are several control buttons: SAVE, CAPTURE, CAPTURE AS, DOWNLOAD, and ABORT, along with a set of navigation icons.

RCP	SP	SP(Live)	PV	CAPTURE
Methane	90.6724	90.6724	90.6724	90.6724
Nitrogen	3.1284	3.1284	3.1284	3.1284
Carbon Dioxide	0.4676	0.4676	0.4676	0.4676
Ethane	4.5279	4.5279	4.5279	4.5279
Propane	0.828	0.8280	0.8280	0.8280
Water	0.0	0.0000	0.0000	0.0000
HydrogenSulphide	0.0	0.0000	0.0000	0.0000
Hydrogen	0.0	0.0000	0.0000	0.0000
Carbon Monoxide	0.0	0.0000	0.0000	0.0000
Oxygen	0.0	0.0000	0.0000	0.0000
i Butane	0.1037	0.1037	0.1037	0.1037
n Butane	0.1563	0.1563	0.1563	0.1563
i Pentane	0.0321	0.0321	0.0321	0.0321
n Pentane	0.0443	0.0443	0.0443	0.0443
n Hexane	0.0393	0.0393	0.0393	0.0393
n Heptane	0.0	0.0000	0.0000	0.0000
n Octane	0.0	0.0000	0.0000	0.0000
n Nonane	0.0	0.0000	0.0000	0.0000
n Decane	0.0	0.0000	0.0000	0.0000
Helium	0.0	0.0000	0.0000	0.0000

Figure 3.7.2 Recipe monitor page (SVGA version)

Note: For 1/4VGA units, the capture column is initially hidden, the scroll bar below the table allowing it to be viewed. This scroll bar and the SAVE/CAPTURE keys (shown above) are toggled between by means of the options key.



### 3.8 BATCHES

#### 3.8.1 Batch loading

- 1 From the main menu, select BATCH, then select BATCHES

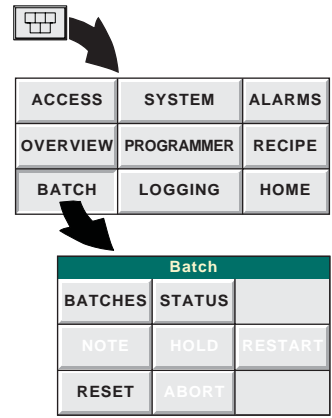

- 2 Touch the ID or filename area
- 3 Select the required item from the picklist which appears.
- 4 Operate the LOAD button.

Note: For the 'Create' function, see section 3.8.8, below.

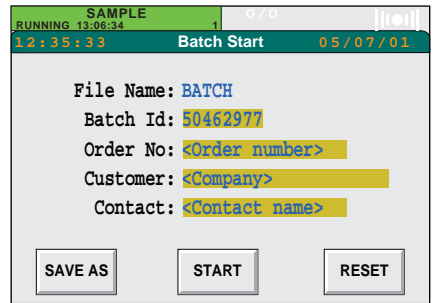
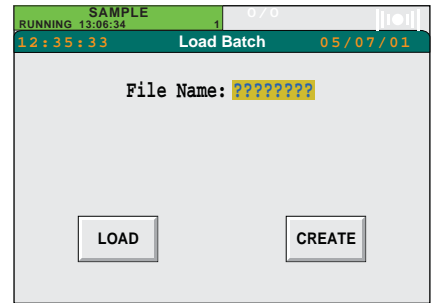

#### 3.8.2 Recipe selection

If applicable, a specific recipe can be selected for loading, from a pick list which appears if the Recipe field area is touched.

#### 3.8.3 Batch customising

The Batch ID is initially chosen as unique by the instrument. The name can be edited in the normal way. In addition to the batch ID there can be up to six custom items (in the example shown there are three, viz: Order No, Customer and Contact). Again, these items are editable in the normal way. The titles of these custom items (e.g. Order No.) are set up using the customising techniques described in Chapter 5, below.

### 3.8.4 Batch initiation

Once all the batch data has been entered, operation of the START key causes one of the following to occur, according as the batch has been configured:

- 1 The batch starts immediately
- 2 A dialogue box appears asking for confirmation of Batch Start. Operation of the OK button starts the batch.
- 3 A dialogue box appears asking for the current user's password. Entry of the password followed by operation of the OK button starts the batch.

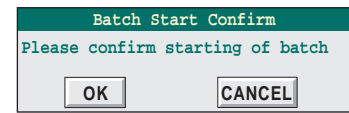

### 3.8.5 Batch monitoring

The batch may be monitored from the Batch Status screen which is accessed from the main menu using the BATCH key, then the STATUS key.

The batch status screen contains all the information present on the Batch Start screen, but also includes the State of the batch, its 'Started at' and (if appropriate) 'Ended at' time and date, and phase information. If a batch message is active, an annunciator bar appears near the top of the page flashing orange/black and a question mark with orange/black flashing background appears at the left side of the alarm pane. Touching the alarm pane allows review and acknowledgement of the message.

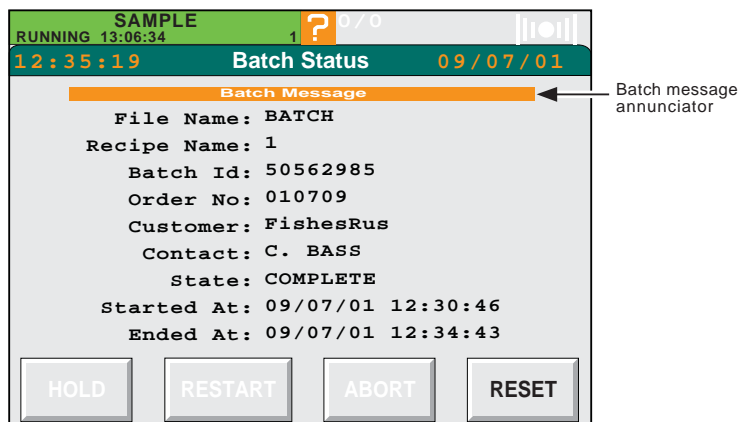

Figure 3.8.5 Batch status page

### 3.8.6 Batch Hold

With a batch running, operating the HOLD key from either the BATCH menu or the Batch Status screen, places the batch into hold mode. The batch may be restarted as required, by pressing 'RESTART'.

### 3.8.7 Batch Abort

With a batch running or held, operating the ABORT key from either the BATCH menu or the Batch Status screen, immediately terminates the batch.

### 3.8.8 Batch Create

A new batch can be created by operating the CREATE key from the 'Load batch' page described in [section 3.8.1](#), above.

Operation of the CREATE key causes a pick list to appear allowing the user to define batch parameters, as shown in the figure.

Filename*	Allows a filename (eight characters max.) to be entered for the Batch file.
Recipe line	Allows a recipe line to be chosen for batch action.
Display Group	Allows one of the display groups to be selected for batch action - see <a href="#">section 3.6</a> for further details
Message	Allows a message (set up in LIN blocks configuration) to be selected for display as appropriate.
Log Group	Allows a log group to be selected for Batch action (section 4.2).
Log Report	A logging group may have been configured to have "reports". In such a case, one of the log group's report files may be selected to drive batch reports. A batch report is generated for start, stop and abort. The create facility generates an elementary report file (.UYF) which may be customised by being exported and edited (see section 5.9.1 for further details of .UYF files).

\* Entry of a Filename is mandatory. Other field entries are optional.

This page is deliberately left blank

## CHAPTER 4: MANAGEMENT

This chapter is for those responsible for setting up the instrument, for managing applications, for editing setpoint programs, and for supervising the day-to-day operation and monitoring of the instrument. ‘Engineer’ level of access to the instrument is required (see section 2.8.1 - gaining access).

This chapter consists of the following sections:

- 4.1 Editing a program
- 4.2 [Logging groups of data](#)
- 4.3 [Managing an application](#)
- 4.4 [Controlling access](#)
- 4.5 [Setting up and re-setting the instrument](#)
- 4.6 [Cloning an instrument](#)
- 4.7 [File Manager.](#)
- 4.8 [Recipe management](#)

With the exceptions of Logging groups of data, Controlling access and File Manager, each section consists of several tasks, which are listed in the sub-contents at the start of each section.

If at any point the display differs from what is expected, the Menu key at the bottom of the screen on the right can be used to return to the Pop-up menu from which the task can be repeated.

### 4.1. EDITING A PROGRAM

#### 4.1.1 INTRODUCTION

---

Note: If more than one programmer has been configured then the right (left) arrow keys do not scroll through the program, but to the next (previous) programmer Id. (Chapter 3, section 3.1.1)

---

##### 4.1.1.1 CREATING A PROGRAM

The PC based Setpoint program editor (supplied on CD as one of the components of the Eurotherm Project Studio) is used to create programs. For details, see the Setpoint Program Editor Handbook (part no. HA261134U005).

##### 4.1.1.2 EDITING A PROGRAM

---

Notes:

- 1 Only two tasks (changing setpoint value and changing segment duration) can be performed while a program is running (but on Hold for the duration of the task). Whilst the current segment is in Hold mode, its values are displayed in green, instead of blue. It is possible to edit this segment’s duration only to times longer than the period of time already elapsed in that segment; other parameters can be edited as normal.
  2. The PREVIEW facility on the PROGRAMMER menu displays a profile of the loaded program over its full duration, and target values can be displayed at any point in time. It is recommended that frequent use be made of PREVIEW, when editing a program, in order to check that the edits have produced the intended profile.
  3. For systems with the Auditor option fitted, an edited program must be saved before it is run.
-

#### 4.1.1.2 EDITING A PROGRAM (Cont.)

Before editing can start, the Program Editor page must be accessed as described in [section 4.1.2](#). Once the editor page has been accessed, the program can be edited in the following ways:

##### Changing a setpoint ([section 4.1.3](#))

- By changing the type of ramp to it (4.1.3.1)

- By changing its value (4.1.3.2)

##### Changing a segment ([section 4.1.4](#))

- By changing its identifier (4.1.4.1)

- By changing its duration (4.1.4.2)

##### Inserting or deleting a segment ([section 4.1.5](#))

- Inserting a segment (4.1.5.1)

- Deleting a segment (4.1.5.2)

##### Changing the Hold Back properties for any analogue setpoint ([section 4.1.6](#))

- Choosing the setpoint (4.1.6.1)

- Changing the Holdback mode (4.1.6.2)

- Changing the Holdback value (4.1.6.3)

##### Changing program properties ([section 4.1.7](#))

- Changing the name of a program (4.1.7.1)

- Changing the rate units for a program (4.1.7.2)

- Choosing an action to be taken at the end of each run (4.1.7.3).

### 4.1.2 Program Editor Page access

1. Press the Menu key, then PROGRAMMER

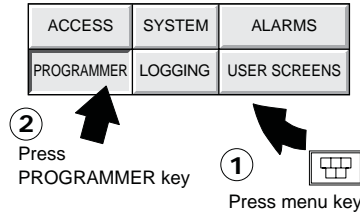

The Programmer menu appears.

Programmer		
MONITOR	PROGRAMS	SCHEDULE
PREVIEW	PRE-PLOT	EDIT
RUN	HOLD	ABORT
RUN FROM	SKIP	

2. Press PROGRAMS

The Load/Save Program page appears, prompting you for the name of a file to Load or Save. (To edit a program, it must first be loaded.)

08:31:03 Load/Save program 21/02/00			
File Name: ????????			
LOAD	SAVE	SAVE AS	DELETE

3. Press the File Name field (the question marks).

On the left of the screen, a pick-list appears, containing the programs held by the instrument.

08:31:49 Load/Save program 21/02/00	
?????????	?????????
dsample	
STMAXALL	
ENMAXSEG	
ENMAXSP	
SAMPLE	
SAVE AS	DELETE

4. Press the name of the program to be edited

5. Press the green Return key

The Load/Save program page displays the name of the selected program.

08:31:15 Load/Save program 21/02/00			
File Name: SAMPLE			
LOAD	SAVE	SAVE AS	DELETE

6. Press LOAD.

If the program has components (parameters) which are not in the LIN database then an error message will appear and the program will not load.

After a successful load, the Programmer menu reappears.

08:31:23 Load/Save program 21/02/00			
Programmer			
MONITOR	PROGRAMS	SCHEDULE	
PREVIEW	PRE-PLOT	EDIT	
RUN	HOLD	ABORT	
RUN FROM	SKIP		

7. Press EDIT

The Program Editor page appears showing the values of the setpoints in tabular form.

Each row represents one setpoint along a horizontal timebase marked in segments. Some of the rows are for analog setpoints and some are for digital ones.

08:31:49 SAMPLE 21/02/00			
SP	1	2	3
Ana In 1	S to 50.0	R to 100.0	R to 0.0
Ana In 2	S to 50.0	R to 65.0	R to 20.0
Ana In 3	S to 50.0	R to 99.0	R to 97.7
Dig in 1	OPEN	CLOSED	OPEN
Dig in 2	CLOSED	OPEN	CLOSED
Dig in 3	OPEN	CLOSED	OPEN

Each column represents a segment, and each segment is identified by a name or number shown at the top of the column. Under the segment identifier is the time duration of the segment.

All the yellowed fields yield further information when pressed.

### 4.1.3 Changing a setpoint

#### 4.1.3.1 CHANGING RAMP TYPE

Generally there are up to six ways in which you can program the Visual Supervisor to control the value of a setpoint (some may not be available on your instrument). These methods are called 'Step' (sometimes called 'Set'), 'Dwell', 'Ramp at', 'Ramp to', 'Servo to setpoint' and '\Servo to process variable'.

##### Step

Value changes instantaneously. Can be used in any segment. Also called 'Set'.

##### Dwell

Value remains constant. May be used in all segments except the first.

##### Ramp at

Value increases at a constant specified rate. May be used in all segments except the first.

##### Ramp to

Value increases linearly to a specified value

---

Note: 'Ramp at' and 'Ramp to' cannot be mixed within the same segment. If an attempt is made to change one of the SPs from one type to the other, a message appears warning that all the other similar types in that segment will be changed to conform.

---

##### Servo to setpoint (SP)

The unit reads the current setpoint value, and sets the setpoint to that value (that is, it does not change it). Similar to 'Dwell' except that the instrument carries out the instruction automatically (without operator intervention). As there is no change, power output remains constant. May be used only in the first segment.

##### Servo to process variable (PV)

The instrument reads the current process value and sets the setpoint to that value. Because the current process value normally differs from the current setpoint value, this option usually results in a change in the power consumption of the process.

---

Note: If the first segment is a Servo to PV or SP, the instrument assumes that it starts from an SP of 0.0. This is unlikely to be the actual SP or PV. Therefore the Preview profile displayed for the first segment will differ from the actual programmed profile. For the same reason, if the second segment is a ramp-at-rate, the segment duration in Preview will differ from the actual duration; and if the second segment is ramp-to-target then the slope in Preview will differ from the actual slope.

---

#### TERMINOLOGY

In this document any change in the value of the setpoint is referred to as a 'ramp', even when the result of that change is zero. This means that the six methods of controlling the value of the setpoint, described above, all result in types of ramp.



### 4.1.3.1 CHANGING RAMP TYPE (Cont.)

#### TO CHANGE THE TYPE OF RAMP

Example for Analog Input 1: The following example describes how to change the ramp in Segment 2 from a 'time-to-target' to a 'ramp-to-target'.

In the Program Editor page, the cell for Analog Input 1, Segment 2 shows R for 'Ramp' and 'to 100.0' for the value, indicating that it is currently a ramp to a specified value.

Press the cell.

A dialogue box appears displaying data about that cell.

Press the yellowed 'Ramp' field.

A pick-list of ramp types appears, with 'Ramp' highlighted

Press the required type (in this case, 'Ramp@').

'Ramp@' highlights yellow.

Press the green 'Return' key.

The dialogue box reappears, now showing 'Ramp@' in the 'Type' field, followed by an extra field 'Ramp at'. (This field only when changing to a 'Ramp@').

Press the yellowed 'Ramp at' field, currently showing 0.0/m (standing for zero units per minute).

SP	1 00:05:00	2 00:50:00	3 00:35:00
Ana In 1	S to 50.0	R to 100.0	R to 0.0
Ana In 2	S to 50.0	R to 65.0	R to 20.0
Ana In 3	S to 50.0	R to 99.0	R to 97.7
Dig in 1	OPEN	CLOSED	OPEN
Dig in 2	CLOSED	OPEN	CLOSED
Dig in 3	OPEN	CLOSED	OPEN

SP	1 00:05:00	2 00:50:00	3 00:35:00
Ana In 1	S to 50.0	R to 100.0	R to 0.0
Ana In 2	S to 50.0	R to 65.0	R to 20.0
Ana In 3	S to 50.0	R to 99.0	R to 97.7
Dig in 1	OPEN	CLOSED	OPEN
Dig in 2	CLOSED	OPEN	CLOSED
Dig in 3	OPEN	CLOSED	OPEN

SP	1 00:05:00	2 00:50:00	3 00:35:00
Ana In 1	S to 50.0	R to 100.0	R to 0.0
Ana In 2	S to 50.0	R to 65.0	R to 20.0
Ana In 3	S to 50.0	R to 99.0	R to 97.7
Dig in 1	OPEN	CLOSED	OPEN
Dig in 2	CLOSED	OPEN	CLOSED
Dig in 3	OPEN	CLOSED	OPEN

SP	1 00:05:00	2 00:50:00	3 00:35:00
Ana In 1	S to 50.0	R to 100.0	R to 0.0
Ana In 2	S to 50.0	R to 65.0	R to 20.0
Ana In 3	S to 50.0	R to 99.0	R to 97.7
Dig in 1	OPEN	CLOSED	OPEN
Dig in 2	CLOSED	OPEN	CLOSED
Dig in 3	OPEN	CLOSED	OPEN

SP	1 00:05:00	2 00:50:00	3 00:35:00
Ana In 1	S to 50.0	R to 100.0	R to 0.0
Ana In 2	S to 50.0	R to 65.0	R to 20.0
Ana In 3	S to 50.0	R to 99.0	R to 97.7
Dig in 1	OPEN	CLOSED	OPEN
Dig in 2	CLOSED	OPEN	CLOSED
Dig in 3	OPEN	CLOSED	OPEN

### 4.1.3.1 CHANGING RAMP TYPE (Cont.)

A numeric keyboard is displayed, showing the current value of the ramp in a black confirmation bar at the top.

Key in the required ramp rate. As soon as the first digit is entered, the rest of the bar clears.

When the new entry is complete, press Return.

The dialogue box reappears, displaying the new value for the ramp rate.

Press DONE.

A new 'Ramp to' value is shown in the cell. To save the new ramp type, press the Option key at the bottom of the screen, then press the SAVE button that appears on a bar at the bottom of the screen.

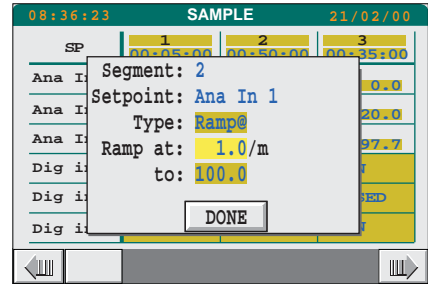
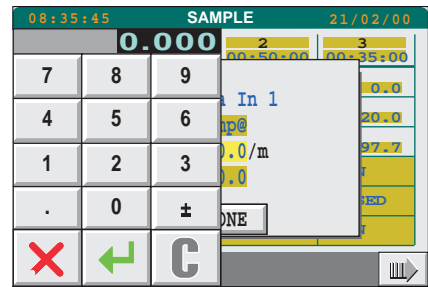

### 4.1.3.2 CHANGING SETPOINT VALUE

In the Program Editor page, select the analogue cell holding the value to be changed.

A dialogue box appears, showing:

- 1 the segment name or number
- 2 the setpoint name for that row
- 3 the setpoint type
- 4 the current target value for the setpoint in that cell.

To change the target value, touch the value and enter the new value using the keyboard display which appears.

Press the Return key

The dialogue box reappears, this time showing the new value.

Press DONE

The Program Editor page returns, with the new value shown in the selected cell.

To save the setting, press the Option key at the bottom of the screen (second key from the right), and then the SAVE button.

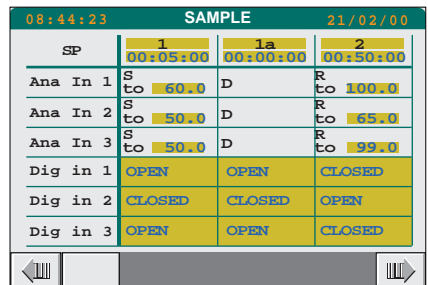
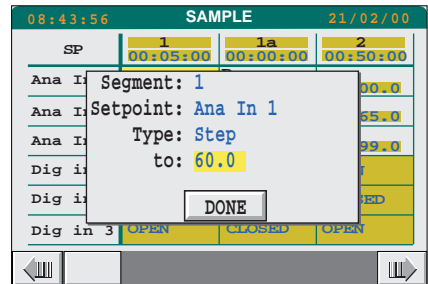
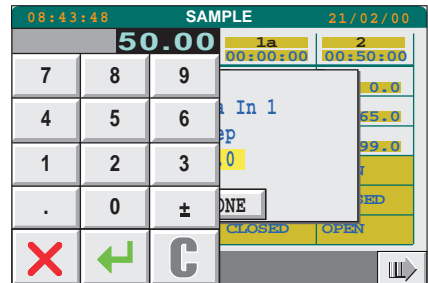
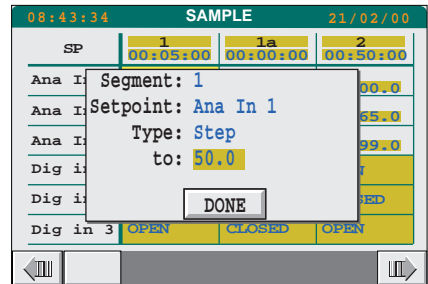

### 4.1.4 Changing a segment

In the Program Editor page, press the identifier at the top of the column of the segment to be modified. For example, segment 1.

A dialogue box appears with two fields: Segment and Duration, and three buttons: INS SEG, DEL SEG and DONE.

Sections 4.1.4.1 and 4.1.4.2, below, show how to change a segment's identifier and duration respectively. Inserting and deleting segments is described in sections 4.1.5.1 and 4.1.5.2 respectively.

Once the segment changes are complete, the SAVE button is used to save the changes. If necessary, the SAVE button is called to the display by pressing the 'option' key located at the bottom of the screen.

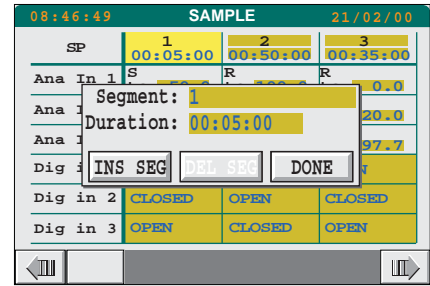

Option key

#### 4.1.4.1 CHANGING SEGMENT IDENTIFIER

In the dialogue box, press the Segment field.

A 'qwerty' keyboard appears.

A numeric/symbol keyboard can be called by pressing the 'up arrow' key at bottom left. A further operation of the arrow key calls a keyboard of accented lower-case letters. Pressing the up arrow key again re-displays the original 'qwerty' keyboard.

The segment identifier can be a name, a number, a character or a digit, but DOS file name rules apply.

The required segment identifier (for example, 'a') is keyed-in using one or more of these keyboards.

To clear the entry so far (but retaining the keyboard display), press the 'C' key.

To cancel the entry and return to the setpoint display, press the red cross key.

Once the segment identifier has been keyed in, the Return key is operated to save it.

The Program Editor page reappears, showing the new identifier for the segment.

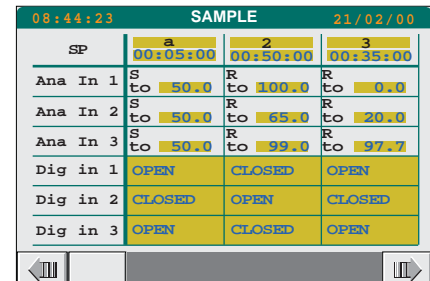

### 4.1.4.2 CHANGING SEGMENT DURATION

**Caution:**

1. Changing the duration of 'ramp-at-rate' segments is not permitted.
2. Changing the duration of 'ramp-to' segments changes the rate of ramp. Therefore, before making any such change, you should consider the possible effect of this upon the operation of the process plant.

In the dialogue box, press the Duration field.

A numeric keyboard appears, with the current duration displayed at the top in hh:mm:ss format. The format can be changed, as described in section 4.5.4 Changing the language and date formats.

Key-in the required duration.

Once the correct duration is keyed-in, the Return key is used to save it.

The Program Editor page appears, showing the new duration for the segment.

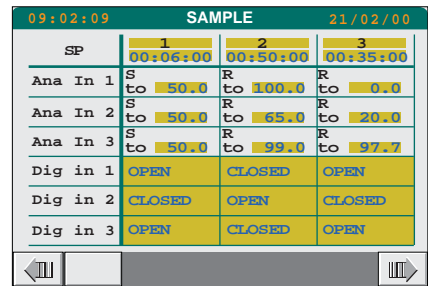
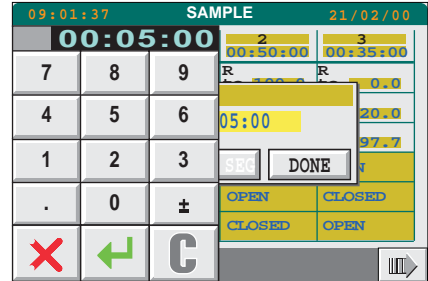

### 4.1.5 Inserting/deleting segments

#### 4.1.5.1 INSERTING A (NULL) SEGMENT

**Notes:**

1. A 'null' segment consists of a dwell of zero duration.
2. Inserting or deleting segments can have a knock-on effect on subsequent 'ramp-to' or 'ramp-at-rate' segments, because the setpoint value at the point when these segments 'start' could change. This could affect the duration of 'ramp-at-rate' segments.

In the segment preceding the new segment's location, press the segment-name cell at the top of the column.

In the dialogue box in section 4.1.4, press the INS SEG key.

The 'New Segment' window appears, requesting an identifier for the new segment.

Press the Segment field (yellowed)

A 'qwerty' keyboard appears. The procedure for entering the identifier for a new segment is the same as that described in section 4.1.4.1

When the required segment name (for example, 1a) has been entered, the Return key is operated.

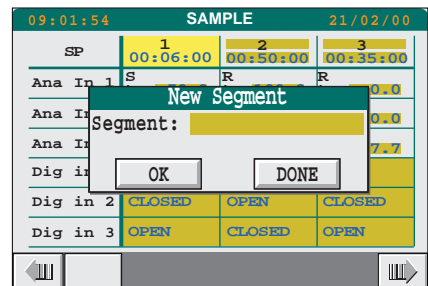

#### 4.1.5.1 INSERTING A (NULL) SEGMENT (Cont.)

The New Segment window reappears, displaying the name of the new segment.

This inserted segment will be a 'null' operation, until it has been modified. A null operation consists of a dwell of zero duration.

Press OK.

The Program Editor page returns with a new, but empty, segment inserted after the one which was being modified.

In order to view the whole setpoint sequence, it might be necessary to scroll right or left using the scroll bar/arrows at the bottom of the display.

The SAVE button is used to save the changes when completed. If necessary, the SAVE button is called to the display by pressing the 'option' key located at the bottom of the screen.

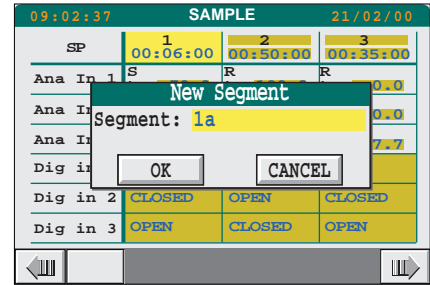

SP	1	1a	2
	00:06:00	00:00:00	00:50:00
Ana In 1	S to 50.0	D	R to 100.0
Ana In 2	S to 50.0	D	R to 65.0
Ana In 3	S to 50.0	D	R to 99.0
Dig in 1	OPEN	OPEN	CLOSED
Dig in 2	CLOSED	CLOSED	OPEN
Dig in 3	OPEN	OPEN	CLOSED

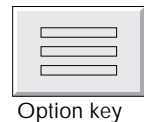

#### 4.1.5.2 DELETING A SEGMENT

The procedure for deleting a segment is the same as that for inserting a segment except that:

- 1 the DEL SEG key is used
- 2 the first segment of a program cannot be deleted - the DEL SEG key is greyed out (deactivated).

The setting is saved in the same way.

#### 4.1.6 Changing hold back properties

'Hold Back' is a state that is automatically induced when the SP ramp rate is too fast for the process to be able to follow it. When the process has fallen behind the SP by an amount equal to a pre-set 'holdback value', then the SP ramp is stopped ('held') until the PV catches up. The Holdback value is set by the Engineer.

For example, if the setpoint is ramping up but the PV has fallen behind and is now falling below the pre-set lower bound, the program will automatically switch the setpoint profile to a dwell to give the PV a chance to catch up. The dwell will continue until the PV climbs above the lower bound (whose profile of course could now also be a dwell). At this point the setpoint profile will switch back to a 'ramp up'.

The result of this is that the overall process time extends by the length of time during which the PV was 'out-of-bounds', which is the same as the length of the dwell.

The remainder of this section explains which type of limit or limits can be set, and how to set the values.

After setting the new values, they are saved by pressing the option key at the bottom of the screen (second key from the right). On the Option bar that appears at the bottom of the screen, press the SAVE button.

### 4.1.6.1 CHOOSING THE SETPOINT

In the Program Editor, choose the analog input for which the Hold Back properties are to be edited.

The cell highlights, and a dialogue box appears (see section 4.1.6.2)

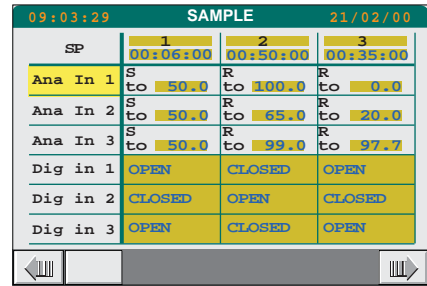

### 4.1.6.2 CHANGING HOLD BACK MODE

Press the Mode field (yellowed)

A pick-list appears with None, Low, High, High & Low shown as modes.

‘None’ means no limits, which means no Hold Back.

‘Low’ specifies a limit below the current setpoint value. If the PV falls below this limit, then the program will compensate by holding the setpoint steady until the PV has recovered to exceed the limit.

‘High’ specifies a limit above the current setpoint value. If the PV exceeds this limit, then the program will compensate by holding the setpoint steady until the PV has fallen below the limit.

‘High & Low’ sets both limits.

Choose the required limit (e.g. LOW).

It highlights.

Press the Return key.

The picklist disappears.

Press DONE.

The dialogue box disappears.

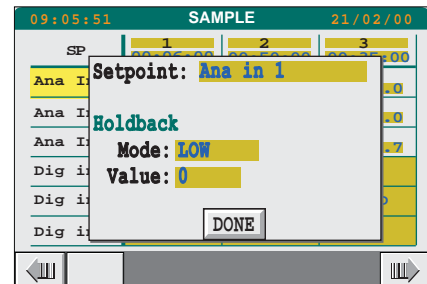
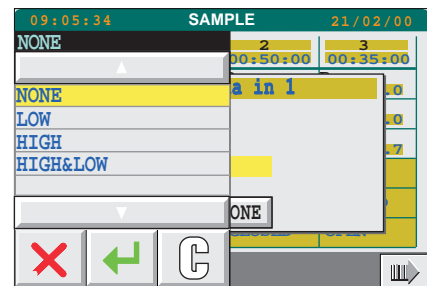
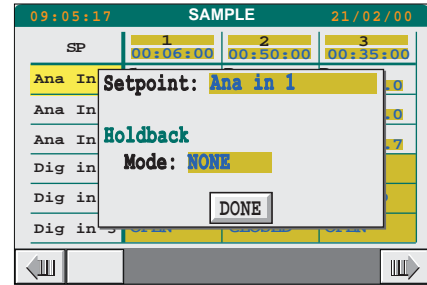

### 4.1.6.3 CHANGING HOLDBACK VALUES

Press the Value field (yellowed).

A numeric keyboard appears, showing the current value in a black confirmation bar at the top.

Key in the required value and press the Return key.

The keyboard disappears.

Press DONE.

The dialogue box disappears.

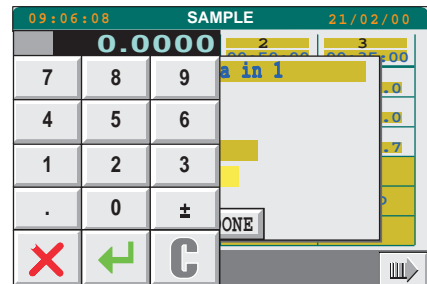

### 4.1.7 Changing program properties

In the Program Editor page, press the SP (Setpoint) cell at top left. The Properties window appears, prompting for:

- Name:
- Rate Units:
- At End:

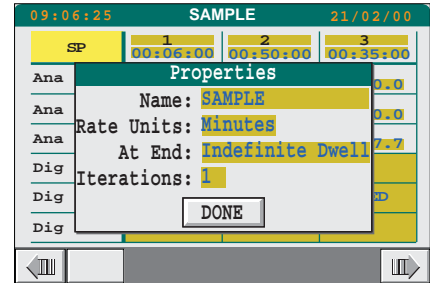

From this screen, the possible tasks are:

- To change the name of a program (section 4.1.7.1)
- To change the rate units (section 4.1.7.2)
- To choose an action to be taken at the end of each run (section 4.1.7.3)
- To change the default number of iterations (section 4.1.7.4)

To save any new settings, press the Option key at the bottom of the screen and then the SAVE button.

#### 4.1.7.1 CHANGING PROGRAM NAMES

Note: A program name should be changed only if ‘non-file name’ characters are to be included. If this is the case, it should be remembered that the file name of the program takes the name of the program by default. In other words, the program name overrides the file name. Therefore, if a program is saved to a new file, two programs of the same name will exist, embedded within different files.

In the Properties window, press the current name displayed in the yellowed ‘Name’ field.

A ‘qwerty’ keyboard display, with a cursor flashing under the first character of the current name, shown in a black confirmation bar above the keyboard.

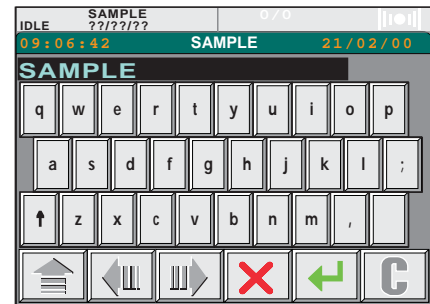

Key in the new name.

When the confirmation bar shows the correct new name (for example, ‘simple’), Press the Return key

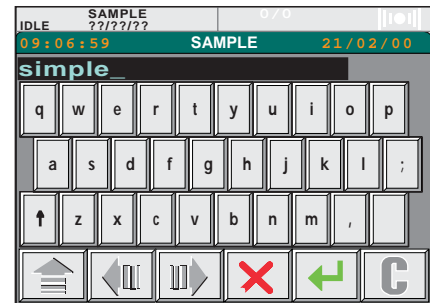

The keyboard disappears, revealing the Properties window showing the new name.

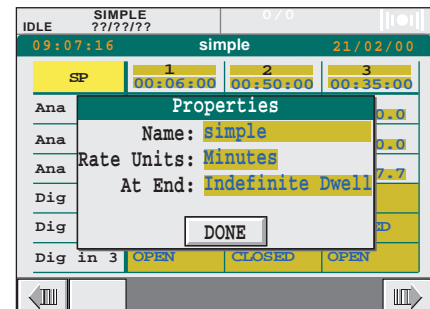

Press DONE

### 4.1.7.2 CHANGING RATE UNITS

In the Properties window, press the 'Rate Units' field.

A pick-list appears with Seconds, Minutes, Hours as selectable options. Select, say, Seconds

Press Return

The Properties window reappears, with the 'Rate Units' field showing 'Seconds'

Press DONE

The Program Editor page reappears (rate units are not shown).

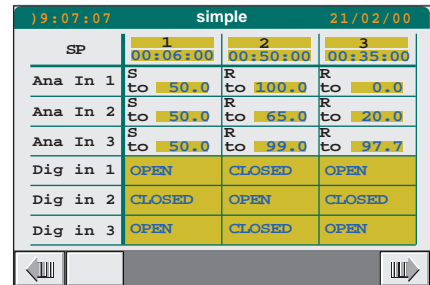
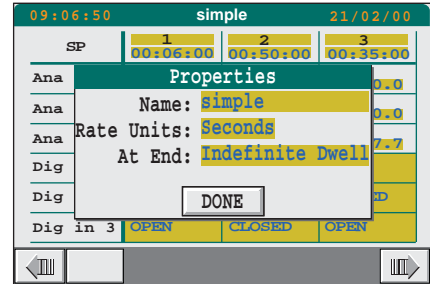
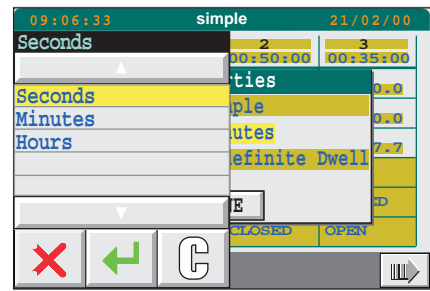

### 4.1.7.3 CHOOSING END-OF-RUN ACTION

In the Properties window, press the yellowed 'At End' field.

A pick-list appears containing 'Indefinite Dwell' and 'Starting Values'.

#### Indefinite dwell

This leaves all values as they are at the end of the program, until new action is taken to change them. A program with an end condition of 'Indefinite Dwell' does not terminate but adopts the COMPLETE state until ABORTED.

Ending on an indefinite dwell is the only circumstance that puts a program into the 'Complete' state and the status panel will show 'COMPLETE'.

#### Starting values

This ends the program by restoring its starting values. In this case, the program adopts the 'Idle' state upon finishing.

Select the required action and press the Return key

The Properties window reappears showing the selected action and, below that, the message 'DONE'.

Press DONE.

The Program Editor page re-appears.

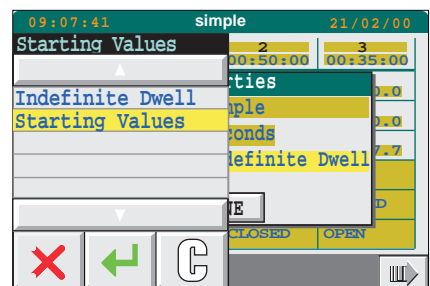
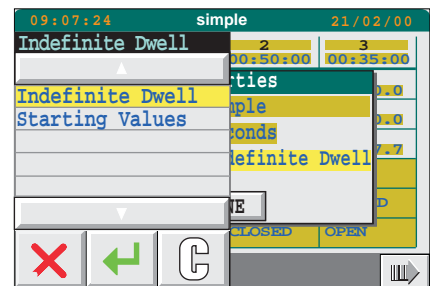



#### 4.1.7.4 CHANGING DEFAULT ITERATIONS

In the Properties window, press the current value for iterations displayed in the 'Iterations' field. A numeric keyboard pop-up menu appears allowing the default number of iterations to be set between 0 and 999, where '0' results in continuous running.

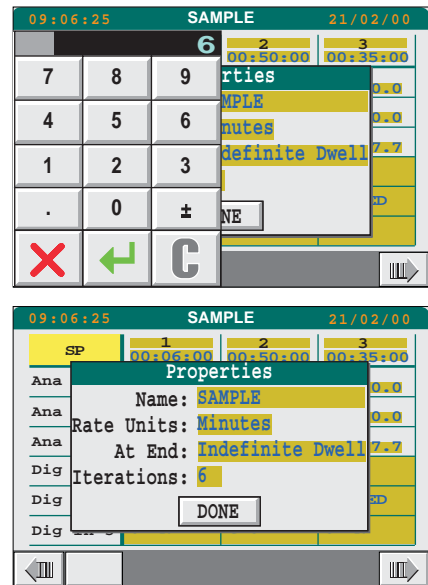

#### 4.1.8 Changing setpoint names

Analogue and digital setpoint names can be changed, but not while the program is running. For analogue setpoints the holdback values can also be amended (see section 4.1.6, above).

With the program stopped, press the setpoint whose name is to be edited - in this example, 'Ana In 1'

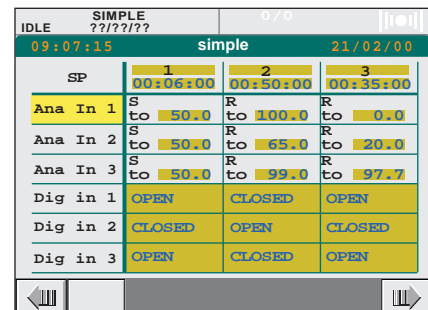

For an analogue setpoint a window is displayed, offering the option to change Setpoint name and Mode (shown opposite). For a digital setpoint the only editable field is 'Setpoint name'.

Press the yellowed field.

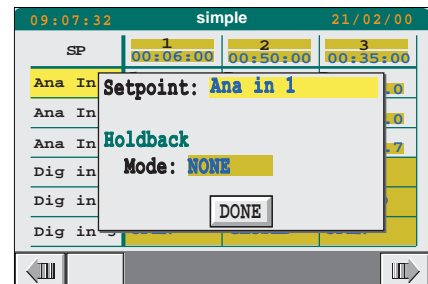

Key in the new name, up to a maximum of 16 characters, FOLLOWED BY ENTER.

Press DONE.

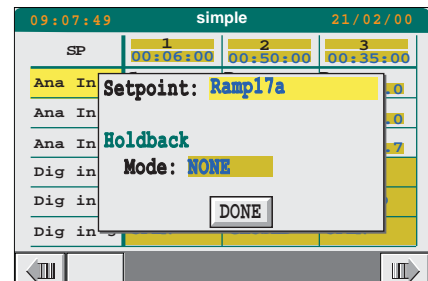

### 4.1.9 Segment timing display

Normally segment timing is shown and edited in terms of the duration of each segment.

It is possible to change this to show the start time and/or the end time of the segment in addition to the duration, or it can be changed to show start time only.

If 'start time only' is selected, the segment is edited by specifying how far into the program the segment is due to start, not in terms of the segment duration. In this case, the time displayed for each segment must be greater than the preceding segment and less than the following segment.

To change these options, press the LAYOUT button at the bottom of the Program Editor screen.

The Editor Layout window appears, offering four fields to edit

Press any field to alternate between YES and NO.

The 'Long SP Names' field re-formats the display to permit names up to 16 characters long, but this will reduce the number of cells visible.

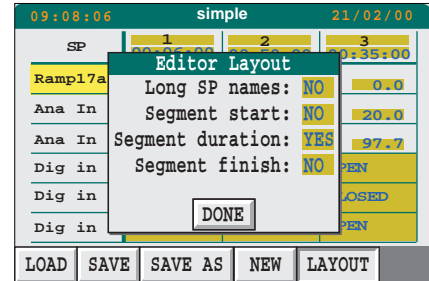

The settings for segment timing are not preserved across power failure. However, it is possible to switch between settings at any time, as this has no effect on the actual program, merely on how the data is presented.

## 4.2 LOGGING GROUPS OF DATA

A 'group' is a set of up to 16 data values that are recorded to one file. The data can be drawn from the same source or from different sources. If from the same source, the data can be recorded at different data rates, with each data rate assigned to a different group.

It is possible to record just one group, or several groups simultaneously. If several groups are to be recorded simultaneously, the groups can be saved to one file or to separate files.

Typically, logging groups of data is used for:

- 1 General audit records (for subsequent analysis with MS Excel, for instance)
- 2 Quality control of product and plant
- 3 Monitoring staff performance.

### 4.2.1 Log initiation

1. Press the Menu key then LOGGING, then GROUPS

The Logging Groups page appears, showing data for a single group.

To scroll between groups, press either the < or > keys can be used.

For any group, the fields are as follows:

**GROUP NAME** This is an identifier given to each group of data. To name a file or to change a file name, first turn 'Logging' to 'OFF' (see next paragraph), then re-enter the name.

**LOGGING** This shows 'ON', 'OFF', or 'On Event'. What is shown depends upon whether logging is currently on, off, or set to start upon the occurrence of an event. The event is specified by the customer and is configured at the factory or by the OEM. To change the current setting, press the yellowed Logging field and select ON, OFF or On Event as required, then press ENTER. The Logging Groups page now shows the new setting against 'Logging'.

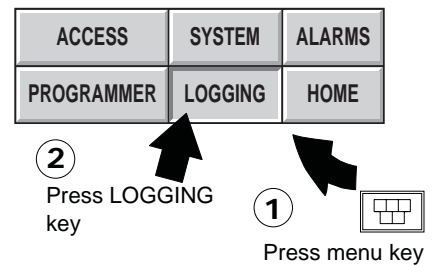

Logging	
MONITOR	OFF-LINE
MANAGE	GROUPS

09:08:23		Logging Groups		21/02/00	
Group Name: lgrpl					
Logging: ON					
Configuration					
Archive Int: 00:01:00					
File Type: ASCII					
Name Type: Hourly					
File Name: ascii .ASC					
Column Titles: Present					
Date Format: Date Time					
SAVE			LOG NOW		

### 4.2.1.1 LOG CONFIGURATION

The remaining fields concern the configuration of the files to be logged. To change any of these fields, Logging must be selected OFF as described above.

Archive Int	<p>This is the interval at which data is archived (saved) to disk during the logging process. The maximum rate is 1 file per 10 secs: for example, 1 file @ 10 secs, 3 files @ 30 secs. If a 'faster' rate than this is entered (for example, 4 files each @ 20 secs) then the specified rate may not be reached, in which case data samples will be lost. For internal archiving, the rate is 10 times faster than archiving to floppy.</p> <p>The default format for this field is hh:mm:ss, but this can be changed (see section 4.5 Setting up and re-setting the instrument).</p> <p>Values are entered using the numeric keyboard that appears on the left of the screen when the field is touched.</p>
File Type	<p><b>ASCII</b> This human-readable file type is for importing into standard, commercial spreadsheets. Files of this type have extensions of the following type: .ASC, .AS1 to .AS9 or .A01 to .A99. Any file name type may be used.</p> <p><b>Binary</b> This is a tamper-proof non human-readable, compressed format which can be interpreted only by the Review software package. Files of this type have extensions of the following type: .PKD, .PK1 to .PK9 or .P01 to .P99. Any file name type may be used.</p> <p><b>Uhh</b> This format, available only with 'Enhanced' instruments is another non human-readable file. Like the Binary format, UHH files can be interpreted only by Review software, but UHH files are more efficient, and allow Review to extract more data than Binary files. UHH files can have only Sequence file names. If 'Hourly' or 'Daily' is selected, then new UHH sequence files are created at hour or day boundaries respectively. The file extension is .UHH.</p>
Name Type	<p><b>Text</b> This results in a continuous file that starts when logging is initiated and stops when logging is stopped.</p> <p><b>Hourly</b> Logs data in hourly blocks starting on the hour. Each log is written to a different file name.</p> <p><b>Daily</b> Logs data in 24 hour blocks starting at midnight.</p> <p><b>Sequence</b> Logs data in sequentially-numbered continuous files.</p>
File Name	<p>For text files, the operator specifies the whole of the 8-character name (DOS rules apply). For hourly and daily file types, the operator specifies the first two letters and the remaining six are assigned automatically by the instrument to identify the start of the hour (or the 24-hour day) logged in the file. The first two characters must be unique to that logging group. For example, an hourly ASCII file that started at 11 o'clock on 26 July 2004, and that was given the identifier 'RN' by the operator, would be assigned the name RN072611.asc (that is, RNmmddhh.asc). A daily packed file that started at the previous midnight would be 'RN040726.pkd' (that is, RNyymmdd.pkd).</p> <p>For sequential files, the operator specifies the first two letters and the remaining six are assigned automatically by the instrument, starting at 000001, and incrementing each time a new file is started.</p>
Column Titles	<p>This field appears only if 'ASCII' is selected as File Type.</p> <p>Pressing the currently-displayed option causes a picklist to appear allowing the user to select 'Present' (column titles included in log) or 'Absent', (column titles are not logged).</p>

**4.2.1.1 LOG CONFIGURATION (Cont.)**

**Date Format** This field appears only if 'ASCII' is selected as the file type, and is used to select the format for the date/time or duration stamp recorded in the file, by means of a picklist containing the formats described in table 4.2.1.1.

**Compr Ratio** Not supported by this release of software.  
If 'Binary' is selected as File Type, then Compr[ression] Ratio replaces Column Titles and Date Format. Compression ration can be selected, form a pick list, to be either Normal or High. Normal provides an exact copy whilst High compresses the data more than 'Normal' but with a slight loss of accuracy.

Once configuration is complete, SAVE should be operated:

**SAVE** Saves the specifications for future logging

**LOG NOW** For ASCII files only, LOG NOW logs a sample immediately it has been selected. This manual initiation can be used to take samples as and when required, in addition to samples taken under timed logging.

FORMAT	ABS/REL	EXAMPLE	DESCRIPTION
Date Time	Absolute	25/09/98,10/30/00	Choose this format to set up the program to accept the date and time as dd/mm/yy, hh:mm:ss. The first example in the previous column means 25 September 1998 at 10.30 am.  09/25/98,10/30/00 The date format can be set to be mm/dd/yy, as described in section 4.5.4 below. The second example expresses the date and time in the new format.
Spreadsheet	Absolute	36068.51	Choose this format for data to be exported to a spreadsheet. The format is a single floating point value, the integer part of which is the number of days since 31 Dec 1899 at 0 hours and the decimal part is the proportion of the day since midnight. For example, a value of 1.5 would represent 1 Jan 1900 at noon. The example in the previous column represents 30 September 1998 at 10 mins and 5 secs past midday (that is, 30/09/98 at 12:10:05).
Integer	Absolute	980930121005	An integer count of seconds since 31 Dec 1899 at 0 hours.
Duration	Relative	00:04:30:00	A text format for expressing the time since start of logging. The example represents 4hrs 30mins since start of logging.
Days	Relative	0.1875	Choose this format for data to be exported to a spreadsheet. A single floating point value. The example represents 4hrs 30mins since start of logging.
DHMS	Relative	00032000	Days Hours Minutes Seconds since start of logging. The example represents 3hrs 20mins since start of logging.

Table 4.2.1 Date formats for logs

### 4.3 MANAGING AN APPLICATION

This section describes the stopping, saving, starting, unloading, loading, running and deleting of applications, using the STOP, SAVE, START, UNLOAD, LOAD, LD+RUN and DELETE keys that appear at the foot of the Application Manager page.

**UNLOAD and DELETE:** For many processes, the Visual Supervisor will control one application all the time. This will be loaded and run at commissioning, or soon after, and thereafter will never be unloaded and will never be deleted. For many processes, therefore, UNLOAD and DELETE will not be used.

**STOP, SAVE and START:** All processes will use STOP, SAVE and START because an application has to be stopped to save application data (to preserve cold-start values if they need changing). This is true even if the process runs only one application. START simply restarts an application after a SAVE.

**LOAD and LD+RUN:** All processes require a LOAD or LD+RUN at least once.

These tasks are described under the following headings:

Displaying the Application Summary page ([section 4.3.1](#))

Displaying the Application Manager page ([section 4.3.2](#))

Stopping an application ([section 4.3.3](#))

Saving application data ([section 4.3.4](#))

Unloading an application ([section 4.3.5](#))

Loading an application, or Loading and running ([section 4.3.6](#))

Deleting an application ([section 4.3.7](#))

Displaying application diagnostics ([section 4.3.8](#))

Function Block Manager ([section 4.3.9](#))

If the very first application is being loaded and run on an instrument, LOAD and then START, or just LD+RUN will be used. If an application is already running and it is to be replaced by another, the sequence from Displaying the Application Manager page to Loading an application (or Loading and running) should be referred to.

Application Summary and Function Block Manager provide useful summaries and overviews at any time.

### 4.3.1 Application summary page

This page displays the percentage of the instrument’s various memory resources that are currently in use.

Press the Menu key and select SYSTEM from the pop-up menu.

Select APPLN then APP SUM.

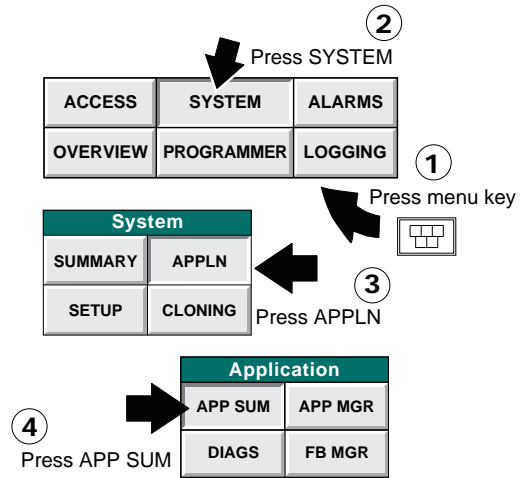

The Application Summary page appears, showing:

- 1 the name of the loaded application,
- 2 its state (RUNNING, IDLE, or STOPPED),
- 3 data about memory usage.

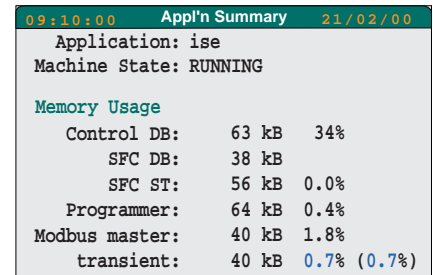

### 4.3.2 Application manager page

Note: If the Terminal Configurator is being used (connected to a PC plugged into the CFG port on the front panel), the Application Manager page will not be accessible. Conversely, if the Application Manager page is being used, the Terminal Configurator will not be usable.

Press the Menu key and select SYSTEM from the pop-up menu.

Select APPLN from the SYSTEM window to display the Application window.

Select APP MGR.

The Appl’n Manager page appears, displaying the name of the current application and its state (i.e. RUNNING, IDLE or STOPPED).

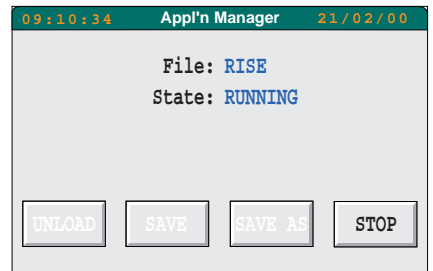
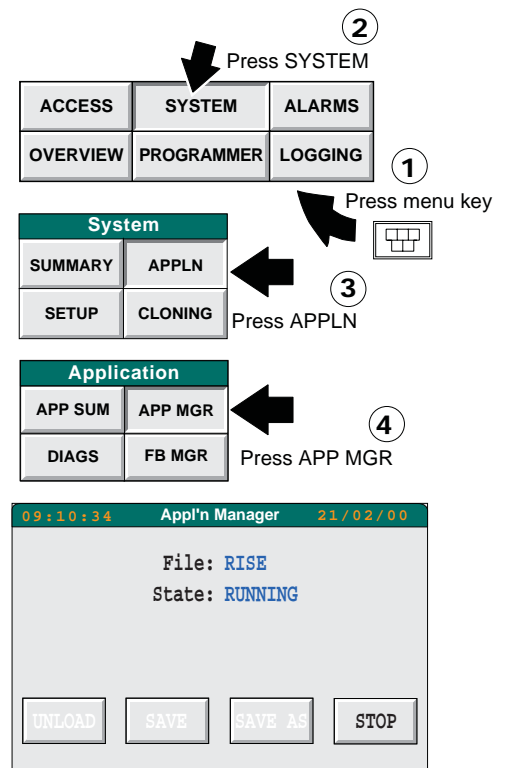

### 4.3.3 Stopping an application

With an application running the Appl'n Manager page should look like this (except for the actual file name).

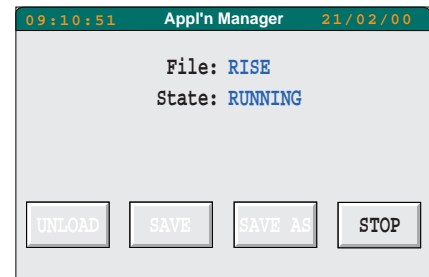

To stop the application, press STOP

The display confirms that the application has STOPPED,

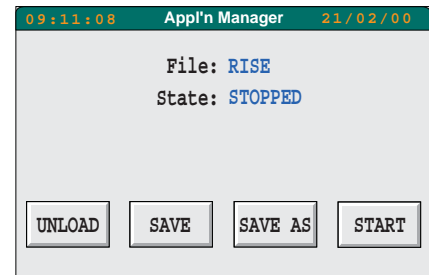

---

Note: While an application is STOPPED, the Logging and Programmer facilities will be suspended. The duration of the current segment will be extended by the length of time the application stays STOPPED. Stopping an application during a critical operation is not recommended.

---

The keys at the bottom of the display offer four options:

UNLOAD the application, without first saving the application data, typically prior to selecting a new application, or cloning a new one.

SAVE the application data, typically because the Cold Start values have changed (usually from the Terminal Configurator).

SAVE AS the data as a different file (SAVE AS).

START the application again.

SAVE, SAVE AS and START are covered in the next section.

---

Note: Any application data saved will not include the current setpoint program.

---



### 4.3.4 Saving application data

The application must be stopped before application data can be saved.

Select SAVE

Saving starts, confirmed by a 'Saving' window.

To save the current application data under a different name, select SAVE AS.

A 'SAVE AS' window appears, with a yellowed field into which another file name can be entered if required (not shown).

To re-start the application, select START

The Appl'n Manager page reverts to its opening display, reporting the current application running.

You can also use START to start another application that you might have loaded.

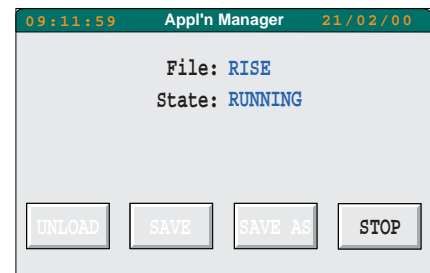
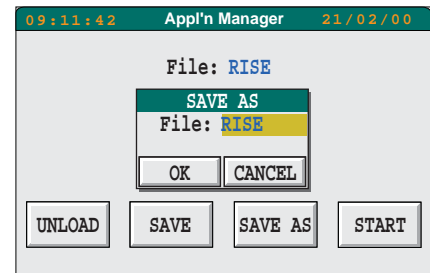
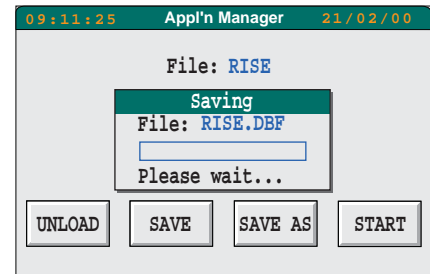
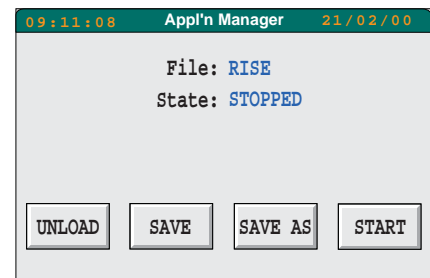

### 4.3.5 Unloading an application

The application must be stopped before it can be unloaded.

Select UNLOAD

The screen might go blank for a few seconds while the application unloads. When the unloading is complete, the Appl'n Manager page should look like this, with three keys offering LOAD, LD+RUN, and DELETE. This is referred to as the 'bare' panel. A new LIN database can be cloned only when in this state.

At this point the choice must be made to load or load-and-run another application, or to delete an application.

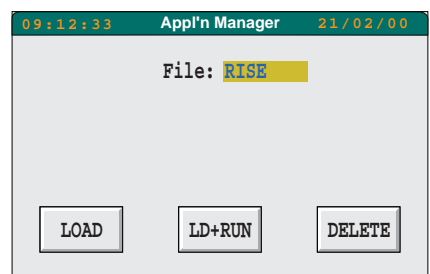
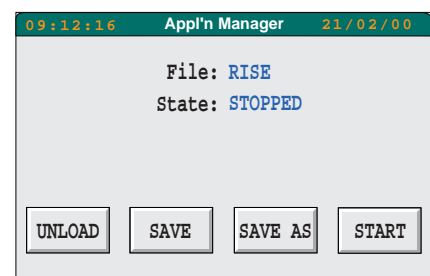

## 4.3.6 Loading or loading and running an application

Before an application can be loaded, any previously-loaded application must have been stopped and unloaded.

### 4.3.6.1 APPLICATION SELECTION

Press the File field

Select the required application from the pick list and press the Return key.

The name is displayed in the File field.

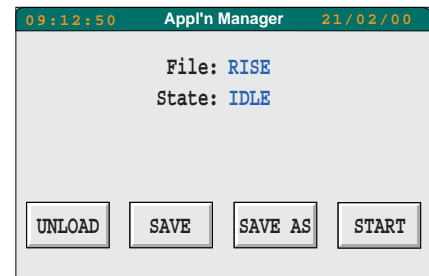

### 4.3.6.2 APPLICATION LOADING

If you select LOAD, there is a short delay before the page shows the name of the application and its state, IDLE.

If LD+RUN is selected, there is a short delay before the page shows the name of the application and its state, RUNNING. The same state can be achieved using LOAD, then START.

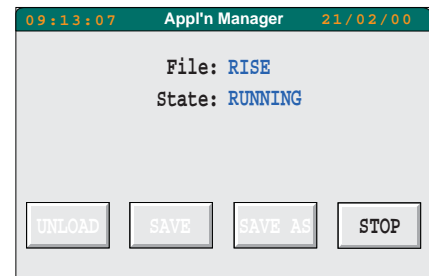

## 4.3.7 Deleting an application

The application must be stopped and unloaded before it is deleted.

Press DELETE

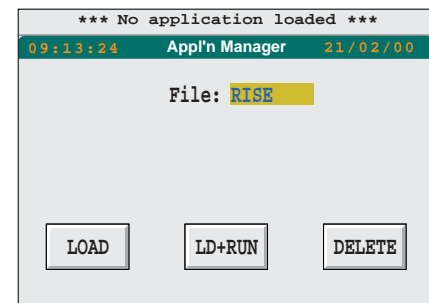

The Confirm Delete window appears.

Press OK

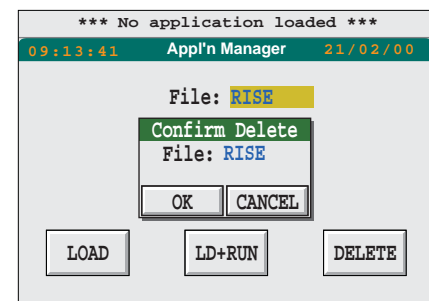

### 4.3.8 Displaying application diagnostics

From the application menu, press DIAGS

The Diagnostic menu appears

Select Modbus or Profibus as required.

The Master Comms Diagnostics page appears.

This presents a list of diagnostic counters. For details of the diagnostics see The LIN Blocks Reference Manual (part no. HA0823754003), the ALH\_DIAG block.

To show diagnostics for a particular Modbus node, change the Node Number from '<ALL>' to the number of the desired node.

To collect statistics from a point in time, press the RESET button to reset all counters to 0.

Application	
APP SUM	APP MGR
DIAGS	FB MGR

Diagnostics	
MODBUS/M	PROFIBUS/M

10:47:10 Master Comms Diags 18/02/00	
Node Number:	<ALL>
Line Fault:	NO
Node Fault:	NO
Requests - Lost:	0
Requests - Aborted:	0
Requests - Total:	495
Replies - Good:	416
Replies - Rejection:	0
Replies - Timed out:	12
Replies - Link Error:	0
Total Cyclic Updates:	64
Late cyclic Updates:	62
RESET	

### 4.3.9 Function block manager

The function blocks set up in LinTools for this application can be viewed as a group, by touching the FB MGR button of the Application pop-up. Touching a particular function Block calls its details to the display. Reference to the LinTools manual will normally have to be made to understand the entries completely.

Highlighted items in the Function Block list can be edited.

Figure 4.3.9a shows how to access the Function Block Manager, and figure 4.3.9b shows the initial Function Block Manager display pages.

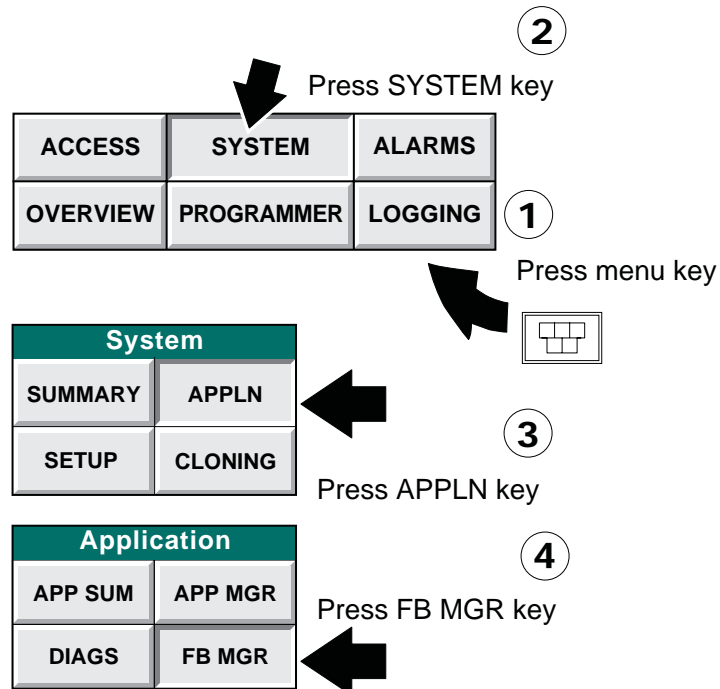

Figure 4.3.9a Access to the Function Block Manager

4.3.9 FUNCTION BLOCK MANAGER (Cont.)

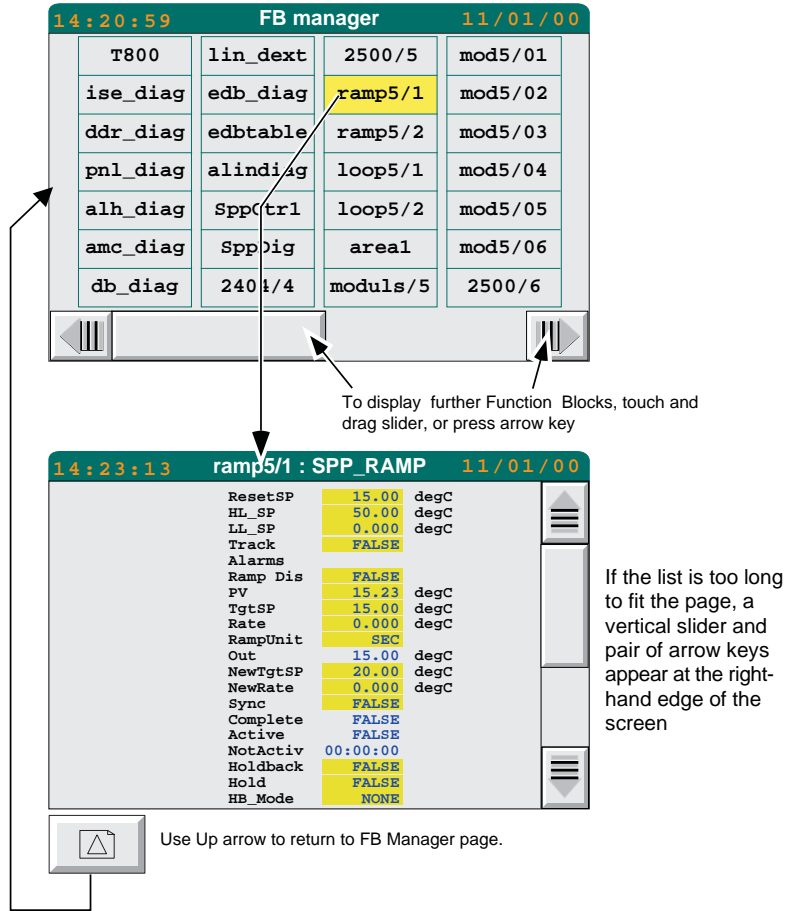

Figure 4.3.9b Function Block Manager Pages

## FUNCTION BLOCK MANAGER (Cont.)

With the data base stopped, the options bar at the bottom of the display contains the keys 'CREATE', 'SAVE' and 'NETWORK'.

Note: For small frame units, the option key toggles the option bar and the scroll bar at the bottom of the screen.

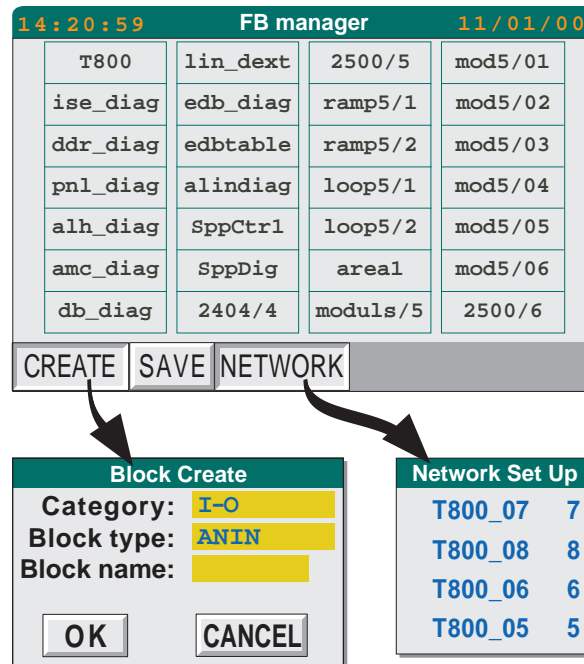

Figure 4.3.9c Create, Save and Network keys

### CREATE

This key allows a new block to be created. Once the block category, block type and block name have been entered, operation of the OK key causes the new block to be created.

### SAVE

Category and Type are selected from pop-up pick lists. The block name must be 'typed in'. Operating this key saves the database in the same way as the SAVE key in the Application Manager ([section 4.3.4](#)).

### NETWORK

Operation of this key displays a list of all the external databases defined within the application.

### 4.3.9.1 ALPHA-NUMERIC BLOCK DISPLAY

Note: This functionality applies only to instruments fitted with software versions 2.7 onwards

Initially, the FB Manager page lists the blocks in 'database order'. Touching the down arrow key (or cycle screens key - if fitted) re-orders the list in alpha-numeric order, with numeric entries first (figure 4.3.9.1). Further operations of the key toggle between the two display orders.

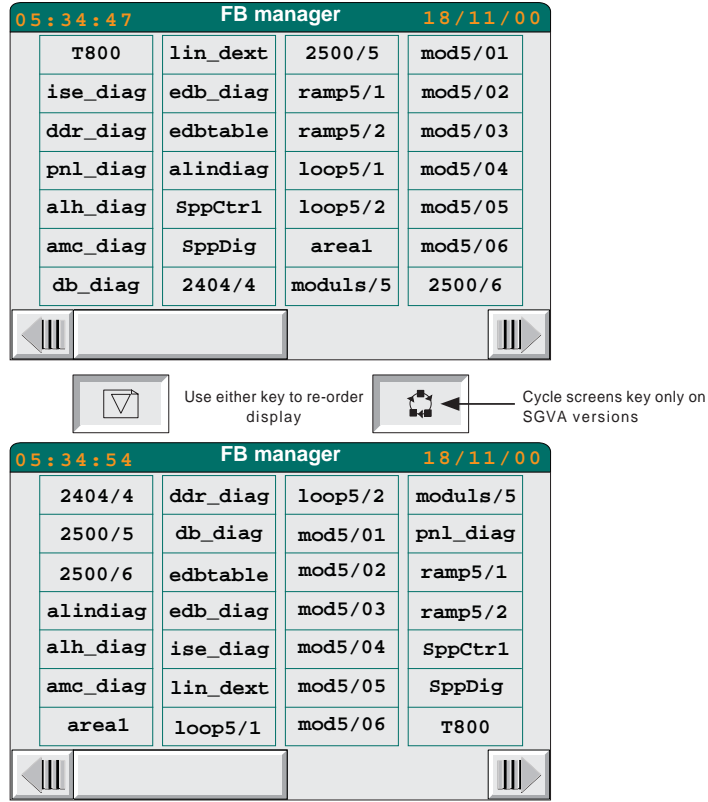

Figure 4.3.9.1 Alpha-numeric Function block ordering.

Note: For the sake of simplicity, only those function blocks shown in figure 4.3.9b have been included in the above figure. In reality, function blocks hidden (off screen) in figure 4.3.9b would replace some of those shown above

4.3.9.2 FUNCTION BLOCK DETAILS

Note: This functionality applies only to instruments fitted with software versions 2.7 onwards

Once a function block has been highlighted, touching the down arrow key (or cycle screens key - if fitted) displays block details - Block name, Block type and update rate (figure 4.3.9.2).

With the data base stopped, the Delete key allows function blocks to be deleted from the database.

A further operation of the down arrow or cycle screens key calls the function block 'Connections' page. If the data base is stopped, this page allows the adding/deleting/modifying of the function block.

In the case of subfields, a number is displayed, which is the number of connections when the database is running, or the number of connectable bits when stopped. Touching the field displays the details of all relevant bits.

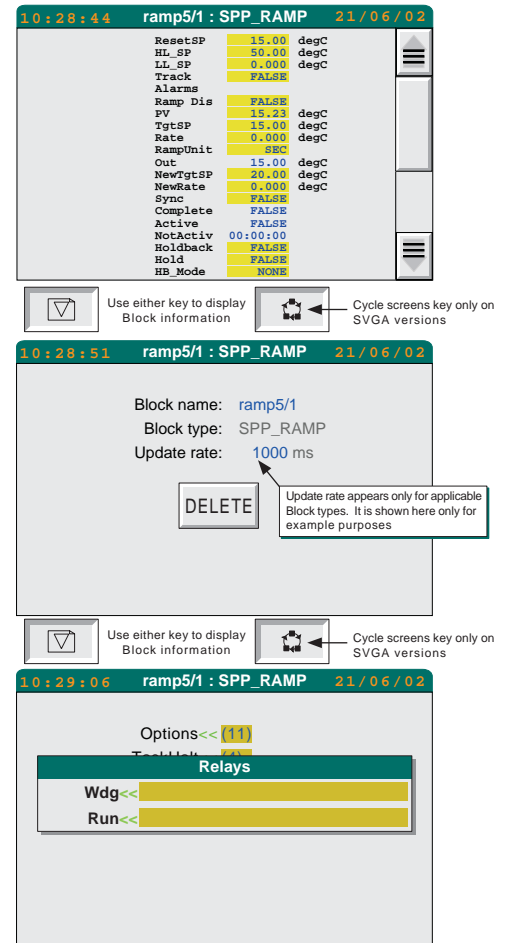

Figure 4.3.9.2 Function block details

4.4 CONTROLLING ACCESS

Note: for instruments fitted with the 'Auditor' option, see also chapter 8.

Access control consists of setting up (and changing, if necessary) the passwords for each of the three types of users: Operators, Commissioning Engineers, and Engineers. Alternatively, for software versions 2.7 onwards, a 'User ID' access system can be used, as described in section 4.4.3, below.

Section 2.8.1, above, contains details of how the passwords/User ID is used to gain access to various parts of the instrument configuration.

As described in section 4.5.5, it is possible to set a time period (time-out) after which the access level returns to 'Locked'.

### 4.4.1 First-time access

**LOCKED level:** For access to the LOCKED level at first-time or at any other time, no password is required.

**OPERATOR and COMMISSION (Commissioning Engineer) levels:**

For first-time access, no password is required.

**ENGINEER level:** For first-time access, immediately after the instrument has been commissioned, the factory-set default password for Engineer-level access should be entered. This password is:

<spacekey>default

I.E. a space character followed immediately by `d e f a u l t` (eight characters in all). The space key on the screen keyboard is the blank key at bottom right, above the 'C' key.

### 4.4.2 Editing the passwords

To change the passwords, carry out the following procedure:

- 1 Press the Menu key.

The Pop-up menu appears.

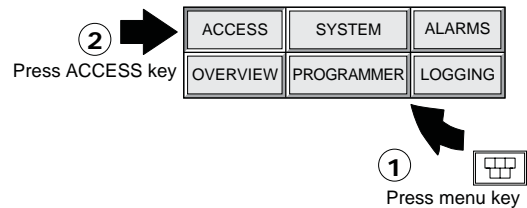

- 2 Press ACCESS.

The Security Access page appears, displaying the current access level (ENGINEER) and two keys: CHANGE and PASSWDS.

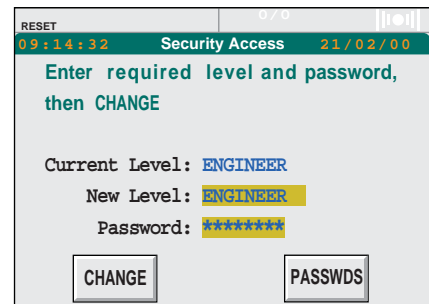

- 3 Press PASSWDS

The Passwords page appears.

- 4 Press the password field you want to change - e.g. Operator

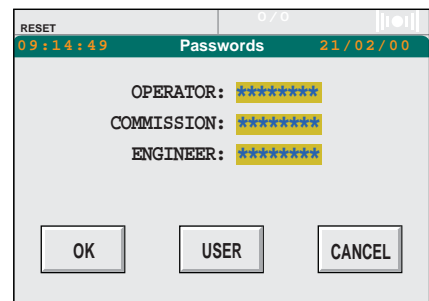

A 'qwerty' keyboard display appears.

(Continued)





#### 4.4.2 EDITING PASSWORDS (Cont.)

- 5 Key in the new password.
- 6 Press the Return key

The Passwords page reappears

- 7 Press OK

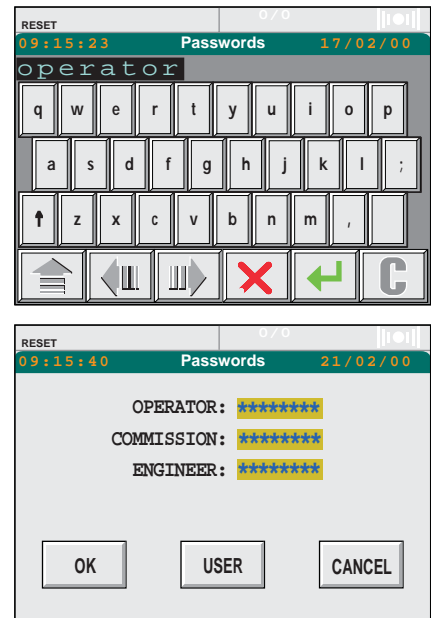

For Commissioning Engineer and Operator passwords, the Security Access page reappears with either COMMISSION or OPERATOR displayed against both Current Level and New Level (depending upon the access level for which you were setting the password).

For Engineer-level passwords only, a Confirm Password window appears, prompting a repeat of the password-entry procedure, as follows in steps 8, 9 and 10.

- 8 Press the password field (still asterisked).
- 9 Key in the new password again, and press the Return key. The Confirm Password window pops up again.
- 10 Press OK. After a short delay, the Security Access page appears with ENGINEER displayed at both Current Level and New Level.

### 4.4.3 User ID system

For software versions 2.7 onwards, the standard system of access described in section 4.4.2 above, can be replaced by a system in which each individual user has a password and ident to allow access to the instrument configuration. The access levels Engineer, Commission and Operator are retained, but with an additional level: Admin.

#### 4.4.3.1 CHANGING TO THE USER ID SYSTEM

**Note:** Changing from the standard access-level system to the user id system is not a reversible process i.e. it is not possible to return to the access-level system from the user id system.

- 1 Press the Menu key and select ACCESS from the pop-up menu. If necessary, change the access level to Engineer
- 2 Press PASSWDS, then USERS.
- 3 Confirm (twice) that the change is to be made.
- 4 Login at Admin level, by
  - a) touching the Identity field and entering ADMIN (must be in capitals) followed by Return, then,
  - b) touching the Password field and entering ADMIN (must be in capitals) followed by Return, then,
  - c) pressing LOG ON.

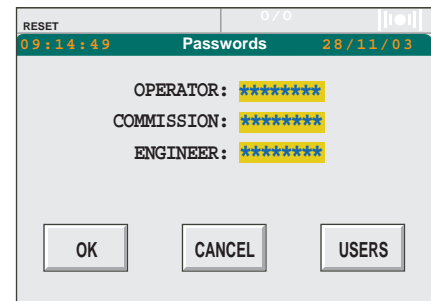

The change has been made to a user ID system of access. It is now necessary to create IDs and passwords for other users, and assign access levels to them, as described in section 4.4.3.2, below.

#### Notes:

- 1 For security reasons, it is recommended that new ADMIN Id and password are entered before any other actions.
- 2 When logging on, it is recommended that the Identity field be cleared completely of any characters before entry of the new Identity. This is be done by positioning the cursor under the first character and operating the 'C' key.

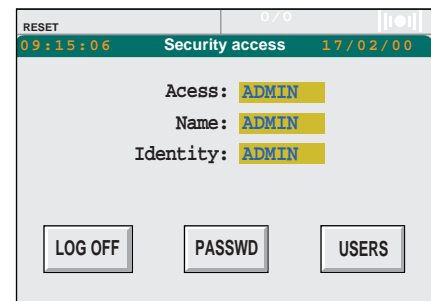

### 4.4.3.2 USER ID MANAGEMENT

Operation of the USERS key calls up a page which allows user identities, passwords and access levels to be assigned. The USERS key appears only for users logged in at ADMIN level.

Figure 4.4.3.2a below, depicts the page. Hidden columns are accessed by a scroll bar which hides the SAVE, CANCEL, NEW etc. keys. When required, these keys are called to the display by operating the Option key one or more times.

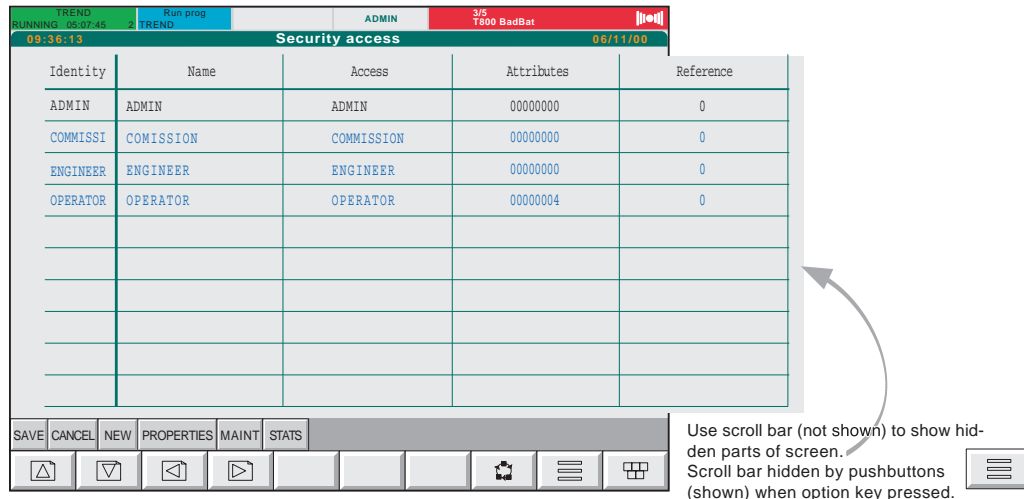

Figure 4.4.3.2a User ID Management page

As is depicted above, the opening display shows one user per access level. In order to edit the Identity (including password), Name, Access level etc. it is necessary only to touch the relevant field (highlights yellow), and edit the entry as required.

#### IDENTITY CHANGE EXAMPLE

**Note:** This procedure is not possible if the unit is fitted with the Auditor option.

To change the Identity 'ENGINEER' to 'Roger' and assign Roger a password of 13.

- 1 Touch the word ENGINEER in the Identity column.
- 2 Touch the word ENGINEER in the Identity field of the resulting dialogue box (figure 4.4.3.2b).

Identity:	ENGINEER		
Password:	*****		
Confirm:	*****		
OK	CANCEL	DELETE	DISABLE

Figure 4.4.3.2b ID Edit page

- 3 Enter 'Roger' using the POP-UP keyboard, followed by Return.
- 4 Touch the yellow Password field, and enter the number 13 using the keyboard.
- 5 Touch the yellow Confirm field and enter the number 13 using the keyboard and press OK. If this entry differs from the first, OK has no effect, and the Confirm field remains highlighted.

To write the changes to the data base, press the SAVE key (first using the Option key to display it, if necessary). Otherwise press CANCEL.

### 4.4.3.2 USER ID MANAGEMENT (Cont.)

#### Editing other fields

The editing of remaining fields is carried out in a similar manner, except for the access level field which is selected from a pick list rather than being typed in as a keyboard entry.

#### Attributes column

Touching this column allows the ADMIN level user to enable or disable the following functions for all other users: View only, Admin only, FTP, Remote, User button, User screen. All functions are set to 'No' by default. The display column reflects the features set to 'Yes', as shown in the table below. The numbers are cumulative, so, for example, if 'View only' and 'FTP' were both selected 'Yes' and all other items 'No', the attribute display would be 00001000

View only	Admin only	FTP	Remote	Display
No	No	No	No	00000000
Yes	No	No	No	00000004
No	Yes	No	No	00000010
No	No	Yes	No	00001000
No	No	No	Yes	00002000

Table 4.4.3.2 Attribute coding

#### View only

Users with this attribute set, have Read Only permission

#### Admin only

This attribute appears only for users with Admin Access level, and means that they can modify only ADMIN pages. If View only is also set, such users are denied all write permissions.

#### FTP

Users with this permission may log in via FTP. FTP users who are View only, are prevented from file system modification, and their logins are not recorded.

#### Remote

Not used with this software release

#### Reference column

For use with user screens, set up in Lin Blocks, this allows individual users, or groups of users allocated the same reference number, to be identified as being logged on.

#### Deleting (Retiring) users

To delete a user, touch the required name in the Identity column, and press DELETE in the resulting dialogue box. To complete the process, press OK in the confirmation dialogue box.

#### Notes:

1. For units fitted with the Auditor option, the DELETE key is named 'RETIRE'. See Chapter 8 for more details.
2. It is not possible to delete the current user.
3. A list of Retired Users can be viewed by touching the 'Cycle Screens' key.  
A second operation of the key returns the user to the Current Users list.



#### Disabling user IDs

To disable a user, touch the required name in the Identity column, and press DISABLE in the resulting dialogue box. The Identity and name of the disabled user appear in red, and the user will not be able to log on, until the login has been re-enabled. To re-enable the login, touch the required name in the Identity column, then re-enter the password and confirm it. The Identity and Name return to their previous blue colour.

It is not possible to disable the current user.

### 4.4.3.2 USER ID MANAGEMENT (Cont.)

#### New Users

New users are entered using the 'NEW' key at the bottom of the page (first using the Option key to display it, if necessary). The new identity and the password are entered as described in the example above.

The new information appears in green, until the SAVE key is operated. (If necessary, use the Option key to display the SAVE key.)

#### Notes:

1. For instruments fitted with the Auditor option, it is not possible to create a new user with a previously 'retired' ID. See section 8 for more details.
2. For instruments fitted with the Auditor option, it is not possible to edit any aspect of an account once the SAVE key has been operated. It is therefore essential to ensure that all entries are correct before saving.

#### Account properties

Figure 4.4.3.2c, below, shows a typical properties page, called by operating the 'PROPERTIES' key at the bottom of the screen. See section 8 for Audit pack variances.

Figure 4.4.3.2c Properties page (typical)

**Note:** Please also refer to Section 8.4.1 if the Auditor Option is fitted.

Min User ID Length	2 to 8	
Min Password Length	0 to 8	
Max Login attempts	0 to 99	(0 = no limit; Values greater than 0 show the number of attempts at logging in that may be made before the account is disabled.
Password Expiry	0 to 180	0 = password never expires. For values greater than 0, the password will expire after the specified number of days have elapsed since the last time the value was edited.
User Timeout	0 to 720	0 = no timeout. For values greater than 0 the user will be logged out after the specified number of minutes has elapsed since the previous screen activity.

#### 4.4.3.2 USER ID MANAGEMENT (Cont.)

##### Maintenance

Operating the 'MAINT' key at the bottom of the Security Access screen calls the 'Account Maintenance' screen to the display, as depicted in figure 4.4.3.2d, below.

If recovery account is set to YES, this enables a recovery in the event of all ADMIN accounts becoming unusable. This requires a maintenance contract with the manufacturer.

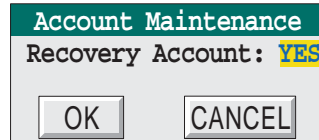

Figure 4.4.3.2d Maintenance screen

---

**Note:** See also Section 8.4.1 if the Auditor Option is fitted.

---

##### Statistics

Operating the STATS key at the bottom of the Security Access screen calls the 'Statistics' screen, showing how many users have been configured out of the total available. For example, Users: 6/100 means that six of the 100 possible users have been configured.

---

**Note:** For small frame instruments, a second operation of the Option key is necessary to reveal the STATS key.

---

## 4.5 SETTING UP AND RE-SETTING THE INSTRUMENT

This section describes the following items

1. Editing Comms parameters (Section 4.5.1)
2. Setting the Start-up strategy (Section 4.5.2)
3. Re-setting the clock (Section 4.5.3)
4. Changing the language and the data entry formats (Section 4.5.4)
5. Setting up the panel display (Section 4.5.5).

### 4.5.1 Editing communications parameters

The editing procedure for Communications Parameters consists of displaying the Comms Setup page and setting up or editing the parameters for each port fitted to the unit.

The SAVE button is used to save the changes, or to cancel the changes before saving them, the CANCEL button is used.

Before any saved changes can take effect, the application must be stopped and then restarted, or the instrument must be powered off and on again. Generally, ‘parameter’ changes (such as baud rate) require only a stop and restart of the application, whereas ‘hardware’ changes (such as changing a Modbus master port to a slave port) require a power down and up.

1. Press the Menu key and select SYSTEM from the Pop-up menu.
2. Press SETUP
3. Press COMMS.

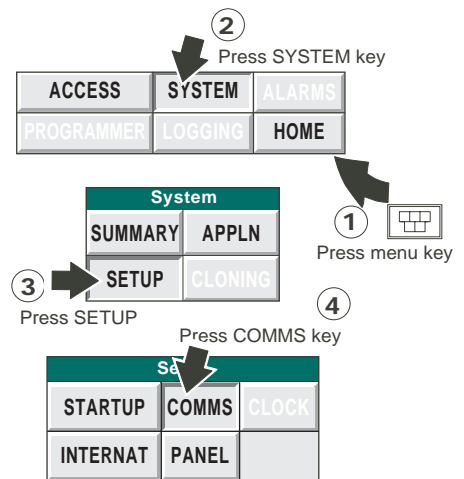

The Comms Setup page appears.

For each port (CFG, SLV, MST...) there is a column of parameters (Hardware, Protocol, Mode No...). If necessary, the vertical scrollbar can be used to display more parameters hidden further down the page. The full list is:

- Hardware Standard (for example, RS422) (EIA422)
- Protocol (for example, Modbus Slave)
- Node Number (decimal)
- Baud (rate)
- Parity
- Data bits (number of)
- Stop bits (number of)
- Timeout (Modbus Master only, in milliseconds)
- TalkThru (Modbus Slave only - see 4.5.1.4).

PORT	CFG	SLV	MST
Hardware	RS232	RS422	RS422
Protocol	SLIN	Modbus/S	Modbus/M
Node No.	1	0	
Baud	9600	19200	19200
Parity	EVEN	EVEN	EVEN
Data Bits	8	8	8

SAVE CANCEL ETHERNET

### 4.5.1 EDITING COMMUNICATIONS PARAMETERS (Cont.)

Cells with a yellow background are edited by pressing them. Others with a white background are fixed (not editable). A blank cell shows that the parameter does not apply for the protocol selected for that port.

1/4VGA instruments with up to three ports always display the SAVE and CANCEL keys at the bottom. 1/4VGA instruments with more than three ports feature a horizontal slide bar at the bottom, which can be used to reveal columns hidden to the right for other ports. In such a case, the Option key is used to display the SAVE and CANCEL keys, temporarily, in place of the slidebar. SVGA instruments always display the SAVE and CANCEL keys.

#### 4.5.1.1 SOFTWARE PARAMETER EDITING

1. Select the required parameter
2. Select or enter the new value from a pop-up list or keyboard
3. Press the green Return key at the bottom of the pop-up. The new value is displayed.
4. Either press the SAVE button to save the change, or press the CANCEL key to abort the change.

#### 4.5.1.2 HARDWARE CHANGES

1. Change the position of the Comms jumpers on the Interconnect board within the instrument, as described in detail in Section 1.4.1. Switching Communications protocols.
2. With no application loaded, press the Option key under the screen. This calls the 'Hardware' key to the display.
3. Press the Hardware key.
4. A warning 'Hardware Check' message appears. To comply, disconnect the instrument from any equipment (see the Caution below).
5. Press OK to cancel the screen warning.
6. The screen redraws and shows the new settings. If these do not correspond to the required values, check that the jumpers have been set to the correct positions.

---

#### CAUTION

Pressing the Hardware key does two things:

1. For the other parameters, it sets default values
  2. It causes spurious characters to be transmitted from both the SLV and MST ports. To ensure that this stream of characters cannot produce faulty readings or damage any other equipment connected, it is recommended that such equipment be disconnected.
-



### 4.5.1.3 PROTOCOLS AVAILABLE

Notes:

1. Ports in parentheses ( ) are not recommended for the associated protocol.
2. CFG port is always EIA232.
3. MST/SLV ports are always EIA422/485.
4. All protocols use 8 data bits except TERMCFG and Printer which use 7 or 8.
5. The Node Number (where presented) must be non-zero to enable the port.

PROTOCOL	PORT	NOTES
ALIN	ALIN	Used to connect a Local Instrument network (LIN) together. The two connectors are wired in parallel for easy daisy-chaining.
DPv1/M	PBUS1	Profibus master communications, supporting Profibus PD and PD1 extension. It is advisable to set the noded number as low as possible, as performance can be affected by high node numbers. It must be ensured, however, that the node number does not clash with any slave's node number.
ELIN	ENET1	Appears only if the Ethernet option is fitted, and is used to connect a Local Instrument network (LIN) across Ethernet.
FTP	ENET2	Used to provide an FTP server if the Ethernet option is fitted.
Keypad	KBD	Enables keypad operation
MODBUS/M	MST (SLV)	The full name of the protocol is 'Modbus RTU master'.
MODBUS/S	SLV, CFG, MST, ENET3	The full name of the protocol is 'Modbus RTU slave'. It is used for the 'Talk-thru' facility, and for direct connection with a Modbus master. ENET3 port is for Modbus/TCP on enhanced units with the ethernet option fitted.
Printer	CFG LPT	Serial printer communications (if fitted) Parallel printer communications (if fitted)
Reader	KBD	Bar code reader communications (if option fitted)
SLIN	CFG	The full name of the protocol is 'Serial Lin'. It is used for connecting with a PC, in order to transfer files during comissioning and during operation.

Table 4.5.1.3 Available protocols

Changes to Protocol selection become effective at different times, as follows:

CFG	On power-up for SLIN; On application start for Modbus/S
ELIN1,2,3	On power up
MST/SLV	On application start
SLIN/ALIN/Keypad	On power up

### 4.5.1.4 TALK-THRU

Talk-Thru, or transparent Modbus access) is a facility provided to enable use of the Eurotherm iTools package to configure Model 2500 controllers without having to disconnect them from the Visual Supervisor. The 2500s are 'daisy-chained' from the Instruments's Modbus Master port or the Profibus port on the rear panel via an EIA422 link.

The PC is connected to the CFG port on the front panel via an EIA232 link. With the iTools package running on the PC, the 2500s can then be configured by 'talking through' the Visual Supervisor.

Notes:

1. In order for TalkThru to work, the database must contain a Gateway file (.GWF) with the same name as the database file (.dbf).
2. If the Profibus port is used, the 2500 unit(s) must support Profibus DPv1.
3. Instead of using PC/iTools via an occasional EIA232 link, a SCADA facility can be used via a permanent EIA422 link. In this case the link must be to the Modbus/S port at the back of the Visual Supervisor.
4. PC/iTools can also be connected to the Modbus/S port, but needs an EIA422/485 convertor. For an occasional link it is more convenient to use the CFG port on the front panel as described above.
5. For more information refer to the iTools User Manual (part no. HA026179).
6. The PC may be connected across ethernet using Modbus/TCP instead of one of EIA232/422/485.

### 4.5.1.5 ETHERNET

The following applies only if the Ethernet option is fitted.

Notes:

1. Before operating the 'ETHERNET' button, operate the 'SAVE' button, or all changes made so far will be lost.
2. Before operating the COMMS button to return to the Comms setup page, operate the SAVE button, or all changes made in the Ethernet setup page will be lost.
3. On the small frame (1/4 VGA) version of the instrument, the three buttons 'SAVE', 'CANCEL' and 'ETHERNET' are hidden by a scroll bar. The Option key is used to toggle between the scroll bar and these buttons. 
4. The user must have suitable access permission in order to edit the Ethernet setup.

Ethernet setup is accessed by operating the 'Ethernet' key at the bottom of the comms set-up page. Figure 4.5.1.5 show the relevant fields. To return to Comms setup, operate the Comms button.

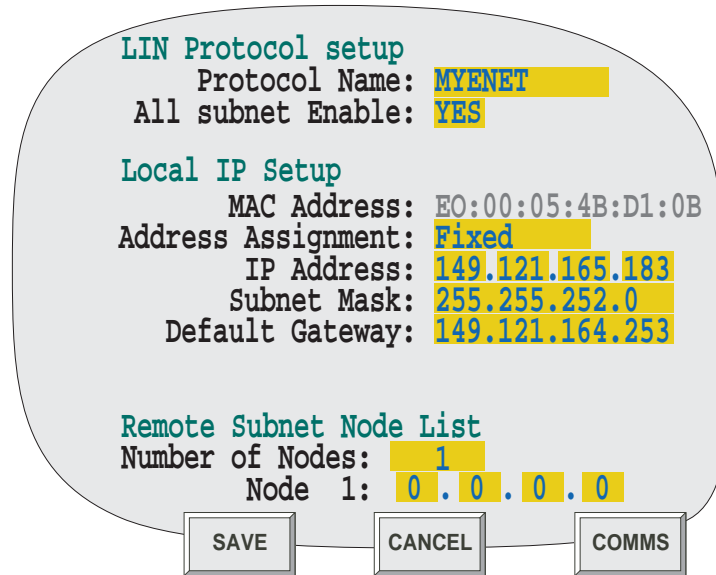

Figure 4.5.1.5 Ethernet setup items

Protocol name	Allows the user to enter a protocol name of up to 12 characters.
All Subnet enable	Select Yes or no.
MAC ADDRESS	This factory-set address is unique to the instrument and is non-editable.
Address Assignment	Select one of: Fixed, DHCP, BootP, DHCP+LL, BootP+LL, Link Local.
IP Address	May be edited only if 'Fixed' selected as Address assignment.
Subnet Mask	May be edited only if 'Fixed' selected as Address assignment.
Default Gateway	May be edited only if 'Fixed' selected as Address assignment.
Number of nodes	Enter 0 to 50. This is the number of nodes in the remote subnet.
Node N:	Allows the IP address of each remote node to be entered.

## 4.5.2 Setting the start-up strategy

Hot and Cold starts are ways of starting the instrument automatically, after a power failure or after a power variation large enough to trigger an alarm (a 'brown out'). The strategy is set by choosing Hot Start, Cold Start or both, and by choosing time-out intervals for Hot Start and Brown Out.

### HOT/COLD START CRITERIA

The type of start selected depends upon the process, and upon the operational policy of the user. For example, some processes are so sensitive that a power-loss of any duration will always mean that the process plant or the load, or both, will need manual attention before re-starting. In this case automatic restart (either hot or cold) would be inappropriate.

#### Hot start and Cold start selected

The most common strategy is to set both the Hot Start and the Cold Start to YES so that, should power return before the end of the time-out, the instrument will attempt a Hot Start. If the time-out has expired the instrument makes a Cold Start.

#### Hot Start only.

A power loss, or a 'brown-out' lasting long enough to trigger an automatic restart, which returns to normal before the Hot Start time-out, causes the instrument to attempt a Hot Start. If the power does not return to normal within the time-out period, a manual restart will be required, as described in section 3.1.1 (Running a program now).

#### Cold start only

If a power loss, or a 'brown-out' lasting long enough to trigger an automatic restart occurs, then, provided that power returns before the Hot-start time-out interval, the instrument will do a Cold Start on power-up.

#### Neither Hot start nor Cold start

If both Hot start and Cold start are set to 'No' the instrument will not restart automatically under any circumstances.

### 4.5.2.1 START-UP STRATEGY PAGE

1. Press the Menu key
2. SYSTEM from the pop-up menu.
3. Select SETUP
4. Select STARTUP

The Start-up Strategy page appears

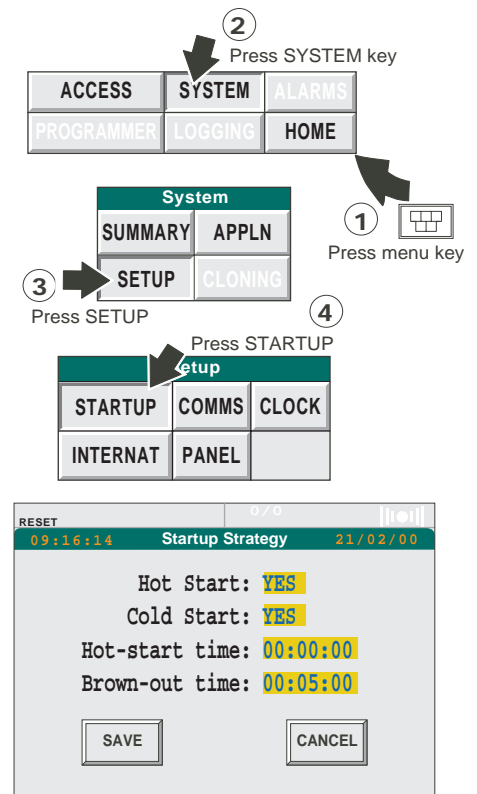

### 4.5.2.1 START-UP STRATEGY PAGE (Cont.)

**Hot start** A Hot start uses data about the current application that the instrument automatically saves in case of power variation or failure. Using this information, which is preserved through any power loss, the instrument can automatically restart the process at any time after normal power returns.

In the fields on the Start-up Strategy page, the following items need to be configured:

1. Whether the process is to start automatically after a power loss
2. A maximum time period (time-out), after the expiry of which, a hot start is inappropriate.

**Cold-Start** Cold Start data is application data, not just program data, so its scope is much wider.

**Hot start time:** This depends upon the process under control. If the process can tolerate only a short time without normal power before either the plant or the load requires manual attention, then a short time-out needs to be set. If, however, the process is robust enough to regain normal processing conditions even after a lengthy power-outage, then a longer Hot Start time-out may be set. Actual times are process-dependent, but the general rule is that the process must not restart automatically beyond the time when it requires manual attention.

**Brown-out time** This sets an alarm when a power-variation has persisted for longer than a preset time. Unless the alarm is set up to take some action, the Brown-out time acts only as a warning, in case some special strategies exist that might need implementing in those circumstances, or that have been set up to run automatically.

If power totally fails but returns within the interval specified as Brown-out time, then the instrument treats it as a brown-out. If it returns after the Brown-out time, then a restart is either possible or certain, depending on how soon after the time limit it returns.

The type of restart attempted depends on the programmed strategy.

### 4.5.2.2 CHANGING START-UP VALUES

#### Changing Hot/Cold start settings

In the Startup Strategy page, press the Startup setting to be changed. Edit the entry using the pick-list which appears, then press Return. The pick-list disappears and the Startup Strategy page displays the new value.

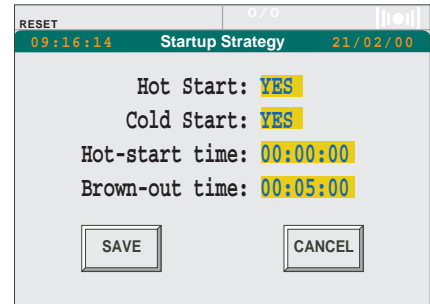

#### Changing time-out values

In the Startup Strategy page, press the time-out value to be changed. Key-in the new value using the pop-up keyboard, then press Return. The field shows the new value.

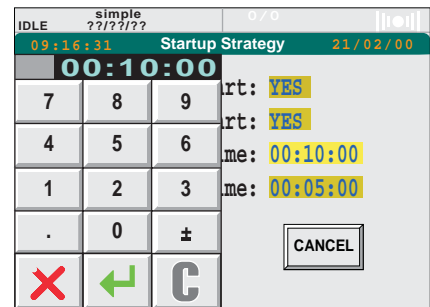

### 4.5.3 Resetting the clock

#### 4.5.3.1 CLOCK SETUP PAGE ACCESS

- 1 Press the Menu key
2. Select SYSTEM from the pop-up menu
- 3 Select SETUP.
- 4 Select CLOCK.

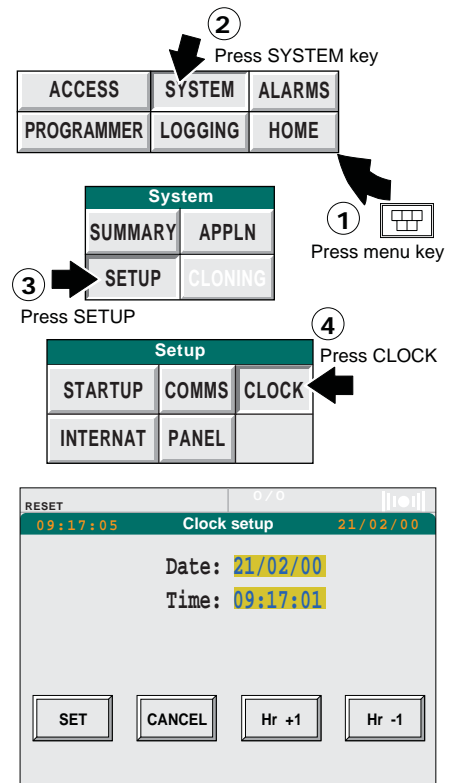

The date/time setting page appears

#### 4.5.3.2 CHANGING DATE AND TIME

To increment or decrement the hours value, press the Hr+1 or the Hr-1 key respectively. The change takes place immediately, and changes the date if appropriate.

**Notes:**

- 1 Operating the SET key enters the time and date displayed on the page. These values are not updated in real-time, but show the values obtaining when the page was called to the screen. As it is not possible to SET the date separately from the time, it is recommended that the date be changed first, then the time.
2. The clock re-starts when the SET key is pressed. This happens after the time has been keyed in and after the Return key has been pressed. It is therefore recommended that the keyed-in time is at least 20 seconds ahead of real time, so that the SET key can subsequently be operated (to start the clock) when real-time equals the keyed-in time.
3. For systems configured to have their clocks synchronised by another network node, it is not possible to edit the time or date if the master clock is running.

**Date changing**

From the Clock Setup page, touch the date field.

A numeric keyboard is displayed, allowing the correct date to be entered. The cursor moves to the next digit after each character has been entered.

To cancel all the digits (the ones at the top of the keyboard display, but not the ones in the Clock Setup page in the background, or in memory), press the 'C' key - the digits change to question marks.

To cancel the whole time-change operation and return to the Clock Setup page, press the red cross key.

Once the correct date has been entered, operate the Return key. To save the entry and re-set the date press the SET key.

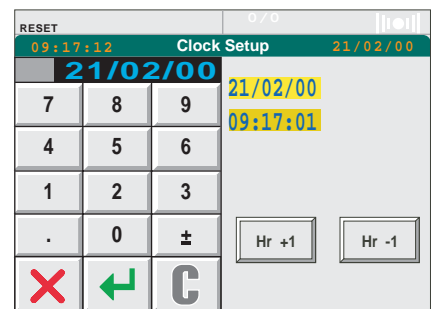

### 4.5.3.2 CHANGING DATE AND TIME (Cont.)

#### TIME CHANGING

Before starting, please see note 3 on the previous page.

From the Clock Setup page, press the time field.

A keyboard is displayed, with the current time displayed in green at the top with a cursor flashing under the first hours digit.

Type-in the required time (the cursor moves to the next character after each number is keyed-in)

To cancel all the digits (the ones at the top of the keyboard display, but not the ones in the Clock Setup page in the background, or in memory), press the 'C' key - the digits change to question marks.

To cancel the whole time-change operation and return to the Clock Setup page, press the red cross key.

When new time has been entered, press the green Return key.

When the actual time is the same as the time just entered, press the SET key to re-start the clock.

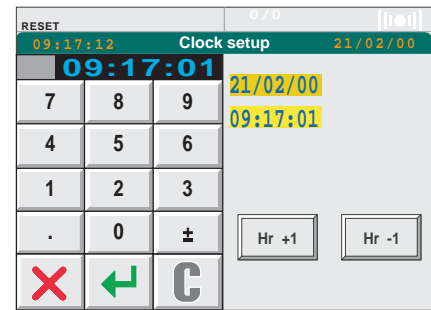

### 4.5.4 Changing language and date/time formats

A different language can be selected only if the instrument holds the appropriate language dictionary file. See section 5.2, The System text dictionary.

- 1 Press the menu key.  
The Pop-up menu appears.
- 2 Select SYSTEM.  
The System Pages window appears.
- 3 Select SETUP.  
The Setup window appears
4. Select INTERNAT.

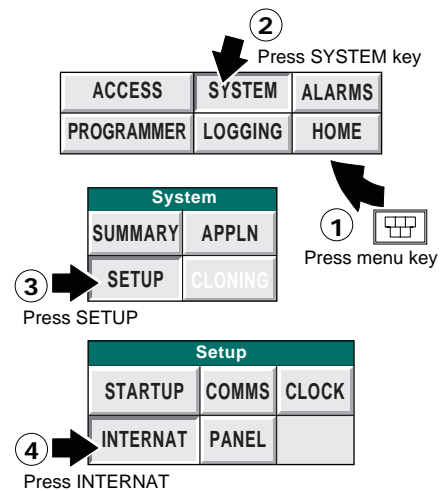

The Internationalise page appears.

The following subsections describe each of the four yellowed fields displayed on the Internationalise page.

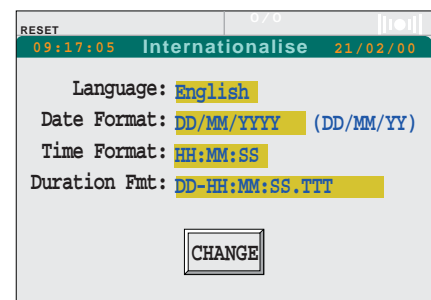

#### 4.5.4 CHANGING LANGUAGE/DATE FORMAT (Cont.)

##### 4.5.4.1 LANGUAGE

If the Language field is touched, a pick-list appears, showing which languages are available. Select the required language and press Return.

The pick-list disappears.

Press CHANGE. The Language field shows the selected language



##### 4.5.4.2 DATE FORMAT

If the Date Format field is touched, a pick-list of the available Date Formats appears. Select the required format and press Return.

The pick-list disappears.

Press CHANGE. The Date Format field shows the selected format.

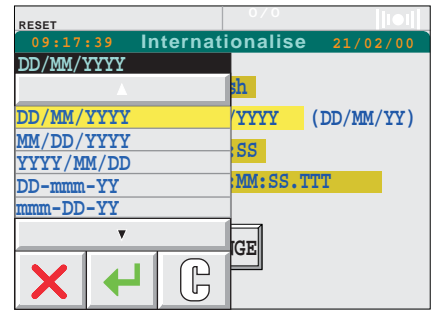

##### 4.5.4.3 TIME FORMAT

If the Time Format field is touched, a pick-list of the available time formats appears. Select the required format and press Return.

The pick-list disappears.

Press CHANGE. The Time Format field shows the selected time format.

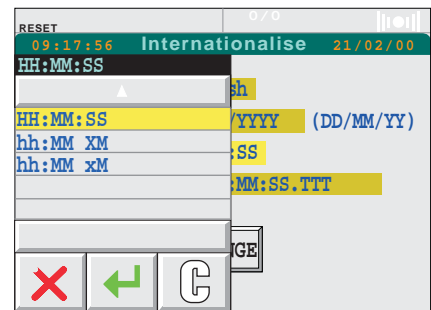

If the Duration Format field is touched, a pick-list of the available time duration formats appears.

Select the required format and press Return.

The pick-list disappears.

Press CHANGE. The Duration Format field shows the selected format.

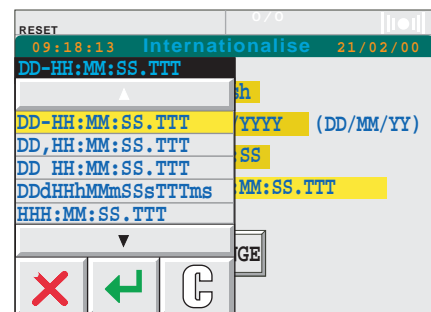

### 4.5.5 Setting up the panel display

The following items can be edited from the Panel Setup page:

1. Backlight properties (1/4 VGA units only)
  - Display Normal and Saver brightness
  - Saver Time-out (a value of 0 means no time-out)
  - Saver brightness is the screen brightness when the screen saver timeout expires.
  
2. Page time-out values (a value of 0 means no time-out)
  - Home (for any Home pages)
  - Pop-up (for the Pop-up menu)
  - Data Entry (for the pick-lists and keypads)
  
3. Time-out to return to Access Level 'Locked' (a value of 0 means no time-out).
 

If this is enabled (by adding an entry into the text dictionary (Section 5.2.4, No. 331)) then a time-out period can be set. If the screen is not touched during this period, the instrument access level returns to 'Locked'.

#### 4.5.5.1 ACCESS TO THE PANEL SETUP PAGE

- 1 Press the menu key.
- 2 Select SYSTEM.
- 3 Select SETUP.
- 4 Select PANEL.

ACCESS	SYSTEM	ALARMS
OVERVIEW	PROGRAMMER	LOGGING
HOME		

System	
SUMMARY	APPLN
SETUP	CLONING

Setup		
STARTUP	COMMS	CLOCK
INTERNAT	PANEL	

The Panel setup page appears

15:55:34 **Panel Setup** 18/02/00

**BACK-LIGHT**

Brightness: 70%

Saver brightness: 20%

Timeout: 0 minutes

**PAGE TIMEOUTS**

Home: 0 minu

Pop-up: 0 seco

Data Entry: 0 seco

Access: 0 minu

'Access' appears only if the relevant entry has been made in the text dictionary.



#### 4.5.5.2 DISPLAY BRIGHTNESS SETTINGS

Note: The brightness adjustment/screen saver described below applies only to 1/4VGA units. SVGA instruments are of fixed brightness

To prolong backlight life, it is recommended that the normal brightness be set to 70% or lower and that the screen saver be used if the instrument is on but not continuously manned. Pressing either the Brightness or Saver Brightness fields brings up a pick-list of alternative percentage values, staged at 10% intervals.

Choose the required value(s), then Press Return

The pick-list disappears.

To save the selection, press SAVE.

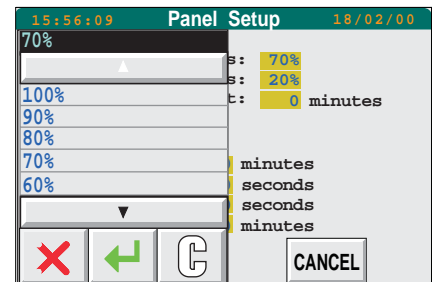

#### 4.5.5.3 TIME-OUTS

Pressing any of the other fields brings up a numeric keyboard, from which new values for the various time-outs can be entered.

After each entry, press Return.

The keyboard disappears.

To save the value, press SAVE.

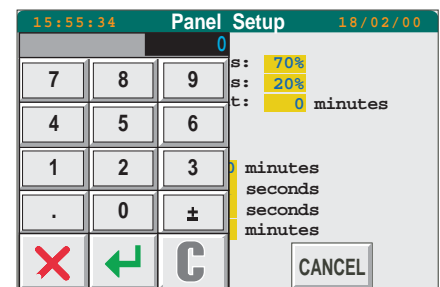

#### 4.5.5.4 DATA ENTRY

Note: The following adjustment applies only to SVGA (large screen) units.

The size of the Data Entry pop-up can be reduced by selecting 'Small' for the item 'Data entry'

## 4.6 CLONING AN INSTRUMENT

Cloning an instrument consists of copying data between instruments via the floppy disk (A) or USB Bulk storage device (B), in order to replicate either the characteristics of the instrument or of the application, or both. It can also be used to backup data (for example, programs).

### Notes:

1. It is recommended that Logging be turned off before cloning is attempted. It is not recommended that Cloning data and Logging data share the same disk.
2. If Intellectual Property Rights Protection (IPRP) (section 4.9.1) is enabled, then data may be cloned only to the original instrument, or to another with the same IPRP settings.

This section consists of the following subsections:

Accessing the Cloning page (Section 4.6.1)

Cloning application data (Section 4.6.2)

Cloning system (instrument) data (Section 4.6.3)

Cloning both application and system data (cloning ALL) (Section 4.6.4).

### 4.6.1 Accessing the cloning page

- 1 Press the Menu key
- 2 Select SYSTEM.
- 3 Select CLONING

The Cloning page appears.

- 4 Press the Application field (yellowed)

A pick-list appears, allowing 'System', 'Application' or 'ALL' to be selected

The highlighted field ('Application' in this example) indicates which type of data was last selected for cloning.

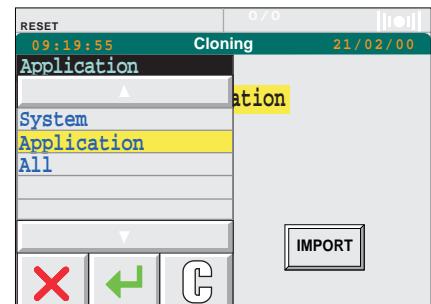
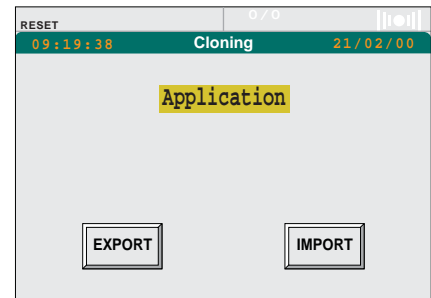
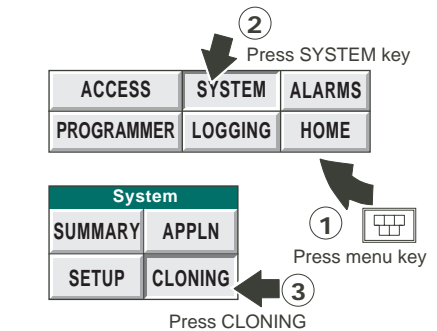

## 4.6.2 Cloning application data

This consists of:

1. Exporting application data (Section 4.6.2.1)
2. Importing application data (Section 4.6.2.2)

### 4.6.2.1 EXPORTING APPLICATION DATA

From the Cloning page, select Application.

The Application Data Cloning page appears displaying the following fields, described below

- 1 Control Database
- 2 SFCs (Sequential Function Charts)
- 3 Programs/Recipes
- 4 User pages
- 5 Forms
- 6 Comms Profiles

Control Database	This is the instrument's LIN database, consisting of file types .dbf, .gwf, .run, and .uyn.
SFCs	Sequential Function Charts are part of any special strategies in software that may have written to support particular events, circumstances or requirements. They consist of .sdb files.
Programs/Recipes	Setpoint programs and/or recipes that have typically have been created on this instrument and which the user now wishes to copy to another instrument. These files can be large enough to fill most of a floppy disk, so the pick-list of data-types allows, for example, the database, SFCs and user pages to be loaded onto one disk, and the recipe programs on to another. Recipes and Programs consist of .uys and .uyr files, and if Batch files are present, .uyb files.
User pages	Written by users to satisfy the control requirements of their particular process. User pages may consist of a single Home page, or a hierarchy of user pages with a Home page at its root. They consist of .ofl and .pnl files.
Forms	Text files that determine how reports and alarm formats for printers are generated. Consist of .uyt and .uyf files.
Comms Profiles	Parameters that determine how the instrument communicates with other instruments. Consist of .uym, .uyp and .gsd files.

Once the required fields have been set to YES the data is exported by touching the EXPORT key at the bottom of the page.

### 4.6.2.2 IMPORTING APPLICATION DATA

From the Cloning page, select IMPORT. The same page as for exporting (shown above) appears with the same fields.

---

#### Notes:

1. Imported user pages take immediate effect.
  2. .pnl files need the application to be unloaded and reloaded to take effect.
  3. Imported Comms profiles need the application to be restarted to take effect.
-

## 4.6.3 Cloning system (instrument) data

### 4.6.3.1 SELECTING SYSTEM DATA

From the Cloning page, showing the pick-list of System, Application and All, select System

Press Return

The Cloning page confirms the selection.

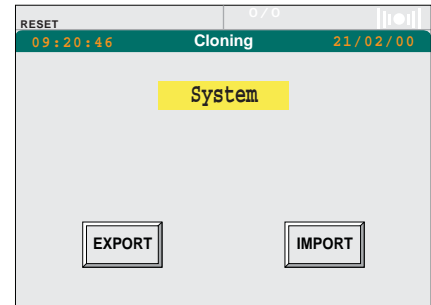
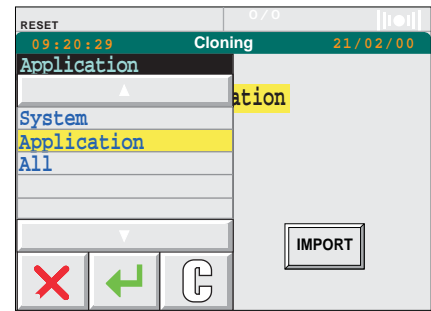

### 4.6.3.2 EXPORTING SYSTEM DATA

Select EXPORT.

The System Data Cloning page appears with three fields as described below:

1. Config Options
2. Dictionaries
3. User Pages

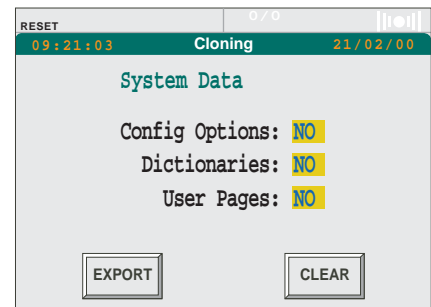

**Config Options** These are: startup strategy, panel settings, comms settings, and current language. Basically they are instrument operation preferences. If the Auditor pack option is enabled, Security Access (if the unit is an Access System Master), Network Audit Trail Setup and Signature Setup are also presented.

**Dictionaries** Dictionaries are items within Customisation (see Chapter 5 of this manual).

**User pages** User pages also form part of Customisation.

---

**Note:** If Access is selected, the exported data must be imported into the destination unit within 60 minutes of export time.

---

### 4.6.3.3 IMPORTING SYSTEM DATA

Imported config options apply on next power-up; dictionaries apply on next power-up or on next change of preferences.

From the Cloning page, select IMPORT. The same page appears as for exporting (shown above) and the same explanations apply.

---

**Note:** An instrument may import access data only if it has been exported by the source unit within the previous 60 minutes.

---

#### **4.6.4 Cloning both application and system data (ALL)**

From the Cloning page, select ALL.

Thereafter the procedures are similar to those in sections 4.6.2. and 4.6.3.

## 4.7 FILE MANAGER

The File Manager allows the copying of files between the internal Flash memory and a floppy disk loaded in the unit's disk drive. It also allows files to be deleted from the internal memory. As shown in the figures below, any application must be stopped and unloaded before File Manager can be accessed.

### 4.7.1 Stopping the application

Figure 4.7.1 shows the keystrokes necessary to stop the application.

### 4.7.2 Calling the file manager

Once the application has been stopped, it can be unloaded and the File Manager called from the 'Maintenance' pop-up as shown in figure 4.7.2.

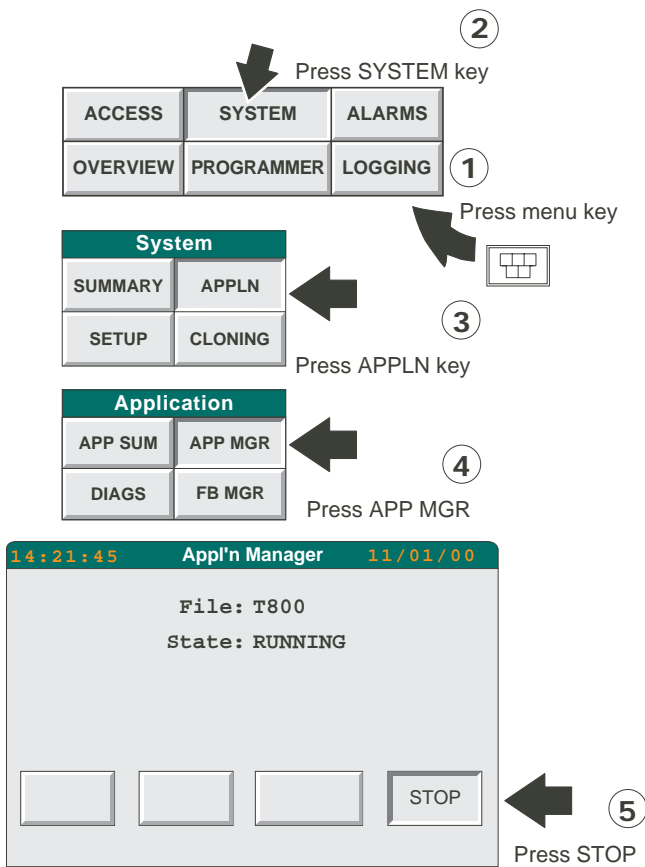

Figure 4.7.1 Application stop

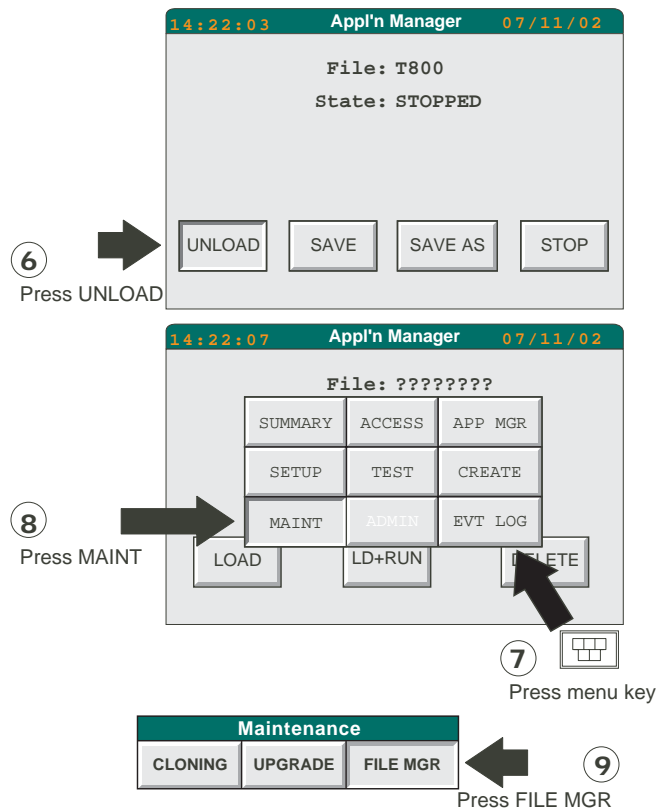

Figure 4.7.2 Calling the file manager

### 4.7.3 File Copy and Delete

Operation of the 'FILE MGR' button in the 'Maintenance' pop-up calls the File Manager page. Once this page is on display, either an individual file name can be selected from the relevant drive and the copy or delete key operated, or the COPY ALL/DEL ALL keys can be used to copy or delete all the files, within the selected filter, on that drive.

#### CAUTION

- Files of the form `_SYSTEM.XYZ*` must not be deleted or the instrument will not operate correctly and revert to a factory configuration
- Files `T800.GSD` and `2500.GSD` must not be deleted or Profibus will not operate correctly.
- The file `_DEFAULT.OFL` must not be deleted or the faceplates in the overview page will fail to operate correctly,

\*XYZ is any three character extension..

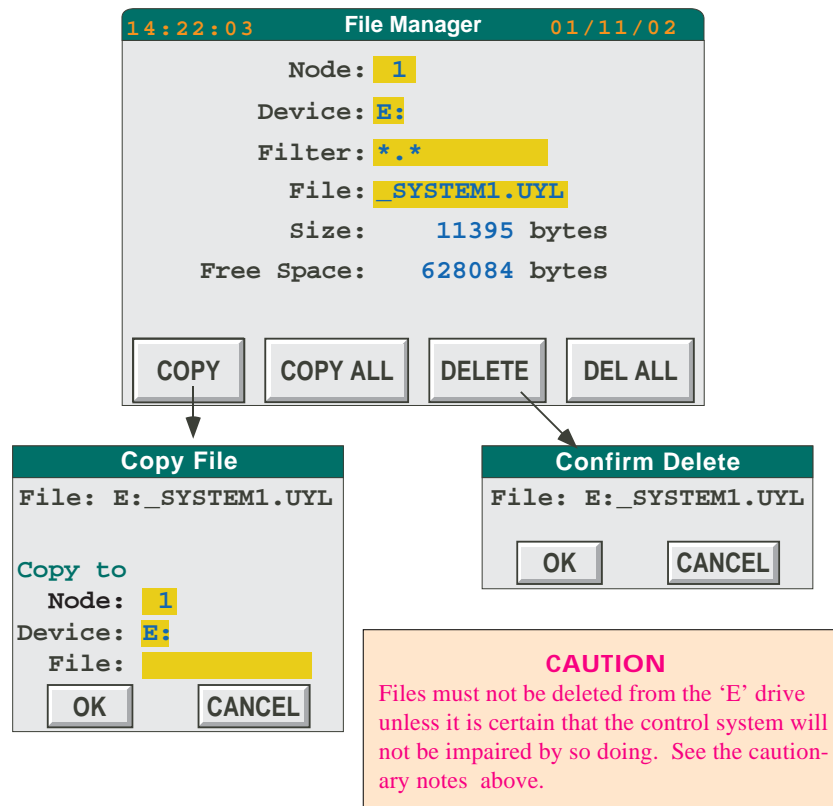

Figure 4.7.3 Copy and delete

Node	For SLIN/ALIN/ELIN systems only, the (decimal) number of the LIN node to be accessed
Device	Selectable as E (internal flash memory) or if any of the following are fitted: A (floppy disk), B (USB Bulk storage device) or H (internal archive).
Filter	Allows file display to be limited to certain types of files. For example, *.* shows all files, whereas, an entry of *.DBF allows only files with .DBF suffix to appear. See 'File' immediately below.
File	Touching this area causes a scroll list of files to be displayed and to be selected (one at a time) for copying or deleting. The range of files displayed can be limited by entering a display 'filter' to limit the scroll list to certain file names or file types.
Size	Shows the size of the selected file.
Free space	Shows the remaining capacity of the drive selected.

## 4.7.4 Reloading the application

Operation of the menu key, followed by the APP MGR button in the pop-up menu, returns to the Application Manager page, which allows a file to be selected to be the application. Once a file name has been selected, operation of the LOAD key and then the START key or the LD+RUN key, returns the unit to normal operation.

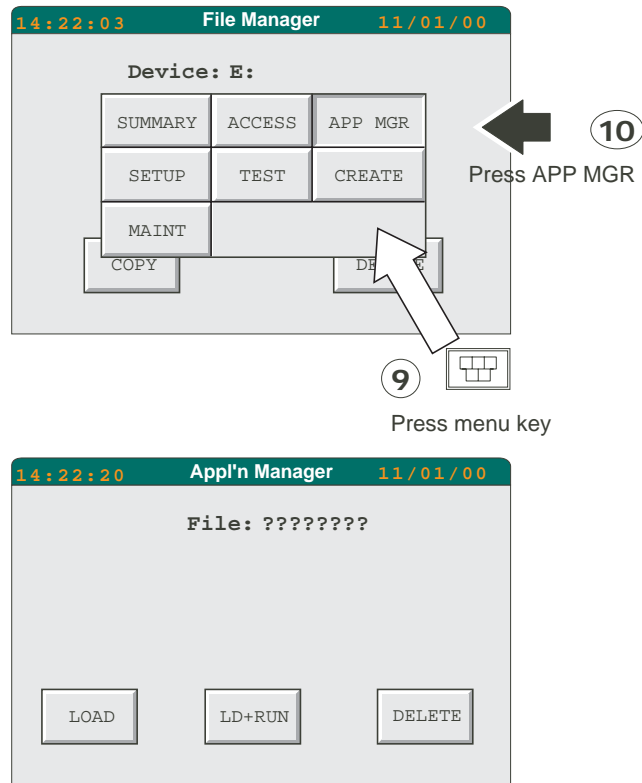

Figure 4.7.4 Regaining the Application Manager Page

## 4.8 RECIPE MANAGEMENT

### 4.8.1 Creating recipe files

A 'blank' recipe file (i.e. a recipe file with no values) can be created from the recipe file page. The recipe editor can then be used to add values.

### 4.8.2 Recipe editing

The recipe editor is called by pressing 'EDIT' from the recipe menu.

---

**Note:** For units fitted with the Auditor Option, an edited recipe must be Saved before it can be downloaded.

---

#### 4.8.2.1 ADD RECIPE LINE

If a spare line is available, a new line can be added by pressing the 'ADD LINE' button. (The Option key may need pressing one or more times in order to display this key.) Once added, the RCP (Recipe) cell at the top left of the display can be pressed to change the name of the selected line.



#### 4.8.2.2 ADD A VARIABLE

A new variable can be added by touching that cell in the left-most (RCP) column, which is immediately above the cell where the new variable is to appear. A Properties Menu appears, which allows the variable name and tag references to be entered.

*Note: variables are executed in 'top-down' order, so the order in which variables appear can be important.*

To add the first variable, press the RCP cell, then the INSERT key on the pop-up menu. The name and tag references of the variable can now be entered. If applicable, Capture and Monitor values can also be edited.

The verify field allows the user to define 'Verify' as 'Yes' or 'No'. If set to No, the variable is not checked, during download, to ensure that the value is correctly written. 'No' is used, for example, where a variable may reset itself or change.

Figure 4.8.2.2 shows a typical properties dialogue box.

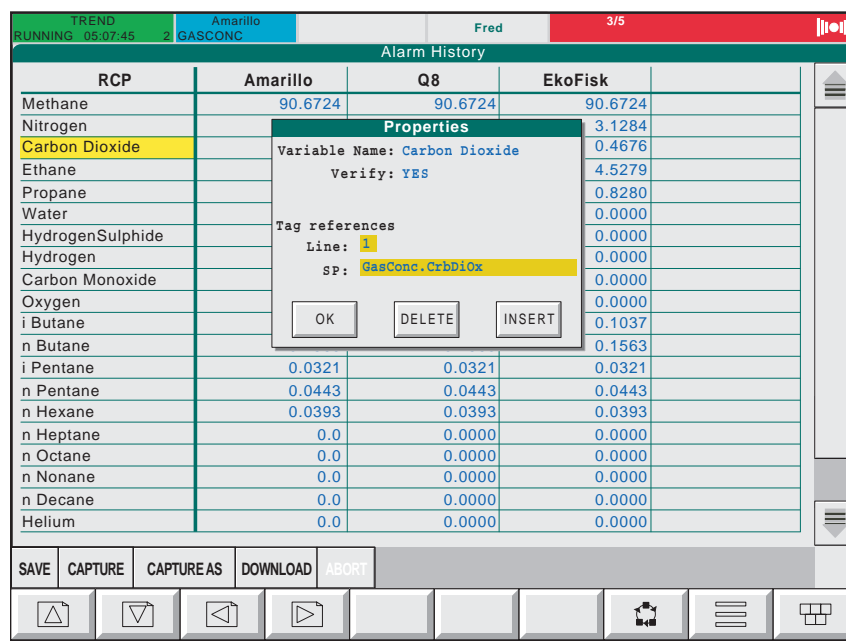

Figure 4.8.2.2 Properties dialogue box

#### 4.8.2.3 TAG REFERENCES

Touching a variable in the RCP column, calls the Properties menu. This menu allows the variable name, tag references and verification setting to be edited.

#### 4.8.2.4 RECIPE VALUE

Touching a value in a recipe column, allows a new value to be entered.

#### 4.8.2.5 ADDING A RECIPE

To add a new recipe, select an existing recipe to act as a model, and touch that recipe's name. Select NEW from the dialogue box which appears. The new recipe takes the values of the model, and can be edited as required.

#### 4.8.2.6 DELETING RECIPES

Touch the recipe name (at the top of the column), then select DELETE from the pop-up dialogue box.

#### 4.8.2.7 SAVING RECIPES

To save changes to the current file name, operate the SAVE button. To make a copy of the file, press SAVE AS.

#### 4.8.2.8 RECIPE FILE PROPERTIES

Touching the RCP cell calls the Recipe File properties dialogue box to the display. This gives the name of the recipe file and the line currently selected, as well as details of the previous file edit. The version field is incremented each time the file is saved.

Further to this there is an editable timeout field allowing a value to be entered to timeout a successful download of a recipe.

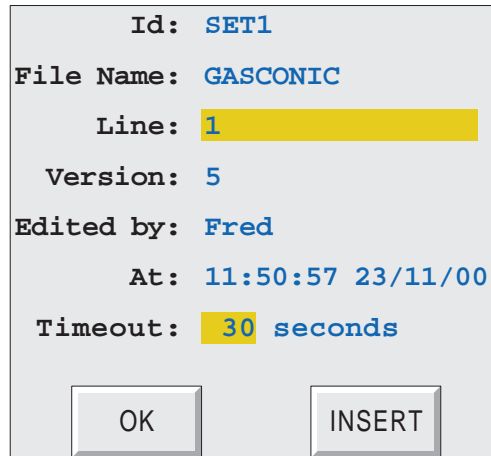

Id: SET1  
File Name: GASCONIC  
Line: 1  
Version: 5  
Edited by: Fred  
At: 11:50:57 23/11/00  
Timeout: 30 seconds

OK INSERT

Figure 4.8.2.8 Recipe File properties box

#### 4.8.3 Capturing a Recipe

With a recipe file loaded and a recipe selected it is possible to 'capture' live values from the running application, for display in the Recipe Monitor page (either in the 'Capture' column if available, or in the SP (Live) column if not). Operation of the CAPTURE button in the monitor page overwrites the existing values in the selected recipe. CAPTURE AS, creates a new recipe with the captured values.

Once values have been captured, they can be modified as required in the Recipe edit page.

## 4.9 OEM FEATURES

### 4.9.1 Intellectual Property Right Protection (IPRP)

The IPRP feature is provided to allow OEMs, for example, to prevent unauthorized copying of application files. The feature is available only on enhanced instruments. To determine if a feature is enabled, view the software options page (section 2.1.4).

If IPRP is enabled:

1. Files on the E: drive may not be copied from the instrument either to floppy disk/USB ‘memory stick’ or via network (ELIN, ALIN, SLIN, FTP) operations.
2. All files on the E: drive may be modified using normal user interface operations.
3. New files may be added to the E: drive, but they may not be copied from the instrument.
4. Existing files may be overwritten by new files, with the same name, across a network.
5. Files are ‘scrambled’ when cloned out of the instrument, so clone files can be used only in the source instrument or in another instrument with the same IPRP password (see below).

#### 4.9.9.1 MODIFYING IPRP SETTINGS

The procedure for modifying the IPRP settings is to create a text file, to copy it to the E: drive, and then to power cycle the instrument.

The text file must be called `_OEM.TXT` and consists of a single line containing comma-separated items as follows:

```
OEM,1,current password,new password,enable/disable
```

Where the items have the following definitions:

OEM	Non variable text string.
1	Non variable value.
Current password	The current password. As despatched from the factory, this is: <code>_OEM_OEM</code> If the current password is entered incorrectly, the file is ignored.
New password	The required new password of up to eight characters. If left blank, the password remains unchanged.
Enable/disable	0 = IPRP disabled (off); 1 = IPRP enabled (on). If left blank, the setting remains unchanged.

For example, to change the default password to ‘Richard1’ and enable IPRP, the file content should be as follows:

```
OEM,1,_OEM_OEM,Richard1,1
```

---

**Note:** Space characters are included in the password. Commas are not allowable as password characters.

---

This page is deliberately left blank

## CHAPTER 5: CUSTOMISING

This chapter describes how to customise the Standard Interface; it consists of the following sections:

- |                                    |                               |
|------------------------------------|-------------------------------|
| 5.1 Introduction                   | 5.9 Form files                |
| 5.2 The System text dictionary     | 5.10 Recipe files             |
| 5.3 The Error text dictionary      | 5.11 The writeable dictionary |
| 5.4 The Event text dictionary      | 5.12 The recipe dictionary    |
| 5.5 The User text dictionary       | 5.13 The batch dictionary     |
| 5.6 The Programmer text dictionary | 5.14 Batch files              |
| 5.7 Panel navigation               | 5.15 Reader files             |
| 5.8 Database names                 |                               |

### 5.1 INTRODUCTION

5.1 to 5.8, show how to replace the supplied screen-displayed texts with ones more suited to a particular process, in a different language and so on.

Each of these can involve either:

1. replacing text items displayed by the instrument's Standard Interface; and/or
2. writing new text, either for any other national language versions of the Standard Interface that might be required, or for any so-called User-screens being developed.

5.9 describes how to format reports. 5.10 to 5.15 contain details of how to create or edit recipe, batch and card-reader files.

#### 5.1.1 The dictionaries

Displayed texts are held in files called dictionaries, covered in sections 5.2 to 5.6 and 5.11 to 5.13. There are specific customisable dictionary files for each of the following types of texts:

1. Standard Interface, excluding the Error and Event messages
2. Error messages
3. Event messages
4. The texts of any User pages (the 'User screens')
5. Programmer texts.
6. Writeable (modifiable) texts for use with the batch system and in reports.
7. Recipe texts
8. Batch texts

The texts of the Standard Interface are held in the System text dictionary, Error messages are held in the Error Text dictionary, and Event messages are held in the Event Text dictionary. These three dictionaries make up the *\_system.uyl* file.

User screen and Programmer text dictionaries are initially empty, for users to fill as required. These two dictionaries make up the *\_user.uyl* file.

### 5.1.1 THE DICTIONARIES (Cont.)

DICTIONARY NAME	FILE NAME	RECORD SYNTAX
System text	<i>_system.uyl</i>	S<N>,<text>
Error text	<i>_system.uyl</i>	E<N>,<text>
Event text	<i>_system.uyl</i>	V<N>,<text>
User text	<i>_user.uyl</i>	U<N>,<text>
Programmer text	<i>_user.uyl</i>	P<N>,<text>
Writable text	<i>_user.uyl</i>	W<N>,<initial text>
Recipe texts	Not applicable	Not applicable
Batch texts	Not applicable	Not applicable

where <N> is the index number of the record ([section 5.2.2. File structure](#)).

Customising an existing *.uyl* file or building a new one is done by editing the files on a PC using a standard text editor (for example, Windows Notepad) and then cloning them into the Visual Supervisor by floppy disk.

### 5.1.2 Panel navigation and database names

Panel navigation ([section 5.7](#)) describes how to change the layout (the architecture) of the Standard Interface. A completely new architecture can be created if required.

Database names ([section 5.8](#)) describes how to change the names of function blocks, alarms, and of items called enumerations which are usually two-state Boolean variables such as ON/OFF and TRUE/FALSE.

## 5.2 THE SYSTEM TEXT DICTIONARY

The System text dictionary holds all the text displayed by the instrument's Standard Interface, except for the following:

- 1 [Error messages](#)
- 2 [Event messages](#)
- 3 Segment type names, and text in menus and column headers.

Of these, Error messages and Event messages are held in their own dictionaries and can be customised through those. Commands, segment type names, and text in menus and column heads are held elsewhere and cannot be customised.

In customising the System dictionary, it is possible to:

- 1 replace any text item with text for a particular industry or application, and/or
- 2 the text can be internationalised by creating new dictionaries for each of up to ten languages

### 5.2.1 File structure

In the listing of the System text dictionary in [section 5.2.4](#), the column header running throughout is:

#### NO. CONTEXT CLASS MAX TEXT

No.	Stands for REFERENCE NUMBER
CONTEXT	Describes the application to which the text relates. For example, STARTUP, COMMS, or CLOCK.
CLASS	Describes the type of text. For example, title of a dialogue box, button text, or error message.
MAX	The maximum permissible length of the replacement text, in number of characters.
TEXT	The default text that the instrument is supplied with for this item.

## 5.2.2 Editing system text

The System text dictionary is held in the *\_system.uyl* file. In the print-out of this file in section 5.2.4:

1. Find the text to be replace (first find its Context, then its Class, then the Text itself)
2. Note its reference number
3. Key in the reference number, and then the new text, related by the following syntax: S<N>, <text>

where:

<N> is the reference number of the record you want to change

<text> is the replacement text.

For example, S12,Display error.

For any text item not replaced in the .uyl file, the version in the ROM file will be used.

## 5.2.3 New language versions

For each language a file called a *\_system<n>.uyl* file must be built, using the same syntax as above. The variable <n> in each file name specifies the particular national language by taking integer values from 0 up to a maximum of 9, one value for each language which is to be available. The correspondence (mapping) between language and integer is decided by the user.

For example, the file holding terms in English might be the file named *\_system0.uyl* with a typical record S2,FILE UPDATE.

## 5.2.4 The dictionary

On delivery of the Visual Supervisor, the contents of the System text dictionary (abridged) are as set out below.

---

Notes:

1. Items where ‘:’ is the final character always have a space after the ‘:’ for formatting purposes
  2. Leading space characters are significant
  3. Any printable character of the Unicode Latin-1 set may be used.
-

## 5.2.4 THE DICTIONARY (Cont.)

NO.	CONTEXT	CLASS	MAX	TEXT
1	GLOBAL	BUTTON_TEXT	12	OK
2	OIFL	DIALOG_TITLE	28	FILE UPDATE
3	OIFL	DIALOG_TEXT	80	The User Page file has changed. The panel system will now reload.
4	GLOBAL	HIDE_CHAR	1	
5	GLOBAL	UPDATE_ERROR	1	
6	GLOBAL	DISP_ERROR	1	
12	OIFL	OIFL_ERROR	20	OIFL ERROR
13	OIFL	OIFL_ERROR	20	BAD FILE
14	OIFL	OIFL_ERROR	20	BAD LINE
15	OIFL	OIFL_ERROR	20	BAD EOF
16	OIFL	OIFL_ERROR	20	MEMORY
17	OIFL	OIFL_ERROR	20	SYNTAX
18	OIFL	OIFL_ERROR	20	RANGE
19	OIFL	OIFL_ERROR	20	NAME
20	OIFL	OIFL_ERROR	20	DICTIONARY
21	OIFL	OIFL_ERROR	20	TYPE
22	OIFL	OIFL_ERROR	20	ACTION
31	ALMMENU	MENU_TITLE	16	Alarms
32	ALMMENU	LEGEND	11	ALARMS
33	ALMMENU	LEGEND	11	ACK
34	ALMMENU	LEGEND	11	ACK ALL
35	ALMMENU	LEGEND	11	HISTORY
36	ALMMENU	LEGEND	11	SUMMARY
37	ALMMENU	DIALOG_TEXT	80	This will acknowledge every alarm.
38	ALMMENU	BUTTON_TEXT	12	OK
39	ALMMENU	BUTTON_TEXT	12	CANCEL
40	ALMMENU	LEGEND	11	ABORT
41	ALH	PAGE_TITLE	20	Alarm History
42	ALH	LEGEND	11	ALM HIST
43	ALH	ALH_TITLE	8	TYPE
44	ALH	ALH_TITLE	8	ACTIVE
45	ALH	ALH_TITLE	8	CLEAR
46	ALH	LEGEND	11	FILTER
47	ALH	ALH_FILTER	8	= ALL
48	ALH	ALH_FILTER	8	= ALARMS
49	ALH	ALH_FILTER	8	= AREA
50	ALH	ALH_FILTER	8	= GROUP
51	ALH	ALH_FILTER	8	= BLOCK
52	ALH	ALH_FILTER	8	= EVENTS
53	ALH	ALH_FILTER	8	= SYSTEM
54	ALH	DIALOG_TEXT	80	This will acknowledge every alarm under the selected filter.
56	ALH	ALH_TITLE	8	ACK
57	ALH	PAGE_TITLE	20	Alarm summary
59	ALH	ALH_FILTER	8	=MSGs
61	ALMMENU	PAGE_TITLE	20	Add Note
62	ALMMENU	LEGEND	11	NOTE
63	ALMMENU	INTRO	64	Adds a Note to the Alarm History list.
64	ALMMENU	ITEM_TITLE	16	Your note:



## 5.2.4 THE DICTIONARY (Cont.)

No.	Context	Class	Max	Text
66	ALMMENU	LEGEND	11	LOG
67	ALH	PAGE_TITLE	20	Event Log
68	ALMMENU	LEGEND	11	EVT LOG
71	ALMMENU	PAGE_TITLE	20	Alarm Archive
72	ALMMENU	LEGEND	11	ARCHIVE
73	ALMMENU	INTRO	64	Archive to disk the alarm history
74	ALMMENU	DIALOGUE_TITLE	28	Acknowledging All Cached Block Alarms
75	ALMMENU	ITEM_TITLE	16	Remaining:
76	ALMMENU	ITEM_TITLE	16	Block:
77	PRINTER	ALM_TYPE	3	ACK
78	PRINTER	ALM_TYPE	3	ACT
79	PRINTER	ALM_TYPE	3	CLR
80	FP	PAGE_TITLE	20	T800 - Starting
81	FP	FP	32	Attempting Cold Start
82	FP	FP	32	Attempting Warm Start
83	FP	FP	32	Attempting Hot Start
84	FP	FP	32	Unpacking Database
85	FP	FP	32	Start Up Error
86	FP	FP	32	Initialising
87	FP	FP	32	Loading Application
88	FP	FP	32	Unloading Application
89	FP	FP	32	Please wait...
90	APPMGR	DIALOG_TITLE	28	Load Error
91	FATAL	FATAL_ERROR	20	No cold/hot start
92	FATAL	FATAL_ERROR	20	No hot start
93	FATAL	FATAL_ERROR	20	No cold start
101	MONTH	MONTH	3	Jan
102	MONTH	MONTH	3	Feb
103	MONTH	MONTH	3	Mar
104	MONTH	MONTH	3	Apr
105	MONTH	MONTH	3	May
106	MONTH	MONTH	3	Jun
107	MONTH	MONTH	3	Jul
108	MONTH	MONTH	3	Aug
109	MONTH	MONTH	3	Sep
110	MONTH	MONTH	3	Oct
111	MONTH	MONTH	3	Nov
112	MONTH	MONTH	3	Dec
113	ALH	DATE POOR CHAR	1	*
114	ALH	TIME POOR CHAR	1	*
120	GLOBAL	BUTTON_TEXT	12	OK
121	GLOBAL	BUTTON_TEXT	12	OK ALL
122	GLOBAL	BUTTON_TEXT	12	CANCEL
123	GLOBAL	BUTTON_TEXT	12	ABORT
124	GLOBAL	BUTTON_TEXT	12	SKIP
125	GLOBAL	BUTTON_TEXT	12	SAVE
126	GLOBAL	BUTTON_TEXT	12	ERROR
127	GLOBAL	SYSSUM_ITEM	8	<NONE>

## 5.2.4 THE DICTIONARY (Cont.)

No.	Context	Class	Max	Text
128	GLOBAL	BUTTON_TEXT	12	NO
129	GLOBAL	BUTTON_TEXT	12	YES
130	SYSMENU	MENU_TITLE	16	System
131	SYSMENU	LEGEND	11	SYSTEM
132	SYSSUM	PAGE_TITLE	20	System Summary
133	SYSSUM	LEGEND	11	SUMMARY
134	SYSSUM	ITEM_TITLE	18	Instrument type:
135	SYSSUM	ITEM_TITLE	18	Variant:
136	SYSSUM	ITEM_TITLE	18	Touch/keypad:
137	SYSSUM	ITEM_TITLE	18	Firmware:
138	SYSSUM	ITEM_TITLE	18	Media:
139	SYSSUM	ITEM_TITLE	18	Option cards:
140	SYSSUM	SYSSUM_ITEM	8	T800
141	SYSSUM	SYSSUM_ITEM	8	Standard
145	SYSSUM	SYSSUM_ITEM	8	kBytes
146	SYSSUM	ITEM_TITLE	18	DRAM:
147	SYSSUM	ITEM_TITLE	18	SRAM:
148	SYSSUM	ITEM_TITLE	18	FLASH:
149	SYSSUM	ITEM_TITLE	18	EEPROM:
150	SYSSUM	SYSSUM_ITEM	8	TOUCH
151	SYSSUM	SYSSUM_ITEM	8	KEYPAD
154	SYSSUM	SYSSUM_ITEM	8	MBytes
155	SYSSUM	SYSSUM_ITEM	8	FLOPPY
156	SYSSUM	SYSSUM_ITEM	8	PCMCIA
157*	SYSSUM	ITEM_TITLE	8	Internal Archive:
158	SYSSUM	SYSSUM_ITEM	8	IDE
159	SYSSUM	ITEM_TITLE	18	USB(Bulk)
160	SYSSUM	PARA	20	Software options
161	SYSSUM	SYSSUM_ITEM	8	ALIN
162	SYSSUM	SYSSUM_ITEM	8	PROFIBUS
163	SYSSUM	SYSSUM_ITEM	8	ETHERNET
164	SYSSUM	SYSSUM_ITEM	8	GPIB
165	SYSSUM	SYSSUM_ITEM	8	ASYNC
166	SYSSUM	SYSSUM_ITEM	8	Report
167	SYSSUM	SYSSUM_ITEM	8	Recipe
168	SYSSUM	ITEM_TITLE	18	Reader:
169	SYSSUM	ITEM_TITLE	18	Batch:
170	APPSUM	PAGE_TITLE	20	Appl'n Summary
171	APPSUM	LEGEND	11	APP SUM
172	APPSUM	ITEM_TITLE	16	Application:
173	APPSUM	ITEM_TITLE	16	Machine State:
174	APPSUM	PARA	24	Memory Usage
180	APPSUM	APPSUM_STATE	10	OFF
181	APPSUM	APPSUM_STATE	10	RESET
182	APPSUM	APPSUM_STATE	10	IDLE
183	APPSUM	APPSUM_STATE	10	RUNNING
184	APPSUM	APPSUM_STATE	10	STOPPED
185	APPSUM	APPSUM_STATE	10	ERROR
190	APPSUM	ITEM_UNITS	9	kB
191	APPSUM	ITEM_TITLE	16	Control DB:
192	APPSUM	ITEM_TITLE	16	Programmer:
193	APPSUM	ITEM_TITLE	16	SFC DB:

\* Note: For software versions prior to 3.0, the text for item 157 was 'LS120'

## 5.2.4 THE DICTIONARY (Cont.)

No.	Context	Class	Max	Text
194	APPSUM	ITEM_TITLE	16	SFC ST:
195	APPSUM	ITEM_TITLE	16	Modbus slave:
196	APPSUM	ITEM_TITLE	16	Modbus master:
197	APPSUM	ITEM_TITLE	16	transient:
200	STARTUP	PAGE_TITLE	20	Startup Strategy
201	STARTUP	LEGEND	11	STARTUP
202	STARTUP	ITEM_TITLE	18	Hot Start:
203	STARTUP	ITEM_TITLE	18	Warm Start:
204	STARTUP	ITEM_TITLE	18	Cold Start:
205	STARTUP	ITEM_TITLE	18	Startup State:
206	STARTUP	ITEM_TITLE	18	Hot-start time:
207	STARTUP	ITEM_TITLE	18	Brown-out time:
220	COMMS	PAGE_TITLE	20	Comms Setup
221	COMMS	LEGEND	18	COMMS
222	COMMS	DIALOG_TEXT	80	The settings specified are invalid.
223	COMMS	DIALOG_TITLE	28	Hardware check
224	COMMS	DIALOG_TEXT	80	IMPORTANT: Ensure comms cables are unplugged before pressing 'OK' to continue.
228	COMMS	COMMS_ITEM	8	Ethernet
229	COMMS	COMMS_ITEM	8	AT102
224	COMMS	OPTION_BUTTON	8	HARDWARE
230	COMMS	COMMS_ITEM	8	IEEE1284
231	COMMS	COMMS_PORT	5	CFG
233	COMMS	COMMS_PORT	5	SLV
234	COMMS	COMMS_PORT	5	MST
235	COMMS	COMMS_PORT	5	PBUS1
236	COMMS	COMMS_PORT	5	PBUS2
237	COMMS	COMMS_PORT	5	ALIN
238	COMMS	COMMS_PORT	4	LPT
239	COMMS	COMMS_PORT	5	KBD
240	COMMS	COMMS_ATTR	9	PORT
241	COMMS	COMMS_ATTR	9	Hardware
242	COMMS	COMMS_ATTR	9	Protocol
243	COMMS	COMMS_ATTR	9	Node No.
244	COMMS	COMMS_ATTR	9	Baud
245	COMMS	COMMS_ATTR	9	Parity
246	COMMS	COMMS_ATTR	9	Data Bits
247	COMMS	COMMS_ATTR	9	Stop Bits
248	COMMS	COMMS_ATTR	9	Timeout
249	COMMS	COMMS_ATTR	9	Talk Thru
250	COMMS	COMMS_ATTR	9	Ind Table
251	COMMS	COMMS_ITEM	8	None
252	COMMS	COMMS_ITEM	8	SLIN
253	COMMS	COMMS_ITEM	8	TermCfg
254	COMMS	COMMS_ITEM	8	Modbus/S
255	COMMS	COMMS_ITEM	8	Modbus/M
256	COMMS	COMMS_ITEM	8	WDB
259	COMMS	COMMS_ITEM	8	Reader
260	COMMS	COMMS_ITEM	8	Keypad
261	COMMS	COMMS_ITEM	8	NONE
262	COMMS	COMMS_ITEM	8	EVEN
263	COMMS	COMMS_ITEM	8	ODD

## 5.2.4 THE DICTIONARY (Cont.)

No.	Context	Class	Max	Text
265	COMMS	COMMS_ITEM	8	RS232
266	COMMS	COMMS_ITEM	8	RS422
267	COMMS	COMMS_ITEM	8	RS485
268	COMMS	COMMS_ITEM	8	ARCNET
270	CLOCK	PAGE_TITLE	20	Clock Setup
271	CLOCK	LEGEND	11	CLOCK
272	CLOCK	ITEM_TITLE	16	Date:
273	CLOCK	ITEM_TITLE	16	Time:
274	CLOCK	BUTTON_TEXT	12	SET
275	CLOCK	BUTTON_TEXT	12	Hr +1
276	CLOCK	BUTTON_TEXT	12	Hr -1
277	CLOCK	INTRO	64	Clock configured as master
278	CLOCK	INTRO	64	Clock configured as slave
280	SYSSUM	ITEM_TITLE	18	SPP/SFC
281	SYSSUM	ITEM	8	SPP
282	SYSSUM	ITEM	8	SFC
283	SYSSUM	ITEM	8	DB
288	SYSSUM	ITEM_TITLE	21	IPR Protection:
289	SYSSUM	SYSSUM_ITEM	8	Auditor:
290	INTERNAT	PAGE_TITLE	20	Internationalise
291	INTERNAT	LEGEND	11	INTERNAT
292	INTERNAT	ITEM_TITLE	14	Language:
293	INTERNAT	ITEM_TITLE	14	Date Format:
294	INTERNAT	ITEM_TITLE	14	Time Format:
295	INTERNAT	ITEM_TITLE	14	Duration Fmt:
296	INTERNAT	BUTTON_TEXT	12	CHANGE
300	INTERNAT	LANGUAGE	12	English
301	INTERNAT	LANGUAGE	12	French
302	INTERNAT	LANGUAGE	12	German
303	INTERNAT	LANGUAGE	12	Italian
304	INTERNAT	LANGUAGE	12	Spanish
305	INTERNAT	LANGUAGE	12	Lang_5
306	INTERNAT	LANGUAGE	12	Lang_6
307	INTERNAT	LANGUAGE	12	Lang_7
308	INTERNAT	LANGUAGE	12	Lang_8
309	INTERNAT	LANGUAGE	12	Lang_9
310	PANEL	PAGE_TITLE	20	Panel Setup
311	PANEL	LEGEND	11	PANEL
312	PANEL	PARA	24	BACK-LIGHT
313	PANEL	ITEM_TITLE	32	Brightness:
314	PANEL	ITEM_TITLE	32	Saver brightness:
315	PANEL	ITEM_TITLE	32	Timeout:
316	PANEL	PARA	24	PAGE TIMEOUTS
317	PANEL	ITEM_TITLE	32	Home:
318	PANEL	ITEM_TITLE	32	Pop-up:
319	PANEL	ITEM_TITLE	32	Data Entry:
320	PANEL	ITEM_UNITS	9	minutes
321	PANEL	ITEM_UNITS	9	seconds
322	PANEL	ITEM	16	100%
323	PANEL	ITEM	16	90%

## 5.2.4 THE DICTIONARY (Cont.)

No.	Context	Class	Max	Text
324	PANEL	ITEM	16	80%
325	PANEL	ITEM	16	70%
326	PANEL	ITEM	16	60%
327	PANEL	ITEM	16	50%
328	PANEL	ITEM	16	40%
329	PANEL	ITEM	16	30%
330	PANEL	ITEM	16	20%
331	PANEL	ITEM_TITLE	20	This item allows an access level timeout to be entered (Section 4.5.5.3). If a non-zero value is entered, then the Access level will return to 'Locked' whenever the time between screen presses is greater than the timeout period.
339	PANEL	ITEM_UNITS	9	days
340	FILEMGR	BUTTON_TEXT	12	COPY ALL
341	FILEMGR	PAGE_TITLE	20	Copy Files
342	FILEMGR	BUTTON_TEXT	16	DEL ALL
343	FILEMGR	PAGE_TITLE	20	Confirm Delete All
344	FILEMGR	ITEM_FILE	16	Files:
360	ACCESS	PAGE_TITLE	20	Security Access
361	ACCESS	LEGEND	11	ACCESS
362	ACCESS	INTRO	64	Enter required level and password, then CHANGE
363	ACCESS	ITEM_TITLE	18	Current Level:
364	ACCESS	ITEM_TITLE	18	New Level:
365	ACCESS	ITEM_TITLE	18	Password:
366	ACCESS	BUTTON_TEXT	12	CHANGE
367	ACCESS	BUTTON_TEXT	12	PASSWDS
368	ACCESS	PAGE_TITLE	20	Passwords
369	ACCESS	PAGE_TITLE	28	Confirm Password
370	ACCESS	INTRO	64	Please re-enter top-level password:
371	ACCESS	ACCESS_LEVEL	10	LOCKED
372	ACCESS	ACCESS_LEVEL	10	OPERATOR
373	ACCESS	ACCESS_LEVEL	10	COMMISSION
374	ACCESS	ACCESS_LEVEL	10	ENGINEER
375	ACCESS	ACCESS_LEVEL	10	ADMIN
380	APPMGR	PAGE_TITLE	20	Appl'n Manager
381	APPMGR	LEGEND	11	APP MGR
382	APPMGR	ITEM_TITLE	16	File:
383	APPMGR	ITEM_TITLE	16	State:
384	APPMGR	BUTTON_TEXT	12	LOAD
385	APPMGR	BUTTON_TEXT	12	LD+RUN
386	APPMGR	BUTTON_TEXT	12	UNLOAD
387	APPMGR	BUTTON_TEXT	12	SAVE
388	APPMGR	BUTTON_TEXT	12	SAVE AS
389	APPMGR	BUTTON_TEXT	12	DELETE
390	APPMGR	BUTTON_TEXT	12	STOP
391	APPMGR	BUTTON_TEXT	12	START
392	APPMGR	DIALOG_TITLE	28	Confirm Delete
393	APPMGR	MESSAGE	128	Application management is already in progress elsewhere
394	APPMGR	DIALOG_TITLE	28	Saving

## 5.2.4 THE DICTIONARY (Cont.)

No.	Context	Class	Max	Text
396	APPMENU	MENU_TITLE	16	Application
397	APPMENU	LEGEND	11	APPLN
398	SETMENU	MENU_TITLE	16	Setup
399	SETMENU	LEGEND	11	SETUP
400	SPP	SPP_STATUS	8	RESET
401	SPP	SPP_STATUS	8	LOADING
402	SPP	SPP_STATUS	8	PRE_RUN
403	SPP	SPP_STATUS	8	RUNNING
404	SPP	SPP_STATUS	8	HELD
405	SPP	SPP_STATUS	8	HELDBACK
406	SPP	SPP_STATUS	8	COMPLETE
407	SPP	SPP_STATUS	8	IDLE
408	SPP	SPP_STATUS	8	POST_RUN
409	SPP	SPP_STATUS	8	ERROR
410	SPP	SPP_FP_VALUE	8	CLOSED
411	SPP	SPP_FP_VALUE	8	OPEN
412	SPP	ITEM_TITLE	16	Segment:
413	SPP	ITEM_TITLE	16	Setpoint:
414	SPP	ITEM_TITLE	16	Ramp at:
415	SPP	ITEM_TITLE	16	to:
416	SPP	BUTTON_TEXT	12	DONE
417	SPP	PAGE_TITLE	18	Current Program
418	SPP	PARA	20	Program
419	SPP	ITEM_TITLE	16	Name:
420	SPP	ITEM_TITLE	16	Status:
421	SPP	ITEM_TITLE	16	Duration:
422	SPP	ITEM_TITLE	16	Completion:
423	SPP	ITEM_TITLE	16	Iteration:
424	SPP	Special	1	/
425	SPP	PARA	24	Segment
426	SPP	ITEM_TITLE	16	Name:
427	SPP	ITEM_TITLE	16	Time Remaining:
428	SPP	BUTTON_TEXT	12	RUN
429	SPP	BUTTON_TEXT	12	HOLD
430	SPP	BUTTON_TEXT	12	ABORT
431	SPP	PAGE_TITLE	20	Load/Save Program
432	SPP	ITEM_TITLE	16	File Name:
433	SPP	BUTTON_TEXT	12	LOAD
434	SPP	BUTTON_TEXT	12	SAVE
435	SPP	BUTTON_TEXT	12	SAVE AS
436	SPP	BUTTON_TEXT	12	DELETE
437	SPP	PAGE_TITLE	20	Schedule Program
438	SPP	ITEM_TITLE	17	File Name:
439	SPP	ITEM_TITLE	17	Start Date:
440	SPP	ITEM_TITLE	17	Start Time:
441	SPP	ITEM_TITLE	16	Iterations:
442	SPP	BUTTON_TEXT	12	CLEAR
443	SPP	BUTTON_TEXT	12	ACCEPT
444	SPP	SPP_CELL	18	SP
445	SPP	SPP_CELL_ABBR	8	D

## 5.2.4 THE DICTIONARY (Cont.)

No.	Context	Class	Max	Text
446	SPP	SPP_CELL_ABBR	8	S
447	SPP	Special	2	to
448	SPP	SPP_CELL_ABBR	8	R
449	SPP	Special	2	R@
450	SPP	SPP_CELL_ABBR	8	Servo SP
451	SPP	SPP_CELL_ABBR	8	Servo PV
452	SPP	PAGE_TITLE	20	Save As...
453	SPP	ITEM_TITLE	16	File Name:
455	SPP	DIALOG_TEXT	80	Overwriting
456	SPP	DIALOG_TITLE	28	PROGRAM SAVE
457	SPP	BUTTON_TEXT	12	OK
458	SPP	BUTTON_TEXT	12	CANCEL
459	SPP	DIALOG_TEXT	80	Deleting
460	SPP	DIALOG_TITLE	28	PROGRAM DELETE
461	SPP	BUTTON_TEXT	12	OK
462	SPP	BUTTON_TEXT	12	CANCEL
463	SPP	DIALOG_TEXT	80	File Saved
464	SPP	DIALOG_TITLE	28	PROGRAM SAVE
465	SPP	BUTTON_TEXT	12	OK
466	SPP	DIALOG_TEXT	80	Program File not found
467	SPP	DIALOG_TEXT	80	Program File too large
468	SPP	DIALOG_TEXT	80	File read error
469	SPP	DIALOG_TEXT	80	File write error
470	SPP	DIALOG_TEXT	80	Unresolved block references
471	SPP	DIALOG_TEXT	80	Program Already Running
472	SPP	DIALOG_TEXT	80	Insufficient file space
473	SPP	DIALOG_TEXT	80	Unrecognised file format
474	SPP	DIALOG_TEXT	80	Schedule already loaded
475	SPP	DIALOG_TEXT	80	Max nested subprograms limit exceeded
476	SPP	DIALOG_TITLE	28	PROGRAM LOAD/SAVE ERROR
477	SPP	BUTTON_TEXT	12	OK
478	SPP	MENU_TITLE	11	Programmer
479	SPP	LEGEND	11	MONITOR
480	SPP	LEGEND	11	PROGRAMS
481	SPP	LEGEND	11	SCHEDULE
482	SPP	LEGEND	11	PREVIEW
483	SPP	LEGEND	11	PRE-PLOT
484	SPP	LEGEND	11	EDIT
485	SPP	LEGEND	11	PROGRAMMER
486	SPP	SPP_FP_VALUE	8	NODATA
487	SPP	ITEM_TITLE	16	Run From:
488	SPP	ITEM_TITLE	16	Name:
489	SPP	BUTTON_TEXT	12	CANCEL
490	SPP	LEGEND	11	RUN FROM
491	SPP	BUTTON_TEXT	12	RUN
492	SPP	ITEM_TITLE	16	Duration:
493	SPP	ITEM_TITLE	16	Time Through:
494	SPP	DIALOG_TEXT	80	A program is scheduled. Continue with LOAD?
495	SPP	DIALOG_TITLE	28	LOAD PROGRAM
496	SPP	PARA	24	Current Schedule:
497	SPP	DIALOG_TITLE	28	UNSAVED EDITS
498	SPP	DIALOG_TEXT	80	This operation will result in the loss of edits which have not yet been saved.

## 5.2.4 THE DICTIONARY (Cont.)

No.	Context	Class	Max	Text
499	SPP	DIALOG_TITLE	28	RAMP TYPE CHANGE
500	SPP	DIALOG_TEXT	80	This will require other ramp types in this segment to be changed.
501	SPP	BUTTON_TEXT	12	NEW
502	SPP	PAGE_TITLE	20	New Program
503	SPP	PAGE_TITLE	20	Load Program
504	SPP	PAGE_TITLE	20	Properties
505	SPP	SPP_HOLDBACK	8	Holdback
506	SPP	ITEM_TITLE	16	Mode:
507	SPP	ITEM_TITLE	16	Value:
508	SPP	SPP_HOLDBACK	8	NONE
509	SPP	SPP_HOLDBACK	8	LOW
510	SPP	SPP_HOLDBACK	8	HIGH
511	SPP	SPP_HOLDBACK	8	HIGH&LOW
512	SPP	ITEM_TITLE	16	Duration:
513	SPP	BUTTON_TEXT	12	INS SEG
514	SPP	BUTTON_TEXT	12	DEL SEG
515	SPP	PAGE_TITLE	20	New Segment
516	SPP	PAGE_TITLE	20	Confirm Delete
517	SPP	ITEM	16	(Continuous)
518	SPP	MESSAGE	128	Building Display, please wait
519	SPP	ITEM_TITLE	16	Type:
520	SPP	SPP_CELL	8	Dwell
521	SPP	SPP_CELL	18	Step
522	SPP	SPP_CELL	18	Ramp
523	SPP	SPP_CELL	18	Ramp@
524	SPP	SPP_CELL	18	Expressn
525	SPP	SPP_CELL	18	Servo SP
526	SPP	SPP_CELL	18	Servo PV
528	SPP	SPP_CELL	18	Dwell
529	SPP	SPP_CELL	18	Step
532	SPP	SPP_CELL	18	Expressn
536	SPP	ITEM_TITLE	20	At End:
537	SPP	SPP_AT_END	24	Indefinite Dwell
538	SPP	SPP_AT_END	24	Starting Values
539	SPP	ITEM_TITLE	16	Ref:
540	SPP	DIALOG_TEXT	80	Program Limits Exceeded
550	SPP	ITEM_TITLE	20	Rate Units:
551	SPP	SPP_RATE_UNITS	16	Seconds
552	SPP	SPP_RATE_UNITS	16	Minutes
553	SPP	SPP_RATE_UNITS	16	Hours
554	SPP	SPP_RATE_UNITS	16	days
555	SPP	DIALOG_TEXT	80	No program loaded
561	SPP	ITEM_TITLE	16	Id:
562	SPP	DIALOG_TEXT	80	Common Block Refs
563	SPP	ITEM_TITLE	16	Iterations:
570	SPP	BUTTON_TEXT	12	SKIP
571	SPP	BUTTON_TEXT	12	LAYOUT
572	SPP	PAGE_TITLE	20	Editor layout
573	SPP	ITEM_TITLE	16	Long SP names:
574	SPP	ITEM_TITLE	16	Segment start:
575	SPP	ITEM_TITLE	16	Segment duration:
576	SPP	ITEM_TITLE	16	Segment finish:



## 5.2.4 THE DICTIONARY (Cont.)

No.	Context	Class	Max	Text
577	SPP	ITEM_TITLE	16	Start Time:
578	SPP	ITEM_TITLE	16	Finish Time:
598	SIGN	BUTTON_TEXT	12	OK
599	SIGN	BUTTON_TEXT	12	CANCEL
600	SIGN	PAGE_TITLE	20	Signature
601	SIGN	PAGE_TITLE	20	Confirmation
602	SIGN	PARA	24	Authorised by
603	SIGN	ITEM_TITLE	16	Reason:
604	SIGN	PARA	24	Signed by
605	SIGN	ITEM_TITLE	16	Old Value:
606	SIGN	ITEM_TITLE	16	New Value:
607	SIGN	ITEM_TITLE	16	Confirm Action:
608	SIGN	PAGE_TITLE	20	Signature Rejected
609	SIGN	ITEM_TITLE	16	Action Result:
610	TEST	PAGE_TITLE	20	Self Tests
611	TEST	LEGEND	11	TEST
612	TEST	LEGEND	11	BATTERY
613	TEST	LEGEND	11	RELAYS
614	TEST	LEGEND	11	RESET
620	TEST	PAGE_TITLE	20	Battery Test
621	TEST	ITEM_TITLE	2	Battery Condition:
622	TEST	ITEM	16	BAD
623	TEST	ITEM	16	GOOD
624	TEST	ITEM	16	????
625	TEST	BUTTON_TEXT	12	FORCE
630	TEST	PAGE_TITLE	20	Relay Test
631	TEST	ITEM_TITLE	22	Health Relay:
632	TEST	ITEM_TITLE	22	Run Relay:
633	TEST	ITEM_TITLE	22	Comms LED:
634	TEST	ITEM	16	OPEN
635	TEST	ITEM	16	CLOSED
640	TEST	PAGE_TITLE	20	Reset Instrument
641	TEST	MESSAGE	128	Confirming OK will reset the instrument. If you do not wish to, then exit from this page
642	TEST	MESSAGE	128	Instrument resetting, please wait.
700	LOGGING	MENU_TITLE	16	Logging
701	LOGGING	LEGEND	11	LOGGING
702	LOGGING	LEGEND	11	MONITOR
703	LOGGING	LEGEND	11	OFF-LINE
704	LOGGING	LEGEND	11	MANAGE
705	LOGGING	LEGEND	11	GROUPS
706	LOGGING	PAGE_TITLE	20	Logging Monitor
707	LOGGING	PAGE_TITLE	20	Logging Groups
708	LOGGING	PAGE_TITLE	20	Logging Off-line
709	LOGGING	PAGE_TITLE	20	Archive Manage
711	LOGGING	ITEM_TITLE	17	File Name:
712	LOGGING	ITEM_TITLE	17	File Type:
715	LOGGING	BUTTON_TEXT	12	MONITOR
716	LOGGING	BUTTON_TEXT	12	OFFLINE
717	LOGGING	BUTTON_TEXT	12	MANAGE
718	LOGGING	BUTTON_TEXT	12	GROUPS

## 5.2.4 THE DICTIONARY (Cont.)

No.	Context	Class	Max	Text
720	LOGGRP	MESSAGE	128	No logging groups configured
721	LOGGRP	ITEM_TITLE	17	Group Name:
722	LOGGRP	ITEM_TITLE	17	Logging:
723	LOGGRP	ITEM_TITLE	17	Archive Int:
725	LOGGRP	ITEM_TITLE	17	Name Type:
726	LOGGRP	PARA	24	Configuration
727	LOGGRP	ITEM_TITLE	17	Column Titles:
728	LOGGRP	ITEM_TITLE	17	Date Format:
729	LOGGRP	ITEM_TITLE	17	Compr Ratio:
731	LOGGRP	BUTTON_TEXT	12	SAVE
732	LOGGRP	BUTTON_TEXT	12	LOG NOW
741	LOGGING	ITEM	13	ASCII
742	LOGGING	ITEM	13	Binary
743	LOGGING	ITEM	13	UHH
745	LOGGRP	ITEM	13	Normal
746	LOGGRP	ITEM	13	High
751	LOGGRP	ITEM	13	ON
752	LOGGRP	ITEM	13	OFF
753	LOGGRP	ITEM	13	On Event
755	LOGGRP	ITEM	13	Text
758	LOGGRP	ITEM	13	Sequence
756	LOGGRP	ITEM	13	Hourly
757	LOGGRP	ITEM	13	Daily
761	LOGGRP	ITEM	13	Date Time
762	LOGGRP	ITEM	13	Spreadsheet
763	LOGGRP	ITEM	13	Integer
764	LOGGRP	ITEM	13	Duration
765	LOGGRP	ITEM	13	Days
766	LOGGRP	ITEM	13	DHMS
767	LOGGRP	ITEM	13	Present
768	LOGGRP	ITEM	13	Absent
770	LOGAMAN	ITEM	16	Files Exported:
771	LOGAMAN	ITEM	16	Files Skipped:
772	LOGAMAN	ITEM	16	Page Locked:
773	LOGAMAN	DIALOGUE_TITLE	28	Archive Manager Export
774	LOGAMAN	DIALOG_TEXT	80	Complete. Device may now be removed.
775	LOGAMAN	DIALOG_TEXT	90	Do you wish to skip ALL duplicate files, i.e. never overwrite files on the export device?
776	LOGAMAN	DIALOG_TEXT	80	Export device is full. Replace device and press OK to continue.
777	LOGAMAN	BUTTON_TEXT	12	EXPORT ALL
778	LOGAMAN	ITEM	16	Export device:
779	LOGGING	ITEM_UNITS	9	Bytes
780	LOGGING	ITEM_UNITS	9	KBytes
781	LOGMON	ITEM_TITLE	16	Media Size:
782	LOGMON	ITEM_TITLE	16	Free Space:

## 5.2.4 THE DICTIONARY (Cont.)

No.	Context	Class	Max	Text
783	LOGMON	ITEM_TITLE	16	Logging:
784	LOGMON	ITEM_TITLE	16	Free Time:
785	LOGMON	ITEM	8	ON
786	LOGMON	ITEM	8	OFF
787	LOGMON	ITEM	8	On Event
789	LOGAMAN	ITEM	16	Files
790	LOGOFFL	INTRO	64	This is a fixed disk. It has no OFFLINE mode.
791	LOGOFFL	ITEM_TITLE	16	Disk:
792	LOGOFFL	ITEM	12	Inactive
793	LOGOFFL	ITEM	12	Active
794	LOGOFFL	ITEM	12	Flushing
795	LOGOFFL	ITEM	12	Off-Line
796	LOGAMAN	BUTTON_TEXT	12	EXPORT
797	LOGAMAN	MESSAGE	128	Please wait...
798	LOGAMAN	ITEM_TITLE	16	File Size:
799	LOGAMAN	BUTTON_TEXT	12	DELETE
800	CLONE	PAGE_TITLE	20	Cloning
801	CLONE	LEGEND	11	CLONING
802	CLONE	ITEM	16	System
803	CLONE	ITEM	16	Application
804	CLONE	ITEM	16	ALL
805	CLONE	BUTTON_TEXT	12	EXPORT
806	CLONE	BUTTON_TEXT	12	IMPORT
807	CLONE	INTRO	64	System Data
808	CLONE	ITEM_TITLE	22	Config Options:
809	CLONE	ITEM_TITLE	22	Config Resources:
810	CLONE	ITEM_TITLE	22	Dictionaries:
811	CLONE	ITEM_TITLE	18	User Pages:
812	CLONE	INTRO	64	Application Data
813	CLONE	ITEM_TITLE	22	Control Database:
814	CLONE	ITEM_TITLE	22	SFCs:
815	CLONE	ITEM_TITLE	22	Programs/Recipes:
816	CLONE	ITEM_TITLE	22	User Pages:
817	CLONE	ITEM_TITLE	22	Comms Profiles:
818	CLONE	BUTTON_TEXT	12	CLEAR
819	CLONE	BUTTON_TEXT	12	DELETE
820	CLONE	ITEM_TITLE	22	Exporting:
821	CLONE	ITEM_TITLE	22	Importing:
822	CLONE	MESSAGE	128	Aborting...
823	CLONE	DIALOG_TEXT	80	Storage device not present. Insert, then select OK to continue.
824	CLONE	DIALOG_TEXT	80	This file already exists. Do you wish to overwrite it?
825	CLONE	DIALOG_TEXT	80	Destination device is full!
826	CLONE	DIALOG_TEXT	80	Error encountered when copying file
827	CLONE	DIALOG_TEXT	80	Destination file exists but source file does not. Remove it?
828	CLONE	DIALOG_TEXT	80	No .RUN file found
829	CLONE	DIALOG_TEXT	80	Multiple .RUN files found

## 5.2.4 THE DICTIONARY (Cont.)

No.	Context	Class	Max	Text
830	UPGRADE	PAGE_TITLE	20	Firmware Upgrade
831	UPGRADE	LEGEND	11	UPGRADE
832	UPGRADE	INTRO	64	Upgrade executable and/or copyright data.
833	UPGRADE	ITEM_TITLE	16	Copying:
834	UPGRADE	MESSAGE	128	WARNING: DO NOT POWER DOWN WHILE FILE COPY IS IN PROGRESS.
835	UPGRADE	MESSAGE	128	Now remove storage device, then power cycle to activate new firmware.
836	UPGRADE	DIALOG_ITEM_TITLE	24	Insufficient memory:
837	UPGRADE	DIALOG_ITEM_TITLE	24	bytes required
838	UPGRADE	DIALOG_ITEM_TITLE	24	bytes available
839	CLONE	DIALOG_TEXT	80	Storage device corrupted. Replace then select OK to continue.
840	AGP	PAGE_TITLE	20	Overview
841	AGP	LEGEND	11	OVERVIEW
842	AGP	BUTTON_TEXT	12	AUTO
843	AGP	BUTTON_TEXT	12	MANUAL
845	AGP	BUTTON_TEXT	8	VIEW
846	AGP	BUTTON_TEXT	8	LIVE
850	AUTODB	PAGE-TITLE	20	Auto Database Create
851	AUTODB	LEGEND	11	CREATE
852	AUTODB	ITEM_TITLE	16	Programmer:
853	AUTODB	ITEM_TITLE	16	Loops:
854	AUTODB	ITEM_TITLE	16	I/O Modules:
855	AUTODB	ITEM_TITLE	16	I/O Channels:
856	AUTODB	ITEM_TITLE	16	I/O Requested:
857	AUTODB	ITEM_TITLE	16	I/O Actual:
858	AUTODB	ITEM_TITLE	16	Logging:
860	AUTODB	INTRO	64	Create a database from nodes 1-8.
861	AUTODB	INTRO	64	The following is a summary of the blocks created.
862	AUTODB	INTRO	64	Use the APP MGR to load the data base.
863	AUTODB	DIALOG_TITLE	28	Saving Database
865	AUTODB	ITEM_TITLE	16	Creating:
866	AUTODB	ITEM_TITLE	16	Num Blocks:
867	AUTODB	ITEM_TITLE	16	Nodes Found:
868	AUTODB	ITEM_TITLE	16	File:
869	AUTODB	ITEM_TITLE	16	Node:
870	AUTODB	BUTTON_TEXT	12	CREATE
900	DIAGMENU	PAGE_TITLE	20	Diagnostics
901	DIAGMENU	LEGEND	11	DIAGS
910	AMCDIAG	LEGEND	11	MODBUS/M
911	AMCDIAG	PAGE_TITLE	20	Modbus Comms Diags
912	AMCDIAG	ITEM_TITLE	27	Requests – Lost:
913	AMCDIAG	ITEM_TITLE	27	Requests – Aborted:
914	AMCDIAG	ITEM_TITLE	27	Requests – Total:
915	AMCDIAG	ITEM_TITLE	27	Replies – Good:
916	AMCDIAG	ITEM_TITLE	27	Replies – Rejection:
917	AMCDIAG	ITEM_TITLE	27	Replies – Timed Out:
918	AMCDIAG	ITEM_TITLE	27	Replies – Link Error:

## 5.2.4 THE DICTIONARY (Cont.)

No.	Context	Class	Max	Text
919	AMCDIAG	ITEM_TITLE	27	Total Cyclic Updates:
920	AMCDIAG	ITEM_TITLE	27	Late Cyclic Updates:
921	AMCDIAG	ITEM_TITLE	27	Node Fault:
922	AMCDIAG	ITEM_TITLE	27	Line Fault:
923	AMCDIAG	ITEM_TITLE	27	Line Number:
924	AMCDIAG	ITEM_TITLE	27	Node Number:
925	AMCDIAG	BUTTON_TEXT	12	RESET
929	AMCDIAG	ITEM	8	<ALL>
930	MAINTMEN	MENU_TITLE	16	Maintenance
931	MAINTMEN	LEGEND	11	MAINT
932	FILEMGR	PAGE_TITLE	20	File Manager
933	FILEMGR	LEGEND	11	FILE MGR
934	FILEMGR	ITEM_TITLE	16	Device:
935	FILEMGR	ITEM_TITLE	16	Filter:
936	FILEMGR	ITEM_TITLE	16	File:
937	FILEMGR	ITEM_TITLE	16	Size:
938	FILEMGR	ITEM_TITLE	16	Free Space:
939	FILEMGR	ITEM_UNITS	9	Bytes
940	FILEMGR	BUTTON_TEXT	12	COPY
941	FILEMGR	BUTTON_TEXT	12	DELETE
942	FILEMGR	PAGE_TITLE	20	Copy File
943	FILEMGR	PARA	24	Copy To
944	FILEMGR	PAGE_TITLE	20	Confirm Delete
945	FILEMGR	ITEM_TITLE	16	Segment:
946	FILEMGR	ITEM_TITLE	16	Node:
947	FILEMGR	ITEM-UNITS	9	(Local)
948	FILEMGR	MESSAGE	128	Remote file access. Please wait...
951	AGP	ITEM_TITLE	12	Missing
952	AGP	ITEM_TITLE	12	Wrong
953	AGP	ITEM_TITLE	12	Unknown
954	AGP	ITEM_TITLE	12	Comm Err
961	AGP	ITEM_TITLE	12	Sensor Break
962	AGP	ITEM_TITLE	12	CJC Fail
963	AGP	ITEM_TITLE	12	Not Used
964	AGP	ITEM_TITLE	12	OP Sat
965	AGP	ITEM_TITLE	12	Init
966	AGP	ITEM_TITLE	12	Inv Cal
968	AGP	ITEM_TITLE	12	Mod Fail
970	AGP	ITEM_TITLE	3	AI2
971	AGP	ITEM_TITLE	3	DI4
972	AGP	ITEM_TITLE	3	DO4
973	AGP	ITEM_TITLE	3	AO2
974	AGP	ITEM_TITLE	3	AI3
975	AGP	ITEM_TITLE	3	DI8
976	AGP	ITEM_TITLE	3	AI4
977	AGP	ITEM_TITLE	3	AO4
978	AGP	ITEM_TITLE	3	DO8
979	AGP	ITEM_TITLE	3	AI4
980	AGP	ITEM_TITLE	3	DI6
990	AGP	ITEM_TITLE	16	XP

## 5.2.4 THE DICTIONARY (Cont.)

No.	Context	Class	Max	Text
991	AGP	ITEM_TITLE	16	TI
992	AGP	ITEM_TITLE	16	TD
993	AGP	ITEM_TITLE	16	RCG
994	AGP	ITEM_TITLE	16	CBH
995	AGP	ITEM_TITLE	16	CBL
996	AGP	ITEM_TITLE	16	MR
997	AGP	ITEM_TITLE	16	Act
1000	AGP	PAGE_TITLE	20	FB Manager
1001	AGP	LEGEND	11	FB MGR
1002	FB_MGR	ITEM_TITLE	16	Block name:
1003	FB_MGR	ITEM_TITLE	16	Block type:
1004	FB_MGR	ITEM_TITLE	16	Cached from:
1005	FB_MGR	ITEM_TITLE	4	ms
1006	FB_MGR	ITEM_TITLE	16	Update rate:
1007	FB_MGR	ITEM_TITLE	16	Update rate:
1008	FB_MGR	ITEM_TITLE	16	Update rate:
1009	FB_MGR	ITEM	16	No connections
1010	ACCESS	INTRO	64	User ID and password, then LOG ON
1011	ACCESS	ITEM_TITLE	18	Ident:
1012	ACCESS	ITEM_TITLE	18	Name:
1013	ACCESS	BUTTON_TEXT	12	LOG ON
1014	ACCESS	ITEM_TITLE	18	Access:
1015	ACCESS	PAGE_TITLE	20	User Password
1016	ACCESS	INTRO	64	please re-enter User password:
1017	ACCESS	BUTTON_TEXT	12	PASSWD
1018	ACCESS	BUTTON_TEXT	12	USERS
1020	ACCESS	BUTTON_TEXT	12	LOG OFF
1021	ACCESS	INTRO	64	To change to Multi-User mode, select OK. See documentation for password information
1023	ACCESS	PAGE_TITLE	20	Multi-User select
1024	ACCESS	DIALOG_TEXT	80	Changing to multi_user mode will be irreversible! Select OK to continue
1025	ACCESS	DIALOGUE_TITLE	28	Confirm Multi-User mode
1026	ACCESS	COL_TITLE	10	Identity
1027	ACCESS	COL_TITLE	10	Reference
1028	ACCESS	COL_TITLE	10	Name
1029	ACCESS	COL_TITLE	10	Access
1030	ACCESS	ITEM_TITLE	18	Identity:
1031	ACCESS	ITEM_TITLE	18	Password:
1032	ACCESS	ITEM_TITLE	18	Confirm:
1033	ACCESS	BUTTON_TEXT	12	NEW
1034	ACCESS	BUTTON_TEXT	12	DELETE
1035	ACCESS	DIALOGUE_TITLE	28	Delete User
1036	ACCESS	DIALOGUE_TITLE	28	New User
1037	ACCESS	MESSAGE	128	Sorting entries, please wait
1038	ACCESS	BUTTON_TEXT	12	DISABLE
1039	ACCESS	MESSAGE	128	Your password has expired. You must change it now.
1060	CLONE	ITEM_TITLE	22	Forms:
1061	UPGRADE	DIALOG_TITLE	24	<Assemble autoexec.o>
1062	UPGRADE	MESSAGE	128	Error encountered when assembling autoexec.o

## 5.2.4 THE DICTIONARY (Cont.)

No.	Context	Class	Max	Text
1063	CLONE	ITEM_TITLE	16	Security Access:
1064	CLONE	ITEM_TITLE	16	Net Audit setup:
1065	CLONE	ITEM_TITLE	16	Signature setup:
1066	CLONE	ITEM_TITLE	16	Include Source Files:
1067	CLONE	ITEM_TITLE	22	Category:
1068	CLONE	DIALOG_TITLE	28	WARNING
1069	CLONE	DIALOG_TEXT	80	No files have been transferred.
1071	FB_MGR	BUTTON_TEXT	12	CREATE
1072	FB_MGR	BUTTON_TEXT	12	DELETE
1073	FB_MGR	BUTTON_TEXT	12	SAVE
1080	FB_MGR	DIALOGUE TITLE	28	Block Create
1081	FB_MGR	ITEM_TITLE	16	Category:
1082	FB_MGR	ITEM_TITLE	16	Block Type:
1083	FB_MGR	DIALOG_TITLE	28	Confirm Block Delete
1084	FB_MGR	BUTTON_TEXT	12	NETWORK
1085	FB_MGR	PAGE_TITLE	20	Network Set Up
1090	MSG	PAGE_TITLE	20	Messages
1091	MSG	LEGEND	11	MSG LIST
1092	ALMMENU	LEGEND	11	MESSAGES
1093	MSG	MESSAGE	16	<None>
1100	RECIPE	LEGEND	11	RECIPE
1101	RECIPE	MENU_TITLE	16	Recipe
1102	RECIPE	BUTTON_TEXT	12	DOWNLOAD
1103	RECIPE	BUTTON_TEXT	12	ABORT
1104	RECIPE	BUTTON_TEXT	12	LOAD
1105	RECIPE	BUTTON_TEXT	12	SAVE
1106	RECIPE	BUTTON_TEXT	12	SAVE AS
1107	RECIPE	BUTTON_TEXT	12	CAPTURE
1108	RECIPE	BUTTON_TEXT	12	CAPTURE AS
1109	RECIPE	BUTTON_TEXT	12	NEW
1110	RECIPE	BUTTON_TEXT	12	DELETE
1111	RECIPE	BUTTON_TEXT	12	ADD LINE
1112	RECIPE	BUTTON_TEXT	12	DELETE
1113	RECIPE	BUTTON_TEXT	12	INSERT
1114	RECIPE	BUTTON_TEXT	12	CREATE
1115	RECIPE	BUTTON_TEXT	12	LINES
1120	RECIPE	LEGEND	11	RECIPES
1121	RECIPE	PAGE_TITLE	20	Load/Save Recipe
1122	RECIPE	LEGEND	11	STATUS
1123	RECIPE	PAGE_TITLE	20	Recipe Status
1124	RECIPE	ITEM_TITLE	16	Downloaded at:
1125	RECIPE	ITEM_TITLE	16	Version:
1126	RECIPE	ITEM_TITLE	16	Edited by:
1127	RECIPE	ITEM_TITLE	16	At:
1128	RECIPE	ITEM_TITLE	16	Timeout:
1130	RECIPE	ITEM_TITLE	16	Status:
1131	RECIPE	ITEM	12	RESET
1132	RECIPE	ITEM	12	DOWNLOADING
1133	RECIPE	ITEM	12	COMPLETE

## 5.2.4 THE DICTIONARY (Cont.)

No.	Context	Class	Max	Text
1134	RECIPE	ITEM	12	FAILURE
1140	RECIPE	DIALOG_TITLE	28	RECIPE ERROR
1141	RECIPE	MESSAGE	128	Recipe File not found
1142	RECIPE	MESSAGE	128	Recipe File limits exceeded
1143	RECIPE	MESSAGE	128	Invalid block reference(s)
1144	RECIPE	MESSAGE	128	Recipe download in progress
1145	RECIPE	MESSAGE	128	Unrecognised file format
1146	RECIPE	MESSAGE	128	File write error
1150	RECIPE	LEGEND	11	MONITOR
1151	RECIPE	PAGE_TITLE	20	Recipe Monitor
1152	RECIPE	PAGE_TITLE	20	SP
1153	RECIPE	PAGE_TITLE	20	SP(Live)
1154	RECIPE	PAGE_TITLE	20	PV
1155	RECIPE	PAGE_TITLE	20	Capture
1160	RECIPE	PAGE_TITLE	20	RCP
1161	RECIPE	ITEM_TITLE	16	Id:
1162	RECIPE	ITEM_TITLE	16	File Name:
1163	RECIPE	ITEM_TITLE	16	Line:
1164	RECIPE	ITEM_TITLE	16	Recipe Name:
1165	RECIPE	ITEM_TITLE	16	Variable Name:
1168	RECIPE	ITEM	8	FALSE
1169	RECIPE	ITEM	8	TRUE
1170	RECIPE	LEGEND	11	EDIT
1171	RECIPE	PAGE_TITLE	20	Recipe Editor
1172	RECIPE	ITEM_TITLE	16	Verify:
1173	RECIPE	PARA	24	Tag References
1174	RECIPE	ITEM_TITLE	16	SP:
1175	RECIPE	ITEM_TITLE	16	Monitor:
1176	RECIPE	ITEM_TITLE	16	Capture:
1180	RECIPE	DIALOG_TITLE	28	New Recipe
1181	RECIPE	DIALOG_TITLE	28	Capture New Recipe
1182	RECIPE	DIALOG_TITLE	28	Delete Recipe
1183	RECIPE	DIALOG_TEXT	80	Deleting
1184	RECIPE	DIALOG_TITLE	28	SAVE
1185	RECIPE	DIALOG_TITLE	28	SAVE AS...
1186	RECIPE	ITEM_TITLE	16	File Name:
1187	RECIPE	DIALOG_TITLE	28	Load Recipe File
1188	RECIPE	DIALOG_TEXT	80	Recipe already loaded.
1189	RECIPE	DIALOG_TITLE	28	UNSAVED EDITS
1190	RECIPE	DIALOG_TEXT	80	This operation will result in the loss of recipe edits which have not yet been saved.
1191	RECIPE	DIALOG_TEXT	80	Overwriting
1192	RECIPE	DIALOG_TITLE	28	Delete Variable
1193	RECIPE	DIALOG_TITLE	28	Properties
1194	RECIPE	DIALOG_TITLE	28	Insert Variable
1195	RECIPE	DIALOG_TITLE	28	RECIPE FILE DELETE
1196	RECIPE	DIALOG_TITLE	28	CREATE AS...
1197	RECIPE	DIALOG_TITLE	28	SELECT LINE
1198	RECIPE	DIALOG_TITLE	28	Capture Recipe
1199	RECIPE	DIALOG_TEXT	80	Capturing
1200	BATCH	LEGEND	11	BATCH
1201	BATCH	MENU_TITLE	16	Batch



## 5.2.4 THE DICTIONARY (Cont.)

No.	Context	Class	Max	Text
1202	BATCH	BATCH_STATE	12	RESET
1203	BATCH	BATCH_STATE	12	IDLE
1204	BATCH	BATCH_STATE	12	STARTING
1205	BATCH	BATCH_STATE	12	RUNNING
1206	BATCH	BATCH_STATE	12	COMPLETE
1207	BATCH	BATCH_STATE	12	HOLDING
1208	BATCH	BATCH_STATE	12	HELD
1209	BATCH	BATCH_STATE	12	RESTARTING
1210	BATCH	BATCH_STATE	12	PAUSING
1211	BATCH	BATCH_STATE	12	PAUSED
1212	BATCH	BATCH_STATE	12	RESUMING
1213	BATCH	BATCH_STATE	12	STOPPING
1214	BATCH	BATCH_STATE	12	STOPPED
1215	BATCH	BATCH_STATE	12	ABORTING
1216	BATCH	BATCH_STATE	12	ABORTED
1217	BATCH	BATCH_STATE	12	FAILED
1220	BATCH	LEGEND	11	BATCHES
1221	BATCH	PAGE_TITLE	20	Load Batch
1222	BATCH	ITEM_TITLE	16	File Name:
1223	BATCH	ITEM_TITLE	16	Recipe Name:
1224	BATCH	ITEM_TITLE	16	Id:
1225	BATCH	ITEM_TITLE	16	State:
1226	BATCH	ITEM_TITLE	16	Started At:
1227	BATCH	ITEM_TITLE	16	Phase:
1228	BATCH	ITEM_TITLE	16	Batch Id:
1229	BATCH	ITEM_TITLE	16	Ended At:
1230	BATCH	BUTTON_TEXT	12	LOAD
1231	BATCH	BUTTON_TEXT	12	START
1232	BATCH	BUTTON_TEXT	12	HOLD
1233	BATCH	BUTTON_TEXT	12	RESTART
1234	BATCH	BUTTON_TEXT	12	ABORT
1235	BATCH	BUTTON_TEXT	12	RESET
1236	BATCH	BUTTON_TEXT	12	NOTE
1237	BATCH	BUTTON_TEXT	12	SAVE AS
1238	BATCH	BUTTON_TEXT	12	CREATE
1240	BATCH	LEGEND	11	STATUS
1241	BATCH	PAGE_TITLE	20	Batch Status
1245	BATCH	PAGE_TITLE	20	Batch Start
1250	BATCH	DIALOG_TITLE	28	BATCH ERROR
1251	BATCH	MESSAGE	128	Batch File not found
1252	BATCH	MESSAGE	128	Batch File limits exceeded
1253	BATCH	MESSAGE	128	Invalid block reference(s)
1254	BATCH	MESSAGE	128	Incorrect batch state
1255	BATCH	MESSAGE	128	Unrecognised file format
1256	BATCH	MESSAGE	128	File write error
1257	BATCH	MESSAGE	128	Bad block
1258	BATCH	MESSAGE	128	Invalid dictionary reference
1259	BATCH	MESSAGE	128	Incorrect password
1260	BATCH	MESSAGE	128	Shared block reference(s)
1270	BATCH	DIALOG_TITLE	28	Batch Start Confirm
1271	BATCH	DIALOG_TEXT	80	Please confirm starting of batch.

## 5.2.4 THE DICTIONARY (Cont.)

No.	Context	Class	Max	Text
1272	BATCH	DIALOG_TEXT	80	Please confirm your password to start batch.
1273	BATCH	ITEM_TITLE	16	Password:
1280	BATCH	DIALOG_TITLE	28	BATCH NOTE
1281	BATCH	DIALOG_TEXT	80	Add a batch note.
1282	BATCH	ITEM_TITLE	16	Note:
1285	BATCH	DIALOG_TITLE	28	SAVE AS ..
1286	BATCH	DIALOG_TEXT	80	Save batch file
1287	BATCH	ITEM_TITLE	16	Filename:
1288	BATCH	DIALOG_TITLE	28	SAVE
1289	BATCH	DIALOG_TEXT	80	Overwriting
1290	BATCH	DIALOG_TITLE	28	CREATE AS ..
1292	BATCH	ITEM_TITLE	16	Recipe Line:
1293	BATCH	ITEM_TITLE	16	Display Group:
1294	BATCH	ITEM_TITLE	16	Message:
1295	BATCH	ITEM_TITLE	16	Log Group:
1296	BATCH	ITEM_TITLE	16	Log Report:
1300	ACCESS	BUTTON TEXT	12	PROPERTIES
1301	ACCESS	PAGE TITLE	20	Account properties
1302	ACCESS	ITEM_TITLE	18	Min User Id Length:
1303	ACCESS	ITEM_TITLE	18	Min Password Length:
1304	ACCESS	ITEM_TITLE	18	Max Login Attempts:
1305	ACCESS	ITEM_TITLE	18	Password Expiry:
1306	ACCESS	ITEM_TITLE	18	User Timeout:
1307	ACCESS	MESSAGE	128	Reducing password expiry period may result in immediate account expiry.
1308	ACCESS	BUTTON_TEXT	12	REINSTATE
1309	ACCESS	ITEM_TITLE	18	Password Expires In:
1310	ACCESS	MESSAGE	128	Your password is due to expire. Please change it
1311	ACCESS	ITEM_TITLE	18	Expires
1312	ACCESS	ITEM_TITLE	18	Attributes
1313	ACCESS	BUTTON_TEXT	12	ENABLE
1314	ACCESS	PAGE_TITLE	20	Security Access - Retired
1315	ACCESS	DIALOG_TITLE	28	Retire User
1316	ACCESS	BUTTON_TEXT	12	RETIRE
1317	ACCESS	DIALOG_TITLE	28	ACCESS ERROR
1318	ACCESS	DIALOG_TEXT	80	Illegal Password
1319	ACCESS	DIALOG_TEXT	80	Illegal User ID and/or Name
1320	ACCESS	DIALOG_TEXT	80	User ID and/or Name Already In Use
1321	ACCESS	ITEM_TITLE	18	Sign:
1322	ACCESS	ITEM_TITLE	18	Authorise:
1323	ACCESS	ITEM TITLE	18	View Only:
1325	ACCESS	ITEM_TITLE	18	Admin Only:
1333	ACCESS	ITEM_TITLE	18	FTP:
1334	ACCESS	ITEM_TITLE	18	Remote:
1353	ACCESS	BUTTON TEXT	12	STATS
1354	ACCESS	PAGE_TITLE	20	Statistics
1355	ACCESS	ITEM_TITLE	18	Users:
1356	ACCESS	ITEM_TITLE	18	Retired Users:
1357	ACCESS	ITEM_TITLE	18	New Users:
1359	ACCESS	BUTTON_TEXT	12	MAINT
1360	ACCESS	PAGE_TITLE	20	Account Maintenance

**5.2.4 THE DICTIONARY (Cont.)**

No.	Context	Class	Max	Text
1361	ACCESS	ITEM_TITLE	18	Recovery Account:
1362	ACCESS	ITEM_TITLE	18	Master Access:
1363	ACCESS	ITEM_TITLE	18	Edit Own Expired Password:
1393	ACCESS	MESSAGE	128	Administrator Rights are Disabled
1394	ACCESS	BUTTON_TEXT	12	RECOVER
1395	ACCESS	PAGE_TITLE	20	Administration Recovery
1396	ACCESS	INTRO	64	Please report the key, date and time below to the support desk who will issue you with the recovery password
1397	ACCESS	ITEM_TITLE	18	Recovery Key:
1398	ACCESS	ITEM_TITLE	18	Date/Time:
1399	ACCESS	ITEM_TITLE	18	Minutes Left:
1400	ADMIN	MENU_TITLE	16	Administration
1401	ADMIN	LEGEND	11	ADMIN
1410	NET_AUDIT	PAGE_TITLE	20	Network Audit Trail
1411	NET_AUDIT	LEGEND	11	NET AUDIT
1412	NET_AUDIT	PARA	24	Destination node
1413	NET_AUDIT	ITEM_TITLE	18	LIN Node:
1414	NET_AUDIT	ITEM_TITLE	18	LIN Segment:
1415	NET_AUDIT	NAT_STATE	12	(Disabled)
1416	NET_AUDIT	NAT_STATE	12	UNINIT
1417	NET_AUDIT	NAT_STATE	12	INIT
1418	NET_AUDIT	NAT_STATE	12	CONNECTED
1419	NET_AUDIT	NAT_STATE	12	ACTIVE
1420	NET_AUDIT	ITEM_TITLE	18	Alarm active:
1421	NET_AUDIT	ITEM_TITLE	18	Alarm cleared:
1422	NET_AUDIT	ITEM_TITLE	18	Alarm ack'ed:
1423	NET_AUDIT	ITEM_TITLE	18	Cached alarms:
1424	NET_AUDIT	ITEM_TITLE	18	System event:
1425	NET_AUDIT	ITEM_TITLE	18	Block event:
1426	NET_AUDIT	ITEM_TITLE	18	Operator note:
1427	NET_AUDIT	ITEM_TITLE	18	Block value change:
1428	NET_AUDIT	ITEM_TITLE	18	Message active:
1429	NET_AUDIT	ITEM_TITLE	18	Message cleared:
1430	NET_AUDIT	ITEM_TITLE	18	Message ack'ed:
1436	NET_AUDIT	ITEM_TITLE	18	Min alarm priority:
1437	NET_AUDIT	ITEM_TITLE	18	Min event priority:
1450	NET_AUDIT	ITEM_TITLE	18	Mode:
1451	NET_AUDIT	NAT_STATE	12	ISOLATED
1452	NET_AUDIT	NAT_STATE	12	PROVIDER
1453	NET_AUDIT	NAT_STATE	12	CONSUMER
1459	NET_AUDIT	ITEM_TITLE	18	Revision:
1460	ACCESS	BUTTON_TEXT	12	DEPLOY
1461	ACCESS	PAGE_TITLE	20	Deploy Access
1462	ACCESS	ITEM_TITLE	18	Number of Slave Nodes:
1463	ACCESS	ITEM_TITLE	18	Slave Nodes:
1464	ACCESS	BUTTON_TEXT	12	CONFIG
1465	ACCESS	PAGE_TITLE	20	Deploy Access – Config
1466	ACCESS	BUTTON_TEXT	12	CLEAR
1467	ACCESS	BUTTON_TEXT	12	FILL
1468	ACCESS	BUTTON_TEXT	12	SORT

## 5.2.4 THE DICTIONARY (Cont.)

No.	Context	Class	Max	Text
1469	ACCESS	MESSAGE	128	Deploying...
1470	ACCESS	ITEM_TITLE	18	Node:
1471	ACCESS	MESSAGE	128	Aborting...
1480	ACCESS	BUTTON_TEXT	12	REVISION
1481	ACCESS	PAGE_TITLE	20	Revision Information
1482	ACCESS	ITEM_TITLE	18	Revision:
1483	ACCESS	ITEM_TITLE	18	Revised On:
1484	ACCESS	ITEM_TITLE	18	Revised By:
1485	ACCESS	ITEM_TITLE	18	Authorised By:
1486	ACCESS	ITEM_TITLE	18	Reason:
1487	ACCESS	ITEM_TITLE	18	Bound to:
1488	ACCESS	ITEM_TITLE	18	Operational Changes:
1500	SIGN	PAGE_TITLE	20	Signature Configuration
1501	SIGN	LEGEND	11	SIG CONFIG
1502	SIGN	ITEM_TITLE	18	Function:
1503	SIGN	BUTTON_TEXT	12	SAVE
1504	SIGN	BUTTON_TEXT	12	DEFAULTS
1505	SIGN	ITEM_TITLE	18	Revision:
1510	SIGN	SIG_LEVEL	16	No Confirmation
1511	SIGN	SIG_LEVEL	16	Confirm Only
1512	SIGN	SIG_LEVEL	16	Password
1513	SIGN	SIG_LEVEL	16	Signature
1514	SIGN	SIG_LEVEL	16	Sign & Authorise
1515	SIGN	SIG_LEVEL	16	Action Disabled
1520	SIGN	ITEM_TITLE	18	Field Changes:
1521	SIGN	ITEM_TITLE	18	Alarm priority Changes:
1522	SIGN	ITEM_TITLE	18	Units Changes:
1523	SIGN	ITEM_TITLE	16	Wiring Changes:
1524	SIGN	ITEM_TITLE	16	Field Changes:
1525	SIGN	ITEM_TITLE	16	Segment Change:
1526	SIGN	ITEM_TITLE	16	Segment Change (held):
1527	SIGN	ITEM_TITLE	16	Current Segment Change:
1528	SIGN	ITEM_TITLE	16	RUN (edited)
1529	SIGN	ITEM_TITLE	16	ACK (6-10)
1530	SIGN	ITEM_TITLE	16	ACH (11-15)
1531	SIGN	ITEM_TITLE	16	User Password Change:
1540	COMMS	COMMS_PORT	5	ENET1
1541	COMMS	COMMS_PORT	5	ENET2
1542	COMMS	COMMS_PORT	5	ENET3
1543	COMMS	COMMS_PORT	5	ENET4
1544	COMMS	COMMS_PORT	5	ENET5
1550	COMMS	COMMS_ITEM	8	ELIN
1551	COMMS	COMMS_ITEM	8	FTP
1560	COMMS	BUTTON TEXT	12	ETHERNET
1561	COMMS	PAGE_TITLE	20	Comms - Ethernet
1562	COMMS	PARA	24	LIN Protocol Setup
1563	COMMS	PARA	24	Local IP Setup
1564	COMMS	PARA	24	Remote Subnet Node List
1565	COMMS	SEPARATOR	1	.
1566	COMMS	ITEM_TITLE	16	Protocol Name:
1567	COMMS	ITEM_TITLE	16	All Subnet Enable:
1569	COMMS	ITEM_TITLE	16	Address Assignment:

**5.2.4 THE DICTIONARY (Cont.)**

No.	Context	Class	Max	Text
1570	COMMS	ITEM	16	Undefined
1571	COMMS	ITEM	16	Fixed
1572	COMMS	ITEM	16	DHCP
1573	COMMS	ITEM	16	BootP
1574	COMMS	ITEM	16	DHCP+LL
1575	COMMS	ITEM	16	BootP+LL
1576	COMMS	ITEM	16	Link Local
1580	COMMS	ITEM_TITLE	16	IP Address:
1581	COMMS	ITEM_TITLE	16	Subnet Mask:
1582	COMMS	ITEM_TITLE	16	Default Gateway:
1583	COMMS	ITEM_TITLE	16	Number of Nodes:
1584	COMMS	ITEM_TITLE	16	Node:
1585	COMMS	SEPARATOR	2	:
1586	COMMS	ITEM_TITLE	16	MAC Address:
1587	COMMS	DIALOG_TITLE	28	WARNING
1588	COMMS	DIALOG_TEXT	80	The specified IP address/mask combination may be invalid.
1590	COMMS	ITEM	16	None
1591	COMMS	ITEM	16	RO
1592	COMMS	ITEM	16	RW
1593	COMMS	ITEM	16	All

## 5.2.5 Panel customisation using the dictionary

It is possible to customise the standard panel interface by defining certain dictionary entries to be “empty”. An empty dictionary entry takes the form “S<N>,” in the .uyl file. Note: the “,” is the last character on the line, it must not be followed by any other (even a space character). If any of the dictionary entries listed below is set to be “empty” then the corresponding function is removed from the standard interface.

Note: do not define dictionary entries other than those listed below to be empty.

NO.	CONTEXT	TEXT	FUNCTION
62	ALMMENU	NOTE	Entering of notes into alarm history
428	SPP	RUN	Running the currently loaded program
429	SPP	HOLD	Hold the currently running program
430	SPP	ABORT	Aborting programs
436	SPP	DELETE	Delete a program
481	SPP	SCHEDULE	Scheduling programs
482	SPP	PREVIEW	Preview of program
483	SPP	PRE-PLOT	Live/preview combined display of program
484	SPP	EDIT	Editing of programs
490	SPP	RUN FROM	Starting a program part way through
570	SPP	SKIP	Skipping the currently executing segment
712	LOGGRP	File Type:	File type ASCII v PACKED
725	LOGGRP	Name Type:	Type of log file name
727	LOGGRP	Column Titles:	Enable/disable column titles in ASCII files
728	LOGGRP	Date Format:	Format of date/time in ASCII files
729	LOGGRP	Compr Ratio:	Compression of data in PACKED files.
732	LOGGRP	LOG NOW	Log an ASCII sample now
777	LOGAMAN	EXPORT ALL	Export from internal archive to removable medium
788	LOGGRP	IYEM_TITLE	Number of groups active out of total
796	LOGAMAN	EXPORT	Export from internal archive to removable medium
1018	ACCESS	USERS	Change to multi-user access
1108	RCP	CAPTURE AS	Capture live value to a new recipe
1111	RCP	ADD LINE	Add a production line to a recipe file
1114	RCP	CREATE	Create a new recipe file
1115	RCP	LINES	Display list of production lines
1166	RECIPE	ITEM_TITLE	File name filter
1234	BATCH	ABORT	Abort a running batch
1236	BATCH	NOTE	Enter a batch note
1238	BATCH	CREATE	Create a new batch file

## 5.2.6 Alarm/event customisation using the dictionary

The following dictionary entries may be defined to add additional information into the alarm text. In all cases the text (if defined) prefixes the another item. If a space is required between the prefix and the item this must be included in the dictionary item when defined. The text is used in the following contexts:

1. Panel Event Log (See section 3.5.6)
2. Alarms and events recorded on trends (See section 3.6.1)
3. Alarms and events recorded in log files
4. Printer (if configured)

No	Prefixes	Notes
580	Original value in a block field change event.	
581	New value in a block field change event.	
582	Message acknowledge reason	
583	Signature reason	Auditor Option Only
584	Logged in user's name	
585	Signature	Auditor Option Only
586	Authorisation	Auditor Option Only

### 5.3 THE ERROR TEXT DICTIONARY

The contents of the Error text dictionary on delivery are as follows:

<b>No.</b>	<b>CODE</b>	<b>TEXT</b>
E1	8301	Bad template
E2	8302	Bad block number
E3	8303	No free blocks
E4	8304	No free database memory
E5	8305	Not allowed by block create
E6	8306	In use
E7	8307	Max length =
E8	8308	No spare databases
E9	8309	Not enough memory
E10	8320	Bad library file
E11	8321	Bad template in library
E12	8322	Bad server
E13	8323	Cannot create EDB entry
E14	8324	Bad file version
E15	8325	Bad template spec
E16	8326	Unable to make block remote
E17	8327	Bad parent
E18	8328	Corrupt data in .DBF file
E19	8329	Corrupt block spec
E20	832A	Corrupt block data
E21	832B	Corrupt pool data
E22	832C	No free resources
E23	832D	Template not found
E24	832E	Template resource fault
E25	8330	Cannot start
E26	8331	Cannot stop
E27	8332	Empty database
E28	8333	Configurator in use
E29	8340	.DBF file write failed
E30	8341	More than one .RUN file found
E31	8342	.RUN file not found
E32	834A	Connection source is not an O/P
E33	834B	Multiple connection to same I/P
E34	834C	Connection destination not I/P
E35	834D	No free connection resources
E36	834E	Bad conn. Src/dest block/field
E37	834F	Invalid connection destination
E38	8350	Hot start switch is disabled
E39	8351	No database was running
E40	8352	Real-time clock is not running
E41	8353	Root block clock is not running
E42	8354	Hotstart time was exceeded
E43	8355	Root block is invalid
E44	8356	Too many control loops
E45	8357	Coldstart switch is disabled



### 5.3 THE ERROR TEXT DICTIONARY (Cont.)

As with the System text dictionary, it is possible to:

1. Replace any text item (Error message) in the Error text dictionary with messages customised for a particular industry or application and/or
2. Internationalise the messages by creating a new dictionary for each of up to ten languages

#### 5.3.1 Editing error messages

The Error dictionary supplied, is a part of the *\_system.uyl* file. To customise it, the principle is the same as for the System text dictionary:

1. In the Error text dictionary, find the text to be replaced
2. Note its reference number
3. Key in the reference number, and then the text you want to replace it with, related by the following syntax:  
E<N>,<text>

where:

<N> is the reference number of the record you want to change  
<text> is the replacement text.

For example: E7,File not found.

#### 5.3.2 Creating new language error text

Any additional language dictionaries that are created must be named *\_system0.uyl*, *\_system1.uyl*, *\_system2.uyl*, and so on up to *\_system9.uyl*, (one dictionary for each language to be implemented)

#### PROCEDURE

In Excel or any similar spreadsheet program:

1. Write a first column of reference numbers, from E1 to at least E45
2. In the second column, assign code numbers
3. In the third column, write the error message in the required language.

## 5.4 THE EVENT TEXT DICTIONARY

On delivery, the Event text dictionary is as listed below. As with the System and Error dictionaries, it is possible to:

1. Replace any text item (Event message) in the Event dictionary with messages customised for a particular industry or application, and/or
2. Internationalise the messages by creating a new dictionary for each of up to ten languages.

V11 to V13 take the User ID, V110 to 116 take the recipe file name or the recipe name.

No.	EVENT NAME	MAX LENGTH 1/4 VGA	MAX LENGTH SVGA	
V1	Clock set	16 characters	16 characters	
V2	Scramble key set	16 characters	16 characters	
V3	Started	N/A	16 characters	Note 1
V4	Ack all	16 characters	16 characters	
V5	Access Save	N/A	16 characters	
V6	Access Updated	N/A	16 characters	Note 1
V7	Timeout	8 characters	16 characters	
V8	Retired User	N/A	16 characters	Note 1
V9	Disqualified	8 characters	16 characters	
V10	Access change	16 characters	16 characters	
V11	Log on	8 characters	16 characters	
V12	Log off	8 characters	16 characters	
V13	Log fail	8 characters	16 characters	
V14	Password change	8 characters	16 characters	
V15	Expired user	8 characters	16 characters	
V16	Disable user	8 characters	16 characters	
V17	Enabled user	8 characters	16 characters	
V18	Deleted user	8 characters	16 characters	Note 2
V19	Created user	8 characters	16 characters	
V20	Purged user	N/A	16 characters	Note 1
V21	AMC mem full	16 characters	16 characters	
V22	Wr Fail	16 characters	16 characters	
V30	Profile	8 characters	16 characters	
V31	ITD mem full	16 characters	16 characters	
V33	Database Running	N/A	16 characters	
V34	Deleted file	8 characters	16 characters	
V35	Imported file	8 characters	16 characters	
V36	Deleted Database	8 characters	16 characters	
V37	Created Database	8 characters	16 characters	
V38	Renamed Block	8 characters	16 characters	Note 2
V39	Created Block	8 characters	16 characters	Note 2
V40	Deleted Block	8 characters	16 characters	Note 2
V41	Database Loaded	16 characters	16 characters	
V42	Database Started	16 characters	16 characters	
V44	Database Resumed	16 characters	16 characters	
V45	Database Restart	16 characters	16 characters	
V46	Database Stopped	16 characters	16 characters	
V47	Database Saved	16 characters	16 characters	
V48	Database Unload	16 characters	16 characters	
V49	Database Stop	16 characters	16 characters	

**Notes:**

- 1 Applies only to units fitted with the Auditor Option
- 2 Not applicable to units fitted with the Auditor Option

**5.4 THE EVENT TEXT DICTIONARY (Cont.)**

No.	EVENT NAME	MAX LENGTH 1/4 VGA	MAX LENGTH SVGA	
V50	Late	8 characters	16 characters	
V51	Loaded	8 characters	16 characters	
V52	No File	8 characters	16 characters	
V53	Too big	8 characters	16 characters	
V54	Bad refs	8 characters	16 characters	
V55	Sch load	8 characters	16 characters	
V56	Run	8 characters	16 characters	
V57	Held	8 characters	16 characters	
V58	Resume	8 characters	16 characters	
V59	Abort	8 characters	16 characters	
V60	Finish	8 characters	16 characters	
V62	Heldback	8 characters	16 characters	
V63	Restart	8 characters	16 characters	
V64	Overnest	8 characters	16 characters	
V65	Bad Prog	8 characters	16 characters	
V66	Sch Abrt	8 characters	16 characters	
V67	OverLims	8 characters	16 characters	
V68	Early	8 characters	16 characters	
V69	Ramp Dis	8 characters	16 characters	
V70	DBN Mem Full	16 characters	16 characters	
V71	Bad _SYSTEM.RES	16 characters	16 characters	
V72	Bad _SYSTEM.OPT	16 characters	16 characters	
V74	Comms Changed	16 characters	16 characters	
V75	Startup Changed	16 characters	16 characters	
V76	Instrument Reset	16 characters	16 characters	
V77	Health Relay	16 characters	16 characters	See Note 1
V78	Run Relay	16 characters	16 characters	See Note 1
V80	No .GWF Found	16 characters	16 characters	
V82	Created .GWF	16 characters	16 characters	
V83	Extra Modbus/S	16 characters	16 characters	
V85	Language	16 characters	16 characters	See Note 2
V86	Date Format	16 characters	16 characters	See Note 2
V87	Time Format	16 characters	16 characters	See Note 2
V88	Duration Format	16 characters	16 characters	See Note 2
V89	Program Edit	16 characters	16 characters	See Note 2
V94	Save	8 characters	16 characters	
V95	Deleted program	8 characters	16 characters	
V96	Run From	8 characters	16 characters	
V97	Skip Request	N/A	16 characters	See Note 1
V98	Segment Edit	16 characters	16 characters	See Note 2
V99	Segment Edit	16 characters	16 characters	See Note 2
V103	Deleted Log File	8 characters	16 characters	
V104	Too Big Log File	8 characters	16 characters	
V108	Schedule	8 characters	16 characters	
V109	Sch Clr	8 characters	16 characters	
V110	Load	8 characters	16 characters	
V111	Download	8 characters	16 characters	

**Notes**

1. Applies only to units fitted with the Auditor Option
2. Applies only to units with Enhanced data base option (available only with 520 CPU)

**5.4 THE EVENT TEXT DICTIONARY (Cont.)**

No.	EVENT NAME	MAX LENGTH 1/4 VGA	MAX LENGTH SVGA	
V112	Complete	8 characters	16 characters	
V113	Failed	8 characters	16 characters	
V114	Abort	8 characters	16 characters	
V115	Capture	8 characters	16 characters	
V117	Deleted Recipe	8 characters	16 characters	
V116	Save	8 characters	16 characters	
V120	Load	8 characters	16 characters	
V121	Start	8 characters	16 characters	
V122	Hold	8 characters	16 characters	
V123	Abort	8 characters	16 characters	
V124	Reset	8 characters	16 characters	
V125	Restart	8 characters	16 characters	
V126	Complete	8 characters	16 characters	
V127	Save	8 characters	16 characters	
V128	Pause	8 characters	16 characters	
V129	Resume	8 characters	16 characters	
V130	Stop	8 characters	16 characters	
V131	Phase	8 characters	16 characters	
V132	Create	8 characters	16 characters	
V140	Net Audit save	N/A	16 characters	See Note
V141	Lost Messages	N/A	16 characters	See Note
V142	Power Cycle	N/A	16 characters	See Note
V143	Net Audit Update	16 characters	16 characters	See Note
V150	Sig Conf Save	16 characters	16 characters	See Note
V151	Sig Conf Update	16 characters	16 characters	See Note
V157	Unused Signature	16 characters	16 characters	See Note
V158	Sign Fail	16 characters	16 characters	See Note
V159	Authorise Fail	16 characters	16 characters	See Note
V160	Min ID	8 characters	16 characters	
V161	Min Password	8 characters	16 characters	
V162	Max Login Attemp	8 characters	16 characters	
V163	Expire Pasword	8 characters	16 characters	
V164	Logout Timeout	8 characters	16 characters	
V168	Access Upd Fail	16 Characters	16 Characters	See Note
V169	Reinstated	16 characters	16 characters	See Note
V170	Recover Enable	16 characters	16 characters	
V171	Recover Disable	16 characters	16 characters	
V172	Master Access	16 characters	16 characters	See Note
V173	Slave Access	16 characters	16 characters	See Note
V174	Bind Access	16 characters	16 characters	See Note
V175	Unbind Acces	16 characters	16 characters	See Note
V176	Access Bind Fail	16 characters	16 characters	See Note
V177	ForcNew on PwdEx	16 characters	16 characters	See Note
V178	Disable on PwdEx	16 characters	16 characters	See Note
V179	Deploy Access	16 characters	16 characters	See Note
V180	Clock sync	16 characters	16 characters	
V181	Clock master	16 characters	16 characters	
V182	Clock slave	16 characters	16 characters	
V183	Clock isolated	16 characters	16 characters	
V185	Expired	16 characters	16 characters	See Note

Note: Applies only to units fitted with the Auditor Option

**5.4 THE EVENT TEXT DICTIONARY (Cont.)**

No	EVENT NAME	MAX LENGTH 1/4 VGA	MAX LENGTH SVGA	
V186	Invalid	16 characters	16 characters	See Note
V190	Log On Remote	8 characters	16 characters	
V191	Log Off remote	8 characters	16 characters	
V192	LogFail Remote	8 characters	16 characters	
V193	Timeout Remote	8 characters	16 characters	
V195	Log On FTP	8 characters	16 characters	
V196	Log Off FTP	8 characters	16 characters	
V197	LogFail FTP	8 characters	16 characters	
V198	Timeout FTP	8 characters	16 characters	

Note: Applies only to units fitted with the Auditor Option

### 5.4.1 Editing Event Messages

The Event dictionary supplied, forms a part of the *\_system.uyl* file. To customise it, the principle is the same as for the System and Error text dictionaries:

1. In the Event text dictionary, find the text to be replaced
2. Note its reference number
3. Key in the reference number, and then the replacement text related by `V<N>,<text>`

where: `<N>` is the reference number of the record to be changed  
`<text>` is the replacement text.

For example: `V41,Appn loaded.`

### 5.4.2 Creating new language error text

Any additional language dictionaries that are created must be named *\_event0.uyl*, *\_event.uyl*, *\_event2.uyl*, and so on up to *\_event9.uyl* (one dictionary for each language to be implemented).

#### PROCEDURE

Using a standard text or spreadsheet editor,

1. Write a first column of reference numbers, from V1 to at least V116
2. In the second column, write the error message in the required language.

Files should be saved as CSV files.

### 5.4.3 Event priorities

All events are initially, priority 1. It is possible to assign other priorities in order, for example, to filter events for use with the printer, logging or trends (using the DR\_ALARM blocks). As with alarms, each event may be assigned a priority of 0 to 15, inclusive, where priority 0 disables the event.

If such customisation is required, the optional file *\_SYSTEM.UYE* may be added to the system. This is a text file, containing a single line for each event requiring customisation. The syntax is : `<Event number>,<Priority>`, where the event number is obtained from the table above, and Priority is 0 to 15.

For example: `41,0`  
`42,0`

would cause the events 'Database loaded' and 'Database started' to be disabled

## 5.5 THE USER TEXT DICTIONARY

This dictionary (initially empty) is available for users who wish to enter their own texts for display on their Home page and User screens, with additional files to hold versions in other languages, if required. The User text dictionary is used in conjunction with the User Screen Editor. For more details refer to The User Screen Editor Handbook (part no. HA260749 U005).

For every System file there may be an optional User file to go with it.

Filenames and record syntaxes follow the pattern of those for the *\_system.uyl* files. Filenames are:  
*\_user.uyl* for the file holding terms customised in English (or other home language).  
*\_user<n>.uyl* for files holding other-language (international) versions,

with *n* taking integer values from 0 up to 9, one value for each language to be made available.

The syntax of each record is: *U<N>, <text>*

where:

*<N>* is the index number of the record

*<text>* is the text.

The dictionary can hold a maximum of 200 records, each consisting of up to 32 characters.

## 5.6 THE PROGRAMMER TEXT DICTIONARY

The Programmer text dictionary holds user-generated text items for display by the Setpoint Program Editor. For more details refer to The Setpoint Program Editor Handbook (part no. HA261134U005). Entries are user text, so the items - when written - are held in the User text dictionary, *\_user.uyl*.

The syntax of each record is: *P<N>, <text>*

where:

*<N>* is the index number of the record

*<text>* is the text.

The dictionary can hold 200 records, each up to 16 characters long.

## 5.7 PANEL NAVIGATION

This describes how to access the menu system in order to perform a task and achieve an objective.

This section consists of:

- 1 The Panel Navigation file ([Section 5.7.1](#))
  - The versions
  - Coding - The Bare Panel version, *\_system.pnl*
  - Coding - The Application Panel version, *\_default.pnl*
- 2 Editing the *\_default.pnl* file ([Section 5.7.2](#))
- 3 Line types ([Section 5.7.3](#))
  - [Panel Agent declaration](#)
  - [Panel Driver declaration](#)
  - [Home Page declaration](#)
  - [Root Page declaration](#)
  - [Initial Page declaration](#)
- 4 Agent types ([Section 5.7.4](#))

The architecture of the Standard Interface is coded in the Panel Navigation file, more usually called the *.pnl* file. This section of the manual describes the Panel Navigation file and how to edit it in order to customise the architecture of the Standard Interface to your own requirements.

The architecture of the User Screen Interface is assembled using the User Screen Editor and is held in other files. To customise the architecture of the User Screen Interface, see the User Screen Editor Handbook (part no. HA260749U005).

### 5.7.1 The Panel Navigation file

#### 5.7.1.1 THE VERSIONS

For any instrument there can be three versions of the Panel Navigation file held in software, with copies of two of them in ROM. The file names are *<appname>.pnl*, *\_default.pnl*, and *\_system.pnl*, with ROM copies of *\_default.pnl* and *\_system.pnl*.

Each of these versions is mostly a list of agents, with various parameters determining behaviour. Some of these parameters are agent-specific, others are generic.

Codings for *\_system.pnl* (the Bare Panel version) and *\_default.pnl* (called the Application Panel version here) follow.

---

**Note:** For units fitted with the Audit option, please see [section 5.7.1.2](#), for codings.

---

With an application (say, *<appname>*) loaded, the system looks for *<appname>.pnl*. This is a version that has been customised for that application and which will generate an interface architecture specifically for it. For an instrument that periodically runs different applications, there could be an *<appname>.pnl* for each application.

If *<appname>.pnl* cannot be found, the instrument searches for *\_default.pnl*. This is a generic version that works for all applications.

If *\_default.pnl* cannot be found, the instrument loads a firmware copy that can always be found in ROM. (The instrument is shipped with these files, and they are loss-proof.)

With no application loaded the system looks for a file called *\_system.pnl*, known as the 'bare' panel version (see also Chapter 4, section 4.3, Managing an Application). If this file cannot be found, the corresponding version in ROM is used.



**5.7.1.1 THE VERSIONS (Cont.)**

Coding - **The Bare Panel version** (*\_system.pnl*)

```
=====
SAMPLE BARE PANEL SYSTEM
=====
```

(Quarter-) VGA Driver:

D1,QVGA

Home Agent (set up for user page 1; if this does not exist then it will default to the System Summary, which has the lowest Id in the main pane)

H1

Initial page (first page after power-up) is the same

I1

Root Agent:

R1000

A1000,MENU,,,3,,,2010,4000,2210,2300,2100,2130,2400,1

A2010,SYS\_SUM

A2210,APP\_MGR,4,,,0

SETUP submenu

A2300,MENU,,,3,#S398,#S399,2030,2040,2050,2060,2070

A2030,STARTUP,,3

A2040,COMMS,,4

A2050,CLOCK,3

A2060,INTERNAT,,4

A2070,PANEL,,2

TEST submenu (TEST has 2 entry points)

A2100,MENU,3,,3,#S610,#S611,2110,2111

A2110,TEST,3

MAINTENANCE submenu

A2400,MENU,4,,3,#S930,#S931,2080,2120,2140

A2080,CLONE,4

A2120,UPGRADE,4

A2140,FILE\_MGR,4

A2130,AUTODB,4,,,2210

A4000,ACCESS

Dialogue Agent

A100000,DIALOG,,,4

==== END OF FILE ====

Continued

**5.7.1.1 THE VERSIONS (Cont.)**

**Coding** - Sample Application Panel version (*\_default.pnl*)

```
=====
SAMPLE APPLICATION PANEL SYSTEM
=====
```

(Quarter-) VGA Driver  
D1,QVGA

Home page is first User Page (or will default to Overview else System Summary,  
as this has the lowest Id in the main pane)

H1

Initial page (first page after power-up) is the user screen 100 (if present)  
I100

Root Menu  
R1000  
A1000,MENU,,,3,,,4000,2000,9000,1500,3000,7000,5000,1

System Submenu  
A2000,MENU,,,3,#S130,#S131,2010,2200,2300,2080

A2010,SYS\_SUM  
A2080,CLONE,4

Application sub-submenu  
A2200,MENU,,,3,#S396,#S397,2020,2210,2220,2230

A2020,APP\_SUM  
A2210,APP\_MGR,4,,,0  
A2220,MENU,,,3,#S900,#S901,2240,2241  
A2230,FB\_MGR,3,4,,0  
A2240,DIAGNOST,4,,,0

Setup sub-submenu  
A2300,MENU,,,3,#S398,#S399,2030,2040,2050,2060,2070

A2030,STARTUP,,3  
A2040,COMMS,,4  
A2050,CLOCK,3  
A2060,INTERNAT,,4  
A2070,PANEL,,2

(Continued)

**5.7.1.1 THE VERSIONS (Cont.)**

## Programmer

A3000,SPP\_MENU,2,3,3,3010

A3010,SPP,2,3,2,3000,1500

## Security Access

A4000,ACCESS

## Logging Submenu (LOGGING has 4 entry points)

A5000,MENU,2,,3,#S700,#S701,5010,5011,5012,5013

A5010,LOG,2,3,2

## Area/Group/Point displays

A1500,AGP,1,2,2

## Recipe

A7000,RCP\_MENU,2,3,3,7010

A7010,RECIPE,2,3,2,7000

## Batch

A8000,BATCH\_MENU,2,,3,8010

A8010,BATCH,2,3,2,8011

## Alarms

A9000,ALM\_MENU,2,,3,9010,9011,9021

A9010,ALM\_HIST,2,,2

A9020,MESSAGE,2,,3

## Dialog Agent

A100000,DIALOG,,,4

==== END OF FILE ====

### 5.7.1.2 Auditor option versions

This sub section contains listing similar to those in 5.7.1.1 above, but for instruments with the Auditor option fitted.

Coding - **The Bare Panel version** (*\_system.pnl*)

```
=====
SAMPLE BARE PANEL SYSTEM
(Auditor Option fitted)
=====
```

```
(Quarter-) VGA Driver:
D1,QVGA
```

Home Agent (set up for user page 1; if this does not exist then it will default to the System Summary, which has the lowest Id in the main pane)

```
H1
```

Initial page (first page after power-up) is the same

```
I1
```

Root Agent:

```
R1000
```

```
A1000,MENU,,,3,,,2010,4000,2210,2300,2100,2130,2400,2500,9012,1
```

```
A2010,SYS_SUM
```

```
A2210,APP_MGR,4,,,0
```

SETUP submenu

```
A2300,MENU,,,3,#S398,#S399,2030,2040,2050,2060,2070
```

```
A2030,STARTUP,,3
```

```
A2040,COMMS,,4
```

```
A2050,CLOCK,3
```

```
A2060,INTERNAT,,4
```

```
A2070,PANEL,,2
```

TEST submenu (TEST has 2 entry points)

```
A2100,MENU,3,,3,#S610,#S611,2110,2111
```

```
A2110,TEST,3
```

MAINTENANCE submenu

```
A2400,MENU,4,,3,#S930,#S931,2080,2120,2140
```

```
A2080,CLONE,4
```

```
A2120,UPGRADE,4
```

```
A2140,FILE_MGR,4
```

```
A2130,AUTODB,4,,,2210
```

Admin submenu

```
A2500,MENU,5,,3,#S1400,#S1401,2510,2520
```

```
A2510,NET_AUDIT,5
```

```
A2520,SIGN_CFG,5
```

```
A4000,ACCESS
```

Alarm History (for event log only)

```
A9010,ALM_HIST,2,,2
```

Dialogue Agent

```
A100000,DIALOG,,,4
```

Signature Agent

```
A200000,SIGN,,,5
```

```
==== END OF FILE =====
```

**5.7.1.2 AUDITOR PACK VERSIONS (Cont.)**

**Coding** - Sample Application Panel version (*\_default.pnl*)

```
=====
SAMPLE APPLICATION PANEL SYSTEM
(Auditor Option fitted)
=====
```

(Quarter-) VGA Driver  
D1,QVGA

Home page is first User Page (or will default to Overview else System Summary,  
as this has the lowest Id in the main pane)

H1

Initial page (first page after power-up) is the user screen 100 (if present)  
I100

Root Menu  
R1000  
A1000,MENU,,,3,,,4000,2000,9000,1500,3000,7000,8000,5000,1

System Submenu  
A2000,MENU,,,3,#S130,#S131,2010,2200,2300,2080,2500

A2010,SYS\_SUM  
A2080,CLONE,4

Application sub-submenu  
A2200,MENU,,,3,#S396,#S397,2020,2210,2220,2230

A2020,APP\_SUM  
A2210,APP\_MGR,4,,,0  
A2220,MENU,,,3,#S900,#S901,2240,2241  
A2230,FB\_MGR,3,4,,0  
A2240,DIAGNOST,4,,,0

Setup sub-submenu  
A2300,MENU,,,3,#S398,#S399,2030,2040,2050,2060,2070

A2030,STARTUP,,3  
A2040,COMMS,,4  
A2050,CLOCK,3  
A2060,INTERNAT,,4  
A2070,PANEL,,2

(Continued)

**5.7.1.2 AUDITOR PACK VERSIONS (Cont.)**

## Admin

A2500,MENU,5,,3,#S1400,#S1401,2510,2520

A2510,NET\_AUDIT,5

A2520,SIGN\_CFG,5

## Programmer

A3000,SPP\_MENU,2,3,3,3010

A3010,SPP,2,3,2,3000,1500

## Security Access

A4000,ACCESS

## Logging Submenu (LOGGING has 4 entry points)

A5000,MENU,2,,3,#S700,#S701,5010,5011,5012,5013

A5010,LOG,2,3,2

## Area/Group/Point displays

A1500,AGP,1,2,2

## Recipe

A7000,RCP\_MENU,2,3,3,7010

A7010,RECIPE,2,3,2,7000

## Batch

A8000,BATCH\_MENU,2,,3,8010

A8010,BATCH,2,3,2,8011

## Alarms

A9000,ALM\_MENU,2,,3,9010,9011,9021,9012

A9010,ALM\_HIST,2,,2

A9020,MESSAGE,2,,3

## Dialog Agent

A100000,DIALOG,,4

## Signature Agent

A200000,SIGN,,5

==== END OF FILE =====

## 5.7.2 Editing the *\_default.pnl* file

In order to change the architecture (layout) of the menu system the *\_default.pnl* file is edited.

For instance, for any one menu, it is possible to change:

- 1 its title and any other legends
- 2 which screen area it occupies (E.G. status area, Main pane, or pop-up menu)
- 3 which sub-menus it generates.

---

Note: It is possible to create a system that is un-navigable and unworkable. For instance, it is possible, inadvertently, to create a system which generates no panel display, and which therefore offers no means of recovery.

---

### 5.7.3 Line types

Please read the following in conjunction with the foregoing listings.

There are several distinct line types, each identified by its first character:

- 1 Panel Agent declaration, beginning with 'A'
- 2 Panel Driver declaration, beginning with 'D'
- 3 Home and Root page definitions, beginning with 'H' and 'R' respectively.
- 4 Initial page definition, beginning with 'I'
- 5 Comment lines, beginning with a 'space' character.

---

Notes:

1. The system will ignore anything it cannot interpret, rather than crash or hang up.
  2. The *\_default.pnl* file is a CSV file with lines terminated by either LF or CR-LF.
  3. The character '\ ' placed at the end of a line combines two lines into one 'logical line'. Repeated use will combine several displayed or printed lines into one logical line. If logical lines are more than 255 characters long, the 255th character is overwritten by subsequent characters.
  4. Line types may appear in any order.
  5. Lines beginning with any other character other than A, D, H or R are ignored, effectively making them comments.
  6. The Comment line type is self-explanatory; explanations of the other line types follow.
- 

#### 5.7.3.1 PANEL AGENT DECLARATION

Syntax: A<Id>,<Type>,<Access>,<WrAccess>,<Pane>,<Specifics>

where all parameters beyond <Type> are optional.

PARAMETER	MEANING
<Id>	is the Agent Id, specified as a decimal number from 1000 to 2 <sup>32</sup> - 1. (or hex, if preceded by 'X'). Ids 1-999 are reserved for user pages defined in the user screen (OFL) file.
<Type>	is a mnemonic for the panel agent type. For example, MENU, ALM_HIST, and so on. These are listed later.
<Access>	gives the security level required for entry to this agent, and is a digit from 1 to 4. The default is 1.
<WrAccess>	gives the security level for 'Write access' within this agent. The precise interpretation of this is agent-specific. The default is <Access>.
<Pane>	is the pane in which the agent is to operate, specified as a digit from 1 to 4 as follows: 1 = Status Pane 2 = Main Pane 3 = Popup Pane 4 = Dialogue Pane. If this parameter is omitted, then the Main Pane is selected by default. Only the Dialog agent operates in the Dialogue pane.

(Continued)



### 5.7.3.1 PANEL AGENT DECLARATION (Cont.)

Example: A9010,ALM\_HIST,2, ,2

Any further parameters are agent-specific in meaning. They must be comma separated, and each must be one of the following types:

- 1 Positive decimal number from 0 to  $2^{32} - 1$
- 2 Hex number, preceded by 'X', with up to 8 digits
- 3 String, within double-quotes
- 4 Dictionary string, using the format #S123, where S (for example) is the dictionary identifier and 123 (for example) is the index number. See the User Screen Editor Handbook for more information.

For example, for a Menu agent, the first two specific arguments are the *title* and *legend* respectively, which may be specified as either strings or dictionary strings. Most other panel agents supply their own title and legend, which may be customised if necessary by modifying the system dictionary.

Parameter specifics are:

<b>PANEL AGENT</b>	<b>PARAMETERS</b>
MENU	Ids for the agents accessed in this menu
SPP	Id for the associated SPP_MENU
SPP_MENU	Id for the associated SPP
ALM_MENU	Id for the associated ALM_HIST
APP_MGR:	Bit-encoding* for displayed keys (buttons)
(A) Application system	1 UNLOAD 2 SAVE 4 SAVE AS 8 STOP/START
(B) Bare system	1 LOAD 2 LOAD AND RUN 4 DELETE

Example of a Menu Agent, using parameters to specify the agents to be accessed from the menu:

A1000,MENU, , ,3, , ,4000,2000,9000,3000,5000,1

\* The bit-encoding in the table above for the Application panel version, refers to the last parameter in the line A2210,APP\_MGR,4, , ,0 in the corresponding listing.

### 5.7.3.2 PANEL DRIVER DECLARATION

Syntax: D<Id>,<Type>[,<Specifics>]

where

<Id> is the driver identity. In a single driver system, this has no real significance.

<Type> is the mnemonic for the panel driver type. Currently the only type supported is QVGA.

Example: D1,QVGA

where the '1' in D1 is just an identifier for the driver, even if there is only one installed.

Currently there are no parameters for driver declarations.

### 5.7.3.3 HOME PAGE DECLARATION

Syntax: H<Id>

Example: H1

This defines the Home agent (the one active after power-up, or after a HOME timeout, which generates the Home page) If there is no Home declaration, it will default to the agent of numerically-lowest Id in the Main pane.

### 5.7.3.4 ROOT PAGE DECLARATION

The Root page is displayed when the Pop-up menu key is pressed, and it usually consists of a menu.

Syntax: R<Id>

Example: R1000

This defines the Root agent.

With no Root declaration, it will default to the lowest Id in the Pop-up pane. If there are no pop-up agents then it will be set equal to the Home agent.

### 5.7.3.5 INITIAL PAGE DECLARATION

The Initial page is displayed on start-up only. It offers the opportunity to have an introductory page that's different from the Home page.

Syntax I<Id>

Example: I1000

This defines the Initial agent.

## 5.7.4 Agent types

Table 5.7.4a sets out the types of agents used.

The Entry points column gives the number of entry points to each of the listed agents, and the number of IDs allocated will be the number in this column, starting at the specified ID. This should be born in mind when assigning Ids to agents, in order to avoid conflicts. Table 1.3.1b give details of those parameters with multiple entry points.

For each agent, the third column (headed 'Invalid') indicates under what circumstances, if any, the agent is not available. 'A' indicates that the agent is not available within an Application panel, and 'B' indicates that it is not available within a Bare panel.

MNEMONIC	ENTRY POINTS	INVALID	DESCRIPTION
ACCESS	1		Security access
AGP	1	B	Overview displays
ALM_HIST	2	B	Alarm History/Summary
ALM_MENU	1	B	Alarm Menu
APP_SUM	1	B	Application summary
AUTODB	1	A	Automatic database creation
BAT_MENU	1	B	Batch menu
BATCH	2	B	See table 5.8
CLOCK	1		Real time clock maintenance
CLONE	1		ISE cloning utilities
COMMS	1		Communications setup
DIAGNOST	1	B	Modbus master comms diagnostics
DIALOG	1		Dialogue box manager
FB_MGR	1	B	Function Block Manager
FILE_MGR	1	A	File Manager
INTERNAT	1		Internationalisation
LOGGING	4	B	Logging control and monitoring
MENU	1		General purpose menu
MESSAGE	2	B	See table 5.8
NET_AUDIT	1		Network Audit Trail Configuration
PANEL	1		Panel parameters, e.g. brightness
RCP_MENU	1	B	Recipe menu
RECIPE	4	B	See table 5.8
RESOURCES	1	A	System resources allocation
SIGN	1		Electronic Signatures manager
SPP	7	B	Setpoint Programmer
SPP_MENU	1	B	Setpoint Programmer Menu
STARTUP	1		Startup strategy definition
SYS_SUM	1		System summary
TEST	3	A	See table 5.8
UPGRADE	1	A	ISE product upgrade utility

Table 5.7.4a Agent types

#### 5.7.4 AGENT TYPES (Cont.)

The second column in Table 5.7.4a, on the previous page, shows that some agents have more than one entry point. The parameter values to invoke the respective sub-menus are as follows:

AGENT	VALUE	FACILITY
ALM_HIST	0	Alarm history
	1	Alarm summary
BATCH	0	Batch load/start
	1	Batch status
LOGGING	0	Monitor
	1	Off-line
	2	Archive Management
	3	Groups
MESSAGE	0	All messages on view
	1	Single message on view.
RECIPE	0	Recipe selection
	1	Recipe status
	2	Recipe Monitor
	3	Recipe editor
SPP	0	Monitor
	1	Programs
	2	Schedule
	3	Preplot
	4	Edit
	5	Preview
TEST	6	Run From
	0	Battery test
	1	Relay test
	2	Reset instrument

Table 5.7.4b Agent sub menus (for entry points >1)

## 5.8 DATABASE NAMES

The LIN database within any Visual Supervisor consists of a number of function blocks, some of which are set by Instrument manufacturer and are common to all Visual Supervisors, and some of which (function block names, alarm names and Enumerations) are specified by the user for the process to be controlled.

Function block names are open to change using LINtools, either by customers or by OEMs.

Enumerations are also editable, but not via LinTools (see section 5.8.3).

These three types of names/text items are held in Database Names files, called *.uyn* files. These files are optional, but where they exist there will be one per database (application). They take the name *<appname>.uyn*.

### 5.8.1 Function block names

Function block names are displayed in two facilities - Alarm History and Logging Groups - and in addition are used in logging files, where they are stored as ASCII.

The syntax for replacing an existing function block name is:

*<Block Alias>,<Block Name>*

where 'Block Alias' is the replacement text and 'Block Name' is the original LIN database name for the block.

For example: First Loop,Lp1 replaces the LIN database name 'Lp1' with the new name 'First Loop' .

---

*Note: The maximum number of characters for block aliases is eight for the small frame (1/4 VGA) unit and 16 for the large frame (SGVA) unit.*

---

### 5.8.2 Alarm names

These are displayed in the Alarm History page.

Syntax:

*<Alarm Alias>,<Block Name>.Alarms.<Alarm Name>* where 'Alarm Alias' is the replacement text and 'Alarm Name' is the original LIN database name for the block.

For example: Battery,T800.Alarms.BadBat replaces the current name (text) 'BadBat' with the new name (text) 'Battery'.

---

*Note: The maximum number of characters for alarm aliases is seven for the small frame (1/4 VGA) unit and 16 for the large frame (SGVA) unit (although only the first eight characters appear in the alarm pane - see section 2.6 for alarm pane details).*

---

### 5.8.3 Enumerations

Enumerations are nearly always Boolean two-state variables, such as TRUE/FALSE and OPEN/CLOSED. They are displayed as part of the Programmer graphical facilities (PREVIEW, PREPLOT, and EDIT), and are also used in logging files.

There are two types:

1 Syntax:

,<Block Name>.<Block Field>, “<Alias>,<Alias>”

For example: ,digital.Out,“OPEN,CLOSED”

This replaces the existing enumerations in block.field ‘digital.out’ with the new enumerations OPEN,CLOSED.

2 Syntax:

,<Block Name>.<Block Field>.<Block SubField>, “<Alias>,<Alias>”

For example: ,digital.Out.Bit1,“OPEN,CLOSED”

This replaces the existing enumerations in block.field.subfield ‘digital.out.bit1’ with the new enumerations OPEN,CLOSED.

### TAGS

Individual function block fields may be tagged, so that whenever a modification to the block is made from the touch screen, the modification is recorded in Event History.

Syntax:

<Field Tag>,<Block Name>.<Field Name>.<Bit number>

where field tag is the name that is used to identify the value when changed.

For example: LowTemp,PID.SL.Bit0

---

Note: the maximum number of characters that may be used for a field tag is eight for small frame (1/4VGA) units and sixteen for large frame (SGVA) units.

---

## 5.9 FORM FILES

The instrument uses two types of form file to configure output to printers, one for the generation of reports, the other for custom formatting of alarms (e.g. text colour change).

### 5.9.1 Report forms

An application containing DR\_REPRT blocks will reference report (.UYF) files. These files allow the printing of reports which feature:

Customised layout of information

Detailed control of the formatting of data items

Text (optionally internationalised)

LIN database variables

System variables – e.g. current date and time.

An example of a .UYF file is given in figure 5.9.1a, and the resulting output in 5.9.1b The various highlighted items are discussed below.

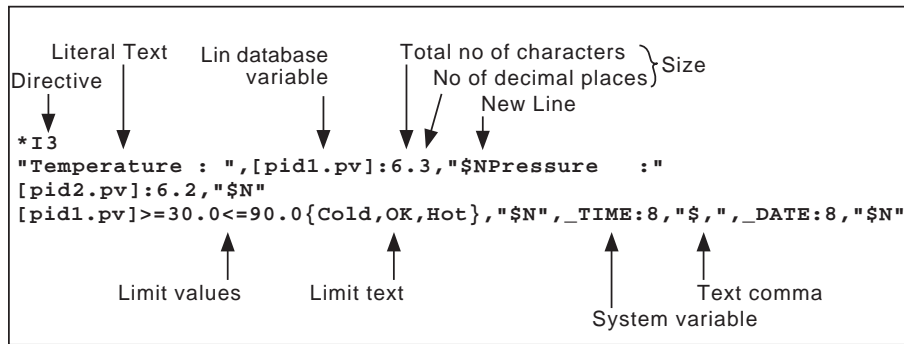

Figure 5.9.1a Sample .UYF file

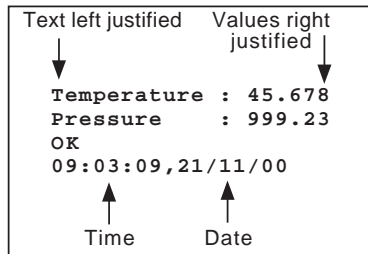

Figure 5.9.1b Printed output

## 5.9.1 REPORT FORMS (Cont.)

### 5.9.1.1 UYF FILE ENTRIES

The UYF file contains identification information (directive), followed by a list of those items (text and variables) which are to be included in the report. These items must be separated by commas, OR by New Line, Line feed or Carriage return instructions.

#### Rules

1. No line is to include more than 255 characters (not counting commas, linefeeds etc.)
2. No spaces or tabs may be included between items (although they may be included in text strings for formatting purposes).

#### Directive

The form identifier used to attach a number to the report for reference via function blocks. Different reports can be included in one .UYF file by preceding them with different Directives. The directive must precede the list of displayed items, and must occupy a line of its own. The syntax is \*I<number>, where <number> is an integer between 1 and 999 inclusive. No spaces are allowed.

#### Literal Text

Enclosed within double quotes, literal text is printed out as typed in. Special characters may be included as shown in table 5.9.1.1a, below. Any ASCII character can be included by typing \$nn, where nn is the hex code for the required character. If a colon followed by a number is included immediately after the text, then this will define the width of the field. E.G. "temperature =":20 would produce the text 'temperature =' followed by seven spaces. Text is left justified, unless otherwise specified, as described below in 'Formatting attributes'.

Entry	Definition	Hex
\$L or \$N	Line feed/new line	0A
\$P	Form feed	0C
\$R	Carriage Return	0D
\$T	Horizontal tab	09
\$" or ""	Double quotes	22
\$\$	Dollar symbol	24
\$,	Comma	2C
\${	Open curly bracket	7B
\$}	Close curly bracket	7D
\$nn	ASCII character nn	nn

Note: See Appendix C for ASCII Unicode Latin-1 character set codes

Table 5.9.1.1a Special characters

#### Dictionary text

Any item from any of the dictionaries described in section 5 can be included in the report. The syntax is #<dictionary ID><entry number>, where the dictionary ID is as follows:  
 Error Text dictionary ID = E  
 Event Text dictionary ID = V  
 Programmer Text dictionary ID = P  
 System dictionary ID = S  
 User Text dictionary ID = U  
 Thus, an entry of #U13 would cause item 13 of the User dictionary to be included in the report.



### 5.9.1.1 UYF FILE ENTRIES (Cont.)

Lin database variables	These variables consist of the block name, the field name and (if appropriate, the sub-field name). When included in the UYF file, these variables must be enclosed within square brackets e.g. [pid2.PV], and must be followed by a colon, then size information, giving the number of characters to be displayed.
Total number of characters	This gives the total number of characters (including any decimal point) to be displayed, with leading zeros suppressed. Values are right justified unless otherwise specified as described below in 'Formatting attributes'.
Number of decimal places.	If the total number of characters figure is followed by a full stop and a second number, then this second number will be the number of decimal places. For example, an entry of 6.1 means that the number format is xxxx.x, or an entry of 6.5 results in a format of .xxxxx
New Line	“\$N” Causes the following items to appear on a new line. For some types of printer, a carriage return (\$R) may also be needed.
Limit values/Limit text	<p>As shown in figure 5.9.1a, it is possible for a status line to be printed out according to the value of the variable. In the example given, the entry :</p> <pre>[PID1.pv]&gt;=30.0&lt;=90.0 {Cold,OK,Hot}</pre> <p>means that if the value of PID1 is 30.0 or more, but less than or equal to 90.0, the word 'OK' is printed. If the value is below 30.0 the word 'Cold' is printed, and if the value is above 90.0, the word 'Hot' is printed.</p> <p>It is possible to use alarm limits as the limit values, and also to use dictionary entries for the limit text e.g.</p> <pre>[PID1.PV]&gt;=[Pid.LL_SP]&lt;=[PID1.HL_SP]{#U10,#U11,#U14}</pre> <p>would print the text string held in item 11 of the User dictionary if the value of PID1 lies between the limits. If the value lies below the lower limit, the message held in U10 is printed, and if the value lies above the upper limit, the text held in U14 is printed.</p> <p>For Boolean variables, which are either false or true, the format is: [Variable]{,false text,true text}. For example, [Pid7.mode]{,Manual} would cause the word Manual to be printed when [Pid7.mode] becomes 'True', but nothing will be printed when the value becomes 'False'.</p>
System variables	<p>System variables (some of which are listed in table 5.9.1.1b) can be used to include system information in the report. In the example of Figure 5.9.1a, the items _TIME and _DATE are included to cause the system time and date to be included in the report. As with other variables, a suitable size must be allocated to the items, for formatting purposes. See the User Screen Editor handbook (HA260749U005) for a complete list.</p>

_ALM_ACT	Number of currently active alarms (integer)
_DATE	Current date, in appropriately internationalised format (string)
_RCP_NAME	Name of current recipe (string)
_SPP_NAME	Name of current program (string)
_TIME	Current time (string)
_USER_NAME	Name of user currently logged on (string)

Table 5.9.1.1b System variables

### 5.9.1.1 UYF FILE ENTRIES (Cont.)

#### FORMATTING ATTRIBUTES

Any one letter from each of the following groups of formatting codes that are applicable to a particular variable can be appended:

1. Enter C, L or R to format the associated value as centred, left justified or right justified respectively. (Text defaults to Left justified (L); Numeric values default to right justified (R).)
2. Enter Z to include leading or trailing zeros
3. For REAL variables: enter S to display the value in scientific notation (e.g. 1.23E-3)
4. For INTEGER variables, one of the following may be chosen:
  - X = Display values in hexadecimal format using capital A to F
  - x = Display values in hexadecimal format using lower case a to f
  - Y = Display values in binary format

For examples: If the value of the block 'PID1.options' is 42, then:

[Pid1.options]:8YZ prints 42 as an 8-bit binary value with leading zeros: 00101010,

[Pid1.options]:8XZ prints 42 as 0000002A, and

[Pid1.options]:4xL prints 42 as 2a␣ (where ␣ represents a space).

If the value of the block 'PID1.options' is 42.0 then:

[Pid1.options]:8S prints 42 as ␣␣4.2E1 (where ␣ represents a space).

#### BARGRAPHS

Simple bargraphs, consisting of a horizontal line of asterisks, can be included in the report, by the entry of scale low and high values and the adding of the letter B after the width character. For example, if the (user entered) scale is 0 to 50, and the width is 20, then a value of 0 is represented by zero asterisks, and a value of 50 is represented by 20 asterisks. Thus, for this example, each asterisk represents 20/50 or 0.4 of the scale. If the value is not a whole number of asterisks, then 'rounding' is applied.

Thus, a value of 42 would be represented by  $42 \times 0.4 = 16.8 = 17$  asterisks, but a value of 41, ( $41 \times 0.4 = 16.4$ ) would be represented by 16 asterisks. The 17th asterisk would 'turn on' when the process value reached 41.5

The following entry, includes literal text entries to show the low and high scale values:

"0 [“, [Loop1.PV]>=0<=50:20B, ”] 50" . For a value of 42, this produces the following printout:

```
0 [ ***** ] 50
```

#### FURTHER INFORMATION

- 1 Variables of type ENUM are printed textually even in the absence of an enumeration list, using the text defined within LIN. If an enumeration list is included, then all the desired strings must be included. **Empty or Over range valued do not default to the LIN strings.**
- 2 Alarm subfields (e.g. [PID1.ALARMS.HIGHABS]) behave as integers taking values 0 to 3:
  - 0 = Alarm not active, Alarm not unacknowledged
  - 1 = Alarm active and acknowledged
  - 2 = Alarm no longer active, but remains unacknowledged
  - 3 = Alarm active but not acknowledged.
 If the entire field is specified (e.g. [PID1.ALARMS]), a bitwise OR of all alarms is performed.

---

**Note:** The subfield 'Combined' is also accessible. This is derived from the individual alarms using a different algorithm.

- 3 It is mandatory to supply size information for all variables except when an enumeration list has been given, in which case, the width defaults to that of the longest string.

## 5.9.2 Alarm forms

**Note:** Ensure correct operation of each customised IDs, as any error in the ID will not be reported as an alarm in the LPTDEV block.

For any application with printer support, there can be an optional alarm message formatting form (.UYT) file. The file syntax is similar to the .UYF file described in section 5.9.1 above, to which reference should be made if necessary.

.UYT files are used to customise the way in which alarm and Event messages are printed in reports. These messages are invoked, when certain actions occur within the instrument. Each alarm or event has an identifier assigned to it so that the correct type of message can be selected.

The various identifiers are listed in table 5.9.2a, along with their applicability to various system variables which can be included in the report. These system variables are listed in table 5.9.2b In the case where a system variable is inapplicable, a blank is displayed.

ID	Invoked on	Applicable to					
		_A_BLOCK	_A_DATE	_A_NAME	_A_PRI	_A_TIME	_A_TYPE
1001	Alarm active	Y	Y	N	Y	Y	Y
1002	Alarm cleared	Y	Y	N	Y	Y	Y
1003	Alarm acknowledged	Y	Y	N	Y	Y	Y
1004	Block event	Y	Y	N	Y	Y	Y
1005	Block event with name	Y	Y	Y	Y	Y	Y
1006	System event	N	Y	N	Y	Y	Y
1007	System event with name	N	Y	Y	Y	Y	Y
1008	Operator note	N	Y	Y	Y	Y	N

Table 5.9.2a Alarm type identifiers

System variable	Definition
_A_BLOCK	The name of the associated function block
_A_DATE	The date associated with the queue entry
_A_NAME	A name associated with an event (e.g. SPP program name)
_A_PRI	The priority assigned to the alarm or event
_A_TIME	The time associated with the queue entry
_A_TYPE	The alarm or event type

Table 5.9.2b Alarm system variables

### 5.9.2.1 EXAMPLE

Figures 5.9.2.1a and 5.9.2.1b show an example of a .UYT file and a typical resulting appearance in the report, respectively.

```
*I1001
_A_DATE:8," ",_A_TIME:8," "
_A_BLOCK:8R,"/",_A_TYPE:8L,"ACTIVE ('_A_PRI:1,")$R$L"
*I1002
_A_DATE:8," ",_A_TIME:8," "
_A_BLOCK:8R,"/",_A_TYPE:8L,"Cleared$R$L"
```

Figure 5.9.2.1a Sample UYT file

```
14/08/00 10:22:33      Loop1/HighAbs  ACTIVE  (7)
14/08/00 10:23:07      Loop1/HighAbs  Cleared
```

Figure 5.9.2.1b Typical .UYT file printout

## 5.10 RECIPE FILES

For instruments supporting Recipes, it is possible to create Recipe files (.UYR) on a PC, using a text editor or spreadsheet that supports Comma separated variable (CSV) format files.

Each .UYR file consists of three parts. The first part is a 3-line header which describes, in a fixed format, the general information contained in the file. The second part consists of a single 'Title Line'. The final part consists of a number of lines, each describing a single variable

---

### Notes:

1. No line may exceed 512 characters, including line feed/carriage return instructions.
  2. Spaces are counted as characters
  3. String titles do not have to be unique
  4. Trailing commas will be treated as illegal unless otherwise stated.
  5. If a string length is exceeded, any 'extra' characters are lost when saving the file.
  6. Commas, double quotes ("), single quotes (') and equals signs are all illegal in fields.
  7. Non-printing characters (excluding <CR> and <LF>) are not permitted anywhere within the file
- 

### 5.10.1 Basic Recipe File

#### 5.10.1.1 FILE HEADER

Line 1

Line 1 must contain UYR,1 only

Line 2

Line two contains comma separated information about the current revision of the file e.g.

2,22/11/00,09:51:16,Fred Ungineer

Where

'2' is the revision level of the file

'22/11/00' is the day/month/year that revision was carried out

'09:51:16' is the hours:minutes:seconds that the revision was carried out.

'Fred Ungineer' is the name of the person who last modified the file.

Line 3

Line three defines the recipe set block to be used and recipe download timeout value, in seconds.

<Recipe Set Block>,<Timeout>

e.g. SET1,30

The recipe Set Block is the name of the RCP\_SET block to be used. If left blank, this field implies any RCP\_SET block.

If the download timeout is exceeded, the recipe download is assumed to have been unsuccessful, and the recipe goes into a failed state

### 5.10.1.2 TITLE LINE

This line defines how many recipes there are in the file, (minimum = one):  
 ,Setpoint:<Line Name>,<Recipe 1 Name>,-,-,<Recipe N name>

where:

<Line name> defines the name of the recipe line (not required for single line files)

<Recipe N name> is the name of the Nth recipe.

### 5.10.1.3 VARIABLE LINES

For each variable in the recipe, a line is required of the form:

<Name>,<Tag>,<Value 1>,-,-,<Value N>

where:

<Name> is the name of the variable

<Tag> is the tag name in the database. If the tag name is enclosed within braces ({}), the variable is considered to be non-verifiable

<Value N> is the value of the Nth recipe. The number of values must correspond with the number of recipes.

### 5.10.1.4 BASIC FILE EXAMPLE

Figure 5.10.1.4 is an example of a basic UYR file with three recipes.

```
UYR,1
6,22/11/00,10:31:38,Richard
,30
,Setpoint:1,Amarillo,Gulf Coast,Ekofisk
Methane,GasConc.Methane,90.67241,96.52220,85.90631
Nitrogen,CasConc.Nitrogen,3.128400,0.2595000,1.006800
Carbon dioxide,GasConc.CrbDiOx,0.4676001,0.5956001,1.495400
Ethane,GasConc.Ethane,4.527901,1.818600,8.491899
Propane,GasConc.Propane,0.8280000,0.4596000,2.301500
Water,GasConc.Water,0.000000,0.000000,0.000000
Hydrogen Sulphid,GasConc.Hsulphid,0.000000,0.000000,0.000000
Hydrogen,GasConc.Hydrogen,0.000000,0.000000,0.000000
Carbon Monoxide,GasConc.CrbMonOx,0.000000,0.000000,0.000000
Oxygen,GasConc.Oxygen,0.000000,0.000000,0.000000
i Butane,GasConc.iButane,0.1037000,0.09770000,0.3846000
n Butane,GasConc.nButane,0.1563000,0.1007000,0.3506000
i Pentane,GasConc.iPentane,0.032100,0.0473000,0.0509000
n Pentane,GasConc.nPentane,0.0443000,0.0324000,0.0480000
n Hexane,GasConc.nHexane,0.393000,0.0664000,0.0000000
```

Figure 5.10.1.4 Basic file example

## 5.10.2 More complex files

### 5.10.2.1 MULTI-LINE FILES

Figure 5.10.2.1, below shows a 2-line version of the basic file described above. The differences are:

In the Title line, field number 2 is included and the lines have been named.

In each variable line, a second field (GasConc2) is included. For the sake of consistency, GasConc has been changed to GasConc1.

```
UYR,1
7,22/11/00,10:53:30,Richard
,30
,Setpoint:Line 1,Setpoint:Line 2,Amarillo,Gulf Coast,Ekofisk
Methane,GasConc1.Methane,GasConc2.Methane,90.67241,96.52220,85.90631
Nitrogen,GasConc1.Nitrogen,GasConc2.Nitrogen,3.128400,0.2595000,1.006800
Carbon dioxide,GasConc1.CrbDiOx,GasConc2.CrbDiOx,0.4676001,0.5956001,1.495400
Ethane,GasConc1.Ethane,GasConc2.Ethane,4.527901,1.818600,8.491899
Propane,GasConc1.Propane,GasConc2.Propane,0.8280000,0.4596000,2.301500
Water,GasConc1.Water,GasConc2.Water,0.000000,0.000000,0.000000
Hydrogen Sulphid,GasConc1.Hsulphid,GasConc2.Hsulphid,0.000000,0.000000,0.000000
Hydrogen,GasConc1.Hydrogen,GasConc2.Hydrogen,0.000000,0.000000,0.000000
Carbon Monoxide,GasConc1.CrbMonOx,GasConc2.CrbMonOx,0.000000,0.000000,0.000000
Oxygen,GasConc1.Oxygen,GasConc2.Oxygen,0.000000,0.000000,0.000000
i Butane,GasConc1.iButane,GasConc2.iButane,0.1037000,0.09770000,0.3846000
n Butane,GasConc1.nButane,GasConc2.nButane,0.1563000,0.1007000,0.3506000
i Pentane,GasConc1.iPentane,GasConc2.iPentane,0.032100,0.0473000,0.0509000
n Pentane,GasConc1.nPentane,GasConc2.nPentane,0.0443000,0.0324000,0.0480000
n Hexane,GasConc1.nHexane,GasConc2.nHexane,0.393000,0.0664000,0.0000000
```

Figure 5.10.2.1 Multi-line file example

### 5.10.2.2 FILES WITH OPTIONAL CAPTURE VARIABLES

To generate a recipe file with separate capture points, then for each recipe line there must be an additional field after each column in the title line and for each variable. The title line entry should be an item called “Capture”, and the field for the variable is the tag of the field to be captured. This field may be left blank if no capture value is to be specified.

Figure 5.10.2.2 shows the 2-line file of figure 5.10.2.1, with capture variable on the first two variables.

```
UYR,1
7,22/11/00,10:53:30,Richard
,30
,Setpoint:Line 1,Capture,Setpoint:Line 2,Capture,Amarillo,Gulf Coast,Ekofisk
Methane,GasConc1.Methane,loop11.pv,GasConc2.Methane,loop21.pv,90.67241,96.52220,85.90631
Nitrogen,GasConc1.Nitrogen,loop12.pv,GasConc2.Nitrogen,loop22.pv,3.128400,0.2595000,1.006800
Carbon dioxide,GasConc1.CrbDiOx,GasConc2.CrbDiOx,0.4676001,0.5956001,1.495400
Ethane,GasConc1.Ethane,GasConc2.Ethane,4.527901,1.818600,8.491899
Propane,GasConc1.Propane,GasConc2.Propane,0.8280000,0.4596000,2.301500
Water,GasConc1.Water,GasConc2.Water,0.000000,0.000000,0.000000
Hydrogen Sulphid,GasConc1.Hsulphid,GasConc2.Hsulphid,0.000000,0.000000,0.000000
Hydrogen,GasConc1.Hydrogen,GasConc2.Hydrogen,0.000000,0.000000,0.000000
Carbon Monoxide,GasConc1.CrbMonOx,GasConc2.CrbMonOx,0.000000,0.000000,0.000000
Oxygen,GasConc1.Oxygen,GasConc2.Oxygen,0.000000,0.000000,0.000000
i Butane,GasConc1.iButane,GasConc2.iButane,0.1037000,0.09770000,0.3846000
n Butane,GasConc1.nButane,GasConc2.nButane,0.1563000,0.1007000,0.3506000
i Pentane,GasConc1.iPentane,GasConc2.iPentane,0.032100,0.0473000,0.0509000
n Pentane,GasConc1.nPentane,GasConc2.nPentane,0.0443000,0.0324000,0.0480000
n Hexane,GasConc1.nHexane,GasConc2.nHexane,0.393000,0.0664000,0.0000000
```

Figure 5.10.2.2 UYR file example with Capture Variables

### 5.10.2.3 FILES WITH OPTIONAL MONITOR VARIABLES

To generate a recipe file with monitor points for each recipe line, an additional field must be included after each column in the title line, and for each variable. The title line entry should be an item called "Monitor". The field for the variable is the tag of the field to be monitored. Monitor fields must be placed after capture fields (if any).

Figure 5.10.2.3 shows a single-line file with monitor and capture points. See section 3.7.2 for details of Capture and Monitor

```

UYR,1
9,22/11/00,11:14:02,Richard
,30
,Setpoint:1,Capture,Monitor,Amarillo,Gulf Coast,Ekofisk
Methane,GasConc.Methane,GasConc.Methane,GasConc.Methane,90.67241,96.52220,85.90631
Nitrogen,GasConc.Nitrogen,GasConc.Nitrogen,GasConc.Nitrogen,3.128400,0.2595000,1.006800
Carbon dioxide,GasConc.CrbDiOx,GasConc.CrbDiOx,GasConc.CrbDiOx,0.4676001,0.5956001,1.495400
Ethane,GasConc.Ethane,GasConc.Ethane,GasConc.Ethane,4.527901,1.818600,8.491899
Propane,GasConc.Propane,GasConc.Propane,GasConc.Propane,0.8280000,0.4596000,2.301500
Water,GasConc.Water,GasConc.Water,GasConc.Water,0.000000,0.000000,0.000000
Hydrogen Sulphid,GasConc.Hsulphid,GasConc.Hsulphid,GasConc.Hsulphid,0.000000,0.000000,0.000000
Hydrogen,GasConc.Hydrogen,GasConc.Hydrogen,GasConc.Hydrogen,0.000000,0.000000,0.000000
Carbon Monoxide,GasConc.CrbMonOx,GasConc.CrbMonOx,GasConc.CrbMonOx,0.000000,0.000000,0.000000
Oxygen,GasConc.Oxygen,GasConc.Oxygen,GasConc.Oxygen,0.000000,0.000000,0.000000
i Butane,GasConc.iButane,GasConc.iButane,GasConc.iButane,0.1037000,0.09770000,0.3846000
n Butane,GasConc.nButane,GasConc.nButane,GasConc.nButane,0.1563000,0.1007000,0.3506000
i Pentane,GasConc.iPentane,GasConc.iPentane,GasConc.iPentane,0.032100,0.0473000,0.0509000
n Pentane,GasConc.nPentane,GasConc.nPentane,GasConc.nPentane,0.0443000,0.0324000,0.0480000
n Hexane,GasConc.nHexane,GasConc.nHexane,GasConc.nHexane,0.393000,0.0664000,0.0000000

```

Figure 5.10.2.3 Single-line file with Monitor and capture.

## 5.11 WRITABLE DICTIONARY

The writable dictionary holds text that may be used for the batch system or in reports. This dictionary is different from all other dictionaries in that it can be modified from the Batch screen, from a bar-code reader or from a user screen. The values of these texts may optionally be initialised from the `_user.uyl` file described in section 5.5, above. The dictionary holds up to 40 records, each of up to 40 characters in length.

## 5.12 THE RECIPE DICTIONARY

The recipe dictionary holds text that originates from the recipe files (.*uyr*). It may not be initialised from a .*uyl* file. The text held by this dictionary changes whenever .*uyr* files are loaded or modified from the front panel.

The dictionary is divided up into sections, one for each recipe set, each spanning a range of up to 1000 records.

The sections are allocated as follows :-

- 1001-1999, Recipe set number 1
- 2001-2999, Recipe set number 2
- 3001-3999, Recipe set number 3
- 4001-4999, Recipe set number 4

Also the section 1-999 represents the recipe set currently on view and is thus a duplicate of one of the other sections. The following table indicates how the records are allocated in each recipe set. To get the actual record, from recipe set number *n*, simply add 1000\**n*. For example, to get the record of the user who last edited the recipe 3 .*uyr* file, use record number 3014

Record	Value
1	File name (excluding . <i>uyr</i> )
11	Revisions number of . <i>uyr</i> file
14	Name of user who last edited the . <i>uyr</i> file
15	Returns "YES" if the file has been edited but not saved or "NO" if not edited.
111	Name of line number 1
112	Name of recipe selected on line 1
113	Name of recipe active on line 1
114	State of recipe on line 1
121 to 124	As 111 to 114 but for line 2.
131 to 134	As 111 to 114 but for line 3.
141 to 144	As 111 to 114 but for line 4.
151 to 154	As 111 to 114 but for line 5.
161 to 164	As 111 to 114 but for line 6.
171 to 174	As 111 to 114 but for line 7.
181 to 184	As 111 to 114 but for line 8.
301 to 316	Names of recipes 1 to 16 respectively
401 to 480	Names of variable numbers 1 to 80 respectively



## 5.13 THE BATCH DICTIONARY

The batch dictionary holds text that originates from the batch files (*.uyb*) and any corresponding recipe files (*.uyr*). It may not be initialised from a *.uyl* file. The text held by this dictionary changes whenever the *.uyb* and/or *.uyr* files are loaded or modified from the front panel.

The dictionary is divided up into sections, one for each batch controller, each spanning a range of up to 1000 records.

The sections are allocated as follows :-

1001-1999, Batch number 1

2001-2999, Batch number 2

3001-3999, Batch number 3

4001-4999, Batch number 4

Also the section 1-999 represents the batch currently on view and is thus a duplicate of one of the other sections.

The following table indicates how the records are allocated for each batch. To get the record from batch *n*, add  $1000*n$ . For example, to get the record of the user who last edited the batch 3 *.uyb* file, use record number 3014

Record	Value
1	File name (excluding <i>.ubr</i> )
11	Revisions number of <i>.uyb</i> file
14	Name of user who last edited the <i>.uyb</i> file
41	Custom title number 1
42	Custom title number 2
43	Custom title number 3
44	Custom title number 4
45	Custom title number 5
46	Custom title number 6
51	Custom variable number 1
52	Custom variable number 2
53	Custom variable number 3
54	Custom variable number 4
55	Custom variable number 5
56	Custom variable number 6
91	State of the batch
92	Name of recipe selected for batch
93	Name of current phase
101 to 120	Names of phase numbers 1 to 20
301 to 316	Names of recipes 1 to 16
401 to 480	Names of recipe variable numbers 1 to 80

## 5.14 BATCH FILES

For instruments supporting Batch, it is possible to create Batch files (.UYB) on a PC using a text editor or spreadsheet that supports Comma separated variable (CSV) format files. Each .UYB file consists of 2 parts. The first part is a 6-line header, which describes, in a fixed format, the general information contained in the file. The second part consists of a number of phases of the batch.

Notes:

1. No line may exceed 512 characters, including line feed/carriage return instructions.
2. Spaces are counted as characters.
3. Trailing commas will be treated as illegal unless otherwise stated.
4. Commas, double quotes (“”), single quotes (‘’) and equals signs are all illegal in fields.
5. Non-printing characters (excluding <CR> and <LF>) are not permitted anywhere in the file.

### 5.14.1 File Header

The format of the 6-line header is:

Line 1

Line 1 must contain UYB,1 only

Line 2

Line 2 contains comma-separated information about the current revision of the file e.g. 2,22/11/00,09:51:16,Fred Bloggs

Where: ‘2’ is the revision level of the file  
 ‘22/11/00’ is the day/month/year that revision was carried out  
 ‘09:51:16’ is the hours:minutes:seconds that revision was carried out  
 ‘Fred Bloggs’ is the name of the person who last modified the file.

Line 3

Line 3 defines the batch engine interface as  
 <BAT\_CTRL>,<End Action>,<Timeout>,<Confirm level>,<BatchID Prefix>  
 e.g. BATCH1,0,60,2,ABC:R

Where

‘BATCH1’ is the name of the BAT\_CTRL block to run the batch.  
 ‘0’ defines the action on RESET,  
 0 Requires a reload,  
 1 Can be re-started without a reload.  
 ‘60’ defines the timeout (in seconds) for state transitions  
 ‘2’ defines the level of confirmation required when starting from the front panel.  
 0 No confirmation required,  
 1 OK/CANCEL dialogue box,  
 2 Required re-entry of password.

ABC:R is an optional batch id prefix of the form <Prefix>:R,  
 where Prefix overwrites the batch ID, from the left, with the characters of the prefix. For example, a prefix of RKN, would result in batch IDs such as RKN00014.  
 :R, if added, makes the batch ID read only (i.e. it cannot be changed from the front panel.)

### 5.14.1 FILE HEADER (Cont.)

Line 4

Line 4 defines the display interface as

<User Screen>,<Display Group>,<Message Filter>,<User Item1>...<User Item6>

Where:

<User Screen>	is the number of a user screen page associated with the batch or 0 is none.
<Display Group>	is the (optional) name of a GROUP block to be associated with the batch (or blank if none).
<Message Filter>	is the (optional) name of block to be used to give the context for message to be associated with this batch, this may be the name of the BAT_CTRL block itself or a GROUP block containing the BAT_CTRL plus other blocks of interest.
<User Item>	specifies a title and value to be displayed on the BATCH start screen. The value may be edited prior to starting the batch. Each user item is of the form <Title>:<Value>:<Width>=<Initial value>:<Attributes> where
<Title>	is a dictionary reference of the #<Dict><Index> e.g. #U12
<Value>	is either a writeable dictionary value e.g. #W12 or else a LIN dB value e.g. [PID.SL]
<Width>	is the number of characters wide to display the value.
<Initial value>	(optional) is the text value to be used to initialise a writeable dictionary entry value. For example #U13 = user dictionary entry 13. The value may only be another dictionary reference, and must be applied at load.
<Attributes>	(optional). Can have one of the following: W = Value must be written. This implies that data entry must occur after load. If the batch is not unloaded, it may be run without re-writing this value. M = Value must be modified from its initial value (for 'W' dictionary items only) after load. If the batch is not unloaded, it may be run without re-writing this value.

Line 5

Line 5 defines the batch log interface as: <LOGROUP>,<Filename>,<Report>

e.g. BAT\_LOG,[BATCH1.Id],BAT\_REPT

Where:

'BAT_LOG'	is the (optional) name of a LGROUP block for the batch log
'[BATCH1.Id]'	is an (optional) LIN database field whose text value will be used as the name of the file. (The example uses the batch Id as the name of the file).
'BAT_REPT'	is the (optional) name of a DR_REPRT block to be used to generate batch reports. If a batch report is to be generated then 3 reports are required in the .UYF file (1: start, 2: stop, 3: abort). The .UYF must be the same name as the .UYB, e.g. if using SAMPLE.UYB then the corresponding .UYF is SAMPLE.UYF.

Line 6

Line 6 defines the recipe interface e.g.

LINE1

Where 'LINE1' is the name of BAT\_LINE block used to parameterise the batch. If SAMPLE.UYB is used then the corresponding recipe file will be SAMPLE.UYR.

### 5.14.2 Batch Phases

For each phase of the batch a line is required of the form:

<Name>

where: <Name> is the name of the phase.

## 5.15 BAR CODE READER FILES

An application containing a READER block will reference a reader file (.UYD) file. These files allow for the matching of bar codes and performing the corresponding actions required by those bar codes.

### EXAMPLE

```
@r,"h",%{GOTO:1}
@r,"a",_ALM_LVL,%{ACK_ALL,GOTO:9010}
@r,"temp",[PID1.SL]:4W2,"deg"," "
@r,"$09",[Prog.RqNxtPrq]:8W,%{ST:"[Prog.NxtRdy]":=TRUE;"}
```

---

#### Notes:

- 1 The first line will match if the input is "h" (plus any trailing characters). It will cause the panel to jump to the home page (user page with Id 1).
  - 2 The second line will match if the input is "a" (plus any trailing characters) and there are some active or unacknowledged alarms. It will cause acknowledgement of all alarms and jump to the Alarm History page (access level permitting, or overridden).
  - 3 The third line will accept input such as "temp98.4deg" (no trailing characters permitted) and will assign the value 98.4 to PID1.SL, provided the current access level is 2 or higher and not overridden.
  - 4 The fourth line will accept a TAB character followed by e.g. "MyProg99", and will load and run the program via the ProgCtrl function block "Prog".
- 

### 5.15.1 Overview

A .UYD file contains an ordered set of potential patterns to be matched. When a bar code is read each of these is checked in turn (in the order they appear in the file) until a match is found (i.e. if there is the potential to match more than one line in the file the first one will be matched).

Each test line (or pattern) comprises a number of items. These items must be separated by commas.

#### Rules

1. No line is to include more than 255 characters
2. No spaces or tabs may be included between items

### PATTERN DELIMITER

Each line must commence "@r"

## 5.15.2 Literal text

A text item simply causes that piece of text to be matched with the input. The match fails unless every character in the string appears in the input at the correct position. Certain characters may have been deemed to be 'wildcards', in which case they will match any character in the input, but this is specified elsewhere (e.g. in the READER function block).

Constant literal text is represented by a string in double quotes, optionally followed by size and format specifications; the details of these are defined later, but the general syntax is:

```
<double-quoted string> [ ':' <size info> <format> ]
```

Examples:

```
"PV = "
```

```
"ABC123":8C (Uses 8 character positions and centre-justifies)
```

Where a width wider than the specified text is given, as in the second example, padding uses the 'space' character (which may or may not be a wildcard - see above). Non-printable ASCII characters are defined using IEEE1131 'ST' format; in particular, the following are supported:

Representation	Character generated
\$L or \$N	Linefeed or newline (hex 0A)
\$P	Form feed (hex 0C)
\$R	Carriage return (hex 0D)
\$T	Horizontal tab (hex 09)
\$\$	Dollar character: '\$' (hex 24)
\$" or ""	Double quotes character (hex 22)
\$nn	Arbitrary ASCII character in hex, e.g. \$7F is 'DEL'.

If any other character follows '\$', then the '\$' is ignored.

Example: "Cost \$"5\$\$\$\$" would match Cost "5\$"

### EMPTY STRINGS

The empty literal string (""). This matches the end of the input and therefore may be used to reject input that includes trailing characters.

---

*Note: Any suffix/terminating characters specified in the READER block do not count as part of the input, for these purposes.*

---

Example: @r,"temp",[PID1.SL]:4W2,"deg","" will not allow trailing temperature characters.

### 5.15.3 Dictionary text

References to text in dictionaries are made using the format:  
# <dictionary type id.> <entry number>

For example #U12 will match item 12 in the user dictionary.

---

Note: The “W” dictionary is writeable and may be written in a similar manner to LIN database variable. E.G. #W10:8 will write 8 characters into the dictionary entry 10

---

Each dictionary also has the “special” entry number “\*” which is the “current” indexed value. This is used in conjunction with the user actions to modify the entry number written to.

### 5.15.4 LIN database variables

Variables may be used in three different ways.

1. A variable not specified to be writeable, and with a non-zero width, is formatted using the current value of the variable and then matched against the input in exactly the same way as for constant strings (including the possible use of wildcards).
2. A variable specified to be writeable (‘W’ attribute, defined later) will be matched, but only in the limited sense that the required number of characters are present in the input, as specified by the width. If the whole pattern matches then the variable will be assigned a value, just as if the characters had been entered via a touch keypad. No assignment will be carried out if the characters are invalid, e.g. letters for a decimal integer variable. Enumerations (defined later) are not currently supported in this context.
3. A variable specified to have zero width will be deemed to have matched if it is a boolean type and true, or if it is a numeric type (integer, real, enum, subfield16, etc.) and is greater than zero, or if it is a string type and is a non-empty string.

The syntax of variables is:

```
<name> [<enumerations>] [‘:’ <time flags>] [‘:’ <size info> <format>]
```

Enumerations, time flags, size and format information are defined later.

For most data types the nature of the printed text is obvious. For booleans, the digits 0 and 1 are used by default, but typically an enumeration would be supplied to override this.

Variable names refer to objects in a database. Different databases may be available, and the one required is specified by the structure of the name. The name is of the form

```
<FB instance>.<field> [.<subfield>], with the whole string enclosed in square brackets (this is mandatory), e.g. [pid1.sp] or [pid2.SelMode.SelAuto].
```

## 5.15.4 LIN DATABASE VARIABLES (Cont.)

### SYSTEM VARIABLES

The following system variables, identified by a leading underscore, are available :

<code>_ACC_I</code>	Current access level (integer)
<code>_ACC_S</code>	Current access level (string)
<code>_ALM_ACT</code>	Number of active alarms (integer)
<code>_ALM_NAK</code>	Number of unacknowledged alarms (integer)
<code>_ALM_LVL</code>	Overall alarm level, bit encoded: 1 = Active, 2 = Unacknowledged
<code>_ALM_URG</code>	Most urgent unacknowledged alarm (string)
<code>_APP_NAME</code>	Name of currently loaded application, if any (string)
<code>_DATE</code>	Current date, in appropriately internationalised format (string)
<code>_TIME</code>	Current time (string)
<code>_TITLE</code>	Title of currently active page in GUI main pane (string)
<code>_USER_ID</code>	ID of currently logged on user (string)
<code>_USER_NAME</code>	Name of currently logged on user (string)
<code>_USER_REF</code>	Reference number of the user currently logged on (integer)

### ENUMERATIONS

These apply to boolean, integer, and enumerated variables. They may be used for matching, but cannot (currently) be used in connection with data input.

Enumerations take the form of a comma-separated list of literal strings to be displayed, between curly braces, immediately following the variable name.

Examples:

```
[door.In.Bit3]{closed,open}
[counter2.op]{Zero,One,Two,Three,Four}
[i.op]{Lo,Lo,Lo,,,,,Hi,Hi,Hi}
```

For booleans the enumerations always refer to FALSE and TRUE respectively, whereas for integers they correspond to values 0, 1, 2, etc. As with literal text, ST format may be used for non-ASCII characters; this will also be necessary to obtain the characters ‘}’ (using “\$}” or “\$7D”) and ‘,’ (using “\$,” or “\$2C”) as well as ‘\$’ itself (using “\$\$” or “\$24”).

In the case of ‘enum’ type variables, an explicit list may be given, as above; if omitted, then the value will still be displayed as an enumeration, but using strings extracted from the database.

Where the enumeration text is not literal, but is to be obtained from a dictionary, the bracketed list is preceded with the dictionary character, “#”.

For example: `door.In.Bit3#{U22,U23}`

### 5.15.5 Number of characters

A width may be given for text and variables. For example,

```
[i.Count]:6
```

would allocate 6 characters to this variable.

If the width is omitted for variables, it will default to zero unless an enumeration has been specified, in which case the width will default to that of the longest enumeration string.

### 5.15.6 Number of decimal places

For REAL variables, the width may be qualified by the number of decimal places, e.g.

```
[Loop1.PV]:7.3
```

This will condition the way the variable is formatted for matching, but in the case of a writeable variables the input is not constrained to have the decimal point in the correct place.

### 5.15.7 Formatting attributes

These are specified for each individual pattern item, modifying the way it is formatted. Some are applicable only to variables, others to constant text too. Some are specific to the data type. Those which apply generally are:

- C Centre justify
- L Left justify
- R Right justify

Centre justification normally tends to the left when the item width and the spaces available are neither both even nor both odd. Adding 'R' to 'C' changes this to a tendency to the right.

Attributes which apply to any variable are:

- Z Use the character '0' instead of ' ' for left padding

The following apply to REAL variables only:

- S Scientific notation, e.g. 1.23E7

---

Note that this will condition the way the variable is formatted for matching, but in the case of a writeable variable the input is not constrained; the 'E' (or 'e') format will always be acceptable as input regardless of whether 'S' was specified.

---

The following may be applied to integer, boolean, subfield and ENUM variables only:

- X Hex format, using upper case A-F
- x Hex format, using lower case a-f
- Y Binary format

If a hex integer is writeable, then either upper or lower case a-f will be accepted as input, regardless of whether 'x' or 'X' was specified.

---

Note: Binary format is not currently available for writeable variables.

---



## 5.15.8 User actions

A pattern match may also cause the execution of a number of user actions. An action list may be included as :-

%{<action>} for a single action

%{<action1>,<action2>} for 2 or more actions

The list of possible actions are shown in table 5.15.8, below.

Description	Syntax	Example
Acknowledge all alarms	ACK_ALL	
Go to a specified display page	GOTO:<Page>	GOTO:9010
Descend to a specified display (i.e. Go Back works)	DESC:<Page>	DESC:9010
General ST	ST:"<ST>"	ST:"[PID1.SL]:=40.0;"
Set index into a dictionary	DICTIONARY_SET:"<dict>":<entry>	DICTIONARY_SET:"W":1
Increment or decrement a dictionary index	DICTIONARY_ADD:"<dict>":<increment>:<limit>	DICTIONARY_ADD:"W":1:14

Table 5.15.8 Action list

### EXAMPLE

The following examples show how the input string "RESET" will reset the writeable dictionary index to 11. Then each successive item beginning "ITEM:" will write its next 8 characters into the writeable dictionary and increment the index. In this way a list of strings are scanned into dictionary entries 11 to 14.

```
@r,"RESET",%{DICTIONARY_SET:"W":11}
@r,"ITEM:",#W*:8W,%{DICTIONARY_ADD:"W":1:14}
```

This construct may particularly useful in scanning a list of text items into the "W" dictionary, which may then be used as input to a report.

This page is deliberately left blank

## CHAPTER 6 MODBUS

This chapter describes the two implementations of Modbus available on this instrument. The two versions are called Modbus Gateway (6.1), and Modbus DCM (Devolved Control Module) (6.2). See also Chapter 1, Section 1.3 for cabling details.

---

*Note: Modbus Gateway version does not support Modbus Master mode*

---

### 6.1 MODBUS GATEWAY

This section describes the implementation of the Modbus gateway in the Unit controller/supervisor.

The main topics covered are:

- 1 Overview of the Modbus gateway (6.1.1)
- 2 Principles of operation (6.1.2)
- 3 Using the diagnostic table (6.1.3)
- 4 Modbus diagnostic function codes (6.1.4)
- 5 Modbus exception responses (6.1.5)
- 6 Notes on Modbus/JBUS implementation (6.1.6)
- 7 Modbus/JBUS interface performance figures (6.1.7)

#### 6.1.1 Overview of the Modbus gateway

The Modbus/JBUS gateway provides a serial interface to the LIN database. By using the techniques of block caching, the gateway can access data in other nodes distributed on the LIN as well as blocks in the local database. The product operates as a Modbus slave, allowing a PLC or supervisory system configured as a Modbus master to access data in the LIN database.

##### 6.1.1.1 MAIN FEATURES

- 1 The mapping between the database and the Modbus address space is entirely user-configurable for both digitals and registers.
- 2 Digitals may be mapped as single bits, 8 bit bytes or 16 bit words.
- 3 Analogue Values map to single 16 bit registers with definable decimal point (Floating-point numbers as well as Integers.)
- 4 32-bit values (floating point or long integer) may be mapped to a pair of registers.
- 5 Configuration is carried out using the LINtools Modbus configurator running on a PC — see the LINtools Product Manual, Part No. HA082377U999.
- 6 Diagnostic and status registers allow the database to control the Modbus interface.
- 7 The gateway supports the Modbus RTU (8-bit) transmission mode. ASCII (7-bit) mode is not supported.

##### 6.1.1.2 FUNCTIONAL DESCRIPTION

The gateway functions by keeping a copy of relevant parameters in Modbus tables which may be individually configured for either digital or register data. This copy is updated from the LIN database by a scanner task running in the gateway.

The gateway supports 16 separate tables, whose size is configurable. The Modbus data area does not reduce the space available for the continuous database.

The default Modbus interface is implemented as a pair of RJ45 sockets on the rear panel of the unit, as described in chapter 1.

## 6.1.1 OVERVIEW (Cont.)

### 6.1.1.3 MODBUS/JBUS FUNCTION CODES SUPPORTED

Table 6.1.1.3 lists the Modbus function codes supported by the gateway, together with their maximum scan counts, i.e. the maximum number of registers or bits that can be read or written in a single Modbus transmission of this type. For full details on Modbus messages and functions please refer to the Gould Modicon Modbus Protocol Reference Guide.

Code	Function
1	Read digital output status
2	Read digital input status
3	Read output registers
4	Read input registers
5	Write single digital output
6	Write single output register
7	Fast read of single byte (not configurable in master)
8	Diagnostics (not configurable in master) (supports subcodes 0, 1, 2, 3, 4, A, C, D, E, F, 10, 11, 12 — see <a href="#">Table 6.1.4</a> )
15	Write multiple digital outputs
16	Write multiple output registers

Table 6.1.1.3 Modbus function codes supported

**Note:** The gateway makes no distinction between inputs and outputs. Thus any register or bit assigned in the gateway can be accessed as both an input or an output as required. This follows the JBUS implementation of Modbus.

## 6.1.2 Principles of operation

The LIN database groups related data into blocks, such blocks representing an input, an output, a controller etc. The LIN configurators and display packages recognise different types of block, and handle them appropriately. By contrast, the Modbus registers and bits are simply lists of data points. In general there is no predefined structuring of these points into blocks or loops, etc., and most implementations define the allocation of registers differently.

Any gateway involves the mapping of data from the instrument's database to Modbus registers and digitals. The gateway has two main purposes:

1. To allow a Modbus master to read from and to write to fields within standard blocks in the LIN system. The slave is passive and can transfer data, with the master only.
2. To allow the master to translate data into a LIN format.

The mapping between registers and blocks is bidirectional; it is up to the master to manage how it interacts with a particular register or point. Gaps can be left in the Modbus data areas for future expansion and these gaps can be written to and read from if required, allowing a system of 'letterboxes' to be set up that can be exploited by some systems. Data in the gaps does not interact with the standard Visual Supervisor database.

**Note:** If more than one table is used, it is not permissible for a Modbus master to request data, in a single message, that crosses table boundaries. The table size must be extended to cover all data, or the master must be configured not to request data from more than one table in a single request.

Figure 6.1.2 shows a possible mapping of Modbus registers to points in a LIN database. The mapping between the two is configured by the user.

## 6.1.2 PRINCIPLES OF OPERATION (Cont.)

The gateway functions by keeping a copy of the relevant parameters in Modbus format. This copy is updated from the slave's database by a 'scanner' task running in the gateway. This task regularly examines each value in both database and copy. If it finds that a database value has changed since last time, it transfers the new value to the copy ready to be read by the master at the next poll request. If the scanner finds that a value in the copy has been updated by the master, it writes that value to the database. When a master reads a value across the Modbus, the data is transmitted from the copy.

**Note:** To maximise communications efficiency, dynamic data should be grouped so that it is available in contiguous table entries for a multi-parameter read.

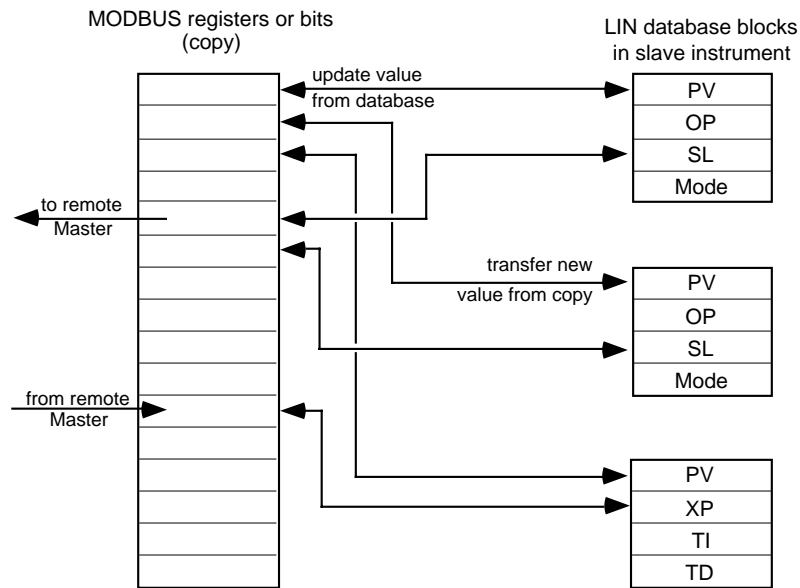

Figure 6.1.2 Slave mode operation

### 6.1.2.1 REFRESH RATES AND TIMING INFORMATION

This section describes the calculations used for determining refresh rates. Refer to [section 6.1.7](#) below for typical figures.

#### Slave mode response time

Defined as the time from the end of the command to the first character of the response.

Minimum	3.5 character periods
Normal	12msec (9600 baud)
Maximum	Probably 50msec (9600 baud)

The cycle time depends on a) the slave response time b) the transit time on the serial link (about 14msec plus 1.15msec per byte at 9600 baud) and c) the execution time of the master.

### 6.1.2.1 REFRESH RATES AND TIMING INFORMATION (Cont.)

Slave mode Scan Period.

The scan period is the time for all the data in the copy areas of all the tables to be updated.

Scan period depends on the number of parameters mapped onto the Modbus address space, and on the number of writes made from the master to blocks that are cached within the slave.

Writing to local blocks does not affect this figure, but the data is updated in only one direction each scan, so that if data is written from the copy to the database, it is not updated from the database to the copy until the following scan.

Data is transferred from the Modbus image to the database only if the value has been changed by the master. The scan period is calculated from the following formula, with a minimum value of 100msec:

$$\text{scan period} = (m \times nt) + (r \times 3.5) + (d \times 3.5) + (w \times 100) \text{ msec}$$

where

- m = minimum period (100msec)
- nt = number of tables
- r = number of registers
- d = number of digitals (or sets of digitals)
- w = number of writes to remote (cached) blocks per scan period.

Example:

For a system with a table of 16 registers and a table with 16 digital descriptors, but no values connected to cached blocks, the scan period is:

$$(100 \times 2) + (16 \times 3.5) + (16 \times 3.5) + (0 \times 100) = 312\text{msec}$$

### 6.1.2.2 MEMORY USE AND REQUIREMENTS

An area of memory is allocated to map the database parameters to the Modbus address space. This memory is allocated to tables, each table representing a series of consecutive registers or bits in the Modbus address space. The table contains an image of the data in the Modbus address space, and a descriptor for each register, bit, or set of bits mapped onto that address space.

Current configuration sizes and limits

Memory for tables	6000 bytes
Maximum number of tables	16
Minimum entries per table	1
Maximum entries per table	Digital bits: 999. Registers: 2000 (limited by memory usage)

Memory requirements for the tables

Overhead	18 bytes per table
Image data — registers	2 bytes per register
Image data — digitals	1 bit per digital (rounded up - see below)
Descriptors — registers	6 bytes/entry (whether connected or not)
Descriptors — digitals	8 bytes/entry (whether connected or not)

Digital image data.

The storage requirement of digital image data is calculated by converting the total number of bits in the table to 8-bit bytes, then rounding this number of bytes up to the nearest 2-byte boundary, i.e. the nearest even number. This means that total bit-counts of from 1 to 16 need 2 bytes of storage space, from 17 to 32 bits need 4 bytes, from 33 to 48 bits need 6 bytes, and so on.

The calculation can be done using the following formula, assuming truncation and integer arithmetic:  
 $2 \times \text{INT}((\text{bitcount} + 15)/16)$  bytes.

Examples.

- 1 A register table with 40 values occupies  $18[\text{overhead}] + (40 \times 2)[\text{data}] + (40 \times 6)[\text{descriptors}] = 338$  bytes.
- 2 The requirements for a digital table depend on how the data is mapped between the Modbus and the database. The examples below show the two extremes for mapping 64 bits to the database. In case a, below, the bits are mapped onto the database in 16-bit units, needing only 4 descriptors. In case b each bit is separately mapped to a different point in the database, needing a total of 64 descriptors.
  - a  $18[\text{overhead}] + 8[\text{data}] + (4 \times 8)[\text{descriptors}] = 58$  bytes.
  - b  $18[\text{overhead}] + 8[\text{data}] + (64 \times 8)[\text{descriptors}] = 538$  bytes.

### 6.1.2.3 DATA CONVERSION

The conversion of data between standard Modbus format and the LIN database format is described here.

#### Data conversion of digitals

Modbus digital signals can be mapped onto database bitfields, booleans and alarms. The following rules apply to mapping these types into the Modbus address space.

1. Bitfields can be mapped individually or as a complete set of 8 or 16 bits onto the Modbus address space.
2. Booleans are mapped onto a single bit in the Modbus address space.
3. Alarms are mapped onto a single bit in the Modbus address space. A value of '1' for this bit corresponds to the 'In alarm' status.

#### Data conversion of registers

All data types can be mapped onto single registers in the Modbus address space. However, special care should be taken when mapping database values that require more than 16 bits — in particular 32 bit integers and floating point numbers.

1. Values requiring up to 16 bits of storage.

Database values that require up to 16 bits of storage (one or two bytes) are mapped directly onto a single register. This includes 8- and 16-bit integers, booleans, alarms and bitfields.

  - a. Long signed 32-bit integers:

When these values are transferred from the database to a Modbus register they are truncated, and only the low order 16 bits are written. When the register is being transferred from the Modbus to the database, the value is sign-extended into the high-order 16 bits.
  - b. Long unsigned 32-bit integers:

When these values are transferred from the database to a single Modbus register they are truncated, and only the low-order 16 bits are written. When the register is being transferred from the Modbus to the database, the high-order 16 bits are assumed to be zero.
  - c. Floating-point numbers:

When these values are transferred from the database to a Modbus register they are scaled according to the decimal point you specify, converted to an integer with rounding, limited to the range -65536 to +65535, and then truncated to 16 bits. This allows applications to work either with signed numbers (-32768 to +32767) or with unsigned numbers (0 to +65535).

When the register is being transferred from the Modbus to the database, it is treated as a signed number in the range -32768 to +32767, scaled according to the decimal point specified and then written to the database.
2. Values requiring up to 32 bits of storage.

32-bit fields representing values where precision must be preserved may be connected to a pair of Modbus registers. The two parts are stored in standard PC format in two consecutive registers, of which the first must be at an even address. This method of linking is enabled by entering D (double precision) in the DP field of the first register. The scanner task ensures data coherency.

  - a. 32-bit totals:

Two-register mapping of long integers is used for the Total and Target fields of the TOTAL and TOT\_CONN blocks.



### 6.1.3 Using the diagnostic table

The diagnostic table is a special set of 32 registers containing status and control bits to allow the database to interact with the Modbus drivers. A diagnostic table allows the user to control the Modbus operation, or present diagnostic information to the database. Generally only one diagnostic table needs to be configured per Modbus configuration.

The registers of a diagnostic table are in two distinct sets. The first sixteen — the internal diagnostic registers — at default addresses 0 to 15. The last sixteen — the Modbus table status and control registers — are at addresses 16 to 31. These two sets of registers are described below.

#### 6.1.3.1 INTERNAL DIAGNOSTIC REGISTERS

The first set of registers (with default addresses 0 to 15) are for internal diagnostic use, and are read-only to the user. They present general information on the operation of the Modbus, and their functions are independent of whether the instrument is operating as a master or a slave. Table 6.1.3.1 lists these registers and their functions.

Offset	Function
0	(Unused)
1	(Unused)
2	Diagnostic register, bits currently allocated: Bit 5 — Slave in listen-only mode
3	Query data as transmitted by function code 8 sub code 0
4	Input delimiter as transmitted by function code 8 sub code 3
5	(Unused)
6	(Unused)
7	Count of error messages sent by slave
8	(Unused)
9	(Unused)
10	(Unused)
11	Master polling task: cycle period in 4 msec ticks
12	Scanner task: time to check all tables in 4 msec ticks
13	Scanner task: time used last time scheduled in 4 msec ticks
14	Scanner task: time used for last delay in 4 msec ticks.
15	(Unused)

Table 6.1.3.1 Internal diagnostic registers 0 to 15

#### 6.1.3.2 MODBUS TABLE STATUS AND CONTROL REGISTERS

The second set of registers (with default addresses 16 to 31) allows individual tables in the configuration to be monitored and controlled. Each register in the diagnostic table is automatically allocated to an entire table in the configuration. Specifically, the diagnostic register at default address 16 is assigned to table 1, the register at address 17 is assigned to table 2, and so on up to table 16.

### 6.1.3 USING THE DIAGNOSTIC TABLE (Cont.)

#### 6.1.3.3 SLAVE MODE DIAGNOSTIC TABLE REGISTERS

The slave mode diagnostic register includes bits that allow monitoring and control of the associated Modbus table by an application running in the database. Figure 6.2 shows the allocation of the bits in the register. The values in the register are used in the following way:

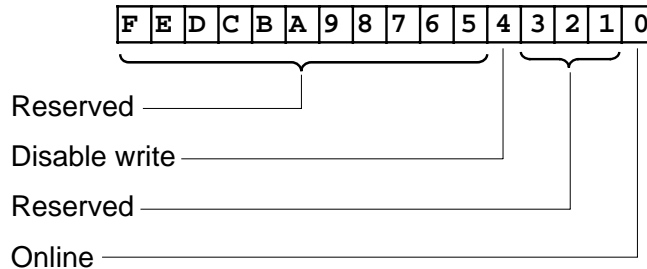

Figure 6.1.3.3 Diagnostic registers

#### Disable write

Setting this bit disables writes across the Modbus serial link to the associated table. The slave will return error code 8 (see Table 6- 4, Exception responses).

#### Online

This bit is set to 1 if the table has been written to or read from in the period defined in Time out in the SETUP menu.

### 6.1.4 Diagnostic function codes

Table 6.1.4 summarises how the common Modbus diagnostic function codes have been supported by the gateway in slave mode. The diagnostics are accessed via Modbus function code 8.

Diagnostic sub-code	Data sent	Description
0000	xxxx	Echoes the data sent
0001	0000	Restarts
	FF00	Resets the diagnostic counters, and re-enables responses if the slave had been placed in Listen-only mode by sub-code 4.
0002	xxxx	Returns the diagnostic register. (In the current versions, the returned data is always zero.)
0003	ABxx	Changes ASCII delimiter. (This echoes the data sent.)
0004	0000	Forces Listen-only mode. There is NO response to this function.
000A	0000	Resets all counters.
000B		(Not supported)
000C	0000	Returns the number of CRC errors detected in messages addressed to this slave.
000D	0000	Returns the number of error messages returned by this slave.
000E	0000	Returns the number of correct messages addressed to this slave.
000F	0000	Returns a count of the number of times the slave has not responded to a valid message (e.g. due to an unsupported function, or a buffering problem in the slave).
0010	0000	Always returns 0.
0011	0000	Always returns 0.
0012	0000	Returns the count of character errors received at the slave, i.e. (overrun + parity + framing) errors.
0013		(Not supported)
0014		(Not supported)

Table 6.1.4 Modbus diagnostic function codes

## 6.1.5 Modbus exception responses

### 6.1.5.1 SLAVE MODE ERROR CODES

Table 6.1.5.1 lists the error codes that may be returned in an exception response from a gateway in slave mode.

Code	Name	Meaning (current implementation)
01*	Illegal function	The function is illegal, or not supported within the Modbus gateway.
02*	Illegal data address	The address referenced does not exist in the slave device.
03*	Illegal data value	The value in the data field is invalid.
04	Failure in associated device	
05	Acknowledge	
06	Busy, rejected message	
07	NAK-negative acknowledgement	
08*†	Write error	The data has been write-protected via a bit in the appropriate table diagnostic register.
09 †	Zone overlap	<p>* Codes implemented in the controller/supervisor slave mode.</p> <p>† Supplementary codes defined by the JBUS specification.</p>
0A †	Header error	
0B †	Slave absent	
0C †	CRC error	
0D †	Transmission blocked	

Table 6.1.5.1 Exception responses from a slave

## 6.1.6 Notes on Modbus/JBUS implementation

Although based on the original Modbus specification, different manufacturers' implementations vary slightly in the correspondence between the actual register or bit addresses in a PLC, for example, and the Modbus/JBUS address, i.e. the 'protocol address'. It is this protocol address that is to be configured in the Modbus gateway implementation.

### 6.1.6.1 MODBUS (AEG-MODICON)

Read-only ('input') and read/write ('output') registers and bits are assigned to separate tables, each with its own address-offset relative to the Modbus protocol address. Table 6.1.6.1 summarises this.

Data type	Modbus function codes		PLC address	Protocol address
	Read	Write		
Output bits	01	05, 15	00001+X	X
Input bits	02	—	10001+X	X
Output registers	03	06, 16	40001+X	X
Input registers	04	—	30001+X	X

Table 6.1.6.1 PLC address offsets for different data types

It is the Modbus function code that determines the value of the offset required, and therefore whether a given Modbus protocol address is directed at an input or output, in a bit or register table.

### 6.1.6.2 JBUS

In the JBUS implementation there is a direct correspondence between a register or bit address and the Modbus protocol address, and no distinction is made between input and output (or indeed internal) PLC registers. Thus Modbus function codes 01 and 02 are treated identically, as are codes 03 and 04. All PLC data thus conforms to a single address range.

### 6.1.6.3 OTHER PRODUCTS

Other manufacturers' 'gateway' implementations conform to the MODICON principle of separate tables for different types of data exchange, but the correspondence between PLC base address and Modbus protocol address is user-configurable.

## 6.1.7 MODBUS/JBUS Interface performance figures

### 6.1.7.1 UPDATE PERIOD

In general the update period between the database in a master device and the database in a slave device, for continuously polled values, is the sum of the following times:

1. Scanning period between MODBUS table and database in the master
2. Cycle time of serial link communications
3. Scanning period between MODBUS table and database in the slave

### 6.1.7.2 SERIAL LINK CYCLE TIME

The cycle time of the serial link communications is itself the sum of the following:

1. Response time at master
2. Transit time (request + response) over serial link
3. Response time at slave

### 6.1.7.3 SCANNING PERIOD AND RESPONSE TIME

For the Unit controller/supervisor the scanning period and response time depend on the number of 16-bit words to be scanned and may be expressed approximately, for both master and slave versions, as:

$$\text{Scanning period (msec)} = 200 + 3.5(r + d)$$

$$\text{Response time (msec)} = 10 + 0.08n$$

where

r = number of register table entries

d = number of digital table entries (1-bit, 8-bit, or 16-bit)

n = number of 16-bit words (registers and bits expressed in multiples of 16)

### 6.1.7.4 TRANSIT TIME ON SERIAL LINK

The Transit time over the serial link depends on the baud rate and the volume of information. At 9600 baud (no parity, 2 stop bits) this may be calculated as follows:

$$\text{Transit time (msec)} = 14 + 2.3n$$

## 6.2 MODBUS DCM

### 6.2.1 Introduction

A Devolved Control Module (DCM) is configured for each item to be accessed via the Modbus link. In addition, an Instrument Block is available for each model of I/O unit produced by the Visual Supervisor manufacturer. This contains various instrument and Modbus parameters along with instrument and I/O failure and status indications.

When all blocks have been configured correctly, and are resident in the data base along with the system.opt file and any relevant Universal Map for Modbus (.uym) files\*, then the Visual Supervisor will start communicating with the I/O unit as soon as it is initialised, without the need to set up mapping tables as is required by the Gateway version.

For 'third party' instruments, a .uym\* file must be created for each DCM.

\*See section 6.2.3 for .uym file description

The DCMs themselves are fully described in Chapter 15 of the LIN Blocks Reference Manual (HA082375U003), but brief details of what is available is given in the list below.

### 6.2.2 DCMs available

The modules available at time of print are:

#### 6.2.2.1 LOOP BLOCKS:

D2X\_LOOP Access PID Control loop in a Series 2000 I/O unit.  
D2X\_TUNE Tune PID Loop in a Series 2000 I/O unit.  
D25\_LOOP Access PID Control loop in a 2500 I/O unit.  
D25\_TUNE Tune PID Loop in a 2500 I/O unit.  
D25e\_LOOP Access PID Control loop in a 2500 I/O unit with 8 PID loops.  
D25e\_TUNE Tune PID Loop in a 2500 I/O unit with 8 PID loops.

#### 6.2.2.2 RAMP BLOCKS

D25\_RAMP Ramp remote setpoint in a 2500 I/O unit.  
D25e\_RAMP Ramp remote setpoint in a 2500 I/O unit with 8 PID loops.

#### 6.2.2.3 I/O MODULE BLOCKS

D25\_MOD Access single I/O Module  
D25\_AI2 Access two-channel analogue input module  
D25\_AI3 Access three-channel analogue input module  
D25\_AO2 Access two-channel analogue output module  
D25\_AO4 Access four-channel analogue output module  
D25\_DI4 Access four-channel digital input module  
D25\_DI8 Access eight-channel digital input module  
D25\_DO4 Access four-channel digital output module

## 6.2.2 DCMs AVAILABLE (Cont.)

### 6.2.2.4 I/O CHANNEL BLOCKS

D25_AI	Access single analogue input channel
D25_AICH	Access single analogue input channel
D25_AO	Access single analogue output channel
D25_AOCH	Access single analogue output channel
D25_DI	Access single digital input channel
D25_DICH	Access single digital input channel
D25_DO	Access single digital output channel
D25_DOCH	Access single digital output channel

### 6.2.2.5 USER WIRING BLOCKS

D25_R_CV	Access up to 8 user wiring calculated values (real) in the I/O unit.
D25_B_CV	Access up to 8 user wiring calculated values (boolean) in the I/O unit.
D25_R_UV	Access the 8 user values (real) in the I/O unit.

### 6.2.2.6 USER ALARM BLOCKS

D25_UALM	Access the alarms in the I/O unit.
----------	------------------------------------

### 6.2.2.7 PARAMETER BLOCKS

DCM_I8	Access up to 8 signed integer (16-bit) parameters in the I/O unit.
DCM_UI8	Access up to 8 unsigned integer (16-bit) parameters in the I/O unit.
DCM_R8	Access up to 8 signed real number (32-bit) parameters in the I/O unit.
DCM_W8	Access up to 8 ABCD hex word (16-bit) parameters in the I/O unit.
DCM_B8	Access up to 8 Boolean parameters in the I/O unit.
DCM_D8	Access up to 8 double precision integer (32-bit) parameters in the I/O unit.
DCM_S8	Access up to 8 signed short integer (8-bit) parameters in the I/O unit.
DCM_T8	Access up to 8 time duration parameters in the I/O unit.
DCM_US8	Access up to 8 unsigned short integer (8-bit) parameters in the I/O unit.
DCM_Y8	Access up to 8 AB hex byte (8-bit) parameters in the I/O unit.

### 6.2.2.8 INSTRUMENT/DIAGNOSTIC BLOCKS

D2000	Provides overall view of the I/O unit comms parameters/status indication etc.
D2500	Provides overall view of the I/O unit comms parameters/status indication etc.

### 6.2.3 The .UYM File

A .uym file is required for every DCM which is to communicate with a MODBUS slave device, in order that the Visual Supervisor may know the address at which a particular point (channel value, alarm threshold value etc.) is to be found. This information has been obtained from the slave device documentation.

**\*Notes:**

- 1 An unlimited number of blocks may use the same .uym file, provided only that their register usage (i.e. the range of addresses) in the target instrument is identical.
- 2 .UYM files can also be used to override information in standard DCMs.

The .uym file (fully described in chapter 15 of the LIN Blocks Reference Manual HA083375U003), is a text file, created on a text editor and loaded into the database. The format is as follows:

Field,Register,Type,Function codes

Where:

Underlined items do not need to be included if the defaults are acceptable

**Field** is the name of the LIN database block being mapped

**Register** is the required Modbus register of the point being accessed. This can be a simple decimal number or it can be of the form: `Constant1[Constant2*(Field name±Constant3)]`

Where

Constants 1,2 and 3 are a simple decimal numbers,

Field name is any field name in the block which has a 16-bit integer value. A sample expression might be: `200 + 10[(Slot_No +Chan_No)-1]`

In which Constants 1, 2 and 3 are 200, 10 and 1 respectively, and the field name is 'Slot\_No + Chan\_No'.

**Type** is number type. This field needs to be entered only if the default (Unsigned Integer (UINT)) is not the correct type. See table 6.6, below, for number type entries.

**Function codes**

Modbus function codes. This field needs to be entered only if the default (3, 4 – read registers) is not acceptable. See table 6.1 above for a list of Function codes supported by the Visual Supervisor. Setting the value to zero disables the field – i.e. it will not communicate. This feature is provided to allow the disabling of communication for individual fields in standard DCM blocks.

Number type entry	Number type definition
BOOL	Value of 0 or 1 in the LSB
DINT	Signed 32-bit register
DINT_X*	Signed 32-bit register (reverse word order)
INT	Signed 16-bit integer
SINT	Signed 8-bit integer
REAL	32-bit IEEE floating point value in two registers
REAL_X*	32-bit IEEE floating point value in two registers (reverse word order)
SREAL_p1	16-bit signed number in units of 0.1
SREAL_p2	16-bit signed number in units of 0.01
SREAL_p3	16-bit signed number in units of 0.001
SREAL_p4	16-bit signed number in units of 0.0001
STIME_ds	16-bit duration in decisecond (0.1second) units
STIME_dm	16-bit duration in deciminute (0.1 min) units
STIME_dh	16-bit duration in deci hour (0.1 hour) units
SUREAL_p1	16-bit unsigned number in units of 0.1
SUREAL_p2	16-bit unsigned number in units of 0.01
SUREAL_p3	16-bit unsigned number in units of 0.001
SUREAL_p4	16-bit unsigned number in units of 0.0001
UDINT	Unsigned 32-bit integer
UDINT_X*	Unsigned 32-bit integer (reverse word order)
UINT	Unsigned 16-bit integer
USINT	Unsigned 8-bit integer
* _X versions must be used when communicating with LIN instruments	

Table 6.2.3 Number types supported by the Visual Supervisor

## 6.2.3 THE .UYM FILE (Cont.)

### 6.2.3.1 EXAMPLE

To read an analogue input value from channel 17 of a chart recorder.

For a particular chart recorder, the Communications parameters, have been set up in the Configuration:Comms menus, as follows (to match the Visual Supervisor settings):

Protocol:           MODBUS  
 Baud Rate:        9600  
 Parity:            Even  
 Data bits:         8 (fixed for MODBUS protocol)  
 Stop bits:         1  
 H/W handshake:   Off  
 Address:           4

From the recorder documentation the analogue input channels are accessed using code 03 and are addressed contiguously, starting with channel 1 at decimal address 0. Thus to read its input value, code 03 and address 16 are required. Thus the .UYM file should contain the following:    MV , 16 , UINT , " 03 "

### 6.2.3.2 SCALING

The recorder documentation also states that the value (PV) is returned as a 16-bit hex number in the range 0000 (Channel Low range value) to FFFF (Channel High range value), and the calculation:

$$\text{Scaled value} = \left( (\text{High range} - \text{low range}) \times \frac{PV}{FFFF} \right) + \text{low range}$$

has to be carried out to find the actual scaled value. The recorder Channel Configuration must be accessed to determine the High and Low range values.

#### Example

High range = 90% for 4V input signal  
 Low range = 10% for 1V input signal  
 Current PV = 2.5V (7FFF)  
 The scaled value is  $\{(90 - 10)\% \times 7FFF/FFFF\} + 10\% = 50\%$

### 6.2.3.3 COMMENTING

A comment can be attached to the end of any line, in the form

, , "Comment"

The maximum number of characters for the .UYM file is 60 characters, including delimiters. The comment text string can contain a maximum of (60 minus rest of line) characters.

Thus the sample .UYM file could become:

MV,16,UINT,"03" , , "Recorder 4, channel 17"



## CHAPTER 7 PROFIBUS

### 7.1 INTRODUCTION

PROFIBUS DP is an industry standard open network used to interconnect instrumentation and control devices in, for example, a manufacturing or processing plant. It is often used to allow a central Programmable Logic Controller (PLC) or PC based control system to use external 'slave' devices for input/output (I/O) or specialised functions, thus reducing the processing load on the controlling unit so that its other functions can be carried out more efficiently using less memory.

This implementation of the PROFIBUS network uses a high speed version of the EIA485 standard to permit transmission rates of up to 12 MBaud between the host and up to 16 PROFIBUS 'Stations' otherwise called 'nodes' either within a single section of network or, with EIA485 repeaters (each counted as a node) in several separate sections of network. Acceptable node addresses are 1 to 125.\*

It is not within the scope of this document to describe the PROFIBUS standard in detail; more detailed information can be found by reference to the profibus web site:

<http://www.profibus.com>.

### 7.2 DEVOLVED CONTROL MODULES

#### 7.2.1 Introduction

A Devolved Control Module (DCM) is configured for each item to be accessed via the link. In addition, an Instrument Block is available for each model of I/O unit produced by the Visual supervisor manufacturer. This contains various instrument and Profibus parameters along with instrument and I/O failure and status indications.

When all blocks have been configured correctly, and are resident in the data base along with any relevant Universal Map for Profibus (.uyf) files<sup>†</sup>, then the Visual Supervisor will start communicating with the I/O unit as soon as it is initialised.

For 'third party' instruments, a .uyf<sup>†</sup> file must be created for each DCM.

The DCMs themselves are fully described in Chapter 15 of the LIN Blocks Reference Manual (HA082375U003), but brief details of what is available is given in the list below.

---

**Notes:**

\* For this issue of software, nodes must be either all Model 2500 modules, produced by the Visual Supervisor manufacturer, or all 'third party' items.

<sup>†</sup> See [section 7.3](#) for .uyf file description

---

## 7.2.2 DCMs available

The modules available at time of print are:

### 7.2.2.1 LOOP BLOCKS

- D2X\_LOOP Access PID Control loop in a Series 2000 I/O unit.
- D2X\_TUNE Tune PID Loop in a Series 2000 I/O unit.
- D25\_LOOP Access PID Control loop in a 2500 I/O unit.
- D25\_TUNE Tune PID Loop in a 2500 I/O unit.
- D25e\_LOOP Access PID Control loop in a 2500 I/O unit with 8 PID loops.
- D25e\_TUNE Tune PID Loop in a 2500 I/O unit with 8 PID loops.

### 7.2.2.2 RAMP BLOCKS

- D25\_RAMP Ramp remote setpoint in a 2500 I/O unit.
- D25e\_RAMP Ramp remote setpoint in a 2500 I/O unit with 8 PID loops.

### 7.2.2.3 I/O MODULE BLOCKS

- D25\_MOD Access single I/O Module
- D25\_AI2 Access two-channel analogue input module
- D25\_AI3 Access three-channel analogue input module
- D25\_AO2 Access two-channel analogue output module
- D25\_AO4 Access four-channel analogue output module
- D25\_DI4 Access four-channel digital input module
- D25\_DI8 Access eight-channel digital input module
- D25\_DO4 Access four-channel digital output module

### 7.2.2.4 I/O CHANNEL BLOCKS\*

- D25\_AI Access single analogue input channel
- D25\_AICH Access single analogue input channel
- D25\_AO Access single analogue output channel
- D25\_AOCH Access single analogue output channel
- D25\_DI Access single digital input channel
- D25\_DICH Access single digital input channel
- D25\_DO Access single digital output channel
- D25\_DOCH Access single digital output channel

### 7.2.2.5 USER WIRING BLOCKS

- D25\_R\_CV Access up to 8 user wiring calculated values (real) in the I/O unit.
- D25\_B\_CV Access up to 8 user wiring calculated values (boolean) in the I/O unit.
- D25\_R\_UV Access the 8 user values (real) in the I/O unit.

### 7.2.2.6 USER ALARM BLOCKS

- D25\_UALM Access the alarms in the I/O unit.

### 7.2.2.7 PARAMETER BLOCKS

DCM_I8	Access up to 8 signed integer (16-bit) parameters in the I/O unit.
DCM_UI8	Access up to 8 unsigned integer (16-bit) parameters in the I/O unit.
DCM_R8	Access up to 8 signed real number (32-bit) parameters in the I/O unit.
DCM_W8	Access up to 8 ABCD hex word (16-bit) parameters in the I/O unit.
DCM_B8	Access up to 8 Boolean parameters in the I/O unit.
DCM_D8	Access up to 8 double precision integer (32-bit) parameters in the I/O unit.
DCM_S8	Access up to 8 signed short integer (8-bit) parameters in the I/O unit.
DCM_T8	Access up to 8 time duration parameters in the I/O unit.
DCM_US8	Access up to 8 unsigned short integer (8-bit) parameters in the I/O unit.
DCM_Y8	Access up to 8 AB hex byte (8-bit) parameters in the I/O unit.

### 7.2.2.8 INSTRUMENT/DIAGNOSTIC BLOCKS

D2000	Provides overall view of the I/O unit comms parameters/status indication etc.
D2500	Provides overall view of the I/O unit comms parameters/status indication etc.

---

\*Notes

- 1 Refer to the Lin blocks reference manual for details of the difference between 'CH' and non 'CH' versions.
  - 2 In each 16-way I/O base, a maximum of 12 eight-way digital input modules (DI8s) may be fitted.
- 

## 7.3 THE .UYP FILE

A .uyp file is required for every<sup>†</sup> DCM (7.2, above) in order that the Visual Supervisor may know the address at which a particular point (channel value, alarm threshold value etc.) is to be found. For third party equipment, this information has to be obtained from the third party documentation.

---

† Note:

An unlimited number of blocks may use the same .uyp file, provided only that their register usage (i.e. the range of addresses) in the target instrument is identical.

---

The .uyp file, is a text file, created on a text editor and loaded into the database. The format is as follows:

*Field, Address, Type, "Operations"*

Where:

Field	Underlined items do not need to be included if the defaults are acceptable is the name of the LIN database block being mapped, and
Address	is the required register of the point being accessed. This entry can be a simple decimal number or it can be of the form: <i>Constant1[Constant2*(Field name±Constant3)]</i> Where Constants 1,2 and 3 are a simple decimal numbers, Field name is any field name in the block which has a 16-bit integer value. A sample expression might be: <i>200 + 10[(Slot_No + Chan_No) - 1]</i> In which Constants 1, 2 and 3 are 200, 10 and 1 respectively, and the field name is 'Slot_No + Chan_No'.
Type	is number type. This field needs to be entered only if the default (Unsigned Integer (UINT)) is not the correct type. See table 7.3 for number type entries.
Operations	One or more of: RC, WC, RA, WA, where R = read, W = write, C = cyclic, A = acyclic Default = RC (read cyclic) If VOID is specified, this field is disabled – i.e. it will not communicate. This feature is provided to allow the disabling of communication for individual fields in standard DCM blocks

**7.3 THE .uyp FILE (Cont.)**

Number type entry	Number type definition
BOOL	Value of 0 or 1 in the LSB
DINT	Signed 32-bit register
DINT_X*	Signed 32-bit register (reverse word order)
INT	Signed 16-bit integer
SINT	Signed 8-bit integer
REAL	32-bit IEEE floating point value in two registers
REAL_X*	32-bit IEEE floating point value in two registers (reverse word order)
SREAL_p1	16-bit signed number in units of 0.1
SREAL_p2	16-bit signed number in units of 0.01
SREAL_p3	16-bit signed number in units of 0.001
SREAL_p4	16-bit signed number in units of 0.0001
STIME_ds	16-bit duration in decisecond (0.1second) units
STIME_dm	16-bit duration in deciminute (0.1 min) units
STIME_dh	16-bit duration in deci hour (0.1 hour) units
SUREAL_p1	16-bit unsigned number in units of 0.1
SUREAL_p2	16-bit unsigned number in units of 0.01
SUREAL_p3	16-bit unsigned number in units of 0.001
SUREAL_p4	16-bit unsigned number in units of 0.0001
UDINT	Unsigned 32-bit integer
UDINT_X*	Unsigned 32-bit integer (reverse word order)
UINT	Unsigned 16-bit integer
USINT	Unsigned 8-bit integer

\* \_X versions must be used when communicating with LIN instruments

Table 7.3 Number types supported by the Visual supervisor

**7.3.1 COMMENTING**

A comment can be attached to the end of one or more lines in the form:

, , “Comment”

The maximum number of characters for the .UYP line is 60 characters, including delimiters. The comment text string can contain a maximum of (60 minus rest of line) characters.

Thus a sample .UYP file might be:

*MV,16,UINT,"RC,WC",,,"Recorder 4, channel 17"*

## 7.4 INSTALLATION

### 7.4.1 Wiring

The cable details given on this page refer to standard 150W Profibus cable. For Category 5 users, a document entitled 'Installation Guidelines for Profibus networks' is available from the manufacturer under part number HA261788.

The Profibus link is terminated at the connection module, using an RJ45 connector as described in section 1.3.1 of this manual.

#### 7.4.1.1 EARTHING THE SHIELD

The PROFIBUS standard suggests that both ends of the transmission line be connected to safety earth. If such a course is followed, care must be taken to ensure that differences in local earth potential do not allow circulating currents to flow, as these can not only induce large common mode signals in the data lines, resulting in communications failure, but can also produce potentially dangerous heating in the cable. Where doubt exists, it is recommended that the shield be earthed at only one point in each section of the network.

#### 7.4.1.2 NETWORK WIRING

There are two distinct ways of wiring a network, known as 'Linear topology' and 'Tree topology'. In a linear network (figure 7.4.1.2a), the maximum number of repeaters is three, giving a total number of stations of 122. In theory the tree set-up (figure 7.4.1.2b) can have more stations, but the PROFIBUS protocol limits the number of stations (including repeaters) to 127 (addresses 0 to 126). It is up to the user to determine which is the most cost effective way of organising the layout.

#### 7.4.1.3 CABLE TYPE

Table 7.4.1.3 below gives the specification for a suitable cable such as Belden B3079A.

Impedance .....	135 to 165 ohms at 3 to 20 MHz
Resistance .....	<110 Ohms/km
Cable capacitance .....	<30 pF/metre
Core diameter .....	0.34mm <sup>2</sup> max. (22 awg)
Cable type .....	Twisted pair, 1x1, 2x2 or 4x1 lines
Signal attenuation .....	9dB max. over total length of line section
Shielding .....	Cu shielding braid, or shielding braid and shielding foil

Table 7.4.1.3 Cable specification

#### 7.4.1.4 MAXIMUM BAUD RATE

The maximum transmission speed depends on the length of the cable run including 'stub' (distance from the bus to a station) lengths. Guaranteed minimum values are given below.

Line length/segment (metres)	100	200	400	1000	1200
Max Baud rate (kbit/sec) (kB)	12,000	1,500	500	187.5	93.75

Table 7.4.1.4 Maximum Baud rate versus line length

7.4.1 WIRING (Cont.)

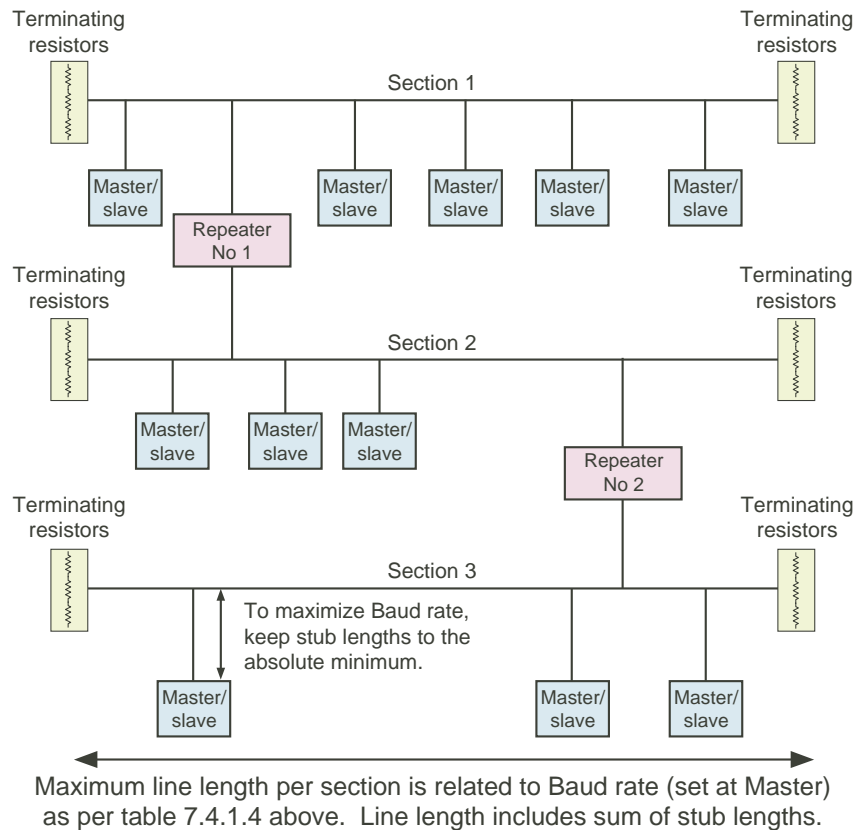

Typical **linear** bus layout, with two repeaters allowing up to 14 slaves to be fitted. A maximum of three repeaters is allowed, allowing up to 13 slaves to be fitted.

Figure 7.4.1.2a Typical linear bus layout

7.4.1 WIRING (Cont.)

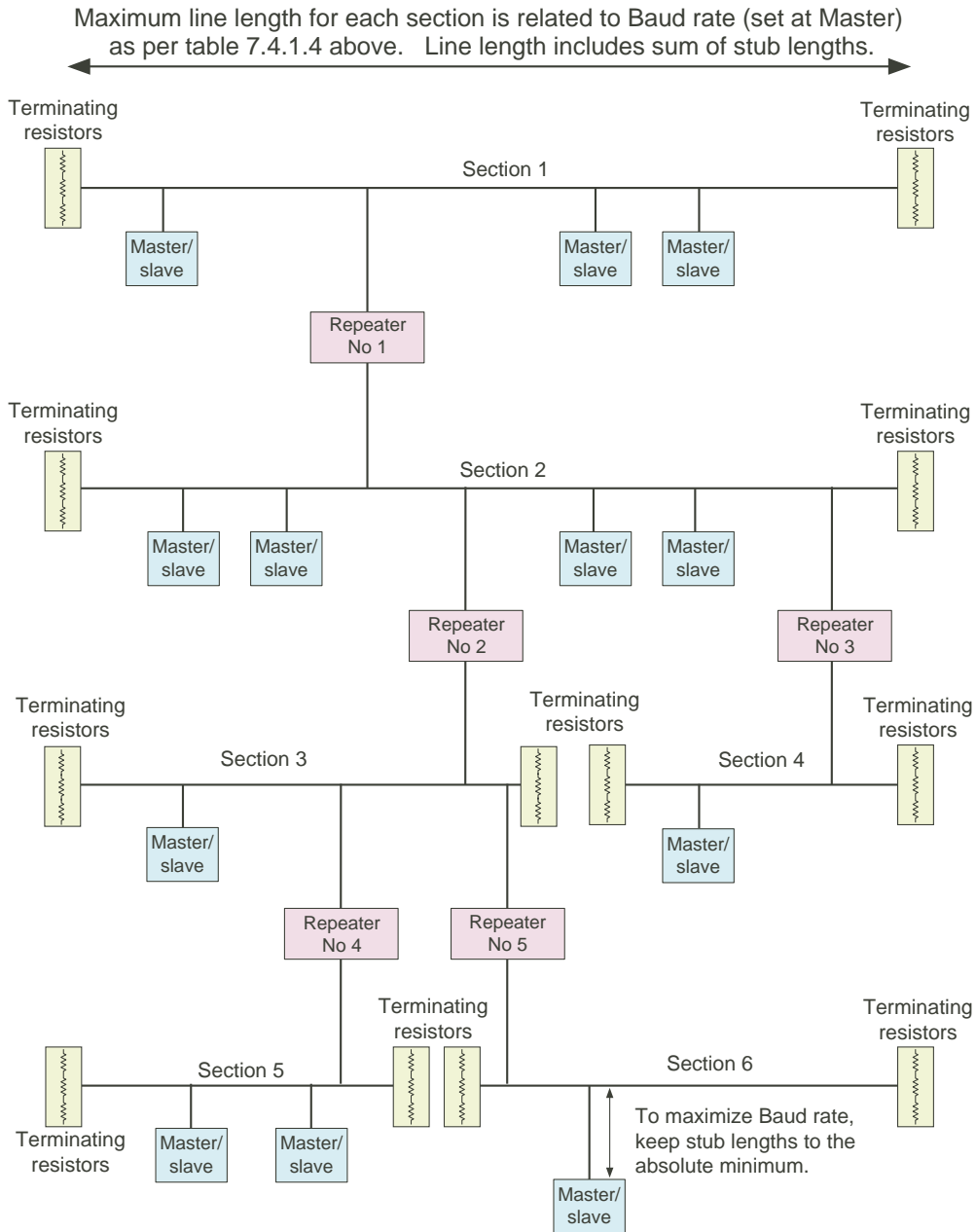

Typical **tree** bus layout, with five repeaters allowing a maximum of 11 slaves to be fitted.

Figure 7.4.1.2b Typical tree bus layout

## 7.4.2 Adding the unit to the network

Once the unit has been physically connected, UYP files and any .gsd files for third party equipment can be transferred, and the database started.

## 7.5 TROUBLESHOOTING

---

### WARNING

Fault finding may affect the network and control system. Ensure that no damage to personnel or equipment can be caused by any fault finding activity.

---

### 7.5.1 No communications

1. Check the wiring
2. Ensure that the node address is unique and within the range 1 to 125 inclusive.
3. Ensure that the network has been correctly configured and that the configuration has been correctly transferred to the master.
4. Verify that the GSD and .uyp files being used are correct.
5. Ensure that the maximum line length of transmission line has not been exceeded for the Baud rate in use (Table 7.3 above).
6. Ensure that the final node on the transmission line (no matter what type of instrument it is) is terminated correctly using a terminator unit. Note that some equipment has built-in pull up and pull down resistors which in some cases can be switched in and out of circuit. Such resistors must be removed or switched out of circuit for all but the instruments at each end of the line.
7. Replace any faulty item(s) and re-test.

### 7.5.2 Intermittent failure to communicate

This fault is shown by the diagnostic status changing, without alarms being generated in the instrument. The following section details diagnostics information.

1. Check wiring as for 'No Communications' above. Pay particular attention to the integrity of the screening and termination
2. Check the number of words in the data exchange against the maximum number the master can support.
3. Ensure that the maximum line length of transmission line has not been exceeded for the Baud rate in use (Table 7.3 above).
4. Ensure that the final node on the transmission line (no matter what type of instrument it is) is terminated correctly, and that only the first and final nodes are so terminated. Note that some equipment has built-in pull up and pull down resistors which in some cases can be switched in and out of circuit. Such resistors must be removed or switched out of circuit for all but the instruments at each end of the line.
5. Replace any faulty item(s) and re-test.

### 7.5.3 Data format or parameter seems incorrect

Verify that the GSD file is correct for the given application by loading it into a GSD file configurator program.



## 7.5.4 Communication seems slow

The normal cyclic exchange of data should be very fast. Should so much data be requiring transfer that it cannot be fitted into the cycle rate, then it will be sent acyclically, and this results in a much slower transfer rate of all data.

To maximise efficiency, module DCMs should be used wherever possible instead of individual channel DCMs. Module DCMs provide a process variable's value and alarm status only. Refer to the Lin Blocks reference manual for further details.

The diagnostic block `pmc_diag` provides information showing any communications 'overflow'.

## 7.6 GLOBAL COMMANDS

Freeze and Sync from a PROFIBUS master have no effect

## 7.7 OPERATION

PROFIBUS DP performs a cyclical scan of the network devices, during which input and output data for each node is exchanged.

Values from each node (input data) are read by the Profibus master, which then runs its control program, and generates a set of values (output data) to be transmitted to the nodes. This process is called an 'I/O data exchange'. This process is repeated continuously, to give a cyclical I/O data exchange.

Examples of input data are

- a. A set of digital readings for a digital input
- b. The measured temperature and alarm status from a PID controller.

Examples of output data are:

- a. A setpoint to be sent to a PID controller

The I/O data exchange can be repeated continuously, synchronised at given times, or repeated at a pre-defined interval, which is asynchronous with the controller. Each node is normally assigned a group of PLC I/O registers, or a single function block, so that the controlling program can deal with each node's data as though the node is an internal device, without having to be concerned about timing problems. This mapping of node to register or function block is carried out during network configuration, which is usually carried out using a PC based program.

### 7.7.1 I/O Data transfer limits

The PROFIBUS DP standard allows up to 244 bytes of data, or 116 discrete data items to be transferred in each direction, during each I/O data exchange. Many PLC masters, however, are unable to support more than 32 bytes, and this has become a typical value. Input and output data lengths for a given node are variable, and it is possible to define nodes as read only, write only or read/write.

The I/O data mixture used by a given slave device is defined by what is called a 'GSD' file, which can be edited to change the mapping of node parameters to PROFIBUS inputs and outputs. This file is imported into the network configuration before the network is created.

## 7.7.2 Data format

Data is transmitted in both directions as a single 16-bit integer value (also called a ‘register’). The value is returned as a scaled integer such that 999.9 is returned as 9999, and 1.234 is returned as 1234. The control program in the PROFIBUS master must convert these integers into floating point numbers if required. Alternatively, scaled integer number types can be used in the .uyy file to achieve the same end (see section 7.3 above).

## 7.8 GSD FILES

Figure 7.8 shows that for each instrument on the communications link, a Device Database File is constructed and loaded into the Profibus configuration terminal. These files (called Gerätestammdaten or GSD files) contain information, relating to the instrument’s parameters, which the PROFIBUS master (a PLC in the figure) needs in order to communicate with the device.

When operating as a Profibus slave unit (not supported in this version), it is necessary to load a Visual supervisor .gsd file into the master unit before communications can be established. A suitable .gsd file is supplied with the unit. When operating as a master unit, .gsd files are required for all ‘third party’ equipment with which the Visual Supervisor is to communicate. Such .gsd files are normally supplied with the third party equipment. The Visual Supervisor will normally come ready loaded with suitable .gsd files for I/O systems (for example) supplied by the Visual Supervisor manufacturer

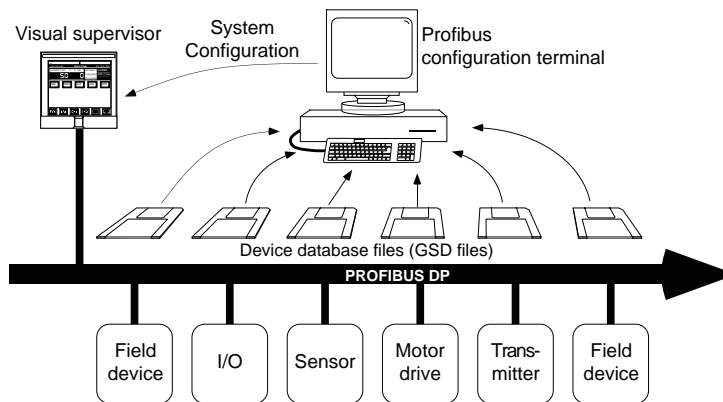

Figure 7.8 Typical PROFIBUS link using a PLC as master  
(from section 3.3 of <http://www.profibus.com>)

### 7.8.1 Specific keywords

The following Eurotherm specific keywords may be added to a slave GSD file.

Keyword	Value	Description
Eurotherm_Demand_Data	1, 2, 3	If any Eurotherm product has been configured to support demand data, this line must be added to the GSD file that applies to that instrument. 1 Eurotherm Drives products such as model 584SV, 590, 605, 690 etc. 2 Eurotherm Controls products, such as model 240x, T630, 2500 etc. 3 Eurotherm Recorders products, such as model 4103, 4100G.

## CHAPTER 8: ADMINISTRATIVE FUNCTIONS

### Notes:

1. Access to all functions described in this chapter require ADMIN privileges.
2. The functions described in this chapter apply only to instruments fitted with the 'Auditor' option.

The Administration menu is accessed by operating the menu key at the bottom right of the screen, followed by operations of SYSTEM and ADMIN keys



### 8.1 NETWORK AUDIT TRAIL

This function allows the Audit trail (i.e. alarm and event logs) to be transmitted from the instrument (the 'Provider') to up to three E suite systems (the 'Consumers'). Network Audit Trail is accessed from the Administration menu by operation of the NET AUDIT key, as depicted in figure 8.1, below.

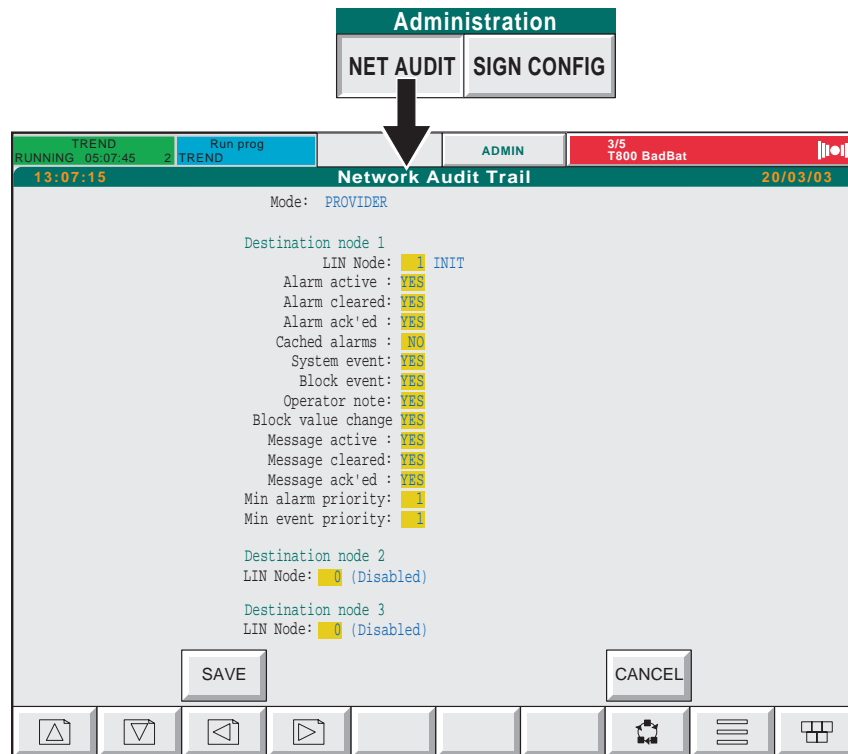

Figure 8.1 Network Audit trail access.

## 8.1.1 Modes

The function can be programmed in the following ways:

1. **Isolated.** The instrument displays only its own alarms and events. Alarms and events are not transmitted to any other node.
2. **Provider.** As 'Isolated', except that the unit can also transmit its alarms and events to up to three other Audit Trail consumers.
3. **Consumer.** The instrument displays its own alarms and events, plus those of up to eight other Visual Supervisors. Alarms and events are not transmitted to any other node. The node number of the provider is prefixed to the relevant line(s) in Alarm and Event Logs (section 3.5.6) - local Alarms and Events are prefixed with space characters.

## 8.1.2 CONFIGURATION (PROVIDER)

Configuration is in two parts - selecting the E suite systems (the Consumers) to which the Audit Trail is to be transmitted, and (if required) disabling one or more alarm or event types, so that only those items of interest are transmitted.

### CONSUMER SELECTION

From 'Provider' mode, enter the (decimal) node addresses of the E suite systems to which the Audit Trail is to be sent. Once this has been done the SAVE key should be operated, and power removed from the instrument for a few seconds, then reapplied.

### AUDIT TRAIL FILTERING

Again, from 'Provider' mode, the various parameters associated with each node's Audit trail can be enabled (set to 'Yes') or disabled (set to 'No').

### PARAMETERS

Lin Mode	UNINIT	No attempt is currently being made to establish communications with the Consumer.
	INIT	Initialised, but no communications have taken place as yet
	CONNECTED	Initial communications have been established, but no Audit Trail files are being transmitted.
	ACTIVE	The Audit Trail is being transferred to the Consumer.
Alarm active	YES = include active alarms	
Alarm Cleared	YES = include cleared alarms	
Alarm Ack'ed	YES = include acknowledged alarms	
Cached Alarms	No = do not include cached alarms (see note below)	
System Event	YES = include system events	
Block events	YES = include block events	
Operator note	YES = include operator notes	
Block Value Change	YES = include events recording changes to block field values	
Message active	YES = include active messages	
Message Cleared	YES = include cleared messages	
Message Ack'ed	YES = include acknowledged messages	
Min. alarm priority	1 to 15: Specifies minimum alarm priority for inclusion	
Min. event priority	1 to 15: Specifies minimum event priority for inclusion	

---

**Note:** 'Cached alarms' is normally set to 'No' to prevent cached blocks being sent to the consumer. (It is usual for the Consumer to have cached these blocks itself.)

---

### 8.1.3 User ID control

The use of passwords and user IDs is more strictly controlled in an instrument fitted with the Auditor option, than in instrument not so fitted (section 4.4, above). Access to User IDs and passwords etc. requires ADMIN permissions. The major points to note are as follows:

1. It is not possible to edit a user's Identity, Name, Access Level or 'Attributes' once the SAVE key has been pressed.
2. Once a password has been allocated, it can not be used again either by the original user or by a new user.
3. A Password expiry period, amongst other things, can be set in the 'Properties' menu. Once this period has expired, the relevant passwords will no longer be usable.
4. A new user's initial password has a 24 hour expiry period. Within this time the user must log in and enter a new password. Once this is done, the new password will be allocated the expiry period set up in the Properties menu (default 90 days).
5. A Password must include one non-alpha character (i.e. it must have at least one character which is not one of A to Z or a to z.)
6. The password may not be the same as the User identity.
7. The 'Delete' key in the non audit pack instrument is replaced by a 'Retire' key. When the Retire key is operated, with a user selected, that user's name is removed (after confirmation) from the security access page. The details are, however, stored within the instrument to ensure that the same ID/password etc. cannot be used more than once.

### SECURITY ACCESS DISPLAY PAGE

This page is called by touching the ACCESS key from the root menu, and entering the ADMIN Identity and Password (both 'ADMIN' when despatched from the manufacturer). Once logged in as ADMIN, operation of the USERS key calls the Security Access Display page, shown in figure 81.2a, below.

---

Note: For a more detailed description of how to access the ADMIN login, see section 4.4.3

---

Identity	Name	Access	Attributes	Expires	Reference
ADMIN	ADMIN	ADMIN	00000003	27/11/04	0
ADMIN2	ADMIN2	ADMIN	00000003	27/11/04	0
COMMISSI	COMMISSION	COMMISSION	00000000	27/11/04	0
ENGINEER	ENGINEER	ENGINEER	00000003	27/11/04	0
OPERATOR	OPERATOR	OPERATOR	00000000	27/11/04	0
richard	LinMan1	ENGINEER	00000003	27/11/04	0

SAVE CANCEL NEW PROPERTIES MAINT STATS REVISION DEPLOY

Figure 8.1.3a Security Access Page

As can be seen from the figure, the page is divided into a number of columns. Name, Access and Reference columns are all as described in section 4.4.3 above. Other columns are used as follows:

### 8.1.3 USER ID CONTROL (Cont.)

#### IDENTITY

Touching a users Identity 'cell' calls the 'Identity' pop-up to appear (figure 8.1.3b). This allows a new password to be entered for the ID in the normal way. The new password has a 24 hour expiry, so the user has to login and provide a further new password with this time period. The pop-up also allows IDs to be 'Retired' or Disabled.

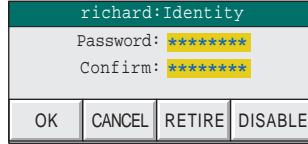

Figure 8.1.3b Identity pop-up

#### RETIRE

A 'retired' user is permanently removed from the Security Access page, and all access privileges are terminated. Retired users' Identities, Names and passwords may not be reused. It is therefore recommended that a note is kept of all Retired users' details.

#### DISABLE

Users who are disabled (Identity and Name in Red) lose their access privileges in a non-permanent way. To reinstate a Disabled user, the Identity cell is touched, the User's password entered and confirmed, and 'OK' touched. If the password is correct, the User is 're-enabled', and is shown in the normal blue colour on the screen. The expiry date remains as first set up for the user.

#### NAME

Operating this button calls the Name pop-up to the screen. For new users whose details have not yet been Saved, the name can be edited. Otherwise, as shown in figure 8.1.3c, this is a View only function.



Figure 8.1.3c Name pop-up

#### ATTRIBUTES

Touching a particular user's Attributes 'cell', calls the Attributes page. This is used to define the users ability to 'sign' and 'authorise' changes, and to define whether the user can modify the instruments operation.

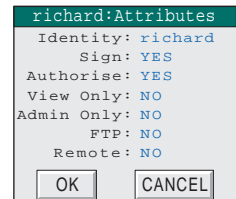

The numbers which appear in the attributes column can be decoded as shown in table 8.1.3. The values are additive, so if, for example, 'Sign' and 'Authorise' are both selected 'Yes', and all other fields are selected 'No', then the attributes value would be 00000003.

Sign	Authorise	View only	Admin only	FTP	Remote	Display
No	No	No	No	No	No	00000000
Yes	No	No	No	No	No	00000001
No	Yes	No	No	No	No	00000002
No	No	Yes	No	No	No	00000004
No	No	No	Yes	No	No	00000010
No	No	No	No	Yes	No	00001000
No	No	No	No	No	Yes	00002000

Table 8.1.3 Attribute coding

### 8.1.3 USER ID CONTROL (Cont.)

#### EXPIRES

This column shows the expiry date for each Password. For each new user, the expiry date is 24 hours after the new user details are Saved. The user must log on and change the password within 24 hours, or the Password will lapse. The new password will have the Expiry period set in the Properties menu (described below) of the Security Access Page.

#### SCREEN KEYS



These keys are located near the bottom of the screen. The SAVE and CANCEL keys operate in the same way as described in section 4.4.3, above.

#### NEW

Operating the NEW key calls the New User pop-up menu to the display. Once the details have been entered, and 'OK' pressed, the new user appears in Green, on the screen.

*Note: Do not press SAVE until all other parameters (e.g. attributes) have been configured for this user. Once SAVED, only the password can be changed.*

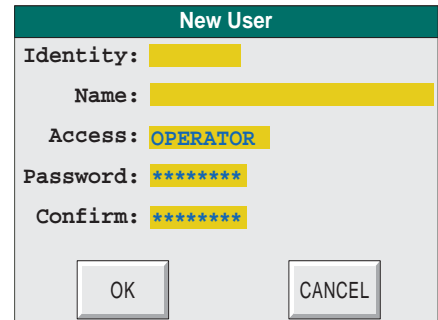

Figure 8.1.3d New User screen

Configure the users **Attributes**, as described above, the press SAVE. The user Identity and Name change to Blue, and the Password expiry date appears as next day. If the user Password is to expire at any period other than that set in the PROPERTIES menu (described below), this should now be set.

ADMIN should now be logged out of, and the new user logged in and a new password entered.

#### PROPERTIES

Similar to the Properties page described in section 4.4.3, this page, depicted with default values in figure 8.1.3e, allows the login parameters to be set, as shown below..

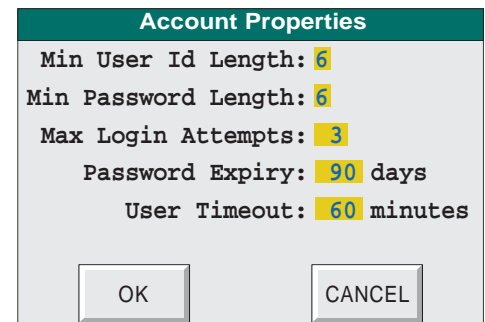

Figure 8.1.3e Properties default values

Min User ID Length	3 to 8	
Min Password Length	3 to 8	Passwords must have at least one non-alpha character.
Max Login attempts	1 to 99	The number of attempts at logging-in that may be made before the account is disabled.
Password Expiry	1 to 180	The password expires after the specified number of days have elapsed since the last time the value was edited.
User Timeout	1 to 720	The user is logged out after the specified number of minutes has elapsed since previous screen activity.

### 8.1.3 SECURITY ACCESS PAGE (Cont.)

#### MAINTENANCE

Operating the 'MAINT' key at the bottom of the Security Access screen calls the 'Account Maintenance' screen to the display, as depicted in figure 8.1.3f, below.

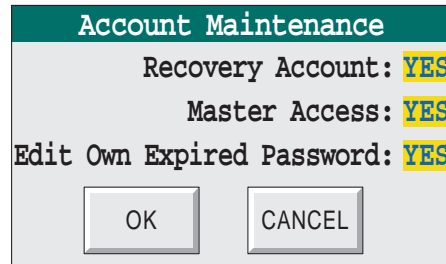

Figure 8.1.3f Maintenance screen

Recovery Account	If recovery account is set to YES, this enables a recovery in the event of all ADMIN accounts becoming unusable. This requires a maintenance contract with the manufacturer.
Master Access	Setting Master Access to 'NO', means that the editing of Account systems is not possible.
Edit Own Expired Password	If set to Yes, the user will be forced to change password when attempting to log in. If set to 'No', only a user with ADMIN permissions may enable a new password for a user whose password has expired.

#### STATISTICS

Operating the STATS key at the bottom of the Security Access screen calls the 'Statistics' screen, as depicted in figure 8.1.3g, below.

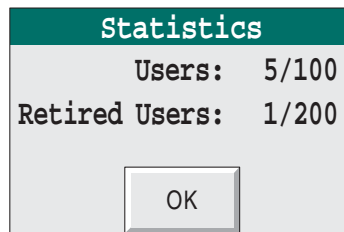

Figure 8.1.3g STATS window

This window shows:

1. How many users have been configured out of the total available. For example, Users: 6/100 means that six of the 100 possible users have been configured.
2. How many users have been retired. For example, 1/200 means that 1 user has been retired, and that 199 further users may be retired.

---

**Note:** Retiring the 201st user causes the 1st Retired user (by time/date) to be removed from the list. This results in Event 20 (Purged user) being set. This user's data can now be re-used.

---



### 8.1.3 SECURITY ACCESS PAGE (Cont.)

#### REVISION

Touching this key, calls the configuration revision page, as depicted in figure 8.1.3h, below.

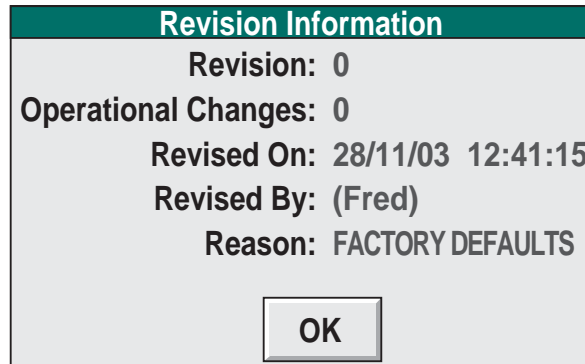

Figure 8.1.3h Revision page

#### DEPLOY

A master access system can 'deploy' its own access system to other Visual Supervisors across its ALIN network.

This 'Deployment' is in three stages:

1. Select the number of nodes (initially 0)
2. Enter the node numbers to be deployed to.
3. Initiate the deployment.

The initial display page appears when the 'DEPLOY' key is first pressed (Figure 8.1.3j), and shows that the number of nodes is zero.

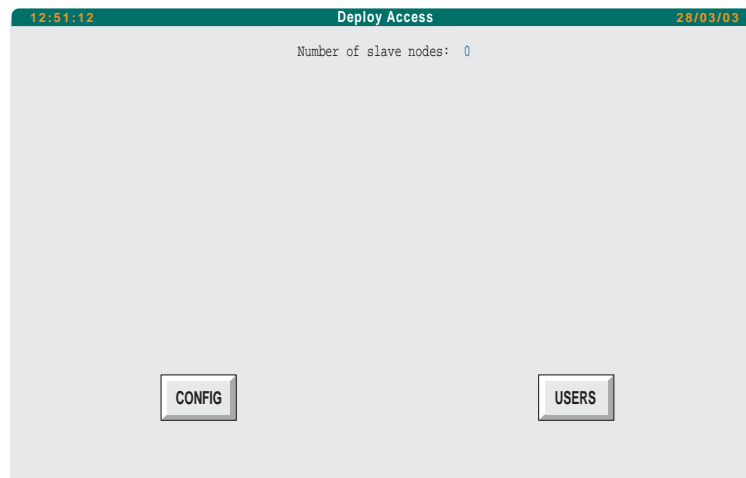

Figure 8.1.3j Initial Deploy configuration page

Touching the CONFIG key, allows the number of nodes to be deployed to, to be entered. The display shows one configuration box each, for the number of nodes selected, to allow the required node numbers to be entered. Initially, all these contain '0', although this value cannot be used. (Figure 8.1.3 k.)

### 8.1.3 SECURITY ACCESS PAGE (Cont.)

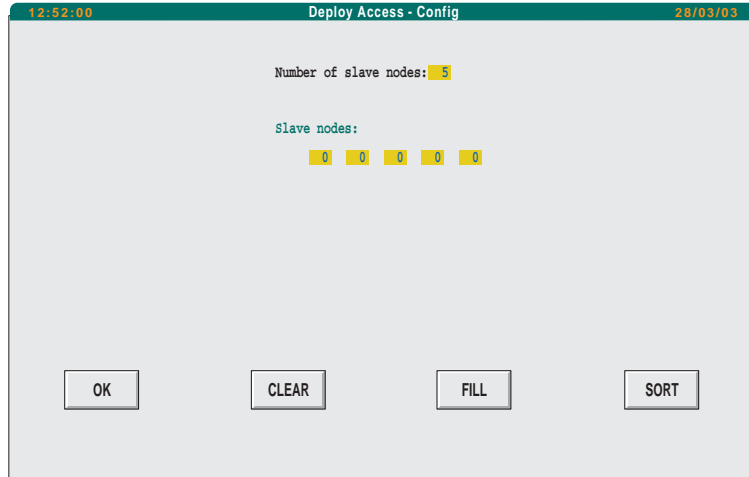

Figure 8.1.3k Node number configuration.

Operation of the FILL key at this point will fill the node number configuration boxes with nodes 1 to n, where n is the number of nodes selected.

If, instead, the first node is entered by the user (say node 10), the FILL operation will automatically fill in the remaining node numbers, (starting at 11 in this example).

If non-consecutive node numbers are entered, say nodes 17, 3, 9, 103 and 14, then the SORT button can be used to reorder the nodes in ascending order (3, 9, 14, 17, 103).

The CLEAR key is used to reset all the mode numbers to '0'.

Operation of the OK key, returns to the previous page, only this time, the newly configured items appear.

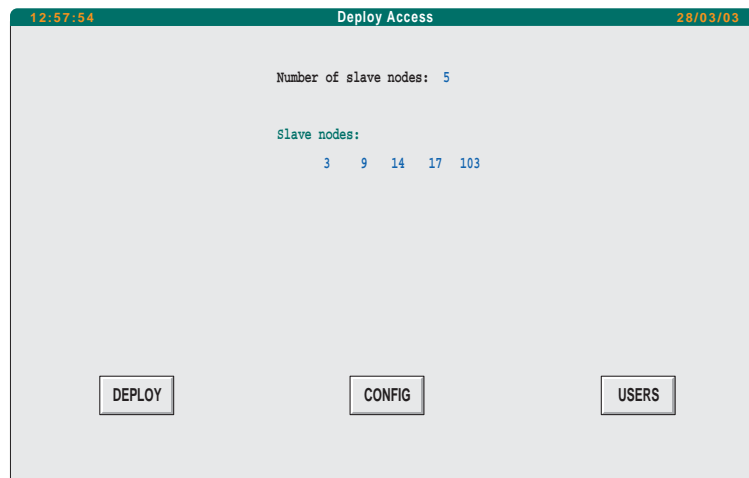

Figure 8.1.3l Completed configuration

Operation of the DEPLOY key causes the deploy to be initiated, once signed and authorized if necessary. Figure 8.1.3m shows the confirmation page.

## 8.1.3 SECURITY ACCESS PAGE (Cont.)

**Deploy Access**

**Number of slave nodes: 5**

**Slave nodes:**

3 9 14 17 103

**Confirm Action: DEPLOY**

**Reason:** [REDACTED]

**Signed by**

**Ident:** ADMIN

**Password:** [REDACTED]

**Authorised by**

**Ident:** [REDACTED]

**Password:** [REDACTED]

Figure 8.1.3m Deploy confirmation page

## 8.2 ELECTRONIC SIGNATURES

### 8.2.1 Enabling electronic signatures

**Note:** Once Electronic signatures have been enabled, they can not subsequently be disabled.

As shipped, electronic signatures are disabled. The 'Enable signatures' Signature Configuration page (figure 8.2.1) appears on the first operation of the SIGN CONFIG key in the Administration menu.

The only choices are to quit the page (by selecting another page using the menu key) or Enable electronic signatures.

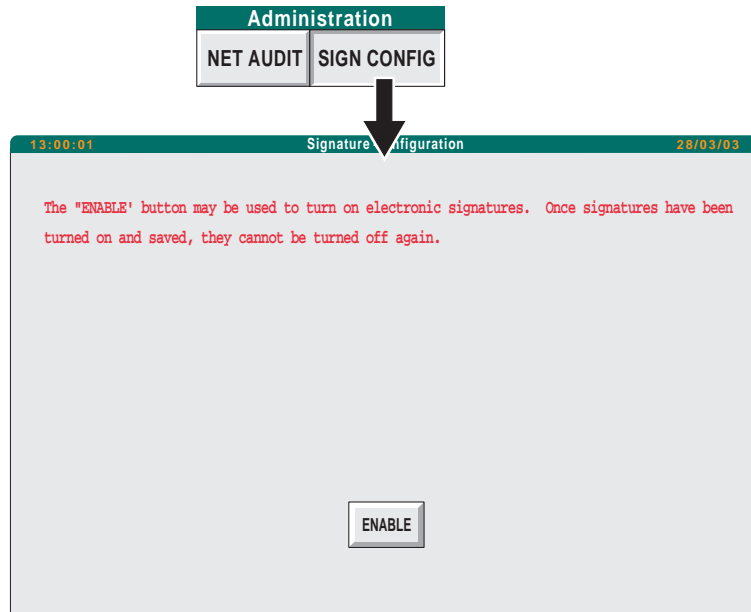

Figure 8.2.1 Enable Signatures page

When 'Enable' is operated, a dialogue box appears requiring two separate ADMIN passwords before the Signature Configuration page (figure 8.2.2) appears.

## 8.2.2 Signature Configuration

Figure 8.2.2a shows the Signature Configuration page. The administrator IDs in 'Revision Level' are, initially the IDs of the administrators who enabled the Electronic Signature feature. Subsequently the IDs are those of the administrators who signed/authorized the previous Configuration Save.

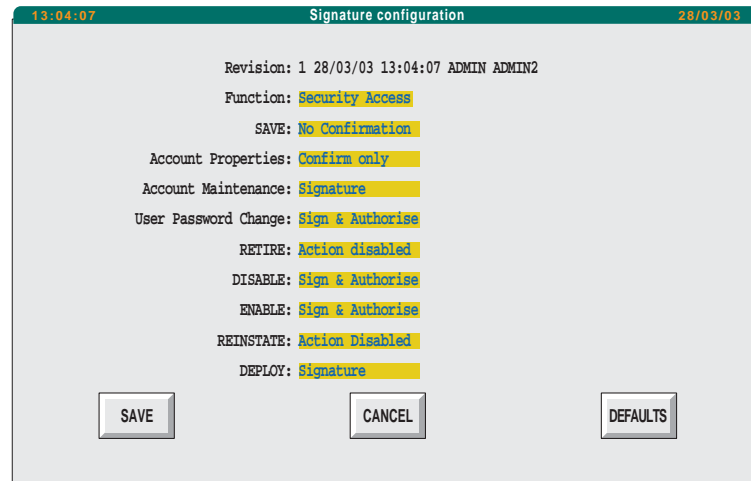

Figure 8.2.2a Signature Configuration page

### ACCESS LEVELS

As can be seen from figure 8.2.2a, above, a number of instrument features can have an access level assigned to them. The possible access level definitions are as follows:

No Confirmation	The instrument behaves as if electronic signatures are turned off.
Confirm only	A dialogue box with OK and CANCEL buttons appears, before the action is undertaken.
Signature	A password entry by a user with Signature Permissions is required before the action is performed.
Sign & Authorise	A password entry by a user with Signature Permission and a further entry by a user with Authorization permission are required before the instrument will respond to the requested action.
Action Disabled	This causes the relevant button caption to be 'greyed out' thus becoming inaccessible to the user. Thus the action may not be undertaken at all.

---

**Note:** Some functions cannot be allocated some access levels. Administrative functions, for example, always require a minimum level of 'Signature', and some functions cannot be assigned 'Action Disabled'.

---

The available functions are in a number of categories, a picklist of categories being displayed when the 'Function' field is touched. Figure 8.2.2b, below shows this picklist.

The button functions at the bottom of the page are as follows:

SAVE	Saves all changes to all functions.
CANCEL	Cancels all changes made since last SAVE or DEFAULT operation.
DEFAULT	Returns the access levels to those when initially enabled.

**8.2.2 SIGNATURE CONFIGURATION (Cont.)**

Figure 8.2.2b Function picklist

## CHAPTER 9: REMOTE ACCESS

The instrument provides a limited set of facilities which allow remote users to access the instruments.

### 9.1 FTP

For instruments fitted with the Ethernet option, an FTP server may be enabled from the comms setup page (section 4.5.1.3).

#### 9.1.1 FTP logon

FTP access always requires the user to log on. Anonymous FTP logons are not permitted. To configure the instrument for FTP logon, the user-based access system (section 4.3.3) must be used, and the relevant user's attributes configured to include FTP = 'Yes'.

The instrument allows up to four users to be logged in at any one time, but only one of these may have write permission (attribute View Only = 'No'). This user's log on/ log off activity is recorded in the Event Log. Users with View Only = 'Yes' do not have their log on/log off activity recorded.

---

Notes:

1. Any attempt to log into a non FTP account, or into a nonexistent account will be recorded in the Event log.
  2. The mis-typing of FTP passwords is included in the count of 'failed attempts to log in' (section 4.4.3.2), and therefore may result in the account being disqualified.
  3. Attempts to login to non FTP accounts are not included in the count of 'failed attempts to log in'.
- 

#### TIMEOUT

FTP users are automatically logged out after 2 minutes of inactivity. This happens regardless of any values for user timeout which have been set at the instrument user interface.

#### 9.1.2 File system

The file system, as viewed via FTP, is seen as a simple set of folders, with the characteristics shown in table 9.1.2.

---

Notes:

1. It is not possible to access the floppy disk or USB bulk storage device via FTP.
  2. It is not possible to create new folders via FTP.
- 

FTP Name	LIN device	Description	Write Permission	Visibility
/app	E:	Internal flash memory for application files	Yes	If IPRP not enabled
/history	H:	Internal archive (if fitted)	No	If archive fitted

Table 9.1.2 File system

#### 9.1.3 Archive File Transfer

If Review software or any other FTP client is used to transfer files from the internal archive to a PC, then it is recommended

- a. That the user account attribute configuration includes FTP = 'Yes' and View Only = 'Yes' and
- b. The access level for this account be set to 'Operator'
- c. The account is used only for this purpose.

This page is deliberately left blank



## CHAPTER 10: PREVENTIVE MAINTENANCE

In order to maintain the instrument at specified performance it is recommended that the internal fan be replaced every two years; replacement procedures are included below for both the large frame and small frame products.

The procedure also shows how to replace the battery, though, as this is a non-rechargeable battery, its replacement period depends on the cumulative length of time over which the instrument is left without supply power. The battery maintains the real-time clock and SRAM data (e.g. hot start database).

A flag (BadBatt) can be set in the “T800” block. This flag will result in an instrument alarm should the battery voltage falls below three Volts. It is recommended that the battery be replaced as soon as possible after the appearance of this warning, as otherwise, retention of SRAM data for more than 24 hours, under power-off conditions, cannot be guaranteed. (A ‘supercap’ ensures that data is retained for at least 24 hours no matter what the state of the battery.)

A procedure is also given for ‘calibrating’ the touch screen. This procedure ensures that the instrument responds to the exact point that has been touched by the user.

### 10.1 LARGE FRAME FAN/BATTERY REPLACEMENT

#### Warning

As hazardous voltages are generated by the power supply board, this procedure may be followed only with the supply voltage isolated, and by trained personnel who are aware of the potential hazard.

1. Isolate the instrument from supply power.
2. Release the combined top/rear cover by removing the four countersunk screws marked ‘A’ in figure 10.1a, and the pan-head screws (‘B’ and ‘C’). All these fixings should be retained for use in re-assembly. For current instruments, screws ‘A’ are T8 Torx headed screws. Previous versions used cross-head screws. For previous versions, items ‘C’ were two-part plastic rivets.
3. Once all the fixings have been removed, the cover can be removed by lifting its bottom edge upwards and outwards (figure 10.1b).

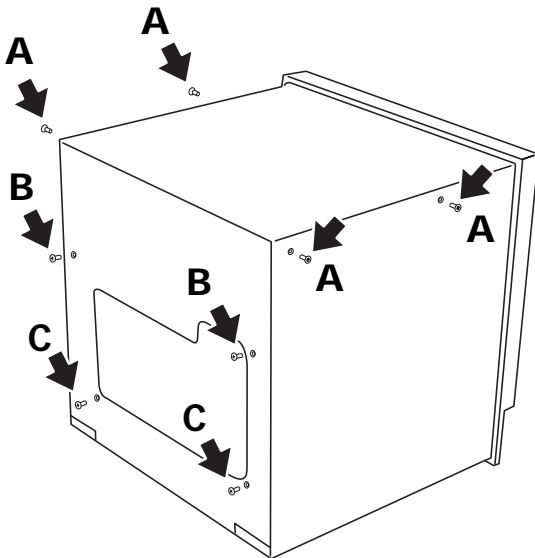

Figure 10.1a Remove cover fixings

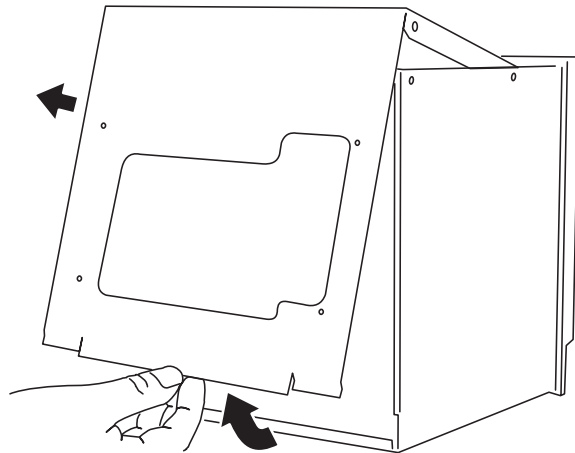

Figure 10.1b Remove cover

## 10.1 SVGA (LARGE FRAME) INSTRUMENTS (Cont.)

This reveals the internal structure of the instrument. Figure 10.1d shows the locations of the fan (A) and the battery (B). Figures 10.1d and 10.1e show details.

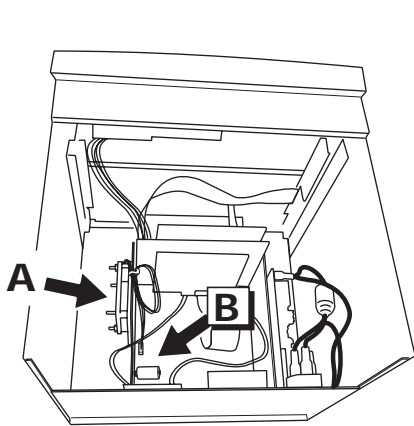

Figure 10.1c Fan and battery locations

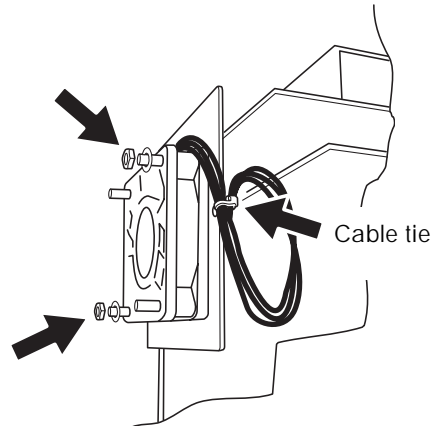

Figure 10.1d Fan replacement details

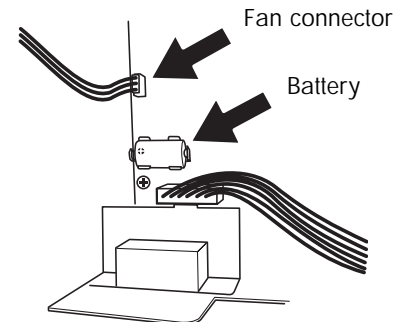

Figure 10.1e Battery and fan connector

### 10.1.1 Fan replacement

1. Disconnect the fan connector, located as shown in figure 10.1e, above.
2. Cut the cable tie (figure 10.1b, above) which secures the fan harness to the chassis.
3. Use a suitable spanner (7mm (9/32) A.F.) to release the two M4 nuts securing the fan.
4. Remove the nuts and associated shakeproof washers, ensuring that any that fall into the body of the instrument are retrieved.
5. Remove the old fan and discard it, noting carefully the orientation (that is, where the harness emerges from the fan body).
6. Take the new fan, and orient it such that the airflow is into the instrument, and the wires emerge from the left hand edge of the fan (that is, the edge nearest the display screen). Figure 10.1.1 shows the airflow and vane direction indicators moulded into the edge of the fan, near the wire aperture.

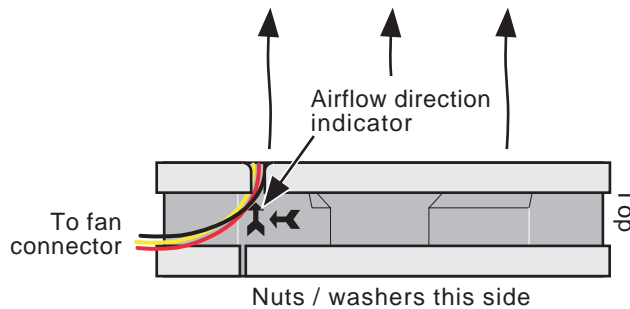

Figure 10.1.1 Airflow direction indicator

7. Slide the fan onto the four studs, and re-fit the two nuts and shake-proof washers at top left and bottom right of the fan. Do the nuts up finger tight, then tighten using a suitable spanner.
8. Coil the harness neatly, and mate the fan connector (located as shown in figure 10.1e). Secure the harness coil to the chassis, using a cable-tie (figure 10.1d), ensuring that the harness is not strained.
10. Refit the top cover, and secure it using fixings A, B and C, previously removed.

## 10.1.2 Battery replacement

### WARNING

Care must be taken to ensure that neither the exhausted battery or its replacement are shorted out, otherwise an explosion may occur, resulting in the emission of hazardous products. Do not use a metal object to remove the battery from its holder: if necessary, use a plastic or wooden item instead.

### WARNING

If the battery is damaged and leakage has occurred, do not allow skin contact with the leak material. Refer to the COSHH statement included in section C3 of Appendix C for details.

Note: Although the circuitry and the battery are protected against incorrect battery insertion, the clock, hot-start data etc. held in the unit's SRAM will not be protected against power loss, should the battery be inserted 'back-to-front'.

1. Once the cover is removed, the exhausted battery (located as shown in figures 10.1c and 10.1e) can be prized out of its holder, and the replacement fitted.
2. Ensure that positive end of the battery is towards the + sign printed on the circuit board, near the battery holder. (There is usually a + sign printed on the battery sleeve.)

## 10.2 SMALL FRAME FAN/BATTERY REPLACEMENT

Note: The fan replacement procedure, detailed below, applies only to small frame units with status levels of Q36 or higher (July 2004). Small frame instruments manufactured prior to this were not fitted with fans. See section 10.3 for battery replacement procedures.

### Warning

As hazardous voltages are generated by the power supply board, this procedure may be followed only with the supply voltage isolated, and by trained personnel who are aware of the potential hazard.

1. Isolate the instrument from supply power.
2. Release the cover by undoing the two T8 Torx-headed screws ('A' in figure 10.2a) and the Cross-headed screw ('B' in the figure).
3. Lift and turn the cover over as shown in figure 10.2b, to reveal the internal structure of the unit.

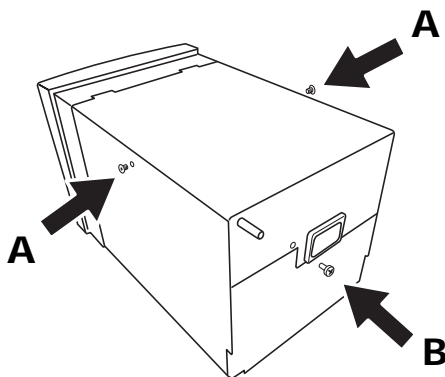

Figure 10.2a Undo cover fixings

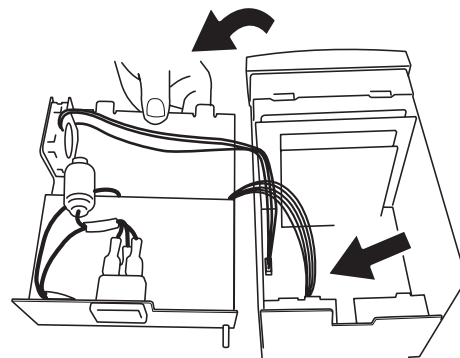

Figure 10.2b Lift and invert cover

The battery can now be replaced, as described in section 10.2.2, below.

## 10.2.1 Fan replacement

**Note:** It is recommended that the fan be replaced with no further disassembly of the unit. If more convenient, the cover can be detached from the rest of the instrument, by disconnecting the power and fan connectors.

Figure 10.2.1a shows the locations of the battery, the fan connector and the power connector. Figures 10.2.1b and 10.2.1c, show the high voltage ac/dc supply and low voltage dc supply units, respectively, with cover removed. It is recommended that the cover be removed only if absolutely necessary, because the (latching) power connector is difficult to disconnect/reconnect.

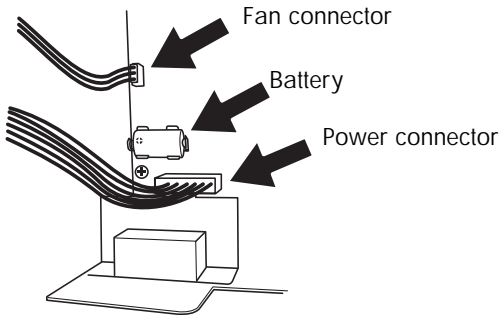

Figure 10.2.1a  
Battery and connector locations

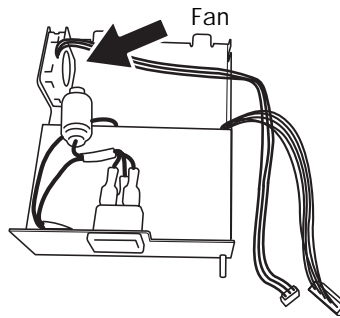

Figure 10.2.1b  
Fan location  
(high voltage supply units)

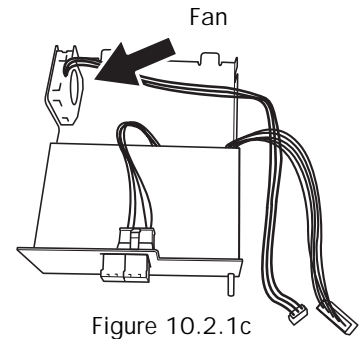

Figure 10.2.1c  
Fan location  
(low voltage dc supply units)

1. With the cover open, and the fan connector disconnected, the old fan can be removed by removing its securing nuts and shake-proof washers, and sliding it off the studs. The orientation of the fan should be noted.
2. Ensuring correct orientation (figure 10.2.1d) fit the new fan over the studs, and secure using the fixings removed in step 1. Ensure that the flow direction indicator arrow is pointing towards the inside of the instrument.
3. Connect the fan connector (and the power connector if previously disconnected) and re-assemble the cover to the rest of the unit.

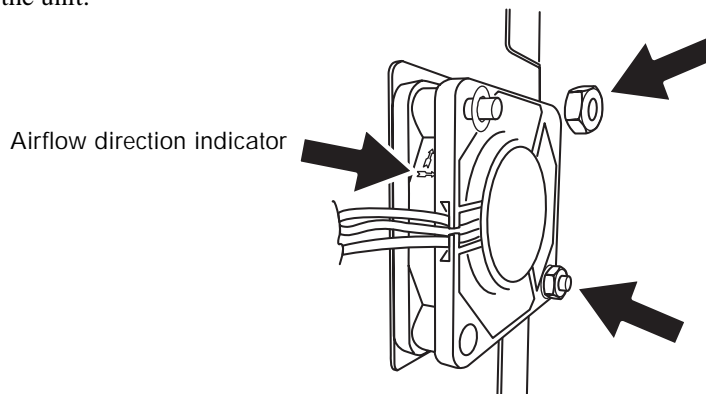

Figure 10.2.1d Fan replacement

## 10.2.2 Battery replacement

Please refer to the warnings and note given in section 10.1.2, above before touching the battery.

1. Once the cover is open, the exhausted battery (located as shown in figure 10.2.1a) can be prised out of its holder, and the replacement fitted.
2. Ensure that positive end of the battery is towards the + sign printed on the circuit board, near the battery holder. (There is usually a + sign printed on the battery sleeve.)

### 10.3 BATTERY REPLACEMENT (OLDER UNITS)

The battery contained in the unit may be of type CR2032 (lithium-manganese dioxide coin cell) or LS14250 (Lithium thionyl Chloride 1/2AA size) according to when the unit was manufactured.

If the battery is of the Lithium thionyl chloride type, please refer to the Warnings and Note in section 10.1.2, above.

1. Remove the top plate of the unit by removing the four M2.5 countersunk-head securing screws ('A' in figure 10.3a) and the M3 pan-head screw ('B' in the figure).
2. Remove the four power supply securing screws 'C' (two each side).
3. The power supply unit can now be rotated out of the chassis, giving access to the battery, located on the interconnection PCB (figure 10.3b). Figure 10.3c shows how to eject coin cells.

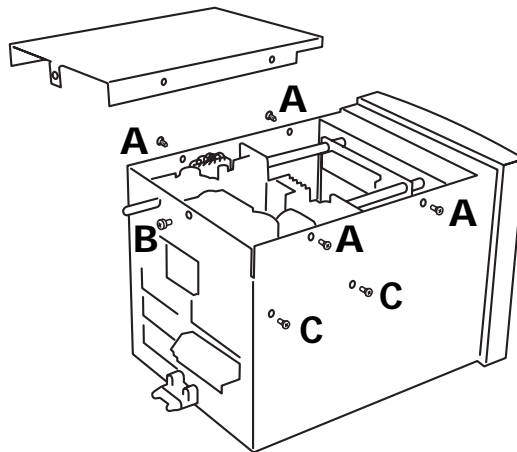

Figure 10.3a Top cover removal

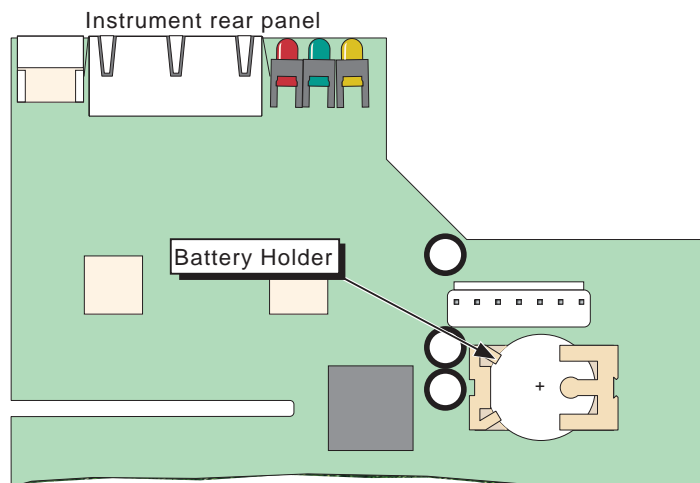

Figure 10.3b Battery location  
(Coin cell shown; 1/2AA location similar).

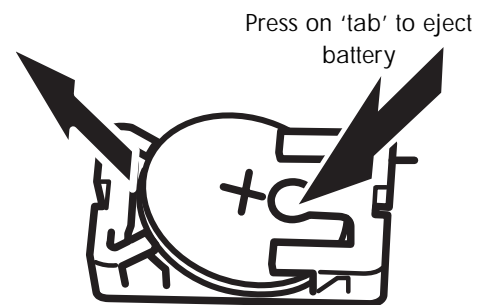

Figure 10.3c Coin cell eject

## 10.4 TOUCH SCREEN CALIBRATION

This ensures that the image is positioned correctly relative to the TOUCH screen.

At switch-on, continuously hold a finger in contact with the display screen until the 'calibration display' appears (approximately 60 seconds after switch on) as depicted in figure 10.4.

Using a soft, small diameter item (e.g. a pencil point) which will not damage the touch screen, touch the intersection of the upper set of crosshairs, as requested by the display.

Once the top left target has been accepted, continue as requested by the display. Once the targets have been accepted, initialisation continues as normal.

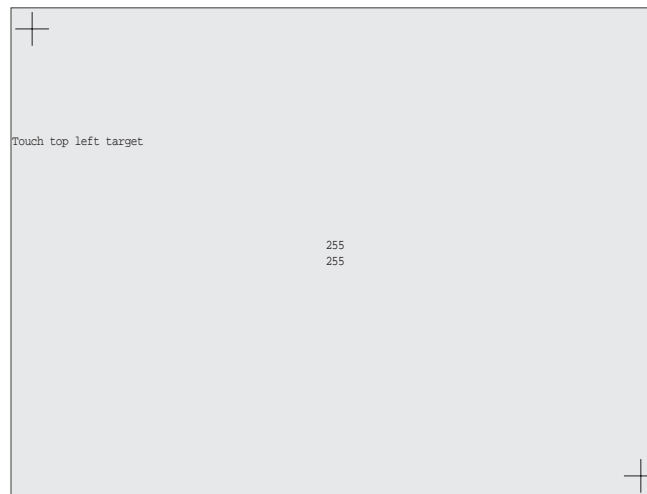

Figure 10.4 Initial calibration display screen

**APPENDIX A: TECHNICAL SPECIFICATION**

In order to comply fully with BS EN61010, all I/O and hardware alarms must be enabled

**General specification****Physical (1/4 VGA)**

## Dimensions

Bezel:	144 x 144 mm
Cut-out:	138 x 138 mm
Depth:	180 mm (case) + X mm (cabling) where X = 50 for Category 5 cable with RJ45 connectors

Weight 2.83 kg

Screen	Type:	1/4 VGA TFT colour
	Display area:	111 x 84 mm
	Touch panel:	Resistive analogue
	Character set:	Unicode Latin-1

**Physical (SVGA)**

## Dimensions

Bezel:	288 x 288 mm
Cut-out:	281 x 281 mm
Depth:	254 mm (case) + X mm (cabling) where X = 50 for Category 5 cable with RJ45 connectors

Weight 6.12 kg

Screen	Type:	SVGA TFT colour
	Display area:	245 x 183 mm
	Touch panel:	Resistive analogue
	Character set:	Unicode Latin-1

**Environmental**

Temperature	Storage:	-10 to +85°C
	Operation:	0 to + 50°C
Humidity	Storage:	5 to 95% RH (non-condensing)
	Operation:	5 to 85% RH (non condensing)
RFI	Emissions:	BS EN50081-1
	Susceptibility:	BS EN50082-2
Electrical Safety		BS EN61010-1:2001 Installation category II, Pollution degree 2.
Vibration		BS EN60873, Section 9.18
Shock		BS EN60068-2-31; BS EN60873, Section 9.12
Protection	Front panel:	IP65 (SVGA); IP54 (1/4 VGA)

**Power Requirements**

## Standard:

Voltage range:	90 to 250 V; 50/60 Hz or 120 to 340V dc.
Maximum power requirement:	50VA
Maximum current:	0.56A
User termination:	Standard IEC fixed plug
Internal fusing:	No user replaceable fuses.
External fusing:	It is recommended that a 3A in-line fuse be fitted.

## Low voltage dc

Voltage range	19 to 32V dc
Maximum power requirement:	30 Watts
Maximum current:	1.6 A
User termination:	Two parallel-wired two-pin fixed plugs
Internal fusing:	2.5 Amp Type T (IEC 127 time Lag)
External fusing:	It is recommended that a 2 Amp Type T (IEC 127 time Lag) fuse be fitted in each positive supply line (section 1.3.6.2).

**SPECIFICATION (Cont.)**

**Battery**

Battery (if fitted) If a battery is fitted, then the its type depends on whether the unit is a large-frame or small frame unit, and on when it was manufactured (see accompanying table). CR2032 is a lithium-manganese dioxide coin cell; LS14250 is a 1/2 AA 3.6V Lithium Thionyl-chloride battery. When exhausted, batteries must be disposed-of in accordance with local regulations: they may not be disposed-of with normal refuse.

Large frame units	Units prior to status level 20 (July 2002) fitted with CR2032.	Units with status level 20 or higher fitted with LS14250.
Small frame units	Units prior to status level 10 (March 2003) fitted with CR2032.	Units with status level 10 or higher fitted with LS14250.

**Health Relay specification**

Contact format Changeover (Common, normally closed and normally open contacts)  
 Contact rating (resistive) 30V ac/60V dc at 0.5Amps  
 Isolation (Contact-to-ground) 30V ac (RMS) or 60V dc.

**Rear panel indicators**

Red LED Hardware /startup failure  
 Yellow LED SLIN comms activity  
 Green LED Software running  
 Modbus Comms activity Yellow LEDs integral with Comms connectors

**Data Logging Storage**

Disk DOS-formatted 3.5 inch floppy (1.44 MB) or 16MB internal Flash memory  
 Data format ASCII (.asc) or compressed data  
 Data compression Proprietary  
 Log frequency Once every 10 seconds (floppy disk); once per second for internal Flash.

**Programmer**

Max. no. of programs Basic = 25; Standard = 25  
 Max. no. of segments Basic = 250 (approx.); Standard = 500 (approx.)  
 Max. no. of analogue setpoints Basic = 8; Standard = 16  
 Max. no. of digital setpoints Basic = 16; Standard = 32

**Alarms and events**

Number of records in history 250 lines maximum (500 max. for models fitted with 520 CPU)  
 History line format Name - Type - Date - Time  
 Acknowledgment Colour coded.  
 No. of records in event log Standard: 250  
 Enhanced: 1000

**Recipes**

Max. no. of concurrent recipe sets (files) 4  
 Max. no. of production lines per set 8  
 Max. no. of recipes per set (file) 16  
 Max. no. variables per set 250

**Batch**

Max. no. of concurrent batches (files) 4  
 Max. no. of phases per batch 20



## SPECIFICATION (Cont.)

### Trends

Max. no. of groups (trends)	SGVA = 8; $\frac{1}{4}$ VGA = 6
Max. no. of points per group	SGVA = 16; $\frac{1}{4}$ VGA = 16 (but max. 6 faceplates)
Maximum frequency	1 sample per second
Maximum samples	15,000 for 1 group of 16 points.

### Communications specification

#### ALIN ports

Connectors	Parallel wired pairs of shielded RJ45 connectors.
Network medium	ArcNet (screened twisted pair, 100 Ohm)
Network type	Token bus
Speed	2.5 Mbits/sec.
Number of nodes (max)	8, extendable by repeater
Line length (max)	100 metres, extendable by repeater
Isolation	60Vdc / 30V ac; 5.6k $\Omega$ to 0V

#### Ethernet port

Type	100/10 Base-T
Cable	Type: Cat 5
	Maximum length: 100 metres
	Termination: RJ45 telephone connector
Transport protocol	TCP I/P; FTP
Isolation	50 Volts peak

#### Modbus/Jbus (EIA422/485)

Connectors	Parallel wired pairs of shielded RJ45 connectors.
Protocol	MODBUS/JBUS RTU slave
Data rate	Selectable between 1200 and 38,400 Baud
Data format	8-bits, 1 or 2 stop bits, selectable parity
MODBUS data tables	16, configurable as registers or bits
Table length (max.)	200 registers or 999 bits
Memory allocated to tables	6000 bytes
Isolation	60Vdc / 30V ac

#### Modbus (DCM)

Connectors	Parallel wired pairs of shielded RJ45 connectors.
Protocol	MODBUS/JBUS RTU master
Number of nodes supported	16 (standard); 64 (enhanced)
Data rate	Selectable between 1200 and 38,400 Baud
Data format	8-bits, 1 or 2 stop bits, selectable parity
Isolation	60Vdc / 30V ac

#### Profibus

Connectors	Parallel wired pairs of shielded RJ45 connectors.
Protocol	Profibus DP/DPV1
Number of nodes supported	16 (standard); 124 (enhanced)
Data rate	Selectable between 9600 and 12M Baud
Isolation	60Vdc / 30V ac; 1M $\Omega$ to Chassis

#### Universal Serial Bus (USB)

Version	1.1 (2.0 devices are compatible)
Devices supported	USB Bulk storage devices ('Memory Stick')
Isolation	No signal isolation

## FUNCTION BLOCKS SUPPORTED

CATEGORY	BLOCK	FUNCTION
BATCH	BAT_CTRL DISCREP RECORD SFC_CON SFC_DISP SFC_MON RCP_SET RCP_LINE	Batch controller / interface Transmitted/received digital signal-match to diagnose plant faults Storage/retrieval of analogue/digital values for runtime use Sequence (SFC) control, selection and running Display/monitoring/control of remotely-running sequence (SFC) Sequence (SFC) runtime monitoring Recipe set Recipe Line
CONDITN	AGA8DATA AN_ALARM CHAR DIGALARM FILTER FLOWCOMP GASCONC INVERT LEAD_LAG RANGE UCHAR	AGA8 calculation block for compressibility of gas mixtures Alarm, with absolute/deviation/rate alarms 16-point analogue characteriser Digital alarm First-order filter Computes flow-rate, corrected for pressure, temperature and density Contains gas concentration units in Mole% units Analogue inversion block Lead-lag Re-ranges an analogue input 16-point characteriser for analogue input blocks
CONFIG	T800 T2900	System block System block
CONTROL	3_TERM ANMS AN_CONN DGMS DG_CONN MAN_STAT MODE PID PID_LINK SETPOINT SIM TP_CONN	Incremental form of the PID block Analogue manual station Analogue connections Digital manual stations Digital connections Manual station, with connections to front panel displays Control mode selection, with push-button masking PID control function 'Faceplate' for SETPOINT/3_TERM/MAN_STAT/MODE combination Generates a setpoint with bias, limits and alarms Simulates two first-order lags or capacity, with noise Specifies up to nine fields as EEPROM 'tepid data' at power-down
CONVERT	ENUMENUM ENUMUINT UINTENUM	Converts between enumerated number types Converts from enumerated type to integer type Converts from integer to enumerated type
DCM	D2X_LOOP D2X_TUNE D25_LOOP D25eLOOP D25_TUNE D25eTUNE D25_RAMP D25eRAMP D25_MOD D25_AI2 D25_AI3 D25_AI4 D25_A02	Access PIB control loop in 2200/2400/2500 Tune PID loop in 220/2400/2500 Access PID control loop in 2500 IOS 2500E Version of D25_RAMP Tune PID loop in 2500 IOS 2500E Version of D25_TUNE Ramp remote setpoint 2500E Version of D25_RAMP Access single I/O physical module in 2500 IOS Access 2-channel analogue input module in 2500 IOS Access 3-channel analogue input module in 2500 IOS Access 4-channel analogue input module in 2500 IOS Access 2-channel analogue output module in 2500 IOS

**FUNCTION BLOCKS SUPPORTED (Cont.)**

CATEGORY	BLOCK	FUNCTION
DCM (Cont.)	D25_D14	Access 4-channel digital input module in 2500 IOS
	D25_DI6	Access 6-channel digital input module in 2500 IOS
	D25_DI8	Access 8-channel digital input module in 2500 IOS
	D25_D04	Access 4-channel digital output module in 2500 IOS
	D25_AICH	Access single analogue input channel in 2500 IOS
	D25_AOCH	Access single analogue output channel in 2500 IOS
	D25_DICH	Access single digital input channel in 2500 IOS
	D25_DOCH	Access single digital output channel in 2500 IOS
	D25_R_CV	Access up to 8 user wiring real calculated values in 2500 IOS
	D25_B_CV	Access up to 8 user wiring Boolean calculated values in 2500 IOS
	D25_R_UV	Access the 8 real user values in 2500 IOS
	D25_UALM	Access the user analogue or digital alarms in 2500 IOS
	D25_AI_T	Single channel analogue input block (time-delayed alarms)
	D25_DI_T	Single channel digital input block (time-delayed alarms)
	DCM_AI	Access single analogue input channel in 2500 IOS
	DCM_AO	Access single analogue output channel in 2500 IOS
	DCM_DI	Access single digital input channel in 2500 IOS
	DCM_DO	Access single digital output channel in 2500 IOS
	DCM_B8	Access up to 8 Boolean parameters in 2500 IOS
	DCM_D8	Access up to 8 double-precision integ (32-bit) parameters in 2500 IOS
	DCM_I8	Access up to 8 integer (16-bit) parameters in 2500 IOS
	DCM_R8	Access up to 8 real number (32-bit) parameters in 2500 IOS
	DCM_S8	Access up to 8 short integer (8-bit) parameters in 2500 IOS
	DCM_T8	Access up to 8 time duration (32-bit) parameters in 2500 IOS
	DCM_UI8	Access up to 8 unsigned integer (16-bit) parameters in 2500 IOS
	DCM_US8	Access up to 8 unsigned short integer (8-bit) parameters in 2500 IOS
	DCM_W8	Access up to 8 'ABCD' hex word (16-bit) parameters in 2500 IOS
	DCM_Y8	Access up to 8 'AB' hex byte (8-bit) parameters in 2500 IOS
	D2500	Provide overall view of remote 2500 IOS instrument
	D2000	Provide overall view of remote 2200 or 2400 instrument
	D25_R_UV	Access the 8 real user values in 2500 IOS
	D25_UALM	Access the user analogue or digital alarms in 2500 IOS
	DIAG	AGA8DIAG
ALH_DIAG		T800 alarm history statistics
ALINDIAG		ALIN MAC/LLC diagnostics
AMC_DIAG		Comms statistics on application master
DB_DIAG		Database diagnostics block
DDR_DIAG		T800 data recording statistics
EDB_DIAG		External database diagnostics block
EDB_TBL		External database table block
ELINDIAG		ELIN Diagnostics
EMAPDIAG		Ethernet mapping diagnostic block
PBUSDIAG		Profibus diagnostics (enhanced instruments only)
PRPDIAG		Port Resolution Protocol diagnostic block (enhanced instruments only)
ISE_DIAG		T800 options and features
NATPDIAG		Audit Trail Provider diagnostics
NATCDIAG		Audit Trail Consumer diagnostics
PMC_DIAG		Profibus diagnostics
PNL_DIAG		T800 front panel information
RSRCDIAG		Database and system resource diagnostics
SFC_DIAG		Sequence diagnostics block
XEC_DIAG		Task diagnostics

**FUNCTION BLOCKS SUPPORTED (Cont.)**

Category	Block	Function
LOGIC	AND4 COMPARE COUNT LATCH NOT OR4 PULSE XOR4	4-input AND Boolean function Indicates greater/less than/equal of two inputs UP/DOWN pulse counter with START/END count target D-type flip-flop function NOT Boolean function 4-input OR Boolean function Pulse output (monostable) function 4-input exclusive-OR Boolean function
MATHS	ACTION ADD2 DIGACT DIV2 EXPR MUL2 SUB2	Action control, with use of stored variables and elapsed time Adds two inputs Action control with use of stored digital variables and elapsed time Divides two inputs Free-format maths expression with up to four inputs Multiplies two inputs Subtracts two inputs
OPERATOR	EVENT PNL_CMD PNL_DLG PNL_MSG PNL_ACC READER	Act upon as audit trail event Panel Command Panel dialogue generation Panel message generation Access to panel system Bar code reader
ORGANISE	AREA GROUP LOGDEV LGROUP LOGGRPEX LPTDEV PGROUP	Associates GROUP blocks into an AREA Associates display and recorder channels into a GROUP Specifies and controls access to an archive medium Collects data from point blocks for archiving LGROUP extension block Printer device block Printer Group
RECORDING	DR_ALARM DR_ANCHP DR_DGCHP DR_REPRT	Filters alarms and events Data recording analog channel point block Data recording digital channel point block Report generator
SELECTOR	2OF3VOTE ALC SELECT SWITCH TAG	Selects 'best' input from three (averaging only the inputs in tolerance) Alarm collection producing a common logic O/P Outputs the highest, middle and lowest inputs, or median of 2, 3 or 4 Single-pole double-throw switch for analogue signals Specifies a user task (loop) tagname, selected from list of eight tags
SPP	SPP_CTRL SPP_DIG SPP_EXT SPP_RAMP	Monitors, schedules and controls program running Wires out digital setpoints from the setpoint program Programmer extended functions Local Ramp
TIMING	DELAY RATE_ALM RATE_LMT SEQ SEQE TIMEDATE TIMER TOTAL TOT_CON TPO	Delay for dead-time applications Up/down-rate alarm applied to PV (OP held at last non-alarm value) Rate-limiter and ramp generator Multi-segment slope/level/time, 15 O/P digitals SEQ extender Clock and calendar event Timer Totaliser (integrator) for analogue variable Totalisation connector block Time proportioning o/p block. Produces a pulse stream with mark/space ratio proportional to its (analogue) input value.

## APPENDIX B: ORDERING INFORMATION

The Visual Supervisor is preconfigured according to the ordering codes shown in the third column of table B below:

Field No.	Field Description	Field Entry	Field entry definition	
1	Processor type	386	386 processor	
		520	520 processor	
2	Archive medium	FD	Floppy disk drive fitted	
		FDUSB	Floppy disk and USB fitted. See note below	
3	Operator interface	LTK	SGVA with touch screen & keyboard *	
		LTO	SGVA with touch screen (original mechanics)	
		LTS	SGVA with touch screen (current mechanics)	
		STK	1/4VGA + touch screen & keyboard.(Keyboard and barcode reader mutually exclusive)	
		STS	1/4VGA + touchscreen	
4	Configuration port	D9	Rear panel 9-way D-type connector	
		JK	Front panel jack plug	
5	Supply voltage	24	24V dc (not 520 cpu)	
		240	90 to 264 Vac or 120 to 340V dc	
6	Battery	BATT	Battery always fitted	
7	Modbus comms standard.	422	Always EIA 422	
8	Comms option 1	–	None	
		PD9	Profibus using 9-way D-type connector	
		PRJ	Profibus using front panel jack plug	
9	Comms option 2	–	None	
		ALIN	ALIN	
		ELIN	ELIN	
10	Printer option	–	None	
		PP	Parallel printer supported	
		SP	Serial printer supported (only if D9 selected at field 4).	
11	Mounting	TPNL	Through panel	
12	Manual language	E	English	
		F	French	
		G	German	
13	Case Colour	GN	Eurotherm Green	
14	Label	0	Eurotherm Logo	
		99	Customer Logo	
		NL	No Logo	
15	Internal archive	–	Not fitted	
		16	16MB fitted	
16	Recipe Support	–	Not supported	
		RCP	Recipes supported	
17	Report support	–	Not supported	
		RPT	Reports supported	
18	Setpoint programming	SFC	Standard sequencing. Basic setpoint program	
		SPP	Standard setpoint program. Basic sequencing	
		EDB	Enhanced (160kB) database (See note below). Standard sequencing. No setpoint program.	
19	Batch Manager	–	No Batch Manager	
		BATCH	batch Manager included	
20	Barcode reader	–	Not supported	
		RKBD	Barcode/ID card reader with PS2 keyboard connector (see also Field 3 option STK)	
		Audit	Electronic records and signature. See note below.	
21	Auditor Feature	–	Not supported	
			Audit	Electronic records and signature. See note below.

Note: Available only with 520 CPU

Table B Order code information

**ORDERING INFORMATION (Cont.)**

The coding bar below shows the format in which the manufacturer prefers to receive ordering information. The codes already entered are for those items for which there are currently no alternatives.

The order can be prepared on this bar before it is submitted on a formal purchase order.

	Field 1 (Processor)	Field 2 (Archive)	Field 3 (Interface)	Field 4 (Config. port)	Field 5 (Supply)	Field 6 (Battery)	Field 7 (Modbus)
T800						BATT	422

	Field 8 (Profibus)	Field 9 (ALIN/ELIN)	Field 10 (Printer)	Field 11 (Mounting)	Field 12 (Language)	Field 13 (Colour)	Field 14 (Label)
				TPNL		GN	

	Field 15 (Int.Archive)	Field 16 (Recipe)	Field 17 (Report)	Field 18 (Setpoint)	Field 19 (Batch)	Field 20 (Barcode)	Field 21 (Auditor)

**APPENDIX C: REFERENCE**

**C1 ASCII CODES**

The following table contains representations of the characters set (UNICODE Latin-1) available on the unit.

Character	Code	Character	Code	Character	Code	Character	Code
Space	20	P	50	Đ	D0		
!	21	Q	51	Ñ	D1		
“	22	R	52	Ò	D2		
#	23	S	53	Ó	D3		
\$	24	T	54	Ô	D4		
%	25	U	55	Õ	D5		
&	26	V	56	Ö	D6		
‘	27	W	57	×	D7		
(	28	X	58	∅	D8		
)	29	Y	59	Ù	D9		
*	2A	Z	5A	Ú	DA		
+	2B	[	5B	Û	DB		
,	2C	\	5C	Ü	DC		
-	2D	]	5D	Ý	DD		
.	2E	^	5E	Þ	DE		
/	2F	_	5F	β	DF		
0	30	`	60	±	B0		
1	31	a	61	±	B1		
2	32	b	62	²	B2		
3	33	c	63	³	B3		
4	34	d	64	´	B4		
5	35	e	65	μ	B5		
6	36	f	66	¶	B6		
7	37	g	67	·	B7		
8	38	h	68	ç	B8		
9	39	i	69	¹	B9		
:	3A	j	6A	º	BA		
;	3B	k	6B	»	BB		
<	3C	l	6C	¼	BC		
=	3D	m	6D	½	BD		
>	3E	n	6E	¾	BE		
?	3F	o	6F	¿	BF		
@	40	p	70	À	C0		
A	41	q	71	Á	C1		
B	42	r	72	Â	C2		
C	43	s	73	Ã	C3		
D	44	t	74	Ä	C4		
E	45	u	75	Å	C5		
F	46	v	76	Æ	C6		
G	47	w	77	Ç	C7		
H	48	x	78	È	C8		
I	49	y	79	É	C9		
J	4A	z	7A	Ê	CA		
K	4B	{	7B	Ë	CB		
L	4C		7C	Ì	CC		
M	4D	}	7D	Í	CD		
N	4E	~	7E	Î	CE		
O	4F			Ï	CF		
				Ā	F0		
				ā	F1		
				à	F2		
				á	F3		
				â	F4		
				ã	F5		
				ä	F6		
				å	F7		
				æ	F8		
				ç	F9		
				è	FA		
				é	FB		
				ê	FC		
				ë	FD		
				ì	FE		
				í	FF		

Table C ASCII codes

**C2 GLOSSARY**

Application	An application consists of a LIN database, a User Screen page set, possibly some Setpoint Programs, Sequences and Dictionary files, plus actions, profile files and sometimes GSD files for third party devices. The application embodies the instrument's control strategy, and also determines the behaviour of its user interface.
Archiving	Archiving is the process of recording the history of a set of data values onto a removable floppy disk. The data can only be 'replayed' with an off-line tool. In this context, archiving is the same as 'logging'. See also 'Logging' and 'Log group'.
Brown-out	A brown-out is a transient power variation or partial power failure severe enough to provoke an automatic re-set in the Visual Supervisor.
Configuration	Configuration is the process of specifying the components of an application in order to determine the performance and behaviour of an instrument. Configuration is usually carried out by the manufacturer or by an OEM. See also 'Application' and 'LIN database'.
Configurator	A configurator is a user interface or software tool that provides the editing capability to configure the instrument.
Configurer	A configurer is any person who configures, or who is responsible for configuring, the instrument.
COSHH	Control of Substances Hazardous to Health
Customisation	This is the procedure by which a user can construct a Home page and sometimes other user screens.
Database	See 'LIN database'.
Dictionary files	Dictionary files hold items of text for display on the screen. Users can edit, replace or delete many of the items.
EMC	Electromagnetic compliance
Home page	The Home page is that which is displayed on power-up, and to which the display returns when no data has been entered during a specified time-out period. It can also be called up at any time. The Home page will either stand on its own or be the root page of a hierarchy of user-written pages.
LIN database	LIN database stands for Local Instrument Network database, a Eurotherm proprietary facility. For any Eurotherm instrument the LIN database is a set of software function blocks that constitutes its control strategy. The manufacturer and/or OEMs select particular function blocks from a library of LIN database function blocks to build a particular control strategy for that instrument. The LIN database of an instrument forms part of its 'application'. See 'Application'.
Log group	A log group is a set of points that are logged (archived) together onto removable media for review off-line.
Logging	Same as 'Archiving'
OEM	Original Equipment Manufacturer. I.E. any organisation that buys Visual Supervisors, incorporates them into its own products, and sells these products onto other customers under its own name.
Power outage	A total power failure for a short time
Process variable (PV)	Process Variable. Examples are temperature, pressure or valve aperture.
Ramp	A ramp is 1 a generic term for all types of programmed change in a setpoint value. Can be a 'dwell' (no change at all), a 'step' (an instantaneous change), a 'ramp at', a 'ramp to', a 'servo to setpoint' or a 'servo to PV' (all linear changes). 2 two of the types mentioned above ('ramp at' and 'ramp to').
Recording	Recording is the process of saving the history of a set of data values in the instrument's non-volatile memory. The data can survive a power outage, and can be replayed on the instrument.



**C2 GLOSSARY (Cont.)**

RFI	Radio frequency interference
SCADA	Supervisory Control and Data Acquisition
Sequences	Sequences are programs that users may have written to deal with any particular events, circumstances or requirements in the process under control.
Setpoint program (SP)	A setpoint program is a strategy to control a number of process variables such as temperature, pressure and valve apertures, over a period that can range, with the Visual Supervisor, from less than a minute to more than seven weeks.
Standard Interface	The Visual Supervisor Standard Interface is the name for the non-customised version of the user interface for the instrument. It's the default, factory-set interface, with no customised features.
Start-up strategy	This defines the way in which the process under control recovers from a partial or total power loss. The Engineer may select one of several start-up strategies.
USB	Universal Serial Bus. High speed serial communications bus.
User screen	A user screen is a page or a set of linked pages for display on the Visual Supervisor, created by a user.

C3 COSHH STATEMENT

C3.1 LITHIUM-THIONYL CHLORIDE BATTERY CELLS

Product: BACK-UP BATTERY			
Part numbers: PA234093			
<b>HAZARDOUS INGREDIENTS</b>			
Name	% Range	TLV	Toxicological data
Lithium (Li)		Not established	
Thionyl Chloride (Li-SOCl <sub>2</sub> )		1.0ppm (4.9mg/m <sup>3</sup> )	
Aluminium Chloride (AlCl <sub>3</sub> )		2mg/m <sup>3</sup>	
Lithium Chloride		Not established	
<b>PHYSICAL DATA</b>			
Boiling point	Thionyl Chloride: 77°C	Specific gravity	Thionyl Chloride: 1.63
Vapour pressure	Thionyl Chloride: 92mm at 20°C	Solubility in water	Thionyl Chloride decomposes violently on contact with water.
Odour	Thionyl Chloride: Pungent, irritant	Colour	Thionyl Chloride: colourless to pale yellow
<b>FIRE AND EXPLOSION DATA</b>			
Flash point (deg C) (Method used)	Not applicable		FLAMMABLE LIMIT
Extinguishing media	Lith-X powder, Class D fire extinguisher, Dry lithium chloride or carbon powder, Pyrene G-1.	LEL	UEL
Special fire-fighting procedures	WATER MUST NOT BE USED. Do not use moist sand, CO <sub>2</sub> , or Class A, B, C or soda ash extinguisher. A Self Contained Breathing Apparatus (SCABA) or Air Purifying Respirator (APR) must be worn.		
Unusual fire and explosion hazards	Cells may leak, vent or explode. If a bright, white flame is present, lithium content is present and on fire. Use one of the extinguishing media recommended above.		
<b>HEALTH HAZARD DATA</b>			
Threshold limit value	Not applicable		
LD 50 Oral	Not applicable	LD 50 Dermal	Not applicable
Skin and eye irritation	Not applicable in normal use. Leakage material is corrosive.		
Over-exposure effects	There are no effects in normal use. If leakage has occurred, vapours are very irritating to skin, eyes and mucous membranes. Inhalation may lead to pulmonary oedema and overexposure may lead to non-fibrotic lung injury.		
Chemical nature	See above. There are no risks in normal use.		
<b>FIRST AID PROCEDURES</b>			
Eyes	Flush with running cold water for at least 15 minutes. Hold eyelids apart. Seek immediate medical attention mentioning thionyl chloride. Contact results in acidic burns.		
Skin	Rinse with copious quantities of running cold water. Avoid hot water. Do not rub skin. If burns develop, seek medical attention, mentioning thionyl chloride. Contact results in acidic burns.		
Ingestion	Seek immediate medical attention. If person is conscious, supply copious amounts of milk or water. Do not induce vomiting. Do not attempt to administer anything by mouth to an unconscious person.		
Inhalation	May result in pulmonary oedema. Remove to fresh air. If breathing is difficult, administer oxygen. If breathing has stopped, administer artificial respiration.		
<b>REACTIVITY DATA</b>			
STABILITY			Conditions to avoid
Stable	Yes	Unstable	Do not short circuit, recharge, over discharge (i.e to below 0.0 Volts), puncture, crush or expose to temperatures above 120°C. do not store in high humidity environments for extended periods.
Hazardous decomposition products	Decomposes in water to give Sulphur Dioxide (SO <sub>2</sub> ), Hydrogen Chloride (HCl) and strongly acidic wastewater.		
Hazardous polymerisation	Will not occur		
<b>SPILL OR LEAK PROCEDURES</b>			
Internal contents are extremely hazardous. Leaking Fluid is corrosive. The cell may explode at high temperatures. Do not breath vapours, or touch liquids with bare hands (see first aid procedures above). Evacuate area. If possible a trained person, wearing suitable breathing apparatus should attempt to stop or contain the leak with soda lime, or baking soda (sodium bicarbonate NaHCO <sub>3</sub> ). Once contained, the leaking battery and soda lime/baking soda should be sealed in a polythene bag and disposed of as Hazardous waste			
<b>Contact should be avoided</b>			
<b>DISPOSAL</b>			
Batteries must be disposed of according to current local regulations for Lithium thionyl chloride batteries. They may not be disposed of as normal waste.			
<b>SPECIAL PROTECTION INFORMATION</b>			
Respiratory	Not applicable in normal use		
Ventilation	Not applicable in normal use		
Protective clothing	Not applicable in normal use		
Other			

## INDEX

**A**

Abort Program .....	3 - 8
Access	
By user ID .....	2 - 16
Control .....	4 - 27
Display pane .....	2 - 13
to configuration .....	2 - 13
Access levels .....	8 - 11
Account Properties .....	4 - 33
Acknowledge	
Alarms .....	3 - 18
Messages .....	3 - 18
Action Disabled .....	8 - 11
Adding new users .....	4 - 33
Admin only .....	4 - 32
Agent types .....	5 - 47
Alarm	
Acknowledgement .....	3 - 18
Active/Cleared/Ack'ed .....	8 - 2
Display pane .....	2 - 10
Forms .....	5 - 55
History	
Archiving .....	3 - 19
Display, adding notes to .....	3 - 18
Page .....	3 - 16
Time display .....	3 - 16
Two-line display .....	2 - 12, 3 - 17
Indication .....	3 - 21
Names .....	5 - 49
Responding to .....	3 - 16
Summary .....	3 - 19
Alarm/event customisation .....	5 - 27
APP MGR .....	4 - 19
APP SUM .....	4 - 19
Application	
Data .....	4 - 47
Cloning .....	4 - 47
Importing .....	4 - 47
Saving .....	4 - 21
Deletion .....	4 - 22
Diagnostics .....	4 - 23
Loading and Running .....	4 - 22
Management .....	4 - 18
Manager page .....	4 - 19
Reloading .....	4 - 52
Selection .....	4 - 22
Stopping .....	4 - 20, 4 - 50
Summary page .....	4 - 19
Unloading .....	4 - 21
APPLN .....	4 - 19
Archiving	
Alarm history .....	3 - 19
Interval .....	4 - 16
ARCNET connectors .....	1 - 11
Area display .....	3 - 21
Archive	
File transfer .....	9 - 1
Attributes column .....	4 - 32

**A (Cont.)**

Audit Trail .....	8 - 1
Filtering .....	8 - 2
Auto create .....	2 - 17

**B**

Bar code reader connection .....	1 - 12
Bar code reader files .....	5 - 64
Bargraph display mode	
Horizontal bars .....	3 - 29
Vertical bars .....	3 - 28
Batch	
Abort .....	3 - 38
Create .....	3 - 39
Customising .....	3 - 37
Hold .....	3 - 38
Initiation .....	3 - 38
Load .....	3 - 37
Monitoring .....	3 - 38
Recipe selection .....	3 - 37
Batch Dictionary .....	5 - 61
Batch Files .....	5 - 62
Batch Phases .....	5 - 63
Block	
Creation .....	4 - 25
Events .....	8 - 2
Value Change .....	8 - 2
Brightness of display .....	4 - 44
Brown-out .....	4 - 39
Time .....	4 - 40

**C**

Cached alarms .....	8 - 2
Capture (recipe) .....	4 - 54
Changing	
Date/Time .....	4 - 41
Date/Time format .....	4 - 43
from Access level to User ID .....	4 - 30
Hot/Cold Start settings .....	4 - 40
Language .....	4 - 43
Setpoint value .....	4 - 6
Start-up Strategy values .....	4 - 40
Clock Setup page .....	4 - 41
Cloning .....	4 - 46
All data .....	4 - 49
Application data .....	4 - 47
Instrument data .....	4 - 48
System data .....	4 - 48
Cold-Start .....	4 - 40
Commission level access .....	4 - 28
COMMS .....	4 - 35
Communications .....	4 - 35
Available protocols .....	4 - 37
Parameter setting .....	4 - 35
Profiles .....	4 - 47
Selecting EIA422 or EIA485	
Large frame units .....	1 - 23
Small frame units .....	1 - 22
Specification .....	A - 3

**C (Cont.)**

Config. sizes and limits (Modbus) .....	6 - 5
Confirm only .....	8 - 11
Connector	
ARCNET .....	1 - 11
Printer .....	1 - 12
Profibus .....	1 - 11
Consumer selection .....	8 - 2
Control Database .....	4 - 47
Creation of Blocks .....	4 - 25
Credit card scanner connection .....	1 - 12
Cursor .....	3 - 30, 3 - 32
Customisation of Panel .....	5 - 26
Customising .....	5 - 1

**D**

Daily	
File names .....	4 - 16
Files .....	3 - 11
Data format .....	7 - 10
Data integrity .....	3 - 15
Database	
Automatic creation of .....	2 - 17
Names .....	5 - 2, 5 - 49
Date	
Format	
Selection .....	4 - 42
Daylight saving .....	4 - 41
DC supply voltage	
Fuse replacement .....	1 - 20-1 - 25
DCM, Available blocks .....	7 - 1
DELETE .....	4 - 18, 4 - 22
Deleting	
Files from disk .....	3 - 14
Segments .....	4 - 9
User IDs .....	4 - 32
Deploy .....	8 - 7
Diagnostics (Modbus Registers) .....	6 - 7
DIAGS .....	4 - 23
Dictionary	
Error text .....	5 - 28
Event text .....	5 - 30
List of .....	5 - 1
Programmer text .....	5 - 35
System text .....	5 - 2-5 - 69
User text .....	5 - 35
Dictionary text .....	5 - 66
Disable	
User ID .....	4 - 32, 8 - 4
Disk .....	3 - 12
Access .....	2 - 16
Display Brightness .....	4 - 44
Display mode	
Bargraph	
Horizontal .....	3 - 29
Vertical .....	3 - 28
Faceplate .....	3 - 28
Horizontal with faceplate .....	3 - 31
Numeric .....	3 - 28
Vertical fullwidth .....	3 - 31
Vertical with faceplate .....	3 - 29
Dwell .....	4 - 4

**E**

Editing	
Alarm names .....	5 - 49
Error messages .....	5 - 29
Event messages .....	5 - 34
Function block names .....	5 - 49
Recipes .....	4 - 52
Electrical installation .....	1 - 8
Electronic signatures .....	8 - 10
ELIN .....	4 - 38
Empty Strings .....	5 - 65
End action .....	4 - 12
Engineer level access .....	4 - 28
Enumerations .....	5 - 50, 5 - 67
Error	
Message editing .....	5 - 29
Text dictionary .....	5 - 28-5 - 69
ETHERNET .....	4 - 38
Event log .....	3 - 20
Event message	
Editing .....	5 - 34
New language .....	5 - 34
Event priorities .....	5 - 34
Event text dictionary .....	5 - 30
Exception responses .....	6 - 9
Exporting application data .....	4 - 47

**F**

Faceplate display mode .....	3 - 28
File	
Copy and delete .....	4 - 51
Header .....	5 - 56
Management .....	3 - 14
Manager .....	4 - 50
Type .....	4 - 16
Text, Hourly, Daily .....	3 - 11
File Header .....	5 - 62
File system .....	9 - 1
Files with capture variables .....	5 - 58
Files with Monitor Variables .....	5 - 59
Floppy disk .....	2 - 16, 3 - 12
Form files .....	5 - 51
Formatting attributes .....	5 - 68
Forms .....	4 - 47
FTP .....	4 - 32, 9 - 1
Logon .....	9 - 1
Timeout .....	9 - 1
Function block	
Detail display .....	4 - 27
Display order .....	4 - 26
Faceplate .....	3 - 23
AI2 module .....	3 - 23
DI4 module .....	3 - 24
Loop .....	3 - 26
PID .....	3 - 27
Ramp .....	3 - 25
Manager .....	4 - 23
Names .....	5 - 49
Fuse replacement	
Large Frame .....	1 - 21
Small Frame .....	1 - 20

**G**

Glossary ..... C - 2  
 Group  
     Display ..... 3 - 21  
 GSD files ..... 7 - 10

**H**

Holdback properties ..... 4 - 9  
 Home page declaration ..... 5 - 46  
 Horizontal display with faceplates ..... 3 - 31  
 Hot start ..... 4 - 40  
     Time ..... 4 - 40  
 Hourly  
     File names ..... 4 - 16  
     Files ..... 3 - 11

**I**

Id value ..... 3 - 2  
 Identity ..... 8 - 4  
 Importing application data ..... 4 - 47  
 Initial page declaration ..... 5 - 46  
 Inserting a segment ..... 4 - 8  
 Installation  
     Electrical ..... 1 - 8  
     Mechanical ..... 1 - 4  
 Instrument  
     Data cloning ..... 4 - 48  
     Setting up ..... 4 - 35  
 Intellectual Property Right Protection ..... 4 - 55  
 IPRP ..... 4 - 55  
 Iteration, number of ..... 3 - 6  
 Iterations, Changing default number ..... 4 - 13

**J**

JBUS gateway ..... 6 - 1

**L**

Labelling symbols ..... 1 - 1  
 Language selection ..... 4 - 42  
 LD+RUN ..... 4 - 18, 4 - 22  
 LIN database variables ..... 5 - 66  
 Lin Mode ..... 8 - 2  
 Linear Bus layout ..... 7 - 6  
 Literal text ..... 5 - 65  
 LOAD ..... 3 - 37, 4 - 18, 4 - 22  
 Load/Save program Id setting ..... 3 - 2  
 Locked ..... 4 - 28  
 Log on ..... 2 - 13  
 Logging ..... 3 - 11  
     Configuration ..... 4 - 16  
     Data groups ..... 4 - 15  
     Display pane ..... 2 - 13  
     File type ..... 4 - 16  
     Initiation ..... 4 - 15  
     Interval ..... 4 - 16  
     Name types ..... 4 - 16  
     To disk  
         Example ..... 3 - 12

**M**

MAINT Key ..... 8 - 6  
 MAINT key ..... 4 - 34  
 Maintenance (security access) ..... 8 - 6  
 Max. Login attempts ..... 8 - 5  
 Mechanical installation ..... 1 - 4  
 Message  
     Active/Cleared/Ack'ed ..... 8 - 2  
     Display/Acknowledge ..... 3 - 18  
     Indicator ..... 2 - 11  
 Min alarm/event priority ..... 8 - 2  
 Min. ID length ..... 8 - 5  
 Min. Password length ..... 8 - 5  
 Modbus  
     Address ..... 6 - 9  
     DCM ..... 6 - 11–6 - 14  
     Diagnostic function codes ..... 6 - 8  
     Function codes ..... 6 - 2  
     Gateway overview ..... 6 - 1  
     Implementation ..... 6 - 9  
     Interface performance ..... 6 - 10  
 MODBUS S/M ..... 4 - 23  
 Monitoring a program ..... 3 - 9, 3 - 10

**N**

Name type ..... 4 - 16  
 Network  
     Audit Trail ..... 8 - 1  
     FB manager key ..... 4 - 25  
 New user ID ..... 4 - 33, 8 - 5  
 No Confirmation ..... 8 - 11  
 No. of characters ..... 5 - 68  
 No. of decimal places ..... 5 - 68  
 Node number configuration ..... 8 - 8  
 Numeric display mode ..... 3 - 28

**O**

Operator access level ..... 4 - 28  
 Operator note ..... 8 - 2  
 Order codes ..... B - 1

**P**

Pan control ..... 3 - 30, 3 - 32  
 Panel agent declaration ..... 5 - 44  
 Panel customisation ..... 5 - 26  
 Panel driver declaration ..... 5 - 45  
 Panel navigation ..... 5 - 2, 5 - 36–5 - 69  
 Panel navigation file ..... 5 - 36  
 Password  
     Editing ..... 4 - 27  
     Expiry ..... 8 - 5  
 Printer connector ..... 1 - 12  
 Profibus. See Chapter 7  
     Connectors ..... 1 - 11  
     GSD files ..... 7 - 10  
     Installation ..... 7 - 5–7 - 10  
     Linear Bus layout ..... 7 - 6  
     Maximum no. of nodes ..... 7 - 1  
     Operation ..... 7 - 9  
     Trouble shooting ..... 7 - 8

**P (Cont.)**

Program	
Abort .....	3 - 8
Changing the name of .....	4 - 11
Creation .....	4 - 1
Display pane .....	2 - 8
Editing .....	4 - 1
Editor, Access to .....	4 - 3
Hold .....	3 - 8
Iterations .....	3 - 6
Monitoring a .....	3 - 9
Properties .....	4 - 11
Running	
From a point .....	3 - 3
From date .....	3 - 5
Running more than one .....	3 - 2
Scheduling .....	3 - 4
Programmer	
Text dictionary .....	5 - 35
Programs/Recipes .....	4 - 47
PROPERTIES key .....	4 - 33
Protocols (communications) .....	4 - 37

**Q**

Question mark .....	2 - 11
---------------------	--------

**R**

Ramp .....	4 - 4
Ramp at .....	4 - 4
Ramp to .....	4 - 4
Type changing .....	4 - 4
Rate units selection .....	4 - 12
Recipe	
Adding .....	4 - 53
Capture .....	4 - 54
Downloading .....	3 - 33
Files .....	5 - 56
Management .....	4 - 52
Monitoring .....	3 - 35
Recipe dictionary .....	5 - 60
Reference column .....	4 - 32
Relay specification .....	A - 2
Remote Access .....	9 - 1
Report forms .....	5 - 51
Retire User ID .....	8 - 4
Revision .....	8 - 7
Root page declaration .....	5 - 46
Running multiple programs .....	3 - 2

**S**

Safety notes .....	1 - 1
SAVE .....	4 - 18, 4 - 21
Scanner task (Modbus) .....	6 - 3
Scheduling a program .....	3 - 4
Screen saver configuration .....	4 - 44
Security access page .....	8 - 3

**S (Cont.)**

Segment	
Changing duration of .....	4 - 8
Changing the identifier .....	4 - 7
Deletion of .....	4 - 9
Inserting a .....	4 - 8
Skip .....	3 - 7
Timing display .....	4 - 14
Servo to .....	4 - 4
Setpoint	
Editing .....	4 - 4
Name	
Saving .....	4 - 13
Setting and re-setting passwords .....	4 - 28
SETUP .....	4 - 35
SFCs .....	4 - 47
Sign & Authorise .....	8 - 11
Signature .....	8 - 11
Signature configuration .....	8 - 11
Specification	
Communications .....	A - 3
General .....	A - 1
Relay .....	A - 2
START .....	4 - 18, 4 - 22
Startup Strategy .....	4 - 39
STATS key .....	4 - 34, 8 - 6
Step .....	4 - 4
STOP .....	4 - 18, 4 - 20
Symbols used on labels .....	1 - 1
SYSTEM .....	4 - 19, 4 - 35
System	
Data	
Cloning .....	4 - 48
Importing/exporting .....	4 - 48
Event .....	8 - 2
Summary Page .....	2 - 5
Text	
Editing .....	5 - 3
New languages .....	5 - 3
System variables .....	5 - 67

**T**

Text files .....	3 - 11
Names .....	4 - 16
The dictionary .....	5 - 3
Time display in Alarm history .....	3 - 16
Time format .....	4 - 43
Timeout	
Display brightness .....	4 - 44
Page Display .....	4 - 44
Pop-up menu .....	4 - 44
Timing information (Modbus) .....	6 - 3
Title line .....	5 - 57
Trend displays .....	3 - 21
Trend review .....	3 - 30, 3 - 32
Trouble shooting .....	7 - 8
Two-line display	
Event log .....	3 - 20

**U**

UNLOAD .....	4 - 18, 4 - 21
Unpacking .....	1 - 3
User	
Attributes .....	8 - 4
ID access .....	2 - 16
ID control .....	8 - 3
ID password system .....	4 - 30
Name .....	8 - 4
Pages .....	4 - 47
Properties .....	8 - 5
Text dictionary .....	5 - 35
Timeout .....	8 - 5
User actions .....	5 - 69
UYF files .....	5 - 52
UYP files .....	7 - 3
UYR files .....	5 - 56
UYT files .....	5 - 55

**V**

Variable lines (Recipe files) .....	5 - 57
Vertical display mode	
Full width .....	3 - 31
With faceplate .....	3 - 29
View only .....	4 - 32

**W**

Writable dictionary .....	5 - 59
---------------------------	--------

**Z**

Zoom control .....	3 - 30, 3 - 32
--------------------	----------------

This page is deliberately left blank



# Inter-Company sales and service locations

## Australia

Eurotherm Pty. Limited.  
Unit 10.  
40 Brookhollow Avenue,  
Baulkham Hills,  
NSW 2153

Telephone: 61 2 9634 8444  
Fax: 61 2 9634 8555  
e-mail: [eurotherm@eurotherm.com.au](mailto:eurotherm@eurotherm.com.au)  
<http://www.eurotherm.com.au>

## Austria

Eurotherm GmbH  
Geiereckstraße 18/1,  
A1110 Wien,

Telephone: 43 1 798 76 01  
Fax: 43 1 798 76 05  
e-mail: [eurotherm@eurotherm.at](mailto:eurotherm@eurotherm.at)  
<http://www.eurotherm.at>

## Belgium and Luxembourg

Eurotherm S.A./N.V.  
Rue du Val-Notre-Dame 384,  
4520 Moha (Huy)  
Belgium

Telephone: 32 (0) 85 274080  
Fax: 32 (0) 85 274081  
e-mail: [sales@eurotherm-belgium.be](mailto:sales@eurotherm-belgium.be)  
<http://www.eurotherm.nl>

## Denmark

Eurotherm Danmark A/S  
Finsensvej 86,  
DK 2000 Fredriksberg,

Telephone: +45 (38) 871622  
Fax: +45 (38) 872124  
e-mail: [salesdk@eurotherm.se](mailto:salesdk@eurotherm.se)

## Finland

Eurotherm Finland,  
Aurakatu 12A,  
FIN-20100 Turku

Telephone: 358 2 25 06 030  
Fax: 358 2 25 03 201

## France

Eurotherm Automation Division Chessell  
Parc d'Affaires,  
6, Chemin des Joncs,  
BP55

F - 69574 Dardilly, CEDEX  
Telephone: 33 0 4 78 66 55 20  
Fax: 33 0 4 78 66 55 35  
e-mail: [chessell@automation.eurotherm.co.uk](mailto:chessell@automation.eurotherm.co.uk)  
<http://www.eurotherm-chessell.fr>

## Germany

Eurotherm Deutschland GmbH  
Ottostraße 1,  
65549 Limburg

Tel: +49 (0) 64 31/2 98 - 0  
Fax: +49 (0) 64 31/2 98 - 1 19  
e-mail: [info@regler.eurotherm.co.uk](mailto:info@regler.eurotherm.co.uk)  
<http://www.eurotherm-deutschland.de>

## Great Britain

Eurotherm Limited,  
Faraday Close,  
Worthing,  
West Sussex BN13 3PL

Telephone: +44 (0)1903 695888  
Fax: +44 (0)1903 695666  
e-mail: [Sales@recorders.eurotherm.co.uk](mailto:Sales@recorders.eurotherm.co.uk)  
or: [Support@recorders.eurotherm.co.uk](mailto:Support@recorders.eurotherm.co.uk)  
<http://www.eurotherm.co.uk>

## Hong Kong

Eurotherm Limited,  
Unit D, 18/F Gee Chang Hong Centre,  
65, Wong Chuk Hang Road,  
Aberdeen.

Telephone: 852 2873 3826  
Fax: 852 2870 0148  
e-mail: [eurotherm@eurotherm.com.hk](mailto:eurotherm@eurotherm.com.hk)

## India

Eurotherm DEL India Limited,  
152, Developed Plots Estate,  
Perungudi,  
Chennai 600 096,

Telephone: 91 44 4961129  
Fax: 91 44 4961831  
e-mail: [info@eurothermdel.com](mailto:info@eurothermdel.com)  
<http://www.eurothermdel.com>

## Italy

Eurotherm SpA,  
Via XXIV Maggio,  
I-22070 Guanzate,  
Como.

Telephone: 39 031 975111  
Fax: 39 031 977512  
e-mail: [info@eurotherm.it](mailto:info@eurotherm.it)  
<http://www.eurotherm.it>

## Japan

Densei Lambda K.K.,  
Strategic Products Dept.  
5F Nissay Aroma Square,  
37-1, Kamata, 5-Chome,  
Ohta-ku,  
Tokyo 144-8721

Telephone: 81 3 5714 0620  
Fax: 81 3 5714 0621  
e-mail (Sales): [k.iwama@densai-lambda.com](mailto:k.iwama@densai-lambda.com)  
e-mail (Technical): [v.rendle@densai-lambda.com](mailto:v.rendle@densai-lambda.com)  
<http://www.densei-lambda.com>

## Korea

Eurotherm Korea Limited,  
J- Building  
402-3  
Poongnab-Dong,  
Songpa-Ku  
Seoul, 138-040

Telephone: 82 2 478 8507  
Fax: 82 2 488 8508

## Netherlands

Eurotherm BV,  
Genielaan 4,  
2404CH Alphen aan den Rijn,  
The Netherlands

Telephone: 31 172 411 752  
Fax: 31 172 417 260  
e-mail: [Sales@eurotherm.nl](mailto:Sales@eurotherm.nl)  
<http://www.eurotherm.nl>

## Norway

Eurotherm A/S,  
Vollsveien 13D  
1366 Lysaker,  
Postboks 227  
NO-1326 Lysaker  
Norway,

Telephone: 47 67 592170  
Fax: 47 67 118301  
<http://www.eurotherm.no>

## Spain

Eurotherm España SA,  
Pol. Ind. De Alcobendas,  
Calle de la Granja 74,  
28108 Alcobendas,  
Madrid.

Telephone: 34 91 661 60 01  
Fax: 34 91 661 90 93  
<http://www.eurotherm.es>

## Sweden

Eurotherm AB,  
Lundavägen 143,  
S-21224 Malmö.

Telephone: 46 40 38 45 00  
Fax: 46 40 38 45 45  
e-mail: [info@eurotherm.se](mailto:info@eurotherm.se)  
<http://www.eurotherm.se>

## Switzerland

Eurotherm Produkte (Schweiz) AG,  
Schwerzistraße, 20,  
CH-8807 Freienbach.

Telephone: 41 55 415 44 00  
Fax: 41 55 415 44 15  
e-mail: [epsag@eurotherm.ch](mailto:epsag@eurotherm.ch)  
<http://www.eurotherm.ch>

## United States of America

Eurotherm Recorders Inc.  
741-F Miller Drive  
Leesburg  
VA 20175-8993

Telephone: 1 703 669 1342  
Fax: 1 703 669 1307  
e-mail (Sales): [sales@chessell.com](mailto:sales@chessell.com)  
e-mail (Technical): [support@chessell.com](mailto:support@chessell.com)  
<http://www.chessell.com>



invensys  
**EUROTHERM**

EUROTHERM LIMITED

Faraday Close, Durrington, Worthing, West Sussex, BN13 3PL  
Telephone: 01903 695888 Facsimile: 01903 695666  
e-mail: [info@eurotherm.co.uk](mailto:info@eurotherm.co.uk)  
Website: <http://www.eurotherm.co.uk>





