

Pioneer

PD-F507 PD-F407

FILE-TYPE COMPACT DISC PLAYER
檔案式雷射唱碟唱機

Operating Instructions
使用說明書

COMPACT
disc
DIGITAL AUDIO

CDFILE
25-DISC

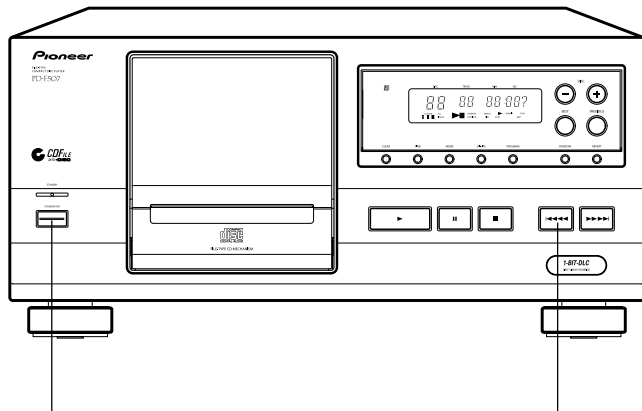

Set the line voltage selector switch to the position of your area before connecting the power cord. (Refer to page 2.)

English

請在連接電源線之前，將線路電壓選擇開關設定至貴地所用電壓位置。(參見16頁。)

中國語

POWER ON DEMO display

POWER ON DEMO display mode allows you to see variations of the display. To enter the POWER ON DEMO display mode, press STANDBY/ON and then **◀◀◀** within 1 second after turning on the power.

To cancel the POWER ON DEMO display mode, press any button.

電源打開演示 (POWER ON DEMO) 顯示

電源打開演示 (POWER ON DEMO) 顯示模式可讓您看到各式各樣的顯示。按下電源 (STANDBY/ON) 按鍵後的一秒鐘之內，再按下 **◀◀◀** 按鍵，便可進入電源打開演示 (POWER ON DEMO) 顯示模式。

如果要解除電源打開演示 (POWER ON DEMO) 顯示模式，只需按任意按鍵即可。

Thank you for buying this Pioneer product. Please read through these operating instructions so you will know how to operate your model properly. After you have finished reading the instructions, put them away in a safe place for future reference. In some countries or regions, the shape of the power plug and power outlet may sometimes differ from that shown in the explanatory drawings. However, the method of connecting and operating the unit is the same.

- This player is for consumer use. If the player is used in a business (for example, used for a long period at a restaurant), the player will not be covered under warranty.
 - CD Video, VIDEO CD, CD graphics, DVD and CD-ROM discs cannot be played with this player.
- K041_En

IMPORTANT



The lightning flash with arrowhead symbol, within an equilateral triangle, is intended to alert the user to the presence of uninsulated "dangerous voltage" within the product's enclosure that may be of sufficient magnitude to constitute a risk of electric shock to persons.

CAUTION

**RISK OF ELECTRIC SHOCK
DO NOT OPEN**

CAUTION:
TO PREVENT THE RISK OF ELECTRIC SHOCK, DO NOT REMOVE COVER (OR BACK). NO USER-SERVICEABLE PARTS INSIDE. REFER SERVICING TO QUALIFIED SERVICE PERSONNEL.



The exclamation point within an equilateral triangle is intended to alert the user to the presence of important operating and maintenance (servicing) instructions in the literature accompanying the appliance.

D3-4-2-1-1_En

CAUTION

This product contains a laser diode of higher class than 1. To ensure continued safety, do not remove any covers or attempt to gain access to the inside of the product.
Refer all servicing to qualified personnel.
The following caution label appears on your unit.



D3-4-2-1-8_En

CAUTION : USE OF CONTROLS OR ADJUSTMENTS OR PERFORMANCE OF PROCEDURES OTHER THAN THOSE SPECIFIED HEREIN MAY RESULT IN HAZARDOUS RADIATION EXPOSURE.

CAUTION : THE USE OF OPTICAL INSTRUMENTS WITH THIS PRODUCT WILL INCREASE EYE HAZARD. D6-8-2-1_En

WARNING: Slot and openings in the cabinet are provided for ventilation and to ensure reliable operation of the product and to protect it from overheating, to prevent fire hazard, the openings should never be blocked and covered with items, such as newspapers, table-cloths, curtains, etc. Also do not put the apparatus on the thick carpet, bed, sofa, or fabric having a thick pile. D3-4-2-1-7b_En

WARNING: The apparatus is not waterproofs, to prevent fire or shocks hazard, do not expose this apparatus to rain or moisture and do not put any water source near this apparatus, such as vase, flower pot, cosmetics container and medicine bottle etc. D3-4-2-1-3_En

WARNING:
BEFORE PLUGGING IN THE UNIT FOR THE FIRST TIME, READ THE FOLLOWING SECTION CAREFULLY.
The voltage of the available power supply differs according to country or region. Be sure that the power supply voltage of the area where this unit will be used meets the required voltage (e.g., 230V or 120V) written on the rear panel. D3-4-2-1-4_En

Voltage selector

You can find the voltage selector switch on the rear panel of multi-voltage models.

The factory setting for the voltage selector is 220-240V. Please set it to the correct voltage for your country or region.

• **For Taiwan, please set to 110-127V before using.**

Before changing the voltage, disconnect the AC power cord. Use a medium size screwdriver to change the voltage selector switch.

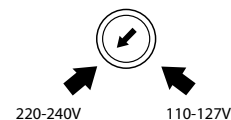

D3-4-2-1-5_En

NOTE: This equipment has been tested and found to comply with the limits for a Class B digital device, pursuant to Part 15 of the FCC Rules. These limits are designed to provide reasonable protection against harmful interference in a residential installation. This equipment generates, uses, and can radiate radio frequency energy and, if not installed and used in accordance with the instructions, may cause harmful interference to radio communications. However, there is no guarantee that interference will not occur in a particular installation. If this equipment does cause harmful interference to radio or television reception, which can be determined by turning the equipment off and on, the user is encouraged to try to correct the interference by one or more of the following measures:

- Reorient or relocate the receiving antenna.
- Increase the separation between the equipment and receiver.
- Connect the equipment into an outlet on a circuit different from that to which the receiver is connected.
- Consult the dealer or an experienced radio/TV technician for help.

D8-10-1-2_En

Information to User

Alteration or modifications carried out without appropriate authorization may invalidate the user's right to operate the equipment.

D8-10-2_En

CAUTION: This product satisfies FCC regulations when shielded cables and connectors are used to connect the unit to other equipment. To prevent electromagnetic interference with electric appliances such as radios and televisions, use shielded cables and connectors for connections.

D8-10-3a_En

The STANDBY/ON switch is secondary connected and therefore, does not separate the unit from mains power in STANDBY position. Therefore install the unit suitable places easy to disconnect the MAINS plug in case of the accident. The MAINS plug of unit should be unplugged from the wall socket when left unused for a long period of time.

D3-4-2-2a_En

WARNING: No naked flame sources, such as lighted candle, should be placed on the apparatus. If naked flame sources accidentally fall down, fire spread over the apparatus then may cause fire.

D3-4-2-1-7a_En

Operating Environment

Operating environment temperature and humidity:
 +5 °C – +35 °C (+41 °F – +95 °F); less than 85 %RH
 (cooling vents not blocked)

Do not install in the following locations

- Location exposed to direct sunlight or strong artificial light
- Location exposed to high humidity, or poorly ventilated location

D3-4-2-1-7c_En

CONTENTS

BEFORE YOU USE THE PLAYER	4	To start playback from a specific disc	11
CAUTIONS REGARDING HANDLING	5	To play a track you want to hear	11
CONNECTIONS	6	To repeat playback	11
NAMES OF PARTS	7	To playback tracks/discs at random	11
HOW TO LOAD THE DISCS	8	To program tracks/discs in a desired order	12
<hr/>		To store your favorite tracks	13
BASIC OPERATIONS		To find out which discs you've listened to recently	13
To listen in order from the first track	9	To scan quickly through tracks on a disc	14
To select the disc and track	9	To use the TIME button	14
To select a play mode	9	<hr/>	
<hr/>		TROUBLESHOOTING	15
VARIOUS OPERATIONS		SPECIFICATIONS	15
To program and play only the discs you want to hear ...	10		

BEFORE YOU USE THE PLAYER

HERE'S WHAT YOU CAN DO!

Up to 25 CDs can be registered by classifying them into 3 categories (CUSTOM). P. 10

For example, if you register your own discs in CUSTOM I, your mother's discs in CUSTOM II and your father's discs in CUSTOM III or if you select three kinds of music genres or artists and register them in the three CUSTOM banks, you can play all of the discs classified under one of the three CUSTOM banks. Addition of discs to already-registered discs is also possible. Each of the three CUSTOM banks can register up to 25 discs.

Immediately access and play your favorite tracks from among the 25 discs loaded in the player. P. 13

The Best Selection Memory function lets you store and play favorite tracks with the touch of a single button (up to 15 tracks).

Easy access to the disc(s) you've listened to recently. P. 13

The Previous Disc Scan function recalls the last disc you played and then moves one by one through the previously played discs (auto-memory of last 15 discs played).

CONFIRM SUPPLIED ACCESSORIES

Remote control unit x 1 (PD-F507 only)

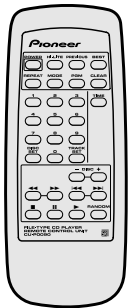

Output cable x 1

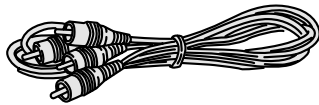

SizeAA/R6P dry cell batteries x 2 (PD-F507 only)

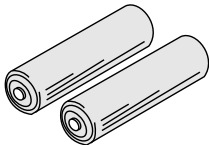

Control cable x 1 (PD-F407 only)

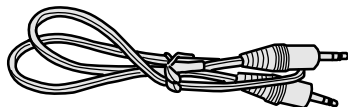

CD liner notes file x 1

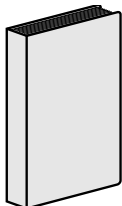

Index label sheet x 1

1	2	3	4	5
6	7	8	9	10
11	12	13	14	15
16	17	18	19	20
21	22	23	24	25

- Please use the index label sheet with the CD liner notes file.

PUT BATTERIES INTO THE REMOTE CONTROL UNIT (PD-F507 only)

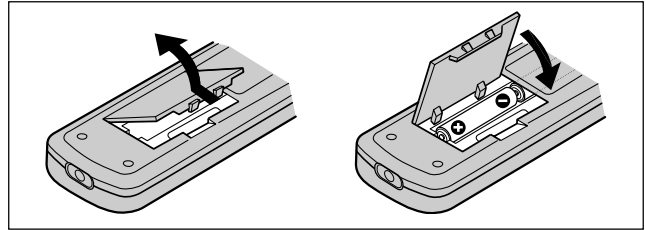

Open the lid of the battery compartment on the rear of the remote control unit, and insert the batteries, taking care to align the ⊕ and ⊖ polarities correctly.

NOTES:

- In order to prevent battery leakage, remove the batteries when not using the remote control unit for an extended period (one month or more). If leakage occurs, carefully wipe away any battery fluid inside the compartment, and replace the batteries with new ones.
- Do not allow books or other objects to rest on top of the remote control unit, since the buttons may be depressed, causing faster exhaustion of the batteries.

Incorrect use of batteries may cause leakage or rupture. Always be sure to follow these guidelines:

- Always insert batteries into the battery compartment correctly matching the positive ⊕ and negative ⊖ polarities, as shown by the display inside the compartment.
- Never mix new and used batteries.
- Batteries of the same size may have different voltages, depending on brand. Do not mix different brands of batteries.
- When disposing of used batteries, please comply with governmental regulations or environmental public instruction's rules that apply in your country/area.

REMOTE CONTROL OPERATIONS (PD-F507 only)

When operating the remote control unit, point the unit's infrared signal transmitter at the remote control receiver (Remote Sensor) on the front panel of the player. The remote control unit can be used within a range of about 7 meters from the remote sensor, and within angles of up to about 30 degrees.

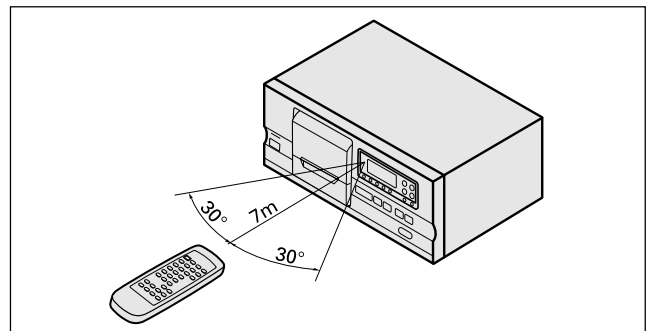

NOTE:

If the remote control sensor window is in a position where it receives strong light such as sunlight or fluorescent light, control may not be possible.

CAUTIONS REGARDING HANDLING

Location

Install the unit in a well-ventilated location where it will not be exposed to high temperatures or humidity.

Do not install the unit in a location which is exposed to direct rays of the sun, or near hot appliances or radiators. Excessive heat can adversely affect the cabinet and internal components. Installation of the unit in a damp or dusty environment may also result in a malfunction or an accident. (Avoid installation near cookers etc., where the unit may be exposed to oily smoke, steam or heat.)

Do not install the unit on a tottered stand, nor in an unstable or inclined surface.



Precautions regarding installation

- Placing and using the compact disc player for long periods on heat-generating sources such as amplifiers will affect performance. Avoid placing the player on heat-generating sources.
- Install this compact disc player as far as possible from tuners and TV sets. A compact disc player installed in close proximity to such equipment may cause noise or degradation of the picture.
- Such noise may be particularly noticeable when an indoor antenna is used. In such cases, make use of an outdoor antenna, or turn off power to the compact disc player.
- **Please place this unit on a level surface.**



Cleaning the player

To clean the PLAYER wipe with a soft, dry cloth. For stubborn dirt, wet a soft cloth with a mild detergent solution made by diluting one part detergent to 5 or 6 parts water, wring well, then wipe off the dirt. Also use a dry cloth to wipe the surface dry. Do not use volatile liquids such as benzene and thinner which are harmful to the unit.

Storing discs

- Discs are made of the same kinds of plastic used for conventional analog audio records. Be careful not to allow discs to warp; always store discs in their cases vertically, avoiding locations with high heat or humidity, or extremely low temperatures. Avoid leaving discs in cars, since the seat of a car in direct sunlight can become unbelievably hot.
- Always read and abide by the precautionary notes listed on disc labels.



CD lens cleaner

The player's pickup lens should not become dirty in normal use, but if for some reason it should malfunction due to soiling, consult your nearest PIONEER authorized service center. Lens cleaners for CD players are commercially available, but special care should be exercised in their use since some may cause damage to the lens.

Condensation

When this unit is brought into a warm room from previously cold surroundings or when the room temperature rises sharply, condensation may form inside, and the unit may not be able to attain its full performance. If this occurs, allow the unit to stand for about an hour or raise the room temperature gradually.



Cleaning and handling compact discs

- The presence of fingerprints or smudges on the surface of the disc will not directly affect the recorded signals, but depending on the degree of contamination, the brightness of the light reflected from the signal surfaces may be reduced, causing degradation of sound quality. Always keep your discs clean by wiping them gently with a soft cloth from the inner edge toward the outer periphery.



- If a disc becomes very dirty, dip a soft cloth in water, and after wringing it out well, wipe the dirt away gently, and then remove any water drops with another soft, dry cloth.
- Do not use record cleaning sprays or anti-static agents on discs. Also, never clean discs with benzene, thinner, or other volatile solvents, since damage to the disc surface may result.



With this unit, use a Compact Disc carrying the mark shown below. Do not use other disc, for this may result in malfunction or damage.

- When holding discs, do not touch their signal surfaces. Hold by the edges, or by one edge and the center hole.
- Do not affix gummed labels or tape to the label surfaces. Also, do not scratch or damage the label.
- Discs rotate at high speed inside the player. Do not use damaged (cracked or warped) discs.
- Do not play a CD with a special shape (having other shape than a circular disc, such as a heart shaped disc). Otherwise malfunction may occur.

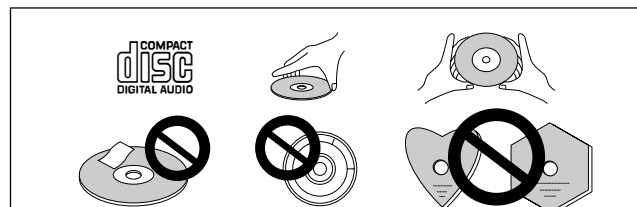

Re-transporting

When re-transporting this unit in the future, remove all discs from the rack. Turn off the STANDBY/ON switch, wait for "OFF" to go out from the display, and unplug the power cord.

CONNECTIONS

- **Before making or changing the connections, switch off the power switch and disconnect the power cord from the AC outlet.**

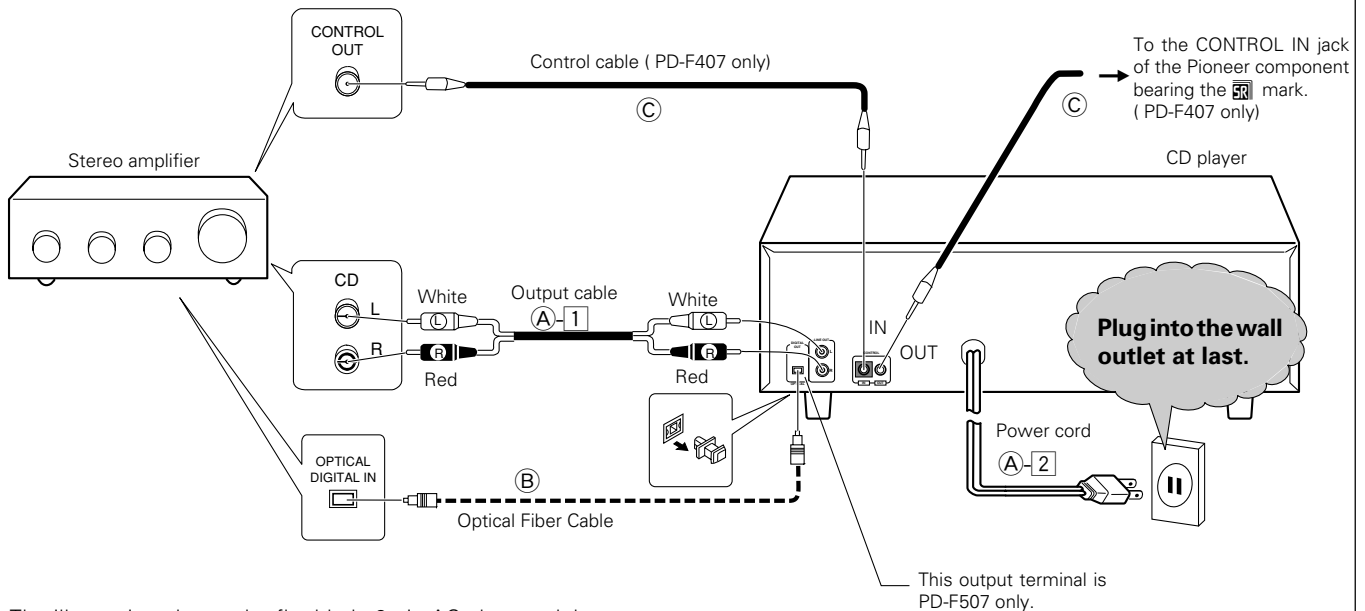

The illustration shows the flat blade 2-pin AC plug model.

Ⓐ Making connections

- 1 Connect the OUTPUT jacks of this unit to the input jacks (CD or AUX) of the amplifier. Make sure that the white plug is connected to the left (L) jack and the red plug to the right (R) jack.
- Be sure not to connect this unit to the amplifier's **PHONO** jacks, as sound will be distorted and normal playback will not be possible.
- 2 Connect the power cord to a household AC wall outlet.
- Make sure plugs are inserted fully into the wall outlet.

NOTE:

Do not connect the power cord to an AC outlet on your amplifier.

Ⓑ Connecting the OPTICAL FIBER CABLE (PD-F507 only)

This unit can be connected to an amplifier equipped with an optical digital jack.

1. Remove the protective dust cap from this unit's **DIGITAL OUT OPTICAL** jack.
2. Use an optical fiber cable to connect the **DIGITAL OUT OPTICAL** jack of this unit to the optical input jack of the amplifier.
- Align the plug of the optical fiber cable with the optical digital jack and fully insert the plug to make a secure connection.

Use a separately sold optical fiber cable for the optical digital jack connections.

Precautions concerning use of optical fiber cables

- Fully insert the optical fiber cable plugs all the way into the jacks.
- Be careful not to fold or crimp the cable. When coiling an optical fiber cable for storage, make sure the diameter of the coil is 15 cm or larger.
- Use an optical fiber cable with a length of 3 m or less.
- Protect the optical fiber cable plugs from scratches and dust.
- When the unit is not connected using an optical fiber cable, be sure to keep the protective dust cap plugged into the optical digital output jack at all times.

Ⓒ System remote control with a Pioneer stereo amplifier that has the mark (PD-F407 only)

When a Pioneer stereo amplifier bearing the mark is used, connect the **CONTROL IN** jack on the rear panel of the CD player to the **CONTROL OUT** jack of the amplifier. This will enable the CD player to be controlled using the remote control unit supplied with the stereo amplifier. If you do not plan to use this feature, it is not necessary to connect the **CONTROL IN/OUT** jacks.

- The remote control unit supplied with the amplifier can be used to control Play, Stop, Pause, Track/Disc Search and Disc Change operations.
- For instructions regarding connections and operation, refer to the operating instructions provided with your stereo amplifier.

NOTES:

- When a control cable is connected to the player's **CONTROL IN** jack, direct control of the player with the remote control unit is not possible. Operate the player with the remote control unit by aiming it at the amplifier.
- Be sure to connect both of the control cable's plugs securely to the **CONTROL IN** and **CONTROL OUT** jacks. Do not connect only one end of the cable.
- Be sure to turn off the power of the amplifier before connecting the power cord and output cable.

POWER-CORD CAUTION

Handle the power cord by the plug. Do not pull out the plug by tugging the cord and never touch the power cord when your hands are wet as this could cause a short circuit or an electric shock. Do not place the unit, a piece of furniture, etc., on the power cord, or pinch the cord. Never make a knot in the cord or tie it with other cords. The power cords should be routed such that they are not likely to be stepped on. A damaged power cord can cause a fire or give you an electrical shock. Check the power cord once in a while. When you find it damaged, ask your nearest PIONEER authorized service center or your dealer for a replacement.

HOW TO LOAD THE DISCS (Be sure to read this before operation)

Loading discs into the rack

The rack is for discs No. 1 - 25 .

- You can load up to 25 discs in each rack.

1

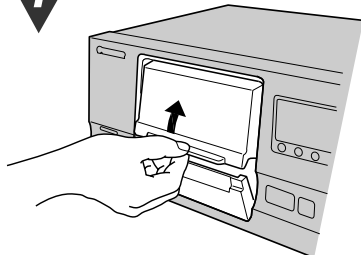

Gently lift the handle to open the hood.



The rack comes out.

2

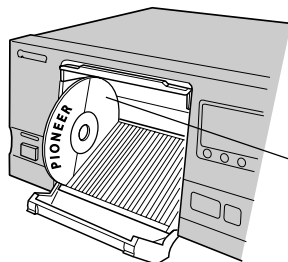

Load the disc into the rack with the label side (printed surface) facing to the right.

Label side faces right

- By using the racks, you can load a total of 25 discs.

3

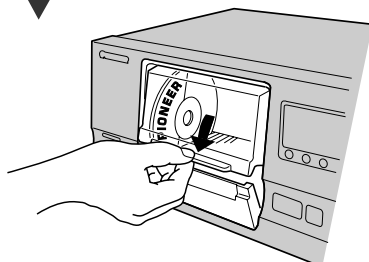

Gently push the handle down to close the hood.

- CDs cannot be played if the hood is open.

- The hood cannot be opened if disc is being played.
- The hood cannot be opened for approximately 10 seconds after playback has finished, or during disc search.
- Be careful not to pinch your fingers when opening and closing the hood.
- Open and close the hood slowly.

- If a disc is inserted with its label side facing to the left, it cannot be played back. Be sure to load all discs with their label sides facing to the right.

⚠ WARNING:

Do not put your hand, or any other objects inside the rack, otherwise injury or part damage may result.

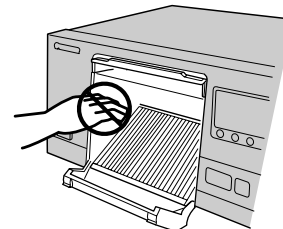

- Do not put anything other than CDs inside the rack.
- Do not use adapters for 8-cm CDs.
- Load only one disc into each disc slot.
- Inserting an 8-cm CDs in between two 12-cm CDs, will make it difficult to remove the 8-cm CD. We recommend inserting 12-cm CDs starting from the right side and 8-cm CDs starting from the left side of the rack.

- The unit will not operate if the hood is open. Be sure to close the hood before attempting any operations.

To remove the discs...

▼ Open the hood when playback has stopped.

▼ Remove the disc from the rack.

- The hood cannot be opened if the rack is currently playing a disc, during disc search, or during the first 10 seconds after playback has finished.

If you try to open the hood in one of the previous situations, "LOCK" will flash in the display. Close the hood immediately and wait for "LOCK" to go out from the display before opening the hood.

Playback will stop if you open the hood for longer than 2 seconds when "LOCK" is flashing.

- Be sure to remove all discs from the rack, set the STANDBY/ON switch to off, wait for "OFF" to go out from the display, and unplug the power cord before moving the unit.
- When moving the product, be careful not to tilt it or apply strong impact to it.

BASIC OPERATIONS

- You can operate PD-F507 by remote control unit and also by the main unit.
- You can operate PD-F407 by the main unit.

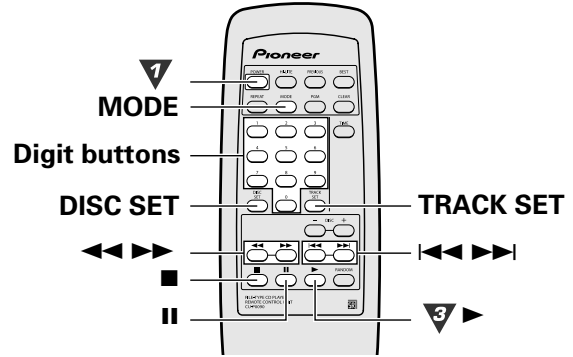
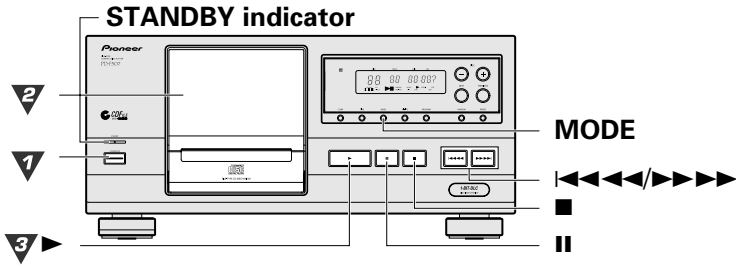

To listen in order from the first track

1 Press **STANDBY/ON**.
To turn the power off...
Press **STANDBY/ON** again.
STANDBY indicator lights.

2 Load discs into the rack.
Close the hood.

• Playback is not possible when the hood is open.

Label side faces right

3 Press **▶**.
The tracks are played in order starting from the first track on the disc with the lowest disc No.

- If you choose a play mode beforehand, the tracks/discs are played back according to the respective play mode.

To stop play Press **■**.

To pause play Press **II**.
To start play again, press **▶** or **II**.

To skip to another track Tap **◀◀◀/▶▶▶** (or **◀▶▶/▶▶▶**) on the remote control unit.

To fast forward/reverse. Hold down **◀◀◀/▶▶▶** (or **◀▶▶/▶▶▶**) on the remote control unit.

To select the disc and track (PD-F507 only)

2 Use the digit buttons to select the disc, then press **DISC SET**.

7 Use the digit buttons to select the track, and press **TRACK SET**.

- **DISC SET** or **TRACK SET** should be pressed in less than 5 seconds after pressing the last **numeric button**.
- If the disc has not been loaded in the selected position, "*** no dISC" is displayed for 3 seconds.

To select a play mode

Press MODE during play or stop mode.
Press a few times to choose the mode you desire.
Playback occurs according to the chosen mode.

- ALL:** All discs are played back
- SINGLE:** One disc is played back
- CUSTOM:** Only discs stored in the CUSTOM file are played back (I, II, III) (see page P.10 to create a custom file).

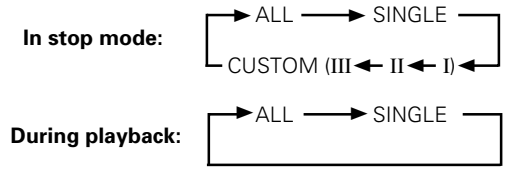

- When you select **SINGLE** during playback, only the current disc will be played.
- If you press **MODE** during program mode, the program contents will be erased.

- Notes!!**
- When you turn the power ON, playback starts according to the last selected play mode.
 - If you did not select a play mode, playback starts in **ALL**.

<Last disc memory>
When you press **■** or turn the power OFF, the unit memorizes the disc that was being played. The next time you press **▶**, playback will start from that same disc.

VARIOUS OPERATIONS

- You can operate PD-F507 by remote control unit and also by the main unit.
- You can operate PD-F407 by the main unit.
- **The parenthesis () show operations for the main unit.**

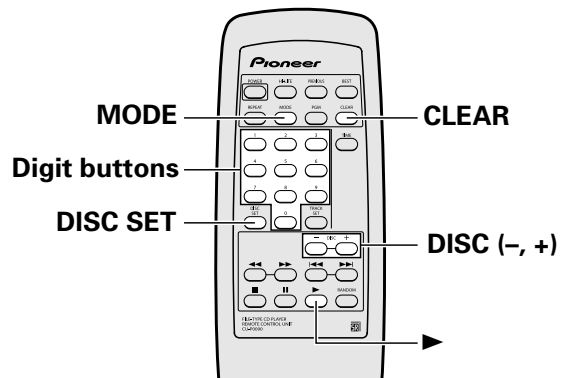
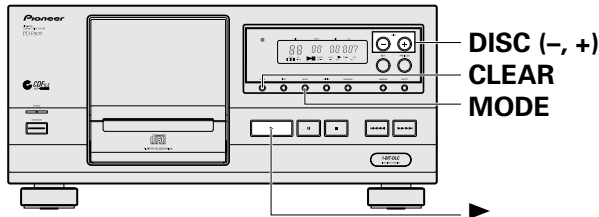

To program and play only the discs you want to hear (CUSTOM playback)

This unit lets you program up to 25 of your favorite discs. For example, you can store all the discs of your favorite artist, or some other group of personal selections, and play only those discs. You can even add other discs to the custom later on.

Operation example) Storing discs 3 and 12 in the CUSTOM II file.

1 **During stop mode, press MODE so that the CUSTOM II indicator lights.**

(MODE)

- If some disc number appears, press CLEAR.

2 **Use the digit buttons to select disc.**

(DISC (-) (+))

- If you use **DISC (-, +)** to select a disc, it will be programmed automatically after approximately 2 seconds.

3 **Press DISC SET.**

4 **Repeat steps 2 and 3 to store other discs.**

(DISC (-) (+))

Press MODE to select CUSTOM and press ►.

Playback starts from the lowest disc No.



Checking the numbers of the stored discs.

Press **TIME** repeatedly (3 times) during stop mode so that the display changes as shown below.

Press **DISC (-/+)**. Each time you press **DISC (-/+)**, a disc number stored in the CUSTOM file is displayed. When all the disc numbers have been displayed, the disc number changes to a blank.

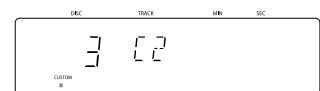

Erasing all the discs from the each CUSTOM file.

Press **MODE** to choose CUSTOM, then press the **CLEAR** button.

Note!!

You cannot change the discs stored in the CUSTOM file. Likewise, you cannot erase just one disc from the CUSTOM file.

- Pressing **DISC (-, +)** during CUSTOM playback lets you choose among other discs stored in the CUSTOM file.
- If you use the digit buttons and **DISC SET** on the remote control during CUSTOM playback to choose a disc not stored in the CUSTOM file, *****- no disc** will be displayed for approximately 3 seconds.
- The discs stored in the CUSTOM file will not be erased when you turn off the power.
- When a disc appointed to the CUSTOM file is not loaded in the rack, *****- no disc** is displayed for approximately 3 seconds, the disc is erased from memory, and CUSTOM searches for the next disc.

VARIOUS OPERATIONS

- You can operate PD-F507 by remote control unit and also by the main unit.
- You can operate PD-F407 by the main unit.

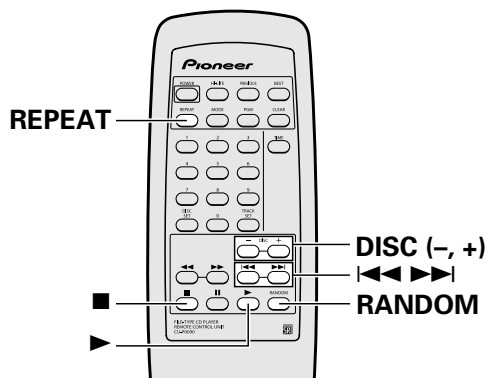
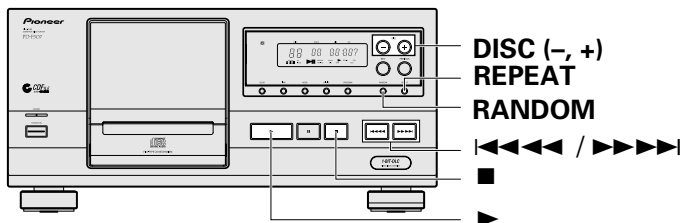

To start playback from a specific disc

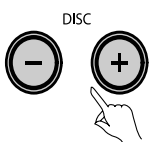

Press **DISC (-, +)** during play or pause to choose a disc number. During pause, press **▶** after choosing the disc.

- Playback starts from the first track of the chosen disc.

- When using the remote control, press **DISC (-, +)** to choose a disc, then press **▶** to start playback.

To play a track you want to hear

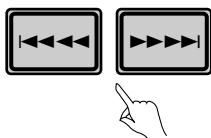

Press **◀◀◀/▶▶▶▶** during play or pause to choose the track number you desire (or press **◀/▶** on the remote control).

- During pause, press **▶** after choosing the track.

To repeat playback (REPEAT play)

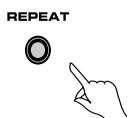

Press the **REPEAT** button during playback. Each time you press the button, the repeat mode changes as follows.

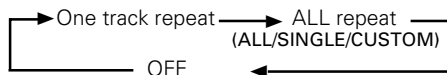

One track



(One track repeat)

Repeats the current or a selected track in either normal, random, or program play mode.

ALL



(ALL repeat)

Repeats in one of the following 3 ways according to the play mode



SINGLE



ALL:Repeats all the tracks on all the discs (1 - 25).

SINGLE:Repeats all the tracks on the selected disc.

CUSTOM



CUSTOM:All of the discs classified under one of the three CUSTOM banks are played repeatedly.

(OFF)

Cancels repeat play and returns the unit to normal play mode.

- To stop repeat playback, press **■**.

To playback tracks/discs at random (RANDOM play)

RANDOM selects tracks at random from the disc(s) in the current play mode and plays each track once. Playback stops when all the tracks on the disc(s) have played back once.

Play mode selected	Play contents
ALL	Plays all tracks in all discs in a random order.
SINGLE	Plays all the tracks from a single disc at random.
CUSTOM	Plays all tracks in the discs stored in the CUSTOM file in a random order.

RANDOM



Press **RANDOM** during either play or stop mode.



To stop random play, press **■**.

Notes!!

- *Random play cannot be activated during the program mode. (If you press **RANDOM** during program play, the program contents will be erased and the unit will start to play tracks at random from all the discs.*
- *If you press **REPEAT** during random play, the contents of the random mode are repeated. (RANDOM REPEAT)*
- *If you press **DISC (-, +)** during random play, random play is canceled.*
- *If you press **MODE** during random play, random play switches to the selected mode.*
- *If all discs contain 17 tracks or less, random play can play every track in the discs once. If any of the discs contain more than 17 tracks, random play plays the same number of tracks as the total number of tracks in the discs, but the tracks with track number 17 or more are not always played once.*

To program tracks/discs in a desired order (PROGRAM play)

- You can operate PD-F507 by remote control unit and also by the main unit.
- You can program up to 32 steps
- The parenthesis () show operations for the main unit.

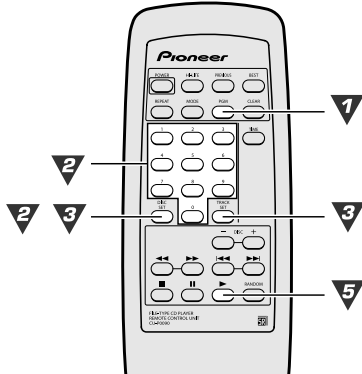

Operation example) Programming disc 2, track 7 as step 1, and disc 5, track 3 as step 2.

1 Press **PGM (PROGRAM)** during stop mode.

2 Use the digit buttons to select the disc, and press **DISC SET**.
(Use DISC (-, +) to select the disc number, then press PROGRAM.)

() The "PGM" indicator blinks.

3 Use the digit buttons to select the track, and press **TRACK SET**.
(Use to select the track number, then press PROGRAM.)

()

4 Repeat steps 2 and 3 to program additional discs and tracks.
Once the track times have been added, the PGM indicator stops blinking and the following display appears (Total Time).

()

5 Press **▶**.
The program play starts from the track that was programmed first.

The following operations can be performed during normal play

<Programming tracks during normal play> (Direct program)

1. Press **PGM (PROGRAM)**.
 - Program mode is activated.
2. Press **PGM (PROGRAM)** during playback.
 - The current track is programmed

<Programming during normal playback (remote control only)> (Pre-programming)

You can program during normal playback (→ Operation example)

- The player changes to program play when the current track finishes playing back.
- To change to program mode directly, press **▶**.

The following operations can only be performed during stop mode

<Programming an entire disc as one step> (Full disc program)

If you skip step of the operation example, disc 2 is programmed as step 1.

<Programming a pause (remote control only)> (Pause program)

If you press **II** at step , you can program a pause. When you press **II**, "PA" appears in the display instead of the disc number.

- For example, when making a program for recording both sides of a cassette tape, press **II** to insert a pause after programming the tracks for one side. After turning the tape over, press **II** to resume recording.

Notes

- You cannot program a pause as the first step, or program two pauses in a row.
- When you program a pause, it counts as 1 step and reduces the total number of tracks you can program.

- **To erase a program...**
Press **■** twice during playback (or once in stop mode). Press **MODE** or **RANDOM** in either play or stop mode. You can also erase the program by pressing **PREVIOUS** (or **BEST** in stop mode).

- **To cancel a program step**
In stop mode, each time you press **CLEAR**, the last step in the program is erased.

- If a programmed disc is missing or inserted backwards during program play, "***no disc" appears in the display, the step is automatically erased, and playback proceeds to the next step.
- Program contents are stored in memory even when the power is turned off (STANDBY).

Notes!!

- If step is carried out before the accumulated time is displayed, the program play starts and the time is not displayed.
- The display is not shown if the total time of the program is 100 minutes or more.

VARIOUS OPERATIONS

- You can operate PD-F507 by remote control unit and also by the main unit.
- You can operate PD-F407 by the main unit.

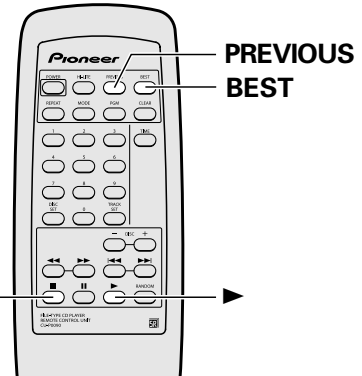
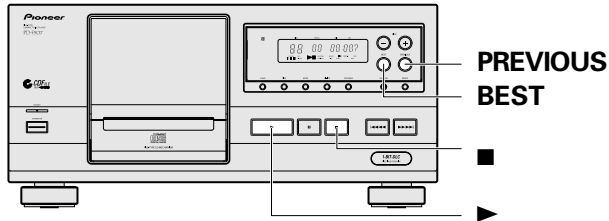

To store your favorite tracks (Best Selection Memory)

To use the one-touch memory, just press the **BEST** button while playing a track you like. You can store up to 15 tracks.

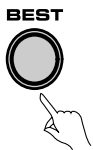

Press BEST while playing a track you like.

The BEST indicator flashes and the disc and track number are stored in memory.

<To listen to the memorized tracks>

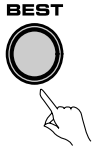

Press BEST during stop mode.

The BEST indicator lights and playback starts from the most recently memorized track.

- If you press **CLEAR** during best playback, the current track is erased and the next track starts to play.
- You cannot memorize a track twice by pressing **BEST** during best playback.
- The memorized contents are stored, even when power is turned off (STANDBY).
- If you press **BEST** to memorize a track when 15 tracks are already memorized, the oldest track is erased from the memory and the new track is memorized.

To find out which discs you've listened to recently

- This function scans the discs in reverse order, starting from the last disc you played.
- It can remember up to 15 discs. If the total number of discs exceeds 15, the oldest disc will be erased to make room for the new disc.

Example) If you played discs 1, 2, 9,12 and 13 in order.

PREVIOUS

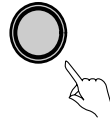

Press the PREVIOUS button.

- It plays approximately 1 min. 10 sec. of the first track of each disc, starting from the last disc you played: 13, 12, 9, 2, 1.

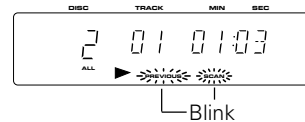

Press ► when you reach the disc you want to hear.

- Previous disc scan is canceled and normal play resumes.

- To cancel scanning, press ■.
- Discs played during random, program, HI-LITE scan and best selection memory play are not included in the PREVIOUS scan.
- If the first track is less than 1 minute long, about 10 seconds from the beginning will be played. If the first track is less than 10 seconds long, the entire track will be played.

VARIOUS OPERATIONS

- You can operate PD-F507 by remote control unit and also by the main unit.
- You can operate PD-F407 by the main unit.
- **The parenthesis () show operations for the main unit.**

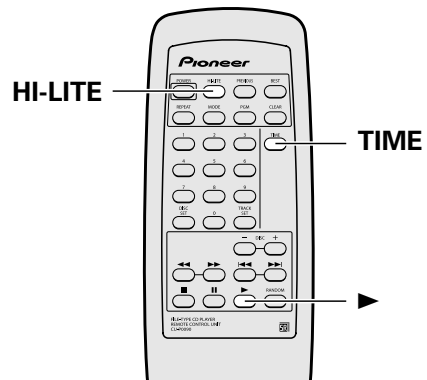
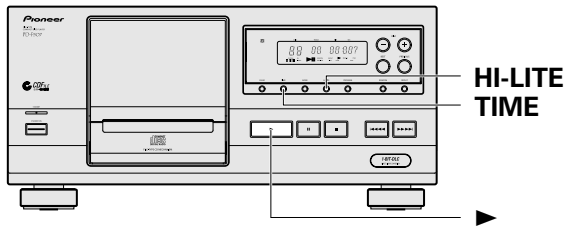

To scan quickly through tracks on a disc (HI-LITE scan)

This function plays a 10 second portion located 1 minute from the start of each track on all the discs in the current play mode.

- Regardless of the ALL or SINGLE play mode, the play mode indicator goes off and all of the discs will be scanned.

<Disc scan>

HI-LITE

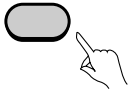

Press once

HI-LITE



The "DISC" and "SCAN" indicator blinks.

Press HI-LITE during either play or stop mode.

- The unit plays a 10 second portion located 1 minute into the first track of each CD, starting from the first CD.

<Track scan>

HI-LITE

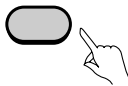

Press twice

HI-LITE



The "SCAN" indicator blinks.

Press HI-LITE twice during either play or stop mode.

- The unit plays a 10 second portion located 1 minute into each track of each CD, starting from the first CD.

<Program scan>

HI-LITE

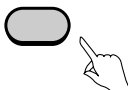

Press once

HI-LITE



The "SCAN" indicator blinks.

Press HI-LITE during program mode.

- The unit plays a 10 second portion located 1 minute into each track in the program.

<Best selection memory scan>

HI-LITE

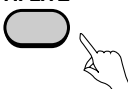

Press once

HI-LITE



The "SCAN" indicator blinks.

Press HI-LITE during best selection memory playback.

- The unit plays a 10 second portion located 1 minute into each track in the best selection memory.

<To return to normal playback>

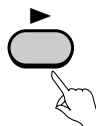

Press ► when you reach the track you want to hear. HI-LITE scan is canceled and normal play resumes.

- To cancel HI-LITE scan, press ■.



Notes!!

- You can use ◀◀▶▶ to skip to another track during track scan.
- If the player is in ALL REPEAT mode, the HI-LITE scan will repeat.
- If the track is less than 1 minute long, about 10 seconds from the beginning will be played. If the track is less than 10 seconds long, the entire track will be played.
- When REPEAT is pressed, HI-LITE scan playback will be repeated.

To use the TIME button

TIME



Press TIME during playback.

Each time you press TIME, the display changes as follows.

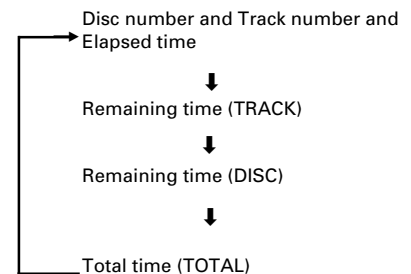

Notes!!

- During program mode, the TOTAL display shows the program step and total elapsed time of the program.
- Time remaining on the disc is not displayed during RANDOM or PROGRAM play.
- Time remaining on the track may not be displayed for tracks numbered greater than 24.

TROUBLESHOOTING

Incorrect operations are often mistaken for trouble and malfunctions. If you think that there is something wrong with this component, check the points below. Sometimes the trouble may lie in another component. Investigate the other components and electrical appliances being used. If the trouble cannot be rectified even after exercising the checks listed below, ask your nearest PIONEER authorized service center or your dealer to carry out repair work.

Symptom	Probable cause	Remedy
No sound	<ul style="list-style-type: none"> Output cables are connected incorrectly or loosely. Incorrect operation of stereo amplifier. Pin plugs and/or amplifier terminals are dirty. Player is in pause mode. The disc is loaded with the label side leftward. 	<ul style="list-style-type: none"> Connect properly. Check the settings of amplifier switches and sound volume controls. Clean away dirt. Press ► or II. Reload the disc with the label side rightward.
When playback is started, it stops immediately. Pause or stops during playback.	<ul style="list-style-type: none"> Disc is inserted in the wrong way. Smudges, etc., on the disc. 	<ul style="list-style-type: none"> Insert the disc correctly with the label side rightward. Clean the smudges from the disc and then play it again.
Remote control will not function. (PD-F507 only)	<ul style="list-style-type: none"> Dead batteries. Obstruction between player and remote control unit. 	<ul style="list-style-type: none"> Replace batteries. Relocate remote control unit or remove obstruction.

Abnormal functioning of this unit may be caused by static electricity, or other external interference. To restore normal operation, unplug the AC power cord and then plug it in again.

SELF-DIAGNOSTICS FUNCTION

The unit incorporates the self-diagnostic function. When an abnormality is detected during operation of the unit, an error message (service No.) appears on the units display automatically. Treat the error by following the instructions in "Countermeasures".

Display on the unit

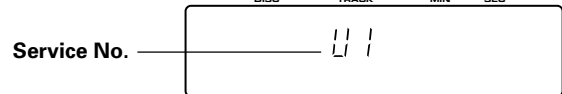

Service No.	Unit Status	Countermeasures
U1	The disc may not be loaded properly in the rack.	<ul style="list-style-type: none"> Reload the discs properly. (Insert one disc only in a slot.) Check if there is a foreign object attached onto the disc. Check if there is a foreign object in the rack.
U2	There is an operation error in the mechanical section.	<ul style="list-style-type: none"> Check if there is a foreign object in the rack. Unplug the power cord then plug it in again.

If the same display appears again, there may be an error in the mechanical section. When requesting servicing, please also let us know the service number displayed on the unit.

SPECIFICATIONS

1. General

Type Compact disc digital audio system
 Power requirements
 Flat blade 2-pin AC plug model AC 110–127V/220–240V (switchable) 50/60 Hz
 Power consumption 13W
 Operating temperature +5°C - +35°C
 Weight (without package) 4.8 kg
 External dimensions 420(W) X 312(D) X 193(H) mm

2. Audio section

Frequency response 2 Hz - 20 kHz
 Level difference between channels 1.0 dB or less (EIAJ)
 Output voltage 2 ± 0.3 Vrms (EIAJ)
 Wow and flutter less than ±0.001 % (W.PEAK) (below measurable level) (EIAJ)
 Channels 2-channel (stereo)

3. Output terminal

Audio line output
 Control input/output jacks (PD-F407 only)
 Optical digital output jack (PD-F507 only)

4. Accessories

- Remote control unit (PD-F507 only) 1
- Size AA/R6P dry cell batteries (PD-F507 only) 2
- Control cable (PD-F407 only) 1
- Output cable 1
- CD liner notes file 1
- Index label sheet 1
- Operating instructions 1

NOTE:

Specifications and design subject to possible modification without notice, due to improvements.

重要



等邊三角形內帶有箭頭的閃電符號旨在引起用戶警惕，因本產品機殼內有無絕緣“危險電壓”，可能很大程度造成觸電的危險。

小心

有電擊的危險
請勿打開

注意
為避免觸電危險，請勿拆卸蓋子（或背面板）。機內沒有可供用戶自行修理的零部件。維修事宜交由有資格的維修人員進行。



等邊三角形內的感嘆號旨在提醒用戶注意本機附帶的資料中有關操作和維護（修理）的重要說明。

D3-4-2-1-1_ChH

小心：

本產品包含有1級以上的鐳射二極管。為了保證安全，切勿打開任何機蓋或者試圖接觸本機內部，必要時應請求專業技術人員提供服務。

下面的提醒標籤貼於本機上。

位置：本機後面板上。

CLASS 1
LASER PRODUCT

D3-4-2-1-8_ChH

歡迎惠購 Pioneer 產品。

請通讀此操作說明書以便使您正確地操作本機。閱讀完說明書之後請妥善保管，以備日後查用。

在某些國家或地區，電源插頭和插座可能與說明圖中所表示的稍有不同，但本機的連接和操作方法是一樣的。

STANDBY/ON開關為二次聯接，因此在STANDBY位置不要將機器從主電源分離。因此請將本機安裝在發生事故時便於拔下電源插頭的合適的場所。如果長期不用，應將電源插頭從插座拔下。

D3-4-2-2-2a_ChH

電壓選擇開關

電壓選擇開關位於多電壓機型的背面板上。

電壓選擇開關的工廠初期設定為220-240V。將本開關設定於符合貴國或地區電壓的位置。

• 對於供應臺灣的機型，請在使用之前設定成110-127V。

在改變電壓之前，要拔除交流電源線。使用中型螺絲刀來改變電壓選擇開關的設定。

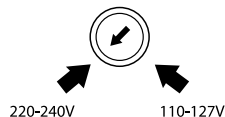

D3-4-2-1-5_ChH

工作環境

工作環境的溫度和濕度：

+5°C ~ +35°C (+41°F ~ +95°F)；小於 85% RH（冷卻口未堵塞）

請勿安裝在下列場所

- 太陽直射或強烈的人造光源下的場所
- 濕度很高或通風不良的場所

D3-4-2-1-7c_ChH

警告：切勿將點燃的蠟燭等明火源放在本機上。萬一明火源倒下，火苗將蔓延到本機，從而引發火災。

D3-4-2-1-7a_ChH

警告：機殼上帶有縫孔和開口，用於通風、防止過熱和確保本產品能夠正常工作。為了防止火災，切勿用報紙、桌布、幕簾等物件堵住或蓋住這些開口，也不要將本機放在鋪有厚毯子的床上、沙發上或很厚的織物上。

D3-4-2-1-7b_ChH

警告：本機不具備防水功能。為防止起火或觸電事故，請勿將其暴露在雨中或潮濕的環境裡，也不要靠近花瓶、花盆、化妝盒、藥瓶等有水的地方。

D3-4-2-1-3_ChH

警告：剛開始將本機插入電源前，請仔細閱讀下一節的說明。電源電壓因國家和地區而異。切記在使用本機時使當地電源電壓與寫在本機後面板上的所需電壓〔如230V或120V〕保持一致。

D3-4-2-1-4_ChH

目 录

在您使用唱機之前	18
使用注意事項	19
連線	20
部件名稱	21
如何裝載唱盤	22

基本操作

從第一張唱盤起按順序播放	23
選擇唱盤和曲目	23
選擇播放模式	23

各種操作

編程序以播放您所期望的唱盤 （定做（CUSTOM）播放）	24
從指定的唱盤開始播放	25
播放您想聽的曲目	25
重復播放（重復（REPEAT）播放）	25
隨機播放 曲目／唱盤 （隨機（RANDOM）播放）	25
按期望順序播放 曲目／唱盤 （編程（PROGRAM）播放）	26
保存您喜愛的曲目	27
尋找最近聽過的唱盤	27
快速掃描唱盤上的曲目（精彩掃描）	28
使用時間（TIME）按鍵	28

故障排除	29
規格	29

在您使用唱機之前

這就是您可作的！

- 唱碟可被分為3個組（定做），每組最多可包含25張唱碟 [P.24](#)。

例如，您可以將自己的唱碟定做為第I組（定做I，CUSTOM I）；您母親的唱碟定做為第II組（定做II，CUSTOM II）；您父親的唱碟定做為第III組（定做III，CUSTOM III）。當然，您也可以根據音樂的類型或作音樂家名稱來定做分組。您可以播放3組之中的任何一組的所有唱碟。在已經定做好的分組中也可以隨時添加唱碟。每個定做分組最多可包含25張唱碟。

- 在唱機中裝載的25張唱盤中，即時選取并播放您所喜愛的曲目 [P.27](#)。

最佳選擇記憶功能，可使您只按一鍵便可存儲并播放您所喜愛的曲目（最多達15首）。

- 方便的選取最近剛聽過的唱盤 [P.27](#)。

既往唱盤掃描功能可將以往聽過的唱盤逐張裝載（自動記憶最近的15張唱盤）。

確認附屬品

遙控器 × 1
(只限於 PD-F507)

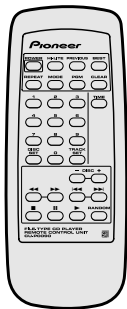

輸出電纜 × 1



A A / R6P 型干電池 × 2
(只限於 PD-F507)

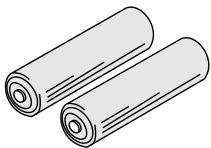

控制連線 × 1
(只限於PD-F407)

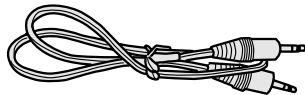

CD 襯里筆記檔案 × 1

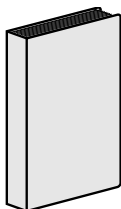

索引標籤紙 × 1

1	2	3	4	5
6	7	8	9	10
11	12	13	14	15
16	17	18	19	20
21	22	23	24	25

- 請將索引標籤紙與 CD 襯里筆記檔案一起使用。

給遙控器裝電池（只限於 PD-F507）

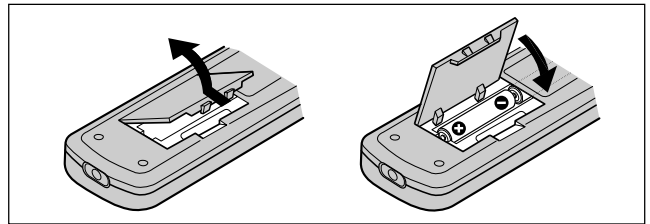

打開位於遙控器背面的電池盒的蓋子，放入電池。請注意按標示的 ⊕ 和 ⊖ 極放好。

注意：

- 為防止電池洩漏，在長時間（個月或更長）不使用遙控器時，務必將電池取出。如果出現洩漏，請將電池液仔細擦干淨，再換上新電池。
- 不要將書或其他物品壓在遙控器上，因為重物會壓下遙控器的按鍵，引起電池過早消耗。

不正常地使用電池會導致洩漏或破裂。

請務必遵守以下規則：

- 安放電池到電池盒時，一定要按盒內所標示的正 ⊕ 負 ⊖ 極性，當放置。
- 新舊電池不可混合使用。
- 雖然尺寸相同，但不同牌號的電池可能有不同的電壓。所以，不可混合使用不同牌號的電池。
- 處理廢舊電池時，請遵守政府條例或適用於貴國或地區的環境公共指令規則。

遙控器操作（只限於 PD-F507）

在操作遙控器時，請將其紅外線信號傳送器對准播放機面的遙控接收器（遙控傳感器）。遙控器可在距離遙控傳感器7米 之範圍內使用，與遙控傳感器所成的角度亦應在30度之內。

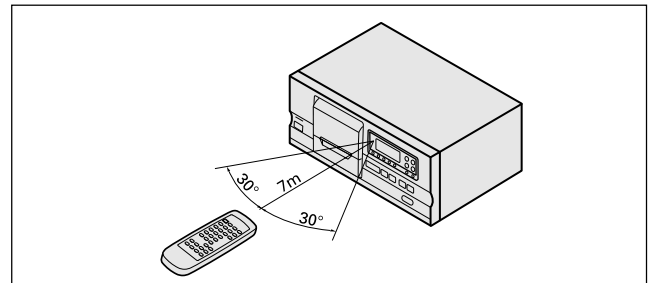

注意：

如果遙控傳感器的窗口位於受到強光或螢光照射之處，則無法進行控制。

使用注意事項

安裝

請把機器放置於通風良好，並且不是高溫或潮濕的場所。
請勿把本機放在處於陽光直接照射，或附近有爐子或散熱器的地方，過熱會對機殼及內部部件產生壞影響。而且，把機器放在潮濕及多塵的地方，會引起誤動作或事故。（避免將本機放置於有油煙、蒸氣或高溫等地方及靠近廚房處）。
也不要將本機放在不穩定或傾斜的表面處。

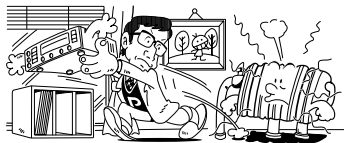

關於安裝前的注意事項

- 若長期把機器放在如放大器等的放熱源上使用，則會對性能產生影響。因此應避免將其置於此類地方。
- 盡量將本機放置遠離調諧器機電視機。若該唱機放置場所接近於這些設備，則可能引起噪音或圖像劣化。
- 使用室內天線時，噪音會特別明顯。這時請使用室外天線或關掉本機電源。
- 請把機器放於水平的平坦場所。



清潔唱機

用柔軟干布清潔本機。遇到頑固的污穢，可用由1份清潔劑加5或6份水稀釋成的中性清潔劑將軟布蘸濕并擰干後，把臟物擦掉。然後再用干布擦干表面。請勿使用對機器有害的苯劑稀釋劑等揮發性溶劑。

唱碟的保存

- 唱碟由同樣種類的塑料制成，這些塑料用於一般摹擬式音頻錄音。切勿唱碟彎曲：平時將唱碟放在唱碟盒內垂直放置保存，並且避免放置在高熱、潮濕或超低溫的地方。也請避免將唱碟放在汽車里，因為直射陽光照射的密閉汽車里溫度會極度上升。
- 請閱讀并遵守唱碟標籤上的注意事項。



唱碟透鏡清潔器

正常使用的話，唱機的拾音透鏡不會變臟，若由於某種原因使唱機誤動作了，請與附近的PIONEER專門維修中心聯繫。唱碟機的透鏡清潔器雖在市面上有出售，但使用時千萬要小心，不要弄毀透鏡。

結露

若從一較寒冷環境，把機器一下子拿到較暖和房間、或者房間溫度突然升高，機內會結露，從而造成機器功能失靈。為防止這種情況發生，請慢慢使房間內溫度升高，或在打開機器電源開關之前，請把機器放置一小時再用。



清潔及使用唱碟時

- 唱碟表面若有指紋或污點，不會直接影響錄音信號，但依程度而異，會減少從信號面反射的光線亮度，這會引起質劣化。請保持唱碟清潔，平常用軟布輕輕從中心向外沿抹。



- 若唱碟臟了，用軟布蘸水，擰干後輕抹唱碟臟處。然後用一干軟布抹去水痕。
- 不要使用唱碟清潔噴液或防靜電藥劑及其他活性劑。千萬不可用苯、稀釋液或其他揮發性液體否則會損壞唱碟表面。



在本機上，只能使用標有以下標記的CD碟片。不要使用其它碟片，否則會引起故障或造成損壞。

- 拿唱碟時，請勿觸摸信號面。拿住邊緣，或用手卡住邊緣與中心孔。
- 不要在標籤一面貼其他標籤或膠布。也不要剝離或損壞標籤。
- 唱碟在唱機內將高速旋轉，因此不要使用已破損的唱碟如有縫或卷曲的唱碟。
- 在本機上可以使用標有以下標記的CD碟片。不可使用其它碟片，否則將產生故障或損壞。

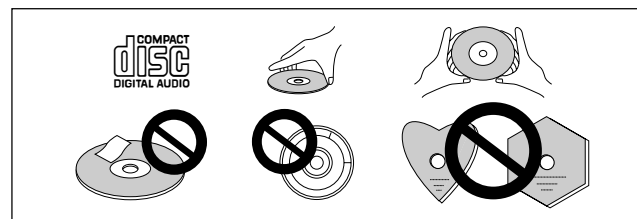

再次搬運

如果將來再次搬運本機，請從唱盤架上取下所有唱碟；關上電源待機開關（POWER STANDBY/ON），等到顯示器上的“OFF”（關）消失後，拔下電源線。

連線

- 在進行或變更連線之前，請先關斷電源開關，再從交流插座上拔下電源線。

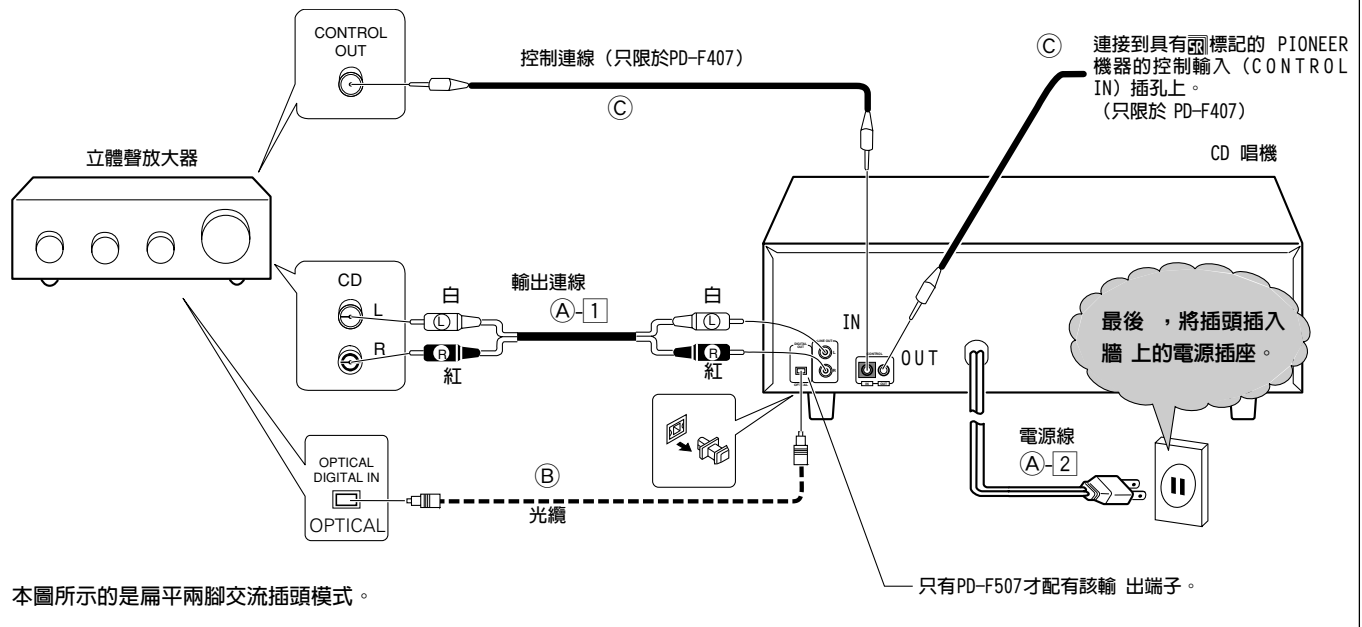

本圖所示的是扁平兩腳交流插頭模式。

Ⓐ 連線

- 1 將本機的輸出 (OUTPUT) 插孔和放大器的輸入 (INPUT) 插孔相連。請確保白色插頭一定插入左 (L) 插孔；紅色插頭一定插入右 (R) 插孔。
 - 絕不可將本機連接到放大器的唱機 (PHONO) 插孔上。這樣會使聲音失真并使正常收音不能進行。
- 2 將電源線連接到牆上的交流插座上。
 - 確認插頭完全插入插座之中。

注意：

不可將插頭插入放大器上的交流插座。

Ⓑ 連接光纖 (只限於PD-F507)

本機可與裝有光學數字式插孔的放大器相連接。

- 1 拆下本機的光學數字輸出 (DIGITAL OUT OPTICAL) 插孔上的防塵罩。
 - 2 用光纖將本機的光學數字輸出 (DIGITAL OUT OPTICAL) 插孔與放大器上的光學輸入插孔相連接。
 - 將光纖的插頭完全插入光學數字式插孔，確保牢靠連接。
- 連接光學數字式插孔時，請用另售的光纖。

使用光纖的注意事項

- 將光纖的插頭完全插入插孔。
- 不可折迭光纖。在收藏光纖時，請將其環繞成圈，並保證該圈的直徑在15厘米以上。
- 使用的光纖應在3米之內。
- 光纖的插頭應妥善保護，以防灰塵和擦傷。
- 當機器之間不使用光纖連接時，為了防止塵埃，一定要在輸出插孔上蓋好防塵罩。

Ⓒ 與具有 標記的PIONEER立體聲放大器相連的系統控制 (只限於PD-F407)

在使用具有 標記的PIONEER立體聲放大器時，可將其控制輸出 (CONTROL OUT) 插孔與CD唱機後面板上的控制輸入 (CONTROL IN) 插孔相連接。這樣，就可使用立體聲放大器的遙控器來控制CD唱機。如果您不打算使用此功能，則沒有必要進行上述的控制輸出 (CONTROL OUT) 插孔的連接。

- 放大器上附帶的遙控器可進行播放、停止、暫停、曲目/唱盤搜索和換唱盤等操作。
- 關於連接和操作等事項請參考放大器附帶的說明書。

注意：

- 當唱機的控制輸入 (CONTROL IN) 插孔被連接後，並不等於可直接用遙控器操作唱機。只能通過將遙控器對準放大器才可操作唱機。
- 在控制輸出 (CONTROL OUT) 插孔和控制輸入 (CONTROL IN) 插孔兩方都要插好連線，不可只連一方。
- 在連接電源線和輸出連線之前，請關掉放大器的電源。

電源線注意事項

握持電源線時應拿住其插頭部位。拔出電源插頭時不可拉住電源線往外拔，當您的手潮濕時，不可觸摸電源線，以免造成短路或觸電。不可將機器、家具等物置於電源線之上，亦不可夾持電源線。不可在電源線上打結或將其與其他連線捆綁在一起。電源線配置時要選擇不會被踩到的路徑。損壞的電源線會引起火災或使您觸電。隔一段時間應檢查一次電源線。當您發現電源線損壞時，可向附近的PIONEER授權的維修中心或經銷商諮詢，請求更換。

部件名稱

前面板

- 括號 P. 中的數字是可供參考的頁碼。

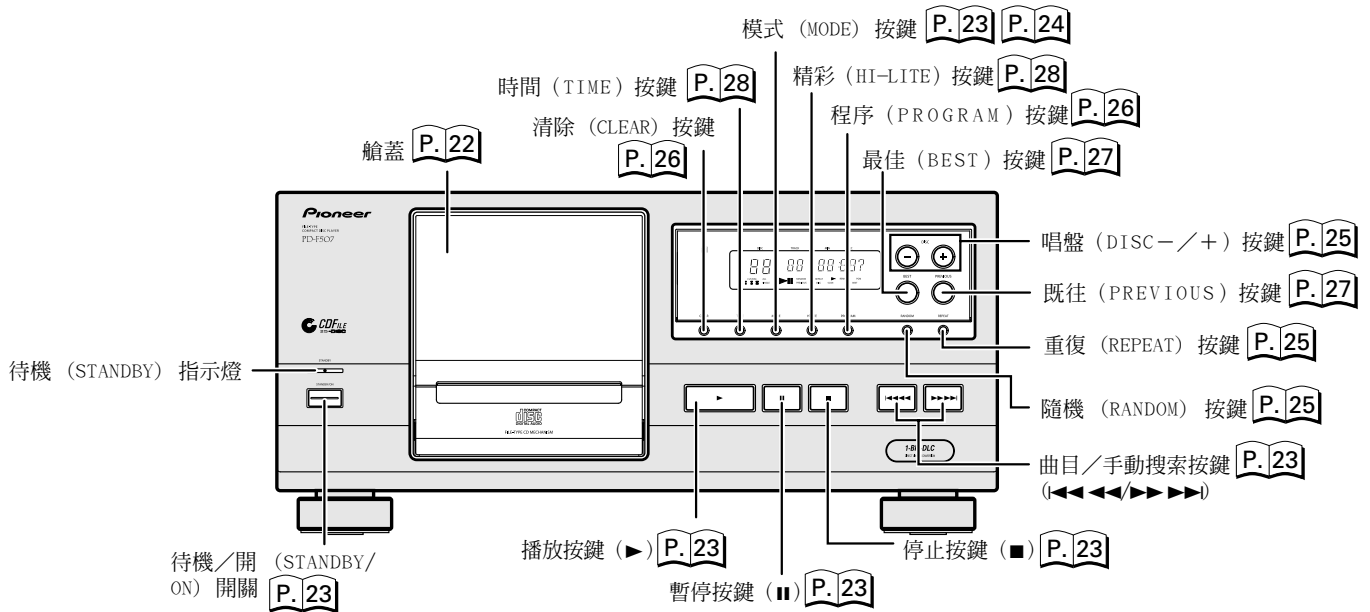

顯示器

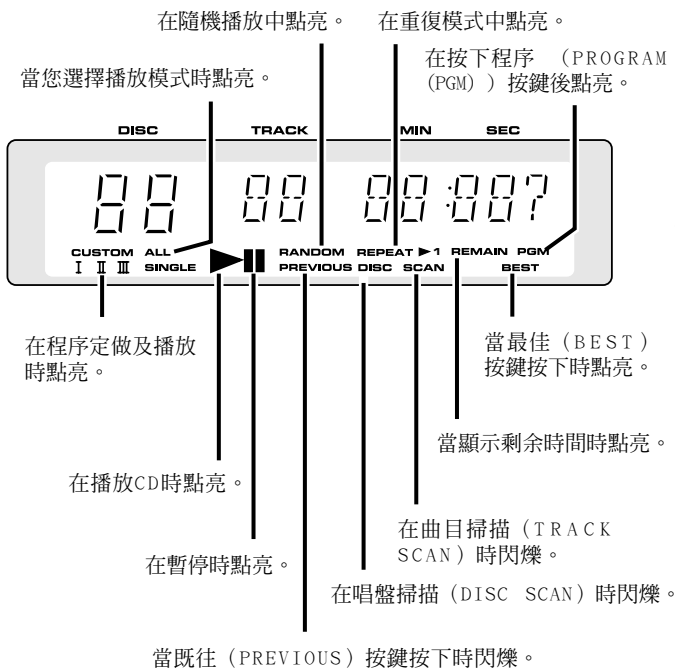

遙控器 (只限於PD-F507)

- 括號 P. 中的數字是可供參考的頁碼。

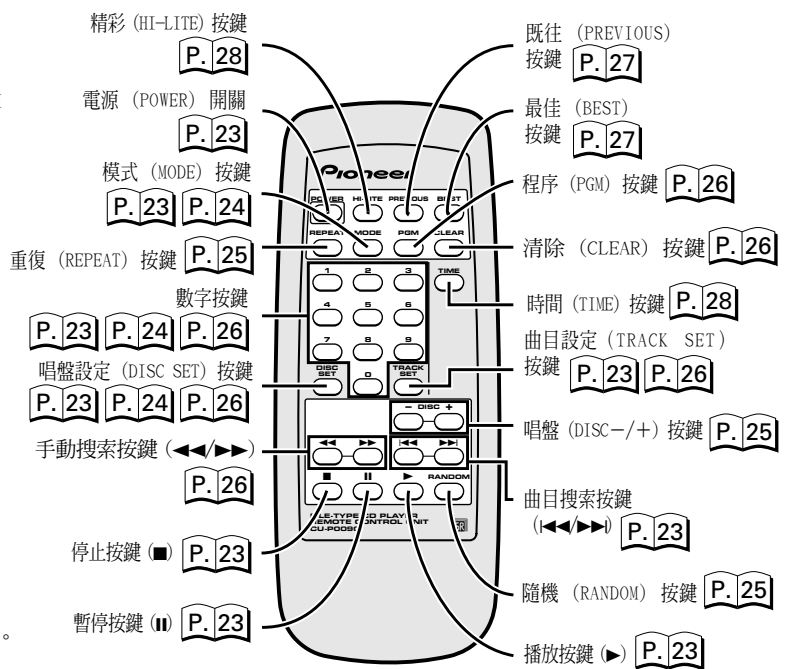

如何裝載唱盤 (使用之前必須閱讀)

在唱盤架上裝載唱盤

在每個唱盤架中，您都可裝入25張唱盤。

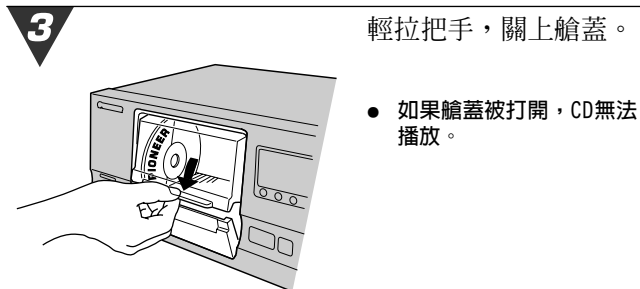
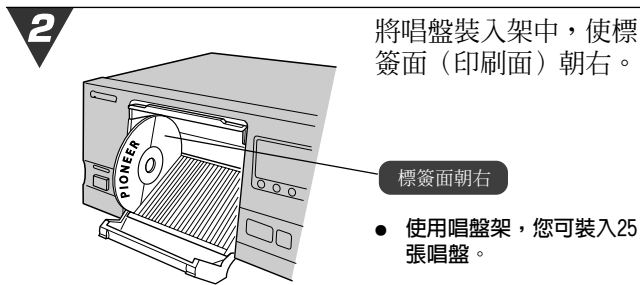
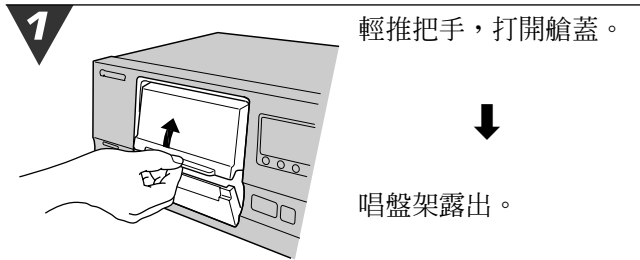

取出唱盤時...

- 1** 當播放停止時，打開艙蓋。
- 2** 從唱盤架上取出唱盤。

- 在播放中，不能打開艙蓋。
- 播放完畢的10秒鐘內或正在搜索之中，艙蓋便不能打開。
- 在打開或關閉艙蓋時，請小心，別夾手。
- 請慢慢地打開或關閉艙蓋。

- 如果裝入唱盤時，將標籤面朝左，則無法播放。請確保所有唱盤的標籤面朝右。
不可將手或任何其他物品置於唱盤架之內。

警告：

不可將手或其它物件伸入碟片架內，否則將造成損傷或機器損壞。

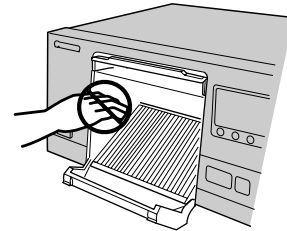

- CD之外的其他物品一律不可進入唱盤架內。
- 對於8厘米 唱盤，不要使用轉接器。
- 在每個插槽中只能放一張唱盤。
- 在12厘米 唱盤之間放置8厘米 唱盤將導致8厘米 唱盤取出困難。建議您在唱盤架的左方放置12厘米 唱盤，在右方裝載8厘米 唱盤。

- 當艙蓋打開時機器無法工作。所以，在進行操作之前請關上艙蓋。

- 如果唱盤架中的唱盤正在播放、被搜索，以及播放完畢的10秒鐘內，艙蓋不能打開。在上述情況下，如果您試圖打開艙蓋，則顯示器上將有“LOCK”（上鎖）字樣閃爍。盡快關上艙蓋，等到顯示器上的“LOCK”字樣消失，再速開艙蓋。當“LOCK”字樣閃爍時，如果您打開艙蓋長於2秒鐘，則播放將自動停。
- 請務必從碟片架中取出所有碟片，將STANDBY/ON（待機/開）開關設置於關閉位置，待“OFF”字樣從顯示器上消失后，拔下電源插頭，再移動機器。
- 在搬運機器時，請不要傾斜或使其受到沖擊。

基本操作

- 您可使用遙控器或在主機上操作PD-F507。
- 您可在主機上操作PD-F407。

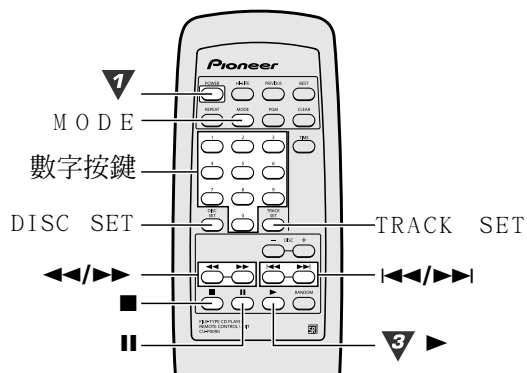
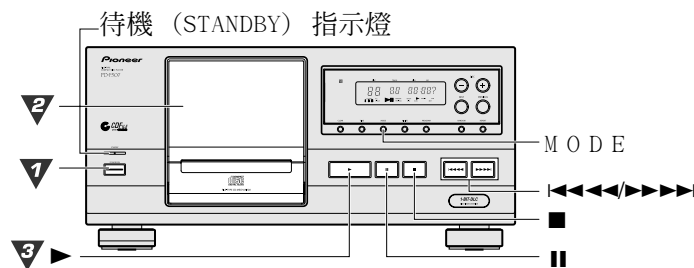

從第一張唱盤起按順序播放

1



按下待機/打開 (STANDBY/ON) 開關。



再次按下待機/打開 (STANDBY/ON) 開關。
待機 (STANDBY) 指示燈點亮。

2

在唱盤架中裝入唱盤。

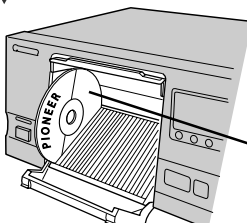



關上艙蓋。

- 艙蓋打開時無法播放。

標籤面朝右。

3



按下 。

將從號碼最小的唱盤開始，按順序播放曲目。

- 如果您事先設定了播放模式，則曲目/唱盤的播放將按相應的模式進行。

停止播放





按 。

暫停播放



按 。

再次播放時，按下  或 。

跳到另一曲目



按  (或遙控器上的 )。

快進/快倒



按住  (或遙控器上的 )。

選擇唱盤和曲目 (只限於PD-F507)

2



使用數字按鍵來選擇唱盤，然後按唱盤設定 (DISC SET) 按鍵。

7



使用數字按鍵來選擇曲目，然後按曲目設定 (TRACK SET) 按鍵。

- 在按下最後一個數字鍵之後的五秒鐘之內，必須按下唱碟設定 (DISC SET) 或曲目設定 (TRACK SET) 按鍵。
- 如果選擇的位置上沒有唱碟，則持續 3 秒鐘顯示出“無唱碟” (NO DISC) 字樣。

選擇播放模式

MODE



在播放或停止模式下，按模式 (MODE) 按鍵。

按下數次，直到出現期望的模式為止。

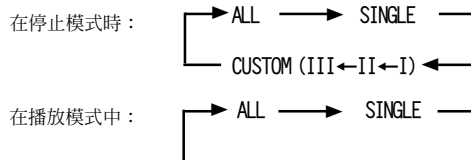

根據選擇的模式進行播放。

- ALL (所有) : 所有的唱盤都被播放。
- SINGLE (單個) : 播放一張唱盤。
- CUSTOM (定做) : 只播放那些存儲在定做 (CUSTOM) 檔案中的唱盤 (定做檔案可參考第24頁)。



- 在播放中如果選擇單個唱盤 (SINGLE) 模式時，只播放當前的唱盤。
- 在程序模式中如果按下模式 (MODE) 按鍵，將消去程序的全部內容。

- 注意！！
- 當您打開電源時，機器即以上一次選擇的模式開始播放。
 - 如果您在播放時沒有選擇模式，機器便以ALL (所有) 模式進行播放。

<前次唱盤記憶>
當您按下  或關閉電源時，機器會記憶正在播放的唱盤。當您下一次按下  時，機器即從同一唱盤開始播放。

各種操作

- 您可使用遙控器或在主機上操作PD-F507。
- 您可在主機上操作PD-F407。
- 括號 () 中所示的是主機的相應操作。

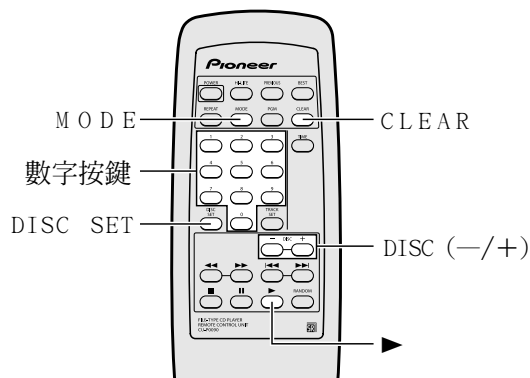
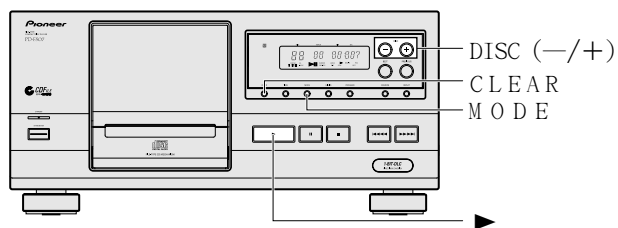

編程序以播放您所期望的唱盤 (定做 (CUSTOM) 播放)

本機讓您對自己喜愛的唱盤，最多可達25張，進行編程。例如，您可以裝入您所喜愛的藝術家的作品以及其他個人選擇的作品，只聽這些唱盤。您也可往定做的單子上追加其他唱盤。

操作例：將唱盤3和12存儲進定做 (CUSTOM II) 檔案。

在停止模式下，按下模式 (MODE) 按鍵，用戶定做 (CUSTOM) II 指示器點亮。

2 使用數字按鍵選擇唱盤。

- 如果您使用唱盤 (DISC (-/+)) 來選擇唱盤，該唱盤便在大約2秒鐘後被自動編程。

3 按下唱盤設定 (DISC SET)。

4 重複步驟2和3以存儲另一張唱盤。

按下MODE (模式) 按鍵，選擇CUSTOM，然後按下 ()。

() 從號碼最小的唱盤開始播放。

檢查存儲的唱盤的數目。
在停止模式下，反復 (3次) 按下時間 (TIME) 按鍵，顯示器將變為下面所示。
按下唱盤 (DISC (-/+)) 按鍵。每按下該按鍵一次，存儲在用戶定做文檔中的唱碟號碼就逐一顯示出來。當文檔中所有的號碼都顯示完畢後，就顯示出空格。

從各個定做分組文檔中消去所有的唱碟。
按下 (模式) MODE按鍵，選擇 (定做) CUSTOM，然後按下 (清除) CLEAR按鍵。

注意！！
您無法更改定做 (CUSTOM) 檔案中的唱盤，同樣地，您也無法從定做 (CUSTOM) 檔案中消去某一個唱盤。

- 在定做 (CUSTOM) 播放時，按下唱盤 (DISC (-/+)) 按鍵可讓您在定做 (CUSTOM) 檔案中選擇唱盤。
- 在定做 (CUSTOM) 播放時，按下遙控器的數字按鍵或唱盤設定 (DISC SET) 按鍵，選擇了一張沒有在定做 (CUSTOM) 檔案登記的唱盤，顯示器上將出現 “** no dISC” (無此唱盤) 字樣，并持續顯示3秒鐘。
- 在關斷電源時，定做 (CUSTOM) 檔案中的內容不會被消掉。
- 當指定了定做 (CUSTOM) 檔案中記錄的唱盤，但該唱盤沒有裝入時，顯示器上將出現 “** no dISC” (無此唱盤) 字樣，并持續顯示3秒鐘，然後該唱盤將從存儲器刪除，定做 (CUSTOM) 搜索繼續到下一唱盤。

- 您可使用遙控器或在主機上操作PD-F507。
- 您可在主機上操作PD-F407。

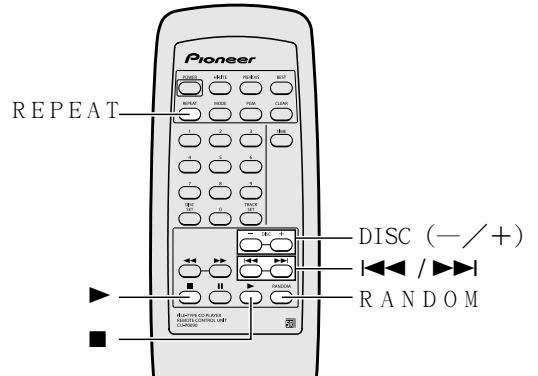
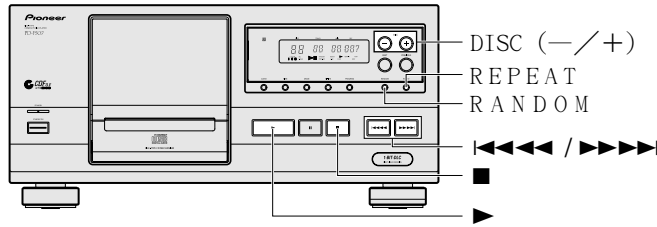

從指定的唱盤開始播放

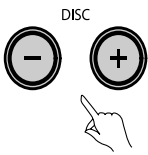

在播放或暫停時，按下唱盤 (DISC (-/+)) 按鍵以選擇唱盤。在暫停時，選擇了唱盤之後要按下 ▶。

- 播放將從選擇的唱盤的第一曲目開始。

- 如果使用遙控器，按下唱盤 (DISC (-/+)) 按鍵以選擇唱盤，然後按下 ▶ 便開始播放。

播放您想聽的曲目

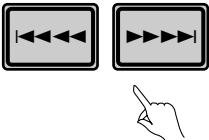

在播放或暫停時，按下 ◀◀ ◀◀/▶▶▶▶ 以選擇曲目 (或按下遙控器上的 ◀◀ / ▶▶)。

在暫停時，選擇了曲目之後要按下 ▶。

重復播放 (重復 (REPEAT) 播放)



在播放時按下重復 (REPEAT) 按鍵。按下一次該按鍵，模式按如下順序變化。

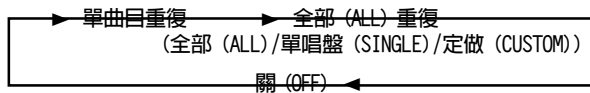

單曲目



全部 (ALL)



單唱盤 (SINGLE)



定做 (CUSTOM)



(單曲目重復)
在正常、隨機或編程模式下，重復播放當前曲目或選擇的曲目。

(全部 (ALL) 重復)
根據模式的不同，按下列三種方式之一，重復播放 [2][3]。

全部 (ALL): 重復所有唱盤 (1-25) 上的所有曲目。

單唱盤 (SINGLE): 重復所選擇的唱盤上的所有曲目。

定做 (CUSTOM): 三個用戶分組之一組中的所有唱碟都被反復播放。

(關 (OFF))
取消重復播放，返回正常模式。

- 停止播放時，按下 ■。

隨機播放 曲目/唱盤 (隨機 (RANDOM) 播放)

隨機 (RANDOM) 功能可將當前模式下所選擇的唱盤中的所有曲目以隨機方式播放，且每曲目只播放一次。所有唱盤上的所有曲目播放完畢之後便停止播放。

選擇的播放 模式	播放內容
全部 (ALL)	以隨機次序，播放所有碟片中的所有曲目。
單唱盤 (SINGLE)	隨機地播放唱盤上的所有曲目。
定做 (CUSTOM)	以隨機次序，播放 (定做) CUSTOM 檔案中的所有碟片中的所有曲目。

RANDOM



在播放或停止模式下，按下隨機 (RANDOM) 按鍵。



按下 ■ 以停止隨機播放。

注意！！

- 在編程模式下不能啟動隨機播放 (如果您在編程播放時按下了隨機 (RANDOM) 按鍵，則程序的內容會被消除，然後在所有唱盤中隨機地選擇曲目 播放)。
- 如果您在隨機播放時，按下重復 (REPEAT) 按鍵，隨機播放的內容會被重復 (隨機重復 (RANDOM REPEAT))。
- 如果您在隨機播放時，按下唱盤 (DISC (-/+)) 按鍵，隨機播放便被解除。
- 如果您在隨機播放時，按下模式 (MODE) 按鍵，隨機播放就會停止，而轉入其他選擇的模式。
- 如果所有碟片中的曲目數不多於17，則隨機播放將一個不漏地播放所有曲目一次。
如果有的碟片中的曲目數多於17，雖然隨機播放的總曲目數與碟片中的總曲目數相等，但對於第17曲或大於17的曲目，並不總是能播放一次。

按期望順序播放 曲目／唱盤 (編程 (PROGRAM) 播放)

- 您可使用遙控器或在主機上操作PD-F507。
- 您可最多編程到32步。
- 括號 () 中的內容供主機操作。

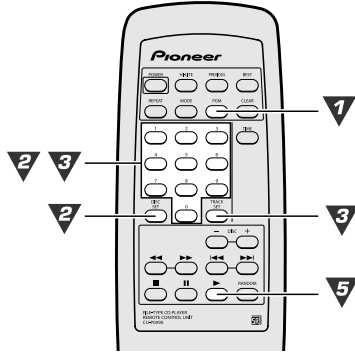

操作例：將唱盤2，曲目7當作第1步來編程。
唱盤5，曲目3作為第2步。

5

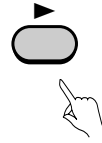

按下 ►。
編程播放從編入的第一首曲目開始播放。



下列操作能在正常播放下進行。

<在正常播放下進行曲目編程>
(直接編程)

- 1 按下編程 (PGM (PROGRAM)) 按鍵。
 - 編程模式啟動。
- 2 在播放時按下編程 (PGM (PROGRAM)) 按鍵。
 - 當前曲目被編程。

<在正常播放下進行曲目編程 (只適於遙控器)>
(預編程)

- 您可在正常播放時編程。(→操作例 1 2 3 4)
- 在當前曲目播放完之後，唱機將轉換到編程播放。
 - 按下 || 以直接轉換到編程模式。

下列操作只能在停止播放下進行。

<將整張唱盤編為一步>
(全盤編程)

如果您跳過操作例子的第3步 3，唱盤2就被編為第1步。

<編入一個暫停 (只適於遙控器)>
(暫停編程)

如果您在第4步 4 時按下 ||，您便編入一個暫停。當您按下 || 時，在顯示器上出現的不是唱盤號碼而是“PA”字樣。

- 例如，在為磁帶的兩面錄音而編程時，在一面的曲目編程完畢之後，按下 || 以插入暫停。在將磁帶倒好後，再按 || 以繼續錄音。

注意！！

- 您不可將暫停作為第1步或連續編入2個暫停。
- 當您編入一個暫停時，它將占據一步，從而使可編程曲目數減少一個。

- 消除一個編程...
在播放時按下 ■ 兩次 (或在停止模式下按下 ■ 一次)。在播放或停止模式下按下模式 (MODE) 按鍵或隨機 (RANDOM) 按鍵。另外，按下既往 (PREVIOUS) 按鍵也可消除一個程序。(或在停止模式下，按下最佳 (BEST) 按鍵)。
- 取消編程中的一步
在停止模式下，每按下 (清除) CLEAR按鍵一次，編程中最后一步就被清除掉。
- 如果一個程序中的唱盤缺席或裝反，播放時，顯示器上將出現 “** -no dISC” 字樣。程序中相應的一步將被消除，播放繼續到下一步。
- 即使當電源關斷時 (待機)，程序的內容也保存在存儲器中。

注意！！

- 如果在累積時間顯示之前就進行第5步 5，編程播放開始且不顯示時間。
- 如果編程中的總時間等於或大於100小時，則顯示器上不顯示。

1

在停止模式下按下編程 (PGM (PROGRAM)) 按鍵。

2

使用數字按鍵選擇唱盤，然後按下唱盤設定 (DISC SET)。
(使用唱盤 (DISC (-/+)) 來選擇唱盤號碼，然後按下編程 (PROGRAM) 按鍵。)

編程 (PGM) 指示燈開始閃爍。

3

使用數字按鍵選擇曲目，然後按下曲目設定 (TRACK SET) 按鍵。
(使用 ◀▶ 來選擇曲目號碼，然後按下編程 (PROGRAM) 按鍵。)

4

重復步驟2和3以選擇其他唱盤和曲目。
當曲目的時間被加上之後，編程 (PGM) 指示燈停止閃爍，顯示器出現如下畫面 (總時間)。

- 您可使用遙控器或在主機上操作PD-F507。
- 您可在主機上操作PD-F407。

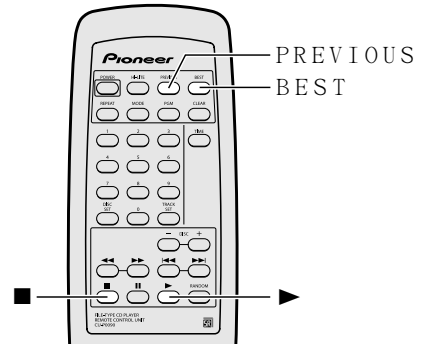
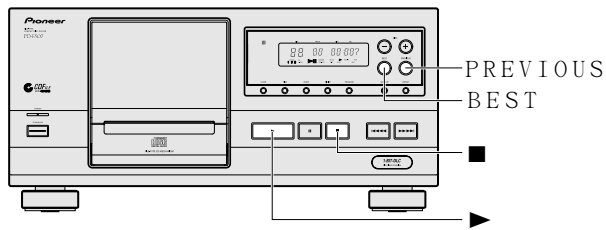

保存您喜愛的曲目（最佳選擇記憶）

在播放您所喜愛的曲目時，只要按下最佳（BEST）按鍵，您便可使用單觸記憶。您可保存最多15首曲目。

BEST



在播放您所鐘愛的曲目時，按下最佳（BEST）按鍵。最佳（BEST）指示燈閃爍，相應的唱盤號碼和曲目號碼記憶於存儲器之中。

<聽記憶的曲目>



在停止模式下，按下最佳（BEST）按鍵。最佳（BEST）指示燈點亮，且從最近記憶的曲目開始播放。

- 如果您在最佳播放時按下清除（CLEAR）按鍵，則當前曲目被消除，開始播放下一曲目。
- 在進行最佳播放時，不允許為了記憶同一曲目兩次而再度按下最佳（BEST）按鍵。
- 即使當電源關斷時（待機），記憶的內容也保存在存儲器中。
- 當記憶的曲目滿15首時，如果您再按下最佳（BEST）按鍵，則最早記憶的內容將被消除以記憶新的曲目。

尋找最近聽過的唱盤

- 該功能從最近聽過的唱盤開始，以倒序掃描唱盤。
- 該功能可記憶最多15張唱盤，如果超過15，則最早的內容將被消除以給新唱盤留出空間。

例：如果您順次播放 唱盤1，2，9，12和13。

PREVIOUS



按下既往（PREVIOUS）按鍵。

- 從最近播放過的唱盤開始，以13，12，9，2，1的順序，播放每張唱盤的第1首曲目約1分10秒鐘。

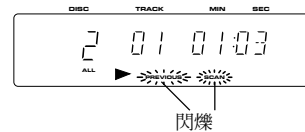

閃爍



當您找到想聽的唱碟時，按下▶按鍵。

- 既往唱盤掃描模式被取消，進入正常播放。

- 按下■以取消掃描。
- 在隨機、編程、精彩掃描和最佳記憶中播放的唱盤不在既往（PREVIOUS）之列。
- 如果第一首曲目短於1分鐘，則只播放約10秒鐘。如果第一首曲目短於10秒鐘，則播放整個曲目。

- 您可使用遙控器或在主機上操作PD-F507。
- 您可在主機上操作PD-F407。
- 括號 () 中的內容供主機操作。

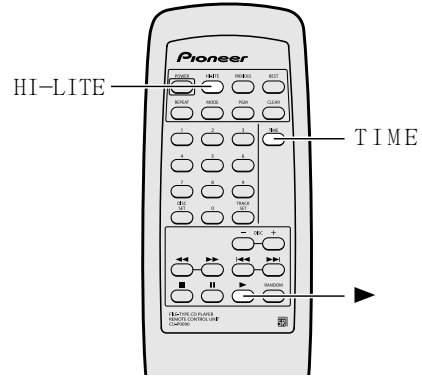
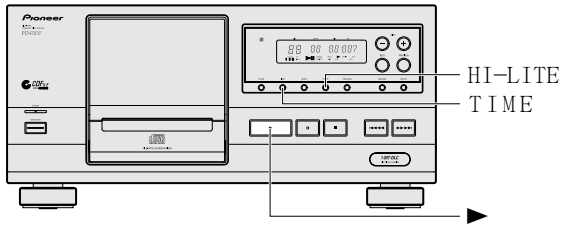

快速掃描唱盤上的曲目 (精彩掃描)

從曲目開頭起算的1分鐘處開始，播放當前模式下所有唱盤的所有曲目10秒鐘。

- 不論是在全部 (ALL) 還是在單張 (SINGLE) 播放模式下，播放模式指示器熄滅，所有唱碟被掃描一遍。

<唱盤掃描>

HI-LITE



按一次



在播放或停止模式下，按下精彩掃描 (HI-LITE) 按鍵。

- 從曲目開頭起算的1分鐘處開始，播放當前模式下所有唱盤的第一首曲目10秒鐘。

唱盤 (DISC) 和掃描 (SCAN) 指示燈閃爍。

<返回正常播放>



當找到期望的曲目時，按下 ▶。精彩掃描 (HI-LITE) 將被取消，返回正常播放。

- 按下 ■ 以取消精彩掃描 (HI-LITE)。

<曲目掃描>

HI-LITE



按二次



在播放或停止模式下，按下精彩掃描 (HI-LITE) 按鍵兩次。

- 從曲目開頭起算的1分鐘處開始，播放當前模式下所有唱盤的所有曲目10秒鐘。

掃描 (SCAN) 指示燈閃爍。

注意！！

- 在進行曲目掃描時，您可使用 ◀◀/▶▶ 以跳到下一曲目。
- 如果唱機在全部重復 (ALL REPEAT) 模式，精彩掃描 (HI-LITE) 將重復進行。
- 如果曲目短於1分鐘，則只播放約10秒鐘。如果第一首曲目短於10秒鐘，則播放整個曲目。
- 當按下重復 (REPEAT) 按鍵時，精彩掃描 (HI-LITE) 將重復進行。

<程序掃描>

HI-LITE



按一次



在編程模式下，按下精彩掃描 (HI-LITE) 按鍵。

- 從曲目開頭起算的1分鐘處開始，播放編程的所有曲目10秒鐘。

掃描 (SCAN) 指示燈閃爍。

<最佳選擇記憶掃描>

HI-LITE



按一次



在最佳選擇記憶掃描模式下，按下精彩掃描 (HI-LITE) 按鍵。

- 從曲目開頭起算的1分鐘處開始，播放最佳選擇記憶的所有曲目10秒鐘。

掃描 (SCAN) 指示燈閃爍。

使用時間 (TIME) 按鍵



在播放時按下時間 (TIME) 按鍵。

每按下時間 (TIME) 按鍵一次，顯示器將按如下順序變化。



注意！！

- 在編程模式下，顯示器出現程序步數和總時間。
- 在隨機 (RANDOM) 和編程 (PROGRAM) 播放時，唱盤剩余時間不被顯示。
- 曲目號碼大於24時，曲目剩余時間不被顯示。

故障排除

不當操作往往意味著麻煩和故障。如果您認為機器有問題，請先檢查下列各點。有時，故障出自別的機器之中。此時則應檢查別的機器和電器。如果經過下列的檢查之後仍不能使機器正常工作，請與附近的PIONEER授權維修中心或經銷商聯系以便維修。

症狀	可能的原因	排除方法
無聲音。	<ul style="list-style-type: none"> ● 輸出連線連接不當或鬆動。 ● 立體聲放大器操作不當。 ● 針型插頭及（或）放大器端子不干淨。 ● 唱機在暫停模式。 ● 唱盤的標籤面朝左放置。 	<ul style="list-style-type: none"> ● 妥當連接。 ● 檢查放大器的開關設定和音量旋鈕。 ● 清除臟物。 ● 按下 ▶ 或 II。 ● 重新放置唱盤使標籤面朝右。
當開始播放時，立即停止。 在播放中暫停或停止。	<ul style="list-style-type: none"> ● 唱盤插入錯誤。 ● 唱盤臟污。 	<ul style="list-style-type: none"> ● 將唱盤標籤面朝右裝入。 ● 清除唱盤上的臟污再播放。
遙控器不工作。（只限於PD-F507）	<ul style="list-style-type: none"> ● 電池耗盡。 ● 唱機和遙控器之間有障礙物。 	<ul style="list-style-type: none"> ● 更換電池。 ● 換個地方用遙控器或除去障礙物。

靜電或其他外部干擾可能引起本機功能異常。關掉電源再打開，或拔掉電源插頭再插上，將會使其恢復正常。

自診斷功能

本機裝備自診斷功能。
當操作發生異常時，在機器的顯示器出現錯誤信息（維修號碼）。這些錯誤可根據以下說明予以排除。

本機的顯示器

維修號碼

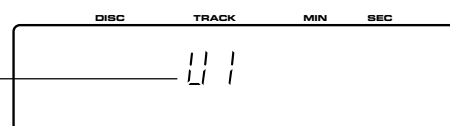

維修號碼	機器症狀	解決辦法
U 1	唱盤架中的唱盤裝載不當。	<ul style="list-style-type: none"> ● 重新裝好唱盤。（在插槽中只放一張唱盤） ● 檢查唱盤上是否有粘異物。 ● 檢查唱盤架上是否有異物。
U 2	機器的機械部分出現操作錯誤。	<ul style="list-style-type: none"> ● 檢查唱盤架上是否有異物。 ● 拔下電源線再重新插上。

如果相同的錯誤再次出現，則說明機械部分可能有問題。在請求維修時，請告知機器上出現的維修號碼。

規格

1. 一般

類型 CD數字式音響系統
 電源
 平刀口2插頭 AC 插頭機型 110 - 127/220 - 240,
 (可切換) 50/60 Hz
 功率 13W
 使用溫度 +5 °C - +35 °C
 重量 (不帶包裝) 4.8 Kg
 外形尺寸 420 (W) X 312 (D) X 193 (H) mm

2. 音響部

頻率響應 2 Hz -20 kHz
 通道間音量差 1.0 dB或者更小 (EIAJ)
 輸出電壓 2±0.3 Vrms (EIAJ)
 速度不均勻性 小於±0.001% (W.PEAK)
 (在可測水平之下) (EIAJ)
 通道 2通道 (立體聲)

3. 輸出端子

音頻線輸出
 控制輸入/輸出插孔 (只限於PD-F407)
 光學數字輸出插孔 (只限於PD-F507)

4. 確認附屬品

- 遙控器 (只限於PD-F507) 1
- AA/R6P型干電池 (只限於PD-F507) 2
- 輸出電纜 1
- 控制連線 (只限於PD-F407) 1
- CD襯里筆記檔案 1
- 索引標記紙 1
- 使用說明書 1

注意：
 因為改良等原因，機形和規格可能隨時變化，恕不另行通知。

日本先鋒公司出版
 版權 © 2004 日本先鋒公司
 版權所有

Published by Pioneer Corporation.
Copyright © 2004 Pioneer Corporation.
All rights reserved.

PIONEER CORPORATION

4-1, Meguro 1-Chome, Meguro-ku, Tokyo 153-8654, Japan

PIONEER ELECTRONICS (USA) INC.

P.O. BOX 1540, Long Beach, California 90810-1540, U.S.A. TEL: (800) 421-1404

PIONEER ELECTRONICS OF CANADA, INC.

300 Allstate Parkway, Markham, Ontario L3R OP2, Canada TEL: (905) 479-4411

PIONEER EUROPE NV

Haven 1087, Keetberglaan 1, B-9120 Melsele, Belgium TEL: 03/570.05.11

PIONEER ELECTRONICS ASIACENTRE PTE. LTD.

253 Alexandra Road, #04-01, Singapore 159936 TEL: 656-472-1111

PIONEER ELECTRONICS AUSTRALIA PTY. LTD.

178-184 Boundary Road, Braeside, Victoria 3195, Australia, TEL: (03) 9586-6300

PIONEER ELECTRONICS DE MEXICO S.A. DE C.V.

Blvd.Manuel Avila Camacho 138 10 piso Col.Lomas de Chapultepec, Mexico,D.F. 11000 TEL: 55-9178-4270

K002_En