

CM1089A

# Microwave Oven

(COMMERCIAL)

## Owner's Instructions & Cooking Guide

Please be advised that the Samsung warranty does NOT cover service calls to explain product operation, correct improper installation, or perform normal cleaning or maintenance.

**Planet  
First** 100 %  
Recycled Paper

This manual is made with 100 % recycled paper.

imagine the possibilities

Thank you for purchasing this Samsung product.  
To receive more complete service, please register  
your product at

[www.samsung.com/register](http://www.samsung.com/register)

**SAMSUNG**

## USING THIS INSTRUCTION BOOKLET

You have just purchased a SAMSUNG microwave oven. Your Owner's Instructions contain valuable information on cooking with your microwave oven:

- Safety precautions
- Suitable accessories and cookware
- Useful cooking tips
- Cooking tips

## LEGEND FOR SYMBOLS AND ICONS

 **WARNING** Hazards or unsafe practices that may result in **severe personal injury or death**.

 **CAUTION** Hazards or unsafe practices that may result in **minor personal injury or property damage**.

 Warning; Fire hazard

 Warning; Hot surface

 Warning; Electricity

 Warning; Explosive material

 Do NOT attempt.

 Do NOT touch.

 Do NOT disassemble.

 Follow directions explicitly.

 Unplug the power plug from the wall socket.

 Make sure the machine is grounded to prevent electric shock.

 Call the service center for help.

 Note

 Important



## IMPORTANT SAFETY INSTRUCTIONS

### READ CAREFULLY AND KEEP FOR FUTURE REFERENCE.

Make sure that these safety precautions are obeyed at all times.

**Before using the oven, confirm that the following instructions are followed.**

#### **WARNING** (Microwave function only)

-  **WARNING:** If the door or door seals are damaged, the oven must not be operated until it has been repaired by a competent person.
-  **WARNING:** It is hazardous for anyone other than a competent person to carry out any service or repair operation that involves the removal of a cover which gives protection against exposure to microwave energy.
-  **WARNING:** Liquids and other foods must not be heated in sealed containers since they are liable to explode.

- ★ **WARNING:** This appliance can be used by children aged from 8 years and above and persons with reduced physical, sensory or mental capabilities or lack of experience and knowledge if they have been given supervision or instruction concerning use of the appliance in a safe way and understand the hazards involved. Children shall not play with the appliance. Cleaning and user maintenance shall not be made by children unless they are aged from 8 years and above and supervised.
- ★ Only use utensils that are suitable for use in microwave ovens.
- ★ When heating food in plastic or paper containers, keep an eye on the oven due to the possibility of ignitions.
- ★ The microwave oven is intended for heating food and beverages. Drying of food or clothing and heating of warming pads, slippers, sponges, damp cloth and similar may lead to risk of injury, ignition or fire.
- ☒ If smoke is emitted, switch off or unplug the appliance and keep the door closed in order to stifle any flames.
- ★ **WARNING:** Microwave heating of beverages can result in delayed eruptive boiling, therefore care must be taken when handling the container.
- ★ **WARNING:** The contents of feeding bottles and baby food jars shall be stirred or shaken and the temperature checked before consumption, in order to avoid burns.
- ☒ Eggs in their shell and whole hard-boiled eggs should not be heated in microwave ovens since they may explode, even after microwave heating has ended.
- ★ The oven should be cleaned regularly and any food deposits removed.
- ☒ Failure to maintain the oven in a clean condition could lead to deterioration of the surface that could adversely affect the life of the appliance and possibly result in a hazardous situation.
- ☒ The appliance is not intended for installing in road vehicles, caravans and similar vehicles etc.

- ★ This appliance is not intended for use by persons (including children) with reduced physical, sensory or mental capabilities, or lack of experience and knowledge, unless they have been given supervision or instruction concerning use of the appliance by a person responsible for their safety.
- ★ Children should be supervised to ensure that they do not play with the appliance.
- ✎ If the supply cord is damaged, it must be replaced by the manufacturer, its service agent or similarly qualified persons in order to avoid a hazard.
- ✎ **WARNING:** Liquids or other foods must not be heated in sealed containers since they are liable to explode;
- ✎ The appliance should not be cleaned with a water jet.
- ★ This oven should be positioned proper direction and height permitting easy access to cavity and control area.
- ★ Before using the your oven first time, oven should be operated with the water during 10 minute and then used.

- ★ If the oven generates a strange noise, a burning smell, or smoke is emitted, unplug the power plug immediately and contact your nearest service center.
- ★ The microwave oven has to be positioned so that plug is accessible.
- ✎ The microwave oven is intended to be used on the counter or counter top use only, the microwave oven shall not be placed in a cabinet.

**⚠ WARNING**  
**(Oven function only) - Optional**

- ✎ **WARNING:** When the appliance is operated in the combination mode, children should only use the oven under adult supervision due to the temperatures generated.
- ★ During use the appliance becomes hot. Care should be taken to avoid touching heating elements inside the oven.
- ✎ **WARNING:** Accessible parts may become hot during use. Young children should be kept away.
- ✎ A steam cleaner is not to be used.

- ❑ **WARNING:** Ensure that the appliance is switched off before replacing the lamp to avoid the possibility of electric shock.
- ★ **WARNING:** The appliance and its accessible parts become hot during use. Care should be taken to avoid touching heating elements. Children less than 8 years of age shall be kept away unless continuously supervised.
- ★ This appliance can be used by children aged from 8 years and above and persons with reduced physical, sensory or mental capabilities or lack of experience and knowledge if they have been given supervision or instruction concerning use of the appliance in a safe way and understand the hazards involved. Children shall not play with the appliance. Cleaning and user maintenance shall not be made by children without supervision.
- ❑ Do not use harsh abrasive cleaners or sharp metal scrapers to clean the oven door glass since they can scratch the surface, which may result in shattering of the glass.

- ❑ The temperature of accessible surfaces may be high when the appliance is operating.
- ❑ The door or the outer surface may get hot when the appliance is operating.
- ❑ Keep the appliance and its cord out of reach of children less than 8 years.
- ❑ Appliances are not intended to be operated by means of an external timer or separate remote-control system.

This product is a Group 2 Class B ISM equipment. The definition of group 2 which contains all ISM equipment in which radio-frequency energy is intentionally generated and/or used in the form of electromagnetic radiation for the treatment of material, and EDM and arc welding equipment. For Class B equipment is equipment suitable for use in domestic establishments and in establishments directly connected to a low voltage power supply network which supplies buildings used for domestic purposes.

## INSTALLING YOUR MICROWAVE OVEN

Place the oven on a flat level surface 85 cm above the floor. The surface should be strong enough to safely bear the weight of the oven.

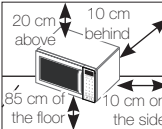
1. When you install your oven, make sure there is adequate ventilation for your oven by leaving at least 10 cm (4 inches) of space behind and, on the sides of the oven and 20 cm (8 inches) of space above.
 
2. Remove all packing materials inside the oven.
3. Install the roller ring and turntable. Check that the turntable rotates freely. (Turntable type model only)
4. This microwave oven has to be positioned so that plug is accessible.
  - ☑ If the supply cord is damaged, it must be replaced by the manufacturer, its service agent or similarly qualified persons in order to avoid a hazard. For your personal safety, plug the cable into a proper AC earthed socket.
  - ☑ Do not install the microwave oven in hot or damp surroundings like next to a traditional

oven or radiator. The power supply specifications of the oven must be respected and any extension cable used must be of the same standard as the power cable supplied with the oven. Wipe the interior and the door seal with a damp cloth before using your microwave oven for the first time.

## CLEANING YOUR MICROWAVE OVEN

The following parts of your microwave oven should be cleaned regularly to prevent grease and food particles from building up:

- Inside and outside surfaces
- Door and door seals
- Turntable and Roller rings (Turntable type model only)

- ☑ **ALWAYS** ensure that the door seals are clean and the door closes properly.
- ☑ Failure to maintain the oven in a clean condition could lead to deterioration of the surface that could adversely affect the life of the appliance and possibly result in a hazardous situation.

1. Clean the outside surfaces with a soft cloth and warm, soapy water. Rinse and dry.

2. Remove any splashes or stains on the inside surfaces of oven with a soapy cloth. Rinse and dry.
3. To loosen hardened food particles and remove smells, place a cup of diluted lemon juice in the oven and heat for ten minutes at maximum power.
4. Wash the dishwasher-safe plate whenever necessary.

 **DO NOT** spill water in the vents. **NEVER** use any abrasive products or chemical solvents. Take particular care when cleaning the door seals to ensure that no particles:

- Accumulate
- Prevent the door from closing correctly

 **Clean** the microwave oven cavity right after each use with a mild detergent solution, but let the microwave oven cool down before cleaning in order to avoid injury.

When cleaning the upper part inside the cavity, it will be convenient to turn heater downward by 45 ° and clean it.

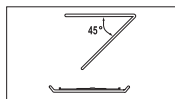

(Swing heater model only)



## STORING AND REPAIRING YOUR MICROWAVE OVEN

A few simple precautions should be taken when storing or having your microwave oven serviced.















The oven must not be used if the door or door seals are damaged:

- Broken hinge
- Deteriorated seals
- Distorted or bent oven casing

Only a qualified microwave service technician should perform repair

-  **NEVER** remove the outer casing from the oven. If the oven is faulty and needs servicing or you are in doubt about its condition:
  - Unplug it from the wall socket
  - Contact the nearest after-sales service centre
-  If you wish to store your oven away temporarily, choose a dry, dustfree place. **Reason :** Dust and damp may adversely affect the working parts in the oven.

 The Light bulb should not be replaced in person for safety reasons. Please contact nearest authorised Samsung customer care to arrange for a qualified engineer to replace the bulb.

 <b>WARNING</b>				
 Only qualified staff should be allowed to modify or repair the appliance.	✓	✓	✓	✓
 Do not heat liquids and other food in sealed containers for microwave function.	✓	✓	✓	✓
 For your safety, do not use high-pressure water cleaners or steam jet cleaners.	✓	✓	✓	✓
 Do not install this appliance; near heater, inflammable material; in a humid, oily or dusty location, in a location exposed to direct sunlight and water or where gas may leak; on an level ground.	✓	✓	✓	✓
 This appliance must be properly grounded in accordance with local and national codes.	✓	✓	✓	✓
 Remove all foreign substances such as dust or water from the power plug terminals and contact points using a dry cloth on a regular basis.	✓	✓	✓	✓
 Do not pull or excessively bend or place heavy object on the power cord.	✓	✓	✓	✓
 In the event of a gas leak (such as propane gas, LP gas, etc.), ventilate immediately without touching the power plug.	✓	✓	✓	✓
 Do not touch the power plug with wet hands.	✓	✓	✓	✓
 Do not turn the appliance off by unplugging the power plug while an operation is in progress.	✓	✓	✓	✓

 Do not insert fingers or foreign substances, If any foreign substance such as water has entered the appliance, unplug the power plug and contact your nearest service centre.	✓	✓	✓	✓
 Do not apply excessive pressure or impact to the appliance.	✓	✓	✓	✓
 Do not place the oven over a fragile object such as a sink or glass object.	✓	✓		
 Do not use benzene, thinner, alcohol, steam cleaner or high pressure cleaner to clean the appliance.	✓	✓	✓	✓
 Ensure that the power voltage, frequency and current are the same as those of the product specifications.	✓	✓		✓
 Plug the power plug into the wall socket firmly. Do not use a multiple plug adapter, an extension cord or an electric transformer.	✓	✓	✓	
 Do not hook the power cord on a metal object, insert the power cord between the objects or behind the oven.	✓	✓	✓	
 Do not use a damaged power plug, damaged power cord or loose wall socket. When the power plug or power cord is damaged, contact your nearest service centre.	✓	✓	✓	✓
 Do not pour or directly spray water onto the oven.	✓	✓		
 Do not place objects on the oven, inside or on the door of the oven.	✓	✓	✓	
 Do not spray volatile material such as insecticide onto the surface of the oven.	✓	✓		
 Do not store flammable materials in the oven. Take special care when heating dishes or drinks that contain alcohol as alcohol vapours may contact a hot part of the oven.	✓		✓	✓



★ Keep children away from the door when opening or closing it as they may bump themselves on the door or catch their fingers in the door.	✓	✓	✓	✓
★ <b>WARNING:</b> Microwave heating of beverages can result in delayed eruptive boiling, therefore care must be taken when handling the container; To prevent this situation ALWAYS allow a standing time of at least 20 seconds after the oven has been switched off so that the temperature can equalize. Stir during heating, if necessary, and ALWAYS stir after heating. In the event of scalding, follow these FIRST AID instructions: <ul style="list-style-type: none"> <li>Immerse the scalded area in cold water for at least 10 minutes.</li> <li>Cover with a clean, dry dressing.</li> <li>Do not apply any creams, oils or lotions.</li> </ul>	✓	✓	✓	✓

**CAUTION** 

★ Only use utensils that are suitable for use in microwave ovens; DO NOT use any metallic containers, Dinnerware with gold or silver trimmings, Skewers, forks, etc. Remove wire twist ties from paper or plastic bags. Reason: Electric arcing or sparking may occur and may damage the oven.	✓		✓	✓
☐ Do not use your microwave oven to dry papers or clothes.	✓		✓	✓
★ Use shorter times for smaller amounts of food to prevent overheating and burning food.	✓		✓	✓
☐ Do not immerse the power cable or power plug in water and keep the power cable away from heat.	✓	✓		

☐ Eggs in their shell and whole hard-boiled eggs should not be heated in microwave ovens since they may explode, even after microwave heating has ended; Also do not heat airtight or vacuum-sealed bottles, jars, containers, nuts in shells, tomatoes etc.			✓	✓
☐ Do not cover the ventilation slots with cloth or paper. They may catch fire as hot air escapes from the oven. The oven may also overheat and switch itself off automatically, and will remain off until it cools sufficiently.	✓		✓	
☐ Always use oven mitts when removing a dish from the oven to avoid unintentional burns.			✓	
★ Stir liquids halfway during heating or after heating ends and allow the liquid stand at least 20 seconds after heating to prevent eruptive boiling.			✓	
★ Stand at arms length from the oven when opening the door to avoid getting scalded by escaping hot air or steam.			✓	
☐ Do not operate the microwave oven when it is empty. The microwave oven will automatically shut down for 30 minutes for safety purposes. We recommend placing a glass of water inside the oven at all times to absorb microwave energy in case the microwave oven is started accidentally.		✓		✓
★ Install the oven in compliance with the clearances stated in this manual. (See installing your microwave oven.)	✓			✓
★ Take care when connecting other electrical appliances to sockets near the oven.	✓	✓	✓	

## **PRECAUTIONS TO AVOID POSSIBLE EXPOSURE TO EXCESSIVE MICROWAVE ENERGY.(MICROWAVE FUNCTION ONLY)**

Failure to observe the following safety precautions may result in harmful exposure to microwave energy.

- (a) Under no circumstances should any attempt be made to operate the oven with the door open or to tamper with the safety interlocks (door latches) or to insert anything into the safety interlock holes.
- (b) Do NOT place any object between the oven door and front face or allow food or cleaner residues to accumulate on sealing surfaces. Ensure that the door and door sealing surfaces are kept clean by wiping after use first with a damp cloth and then with a soft dry cloth.
- (c) Do NOT operate the oven if it is damaged until it has been repaired by a qualified microwave service technician trained by the manufacturer. It is particularly important that the oven door closes properly and that there is no damage to the:
  - (1) door (bent)
  - (2) door hinges (broken or loose)
  - (3) door seals and sealing surfaces
- (d) The oven should not be adjusted or repaired by anyone other than a properly qualified microwave service technician trained by the manufacturer.

Samsung will charge a repair fee for replacing an accessory or repairing a cosmetic defect if the damage to the unit and/or damage to or loss of the accessory was caused by the customer. Items this stipulation covers include:

- (a) A Dented, Scratched, or Broken Door, Handle, Out-Panel, or Control Panel.
  - (b) A Broken or missing Tray, Guide Roller, Coupler, or Wire Rack.
- Use this appliance only for its intended purpose as described in this instruction manual. Warnings and Important Safety Instructions in this manual do not cover all possible conditions and situations that may occur. It is your responsibility to use common sense, caution, and care when installing, maintaining, and operating your appliance.
  - Because these following operating instructions cover various models, the characteristics of your microwave oven may differ slightly from

those described in this manual and not all warning signs may be applicable. If you have any questions or concerns, contact your nearest service centre or find help and information online at [www.samsung.com](http://www.samsung.com).

- This microwave oven is supposed for heating food. It is intended for domestic home-use only. Do not heat any type of textiles or cushions filled with grains, which could cause burns and fire. The manufacturer cannot be held liable for damage caused by improper or incorrect use of the appliance.
- Failure to maintain the oven in a clean condition could lead to deterioration of the surface that could adversely affect the life of the appliance and possible result in a hazardous situation.



## **CORRECT DISPOSAL OF THIS PRODUCT (WASTE ELECTRICAL & ELECTRONIC EQUIPMENT)**

### **(Applicable in countries with separate collection systems)**

This marking on the product, accessories or literature indicates that the product and its electronic accessories (e.g. charger, headset, USB cable) should not be disposed of with other household waste at the end of their working life. To prevent possible harm to the environment or human health from uncontrolled waste disposal, please separate these items from other types of waste and recycle them responsibly to promote the sustainable reuse of material resources.

Household users should contact either the retailer where they purchased this product, or their local government office, for details of where and how they can take these items for environmentally safe recycling.

Business users should contact their supplier and check the terms and conditions of the purchase contract. This product and its electronic accessories should not be mixed with other commercial wastes for disposal.

## CONTENTS

Quick look-up guide .....	11
Oven .....	12
Control panel .....	12
Checking that your oven is operating correctly .....	13
Cooking/reheating .....	13
Using the start and +30 sec button .....	13
Using the stop/cancel button .....	13
Setting cooking time and power level .....	14
Power levels .....	14
Using defrost button .....	15
Memory programming .....	15
Using the check button .....	16
Resetting the memory program cycle counter .....	17
Setting the sound .....	17
Using the double quantity button .....	18
Cookware guide .....	18
Cooking guide .....	19
What to do if you are in doubt or have a problem .....	21
Technical specifications .....	22

## QUICK LOOK-UP GUIDE

### If you want to cook some food.

1. Place the food in the oven.  
Select the power level by pressing the **Power Level** () button once or more time.



2. Select the cooking time by pressing the **Number** buttons as required (Max : 30 min.).



3. Press **Start** () button.

**Result :** Cooking starts. The oven beeps four times when cooking is over.



### If you want to defrost some food.

1. Place the frozen food in the oven.  
Press the **Defrost** () button.



2. Select the cooking time by pressing the **Number** buttons as required (Max : 30 min.).



3. Press **Start** () button.

**Result :** Cooking starts. The oven beeps four times when cooking is over.



### If you want to adjust the cooking time.

Leave the food in the oven.  
Press +30s once or more times for each extra 30 seconds.



## OVEN

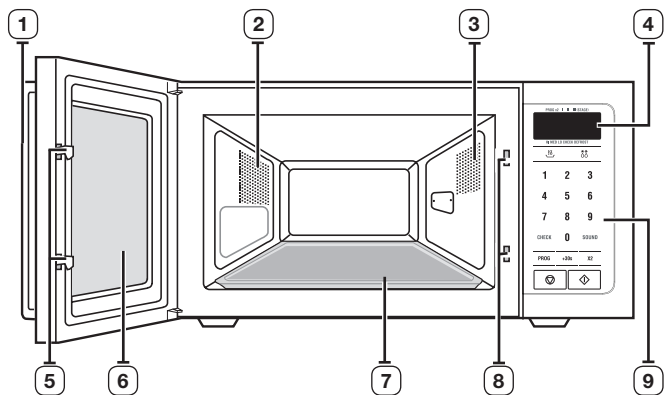

- |                      |                           |
|----------------------|---------------------------|
| 1. HANDLE            | 5. DOOR LATCHES           |
| 2. VENTILATION HOLES | 6. DOOR                   |
| 3. OVEN LAMP         | 7. CERAMIC PLATE          |
| 4. DISPLAY           | 8. SAFETY INTERLOCK HOLES |
|                      | 9. CONTROL PANEL          |

## CONTROL PANEL

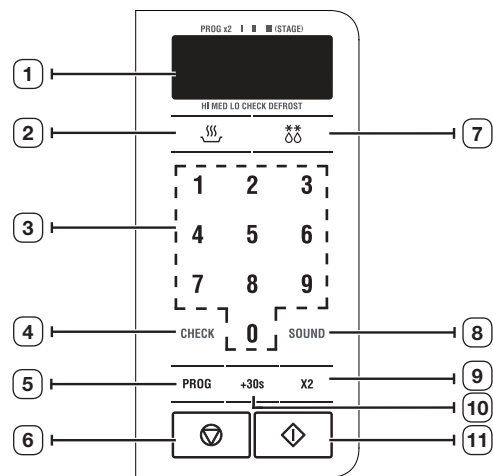

- |                       |                           |
|-----------------------|---------------------------|
| 1. DISPLAY            | 7. DEFROST BUTTON         |
| 2. POWER LEVEL BUTTON | 8. SOUND BUTTON           |
| 3. NUMBER BUTTONS     | 9. DOUBLE QUANTITY BUTTON |
| 4. CHECK BUTTON       | 10. +30s BUTTON           |
| 5. PROGRAMME BUTTON   | 11. START BUTTON          |
| 6. STOP/CANCEL BUTTON |                           |

## CHECKING THAT YOUR OVEN IS OPERATING CORRECTLY

The following simple procedure enables you to check that your oven is working correctly at all times.

First, place a bowl of water on the ceramic plate. Then, close the door.

1. Select the power level by pressing the **Power Level** () button once or more time.



2. Select the cooking time by pressing the **Number** buttons as required (Max : 30 min.). Press **Start** () button.



**Result :** The oven heats the water for 4 or 5 minutes. The water should then be boiling.

-  The oven must be plugged into an appropriate wall socket. The ceramic plate must be in position in the oven. If a power level other than the maximum is used, the water takes longer to boil.

### Auto energy saving function.

If you do not select any function when appliance is in the middle of setting or operating with temporary stop condition, function is canceled and the display will be turned off after 10 minutes.

Oven Lamp will be turned off after 5 minutes with door open condition.

## COOKING/REHEATING

The following procedure explains how to cook or reheat food.

**ALWAYS** check your cooking settings before leaving the oven unattended. First, place the food in the centre of the ceramic plate. Then, close the door.

1. Select the power level by pressing the **Power Level** () button once or more time.



2. Select the cooking time by pressing the **Number** buttons as required (Max : 30 min.).



**Result :** The oven light comes on.



-  **Never** switch the microwave oven on when it is empty.

## USING THE START AND +30 SEC BUTTON

This button offers a convenient way to heat food in 30 seconds increments at the High power level.

1. Press the **+30s (+30s)** button once for each 30 sec. Press **Start** () button.  
For example, press **+30s (+30s)** button twice for one minute. The time will display, and press **Start** () button.



2. Add Seconds to a program in progress by pressing the **+30s (+30s)** button for each 30 sec. you want to add.



## USING THE STOP/CANCEL BUTTON



The **Stop/Cancel** () button allows you to clear instructions you have entered. It also allows you to pause the oven's cooking cycle, so that you can check the food.



1. To pause the oven during cooking, press **Stop/Cancel** () button once.

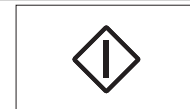

2. To restart, press **Start** () button.



-  To correct a mistake you have just entered, press **Stop/Cancel** () button once, then re-enter the instructions.

-  To cancel cooking setting during cooking, press **Stop/Cancel** () button twice.

## SETTING COOKING TIME AND POWER LEVEL

### ONE STAGE COOKING.

You can stop cooking at any time to check the food.

1. Press the **Power Level** (🔥) button to select the power. By pressing the **Power Level** (🔥) button repeatedly, you can select the power level - HI, MED, or LO.



2. Use the **Number** buttons to enter the cooking time. You can set a time from one second to 30 minutes.

To set a time over one minute, enter the second as well.

For example, to set 10 minutes, enter **1, 0, 0, 0**.

10:00



3. Press the **Start** (▶) button to begin cooking.



- ✍ The maximum allowable cooking time is 30 min. If the time exceeds 30 min, the display will show "E3", then press **Stop/Cancel** (⊖) button and repeat the steps.

E3

### MULTI-STAGE COOKING

You can stop cooking at any time to check the food.

1. Press the **Power Level** (🔥) button to select the power. By pressing the **Power Level** (🔥) button repeatedly, you can select the power level - HI, MED, or LO.



2. Use the **Number** buttons to enter the cooking time. You can set a time from one second to 30 minutes.

To set a time over one minute, enter the second as well.

For example, to set 10 minutes, enter **1, 0, 0, 0**.

10:00



3. Repeat step 1 and 2 for II or III stage cooking.

4. Press the **Start** (▶) button to begin cooking.



### POWER LEVELS

You can choose among the power levels below.

Power Level	Percentage	Output
HIGH (HI)	100 %	1050 W
MEDIUM (MED)	70 %	735 W
LOW (LO)	50 %	525 W
DEFROST (❄)	30 %	315 W

- ✍ If you select higher power level, the cooking time must be decreased.

- ✍ If you select lower power level, the cooking time must be increased.

- ✍ The maximum allowable cooking time is 30 min. If the time exceeds 30 min, the display will show "E3", then press **Stop/Cancel** (⏹) button and repeat the steps.

E3

## USING DEFROST BUTTON

The defrost time and power level are set automatically. You simply select the programme and the weight.

- ✍ Use only dishes that are microwave-safe.

First, place the frozen food in the centre of the ceramic plate and close the door.

1. Press the **Defrost** (❄) button.



2. Press the **Number** buttons to set the defrosting time. You can set a time from one second to 30 minutes.



3. Press the **Start** (▶) button.



- ✍ The maximum allowable cooking time is 30 min. If the time exceeds 30 min, the display will show "E3", then press **Stop/Cancel** (⏹) button and repeat the steps.

E3

## MEMORY PROGRAMMING

### ONE STAGE COOKING.

1. Upon pressing the **Program(PROG)** button, the oven will enter Program mode. The display will be cleared.



2. Using the **Number** buttons, enter the program number from 1 to 20.



3. Then, press the **Power Level** (⏻) button to select power. By pressing the **Power Level** (⏻) button repeatedly, you can select the power level - HI, MED, or LOW.



4. Use the **Number** buttons to enter the cooking time. You can set a time from one second to 30 minutes. To set a time over one minute, enter the seconds as well.

For example, to set 10 minutes, enter **1, 0, 0, 0**.



5. Press the **Program(PROG)** button to complete setting the memory. The display will show '0'.



- ✍ The maximum allowable cooking time is 30 min. If the time exceeds 30 min, the display will show "E3", then press **Stop/Cancel** (⏹) button and repeat the steps.

E3



**MULTI - STAGE COOKING.**

1. Upon pressing the **Program(PROG)** button, the oven will enter Program mode. The display will be cleared.



2. Using the **Number** buttons, enter the program number from 1 to 20.



3. Then, press the **Power Level** () button to select power. By pressing the **Power Level** () button repeatedly, you can select the power level - HI, MED, or LOW.





4. Use the **Number** buttons to enter the cooking time. You can set a time from one second to 30 minutes. To set a time over one minute, enter the seconds as well. For example, to set 10 minutes, enter **1, 0, 0, 0**.



5. Repeat step 3 and 4 for II or III stage memory programming.

6. Press the **Program(PROG)** button to complete setting the memory. The display will show '0'.



-  The maximum allowable cooking time is 30 min. If the time exceeds 30 min, the display will show "E3", then press **Stop/Cancel** () button and repeat the steps.

**USING MEMORY PROGRAMMING.**

Press the **Number** buttons to select user-programmed memory functions (please refer to memory programming) from 1 to 20. Press the **Start** () button.

-  If the DEFROST function is included in STAGE COOKING, it works at first.

-  If you want to change program, just reset MEMORY PROGRAMMING.

**USING THE CHECK BUTTON**

Confirming the cooking time and Power Level in each memory program.

1. Clear all operations by pressing the **Stop/Cancel** () button. Press the **Check (CHECK)** button to enter Check mode.



2. Using the **Number** buttons, enter the program number from 1 to 20. For example, suppose you press '5', for the Memory Program 5 which is HI Power Level, I Stage cooking with a time of 6 minutes and 30 seconds, 6:30.



First, '5' will be displayed. but will change to show the



3. After one second, the display will clear automatically. If you want to check other Memory Programs, just enter the Memory Program numbers.



4. Press the **Stop/Cancel** () button to exit the Check mode.

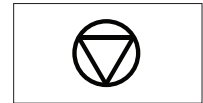



Reading each Memory Program's Cycle Counter

1. Clear all operations by pressing the **Stop/Cancel** (⊖) button.

Press the Check button to enter Check mode.

**CHECK**

2. Press the **Start** (◇) button, and then press any **Number** button, from 1 to 20, and the number of cycles for that particular Memory Program will be displayed. The cycle count is displayed in units of 10.

For example, if Memory Program 5 has been used 100 times, the display will show '10'.

10



1	2	3
4	5	6
7	8	9
CHECK	0	SOUND

- As the display uses units of 10, the cycle counts are approximate. The cycle count displayed increases every ten cycles.

- For example, if the cycle count were 90-99, "9" would be displayed. The "9" would change to "10" on the 100th cycle. The cycle counter function has a limit of 99,990 cycles. Once that number is exceeded, the cycle counter will automatically clear and start again from "0".

3. After one second, the display will clear automatically. If you want to check other Memory Programs, just enter the Memory Program numbers.

1	2	3
4	5	6
7	8	9
CHECK	0	SOUND

4. Press the **Stop/Cancel** (⊖) button to exit the Checking mode.



## RESETTING THE MEMORY PROGRAM CYCLE COUNTER

1. Clear all operations by pressing the **Stop/Cancel** (⊖) button.

The display will show ':0'.

:0



2. Hold the Number '0' and then press **Defrost** (❄❄) button.

The microwave will emit a Beep sound confirming the reset operation.

Clearing all numbers on the display using the Stop/Cancel button will show "0" as below.

0



3. Press the **Stop/Cancel** (⊖) button to exit the Resetting mode.



## SETTING THE SOUND

1. Press the **Sound** button to adjust sound volume.

The basic sound volume is "LO" and when you press the **Sound** button repeatedly, the sound volume changes in the following order - MED, HI, OFF, LO one by one.

Sound

**SOUND**

2. Press the **Start** (◇) button to exit **Sound** mode. The display will show ":0".

:0



Indicator	Sound
HI	Loud
MED	Middle
LO	Low
Blank	Off

## USING THE DOUBLE QUANTITY BUTTON

1. Press the **Double Quantity(X2)** button.



2. By using the **Number** buttons, enter the Memory Program number from 1 to 20.

For example, suppose you press '5' button, for **Memory Program 5** which is HI Power Level, I Stage cooking with a time of 6 minutes and 30 seconds, 6:30.



3. The **Memory Program** then operates for double the user-programmed time, which in this case makes 13 minutes.



(6.30 x 2 = 13)

-  The maximum allowable cooking time is 30 min. If doubling the programmed time exceeds the maximum allowable cooking time, the display will show "E3", then press **Stop/Cancel** (⏹) button.



1	2	3
4	5	6
7	8	9
CHECK	0	SOUND

## COOKWARE GUIDE

To cook food in the microwave oven, the microwaves must be able to penetrate the food, without being reflected or absorbed by the dish used. Care must therefore be taken when choosing the cookware. If the cookware is marked microwave-safe, you do not need to worry. The following table lists various types of cookware and indicates whether and how they should be used in a microwave oven.

Cookware	Microwave-safe	Comments
<b>Aluminum foil</b>	✓ X	Can be used in small quantities to protect areas against overcooking. Arcing can occur if the foil is too close to the oven wall or if too much foil is used.
<b>China and earthenware</b>	✓	Porcelain, pottery, glazed earthenware and bone china are usually suitable, unless deco-rated with a metal trim.
<b>Disposable polyester cardboard dishes</b>	✓	Some frozen foods are packaged in these dishes.
<b>Fast-food packaging</b>		
<ul style="list-style-type: none"> <li>Polystyrene cups containers</li> </ul>	✓	Can be used to warm food. Overheating may cause the polystyrene to melt.
<ul style="list-style-type: none"> <li>Paper bags or newspaper</li> </ul>	X	May catch fire.
<ul style="list-style-type: none"> <li>Recycled paper or metal trims</li> </ul>	X	May cause arcing.
<b>Glassware</b>		
<ul style="list-style-type: none"> <li>Oven-to-tableware</li> </ul>	✓	Can be used, unless decorated with a metal trim.
<ul style="list-style-type: none"> <li>Fine glassware</li> </ul>	✓	Can be used to warm foods or liquids. Delicate glass may break or crack if heated suddenly.
<ul style="list-style-type: none"> <li>Glass jars</li> </ul>	✓	Must remove the lid. Suitable for warming only.

Cookware	Microwave-safe	Comments
<b>Metal</b>		
<ul style="list-style-type: none"> <li>Dishes</li> <li>Freezer bag twist ties</li> </ul>	x	May cause arcing or fire.
<b>Paper</b>		
<ul style="list-style-type: none"> <li>Plates, cups, napkins and Kitchen paper</li> <li>Recycled paper</li> </ul>	✓	For short cooking times and warming. Also to absorb excess moisture.
	x	May cause arcing.
<b>Plastic</b>		
<ul style="list-style-type: none"> <li>Containers</li> <li>Cling film</li> <li>Freezer bags</li> </ul>	✓	Particularly if heat-resistant thermoplastic. Some other plastics may warp or discolour at high temperatures. Do not use Melamine plastic.
	✓	Can be used to retain moisture. Should not touch the food. Take care when removing the film as hot steam will escape.
	✓ x	Only if boilable or oven-proof. Should not be airtight. Prick with a fork, if necessary.
<b>Wax or grease-proof paper</b>	✓	Can be used to retain moisture and prevent spattering.

✓ : Recommended

✓x : Use Caution

x : Unsafe

## COOKING GUIDE

### Reheating Dish Entrees

Use the power levels and times in this table as a guide lines for reheating.

Food	Portion (g)	Method	Power	Time (min.)	Standing time (min.)
Plated meal (chilled)	350	Plate a meal of 2-3 chilled components on a ceramic dish. Reheat covered.	MEDIUM	6½-7	3
Chicken curry & rice (chilled)	300	Plate a meal of 2 chilled components on a ceramic dish (e.g. rice and curry). Reheat covered.	MEDIUM	4½-5½	3
Pasta with sauce (chilled)	350	Put pasta (e.g. spaghetti or egg noodles) into a deep ceramic plate. Reheat covered. Stir during reheating.	HIGH	4-5	3
Filled pasta in sauce (chilled)	350	Put filled pasta (e.g. ravioli, tortellini) in a deep ceramic plate. Reheat covered. Stir occasionally during reheating.	MEDIUM	4½-5½	3
Lasagne (chilled)	400	Put the chilled lasagne (pre-cooked product) widthways in the centre of table. Reheat covered.	HIGH	4½-5½	3
Bechamel potatoes (chilled)	400	Put bechamel potatoes (pr-cooked product) widthways in the centre of table. Reheat covered.	MEDIUM	5½-6½	3
Baked potatoes (ready cooked and chilled)	500 (2 x 250)	Pierce film and put potatoes on a flat ceramic plate.	HIGH	5-6	2-3

### Reheating Soup and Stew

Use the power levels and times in this table as a guide lines for reheating.

Food	Portion (g)	Method	Power	Time (min.)	Standing time (min.)
Soup (chilled)	250	Pour into a deep ceramic plate. Reheat covered. Stir during reheating.	HIGH	3-3½	2-3
Stew (chilled)	250	Pour into a deep ceramic plate or bowl. Reheat covered. Stir during reheating.	MEDIUM	4-4½	2-3
	500			5½-6	
Bean stew (canned)	350	Pour into a deep ceramic plate or bowl. Reheat covered. Stir during reheating.	MEDIUM	3½-4	2-3
Soup (frozen)	1000	Pour into a glass pyrex dish with lid. Reheat covered. Stir during reheating.	HIGH	20-22	2-3

### Cooking Breakfast

Use the power levels and times in this table as a guide lines for cooking.

Food	Portion	Method	Power	Time (min.)	Standing time (min.)
Bacon (chilled)	2 slices (20 g)	Put bacon slices on kitchen paper on a flat ceramic plate.	HIGH	ca. 1½	1
Scrambled eggs	2 eggs	Beat eggs, add salt and 2 tbsp. milk. Put in a deep ceramic plate. Stir several times during cooking.	LO	ca. 2½	1
Baked beans (canned)	250 g	Put the beans in a deep ceramic plate. Reheat covered. Stir during reheating.	MEDIUM	2½-3½	1-2

### Reheating Snacks

Use the power levels and times in this table as a guide lines for cooking.

Food	Portion	Method	Power	Time (min.)	Standing time (min.)
Cheeseburger (chilled)	150 g (1 pc)	Put burger on kitchen paper on a ceramic plate.	HIGH	1-1½	2-3
Cheeseburger (frozen)	150 g (1 pc)	Put burger on kitchen paper on a ceramic plate.	LO	3-3½	2-3
Hot dog (chilled)	125 g (1 pc)	Put hot dog on kitchen paper on a ceramic plate.	MEDIUM	1½	2-3
Pizza; slice (chilled)	100 g	Put the pizza slice on a kitchen paper on ceramic plate.	LO	1½-2	1-2
Meat & vegetable wrap (chilled)	200 g	Put the chilled wrap (filled pastry roll) on kitchen paper on a ceramic plate.	MEDIUM	2-2½	1-2
Quiche/pie (chilled)	150 g	Put quiche on kitchen paper on a ceramic plate.	MEDIUM	2-2½	2-3
Croissants	60 g (2 pcs)	Put the croissants on kitchen paper on a ceramic plate. Serve croissants directly after warming.	MEDIUM	½-1	-

### Defrosting and Cooking Desserts

Use the power levels and times in this table as a guide lines for cooking.

Food	Portion	Method	Power	Time (min.)	Standing time (min.)
Berries in sauce	250 g	Put frozen fruits in a glass pyrex bowl with lid. Reheat covered. Stir once during standing time.	MEDIUM	6-6½	2-3
Yeast dumplings with jam filling	300 g (2 pcs)	Put frozen yeast dumplings (pre-cooked) side by side in a glass pyrex bowl with lid. Moist the top of them with cold water. Cook covered.	MEDIUM	4½-5	2-3

## Defrosting Bread and Cake

Use the power levels and times in this table as a guide lines for cooking.

Food	Portion	Method	Power	Time (min.)	Standing time (min.)
Baguettes	150 g (1 pc)	Put the baguette widthways on kitchen paper in the oven.	DEFROST	ca. ½	3-5
Bread rolls	50 g (4 pcs)	Put the rolls side by side on kitchen paper in the oven.	DEFROST	ca. 3	3-5
Fruit cake	120 g (1 pc)	Put the piece of cake on a ceramic plate.	DEFROST	3-3½	5-10
Cream cake roll	100 g (1 pc)	Put the piece of cake on a ceramic plate. Place plate in the centre of table. Let stand until cream is totally defrosted.	DEFROST	ca. 1	10-20

## WHAT TO DO IF YOU ARE IN DOUBT OR HAVE A PROBLEM

If you have any of the problems listed below try the solutions given.

### This is normal.

- Condensation inside the oven.
- Air flow around the door and outer casing.
- Light reflection around the door and outer casing.
- Steam escaping from around the door or vents.

### The oven does not start when you press the start button.

- Is the door completely closed?

### The food is not cooked at all.

- Have you set the timer correctly?
- Is the door closed?
- Have you overloaded the electric circuit and caused a fuse to blow or a breaker to be triggered?

### The food is either overcooked or undercooked.

- Was the appropriate cooking length set for the type of food?
- Was an appropriate power level chosen?



### The oven causes interference with radios or televisions.

- Slight interference may be observed on televisions or radios when the oven is operating. This is normal. To solve this problem, install the oven away from televisions, radios and aerials.

### The light bulb is not working.

- The Light bulb should not be replaced in person for safety reasons. Please contact nearest authorised Samsung customer care, to arrange for a qualified engineer to replace the bulb.

### Sparking and cracking occur inside the oven (arcing).

- Have you used a dish with metal trimmings?
  - Have you left a fork or other metal utensil inside the oven?
  - Is aluminum foil too close to the inside walls?
-  Door opening starts automatic operation of fan for 5 minutes. When placing or removing food items, as soon as the door is opened the lamp and fan will start automatically. The automatic starting of the fan is intentional, so no service call is required. The fan will automatically upon closing the door after 5 minutes.
-  If the above guidelines do not enable you to solve the problem, then contact your local SAMSUNG customer service centre. Please have the following information read.
- The model and serial numbers, normally printed on the rear of the oven
  - Your warranty details
  - A clear description of the problem
- Then contact your local dealer or SAMSUNG aftersales service.

## TECHNICAL SPECIFICATIONS

SAMSUNG strives to improve its products at all times. Both the design specifications and these user instructions are thus subject to change without notice.

<b>Model</b>	<b>CM1089A</b>
<b>Power source</b>	230 V ~ 50 Hz
<b>Power consumption</b> Microwave	1600 W, 7 A
<b>Output power</b>	230 V : 1050 W (IEC-705) (4 power levels including defrost)
<b>Operating frequency</b>	2450 MHz
<b>Cooling method</b>	Cooling fan motor
<b>Dimensions (W x H x D)</b> Outside Oven cavity	517 x 297 x 412 mm 336 x 225 x 349 mm
<b>Volume</b>	26 liter
<b>Weight</b> Net Gross	17.5 kg 19.0 kg

## MEMO

**MEMO**

**MEMO**

**ENGLISH**



QUESTIONS OR COMMENTS

COUNTRY	CALL	OR VISIT US ONLINE AT
AUSTRIA	0810 - SAMSUNG (7267864, € 0.07/min)	www.samsung.com
BELGIUM	02-201-24-18	www.samsung.com/be (Dutch) www.samsung.com/be_fr (French)
DENMARK	70 70 19 70	www.samsung.com
FINLAND	030-6227 515	
FRANCE	01 48 63 00 00	www.samsung.com/fr
GERMANY	0180 5 SAMSUNG bzw. 0180 5 7267864* (*0,14 €/Min. aus dem dt. Festnetz, aus dem Mobilfunk max. 0,42 €/Min.)	www.samsung.com
ITALIA	800-SAMSUNG(726-7864)	
CYPRUS	8009 4000 only from landline (+30) 210 6897691 from mobile and land line	
GREECE	80111-SAMSUNG (80111 726 7864) only from land line (+30) 210 6897691 from mobile and land line	
LUXEMBURG	261 03 710	
NETHERLANDS	0900-SAMSUNG (0900-7267864) (€ 0,10/Min)	
NORWAY	815 56480	
PORTUGAL	808 20-SAMSUNG(808 20 7267)	
SPAIN	902 - 1 - SAMSUNG (902 172 678)	
SWEDEN	0771 726 7864 (SAMSUNG)	
SWITZERLAND	0848 - SAMSUNG(7267864, CHF 0.08/min)	www.samsung.com/ch (German) www.samsung.com/ch_fr (French)
U.K	0330 SAMSUNG (7267864)	www.samsung.com
EIRE	0818 717100	

Code No.: DE68-03310E-01