

Pioneer *sound.vision.soul*

COMPACT DISC PLAYER

CDJ-400

DJS Control Guide

DJS

■ DJS Control Guide

By connecting your CDJ-400 (compact disc player) to your computer, you can control programs on your PC, including the DJ software made by Pioneer, namely DJS. When you combine your CDJ-400 with DJS, you can use the CDJ-400 to achieve all of the following:

1. Control two players (A and B) in DJS
2. Manipulate selected songs
3. Play back DJS sound (functions as a computer controlled audio device)

* There are functions that cannot be achieved with other companies' PC programs. For further information, refer to the Operating Instructions of the relevant PC program.

DJS software is designed for using MP3 files to enjoy playing the DJ on a computer. (You may not record the audio created in DJ play.)

Please refer to the **CDJ-400 Operating Instructions (printed manual)** and the DJS user's manual (PDF file) together when you work with DJS.

Table of Contents

Chapter 1	Connecting your CDJ-400 and DJS	
1-1	Using 2 CDJ-400s	3
1-2	Using 1 CDJ-400	4
Chapter 2	Precautions when Starting Up	
2-1	Selecting a Player Control	5
2-2	CDJ-400 Audio Device Function Settings	6
Chapter 3	Using your CDJ-400 to Control DJS	
3-1	Operating a Player with DJS	8
3-2	Selecting Songs	9
3-3	Switching the Player Control	9
Chapter 4	Using the Support Site	10

● Please be sure to read the Software End User License Agreement thoroughly before starting to use DJS. For more information on the DJS Software End User License Agreement, its minimum operating environment and installation procedures, please refer to the Quick Start Guide (PDF file).

● Copying of copyrighted materials such as music is unlawful unless permitted by a legal exception or consented to by the rightowners. Music recorded from CDs, etc. is protected by the copyright laws of each country, as well as by international agreements. The person who makes such a recording, himself, bears full responsibility for legal compliance in the use thereof.

* Pioneer is a registered trademark of the Pioneer Corporation.

* Microsoft and Windows are registered trademarks of the Microsoft Corporation of the United States and other countries. The formal name of Windows is the Microsoft Windows Operating System.

* MPEG Layer-3 audio coding technology licensed from Fraunhofer IIS and Thomson multimedia.

Supply of this product only conveys a license for private, non-commercial use and does not convey a license nor imply any right to use this product in any commercial (i.e. revenue-generating) real time broadcasting (terrestrial, satellite, cable and/or any other media), broadcasting/streaming via internet, intranets and/or other networks or in other electronic content distribution systems, such as pay-audio or audio-on-demand applications. An independent license for such use is required. For details, please visit <http://www.mp3licensing.com>.

* All other company names and names of products are either the trademarks or registered trademarks of their respective company(ies).

©2007 PIONEER CORPORATION. All rights reserved.

Chapter 1

Connecting your CDJ-400 and DJS

When you use your CDJ-400 in conjunction with DJS, you can control DJS from your CDJ-400.

By controlling DJS from your CDJ-400, you can manipulate it with the feel of using a DJ player for operations that to date you have done with your computer's mouse and keyboard.

Connecting 1 CDJ-400

Using just one CDJ-400, you can switch between and control two DJS players.

→ '1-2 Using 1 CDJ-400'

1-1 Using 2 CDJ-400s

Connecting two CDJ-400s to your computer gives a direct feel to controlling your DJS player A and player B, and thus expands the range for DJ performance.

Of course all the basic functions, such as play, cue, scratch, tempo control and so on can make song selections from the DJS music list using controls like the Rotary dial.

● Configuration of Audio Output from a CDJ-400 (connection example)

The CDJ-400 is set up with a function for operating as a computer's audio device.

If you set the DJS audio output to your CDJ-400, you can output the DJS audio from the audio output terminal of your CDJ-400 in the very same way as a music source, such as music CD or USB memory that can be played on the CDJ-400.

→ '2-2 CDJ-400 Audio Device Function Settings'

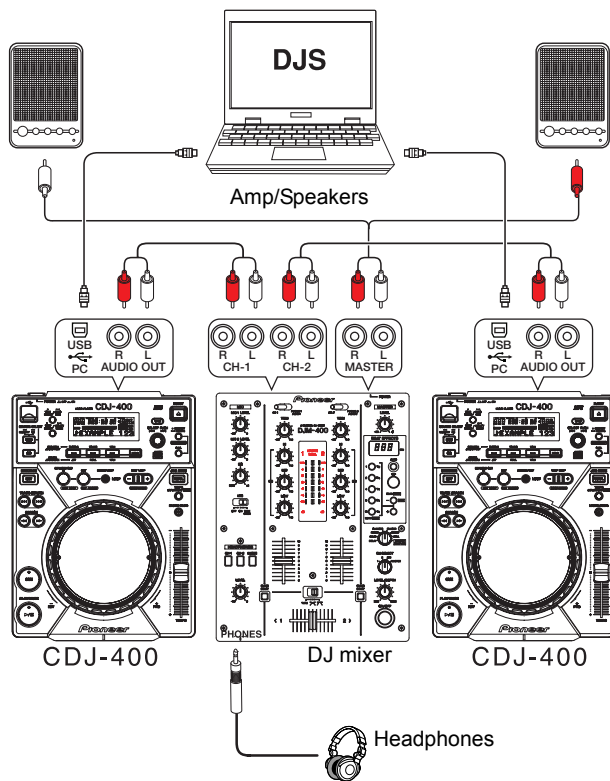

● Configuration when not Outputting Audio from a CDJ-400

For configurations (connection examples) when the CDJ-400's audio output is not used and the DJS audio is output from another audio device, please refer to '● Configuration when using the DJS Mixer Functions (Example of Connections)' and '● Configuration when using an External DJ mixer (Example of Connections)' on the next page.

Warning!

Updating your Version of DJS

In order to use your CDJ-400 in conjunction with DJS, it is necessary to update DJS to version 1.500 or later. Please refer to the DJS user's manual for directions on how to update your version of DJS.

→ 'Chapter 4 Using the Support Site'

Warning!

Before Connecting to your Computer

If you are going to connect and use a CDJ-400 with your computer, install the driver software for the CDJ-400 onto your computer.

For information on obtaining the driver software for your CDJ-400 and how to install it, please refer to **CONNECTIONS of the CDJ-400** as well as the following Web page:

<http://www.prodjnet.com/support/en/>

Note

Connecting a CDJ-400 and a DJ mixer

Connect the audio output terminal (AUDIO OUT) of the CDJ-400 and the audio input terminal (CH) of the DJ mixer.

Connect the white plugs of the audio cable that comes with the CDJ-400 to the white L (left) terminals and the red plugs to the red R (right) terminals.

Connecting Amps & Headphones to a DJ mixer

Connect either an amp or speakers to the audio output terminal (MASTER) of the DJ mixer, and/or connect headphones to the headphone terminal (PHONES). For information on how to make the connections, please refer to Operating Instructions of the DJ mixer you are using.

1-2 Using 1 CDJ-400

Using just one CDJ-400, you can switch between and control DJ players A & B. Of course all the basic functions, such as play, cue, scratch, tempo control and so on can make song selections from the DJ's music list using controls like the Rotary dial.

● Configuration when using the DJ's Mixer Functions (Example of Connections)

DJS master (for amp or speakers) and monitor (for headphones) audio is output to each audio output of your computer.

Your computer needs to have two or more audio output systems.

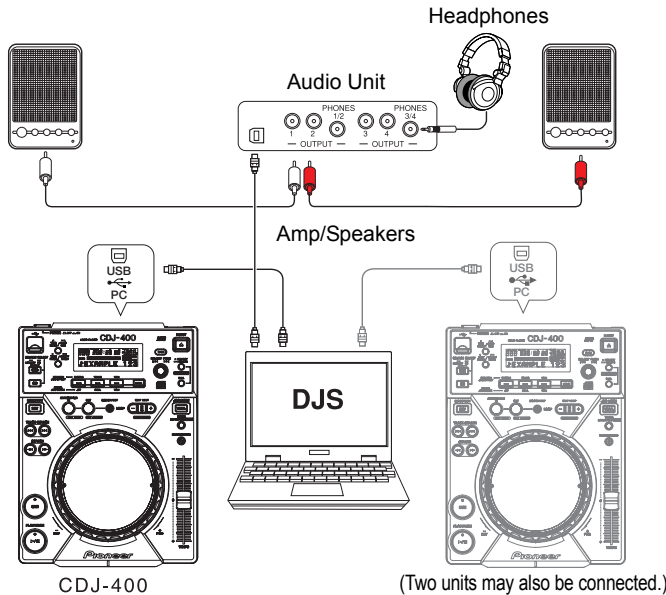

● Configuration when using an External DJ mixer (Example of Connections)

The DJ's player A and player B audio is output to each audio output of your computer.

Your computer needs to have two or more audio output systems.

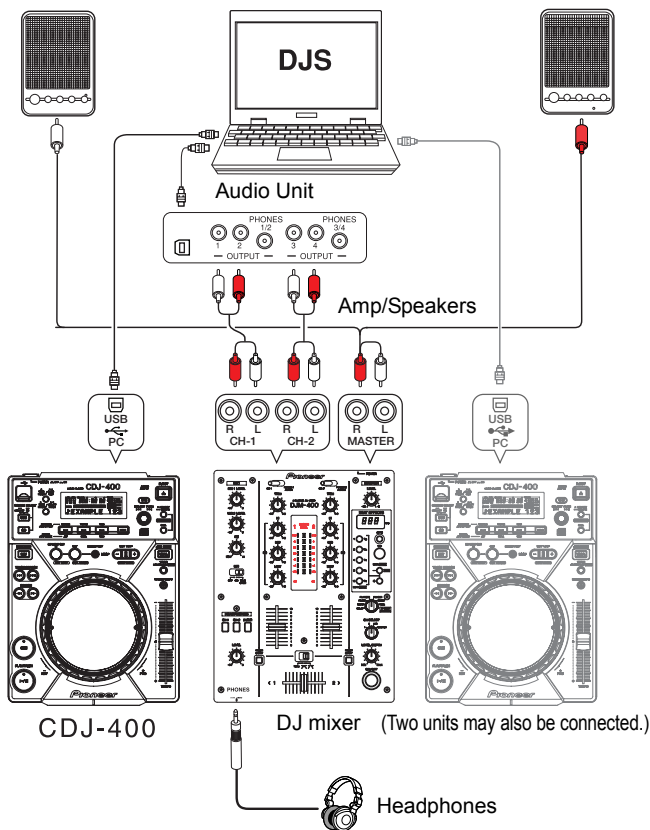

Warning!

Before Connecting to your Computer

If you are going to connect and use a CDJ-400 with your computer, install the driver software for the CDJ-400 onto your computer. For information on obtaining the driver software for your CDJ-400 and how to install it, please refer to **CONNECTIONS of the CDJ-400** as well as the following web page.
<http://www.prodjnet.com/support/en/>

Note

DJS Mixer Functions

On the DJ's settings screen, switch the setting to using the internal mixer and specify where the audio is output to for the master (amp or speakers) and the monitor (headphones).

→ '2-2 CDJ-400 Audio Device Function Settings'

Audio Unit

If your computer only has one audio output system, please add another audio device, such as a sound card or an audio unit.

For information on connecting your computer with audio devices as well as on driver installation, please refer to the Operating Instructions of each of the audio devices.

Note

Using an External DJ mixer

On the DJ's settings screen, switch the setting to using an external mixer and specify where to output the audio for player A and player B.

→ '2-2 CDJ-400 Audio Device Function Settings'

Audio Unit

If your computer only has one audio output system, please add another audio device, such as a sound card or an audio unit.

For information on connecting your computer with audio devices as well as on driver installation, please refer to the Operating Instructions of each audio device.

List Player

If your computer has three or more audio output systems, you can output audio for three players, namely player A, player B and a list player.

Connecting Amps & Headphones to a DJ mixer

Connect either an amp or speakers to the audio output terminal (MASTER) of the DJ mixer, and/or connect headphones to the headphone terminal (PHONES). For information on how to make the connections, please refer to the Operating Instructions of the DJ mixer you are using.

Chapter 2

Precautions when Starting Up

Before starting to play with your CDJ-400, computer and DJS, select a player control and where the audio is output.

2-1 Selecting a Player Control

Connect the CDJ-400 to your computer with a USB cable.

For information on each of the cables that come with the CDJ-400 as well as each type of the CDJ-400's cable terminals, please refer to **CONNECTIONS** in the **Operating Instructions of your CDJ-400**.

- 1** Start up your computer.
- 2** Connect a USB cable to the USB port on the back of your CDJ-400 and to your computer's USB port and then turn on your CDJ-400.
 - Alternatively, you can also power up your CDJ-400 first and then connect the CDJ-400 to your computer.
- 3** Start up DJS.
 - Once DJS starts up, the [DJ Play] screen is displayed.
- 4** Select PC with your CDJ-400's USB select button (SOURCE SELECT).
 - Each time you press the USB select button, the indicator switches between MEMORY and PC.

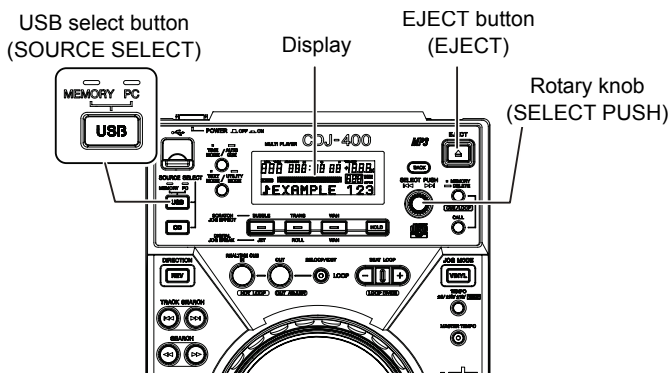

- 5** Rotate the CDJ-400's rotary knob (SELECT PUSH) to select the DJS player (A or B) you wish to assign.
 - Assigning a CDJ-400 to DJS Player A
 - When you turn the Rotary dial to the left, PLAYER A? is shown on the Display of your CDJ-400; press the Rotary dial to select it.
 - Assigning a CDJ-400 to DJS Player B
 - When you turn the Rotary dial to the right, PLAYER B? is shown on the Display of your CDJ-400; press the Rotary dial to select it.

When connecting two CDJ-400s

After you assign one of your CDJ-400s to a player (Either A or B), assign the other CDJ-400 to the other DJS player (A or B).

When connecting one CDJ-400

When PC is selected, if you press the EJECT button (EJECT), the assigned DJS player switches from A to B (or from B to A).

→'3-3 Switching the Player Control'

Warning!

Before Connecting to your Computer

If you are going to connect and use a CDJ-400 with your computer, install the driver software for the CDJ-400 onto your computer. For information on obtaining the driver software for your CDJ-400 and how to install it, please refer to **CONNECTIONS of the CDJ-400** as well as the following web page.
<http://www.prodjnet.com/support/en/>

Warning!

Starting up DJS

First connect your CDJ-400 and power it up, then start up DJS.

Removing a CDJ-400

Always close DJS before disconnecting your CDJ-400 or turning it OFF.

Warning!

When three or more CDJ-400s are connected

Even if you connect three or more CDJ-400s, you will not be able to use the third or additional CDJ-400s to operate DJS or to output the DJS audio.

2-2 CDJ-400 Audio Device Function Settings

Make the setting for where audio will be output on the DJS [DJ Play] screen.
Start up DJS and make the settings on the [Mixer/Sound Card] screen in Preferences.

When Using the DJS Mixer Functions

Set the audio outputs for the DJS master (amp and/or speakers) and the monitor (headphones).

→ [● Configuration when using the DJS Mixer Functions \(Example of Connections\)](#)

When Using an External DJ mixer

Specify where to output the audio for the DJS players A and B.

→ [● Configuration when using an External DJ mixer \(Example of Connections\)](#)

→ [● Configuration of Audio Output from a CDJ-400 \(connection example\)](#)

1 Open the [Mixer/ Sound Card] settings screen in Preferences.

- On the settings menu on the left hand side of Preferences, click [Mixer/ Sound Card] to open the [Mixer/ Sound Card] settings screen.

2 Click either [Internal Mixer] or [External Mixer] and then click [ASIO].

- **Internal Mixer:**
Select if you are using the DJS mixer functions.
- **External Mixer:**
Select if you are using an external DJ mixer (outputting audio from CDJ-400).



Note

Changing DJS Settings

Make changes to the various DJS settings on the different types of Preferences settings screens. After clicking [File] on the DJS menu, click [Preferences].

Note

Selecting ASIO or DirectX

When using a CDJ-400, we recommend that you select [ASIO]. Before you connect your CDJ-400 to your computer, be sure to install the driver software for the CDJ-400. If you are using an audio device that is not [ASIO] compliant, please select [DirectX].

CDJ-400 Driver Software

For information on obtaining the driver software and how to install it, please refer to [CONNECTIONS of the CDJ-400](#) as well as the following Web page:
<http://www.prodjnet.com/support/en/>

3 Select the output terminal of the CDJ-400 as a sound card.

- **Sound card 1 (SC1):**
After clicking the check box for [Sound Card 1 (SC1)] ON, click to select the audio output terminal (device/channel name) from the list of sound cards.
- **Sound card 2 (SC2):**
After clicking the check box for [Sound Card 2 (SC2)] ON, click to select the audio output terminal (device/channel name) from the list of sound cards.

CDJ-400 Audio Output Terminal (Device/Channel Name)

If one CDJ-400 is connected:

“PIONEER CDJ-400 ASIO” is displayed in the list of sound cards.

If two CDJ-400s are connected:

Both “PIONEER CDJ-400 ASIO: CDJ-400 1” and “PIONEER CDJ-400 ASIO: CDJ-400 2” are displayed in the list of sound cards. “CDJ-400 1” or “CDJ-400 2” is displayed in the CDJ-400 display corresponding to its respective channel, so select the CDJ-400 that is positioned on the left for player A and the CDJ-400 positioned on the right for player B.

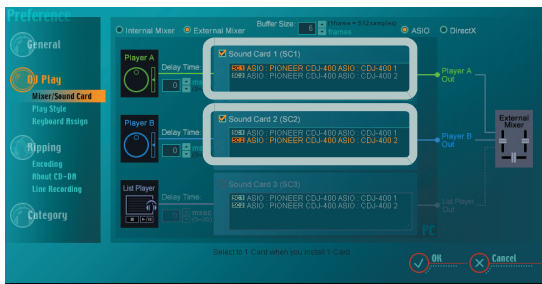

Selecting a Sound Card:

You can select audio devices other than the CDJ-400 as the sound card. When one is selected, the DJS audio is output from the selected audio device and audio is not output from the CDJ-400 Audio output connectors.

4 Click [OK].

- Click [OK]. The [Mixer/Sound Card] setting screen will close.

Note

Selecting a Sound Card

Sound cards and/or audio units other than the CDJ-400 may be selected from the sound cards that are displayed in the list.

When one is selected, the DJS audio is output from the selected sound card or audio unit and audio is not output from the CDJ-400 audio output terminal.

- • [Configuration when using the DJS Mixer Functions \(Example of Connections\)](#)
- • [Configuration when using an External DJ mixer \(Example of Connections\)](#)

Adding Audio Devices

If your computer only has one audio output system, please add another audio device, such as a sound card or an audio unit.

For information on connecting your computer with audio devices as well as on driver installation, please refer to the Operating Instructions of each audio device.

Adjusting the Delay Time

If you are using more than one sound card and/or audio unit and there are differences in their responsiveness, you can match them up by setting a delay time (adding a delay time) for the audio output with a fast response time to the audio output timing of the audio output unit with the slower response time.

If you are using two CDJ-400s, no adjustments in the delay time are required. Set the delay time of sound card 1 (SC1) and sound card 2 (SC2) to 0 msec.

Adjusting the Buffer Size

If the audio gets interrupted during playback, increase the size of the buffer.

Player L (List Player)

If your computer has three or more audio output systems, you can output audio for three players, namely player A, player B and a list player.

Chapter 3

Using your CDJ-400 to Control DJS

When you connect your CDJ-400 to your computer, you can control DJS from the CDJ-400.

By controlling DJS from your CDJ-400, you can manipulate it with the feel of using a DJ player for operations that to date you have done with your computer's mouse and keyboard

Of course all the basic functions, such as play, cue, scratch, tempo control and so on can make song selections from the DJS music list using controls like the Rotary dial.

3-1 Operating a Player with DJS

You can use the CDJ-400 to operate either player A or player B on the [CJ Play] screen.

1 Select PC with your CDJ-400's USB select button (SOURCE SELECT).

- If you have set the DJS audio output to your CDJ-400, the DJS audio will be output from your CDJ-400's audio output terminal.
→ '2-2 CDJ-400 Audio Device Function Settings'

2 Operate the CDJ-400 Player.

- When you operate the various buttons on your CDJ-400, such as the jog dial or the tempo adjustment knob, it operates the player in the [DJ Play] screen.

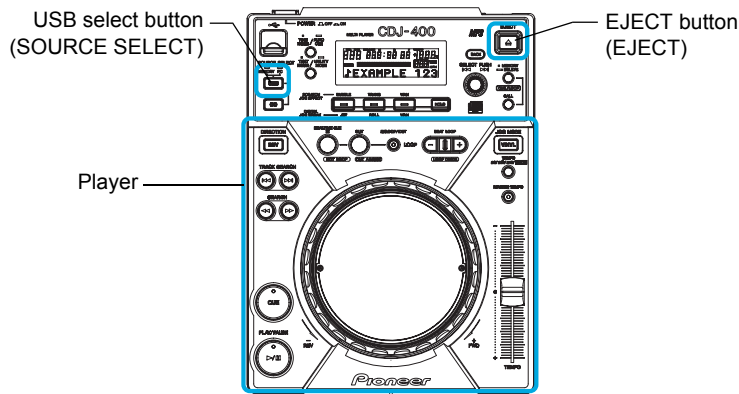

Functions that are Linked with the [DJ Play] Screen (Player Functions)

CDJ-400 Operation Control	Control Linked on the [DJ Play] Screen
PLAY/PAUSE	PLAY/PAUSE button
CUE	CUE button
SEARCH	SEARCH buttons
TRACK SEARCH	TRACK SEARCH buttons
IN / REAL TIME CUE	IN/REALTIME CUE/HOT LOOP button
OUT	OUT/OUT ADJUST button
RELOOP/EXIT	RELOOP/EXIT button
JOG MODE	JOG MODE VINYL button (VINYL mode / CDJ mode)
TEMPO $\pm 6/\pm 10/\pm 16$ /WIDE	TEMPO control range button
MASTER TEMPO	MASTER TEMPO button
TEMPO	TEMPO control slider
JOG (-REV/+FWD)	Jog dial

For information on how the different button functions work, please refer to **PANEL FACILITIES** in the **CDJ-400 Operating Instructions**.

Warning!

Before Connecting to your Computer

If you are going to connect and use a CDJ-400 with your computer, install the driver software for the CDJ-400 onto your computer. For information on obtaining the driver software for your CDJ-400 and how to install it, please refer to **CONNECTIONS of the CDJ-400** as well as the following web page.
<http://www.prodjnet.com/support/en/>

Note USB Select Button (SOURCE SELECT)

Each time you press the USB select button, the indicator switches between MEMORY and PC.

Note EJECT Button (EJECT)

When one CDJ-400 is connected, you can switch DJS operations from player A to player B (or from player B to player A).
→ '3-3 Switching the Player Control'

Spin (when in VINYL mode)

If you spin the jog dial of your CDJ-400 very quickly, even after you let go of it, it will continue playing at the speed and in the direction that the jog dial is rotating until it stops. You cannot do this Spin play with the mouse.

Simultaneous Operations

You can do the following operations at the same time from a CDJ-400 player.

- If you rotate the jog dial while holding down SEARCH, it accelerates the search play speed.
- While playing a cue point sample, if you hold down the CUE button, you can operate the jog dial.
- While playing a cue point sample, if you hold down the CUE button and the press the PLAY button, even if you let go of the CUE button, it keeps on playing without returning to the CUE point.
- While playing a cue point sample, if you hold down the CUE button and press the Loop In Button (Real Time Cue), the playback point is recorded as the CUE point. When you release the CUE button, it returns to the CUE point.
- When you are in the VINYL mode, if you hold down the jog dial and press the CUE button, the playback point is recorded as the CUE point. When you release the jog dial, it returns to the CUE point.
- When you are in the VINYL mode, if you hold down the jog dial and press the Loop In (Real Time Cue) button, the playback point is recorded as the CUE point. Even when you release the jog dial, it continues playing without returning to the CUE point.

Unlinked Player Functions

The following CDJ-400 buttons do not link up with the [DJ Play] screen. (No Function in DJS)

- Beat Loop / Loop Divide Buttons (BEAT LOOP)
- Reverse Button (DIRECTION)

3-2 Selecting Songs

You can use the CDJ-400 to operate Tracklists or Playlists on the [DJ Play] screen.

1 Select PC with your CDJ-400's USB select button (SOURCE SELECT).

- If you have set the DJS audio output to your CDJ-400, the DJS audio will be output from your CDJ-400's audio output terminal.
→ '2-2 CDJ-400 Audio Device Function Settings'

2 Operate the track list or play list.

- You can use the controls of your CDJ-400, like the Rotary dial, Folder BACK button, and the HOLD button to work with the track list or play list that is displayed in the [DJ Play] screen.

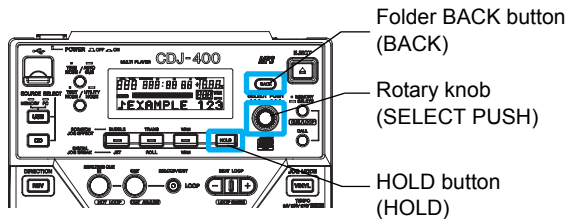

Aligning the selected line with the song you want to play

CDJ-400 Operation Control	Functions that are Linked with the [DJ Play] screen
Rotary dial (Rotate)	Rotate it clockwise and the selected line moves downwards. Rotate it counterclockwise and the selected line moves upwards.
Rotary dial (Push)	If the selected line is on a song, then the selected song is loaded to player A (or player B) and played. If the selected line is on a category, such as a genre, artist, album, etc., then the line moves to the next list down and the list of songs in the selected category is displayed.
Folder BACK button (Push)	The line moves to the next list up. (Genre, artist, album, etc.)
HOLD button (Push)	If a list is closed, it opens the list.

3-3 Switching the Player Control

When one CDJ-400 is connected, if you press the EJECT button (EJECT) while PC is selected, the assigned DJS player switches from A to B (or from B to A). However, where the DJS audio is output does not switch automatically switch from A to B (or from B to A), so when you are outputting the DJS audio from the audio output terminal of the CDJ-400, be sure to switch where the DJS audio is output, using the [Mixer/Sound Card] screen in Preferences, as necessary.

→ '2-2 CDJ-400 Audio Device Function Settings'

When two CDJ-400s are connected

The assigned DJS player doesn't switch even if the EJECT button (EJECT) is pressed. Close DJS and turn off your CDJ-400, and then select a player control and where the audio is output by following 'Chapter 2 Precautions when Starting Up'.

Note

USB Select Button (SOURCE SELECT)

Each time you press the USB select button, the indicator switches between MEMORY and PC.

Note

Track Lists and Play Lists

The format of music lists can be switched on the [Play Style] settings screen in DJS Preferences. On the settings menu on the left hand side of Preferences, click [Play Style] to open the [Mixer/Sound Card] settings screen.

Vertical Scrolling

If you move the selected line to the top (or the bottom), the list will scroll vertically and display the selected line.

Selecting artists or albums

If you put the selected line on [Artist/Album] in the category column and then push the Rotary dial, a list of artists or albums is displayed.

If you put the selected line on an artist or an album and then press the Rotary dial, a list of songs is displayed.

TEXT MODE Button (TEXT MODE)

Switches the text that is shown on the CDJ-400's Display.

- Title, Album, Artist

TIME MODE/AUTO CUE button (TIME MODE / AUTOCUE)

Switches the time display.

- Elapsed Time (TIME) / Time Remaining (REMAIN)

If you press and hold it, it toggles the autocue function ON and OFF.

The Auto Cue Function

When a song is loaded, this function automatically sets a cue to the point immediately before the audio starts to play.

When using a play list

When the format of the music list is in Play List, the selected song is loaded and goes into standby mode.

Warning!

When three or more CDJ-400s are connected

Even if you connect three or more CDJ-400s, you will not be able to use the third or additional CDJ-400s to operate DJS or to output the DJS audio.

Chapter 4 Using the Support Site

Before contacting us about how to use DJS or with technical questions, please check the User's Manual recorded on the DJS CD-ROM as well as the FAQ on the DJS support site.

- To connect to the DJS support site, click [File] on the DJS menu and then click [Internet].
When using the DJS support site, it is necessary to enter the login name and password you specified when you registered as a DJS user.
- When using the DJS support site, please have the following details at hand when you contact us: customer's name, product name, installation key, model and specs of the computer (CPU, amount of memory, peripheral devices connected, etc.), version of the operating system and a detailed description of the problem you are experiencing.
- We are only able to provide support for DJS users who have completed user registration. Please take care of the login name and password you specified during user registration in the same way as the installation key and registration ID so you do not forget them.
 - * For information about installation of DJS or how to complete user registration, please refer to the User's Manual that is recorded on the DJS CD-ROM.
- If you experience difficulties in installing the software or completing user registration, please refer to our home page on the internet.

Information on Installation and User Registration

<http://www.prodjnet.com/djs/support>

- * If you have questions about your computer, peripheral devices or technical questions, such as about combinations with products other than those we support, please check with the manufacturer of the device or contact the sales outlet.
- There are DJS version updates scheduled in order to improve the performance and add functionality. By completing the user registration, you not only gain access to our support site, but it also allows you to download the updater program. By all means update your version of DJS with this updater program so you can always have the latest version to use.