

NEC Express5800 Series White Paper
R120d-2M, R120d-1M
R120d-2E, R120d-1E

FC SAN Boot Configuration Guide

Windows Server 2008 (Hyper-V)
Windows Server 2008 R2 (Hyper-V 2.0)
Red Hat Enterprise Linux 5
Red Hat Enterprise Linux 6
VMware vSphere5

October 2012
NEC Corporation
First Edition

Trademarks

EXPRESSBUILDER and ESMPRO, SigmaSystemCenter, WebSAM DeploymentManager, WebSAM NetvisorPro, WebSAM StorageManager, and PathManager are registered trademarks or trademarks of NEC Corporation.

Microsoft, Windows, Windows Server, Hyper-V, Active Directory, and MS-DOS are registered trademarks or trademarks of Microsoft Corporation in the United States and/or other countries.

Red Hat® and Red Hat Enterprise Linux are registered trademarks or trademarks of Red Hat, Inc. in the United States and/or other countries.

Linux® is a registered trademark or trademark of Linus Torvalds in Japan and/or other countries.

Intel and Xeon are registered trademarks or trademarks of Intel Corporation and/or its subsidiaries in the United States and/or other countries.

The official name of Windows Server 2008 is Microsoft® Windows® Server 2008 Operating System.

VMware, the VMware logo, Virtual SMP, and Vmotion are registered trademarks or trademarks of VMware, Inc. in the United States and/or other countries.

All other trademarks are the property of their respective owners.

[Notice]

- (1) No part of this document may be copied in whole or in part without permission.**
- (2) The contents of this document may be changed in the future without prior notification.**
- (3) No part of this document may be copied or revised without permission from NEC.**
- (4) Care has been taken to make sure that the contents of this document are correct, but if there are any doubtful items, mistakes or missing items, then please contact your dealer or the NEC sales department.**
- (5) Regardless of (4) above, NEC is not responsible for any damages resulting from using this software.**

Table of Contents

1. Overview

1.1.Purpose of this document.....	P. 7
1.2.What is SAN Boot?.....	P. 7
1.3.Abbreviations.....	P. 8
1.4.SAN Boot Environment Hardware Connection Images.....	P. 9
1.5.Precautions for Building a SAN Boot Environment.....	P. 9
1.6 Confirmation/Advanced Preparations.....	P. 10
1.7.Acquiring Manuals.....	P. 11
1.8.Hardware and Software Specifications.....	P. 14

2. Preparation

2.1.Management Server Preparation.....	P. 15
2.1.1. Management Software and Linkage Image.....	P. 15
2.1.2. Installing Software in the Management Server.....	P. 16
2.1.3. Management LAN Settings.....	P. 16
2.1.4. NEC M-series Storage Control Software Installation.....	P. 17
2.2.FC Switch Preparation.....	P. 18
2.2.1. Configuration.....	P. 18
2.2.2. FC Zoning Settings.....	P. 19
2.3. Confirm WWPN	P. 20
2.3.1. Confirm WWPN	P. 20
2.4.FC Controller Mounting Location.....	P. 21
2.4.1. R120d-2M.....	P. 22
2.4.2. R120d-1M.....	P. 22
2.4.3. R120d-2E.....	P. 23
2.4.4. R120d-1E.....	P. 23

3. Storage Settings

3.1.NEC M-series Storage Settings.....	P. 24
3.1.1. Creating a Pool and Logical Disk (LD).....	P. 24
3.1.2. Creating an LD Set.....	P. 25
3.1.3. Assigning LDs to an LD Set.....	P. 26
3.1.4. Changing the Port Access Mode.....	P. 28
3.1.5. Linking the LD Sets and FC Controllers.....	P. 28

Table of Contents

4. Server Settings

4.1.FC Cable Connection..... P. 31

 4.1.1. R120d-2M..... P. 32

 4.1.2. R120d-1M..... P. 33

 4.1.3. R120d-2E..... P. 34

 4.1.4. R120d-1E..... P. 35

4.2.Server BIOS Settings..... P. 36

 4.2.1. FC Controller BIOS Enable Setting..... P. 36

4.3.FC Controller BIOS Settings..... P. 37

 4.3.1 Starting the BIOS Configuration Utility..... P. 37

 4.3.2. Selecting the FC Port..... P. 38

 4.3.3. Boot Device Registration..... P. 39

 4.3.4. Boot BIOS Enable Setting..... P. 44

4.4.Making Single Path FC Connections..... P. 46

5. OS Installation

5.1.Overview..... P. 49

5.2.Windows..... P. 50

 5.2.1. Windows Server 2008 and Windows Server 2008 R2
 Installation..... P. 50

 5.2.2. Advanced Preparations..... P. 51

 5.2.3. OS Installation..... P. 52

 5.2.4. Service Pack Application P. 52

 5.2.5. NEC Storage PathManager for Windows Installation..... P. 52

 5.2.6. Hyper-V Installation (only when using Hyper-V)..... P. 53

5.3.Linux..... P. 59

 5.3.1. Red Hat Enterprise Linux 5 and Red Hat Enterprise Linux 6
 Installation..... P. 59

 5.3.2. PathManager Installation..... P. 60

 5.3.3. Before Setting Up..... P. 60

 5.3.4. Installation..... P. 69

 5.3.5. Uninstalling..... P. 86

 5.3.6. Updating..... P. 93

 5.3.7. Preparing for Operation..... P. 94

 5.3.8. Detailed Information..... P. 96

 5.3.9. Installing Applications..... P. 96

5.4.VMware ESX/ESXi..... P. 97

 5.4.1. Precautions for Configuring SAN Boot P. 97

 5.4.2. Precautions for Building SAN Boot P. 97

Table of Contents

6. Confirming Operation and Setting Up Redundant Paths

6.1.Reconnecting the FC Cable..... P. 98

6.2.Checking FC Path Redundancy..... P. 98

7. Additional Application Settings

7.1.DDR (NEC M-series Storage)..... P. 99

7.1.1. Backup and Restore Windows Server 2008 Hyper-V with the DDR Function..... P. 101

7.1.2. Backup and Restore Windows Server 2008 R2 Hyper-V with the DDR Function..... P. 103

7.1.3. Backup and Restore VMware ESX/ESXi with the DDR Function..... P. 106

7.1.4. Cautions for Backup and Restore Windows Server OS Images with the DDR Function P. 109

8. Precautions and Restrictions

8.1.Server..... P. 113

8.1.1. Mixing FC Controller Models..... P. 113

8.1.2. Multiple Path Compatibility..... P. 113

8.1.3. BIOS Settings for Installing Windows Server 2008..... P. 113

8.1.4. Installing the Latest BIOS..... P. 114

8.1.5. Internal Disk Mounting Restrictions P. 114

8.1.6. System BIOS Setup..... P. 114

8.2.Storage..... P. 115

8.2.1. Connecting Multiple Storage Devices..... P. 115

8.2.2. Storage Performance and Number of OSs Installed..... P. 115

8.3.OS..... P. 116

8.3.1. Number of OS Licenses Used..... P. 116

8.3.2. OS Memory Dump..... P. 118

8.3.3. Redundant Path Connections when Installing the OS..... P. 118

8.3.4. Linux OS Logical Volume Manager..... P. 118

8.4. PathManager..... P. 119

8.4.1. NEC Storage PathManager Versions..... P. 119

8.4.2. Backup and Restore Disks in Linux OS with PathManager Installed..... P. 119

Table of Contents

9. Appendix

9.1.	Confirm FC Controller WWPN and WWNN.....	P. 120
9.1.1.	Confirm from IEEE Address Labels.....	P. 120
9.1.2.	Confirm from the WWPN Address Label (only N8190-153)	P. 120
9.1.3.	Confirm from the FC BIOS.....	P. 121

1. Overview

1.1. Purpose of this document

- This manual describes the process for implementing NEC Express5800 Series rack server operating system in an FC SAN Boot system that is located in storage devices in a Storage Area Network (hereafter referred to as SAN).
- Because there are many different reference sources for servers, storage devices, software and other items when building a SAN Boot system, this manual shows the overall flow of implementation by pointing to and indicating the various manuals to be used. By doing so, this manual shows how to build a SAN Boot system.
- Because of this, this manual does not guarantee performance, availability and reliability. Before building a system, the user must assure performance, availability and reliability by following the system design requirements.

1.2. What is SAN Boot?

- SAN Boot is a method in which the system is booted through a SAN from an operating system stored in NEC M-series Storage in the SAN.
- The advantages of SAN Boot are: (1) effective use of storage resources and improved fault tolerance by assigning the boot area to a highly reliable storage system; and (2) adding flexibility to system changes by allowing switching of storage networks and reducing downtime.
- NEC Express5800 Series provides a SAN Boot solution that encompasses the advantages of SAN Boot and provides companies with an optimized and highly available IT system foundation.

1. Overview

1.3. Abbreviations

- The following table shows the meanings of the abbreviations used in this manual.

Abbreviation	Description	Remarks
FC	Fibre Channel	---
HBA	Host Bus Adapter	---
WWPN	World Wide Port Name	---
WWNN	World Wide Node Name	---
WWN	World Wide Name	---
LD	Logical Disk	---
RHEL	Red Hat Enterprise Linux	---
DDR	DynamicDataReplication	Data replication function
iSM(E)	StorageManager (Express)	Storage management software
ControlCommand	Storage ControlCommand	Storage software
MV	Master Volume	Working volume
RV	Replication Volume	Backup volume
WG	WG	Logical disk usage format: Windows (GPT disk)
WN	WN	Logical disk usage format: Windows (MBR disk)
LX	LX	Logical disk usage format: Linux/VMware (VMFS)

1. Overview

1.4. SAN Boot Environment Hardware Connection Images

- The diagrams below following show typical hardware configurations for a SAN Boot environment.

【8G FC SAN Boot (via switch) configuration】

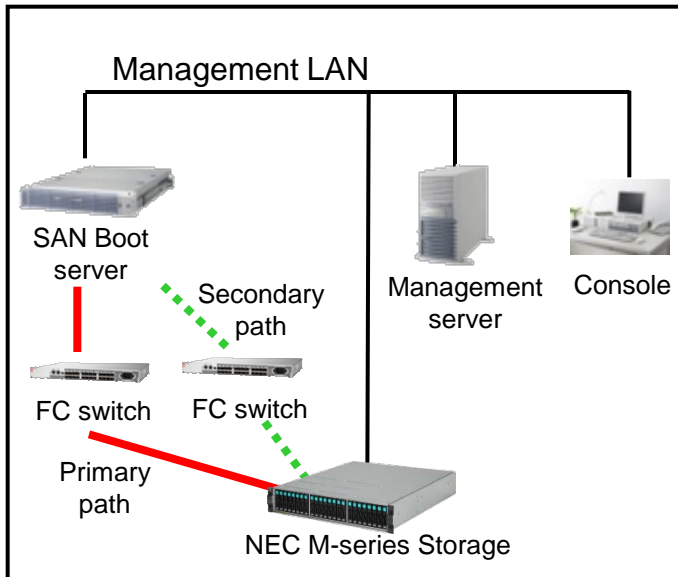

【8G FC SAN Boot (direct) configuration】

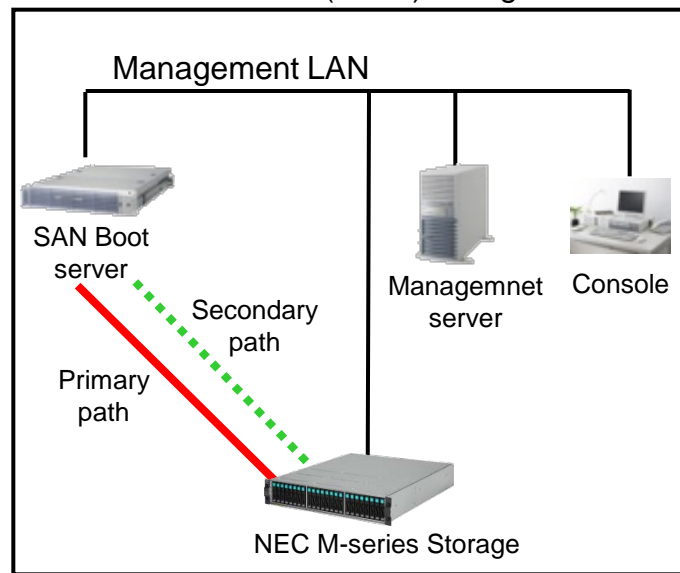

SAN Boot servers should not have HDDs, SSDs, and RAID controllers. Please be aware of that when ordering equipment.

1.5. Precautions for Building a SAN Boot Environment

- Refer to the another paper “**SAN Boot Compatibility Table**” for the hardware and software that can be used to build a SAN Boot system.
- Also make sure to check the configuration guidelines and product operating requirements for servers, storage devices, and software.



There are precautions and restrictions when building a SAN Boot environment. Be sure to see “[8. Precautions and Restrictions](#)” when considering to implement a SAN Boot environment.

1. Overview

1.6. Confirmation/Advanced Preparations

- The following manuals and system updates may be necessary to build a SAN Boot environment. Acquiring these before starting the actual build process is recommended.

Confirmation/Advanced Preparations

Ch
2

2.3. Confirm WWPN

→ See “[9.1.1 Confirm from IEEE Address Labels](#)” to confirm each FC controller WWPN.

2.4. FC Controller Mounting Location

→ Confirm the mounting locations of the FC controllers on each server in the SAN Boot environment.

Ch
3

3.1.5. Linking the LD Sets and FC Controllers

See “[2.3 Confirm WWPN](#)” to confirm the WWPN.

Ch
5

5.2.3. OS Installation

Be sure to have the EXPRESSBUILDER DVDs for each server in order to update their drivers.
Be sure to have the NEC OS installation media to install the OS.

5.2.4. Windows Service Pack

Windows Server 2008 → Service Pack 2 is required to install.

5.2.6.2. Hyper-V Installation – KB Installation for Windows Server 2008 R2

In an environment in which Service Pack 1 is not installed, after enabling Hyper-V, KB2264080 should be installed if necessary.

5.3.1. OS Installation

Red Hat Enterprise Linux 5

Be sure to have the Red Hat Enterprise Linux 5.7 installation media.

Red Hat Enterprise Linux 6

Be sure to have the Red Hat Enterprise Linux 6.1 installation media.

Ch
7

7.1.2. Backup and Restore Windows Server 2008 R2 Hyper-V with the DDR Function

Acquire “**iSMpassthrough_enabler.**”

Source: Included in the package with ControlCommand ver. 6.2 or later.

Ch
8

8.1.4. Installing the Latest BIOS

In order to update the system BIOS, acquire the BIOS update module.

Source: <http://www.58support.nec.co.jp/global/download/index.html>

1. Overview

1.7. Acquiring Manuals

- The following manuals and system updates may be necessary to create a SAN Boot environment. Acquiring these before starting the actual build process is recommended.

Reference Manuals

Ch
1

1.7. Acquiring Manuals

- Server (NEC Express5800 Series User's Guide)
- FC Controller User's Guide
Source: <http://www.58support.nec.co.jp/global/download/>
- NEC Express5800 Series Microsoft® Windows Server® 2008 R2 Support Information
Source: <http://www.58support.nec.co.jp/global/download/w2008r2/sp1.html>

Ch
2

2.1.4. NEC M-series Storage Control Software Installation

- **“SAN Boot Compatibility Table”**
- **“StorageManager Installation Guide”**

M Series source: INSTALL.pdf in the WebSAM StorageManager Suite CD-ROM

2.1.4.2. Unlocking the AccessControl License

- **“NEC Storage Software Configuration Setting Tool User's Manual (GUI)”**

Source: manual¥IS051.pdf in the StorageManager Express Setup and Utility CD-ROM

2.2.2.1. FC Switch Zoning

- **“User's Guide”**

Source: attached with FC switch.

Ch
3

3.1.1. Creating a Pool and a Logical Disk (LD)

3.1.2. Creating a LD Set

3.1.3. Assigning LDs to an LD Set

3.1.4. Changing the Port Access Mode

3.1.5. Linking the LD Sets and FC Controllers

- **“NEC Storage Software Configuration Setting Tool User's Manual (GUI)”**

M Series source: manual¥IS051.pdf in the StorageManager Express Setup and Utility CD-ROM

1. Overview

1.7. Acquiring Manuals

Reference Manuals

Ch
5

5.2.5. NEC Storage PathManager for Windows Installation

→ **“Storage PathManager for Windows Installation Guide”**

Source: Refer to the manual in the PathManager Installation CD-ROM.

5.3.2. PathManager Installation

→ Detailed information

Source: Refer to the manual in the PathManager Installation CD-ROM.

5.4 VMware ESX/ESXi

→ **“Storage PathManager for VMware Installation Guide”**

Source: Refer to the manual in the PathManager Installation CD-ROM.

Ch
6

6.2. Checking FC Path Redundancy

Windows OS

→ Refer to **“NEC Storage PathManager User’s Manual (Windows version)”** to check details.

Source: Refer to the manual in the PathManager Installation CD-ROM

VMware ESX/ESXi

→ Refer to **“NEC Storage PathManager User’s Manual (VMware version)”** to check details.

Source: Refer to the manual in the PathManager Installation CD-ROM

1. Overview

1.7. Acquiring Manuals

Reference Manuals

Ch
7

7.1. DDR (NEC M-series Storage)

→ **“Storage ControlCommand installation guide”**

Source: INSTALL.PDF in the Storage ControlCommand on Windows CD-ROM

Source: INSTALL.PDF in the Storage ControlCommand on Linux CD-ROM

→ **“Storage Series Configuration Settings Guide (GUI)”**

M Series source: manual¥IS051.pdf in the WebSAM StorageManager Suite CD-ROM

→ **“Storage Software Data Replication Usage Guide – Functions”**

Source: manual¥IS015.pdf in the Storage ControlCommand on Windows CD-ROM

Source: manual¥IS015.pdf in the Storage ControlCommand on Linux CD-ROM

→ **“Storage Software ControlCommand Command Reference”**

Source: manual¥IS041.pdf in the Storage ControlCommand on Windows CD-ROM

Source: manual¥IS041.pdf in the Storage ControlCommand on Linux CD-ROM

→ **“Storage Software StorageManager Command Reference”**

M Series source: manual¥IS052.pdf in the WebSAM StorageManager Suite CD-ROM

7.1.2. Backup and Restore Windows Server 2008 R2 Hyper-V with the DDR Function

→ Backup and restore procedures: **“Storage Software Data Replication Usage Guide – Installation and Operation”**

Source: manual¥IS016.pdf in Storage ControlCommand on Windows CD-ROM

Ch
8

8.1.4. Installing the Latest BIOS

→ With respect to updating procedures, refer to the BIOS download page instructions for each device and the **“Readme.txt”** files included with the downloaded data.Source: <http://www.58support.nec.co.jp/global/download/index.html>

1. Overview

1.7. Acquiring Manuals

- Acquiring Manuals
 - This manual describes the various implementation steps while referring to the relevant sections of the various individual product manuals.
 - While the product manuals are included with their products, downloading the latest information from the appropriate website is recommended.
 - Server (NEC Express5800 Series User's Guide)
 - <http://www.58support.nec.co.jp/global/download/>
"Rack" under the Document & Software tab > Select the corresponding device.
 - FC Controller User's Guide
 - <http://www.58support.nec.co.jp/global/download/>
"Server Options" under the Document & Software tab > "Host bus adapters"
> Fibre Channel Controller [N8190-153] or [N8190-154]
 - OS
 - Windows
 - ➔ NEC Express5800 Series Microsoft® Windows Server® 2008 R2 Support Information
<http://www.58support.nec.co.jp/global/download/w2008r2/sp1.html>
Refer to the section on the standard rack server.
 - Applications
 - NEC M-series Storage control software related manuals and installation guides.

1.8. Hardware and Software Specifications

- Hardware and Software Specifications
 - Ask your local NEC subsidiary about the availability for our products.

2. Preparation

2.1. Management Server Preparation

2.1.1. Management Software and Linkage Image

- The following diagram illustrates the main roles (installed software) played by the management server used in a SAN Boot environment.
 - Management Servers (ESMPRO/ServerManager)
 - Storage configuration setting/monitoring (StorageManager)

- The software installed in the management server are linked in the manner shown in the image below.

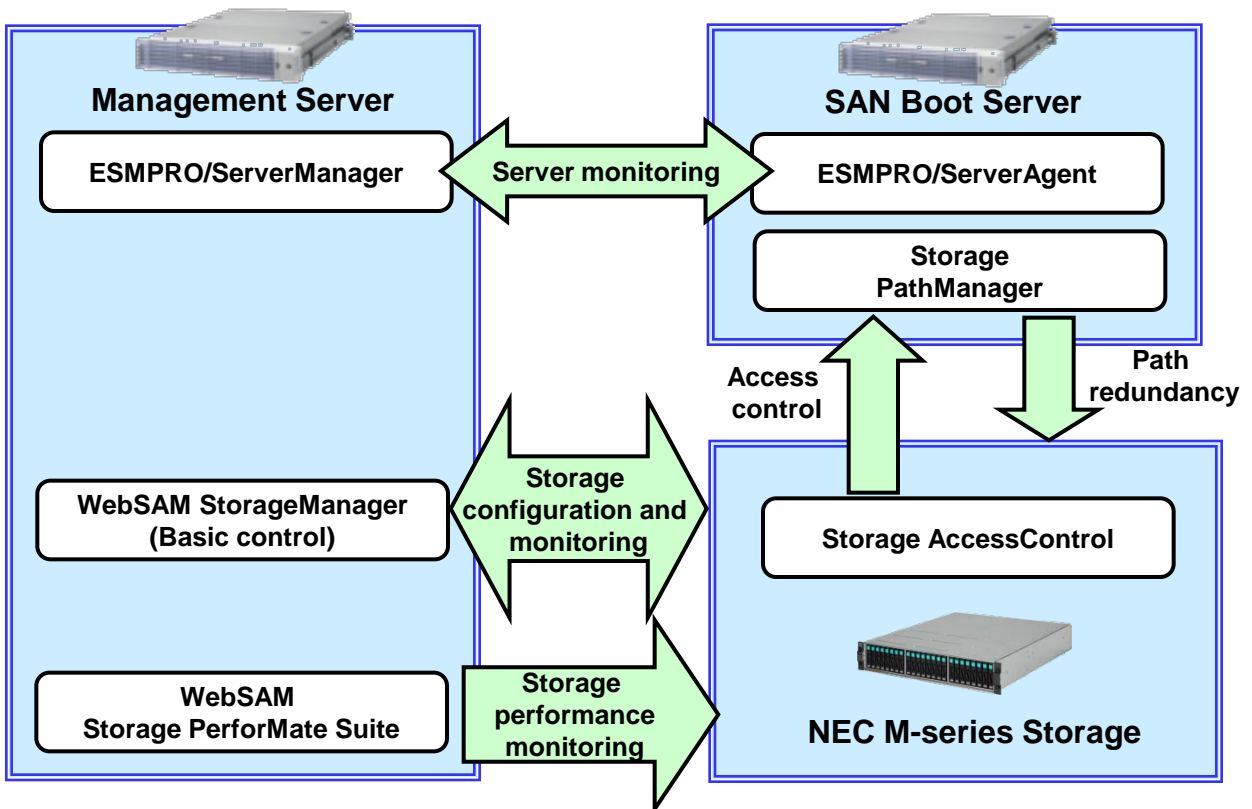

2. Preparation

2.1. Management Server Preparation

2.1.2. Installing Software in the Management Server

- This section describes the NEC M-series Storage management settings and FC switch preparation that are necessary before building the SAN Boot environment (i.e., before OS installation).
- See “[7. Additional Application Settings](#)” with respect to data replication functions (DDR) that must be set after installing the OS.

2.1.3. Management LAN Settings

- In order to perform the StorageManager that sets up and manages NEC M-series Storage disk array, use the management LAN (*1) to connect and setup the network. (Required)
- Also, connecting and setting up the management LAN is strongly recommended in order to facilitate smooth implementation and management of the SAN Boot servers.

*1 Independently building the management LAN is recommended, but it is also possible to run it in the same segment as an operating LAN. If these two are to share a segment, the system should be designed so that access is possible even under heavy loads.

2. Preparation

2.1. Management Server Preparation

2.1.4. NEC M-series Storage Control Software Installation

2.1.4.1. StorageManager Installation

- StorageManager controls the storage disk array in the SAN Boot environment. If StorageManager is not installed or the version that is installed cannot be used for SAN Boot, refer to “**Chapter 3 Server Installation (Windows)**” and “**Chapter 4 Client Installation**” of the “**NEC Storage Manager Installation Guide**”.
- * See the “**SAN Boot Compatibility Table**” for the StorageManager version that can be used for SAN Boot.
- * Refer to the INSTALL.pdf file in the NEC Storage Manager Suite CD-ROM to find the “**Installation Guide**.”

2.1.4.2. Unlocking the AccessControl License

- SAN Boot is not recommended to share system disks among multiple servers. Therefore, it is necessary to control access from various servers with AccessControl.
- Refer to “**11.4 License Unlock**” of the “**NEC Storage Software Configuration Setting Tool User’s Manual (GUI) for the M Series**” with regard to unlocking the AccessControl license.
- When using additional licenses, refer to “**11.4 License Unlock**” and unlock them.
- For the M10e and M100, the AccessControl license is unlocked by default. Thus there is no need to unlock it.
- * Refer to the manual¥IS051.pdf file in the StorageManager Express Setup and Utility CD-ROM for the “**NEC Storage Software Configuration Setting Tool User’s Manual (GUI) for the M Series**.”

2. Preparation

2.2. FC Switch Preparation

2.2.1. Configuration

- In a SAN Boot environment, the SAN Boot servers are connected to storage disk array through FC switches, or to storage disk array directly.
- Note that cascading FC switches are not recommended in a SAN Boot environment.

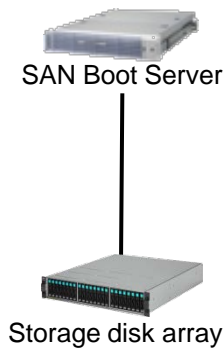

Config. Example 1
Direct connection

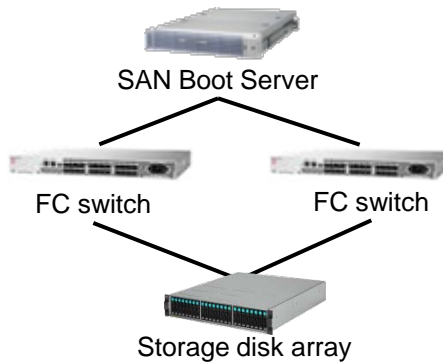

Config. Example 2
Connection via switches

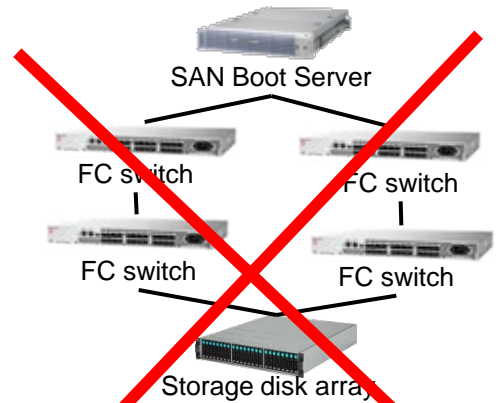

Config. Example 3
Cascading connection
(Not Recommend)

2.2.1.1. FC Switch Configuration

- FC Switch can be configured with the NEC WB series (WB310A/330A/340A/512A/514A).



WB310A / 330A / 340A



WB512A/514A

2. Preparation

2.2. FC Switch Preparation

2.2.2. FC Zoning Settings

2.2.2.1. FC Switch Zoning

- The purpose of zoning FC switches is to logically separate connected devices that do not have any mutual access, so that they cannot be accessed by connected devices from outside their zones. This improves security.
- When using SAN Boot, unless zoning is set so that FC controllers connects servers to the FC switches according to zones differentiated by ports, when another server that belongs to the same zone is linked, a disturbance will occur in which logging in is allowed from another server. Because of this, zoning must be set so that the zones are separated by the ports on the FC controllers.
- Conversely, when there are multiple devices in the same zone, a device might be affected by another device. Therefore, it is strongly recommended to divide the devices into zones on a one-to-one basis with the ports.
- Refer to the “**User’s Guide**” that is included with the FC switches for details on zoning them.
- FC switch zoning configuration example:
 - ➔ The illustration below shows a port zoning example configuration in which two FC switches are connected to two servers with redundant paths.

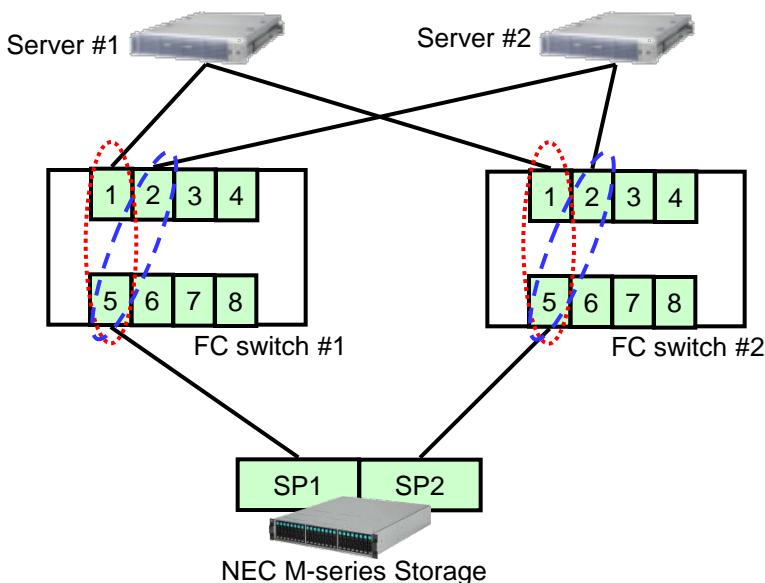

* In this type of configuration, the zoning settings for FC switches #1 and #2 are recommended so that the following ports are paired.

Server #1 zone pairing: [Port 1] ↔ [Port 5]
 Server #2 zone pairing: [Port 2] ↔ [Port 5]



Refer to “**Zoning Settings**” in the FC switch “**User’s Guide**” for setting details. This example shows two servers, but Port 3 or higher can also be zoned in preparation for future expansion.

2. Preparation

2.3. Confirm WWPN

- Confirm the WWPN (World Wide Port Name) of the FC controllers on each server that will use SAN Boot before deploying servers in an FC SAN Boot environment.
 - In an FC SAN Boot environment, AccessControl is used in NEC M-series Storage disk array. Thus it is necessary to bind the server FC controllers and LD sets in NEC M-series Storage.
 - Because NEC M-series Storage uses the FC controller WWPN for linking, it is necessary to check the WWPN before binding the logical disks.
 - .
 - The FC controller that executes FC SAN Boot must be implemented in the designated option card slot. The location of the option card slot depends on the server models.

2.3.1. Confirm WWPN

- See “[9.1.1. Confirm from IEEE Address Labels](#)” in this manual, confirm the WWPN of the FC controller, then write down each value.

2. Preparation

2.4. FC Controller Mounting Location

- Mounting the FC controller on FC SAN Boot server.
The FC controller mounting location is depending on the server model.



When linking the **LD** sets with **FC** controllers, the **WWPN** values are required. Note for future reference all **WWPN** values for each mounted **FC** controller.



When using the **N8190-154** on **R120d-2M**, **R120d-1M**, **R120d-2E** or **R120d-1E**, give priority to **Port 1** for **FC SAN Boot**.

2. Preparation

2.4. FC Controller Mounting Location

2.4.1. R120d-2M

- When FC SAN Boot is implemented from one FC controller, mount in Slot #2B.
- When FC SAN Boot is implemented from two FC controllers, mount in Slot #2B and Slot #1B.

! When **FC SAN Boot** is implemented from **two N8190-154** units, **Port 1** position is the port for **FC SAN Boot**. Note for future reference which values are assigned to the **Port 1** position.

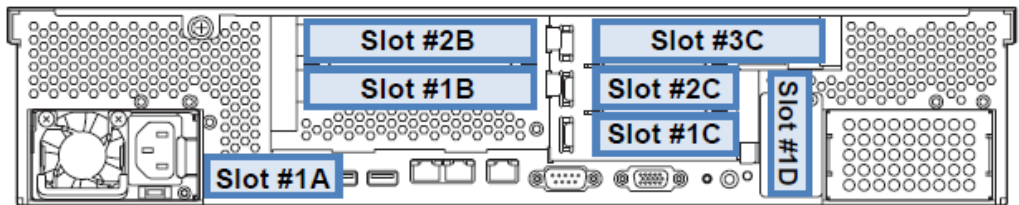

R120d-2M PCI slots

2.4.2. R120d-1M

- When FC SAN Boot is implemented from one FC controller, mount in Slot #1B.
- When FC SAN Boot is implemented from two FC controllers, mount in Slot #1B and Slot #1C.

! When **FC SAN Boot** is implemented from **two N8190-154** units, **Port 1** position is the port for **FC SAN Boot**. Note for future reference which values are assigned to the **Port 1** position.

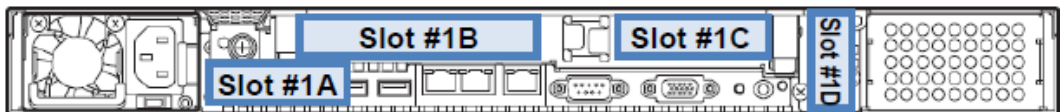

R120d-1M PCI slot

2. Preparation

2.4. FC Controller Mounting Location

2.4.3. R120d-2E

- When FC SAN Boot is implemented from one FC controller, mount in Slot #1B.
- When FC SAN Boot is implemented from two FC controllers, mount in Slot #1B and Slot #2B.



When **FC SAN Boot** is implemented from **two N8190-154** units, **Port 1** is the port position for **FC SAN Boot**. Note for future reference which values are assigned to the **Port 1** position.

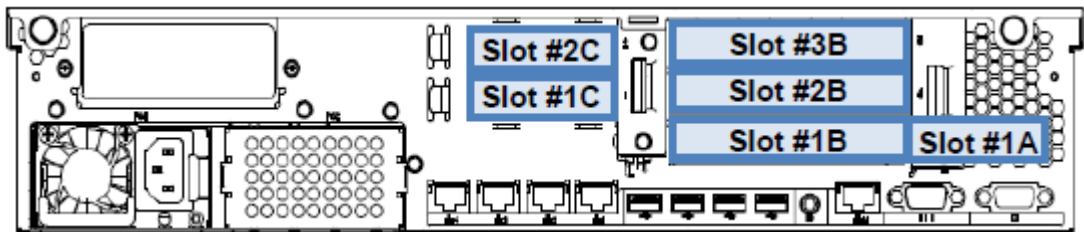

R120d-2E PCI slot

2.4.4. R120d-1E

- When FC SAN Boot is implemented from one FC controller, mount in Slot #1B.
- When FC SAN Boot is implemented from two FC controllers, mount in Slot #1B and Slot #1C.



When **FC SAN Boot** is implemented from **two N8190-154** units, **Port 1** is the port position for **FC SAN Boot**. Note for future reference which values are assigned to the **Port 1** positions.

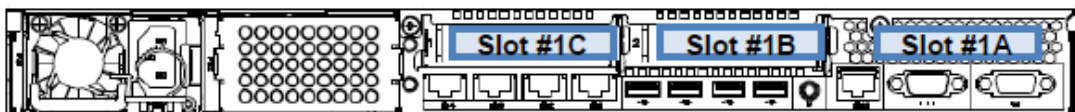

R120d-1E PCI slot

3. Storage Settings

3.1. Storage M Series Settings

3.1.1. Creating a Pool and Logical Disk (LD)

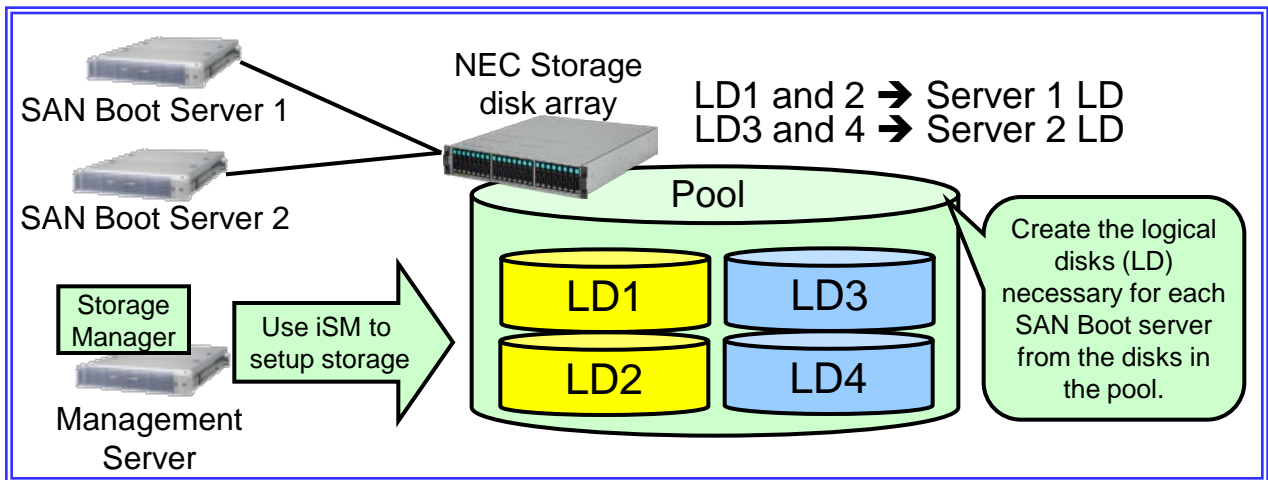

- StorageManager creates the pool and logical disk (hereafter referred to as LD). For NEC M Series Storage, refer to “**7.1 Pool Bind**” and “**9.1 Logical Disk Bind**” in “**NEC Storage Software Configuration Setting Tool User’s Manual (GUI) for the M Series.**”

- * When the pool has already been created , create the LDs properly.
- * It takes long time to format disk up to the capacity and number of LDs.



When using the Storage data replication function to create a Windows OS image, set the logical disk format of the LD storing the OS to “WG” so that the disk signature does not change.

See “[7.1.4. Precautions for Backup and Restore from a Windows Server OS Image with the DDR Function](#)” for details.

3. Storage Settings

3.1. NEC M-series Storage Settings

3.1.2. Creating an LD Set

- StorageManager creates an LD set.
- Refer to “10.3.3.1 Creating a New LD Set/Changing Settings” in “NEC Storage Software Configuration Setting Tool User’s Manual (GUI) for the M Series” for details.

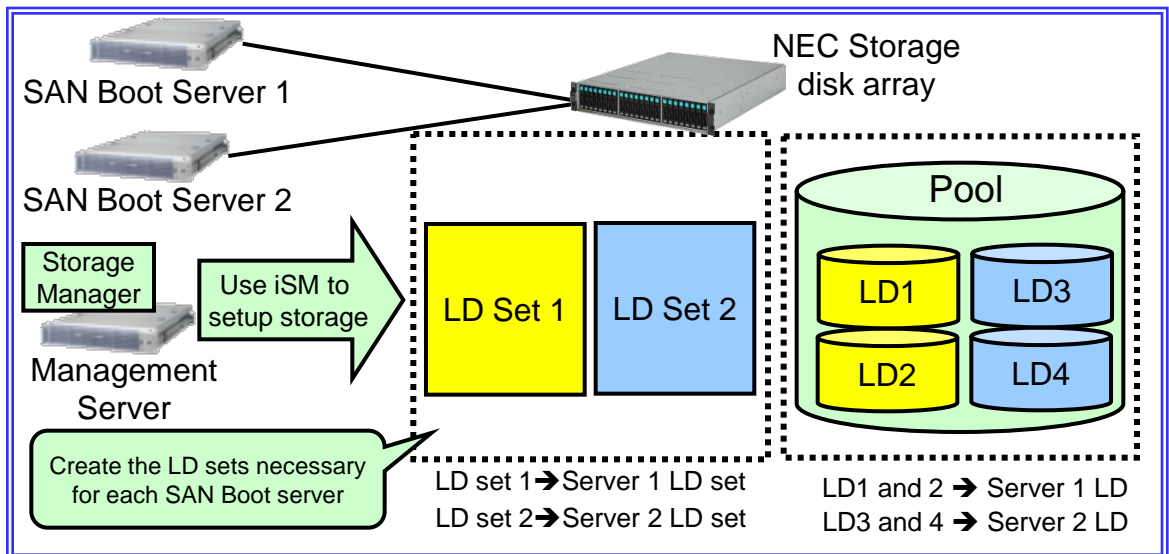

Set the application server platform for the LD set platform.

If the application server OS is VMware ESX/ESXi, set “LX” as the platform.

- An LD set is a virtual image that indicates a group of logical disks. SAN boot server can access the LDs by assigning path information (WWN (World Wide Name) of SAN Boot server) and LDs. Refer to “2.3 LD Set” in “NEC Storage Software Configuration Setting Tool User’s Manual (GUI) for the M Series” for details.

3. Storage Settings

3.1. NEC M-series Storage Settings

3.1.3. Assigning LDs to an LD Set

- StorageManager assigns LDs to an LD set.
- Refer to “10.1 Assignment of Logical Disk” in “NEC Storage Software Configuration Setting Tool User’s Manual (GUI) for the M Series” for details.
 - * Assign LDs to an LD set after formatting in “3.1.1. Creating a Pool and Logical Disks (LD).”

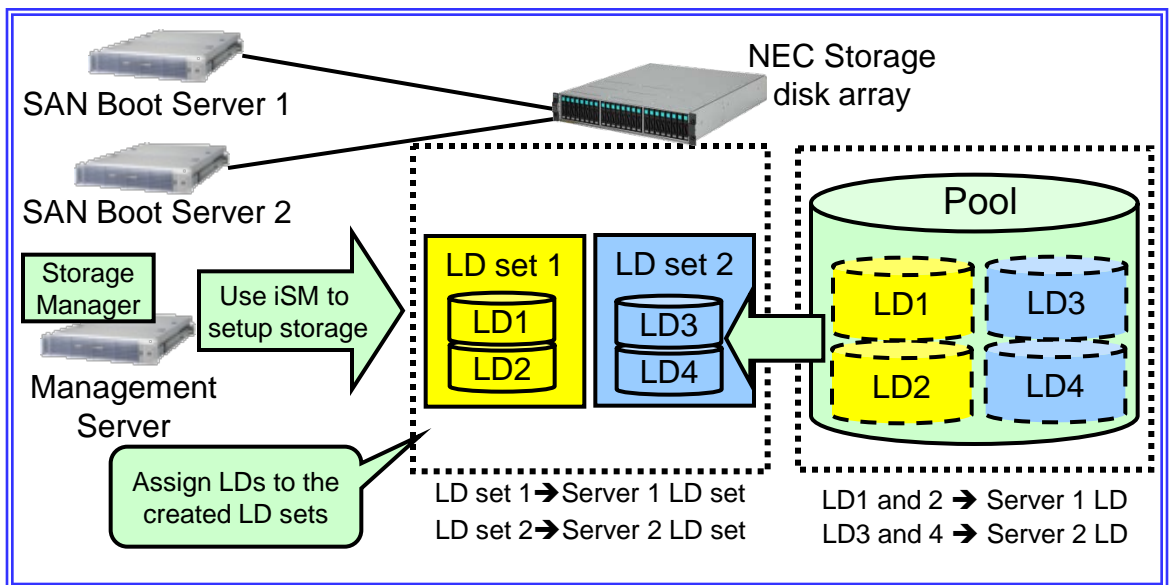

3. Storage Settings

3.1. NEC M-series Storage Settings

● Cautions for Assigning LDs

- The following connection are not recommended:

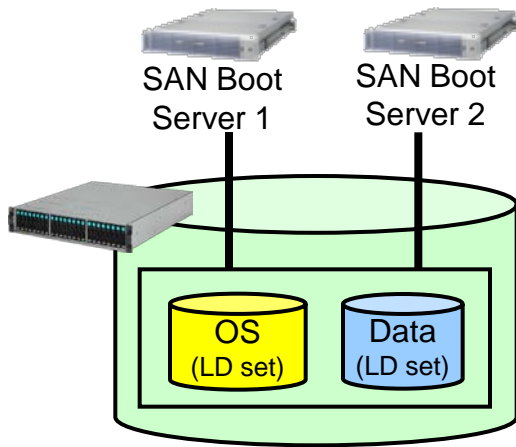

✗ The FC controllers of multiple servers are bound to the same LD sets.

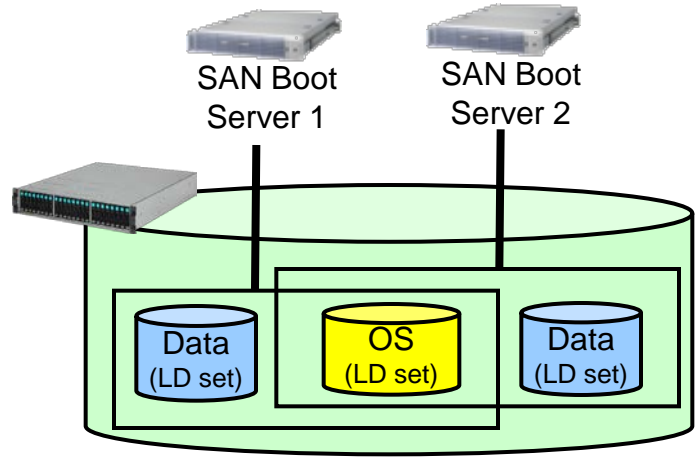

✗ When the LD sets are separated, the same OS disk is binding to them.

- Multiple servers can not access single LD set.
- Exclusive access control by cluster software is necessary to share data disks.

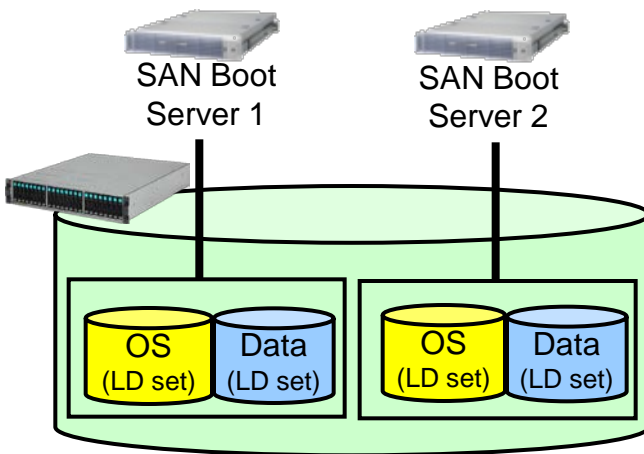

✓ The FC controllers of multiple servers are binding to unique LD sets.

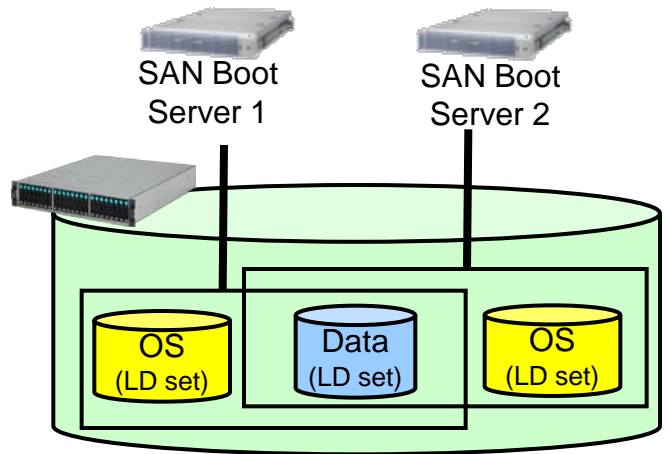

✓ The FC controllers of multiple servers are binding to unique OS disks, and data disks are shared.

3. Storage Settings

3.1. NEC M-series Storage Settings

3.1.4. Changing the Port Access Mode

- To execute SAN Boot, the access mode of NEC M-series Storage ports must be set to the WWN mode. (WWN mode is set by default.)
- Set the port access mode to WWN mode with StorageManager.
- Refer to “11.2.7 Port Mode Switching” in “NEC Storage Software Configuration Setting Tool User’s Manual (GUI) for the M Series” for details.

3.1.5. Linking the LD Sets and FC Controllers

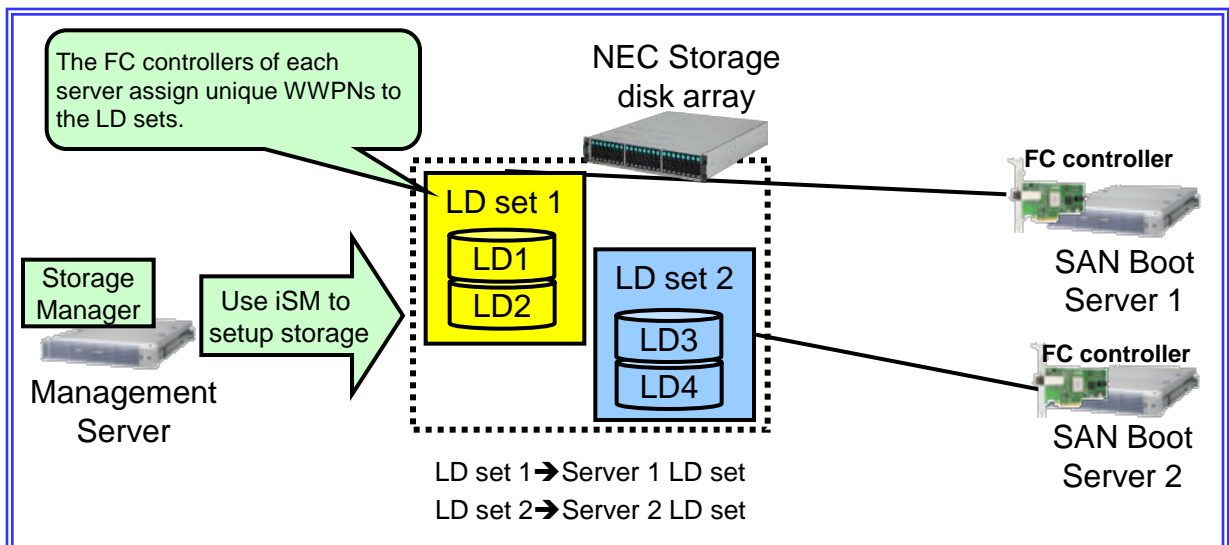

- Link the WWPNs of the FC controller on the SAN Boot server to the LD sets created in “[3.1.2 Creating an LD Set](#)” in this manual with StorageManager.

3. Storage Settings

3.1. NEC M-series Storage Settings

- Refer to “10.3.3.1 Creating a New LD Set/Changing Settings” of “NEC Storage Software Configuration Setting Tool User’s Manual (GUI) for the M Series” for details.

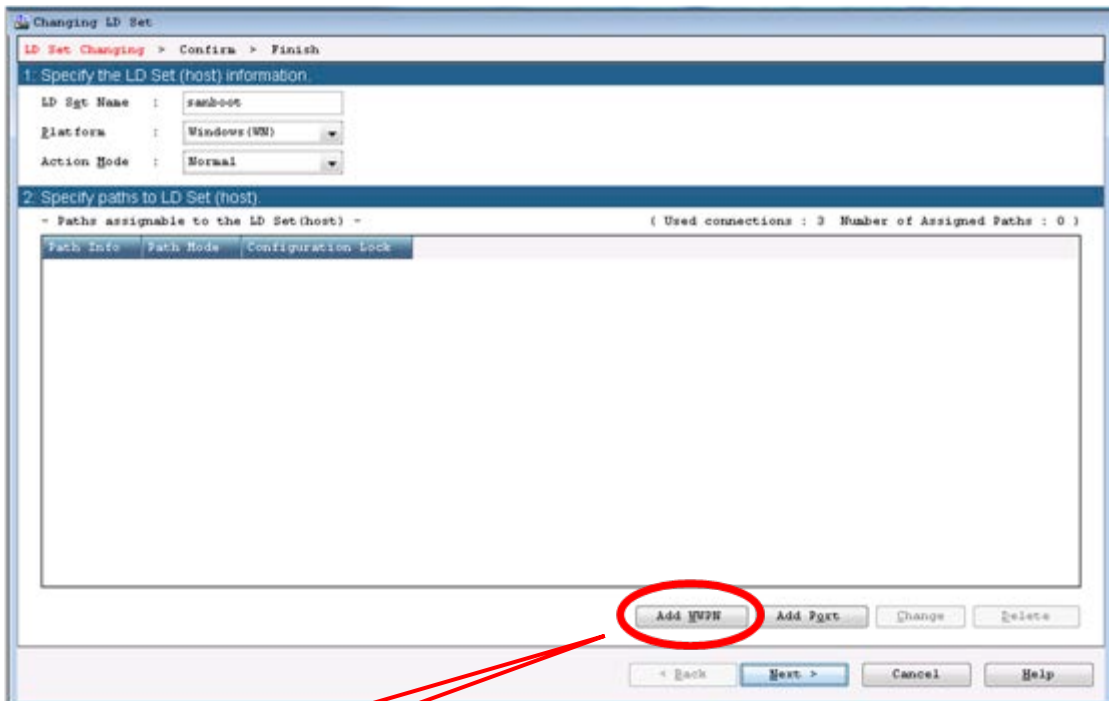

Click this

3. Storage Settings

3.1. NEC M-series Storage Settings

- To set a redundant configuration, link all FC controller ports in FC SAN Boot to the same LD sets at this time.

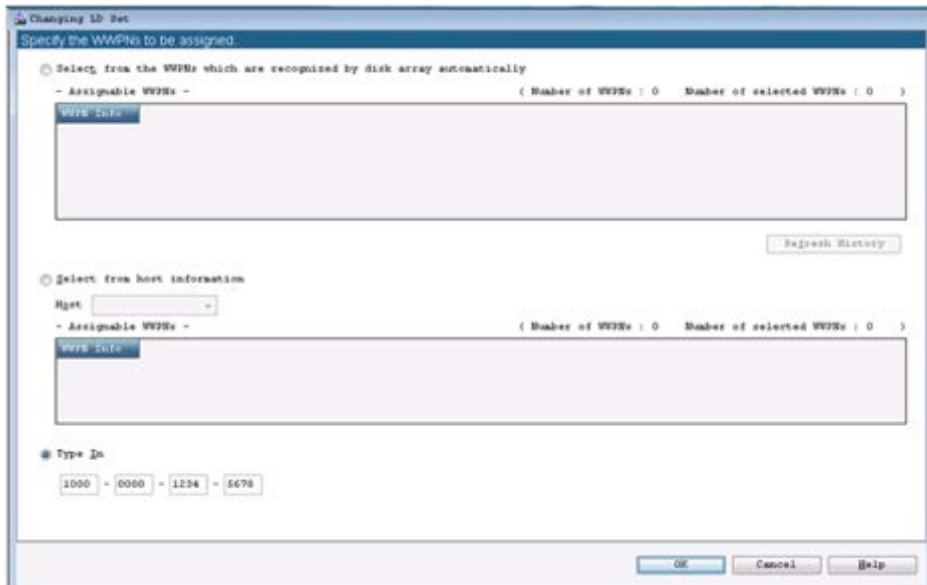

- User can check WWPNs with the WWPN labels on the FC controllers, or from the FC controller BIOS.
If the FC controller is not mounted on the server, see [“2.3 Confirm WWPN”](#) on how to check the WWPN label on the FC controller.
- If the FC controller is already mounted on the server, see [“9.1.3 Confirm from the FC BIOS”](#) on how to check it from the FC controller BIOS.

4. Server Settings

4.1. FC Cable Connection

- Before setting up the BIOS, the ports of the FC controller that will execute FC SAN Boot must be connected to the FC switches / storage disk array with FC cables.
- The locations of the mounting FC controller and FC ports used for FC SAN Boot will be depending on the server model.



FC cables should be connected with only two paths used for FC SAN.



If the **N8190-154** on **R120d-2M**, **R120d-1M**, **R120d-2E** or **R120d-1E**, Port 1 should be used for FC SAN Boot.

4. Server Settings

4.1. FC Cable Connection

4.1.1. R120d-2M

- FC SAN Boot implemented from two N8190-153 units:
Connect the FC controllers mounted in Slot #2B and Slot #1B to the FC switches / storage disk array with FC cables.

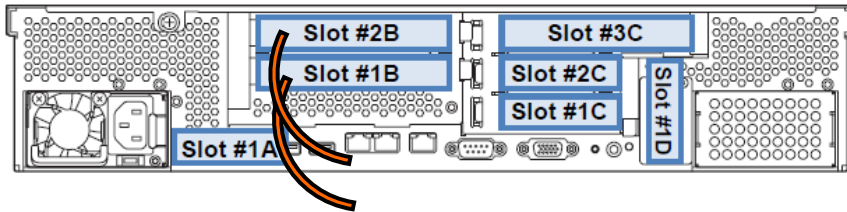

- FC SAN Boot implemented from one N8190-154 unit:
Connect the FC controller mounted in Slot #2B to the FC switches / storage disk array with FC cables.

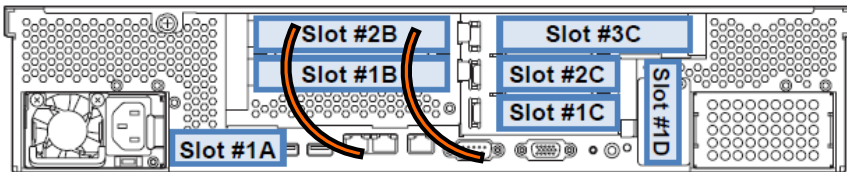

- FC SAN Boot implemented from two N8190-154 units:
Connect the Port 1 of the FC controllers mounted in Slot #2B and Slot #1B to the FC switches / storage disk array with FC cables.

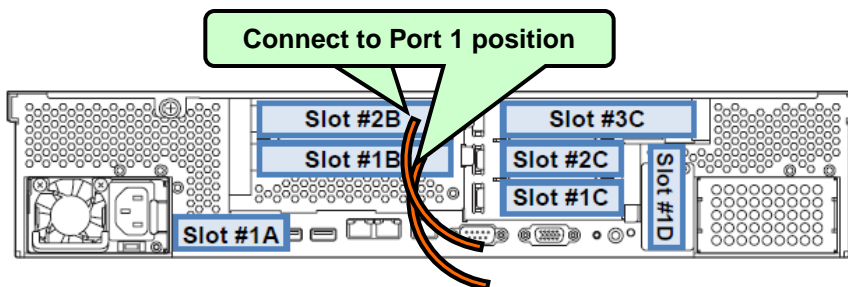

4. Server Settings

4.1. FC Cable Connection

4.1.2. R120d-1M

- FC SAN Boot implemented from two N8190-153 units:
Connect both FC controllers to the FC switches / storage disk array with FC cables.

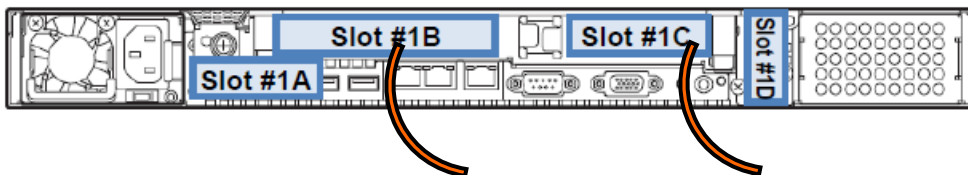

- FC SAN Boot implemented from one N8190-154 unit:
Connect the FC controller mounted in Slot #1B to the FC switches / storage disk array with FC cables.

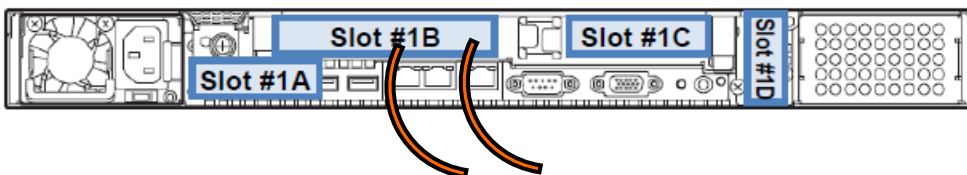

- FC SAN Boot implemented from two N8190-154 units:
Connect the Port 1 of both FC controllers to the FC switches / storage disk array with FC cables.

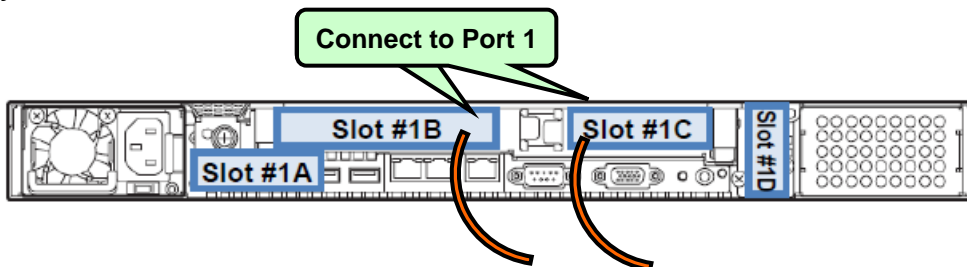

4. Server Settings

4.1. FC Cable Connection

4.1.3. R120d-2E

- FC SAN Boot implemented from two N8190-153 units:
Connect the FC controllers mounted in Slot #2B and Slot #1B to the FC switches / storage disk array with FC cables.

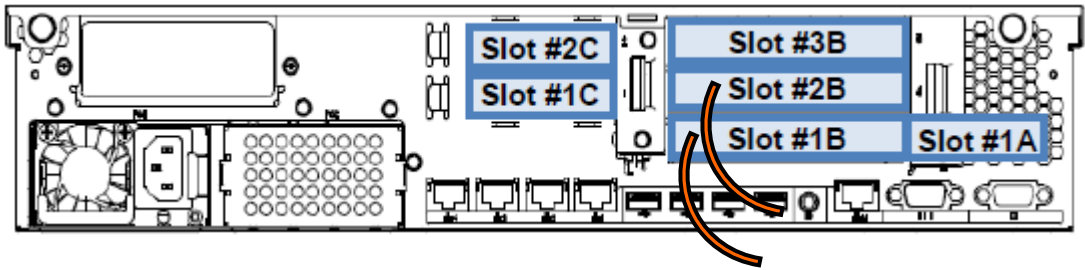

- FC SAN Boot implemented from one N8190-154 unit:
Connect the FC controller mounted in Slot #1B to the FC switches / storage disk array with FC cables.

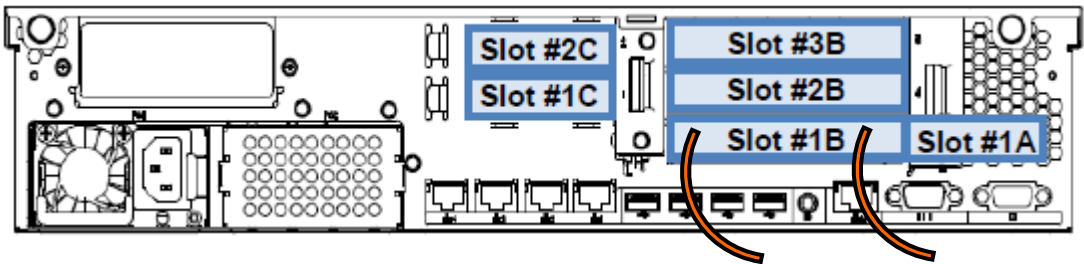

- FC SAN Boot implemented from two N8190-154 units:
Connect the Port 1s of the FC controllers mounted in Slot #2B and Slot #1B to the FC switches / storage disk array with FC cables.

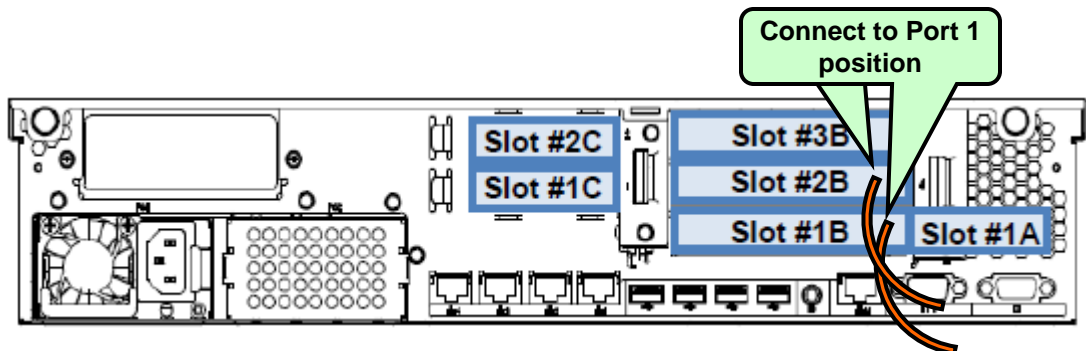

4. Server Settings

4.1. FC Cable Connection

4.1.4. R120d-1E

- FC SAN Boot implemented from two N8190-153 units:
Connect both FC controllers to the FC switches / storage disk array with FC cables.

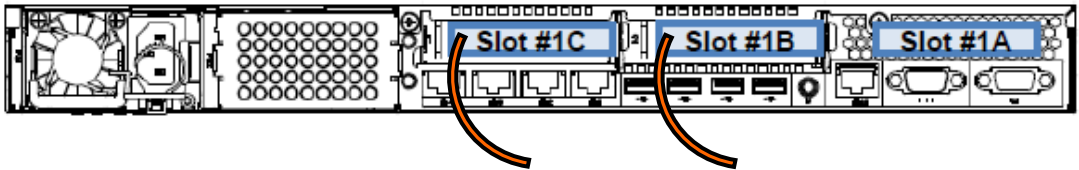

- FC SAN Boot implemented from one N8190-154 unit:
Connect the FC controller mounted in Slot #1B to the FC switches / storage disk array with FC cables.

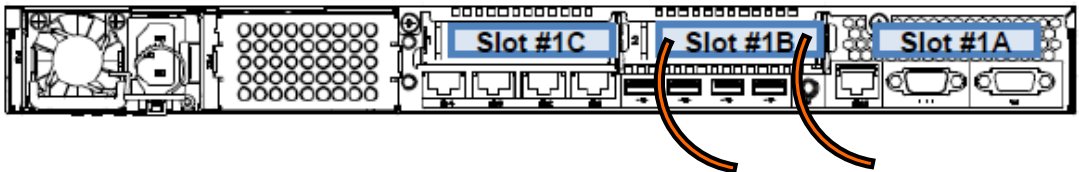

- FC SAN Boot implemented from two N8190-154 units:
Connect the Port 1 of both FC controllers to the FC switches / storage disk array with FC cables.

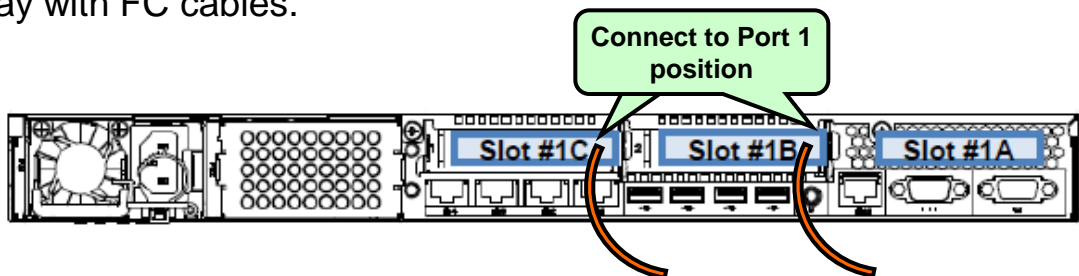

4. Server Settings

4.2. Server BIOS Settings

- To execute FC SAN Boot, the server BIOS settings must be changed to enable the FC controller BIOS.
- To change the server BIOS settings, hold down the <F2> key when booting the server and enter the System Setup screen.

Refer to the maintenance guides of each device and the “**System BIOS**” section of the User’s Guide for details on setting up the System BIOS.

Press <F2> to enter SETUP or Press <F12> to Network

4.2.1. FC Controller BIOS Enable Setting

- Change the “PCI Configuration” setting.
 - The slot to be enabled is the slot in which the FC controller used to execute FC SAN Boot in “[2.4 FC Controller Mounted Location](#)” is mounted.

[BIOS Setup Screen]

→ [Advanced]

[PCI Configuration]

PCI Slot 1 Option ROM: [Enabled]

- * The Option ROMs of slots that including FC controllers for FC SAN Boot should be set to “Disabled.”

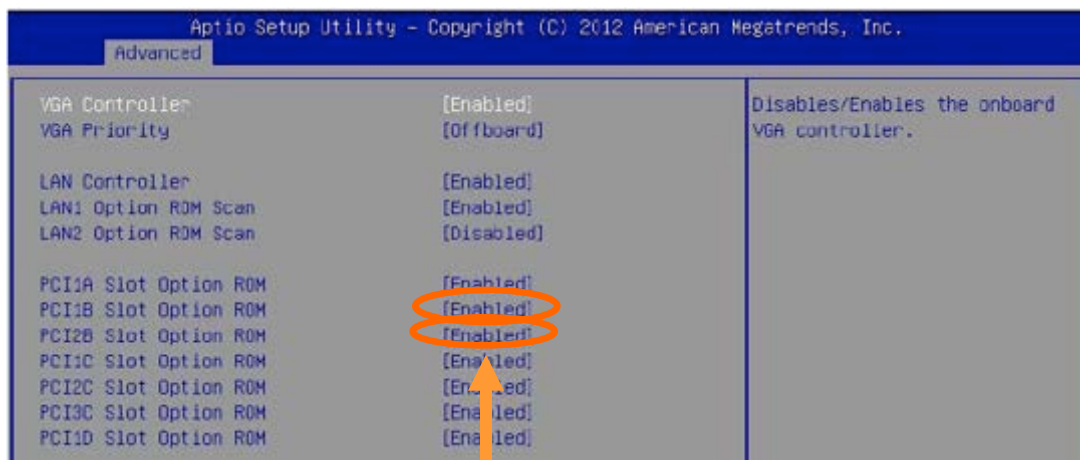

Change the setting for the slot with the FC controller from Disabled to Enabled. (The figure above is for the R120d-2M.)

4. Server Settings

4.3. FC Controller BIOS Settings

- Set up the FC controller BIOS from a local console of the server used for FC SAN Boot.

4.3.1. Starting the BIOS Configuration Utility

- After completing “[4.2 Server BIOS Settings](#),” turn off the power. Then turn it on again.
- When the following message is displayed, press the <Alt> + <E> key or <Ctrl> + <E> key combination to start the FC controller BIOS configuration utility.

```

!!! Emulex LightPulse x86 BIOS !!!, Version 2.02a2
Copyright (c) 1997-2008 Emulex. All rights reserved.

Press <Alt E> or <Ctrl E> to enter Emulex BIOS configuration
utility. Press <s> to skip Emulex BIOS

```

- Once pressed keys are recognized, the following message is displayed, then the menu screen is shown. If it does not appear, reboot the server and try again.

```

Emulex BIOS configuration utility selected
Bringing the Link up, Please wait...
Bringing the Link up, Please wait...

```

```

Emulex LightPulse BIOS Utility, UB2.02a2
Copyright (c) 1997-2008 Emulex. All rights reserved.

Emulex Adapters in the System:

1. LPe12002-M8:      PCI Bus, Device, Function (05,00,01)
2. LPe12002-M8:      PCI Bus, Device, Function (05,00,00)

Enter a Selection: _

Enter <x> to Exit

```

4. Server Settings

4.3. FC Controller BIOS Settings

4.3.2. Selecting the FC Port

- After the menu is displayed, select the number that corresponds to the port that is connected to the storage device in which the OS will be installed, and display the information screen of that port.

```

Emulex LightPulse BIOS Utility, UB2.02a2
Copyright (c) 1997-2008 Emulex. All rights reserved.

Emulex Adapters in the System:

1. LPe12002-MB:      PCI Bus, Device, Function (05,00,01)
2. LPe12002-MB:      PCI Bus, Device, Function (05,00,00)

Enter a Selection: _
  
```

- For the N8190-154, the PCI Bus and device are the same and ports 00 and 01 are displayed in Function. Of these, 00 corresponds to Port 0 and 01 to Port 1.
- The order in which Port 0 and Port 1 are displayed will differ depending on the servers.

4. Server Settings

4.3. FC Controller BIOS Settings

4.3.3. Boot Device Registration



Make sure that the Port Name of the selected port matches the WWPN of the port used for FC SAN Boot. If they do not match, press the <ESC> key, then reselect the port according to [“4.3.2 Selecting the FC Port.”](#)

- Select 1 in the following screen. A list of boot devices will be displayed.

```
Adapter 01:          PCI Bus, Device, Function (05,00,01)
LPc12002 MB:      Mem Base: FBB80000  Firmware Version: US1.11A5
Port Name: 10000000 C98E3121  Node Name: 20000000 C98E3121
Topology: Auto Topology: Loop First (Default)
The BIOS for this adapter is Disabled

1. Configure Boot Devices
2. Configure This Adapter's Parameters

Enter a Selection: _
```

4. Server Settings

4.3. FC Controller BIOS Settings

- After the boot device list is displayed, enter “1” to display the setup screen for the Primary Boot entry.

```

Adapter 01: S_ID: 000001   PCI Bus, Device, Function (05,00,01)

List of Saved Boot Devices:

1. Unused   DID:000000 WWPN:00000000 00000000 LUN:00 Primary Boot
2. Unused   DID:000000 WWPN:00000000 00000000 LUN:00
3. Unused   DID:000000 WWPN:00000000 00000000 LUN:00
4. Unused   DID:000000 WWPN:00000000 00000000 LUN:00
5. Unused   DID:000000 WWPN:00000000 00000000 LUN:00
6. Unused   DID:000000 WWPN:00000000 00000000 LUN:00
7. Unused   DID:000000 WWPN:00000000 00000000 LUN:00
8. Unused   DID:000000 WWPN:00000000 00000000 LUN:00

Select a Boot Entry: _

```

- If the boot device is not found through the selected port, the boot device list will not appear, and “This Adapter is not ready, try again!” message will be displayed. Make sure that the correct port is selected. If the port is correct, re-check the connection between server and storage disk array etc., then reboot the server and try again.

4. Server Settings

4.3. FC Controller BIOS Settings

- Input the number of the boot device to be registered.



Be sure to enter the device number that includes LUN0 as the boot device number. If an LUN0 device is not displayed, see [“3.1.3 Assigning LDs to an LD set”](#) and recheck LD assignment.

```

Adapter 01: S_ID: 000001   PCI Bus, Device, Function (05,00,01)

00 Clear selected boot entry!!
01 ALPA:BA(19) WWPN:22000016 971215F2 LUN:00 NEC   iStorage 1000 1000

Select The Two Digit Number of The Desired Boot Device: _

```

- When the input screen for entering device starting LUN digits appears, input 00 (meaning LUN0).

```

ALPA:BA(19) WWPN:22000016 971215F2

Enter two digits of starting LUN (Hex): _

<Esc> to Previous Menu

```

4. Server Settings

4.3. FC Controller BIOS Settings

- When the device LUN selection screen is displayed, input 01 (LUN:00).

```

Adapter 01: S_ID: 000001    PCI Bus, Device, Function (05,00,01)

ALPA:BA SelectID:19    WWPN:22000016 971215F2

01.    LUN:00
02.    LUN:01
03.    LUN:02

NEC    iStorage 1000 1000
NEC    iStorage 1000 1000
NEC    iStorage 1000 1000

Enter a Selection: _
B#W: Boot number via WWPN. B#D: Boot number via DID

```

- When the device boot method selection screen is displayed, input “1” (boot via WWPN).

```

DID:0000BA WWPN:22000016 971215F2 LUN:00

1. Boot this device via WWPN
2. Boot this device via DID

<Esc> to Previous Menu
Enter a Selection: _

```

4. Server Settings

4.3. FC Controller BIOS Settings

- The boot device list is displayed again. Make sure that the “Primary Boot” entry at the top is set to “Used.”

```

Adapter 01:  S_ID: 000001      PCI Bus, Device, Function (05,00,01)

List of Saved Boot Devices:
1. Used      DID:000000 WWPN:22000016 971215F2 LUN:00 Primary Boot
2. Unused   DID:000000 WWPN:00000000 00000000 LUN:00
3. Unused   DID:000000 WWPN:00000000 00000000 LUN:00
4. Unused   DID:000000 WWPN:00000000 00000000 LUN:00
5. Unused   DID:000000 WWPN:00000000 00000000 LUN:00
6. Unused   DID:000000 WWPN:00000000 00000000 LUN:00
7. Unused   DID:000000 WWPN:00000000 00000000 LUN:00
8. Unused   DID:000000 WWPN:00000000 00000000 LUN:00

```

- After checking the above, press <ESC> to return to the menu below.

```

Adapter 01:          PCI Bus, Device, Function (05,00,01)

LPe12002-MB:  Mem Base: FBB80000  Firmware Version: US1.11A5
Port Name: 10000000 C98E3121  Node Name: 20000000 C98E3121
Topology: Auto Topology: Loop First (Default)
The BIOS for this adapter is Disabled

1. Configure Boot Devices
2. Configure This Adapter's Parameters

Enter a Selection: _

```

4. Server Settings

4.3. FC Controller BIOS Settings

4.3.4. Boot BIOS Enable Setting

- Select “2” from the following menu to display the parameter setup screen.

```

Adapter 01:          PCI Bus, Device, Function (05,00,01)

LPe12002-MB:  Mem Base: FBB80000  Firmware Version: US1.11A5
Port Name: 10000000 C98E3121  Node Name: 20000000 C98E3121
Topology: Auto Topology: Loop First (Default)
The BIOS for this adapter is Disabled

1. Configure Boot Devices
2. Configure This Adapter's Parameters

Enter a Selection: _

```

- Select “1” to display the BIOS enable/disable setup screen.

```

Adapter 01:          PCI Bus, Device, Function (05,00,01)

LPe12002-MB:  Mem Base: FBB80000  Firmware Version: US1.11A5
Port Name: 10000000 C98E3121  Node Name: 20000000 C98E3121
Topology: Auto Topology: Loop First (Default)
The BIOS for this adapter is Disabled

1. Enable or Disable BIOS
2. Change Default ALPA of this Adapter
3. Change PLOGI Retry Timer (+Advanced Option+)
4. Topology Selection (+Advanced Option+)
5. Enable or Disable Spinup Delay (+Advanced Option+)
6. Auto Scan Setting (+Advanced Option+)
7. Enable or Disable EDD 3.0 (+Advanced Option+)
8. Enable or Disable Start Unit Command (+Advanced Option+)
9. Enable or Disable Environment Variable (+Advanced Option+)
10. Enable or Disable Auto Boot Sector (+Advanced Option+)
11. Link Speed Selection (+Advanced Option+)

Enter a Selection: _

```

4. Server Settings

4.3. FC Controller BIOS Settings

- Since BIOS is disabled by default, “The BIOS is Disabled!!” is displayed. Press “1.”

```
Adapter 01:          PCI Bus, Device, Function (05,00,01)

The BIOS is Disabled!!

Enable Press 1, Disable Press 2: _
```

- Make sure that “The BIOS is Enabled!!” is displayed, then press <ESC> twice to return to the port selection menu.

```
Adapter 01:          PCI Bus, Device, Function (05,00,01)

The BIOS is Enabled!!

Enable Press 1, Disable Press 2: _
```

- Repeat the steps in [“4.3.2 Selecting the FC Port”](#) for the remaining FC ports that are connected to storage devices in which OSs are to be installed to register the boot devices and enable the Boot BIOS.



Do not register the boot devices and do not enable the Boot BIOS of FC ports connected to storage devices in which OS will not be installed.

- FC controller BIOS setup is completed after setting up the rest of FC ports.

4. Server Settings

4.4. Making Single Path FC Connections

- When installing Windows OS or RHEL OS, the path connecting to the storage in which the OS is to be installed must be made a single path. The path to be left will differ depending on the server model.
 - * VMware can be installed with the redundant path connected.



When N8190-154 is on **R120d-2M**, **R120d-1M**, **R120d-2E** or **R120d-1E**, FC SAN Boot is executed with priority given to Port 1.



The remain of FC cable will be reconnected after installing the OS/PathManager.
Note for future reference the original connection location.

4. Server Settings

4.4. Making Single Path FC Connections

➤ R120d-2M

- Disconnect the FC cable from Slot #1B. If the FC controller mounting on Slot #2B is a N8190-154 unit, disconnect the FC cable connected to Port 0.

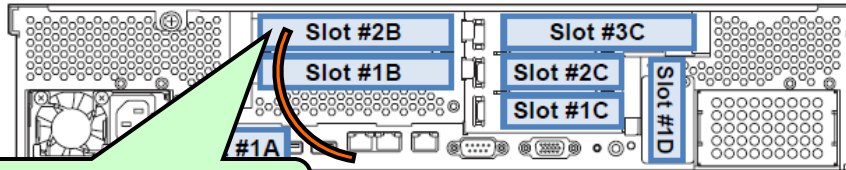

Leave the path to Port 1 of
N8190-154 units

➤ R120d-1M

- Disconnect the FC cable from Slot #1C. If the FC controller mounting on Slot #1B is a N8190-154 unit, disconnect the FC cable connected to Port 0.

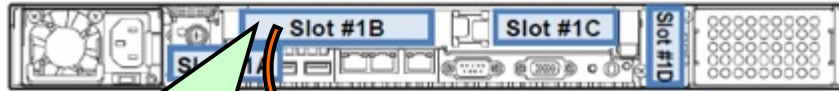

Leave the path to Port 1 of
N8190-154 units

4. Server Settings

4.4. Making Single Path FC Connections

➤ R120d-2E

- Disconnect the FC cable from Slot #2B. If the FC controller mounting on Slot #1B is a N8190-154 unit, disconnect the FC cable connected to Port 0.

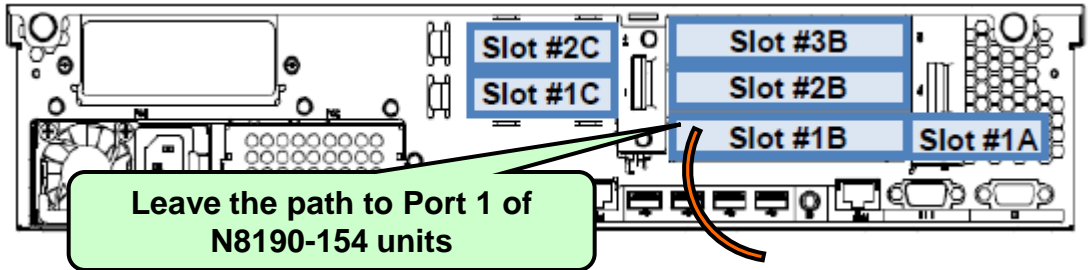

➤ R120d-1E

- Disconnect the FC cable from Slot #1C. If the FC controller mounting on Slot #1B is a N8190-154 unit, disconnect the FC cable connected to Port 0.

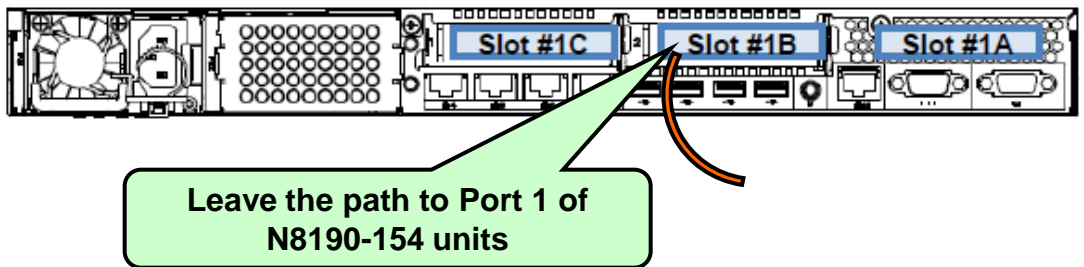

5. OS Installation

5.1. Overview

- After the configuration is completed through Chapter 4 and the OS installation area (LD) is recognized by the FC BIOS, OS installation can be initiated.

Installation method will differ depending on the OS. Please read carefully the procedures and precautions in each chapter before proceeding.

- Windows Server : [5.2. Windows](#)
 - Compatible with NEC Storage M series FC SAN Boot.
- Linux(Red Hat) : [5.3 Linux](#)
 - Compatible with NEC Storage M series FC SAN Boot.
- VMware : [5.4 VMware ESX/ESXi](#)
 - Compatible with NEC Storage M series FC SAN Boot.
 - * Go to the URL below and use a storage device that has VMware certification.
<http://www.vmware.com/resources/compatibility/search.php>

5. OS Installation

5.2. Windows

5.2.1. Windows Server 2008 and Windows Server 2008 R2 Installation

- This section describes the installation of Windows Server 2008 and Windows Server 2008 R2 into NEC Express5800 series. The compatible hardware devices are listed below.

<NEC Express5800 Series>

Product name
R120d-2M
R120d-1M
R120d-2E
R120d-1E

- The Windows OS is installed according to the following flow.

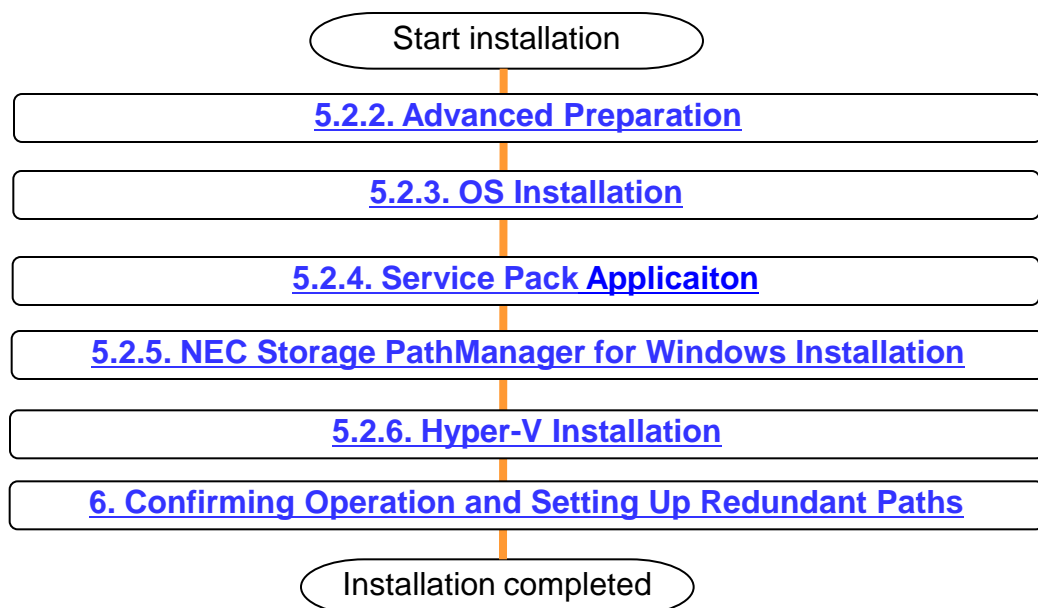

5. OS Installation

5.2. Windows

5.2.2. Advanced Preparations



Do not make the path between the server and NEC M-series Storage redundant without installing PathManager. Doing so can lead to OS installation failure.

➤ Items necessary for installation

- EXPRESSBUILDER DVD
 - ➔ R120d-2M / R120d-1M: Ver. 6.10-021.01 or later
 - ➔ R120d-2E / R120d-1E: Ver. 6.10-023.01 or later
- OS installation media
 - ➔ NEC OS installation media (hereafter referred to as “**backup DVD**”)
- Installation Guide (Windows) (in EXPRESSBUILDER DVD)

5. OS Installation

5.2. Windows

5.2.3. OS Installation

- Following the instructions in Installation Guide (Windows), install the OS with OS Standard Installer.

5.2.4. Service Pack Application

5.2.4.1. Windows Server 2008

- See the information on the following website and install Service Pack 2.
- Windows Server 2008 Service Pack 2
→ <http://www.58support.nec.co.jp/global/download/w2008sp2/index.html>

5.2.4.2. Windows Server 2008 R2

- See the information on the following website and install Service Pack 1. This step can be skipped if Service Pack 1 is not to be installed.
- Windows Server 2008 R2 and Windows 7 Service Pack 1
→ <http://www.58support.nec.co.jp/global/download/w2008r2/sp1.html>

5.2.5. NEC Storage PathManager for Windows Installation

- Install NEC Storage PathManager that makes NEC M-series Storage path redundant.
Do not make the path between the server and NEC M-series Storage redundant until installation is completed.
- To use NEC Storage PathManager, install it according to “**Installation**” in the “**Installation Guide**” provided with the product.
When using the NEC Storage PathManager that comes with an NEC M10e or M100 series unit, install the software according to “**NEC Storage PathManager Installation**” in the “**Disk Array Unit User’s Guide**” that comes with the unit.

5. OS Installation

5.2. Windows

5.2.6. Hyper-V Installation (only when using Hyper-V)

Follow the steps below in order to use Hyper-V with Windows Server 2008 or Windows Server 2008 R2. This section can be skipped if Hyper-V is not used.

- (1) Start the Server Manager.
- (2) Select “Roles” from the menu at left, then click “Add Roles.”

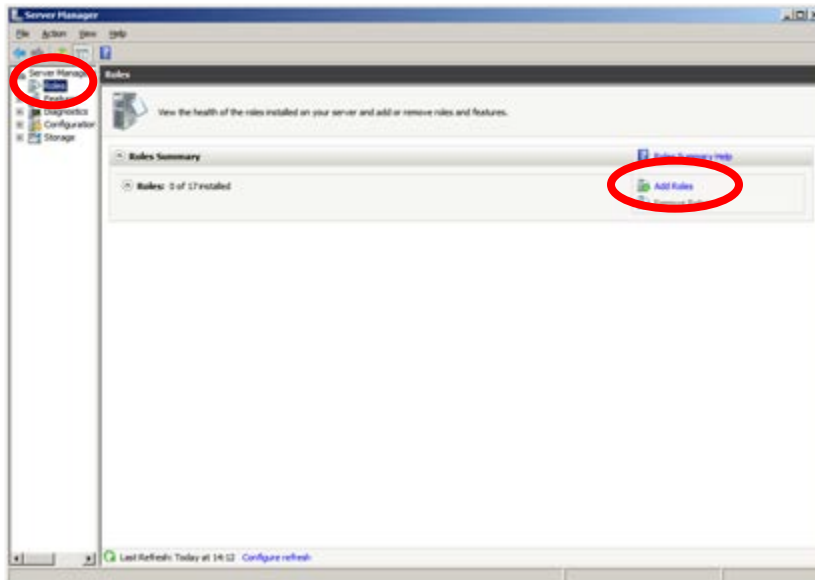

- (3) After the screen below is displayed, click “Next.”

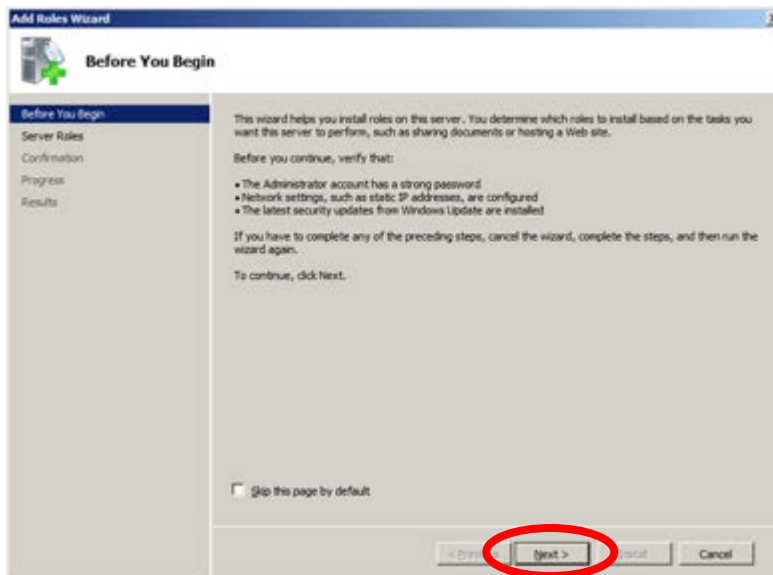

5. OS Installation

5.2. Windows

(4) Select “Hyper-V” from the following screen, then click “Next.”

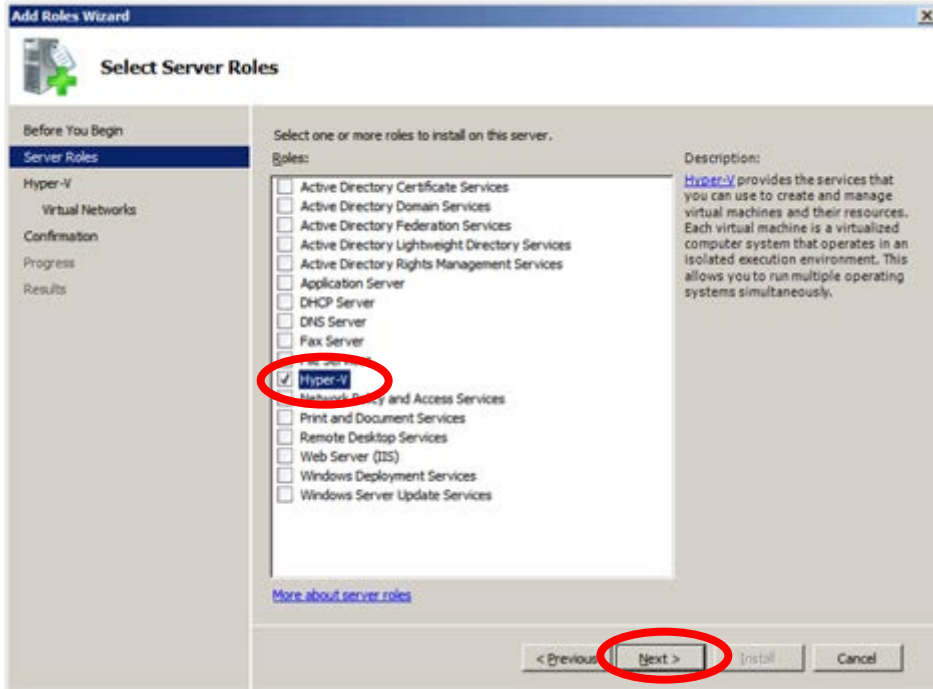

(5) After the screen below is displayed, click “Next.”

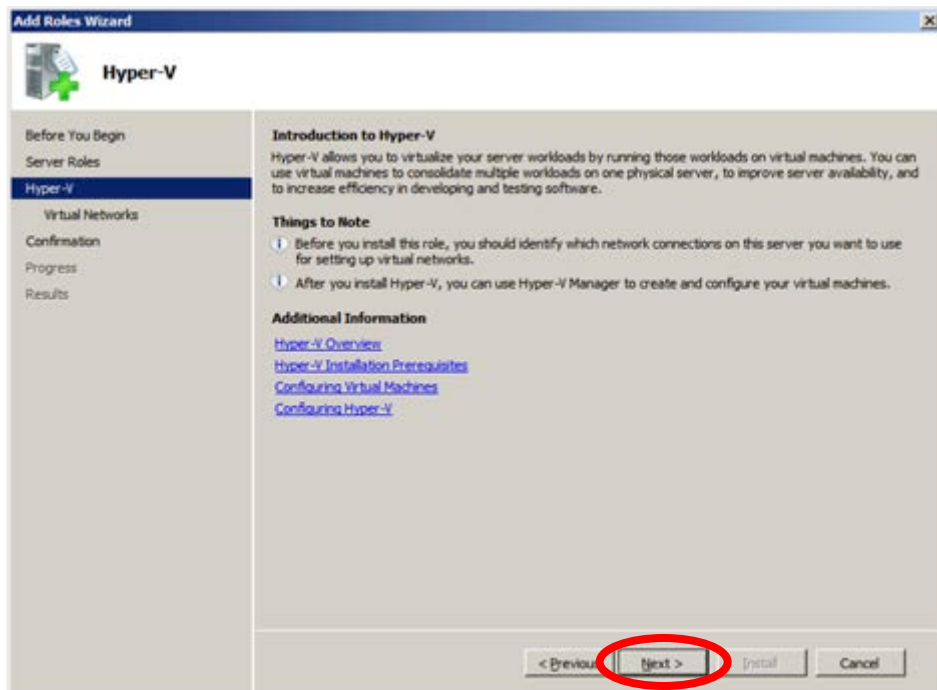

5. OS Installation

5.2. Windows

- (6) After the screen below is displayed, select the network adapter to connect the virtual network switch if necessary, then click “Next.” The virtual network switch is necessary for the virtual machine to communicate with other computers.

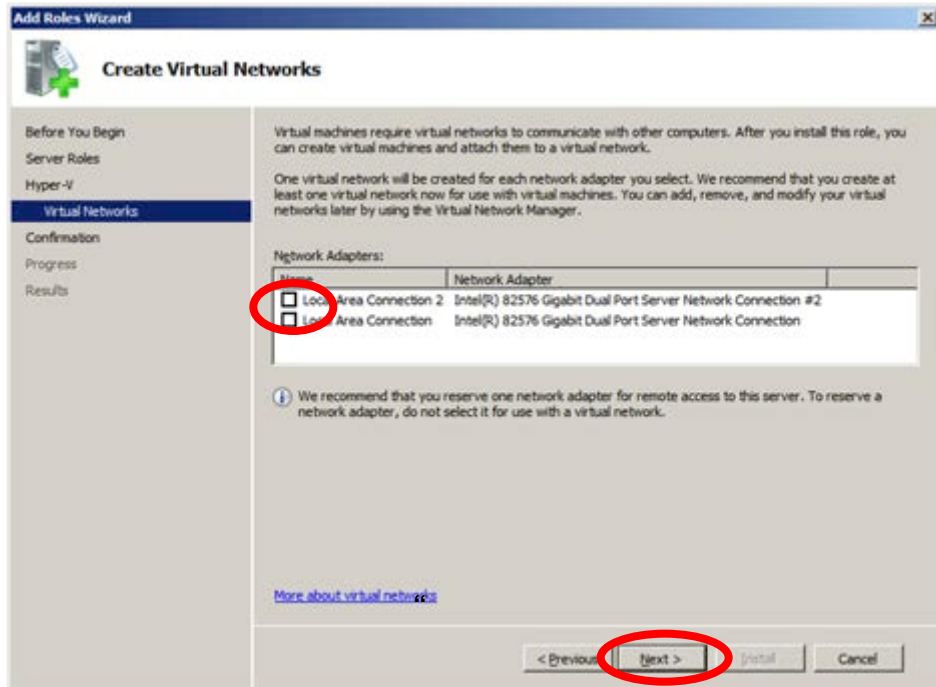

- (7) After the screen below is displayed, click “Install.”

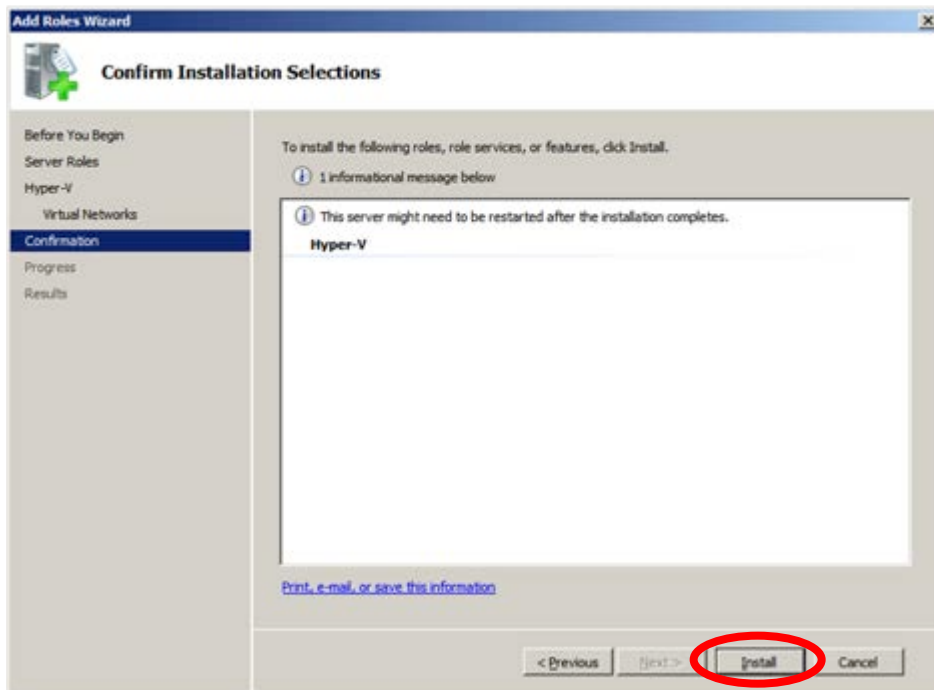

5. OS Installation

5.2. Windows

(8) Hyper-V is being installed.

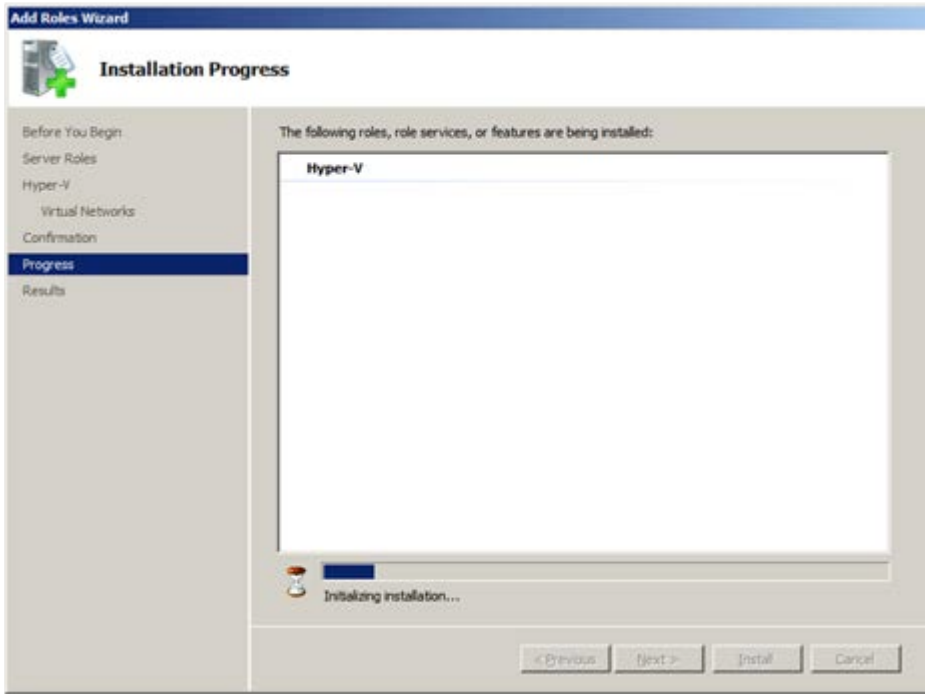

(9) After the screen below is displayed, click “Close.”

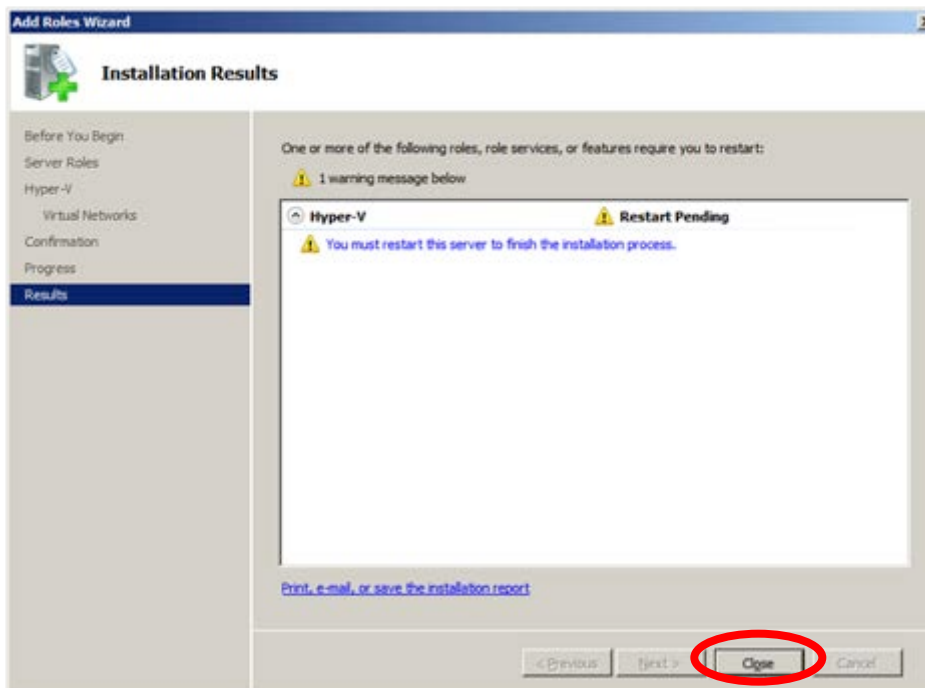

5. OS Installation

5.2. Windows

(10) After the screen below is displayed, click “Yes” and reboot the server.

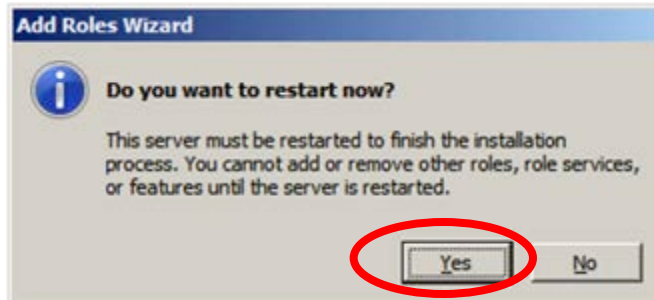

(11) After rebooting and logging into Windows, Hyper-V installation will continue.

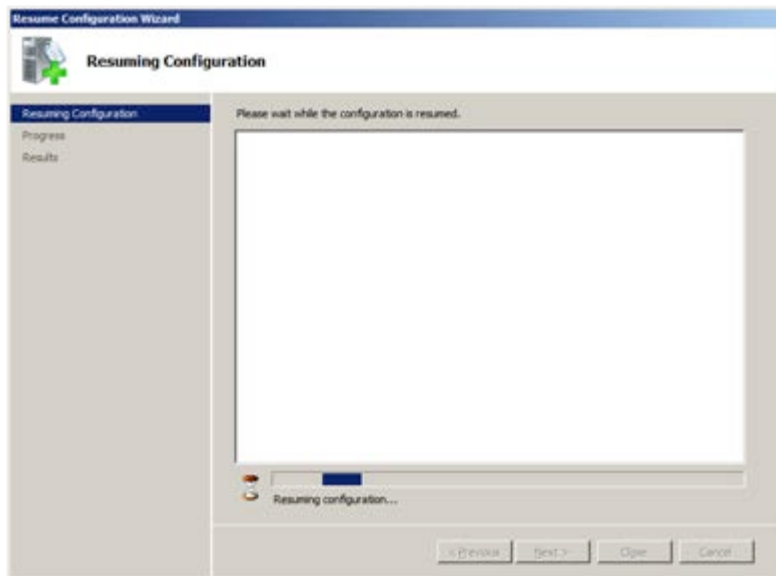

(12) After the screen below is displayed, click “Close.”

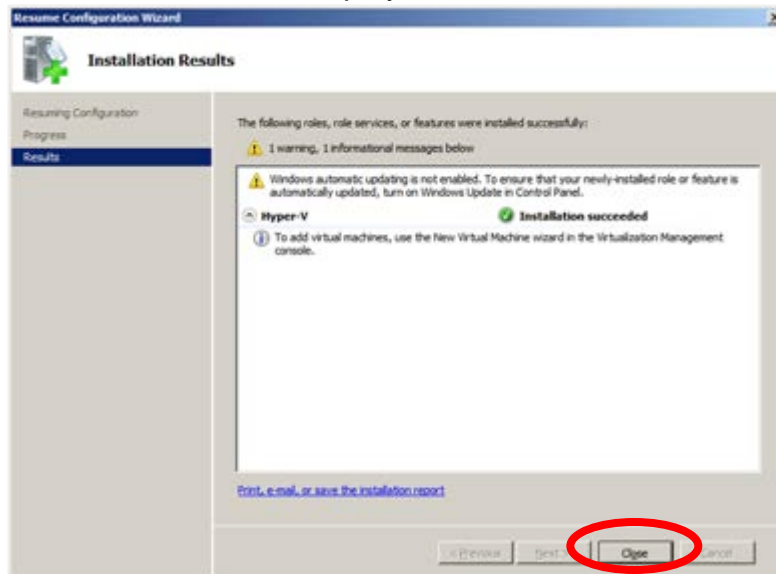

5. OS Installation

5.2. Windows

(13) Install a hotfix program if necessary.

- Windows Server 2008

→ None

- Windows Server 2008 R2

1. KB2517374: <http://support.microsoft.com/kb/2517374>

If Service Pack 1 is not installed, install a hotfix program if any of the following devices is applied.

If Service Pack 1 is installed, the updates are not necessary.

R120d-2M	All models
R120d-1M	All models
R120d-2E	All models
R120d-1E	All models

After completing all of the above, go to “[6. Confirm Operation and Setting Up Redundant Paths.](#)”

5. OS Installation

5.3. Linux

5.3.1. Red Hat Enterprise Linux 5 and Red Hat Enterprise Linux 6 Installation

■ NEC supported OS version

	RHEL5	RHEL6
R120d-2M R120d-1M	RHEL5.7 and later	RHEL6.1 and later
R120d-2E R120d-1E	RHEL5.7 and later	RHEL6.2 and later

■ Installation Guide

- Red Hat Enterprise Linux 5
https://access.redhat.com/knowledge/docs/en-US/Red_Hat_Enterprise_Linux/5/html/Installation_Guide/pt-install-info-x86.html
- Red Hat Enterprise Linux 6
https://access.redhat.com/knowledge/docs/en-US/Red_Hat_Enterprise_Linux/6/html/Installation_Guide/pt-install-info-x86.html

5. OS Installation

5.3. Linux

5.3.2. PathManager Installation

- This section describes how to install the “NEC StoragePathManager for Linux” in SAN Boot environment of NEC Express5800 series.
- Red Hat Enterprise Linux 5 or 6 are prerequisites, and one of the following functional versions of PathManager should be used.
 - Red Hat Enterprise Linux 5 → Functional Version 4.0.1 or higher
 - Red Hat Enterprise Linux 6 → Functional Version 5.1.5 or higher

5.3.3. Before Setting Up

- Confirm the following before setting up PathManager.
 - (1) Set up the FC driver according to the FC controller setup instructions. If the FC drivers that come with the OS are used, then it is not necessary to reinstall the drivers.
 - (2) If an FC switch is connected, then the FC switch must be set up.
 - (3) If there is a cross call setting for M-series Storage device, then it must be set to “On.” See the Storage device instructions on how to set up the cross call settings.
 - (4) Make sure that ExpressCluster is not set up.
If ExpressCluster is used, set up PathManager before setting up ExpressCluster. In order to install PathManager in an environment in which ExpressCluster is installed, ExpressCluster must be paused.
 - (5) It must be possible to execute the `sg_scan` command.
Since the `sg_scan` command will be necessary, install the required package if it is not already installed. (See [“5.3.3.1 Checking for the sg_scan Command”](#) for details.)

Check the following only for Red Hat Enterprise Linux 5

- (6) Make sure that the mount targets are not used for the label names.
When mounting NEC Storage SCSI device partitions when booting, do not use the label information to mount them. If label information is used, mount without the label information. (See [“5.3.3.2 Checking for Mount Targets”](#) for details.)
- (7) After consulting [“5.3.3.2 Checking for Mount Targets,”](#) make sure that there are no problems in using a multiple path configuration.

5. OS Installation

5.3. Linux

5.3.3.1. Checking for the sg_scan Command

This section describes how to check `sg_scan` used in “[5.3.5.2 Installation in a SAN Boot Environment](#).” Please follow the instructions below.

- (1) Execute the `sg_scan` command.

```
# sg_scan
/dev/sg0:  scsi0  channel=0  id=0  lun=0
/dev/sg1:  scsi0  channel=0  id=0  lun=1
```

- (2) There are no problems if the above is output or there is no output. Since the `sg_scan` command can be executed, go to “[5.3.3.2 Checking for Mount Targets](#).” If “command not found” is displayed, then go to the next step.

- (3) Use the `rpm` command to make sure that `sg3_utils` is installed.

```
# rpm -qa |grep sg3_utils
sg3_utils-x.xx-x.x
sg3_utils-libs-x.xx-x.x
```

- (4) There is no problem if the version is displayed as in the example above. If “command not found” is displayed in (2) above, then make sure that there is a path to `sg_scan` (to `/usr/bin`). If there is no such path, add `/usr/bin` to `$PATH`, then go to one of the following sections for the respective OS. If nothing is displayed, then go to step (5).

- Red Hat Enterprise Linux 5 → “[5.3.3.2. Checking for Mount Targets](#)”
- Red Hat Enterprise Linux 6 → “[5.3.3.4. PathManager Setup](#)”

- (5) Prepare the `sg3_utils` RPM package.

Insert the installation disk that contains the `sg3_utils` RPM package into the DVD drive and mount it.

5. OS Installation

5.3. Linux

(6) Install sg3_utils.

If sg3_utils-libs is not installed, it must be installed first.

```
# rpm -ivh sg3_utils-libs-x.xx-x.x.xxx.rpm
Preparing... #####
[100%]
 1:sg3_utils-libs #####
[100%]
# rpm -ivh sg3_utils-x.xx-x.x.xxx.rpm
Preparing... #####
[100%]
 1:sg3_utils #####
[100%]
```

- * Warnings such as "DSA signature: NOKEY, key ID db42a60e" may be output, but they can be ignored.

(7) Make sure that **sg_scan** can be executed.

```
# sg_scan
/dev/sg0: scsi0 channel=0 id=0 lun=0
/dev/sg1: scsi0 channel=0 id=0 lun=1
```

This completes confirmation of the sg_scan command. Go to one of the following sections for the respective OS.

- Red Hat Enterprise Linux 5 → "[5.3.3.2. Checking for Target Mounts](#)"
- Red Hat Enterprise Linux 6 → "[5.3.3.4. PathManager Setup](#)"



The output results are examples. The actual output may differ depending on your environment.

5. OS Installation

5.3. Linux

5.3.3.2. Checking for Mount Targets

This section checks for mount targets when booting, and changes settings if label names are used for mounting. Please follow the instructions below.

(1) Check the information for `/etc/fstab` and `/boot/grub/grub.conf`.

```
# cat /etc/fstab
LABEL=/          /                ext3      defaults    1 1
LABEL=/boot      /boot            ext3      defaults    1 2
none             /dev/pts         devpts    gid=5,mode=620 0 0
none             /dev/shm         tmpfs     defaults    0 0
none             /proc            proc      defaults    0 0
none             /sys             sysfs     defaults    0 0
LABEL=/swap      swap             swap      defaults    0 0
...
```

```
# cat /boot/grub/grub.conf
# grub.conf generated by anaconda
...
#boot=/dev/sda
default=0
timeout=5
splashimage=(hd0,0)/grub/splash.xpm.gz
hiddenmenu
title Red Hat Enterprise Linux Server (2.6.18-53.el5)
    root (hd0,0)
    kernel /vmlinuz-2.6.18-53.el5 ro root=LABEL=/ rhgb quiet
    initrd /initrd-2.6.18-53.el5.img
```

If "LABEL" is shown in the first field of `/etc/fstab` (the shaded area) or after "root=" in `/boot/grub/grub.conf`, the label names are used for mounting. In those cases, go to the next step.

Otherwise, go to "[5.3.3.4 PathManager Setup.](#)"

5. OS Installation

5.3. Linux

- (2) Check the device file name that corresponds to the label.

```
# mount
/dev/sda2 on / type ext3 (rw)
none on /proc type proc (rw)
none on /sys type sysfs (rw)
none on /dev/pts type devpts (rw,gid=5,mode=620)
usbfs on /proc/bus/usb type usbfs (rw)
/dev/sda1 on /boot type ext3 (rw)
none on /dev/shm type tmpfs (rw)
none on /proc/sys/fs/binfmt_misc type binfmt_misc (rw)
...
# cat /proc/swaps
Filename                Type              Size      Used      Priority
/dev/sdb1                partition         1048544  0         42
. . .
```

- (3) Specify the device file that corresponds to the label from the results of `/etc/fstab` and `mount`.

In the above example, they correspond as follows:

LABEL=/ is `/dev/sda2`

LABEL=/boot is `/dev/sda1`

LABEL=/swap is `/dev/sdb1`

- (4) The `/etc/fstab` and `/etc/grub.conf` notations should be changed to corresponding device files with an editor. (The following shows the results after editing.)

```
# cat /etc/fstab
/dev/sda2      /                ext3          defaults      1 1
/dev/sda1      /boot            ext3          defaults      1 2
none           /dev/pts         devpts        gid=5,mode=620 0 0
none           /dev/shm         tmpfs         defaults      0 0
none           /proc            proc          defaults      0 0
none           /sys             sysfs         defaults      0 0
/dev/sdb1      swap             swap          defaults      0 0
...
```

```
# cat /etc/grub.conf
# grub.conf generated by anaconda
...
#boot=/dev/sda
default=0
timeout=5
splashimage=(hd0,0)/grub/splash.xpm.gz
hiddenmenu
title Red Hat Enterprise Linux Server (2.6.18-53.el5)
    root (hd0,0)
    kernel /vmlinuz-2.6.18-53.el5 ro root=/dev/sda2 rhgb quiet
    initrd /initrd-2.6.18-53.el5.img
```

5. OS Installation

5.3. Linux

(5) Restart the system and make sure it boots normally.

```
# sync
# shutdown -r now
```

(6) Make sure that the mounted devices are correct.

```
# mount
/dev/sda2 on / type ext3 (rw)
none on /proc type proc (rw)
none on /sys type sysfs (rw)
none on /dev/pts type devpts (rw,gid=5,mode=620)
usbfs on /proc/bus/usb type usbfs (rw)
/dev/sda1 on /boot type ext3 (rw)
none on /dev/shm type tmpfs (rw)
none on /proc/sys/fs/binfmt_misc type binfmt_misc (rw)
...
# cat /proc/swaps
Filename                Type              Size              Used              Priority
/dev/sdb1                partition         1048544           0                  42
...
```

This completes confirmation of mount targets. Next, go to "[5.3.3.3 Redundant Path Connections](#)."

5. OS Installation

5.3. Linux

5.3.3.3. Redundant Path Connections

Path connections should be made after checking the mount targets.

- (1) Reconnect the disconnected paths.
- (2) Restart the system and make sure that it boots normally.

```
# shutdown -r now
```



Depending on the configuration, reconnecting paths may change the order in which they are recognized by the OS. This may cause an error when booting. (Example: /dev/sdb changed to /dev/sdc after connecting paths.)

In such a configuration, make sure that there are no settings using labels, then go to the next step without reconnecting paths.

In this case, paths are reconnected after "[5.3.4.4 Migration to an Environment Using PathManager.](#)"

This completes the redundant path connections. Next, go to "[5.3.3.4 PathManager Setup.](#)"

5.3.3.4. PathManager Setup

PathManager is set up using the installation CD-ROM and following the steps below. Be sure to set up PathManager by booting the OS with the kernel that uses PathManager and as the root user.



Do not use the PathManager version 4.0.0 rpm file (the RPM file name that starts with "sps-E-4.0.0-") that comes on the PathManager 4.0 installation CD-ROM. Use the rpm file for PathManager version 4.0.1 or later.

Insert the installation CD-ROM and mount it.

```
# mkdir -p /mnt/cdrom
# mount /dev/cdrom /media/cdrom
```

If it is automounted, go to the automount target directory.

```
# cd /media/ [auto-mounted-directory]
```

5. OS Installation

5.3. Linux

Table 1-1 shows the files in the installation CD-ROM.

Table 1-1 List of Files in the Installation CD-ROM (*1)

Directories and file names	Description
<pre>Express5800_100 -- RPMS -- RHEL4 -- RHEL5 -- 5.2 -- 5.3 -- IA32 -- sps-utils-4.2.1-0.i686.rpm (*3) -- sps-driver-E-4.2.4- 2.6.18.128.el5.i686.rpm -- EM64T -- sps-utils-4.2.1-0.x86_64.rpm -- sps-driver-E-4.2.4- 2.6.18.128.el5.x86_64.rpm -- 5.4 -- IA32 -- sps-utils-4.3.0-0.i686.rpm -- sps-driver-E-4.3.3- 2.6.18.164.el5.i686.rpm -- sps-driver-E-4.3.3- 2.6.18.164.9.1.el5.i686.rpm -- EM64T -- sps-utils-4.3.0-0.x86_64.rpm -- sps-driver-E-4.3.3- 2.6.18.164.el5.x86_64.rpm -- sps-driver-E-4.3.3- 2.6.18.164.9.1.el5.x86_64.rpm</pre>	RPM file PathManager package
<pre>Express5800_100 -- doc -- IS202.pdf -- ISRX203.pdf</pre>	PathManager for Linux instructions (PDF format) PathManager for Linux installation guide (PDF format)
<pre>Express5800_A1000 -- RPMS -- doc</pre>	For Express5800/Scalable HA Server
<pre>readme.txt filelist.txt gpl.txt</pre>	
<pre>install.txt install.sh</pre>	Installer

5. OS Installation

5.3. Linux



- *1: The grayed out files in the table are not used in a SAN Boot environment.
- *2: From PathManager 4.0.1 to PathManager 4.1.3, there is one rpm file per kernel.
- *3: For PathManager 4.2.1 or later, rpm files are divided into the following functional units:
 - sps-utils (utility), sps-driver (driver)
- *4: The filenames of the PathManager CD-ROM product are partial.

5. OS Installation

5.3. Linux

5.3.4. Installation

5.3.4.1. PathManager Installation

PathManager is installed using the installation CD-ROM and taking the following steps. As the root administrator, be sure to set up PathManager by booting the OS with the kernel that uses PathManager.

Because the installation process differs depending on the kernel version, refer to (1) and (2) below and use the suitable process.

(The kernel version can be checked with the "**uname -r**" command.)

(1) Red Hat Enterprise Linux 5.4 (Kernel-2.6.18-164.el5) and later
Installation can be executed with the installer.

1. Go to the mount target directory.
(* If automounted, go to the automounted target directory.)

```
# cd /mnt/cdrom  
#
```

5. OS Installation

5.3. Linux

2. Specify the **-i** option and install the RPM file. (Execute the underlined command in the box below.)
 - *1. If the **--silent** option is not specified, the OS will not be rebooted.
The OS must be rebooted before using PathManager. Reboot manually.
 - *2. Specify the **--iscsi** option for iSCSI connections.
Also specify the **--iscsi** option for the configurations that use both iSCSI and FC.
This is the same for both boot disks and data disks that use iSCSI.

For Kernel Version 2.6.18-164.el5 (FC Connection)

```
# sh install.sh -i --silent
===== Precheck for SPS Installation / Uninstallation =====
Distribution      : RedHat
Architecture     : i686
Kernel Version   : Linux2.6
Kernel Details   : 2.6.18-164.el5
----- The following packages will be installed. -----
driver : ./Express5800_100_NX7700i/RPMS/RHEL5/5.4/IA32/sps-driver-E-
4.3.1-2.6.18.164.el5.i686.rpm
utils   : ./Express5800_100_NX7700i/RPMS/RHEL5/5.4/IA32/sps-utils-
4.3.0-0.i686.rpm
=====
Preparing...      ##### [100%]
  1:sps-driver-E  ##### [100%]
Preparing...      ##### [100%]
  1:sps-utils     ##### [100%]
patching file rc.sysinit
Starting up sps devices:
Couldn't open /etc/sps.conf. No such file or directory.
I try auto setting...
Wait.
parsing... device:/dev/dda (OK)
parsing... disk-info:NEC      ,iStorage 1000      ,0000000935000734,00001
(OK)
parsing... LoadBalance:D2 (OK)
parsing... path-info:0 Host:scsi:8 Channel:0 Id:0 Lun:0 Priority:1
Watch:Enable Status:ACT (OK)
parsing... path-info:7 Host:scsi:7 Channel:0 Id:0 Lun:0 Priority:2
Watch:Enable Status:ACT (OK)
Wait until all /dev/ddX is made.....END
dd_daemon (pid 3963) is running...
sps Install Completed.....
#
Broadcast message from root (Thu Feb 25 14:15:57 2010):
The system is going DOWN for reboot in 1 minute!
```

This is always output for the first installation, but it is not a problem.

5. OS Installation

5.3. Linux

3. If installation is completed successfully, the message "sps Install Completed" (the shaded area) is output. Installation fails if this message is not output. In that case, follow the instructions in "Appendix D. Installer Error Messages" in the "NEC Storage PathManager for Linux Installation Guide".
4. If installation is completed successfully, the system will restart in one minute. Make sure that the OS functions normally.

This completes installation of PathManager for RHEL5.4 or later. Next, go to "[5.3.4.2 Installation in a SAN Boot Environment.](#)"

- (2) Systems before Red Hat Enterprise Linux 5.4 (Kernel-2.6.18-164.el5):
Install manually.

Go to the directory which corresponds to the system in the distribution and architecture (IA32, etc.) under Express5800_100/RPMS/. (See "[5.3.3.4 PathManager Setup](#)" for the directory structure.)

1. Install the RPM file that corresponds to the kernel version being used with the following command.
 - For Kernel Version 2.6.18-128.el5 –
 (The shaded sections indicate the corresponding kernel version.)

```
# rpm -ivh sps-utils-*
sps-utils          #####
# uname -r
2.6.18-128.el5
# rpm -ivh sps-driver-E-2.6.18.128.el5.*.rpm
sps-driver-?      #####
#
```



- For versions before Red Hat Enterprise Linux 5.3 (Kernel 2.6.18-128.el5), this is a package name that contains both sps-utils and sps-driver.
Example: sps-E-4.1.3-2.6.18.92.el5.i686.rpm

5. OS Installation

5.3. Linux

The following files are installed:

```

/lib/modules/(kernel version)/ kernel/drivers/scsi/dd_mod.ko
/lib/modules/(kernel version)/ kernel/drivers/scsi/sps_mod.ko
/lib/modules/(kernel version)/ kernel/drivers/scsi/sps_mod2.ko
/sbin/dd_daemon
/sbin/spscmd
/sbin/hotaddpath
/sbin/hotremovepath
/sbin/removearrayinfo
/sbin/recoverpath
/sbin/mkdd
/sbin/spsconfig
/etc/dualpathrc
/etc/rc.d/init.d/dd_daemon
/etc/rc.d/rc0.d/K77dd_daemon
/etc/rc.d/rc1.d/K77dd_daemon
/etc/rc.d/rc2.d/S45dd_daemon
/etc/rc.d/rc3.d/S45dd_daemon
/etc/rc.d/rc5.d/S45dd_daemon
/etc/rc.d/rc6.d/K77dd_daemon
/opt/nec/report/inf/dualpath.inf
/opt/nec/report/table/dualpath.tbl
/opt/nec/sps/esm/report/inf/dualpath.inf
/opt/nec/sps/esm/report/table/dualpath.tbl
/opt/nec/sps/esm/report/inf/dualpathE.inf
/opt/nec/sps/esm/report/table/dualpathE.tbl
/opt/nec/sps/bin/spslog.sh
/opt/nec/sps/bin/sps_setesmtbl.sh
/opt/nec/sps/patch/rc.sysint.rhel5.diff

```

2. Execute the following command and make sure that no error occurs.

```
# depmod -a `uname -r`
#
```



Be sure to enclose **uname -r** in back quotes (` `).

5. OS Installation

5.3. Linux

3. Set up automatic booting.

In order to start the PathManager driver when booting the OS, the OS boot script (/etc/rc.d/rc.sysinit) must be edited. If an iSCSI connection is used, the iSCSI initiator startup script (/etc/rc.d/init.d/iscsi/) must also be edited. Apply the patch file as shown below to edit startup scripts. (*1).

If the OS boot script before applying the patch file is /etc/rc.d/rc.sysinit.orig, then the iSCSI initiator startup script will be left as /etc/rc.d/init.d/iscsi.orig. If this patch file has already been applied to the OS boot script, it does not have to be applied again.

```
# cd /etc/rc.d

<FC connection>
# patch -b -p0 < /opt/nec/sps/patch/rc.sysinit.rhel5.diff

<iSCSI connection>
# patch -b -p0 < /opt/nec/sps/patch/iscsi.rhel5.diff
```



*1: Patches can be applied to both /etc/rc.d/rc.sysinit and /etc/rc.d/init.d/iscsi with one patch.

When a patch command is executed, an error may occur and the patch file may not be applied correctly. In that case, add the lines in the patch file that start with "+" to /etc/rc.d/rc.sysinit and /etc/rc.d/init.d/iscsi. Refer to the contents of the patch file when adding these lines.

4. Reboot the system and make sure that it starts normally.

```
# sync
# shutdown -r now
```

This completes PathManager installation.

Next, go to "[5.3.4.2. Installation in a SAN Boot Environment.](#)"

5. OS Installation

5.3. Linux

5.3.4.2. Installation in a SAN Boot Environment (Red Hat Enterprise Linux 5)

Follow the process below to use the system in a SAN Boot environment.

Setup process for using a SCSI device (/dev/sdX) as a root device in a SAN Boot environment.

(When the PathManager device (/dev/ddX) is not used as the root device.)

- * A root device is a necessary device to boot the OS. ("/" or "/boot" or "swap" by default)

(1) Make sure that the following description is not in /etc/modprobe.conf.

```
# cat /etc/modprobe.conf
...
# Please add the following line to /etc/modprobe.conf
options sps_mod
dda=NEC_____,iStorage_2000_____,00000000929200235,00000
ddb=NEC_____,iStorage_2000_____,00000000929200235,00001
...
```

(2) Set up the boot RAM disk to include the PathManager driver. After backing up the current settings, add the following line (shaded line) to the end of the /etc/modprobe.conf.

```
# cp -p /etc/modprobe.conf /etc/modprobe.conf.sps
# vi /etc/modprobe.conf
...
alias scsi_hostadapter aic79xx
alias scsi_hostadapter1 lpfc
alias usb-controller uhci-hcd
alias scsi_hostadapter2 dd_mod .....*1
```



*1: scsi_hostadapterX: Specify X as the largest number in the alias scsi_hostadapter line in the file.

5. OS Installation

5.3. Linux

- (3) Check the root devices. In the following example, the root devices are `/dev/sda` and `/dev/sdb`.

```
# cat /etc/fstab
/dev/sda2      /                ext3          defaults      1 1
/dev/sda1      /boot            ext3          defaults      1 2
none          /dev/pts         devpts        gid=5,mode=620 0 0
none          /dev/shm         tmpfs         defaults      0 0
none          /proc            proc          defaults      0 0
none          /sys             sysfs         defaults      0 0
/dev/sdb1      swap             swap          defaults      0 0
...
# mount
/dev/sda2 on / type ext3 (rw)
none on /proc type proc (rw)
none on /sys type sysfs (rw)
none on /dev/pts type devpts (rw,gid=5,mode=620)
usbfs on /proc/bus/usb type usbfs (rw)
/dev/sda1 on /boot type ext3 (rw)
none on /dev/shm type tmpfs (rw)
none on /proc/sys/fs/binfmt_misc type binfmt_misc (rw)
...
# cat /proc/swaps
Filename                                Type              Size      Used
Priority
/dev/sdb1                                partition         1048544  0      42
...
```

- (4) Confirm the PathManager device that corresponds to the root device (`/dev/sd*`) checked in (3). The PathManager device that corresponds to the root device can be confirmed by adding the **-chk** option to the **spsconfig** command and executing it. In the following example, it can be confirmed that `/dev/sda` corresponds to `/dev/dda` and `/dev/sdb` corresponds to `/dev/ddb`.

```
# spsconfig -chk /dev/sda /dev/sdb
/dev/sda -> /dev/dda
/dev/sdb -> /dev/ddb
```

5. OS Installation

5.3. Linux

- (5) Generate the options setup to set up the PathManager device confirmed in (4) as the route device. Execute the **spsconfig** command with the **-add** option to generate the options setup. In the example below, the generated options setup is added through redirection to `/etc/modprobe.conf`.

```
# spsconfig -add /dev/dda /dev/ddb >> /etc/modprobe.conf ...*2
```



*2: Be sure to use two right arrows (">>") in the description. Using only one will ">" overwrite the contents of `/etc/modprobe.conf` and the OS will not be bootable.

- (6) Make sure that the following description is in `/etc/modprobe.conf`.

```
# cat /etc/modprobe.conf
...
# Please add the following line to /etc/modprobe.conf
options sps_mod
dda=NEC_____,iStorage_2000____,0000000929200235,00000
ddb=NEC_____,iStorage_2000____,0000000929200235,00001
...
```

- (7) After backing up the current settings, change the root device described in `"/etc/fstab"` to the PathManager device confirmed in (4).

```
# cp -p /etc/fstab /etc/fstab.sps
# vi /etc/fstab
/dev/dda2      /          ext3      defaults      1 1
/dev/dda1      /boot      ext3      defaults      1 2
none          /dev/pts   devpts    gid=5,mode=620 0 0
none          /dev/shm   tmpfs     defaults      0 0
none          /proc      proc      defaults      0 0
none          /sys       sysfs     defaults      0 0
/dev/ddb1      swap       swap      defaults      0 0
...
```

- (8) Generate a boot RAM disk that includes the PathManager driver. Executing the **mkinitrd** command as shown below will generate the boot RAM disk. In the example below, a boot RAM disk designated `/boot/initrdsps.img` is generated.

```
# mkinitrd /boot/initrdsps.img `uname -r`
```



Be sure to enclose `uname -r` in back quotes (` `).

5. OS Installation

5.3. Linux

(9) Add a setting to start with the boot RAM disk created in (8) to the boot loader settings. This is done using the following process:

1. Back up /boot/grub/grub.conf.
2. Copy the current settings used for booting.
3. Change the title to an arbitrary name.
4. Change initrd to the file name of the boot RAM disk created in (8).
5. Based on the results confirmed in (4), specify the PathManager device that corresponds to /dev/sd* for root.
6. Change the value of the default line.

```
# cp -p /boot/grub/grub.conf /boot/grub/grub.conf.sps
# vi /boot/grub/grub.conf
...
#boot=/dev/sda
default=0
timeout=5
splashimage=(hd0,0)/grub/splash.xpm.gz
hiddenmenu

title Red Hat Enterprise Linux Server (2.6.18-53.el5_spssan)
    root (hd0,0)
    kernel /vmlinuz-2.6.18-53.el5 ro root=/dev/dda2 rhgb
quiet
    initrd /initrdsps.img

---
title Red Hat Enterprise Linux Server (2.6.18-53.el5)
    root (hd0,0)
    kernel /vmlinuz-2.6.18-53.el5 ro root=/dev/sda2 rhgb
quiet
    initrd /initrd-2.6.18-53.el5.img
...

```

The diagram illustrates the process of modifying the GRUB configuration file. It shows the original configuration with callouts for steps 1 through 6. Step 1 points to the backup command. Step 2 points to the copy command. Step 3 points to the title change. Step 4 points to the kernel and initrd changes. Step 5 points to the root device change. Step 6 points to the default line change. A green arrow indicates the transition from the original configuration to the modified configuration.

(10) Reboot the system and make sure that it starts normally with the settings added to the boot loader. If the system does not start normally, return "/etc/fstab" to its original setup, and boot the system with the existing boot RAM disk.

```
# sync
# shutdown -r now
```

5. OS Installation

5.3. Linux

(11) Make sure that the PathManager device is used as the root device.

```
# mount
/dev/dda2 on / type ext3 (rw)
none on /proc type proc (rw)
none on /sys type sysfs (rw)
none on /dev/pts type devpts (rw,gid=5,mode=620)
usbfs on /proc/bus/usb type usbfs (rw)
/dev/dda1 on /boot type ext3 (rw)
none on /dev/shm type tmpfs (rw)
none on /proc/sys/fs/binfmt_misc type binfmt_misc (rw)
...
# cat /proc/swaps
Filename                Type            Size    Used    Priority
/dev/ddb1                partition      1048544 0        42
...
```

This completes installation (initial setup) in a SAN Boot environment.

If there are any application setup files other than the boot device using the disk array (/dev/sdX), follow the instructions in "[5.3.4.4 Migration to an Environment Using PathManager.](#)"

5. OS Installation

5.3. Linux

5.3.4.3. Installation in a SAN Boot Environment (Red Hat Enterprise Linux 6)

Execute the following process to use the system in a SAN Boot environment.

<Setup process for using a SCSI device (/dev/sdX) as a root device in a SAN Boot environment. (When the PathManager device (/dev/ddX) is not used as the root device.)>

- * A root device is a necessary device to boot the OS. ("/" or "/boot" or "swap" by default)

(1) Enable the PathManager SAN Boot settings.

```
# spsconfig -sanboot-cfg-add
Addition of San-boot configuration succeeded.
```

(2) Check the root devices. In the example below, /dev/sda and /dev/sdb are the root devices.

```
# cat /etc/fstab
UUID=111d442e-0979-4d9a-a099-97995cecdb4f /      ext4    defaults 1 1
UUID=4a8155ca-dc82-4d32-9806-be29d1607321 /boot  ext4    defaults 1 2
UUID=842d0fd5-cd45-4d9c-acc8-0d4f097e7639 swap   swap    defaults 0 0
tmpfs          /dev/shm          tmpfs    defaults      0 0
devpts         /dev/pts          devpts   gid=5,mode=620 0 0
sysfs         /sys              sysfs    defaults      0 0
proc          /proc             proc     defaults      0 0
...
# mount
/dev/sda2 on / type ext3 (rw)
none on /proc type proc (rw)
none on /sys type sysfs (rw)
none on /dev/pts type devpts (rw,gid=5,mode=620)
usbfs on /proc/bus/usb type usbfs (rw)
/dev/sda1 on /boot type ext3 (rw)
none on /dev/shm type tmpfs (rw)
none on /proc/sys/fs/binfmt_misc type binfmt_misc (rw)
...
# cat /proc/swaps
Filename                                Type              Size              Used              Priority
/dev/sdb1                                partition         1048544           0                  42
...
```

5. OS Installation

5.3. Linux

The preceding screen shows that `/dev/sda2` is mounted in `/`, `/dev/sda1` is mounted in `/boot`, and `/dev/sdb1` is used as the swap. From this, the correlations between UUID and `/dev/sd*` in `fstab` in the above example are as follows.

```
UUID=111d442e-0979-4d9a-a099-97995cecdb4f -> /dev/sda2
UUID=4a8155ca-dc82-4d32-9806-be29d1607321 -> /dev/sda1
UUID=842d0fd5-cd45-4d9c-acc8-0d4f097e7639 -> /dev/sdb1
```

- (3) Confirm the PathManager device that corresponds to the root device (`/dev/sd*`) checked in (2). The PathManager device that corresponds to the root device can be confirmed by adding the `-chk` option to the `spsconfig` command and executing it. In the following example, it can be confirmed that `/dev/sda` corresponds to `/dev/dda` and `/dev/sdb` corresponds to `/dev/ddb`.

```
# spsconfig -chk /dev/sda /dev/sdb
/dev/sda -> /dev/dda
/dev/sdb -> /dev/ddb
```

- (4) After backing up the current settings, change the root device described in `/etc/fstab` to the PathManager device confirmed in (3).

```
# cp -p /etc/fstab /etc/fstab.sps
# vi /etc/fstab
/dev/dda2          /                ext4    defaults    1 1
/dev/dda1          /boot            ext4    defaults    1 2
/dev/ddb1          swap             swap    defaults    0 0
tmpfs              /dev/shm         tmpfs   defaults    0 0
devpts             /dev/pts         devpts  gid=5,mode=620 0 0
sysfs              /sys             sysfs   defaults    0 0
proc               /proc            proc    defaults    0 0...
```

- (5) Generate a boot RAM disk that includes the PathManager driver. Executing the `mkinitrd` command as shown below will generate the boot RAM disk. In the example below, a boot RAM disk designated `/boot/initrdsps.img` is generated.

```
# mkinitrd /boot/initrdsps.img `uname -r`
```



Be sure to enclose `uname -r` in back quotes (```).

5. OS Installation

5.3. Linux

- (6) Add a setting to start with the boot RAM disk created in (8) to the boot loader settings. This is done using the following process:
1. Back up /boot/grub/grub.conf.
 2. Copy the current settings used for booting.
 3. Change the title to an arbitrary name.
 4. Change initrd to the file name of the boot RAM disk created in (5).
 5. Based on the results confirmed in (3), specify the PathManager device that corresponds to UUID for root.
 6. Change the value of the default line.

```
# cp -p /boot/grub/grub.conf /boot/grub/grub.conf.sps
# vi /boot/grub/grub.conf
...
#boot=/dev/sda
default=0
timeout=5
splashimage=(hd0,0)/grub/splash.xpm.gz
hiddenmenu

title Red Hat Enterprise Linux (2.6.32-131.0.15.el6.x86_64_spssan)
    root (hd0,0)
    kernel /vmlinuz-2.6.32-131.0.15.el6.x86_64 ro
    root=/dev/dda3 rd_NO_LUKS rd_NO_LVM rd_NO_MD rd_NO_DM
    LANG=ja_JP.UTF-8 KEYBOARDTYPE=pc KEYTABLE=jp106 crashkernel=auto
    rhgb quiet
    initrd /initramfs-sps.img
```

1. Back up

2. Copy the current settings used for booting

3. Change title
4. Change initrd
5. Change root

6. Change the value of the default line

```
-----
title Red Hat Enterprise Linux (2.6.32-131.0.15.el6.x86_64)
    root (hd0,0)
    kernel /vmlinuz-2.6.32-131.0.15.el6.x86_64 ro
    root=UUID=111d442e-0979-4d9a-a099-97995cecdb4f rd_NO_LUKS rd
    _NO_LVM rd_NO_MD rd_NO_DM LANG=ja_JP.UTF-8 KEYBOARDTYPE=pc
    KEYTABLE=jp106 crashkernel=auto rhgb quiet
    initrd /initramfs-2.6.32-131.0.15.el6.x86_64.img
-----
```

- (7) Reconnect any disconnected paths and make the paths redundant.
- (8) Reboot the system and make sure that it starts normally with the settings added to the boot loader. If the system does not start normally, return "/etc/fstab" to its original setup, and start the system with the existing boot RAM disk.

```
# sync
# shutdown -r now
```

5. OS Installation

5.3. Linux

(9) Make sure that the PathManager device is used as the root device.

```
# mount
/dev/dda2 on / type ext3 (rw)
none on /proc type proc (rw)
none on /sys type sysfs (rw)
none on /dev/pts type devpts (rw,gid=5,mode=620)
usbfs on /proc/bus/usb type usbfs (rw)
/dev/dda1 on /boot type ext3 (rw)
none on /dev/shm type tmpfs (rw)
none on /proc/sys/fs/binfmt_misc type binfmt_misc (rw)
...
# cat /proc/swaps
Filename                Type              Size      Used      Priority
/dev/ddb1                partition        1048544  0         42
...
```

This completes installation into a SAN Boot environment.

If there are any application setup files other than the boot device using the disk array (/dev/sdX), follow the instructions in "[5.3.4.4 Migration to an Environment Using PathManager.](#)"

5. OS Installation

5.3. Linux

5.3.4.4. Migration to an Environment Using PathManager

If there are any application setup files using the NEC Storage SCSI device (/dev/sdX), follow the instructions below.

< Example of procedures for making changes with /etc/fstab when the NEC Storage SCSI device /dev/sdX is used. >

Migrating a device mounted in /mnt/work to an environment using PathManager:

```
# vi /etc/fstab
...
/dev/sdf1          /mnt/work        ext3              defaults          0 0
...
```

(1) Use the **sg_scan** command to confirm that the target device is an NEC Storage SCSI device.

[NEC's D-Series Storage Disk Array]

If "NEC" and "iStorage XXXX" appear, it is an NEC Storage SCSI device. (the shaded areas)

```
# sg_scan -i /dev/sdf
/dev/sdf: scsi0 channel=0 id=0 lun=5 [em]
      NEC      iStorage 1000      1000 [rmb=0 cmdq=1 pqual=0 pdev=0x0]
```

[NEC's M-Series Storage Disk Array]

If "NEC" and "DISK ARRAY" appear, it is an NEC Storage SCSI device. (the shaded areas)

```
# sg_scan -i /dev/sdf
/dev/sdf: scsi0 channel=0 id=0 lun=5 [em]
      NEC      DISK ARRAY      1000 [rmb=0 cmdq=1 pqual=0 pdev=0x0]
```

[NEC's E-Series Storage Disk Array]

If "DGC" appears, it is an NEC Storage SCSI device. (the shaded area)

```
# sg_scan -i /dev/sdf
/dev/sdf: scsi0 channel=0 id=0 lun=5 [em]
      DGC      RAID 10      0223 [rmb=0 cmdq=1 pqual=0 pdev=0x0]
```

(2) Make sure /dev/ddX corresponds to /dev/sdf/.

Executing the spsconfig with the -chk option will confirm the corresponding PathManager device. In the following example, it can be confirmed that /dev/sdf corresponds to /dev/ddd.

```
# spsconfig -chk /dev/sdf
/dev/sdf -> /dev/ddd
```

5. OS Installation

5.3. Linux

- (3) After backing up the file to be changed (any file name can be used), /dev/sdf is changed to the device /dev/ddd confirmed in (2).

```
# cp -p /etc/fstab /etc/fstab.sps
# vi /etc/fstab
...
/dev/ddd1          /mnt/work         ext3              defaults          0 0
...
```

- (4) If the NEC Storage SCSI device is used by an application, make the same changes as in (3).
- (5) Reboot the system.

This completes the migration to an environment using PathManager.

5. OS Installation

5.3. Linux

5.3.4.5. kdump Setup

When Red Hat Enterprise Linux 6 is used, kdump that uses the PathManager device must be set up because kdump cannot be used with the default settings.

To use kdump, refer to "**Appendix F. How to Set Up kdump**" in the "**NEC Storage PathManager for Linux User's Manual**" and set it up.

5. OS Installation

5.3. Linux

5.3.5. Uninstalling

5.3.5.1. Removing kdump Settings

In order to remove kdump settings, refer to "Appendix F. How to Set Up kdump" in the "NEC Storage PathManager for Linux User's Manual."

5.3.5.2. Removing the SAN Boot Environment Settings (Red Hat Enterprise Linux 5)

If PathManager is installed in a SAN Boot environment, follow the steps below before uninstalling PathManager.

(1) Make sure that the root device is a PathManager device.

```
# mount
/dev/dda2 on / type ext3 (rw)
none on /proc type proc (rw)
none on /sys type sysfs (rw)
none on /dev/pts type devpts (rw,gid=5,mode=620)
usbfs on /proc/bus/usb type usbfs (rw)
/dev/dda1 on /boot type ext3 (rw)
none on /dev/shm type tmpfs (rw)
none on /proc/sys/fs/binfmt_misc type binfmt_misc (rw)
...

# cat /proc/swaps
Filename                Type            Size            Used            Priority
/dev/ddb1                partition      1048544         0               42
...
```

(2) Return the root device settings to their original settings.

```
# mv /etc/fstab.sps /etc/fstab
```

(3) Return the settings of the module to include in the boot RAM disk and PathManager options settings to their original settings. When uninstalling PathManager update, leaving /etc/modprobe.conf will allow you to skip some of the resetting process after PathManager updates.

```
# mv /etc/modprobe.conf.sps /etc/modprobe.conf
```

(4) Delete the boot RAM disk that includes the PathManager driver.

```
# rm /boot/initrd.sps.img
```

(5) Return the boot loader setup file to its original settings.

```
# mv /boot/grub/grub.conf.sps /boot/grub/grub.conf
```

5. OS Installation

5.3. Linux

(7) Restart the system with the original boot RAM disk.

```
# sync
# shutdown -r now
```

(8) Make sure that the root device is not the PathManager device.

```
# mount
/dev/sda2 on / type ext3 (rw)
none on /proc type proc (rw)
none on /sys type sysfs (rw)
none on /dev/pts type devpts (rw,gid=5,mode=620)
usbfs on /proc/bus/usb type usbfs (rw)
/dev/sda1 on /boot type ext3 (rw)
none on /dev/shm type tmpfs (rw)
none on /proc/sys/fs/binfmt_misc type binfmt_misc (rw)
...

# cat /proc/swaps
Filename                Type              Size              Used              Priority
/dev/sdb1                partition         1048544           0                  42
...
```

This completes removal of the SAN Boot environment settings.

Proceed to "[5.3.5.4 Uninstalling PathManager.](#)"

5. OS Installation

5.3. Linux

5.3.5.3. Removing the SAN Boot Environment Settings (Red Hat Enterprise Linux 6)

If PathManager is installed in a SAN Boot environment, follow the steps below before uninstalling PathManager.

- (1) Make sure that the root device is a PathManager device.

```
# mount
/dev/dda2 on / type ext3 (rw)
none on /proc type proc (rw)
none on /sys type sysfs (rw)
none on /dev/pts type devpts (rw,gid=5,mode=620)
usbfs on /proc/bus/usb type usbfs (rw)
/dev/dda1 on /boot type ext3 (rw)
none on /dev/shm type tmpfs (rw)
none on /proc/sys/fs/binfmt_misc type binfmt_misc (rw)
...

# cat /proc/swaps
Filename                Type      Size      Used      Priority
/dev/ddb1                partition 1048544   0         42
...
```

- (2) Return the root device settings to their original settings.

```
# mv /etc/fstab.sps /etc/fstab
```

- (3) Disable the PathManager SAN Boot settings.

```
# spsconfig -sanboot-cfg-del
```

- (4) Delete the boot RAM disk that includes the PathManager driver.

```
# rm /boot/initramfs-sps.img
```

- (5) Return the boot loader setup file to its original settings.

```
# mv /boot/grub/grub.conf.sps /boot/grub/grub.conf
```

This completes removing the SAN Boot environment settings. Proceed to ["5.3.5.4 Uninstalling PathManager."](#)

5. OS Installation

5.3. Linux

5.3.5.4. Uninstalling PathManager

PathManager can be uninstalled following the directions below.

Because the installation process depends on the kernel version, select process (1) or (2) depending on the version used. (The kernel version can be checked with "uname -r.")

- (1) Red Hat Enterprise Linux 5.4 (Kernel-2.6.18-164.el5) or later

The uninstaller can be used.

1. Go to /opt/nec/sps/installer.

```
# cd /opt/nec/sps/installer
#
```

2. Uninstall the RPM file. (Execute the underlined command.)

* If the --silent option is not specified, the OS will not be rebooted.

(The OS must be rebooted. Reboot manually.)

```
# sh uninstall.sh -silent
===== Precheck for SPS Installation / Uninstallation =====
Distribution      : RedHat
Architecture     : i686
Kernel Version   : Linux2.6
Kernel Details   : 2.6.18-164.el5
----- The following packages will be uninstalled. -----
driver           : sps-driver-E-4.3.1-2.6.18.164.el5
utils            : sps-utils-4.3.0-0
=====
patching file rc.sysinit
sps Uninstall Completed.....
#
Broadcast message from root (Thu Feb 25 14:38:01 2010):
The system is going DOWN for reboot in 1 minute!
#
```

3. If the uninstaller is completed successfully, the message "sps Uninstall Completed" is output (shaded line). If this message is not output, the uninstall failed. Follow the instructions in "**Appendix D. Error Messages from Installer**" in the "PathManager for Linux Installation Guide."
4. If the uninstaller is completed successfully, the system will reboot in one minute. Make sure that the OS operates normally.

5. OS Installation

5.3. Linux

5. After the OS is rebooted, make sure that the root device is not the PathManager device.

```
# mount
/dev/sda2 on / type ext3 (rw)
none on /proc type proc (rw)
none on /sys type sysfs (rw)
none on /dev/pts type devpts (rw,gid=5,mode=620)
usbfs on /proc/bus/usb type usbfs (rw)
/dev/sda1 on /boot type ext3 (rw)
none on /dev/shm type tmpfs (rw)
none on /proc/sys/fs/binfmt_misc type binfmt_misc (rw)
...
# cat /proc/swaps
Filename                Type      Size      Used      Priority
/dev/sdb1                partition 1048544   0         42
...
```

This completes uninstalling PathManager in RHEL 5.4 or later.

5. OS Installation

5.3. Linux

(2) Systems before Red Hat Enterprise Linux 5.4 (Kernel-2.6.18-164.el5):
Uninstall is executed manually.

1. Use the following command to make sure that PathManager is used in the current environment.

- If the kernel version is 2.6.18-128.el5

```
# rpm -qa | grep sps
sps-utils-4.2.1-0
sps-driver-E-4.2.1-2.6.18.128.el5
```



- For systems earlier than Red Hat Enterprise Linux 5.3 (Kernel 2.6.18-128.el5), this is the package containing both sps-utils and sps-driver.
Example: sps-E-4.1.3-2.6.18.92.el5.i686.rpm

2. Delete the patch file applied to the OS boot script (/etc/rc.d/rc.sysinit) and iSCSI initiator startup script in "3. Set up automatic booting" of (2) of ["5.3.4.1 PathManager Installation."](#)
Execute the following steps.

```
# cd /etc/rc.d

<FC connected>
# patch -R -p0 < /opt/nec/sps/patch/rc.sysinit.rhel5.diff

<iSCSI connected>
# patch -R -p0 < /opt/nec/sps/patch/iscsi.rhel5.diff
```



The message "Unreversed patch detected! Ignore -R? [n]" may be displayed after executing the patch command. Reply "n" in that case.
When "Apply anyway? [n]" appears, reply "y."
If an error message is displayed, deleting the patch file has failed.
If deleting the patch file fails, edit /etc/rc.d/rc.sysinit and /etc/rc.d/init.d/iscsi to delete the corresponding sections. (Delete the lines that start with "+.")

5. OS Installation

5.3. Linux

3. Specify the PathManager package name checked in 1., then uninstall the PathManager with the following command.

- If the kernel version is 2.6.18-128.el5 -

```
# rpm -e sps-driver-?-4.2.1-2.6.18.128.el5  
# rpm -e sps-utils-4.2.1-0
```

4. Execute the following command and make sure that no error is displayed.

```
# depmod -a `uname -r`
```

5. Reboot the system and make sure that it starts normally.

```
# sync  
# shutdown -r now
```

6. If there is a setup file (/etc/sps.conf), delete it.

```
# rm /etc/sps.conf
```

This completes the uninstall process.

5. OS Installation

5.3. Linux

5.3.6. Updating

- PathManager is updated by uninstalling PathManager, then reinstalling it. The following describes how to update PathManager when a kernel is updated.

- (1) Uninstall PathManager. See "[5.3.5 Uninstalling](#)" for the uninstalling procedure. If there are no hardware changes and the current settings are to be used after updating, there is no need to execute 6 in "[5.3.5.4 Uninstalling PathManager](#)." The current settings can be used by leaving the setup file.



*1: After PathManager is uninstalled, /dev/ddX cannot be used. Therefore, stop any applications that use /dev/ddX before updating PathManager. Also, do not access /dev/ddX while updating.

- Update the kernel.



*2: If ExpressCluster is used, refer to "**Appendix A. Introduction to the ExpressCluster Environment**" in the installation guide.

- Boot the OS with the updated kernel.
- (2) Install PathManager. See "[5.3.4 Installation](#)" for instructions.

This completes the updating process.

5. OS Installation

5.3. Linux

5.3.7. Preparing for Operation

- After installing PathManager and rebooting the system, PathManager will automatically recognize the target disks and paths and operation will start. The following describes how to make sure that PathManager operates normally.
- (1) Make sure that the installed PathManager corresponds to the kernel in use. Make sure that the kernel version (A) displayed by "uname -r" and the kernel version (B) displayed by "rpm -qi" are the same.

```

# uname -r          (Check the kernel version)
2.6.X-XX
# rpm -qa | grep sps
sps-xxx-yyyy
# rpm -qi sps-xxx-yyyy
Name           : sps-X-XXX           Relocations: (not relocatable)
Version        : 4.X.X             Vendor: NEC Corporation
Release       : 2.6.XX.XX          Build Date:  YYYY/MM/DD HH:MM:SS
Install date:  YYYY/MM/DD HH:MM:SS Build Host:  nec.co.jp
Group         : Utilities/System    Source RPM:  sps-X-XX.X.src.rpm
Size          : XXXXXX              License:    XXXXXX
Signature     : (none)
Packager      : NEC Corporation
Summary       : SCSI multi-path driver and utilities for NEC iStorage
Description   :
-----
----
This package contains a driver, daemon and some utilities.
The driver (dd_mod,sps_mod) provides the redundant SCSI-path for
NEC iStorage Disk Array System.
The daemon (dd_daemon) supervises the driver.
And, some utilities work for the maintenance.
This Driver works on Red Hat Enterprise Linux X [Kernel:2.6.X-XX].
-----
----
#

```

Kernel version (A) in use

Kernel version (B) that can operate PathManager

5. OS Installation

5.3. Linux

- (2) Check `/proc/scsi/sps/ddX` (X is the LUN number created in NEC Storage unit; a, b, c, etc.). Make sure that there are "path-info:" lines for all the multiplexing for each device. Also, if the "device-info:" status column are all "NML," the paths are multiplexed normally. If nothing is displayed, NEC Storage unit is not recognized by all the paths. Check the server and NEC Storage unit connection, FC driver status, NEC Storage unit cross call settings, etc.

```
# cat /proc/scsi/sps/dda
device:/dev/dda
disk-info:NEC      ,iStorage 2000      ,0000000931000013,00000
device-info:Host:scsi:2 Channel:0 Id:0 Lun:0 Status:NML
LoadBalance:S
path-info:0 Host:scsi:0 Channel:0 Id:0 Lun:0 Priority:1 Watch:Enable
Status:ACT
path-info:1 Host:scsi:1 Channel:0 Id:0 Lun:0 Priority:2 Watch:Enable
Status:HOT
```

5. OS Installation

5.3. Linux

- (3) Make sure that the path crawl daemon is active. If so, the following message is displayed.

```
# /etc/rc.d/init.d/dd_daemon status
dd_daemon (pid XXX) is running ...
```

This completes preparations for operation.

5.3.8. Detailed Information

- For detailed information not contained in this manual, refer to "[NEC Storage PathManager for Linux User's Manual](#)" (Express5800_100/doc/IS202E.pdf) in the installation CD-ROM.

5.3.9. Installing Applications

- Refer to the following websites to install the various applications.
- ESMPRO/ServerAgent
This application provides server operation monitoring, preventive maintenance, and error monitoring functions.
Use this application with the ESMPRO/ServerManager that provides manager functions.
Refer to the following URL for ESMPRO/ServerAgent installation instructions:
<https://www.express.nec.co.jp/linux/dload/esmpro/esm4.html>
* Use the version that is compatible with the installed OS.

5. OS Installation

5.4. VMware ESX/ESXi

- Refer to the following website for details on VMware ESX/ESXi:
<http://www.vmware.com/>
 - Please contact NEC sales or dealers for technical literature on VMware vSphere5.

5.4.1. Precautions for Configuring SAN Boot

- Be aware of the following points when making a VMware ESX/ESXi SAN Boot configuration.
 Check the "**SAN Boot Compatibility Table**" for the recommended hardware and software.

NEC Express5800	R120d-2M, R120d-1M, R120d-2E, R120d-1E
Network	Separating the NIC used by vMotion service console and the NIC used by the virtual machine is recommended.
FC path redundancy	If multiple paths are configured in the ESXi environment, the ESXi functions will allow HBA failover and SP (Storage Port) failover, but the NEC Storage PathManager will manage and control redundant paths tuned for NEC storage products. PathManager can be used with VMware vSphere5 Enterprise Edition or higher, and the supported target disk array is the M series.

<Precautions (Restrictions)>

- If VMware ESX/ESXi is made into a SAN Boot configuration, the following functions are not available.
 - Autonomous restoration to a spare VMware ESX (host OS) server through SigmaSystemCenter
 - Backup and restore of VMware ESX (host OS) through DeploymentManager

5.4.2. Precautions for Building SAN Boot

- Install VMware ESX/ESXi after executing "[4.2.1 FC Controller BIOS Enable Setting](#)" in this manual.
- In order to install NEC Storage PathManager, install VMware ESXi5 first, then install PathManager according to the Installation Guide that comes with it.

6. Confirming Operation and Setting Up Redundant Paths

- If the FC cable has not been reconnected in "5. OS Installation," then reconnect the FC cable and set it up as a redundant path.

6.1. Reconnecting the FC Cable

- Reconnect the FC cable disconnected in "[4.4 Making Single Path FC Connections](#)" to its original FC controller.

If the redundant path is not registered in the FC BIOS, register it.

Follow the example in "[4.3 FC Controller BIOS Settings](#)" to register the Port 2 and higher redundant paths as the boot device.

6.2. Checking FC Path Redundancy

➤ **Window OS**

- In the Windows OS, FC path redundancy can be checked by executing the control command "spsadmin /lun."

Refer to "[3.1.2 Path List Display](#)" in the "**NEC Storage PathManager User's Manual (Windows version)**" for details.

➤ **Linux OS**

- In the Linux OS, FC path redundancy can be checked by linking Port 2 and higher of the FC controller. Then execute the following after restarting the OS.

```
"cat /proc/scsi/sps/ddX"
```

Note: Specify a character that corresponds to the environment in place of "X."

See "[5.3.10 Preparing for Operation](#)" in this manual for details.

➤ **VMware ESX/ESXi**

- The steps in this section are not necessary if VMware ESX/ESXi is installed and the steps in "[3.1.5 Linking the LD Sets and FC Controllers](#)" are not executed.

- If Storage PathManager is installed, then VMware FC path redundancy can be checked through the VMware vSphere Client.
Refer to "[4.1.2 Checking Operation Status](#)" in the "**NEC Storage PathManager User's Manual (VMware version)**" for details.

7. Additional Application Settings

7.1. DDR (NEC M-series Storage)

- By NEC M series storage data replication function (DDR), it is possible to make backup and restore Windows (including Hyper-V), Linux and VMware ESX/ESXi OS images, Hyper-V and VMware virtual machine images, and the data areas of physical and virtual machines.
- User can make backup and restore with the data replication function by the replication control screen of StorageManager on the management server, or by using the ControlCommand on the management server or on the backup server. Also user can make backup and restore by iSMCLI on the disk array..
- In order to use the data replication function, it is necessary to unlock DynamicDataReplication license. For the M series, refer to "**11.4 License Unlock**" of the "**NEC Storage Software Configuration Setting Tool User's Manual (GUI) for the M Series**" for details on unlocking the license.
- In order to use ControlCommand, user needs to install Storage ControlCommand in the environment used. Refer to the "**Installation Guide (INSTALL.PDF)**" on the "**NEC Storage ControlCommand CD-R**" for the installation process.
- In order to use ControlCommand on the management server, user needs operations combined with StorageManager. Refer to "**4.2.2 Using ReplicationControl with iSM**" in the "**NEC Storage Software Data Replication User's Manual (Function Guide)**" and "**Chapter 8. Operation Setting**" in the "**NEC Storage Software ControlCommand Command Reference.**"

7. Additional Application Setup

7.1. DDR (NEC M-series Storage)

- When user executes iSMCLI provided by the Storage M series, it is necessary to execute commands on the disk array. User must log in the disk array by ssh/telnet/rsh protocol, or execute commands remotely. Refer to "**Appendix D. Disk Backup and Data Restoration with Use of Data Replication Function**" in "**NEC Storage Software NEC Storage Manager Command Reference**" for backup and restore procedures by iSMCLI.
- All references to "Windows Server 2008" in this chapter are also applicable to revisions after Windows Server 2008 (R2, etc.) unless noted.

7. Additional Application Setup

7.1. DDR (NEC M-series Storage)

7.1.1. Backup and Restore Windows Server 2008 Hyper-V with the DDR Function

- This section describes the cautions and restrictions when user executes the M-series Storage data replication function to make backup and restore OS images of Windows Server 2008 with Hyper-V installed, virtual machine images (VHD) in Hyper-V, and virtual machine data areas (pass-through devices).
- Be sure to also refer to "[7.1.4. Cautions for Backup and Restore Windows Server OS Images with the DDR Function](#)" in this manual.

(1) Configuration

The backup and restore procedures are based on the following configuration..

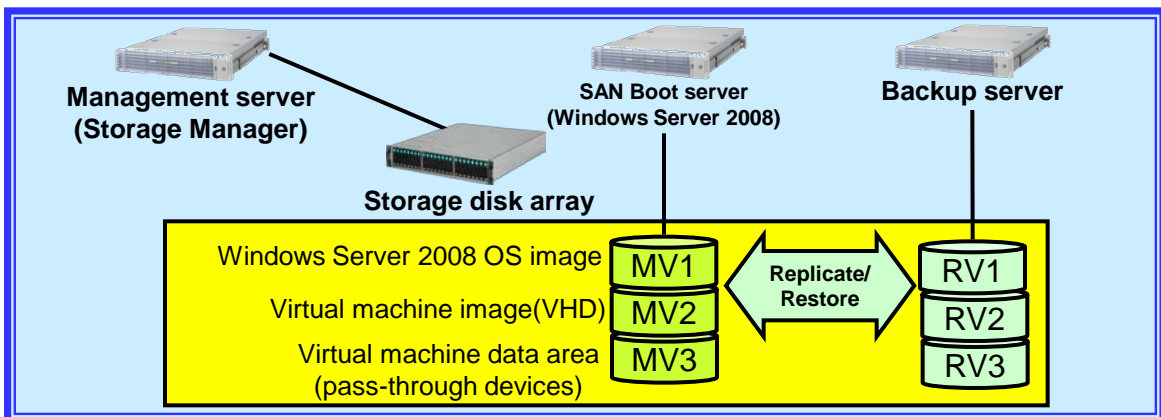

(2) Logical disk format

1. Be sure to set "WG" as the usage format for Windows Server OS image logical disk that has Hyper-V installed in it.
2. Set the usage format of the logical disks accessed by Hyper-V (virtual machine images in Hyper-V (VHD)) and virtual machine data areas (pass-through devices) according to the actual partition style as shown below:
 - ➔ For use as an MBR format disk: "WN"
 - ➔ For use as a GPT format disk: "WG"

(3) Backup and restore of Windows Server 2008 OS images:

The following instructions show how to use the NEC M-series Storage data replication function to make backup and restore OS images of Windows Server 2008 with Hyper-V installed.

7. Additional Application Setup

7.1. DDR (NEC M-series Storage)

➤ Backup Procedure

(1) Execute replication (Management server):

Execute the replication process from the StorageManager and synchronize MV and RV for the following:

- ➔ Windows Server 2008 OS image
- ➔ Virtual machine image in Hyper-V
- ➔ Virtual machine data area

(2) Shut down Windows Server 2008 (Windows Server 2008):

Shut down the Windows Server 2008 that uses the MV to make backed up.

(3) Execute separation (Management server):

Execute the separation process from the StorageManager and separate MV and RV for the following:

- ➔ Windows Server 2008 OS image
- ➔ Virtual machine image in Hyper-V
- ➔ Virtual machine data area

(4) Restart Windows Server 2008 (Windows Server 2008):

Restart Windows Server 2008 shut down in (2), then restart operations.

➤ Restore Procedure

(1) Shut down Windows Server 2008 (Windows Server 2008):

Shut down the Windows Server 2008 that uses the MV to be restored.

(2) Reconstruct MV (Management server):

If it is necessary to reconstruct MV because of a physical error, execute the following procedure:

1. Set the MV AccessControl (Access prohibited).
2. Reconstruct the LDs.
3. Execute pair reset.
4. Set the MV AccessControl (Access allowed).

(3) Execute restore (Management server).

Execute the restore process from the StorageManager, then restore the RV data in MV.

(4) Restart Windows Server 2008 (Windows Server 2008).

Restart Windows Server 2008 that was shut down in (1), then restart operations.

7. Additional Application Setup

7.1. DDR (NEC M-series Storage)

7.1.2. Backup and Restore Windows Server 2008 R2 Hyper-V with the DDR Function

- This section describes the cautions and restrictions when user executes M-series Storage data replication function to back up and restore virtual machine data areas (pass-through devices) from Windows Server 2008 R2 virtual machines with Hyper-V installed.
- Be sure to also refer to "[7.1.4. Cautions for Backup and Restore Windows Server OS Images with the DDR Function](#)" in this manual.
 - This function is supported for Hyper-V in Windows Server 2008 R2 or later, not for Hyper-V in Windows Server 2008.

(1) Configuration

The backup and restore procedures are based on the following configuration
A virtual machine must have ControlCommand installed in order to use the data replication function from it.

In an M series disk array, iSMCLI on the disk array can be used to execute data replication. In this case, ControlCommand does not have to be installed in the virtual machine. But ssh/telnet/rsh protocol must be used from a virtual machine to log into the Storage M series disk array, otherwise the environment that allows remote iSMCLI to execute commands is necessary.

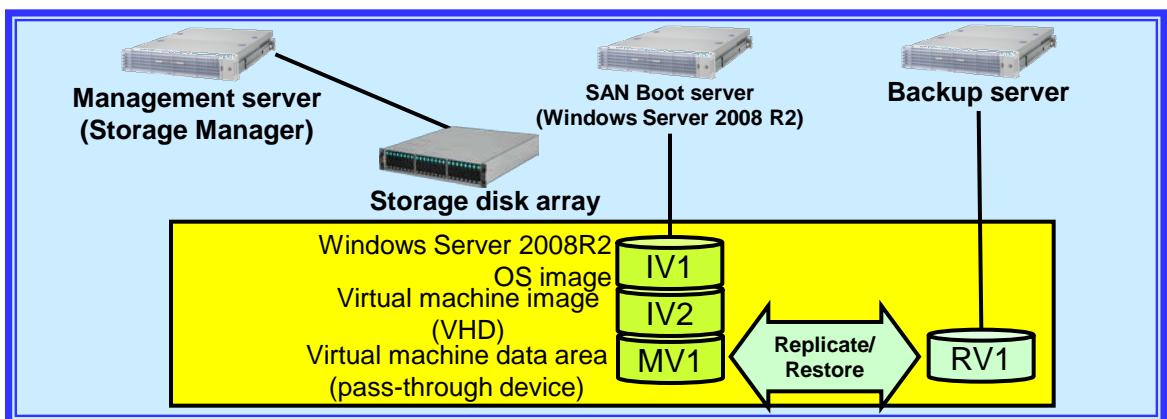

7. Additional Application Setup

7.1. DDR (NEC M-series Storage)

- (2) Backup and restore data areas from virtual machines:

The following instructions show how to use the M series Storage data replication function to make backup and restore the data areas (pass-through disks) from virtual machines of Windows Server 2008 R2 with Hyper-V installed.

- Preparation

- (1) Execute iSMpassthrough_enabler (Windows Server 2008 R2):

In order to use ControlCommand to replicate data on a virtual machine, the virtual machine must recognize the data area as an M-series Storage disk array.

The iSMpassthrough_enabler command must be executed one time in the Windows Server 2008 R2 host OS after the virtual machine is created. (Another command is necessary if new virtual machine is added after the operation starts.)

The iSMpassthrough_enabler command is included in the ControlCommand package.

This step is not necessary if data is replicated with iSMCLI provided by NEC M-series Storage.

- Backup Procedure

By executing the iSMpassthrough_enabler command, user can use ControlCommand in the virtual machine to back up the data area in the same manner as DDR operations on a regular physical server.

Refer to "**3.1.1. Example of Backup Operation**" in the "**NEC Storage Software Data Replication User's Manual (Installation and Operation Guide for Windows)**."

Refer to "**Appendix D: Disk Backup and Data Restore with Use of Data Replication Function**" in the "**NEC Storage Software NEC Storage Manager Command Reference**" when backing up data areas with iSMCLI provided by NEC M-series Storage

7. Additional Application Setup

7.1. DDR (NEC M-series Storage)

- Restore Procedure

By executing the iSMpassthrough_enabler command, user can use ControlCommand in the virtual machine to restore the data area in the same manner as DDR operations on a regular physical server.

Refer to "**3.1.2. Example of Restoring Master Volume Data**" in "**NEC Storage Software Data Replication User's Manual (Installation and Operation Guide for Windows)**" for restoration instructions.

Refer to "**Appendix D: Disk Backup and Data Restore with Use of Data Replication Function**" in the "**NEC Storage Software NEC Storage Manager Command Reference**" when restoring data areas with iSMCLI provided by NEC M-series Storage.

7. Additional Application Setup

7.1. DDR (NEC M-series Storage)

7.1.3. Backup and Restore VMware ESX/ESXi with the DDR Function

- This section describes the cautions and restrictions when user executes the NEC M-series Storage data replication function to back up and restore OS images of VMware ESX/ESXi, virtual machine images (VMFS) on VMware ESX/ESXi, and virtual machine data areas (RDM (Raw Device Mapping)).

(1) Configuration

The backup and restore procedures are based on the following configuration.

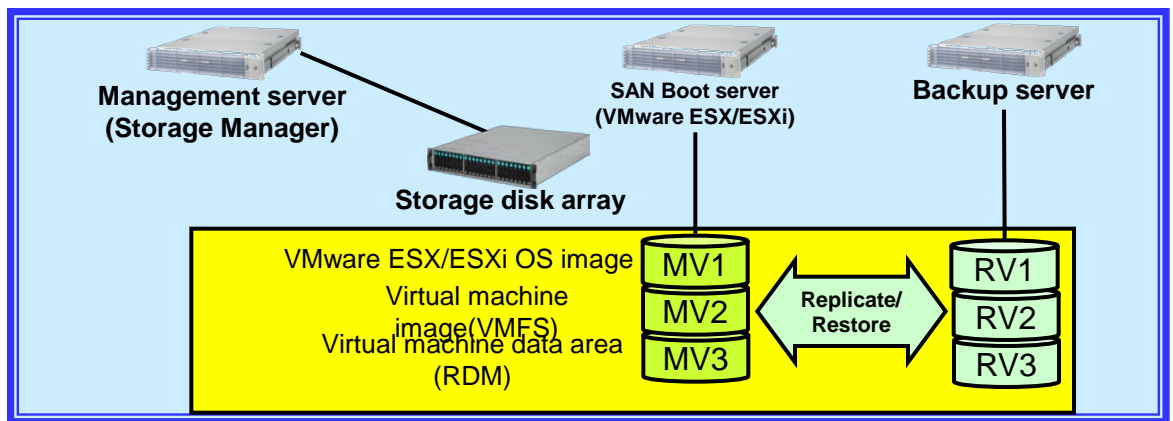

(2) Logical disk format

- Be sure to set "LX" as the usage format for the logical disk in which the VMware ESX/ESXi OS image is installed and the logical disk in which the VMware ESX/ESXi virtual machine image (VMFS) is stored. Set the usage format of the data area (RDM (Raw Device Mapping)) logical disk of the virtual machine according to the actual partition style as shown in the below examples:

For use as a Linux disk: "LX"

For use as a Windows MBR format disk: "WN"

For use as a Windows GPT format disk: "WG"

7. Additional Application Setup

7.1. DDR (NEC M-series Storage)

- (3) Backup and restore VMware ESX/ESXi OS images:
The following instructions show how to make backup and restore VMware ESX/ESXi OS images with the M-series Storage data replication function.
- Backup Procedure
 1. Execute replication (Management server).
Execute the replication process from the StorageManager and synchronize MV and RV for the following:
 - ➔ VMware ESX/ESXi OS image
 - ➔ Virtual machine image in VMware ESX/ESXi
 - ➔ Virtual machine data area
 2. Shut down VMware ESX/ESXi (VMware ESX/ESXi).
➔ Shut down the VMware ESX/ESXi system which uses the MV to be backed up.
 3. Execute separation (Management server).
Execute the separation process from the StorageManager and separate MV and RV for the following:
 - ➔ VMware ESX/ESXi OS image
 - ➔ Virtual machine image in VMware ESX/ESXi
 - ➔ Virtual machine data area
 4. Restart VMware ESX/ESXi (VMware ESX/ESXi).
Restart VMware ESX/ESXi shut down in 2., then restart operations.
 - Restore procedure
 1. Shut down VMware ESX/ESXi (VMware ESX/ESXi).
Shut down the VMware ESX/ESXi system that uses the MV to be restored.
 2. Reconstruct MV (Management server).
If it is necessary to reconstruct MV because of a physical error, execute the following procedure
 - 1) Set the MV AccessControl (Access prohibited).
 - 2) Reconstruct the LDs.
 - 3) Execute pair resetting.
 - 4) Set the MV AccessControl (Access allowed).
 3. Execute restore (Management server).
Execute the restore process from the StorageManager, then restore the RV data in MV.

7. Additional Application Setup

7.1. DDR (NEC M-series Storage)

4. Restart VMware ESX/ESXi (VMware ESX/ESXi).

Restart the virtual machine that was shut down through the vCenter Server
Restart VMware ESX/ESXi shut down in 1. ., then restart operations.

- (4) Backup and restore virtual machine images (VMFS):

The following instructions show how to back up and restore virtual machine images by NEC M-series Storage data replication function.

- Backup Procedure

1. Execute replication (Management server).

Execute the replication process from the StorageManager and synchronize MV and RV for the virtual machine image and RDM.

2. Shut down the virtual machine (VMware ESX/ESXi).

From the vCenter Server (vSphere client) or service console, shut down all virtual machines that use the MV to be backed up.

3. Execute separation (Management server).

Execute the separation process from the StorageManager and separate MV and RV for the virtual machine image and RDM.

4. Restart the virtual machine (VMware ESX/ESXi).

Restart the virtual machine that was shut down through the vCenter Server (vSphere client) or the service console, then restart operations.

- Restore Procedure

1. Shut down and delete the virtual machine (VMware ESX/ESXi).

From the vCenter Server (vSphere client) or service console, shut down all virtual machines that use the MV to be restored, then delete the virtual machines (delete inventory).

2. Reconstruct MV (Management server).

If it is necessary to reconstruct MV because of a physical error, execute the following procedure:

- 1) Set the MV AccessControl (Access prohibited).

- 2) Reconstruct the LDs.

- 3) Execute pair reset.

- 4) Set the MV AccessControl (Access allowed).

3. Execute restore (Management server).

Execute the restore process from the StorageManager, then restore the RV data in MV.

7. Additional Application Setup

7.1. DDR (NEC M-series Storage)

4. Recognize the recovered VMFS (VMware ESX/ESXi).
From the vCenter Server (vSphere client) or service console, rescan with the "Storage adapter."
5. Restart the virtual machine (VMware ESX/ESXi).
Restart the virtual machine shut down in 1., then restart operations.

7.1.4. Cautions for Backup and Restore Windows Server OS Images with the DDR Function

- Please note the following when user executes NEC M-series Storage DDR (data replication) function to back up a Windows Server OS image.

(1) Logical disk format

When the logical disk is "WN" format, the Windows disk signatures will differ for the master volume (MV) and replication volume (RV). Then, when a logical disk is restored from RV, the OS will not be able to start.

Therefore, the usage format for the logical disk that stores the Windows OS must be set to "WG" regardless of the actual disk format (MBR, GPT) used by the Windows server.

* When ControlCommand from a management server is used to back up an OS image in NEC M-series Storage that is FC connected, it is necessary to add "GPTDISK=USE" to the [CHECK] section of the operation option setup file (%SystemRoot%\¥ismvol¥iSMrpl.ini) in order to manipulate a logical disk in the "WG" usage format.

(2) BitLocker drive encoding

When handling an OS image (MV, RV backed up from MV, or MV restored from RV) that has been encoded with BitLocker, the operation will differ as shown below depending on whether the server that executed the encoding is used or another server is used.

- Using the server that executed encoding

[OS startup]	➔ Possible
[Enable/Disable BitLocker encoding]	➔ Possible
[Unlocking BitLocker encoding]	➔ Possible

7. Additional Application Setup

7.1. DDR (NEC M-series Storage)

- (3) Backup and restore VMware ESX/ESXi OS images:
The following instructions show how to back up and restore VMware ESX/ESXi OS images with M-series Storage data replication function.
- Backup Procedure
 1. Execute replication (Management server).
Execute the replication process from the StorageManager and synchronize MV and RV for the following:
 - ➔ VMware ESX/ESXi OS image
 - ➔ Virtual machine image in VMware ESX/ESXi
 - ➔ Virtual machine data area
 2. Shut down VMware ESX/ESXi (VMware ESX/ESXi).
➔ Shut down the VMware ESX/ESXi system which uses the MV to be backed up.
 3. Execute separation (Management server).
Execute the separation process from the StorageManager and separate MV and RV for the following:
 - ➔ VMware ESX/ESXi OS image
 - ➔ Virtual machine image in VMware ESX/ESXi
 - ➔ Virtual machine data area
 4. Restart VMware ESX/ESXi (VMware ESX/ESXi).
Restart VMware ESX/ESXi shut down in 2., then restart operations.
 - Restore procedure
 1. Shut down VMware ESX/ESXi (VMware ESX/ESXi).
Shut down the VMware ESX/ESXi system that uses the MV to be restored.
 2. Reconstruct MV (Management server).
If it is needed to reconstruct MV because of a physical error, execute the following procedure
 - 1) Set the MV AccessControl (Access prohibited).
 - 2) Reconstruct the LDs.
 - 3) Execute pair resetting.
 - 4) Set the MV AccessControl (Access allowed).
 3. Execute restore (Management server).
Execute the restore process from the StorageManager, then restore the RV data in MV.

7. Additional Application Setup

7.1. DDR (NEC M-series Storage)

4. Restart VMware ESX/ESXi (VMware ESX/ESXi).

Restart the virtual machine that was shut down through the vCenter Server
Restart VMware ESX/ESXi shut down in 1. ., then restart operations.

- (4) Backup and restore virtual machine images (VMFS):

The following instructions show how to back up and restore virtual machine images by NEC M-series Storage data replication function.

- Backup Procedure

1. Execute replication (Management server).

Execute the replication process from the StorageManager and synchronize MV and RV for the virtual machine image and RDM.

2. Shut down the virtual machine (VMware ESX/ESXi).

From the vCenter Server (vSphere client) or service console, shut down all virtual machines that use the MV to be backed up.

3. Execute separation (Management server).

Execute the separation process from the StorageManager and separate MV and RV for the virtual machine image and RDM.

4. Restart the virtual machine (VMware ESX/ESXi).

Restart the virtual machine that was shut down through vCenter Server (vSphere client) or the service console, then restart operations.

- Restore Procedure

1. Shut down and delete the virtual machine (VMware ESX/ESXi).

From the vCenter Server (vSphere client) or service console, shut down all virtual machines that use the MV to be restored, then delete the virtual machines (delete inventory).

2. Reconstruct MV (Management server).

If it needed to reconstruct MV because of a physical error, execute the following procedure:

- 1) Set the MV AccessControl (Access prohibited).

- 2) Reconstruct the LDs.

- 3) Execute pair reset.

- 4) Set the MV AccessControl (Access allowed).

3. Execute restore (Management server).

Execute the restore process from the StorageManager, then restore the RV data in MV.

7. Additional Application Setup

7.1. DDR (NEC M-series Storage)

- Other servers
 - [OS startup]
 - ➔ need recovery key for startup.
 - ➔ The following actions are executed after starting with a recovery key.
 - [Enable/Disable BitLocker encoding]
 - ➔ Encoding can be disabled, but cannot be re-enabled after disabling.
 - [Unlocking BitLocker encoding]
 - ➔ Possible

➤ Applying a hotfix when using ControlCommand in Windows Server 2008

It is possible that the problems in Windows Server 2008 cause unmount (iSMrc_umount command) to fail.

Microsoft has reported this problem as a product error and hotfix information has been released.

When using a server with Windows Server 2008 installed, refer to the below website and apply the appropriate hotfix to the server.

(If Windows Server 2008 SP2 has been applied, the above program is not necessary.)

[Hotfix download URL]

<http://support.microsoft.com/kb/952790/>

* Microsoft Support Technical Bulletin – 952790

8. Precautions and Restrictions

8.1. Server

8.1.1. Mixing FC Controller Models

- Different FC controller models cannot be installed on a single server. (Only the same model FC controllers can be mounted on a single server.)

8.1.2. Multiple Path Compatibility

- Binding multiple servers to the same logical system disk is not allowed. (Multiple servers cannot share the same OS system disk.)

8.1.3. BIOS Settings for Installing Windows Server 2008

- Before installation, go to the Boot Order setup screen in the server device system BIOS, check the FC controller ports, and make sure that they are bootable.

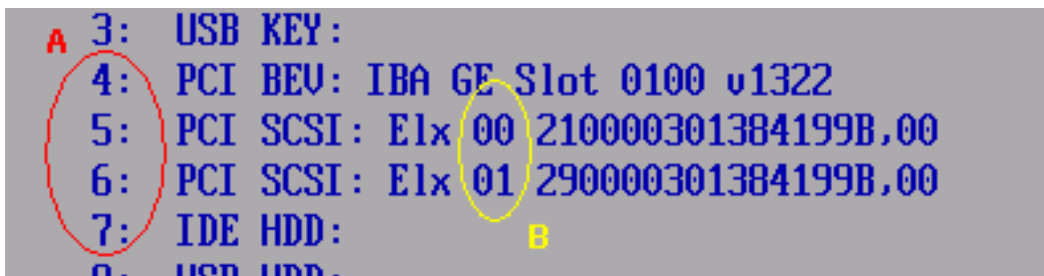

- The numbers circled in "A" in the illustration show the boot priority. If the FC controller ports are not specified here, they cannot be used to boot the system. The numbers circled in "B" indicate the FC controller port numbers.
- Windows Server 2008 installation may fail if the FC controller ports are not bootable.
- Both of the following settings must be made to enable booting from an FC controller:
 - LDs must be assigned to the LD set linked to the FC controller port.
 - The boot BIOS setting must be enabled for the FC controller port linked to the LD set with assigned LDs.
- See "[4.3 FC Controller BIOS Settings](#)" for details on setting the FC controller boot BIOS.

8. Precautions and Restrictions

8.1. Server

8.1.4. BIOS updates

- R120d-2M, R120d-1M, R120d-2E, and R120d-1E do not require BIOS updates, but updating them to the latest public version is recommended.
 - Refer to the BIOS download page of each device and the "Readme.txt" file that comes with the downloaded data for the updating instructions.
- See the following website to check for any available BIOS updates.
- R120d-2M, R120d-1M, R120d-2E, R120d-1E
- NEC Express5800 Series Product Information
- ➔ <http://www.58support.nec.co.jp/global/download/index.html>

8.1.5. Restrictions for Internal option in server

- Under SAN Boot environment, mounting HDD/SSDs and RAID controllers on SAN Boot servers are not recommended.

8.1.6. System BIOS Setup

- "SATA AHCI" and "SATA RAID" parameters on server's system BIOS must change to "disabled".

8. Precautions and Restrictions

8.2. Storage

8.2.1. Connecting Multiple Storage Devices

- Connections cannot be made to access multiple storage devices through the FC switches under the FC controller ports that implement FC SAN Boot. Only the ports that are not used for FC SAN Boot should be selected to access multiple storage devices.
- While one of the N8190-154 ports is used for FC SAN Boot, the other ports can access multiple storage.

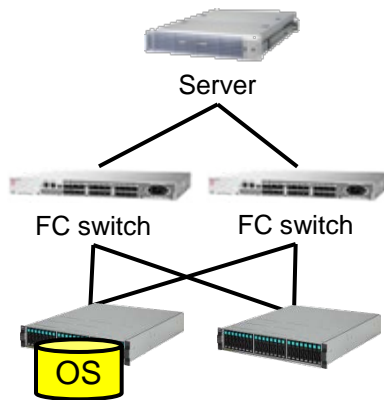

The storage device with the OS installed and another storage device are connected to the same port of the FC controller.

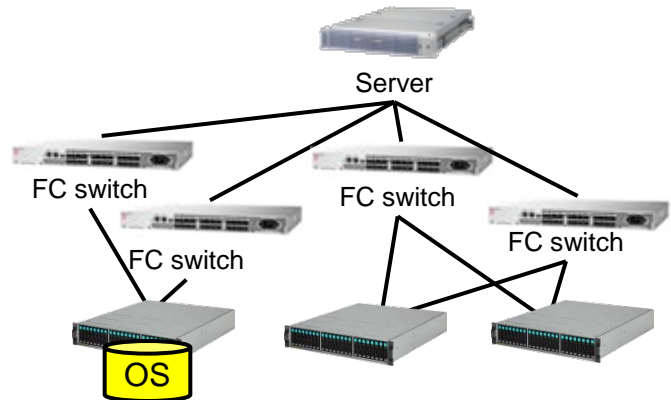

The storage device with the OS installed and another storage devices are not connected to the same port of the FC controller.

8.2.2. Storage Performance and Number of OSs Installed

- AS for the numbers of OSs used per storage device, consider the estimation based on required performance with responsibility of system management department.

8. Precautions and Restrictions

8.3. OS

8.3.1. Number of OS Licenses Used

- Windows Server 2008/Windows Server 2008 R2
 - Number of Windows Server 2008 and Windows Server 2008 R2 licenses used for FC SAN Boot will depend on the number of instances (number of servers).

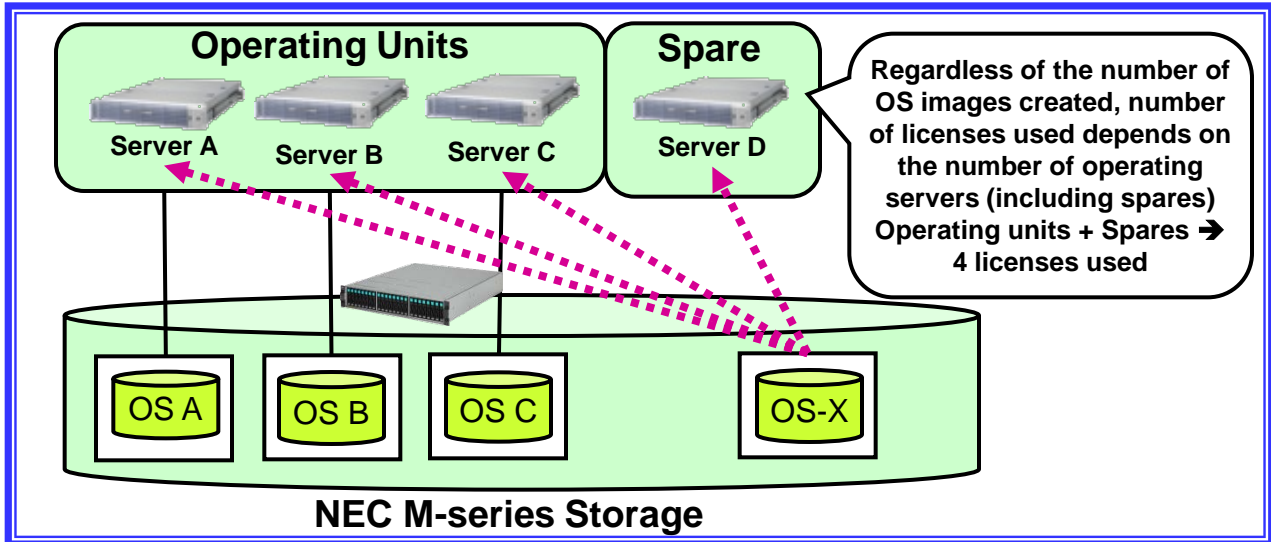

- In a configuration such as that shown above in which OS-X is automatically used when there is a problem, the number of licenses used are the same as the number of servers used (including spares); i.e., four licenses in this case.
- Refer to the Windows Server 2008 and/or Windows Server 2008 R2 software end user's license agreement for a definition of instances.

8. Precautions and Restrictions

8.3. OS

➤ Red Hat Enterprise Linux 5 and Red Hat Enterprise Linux 6

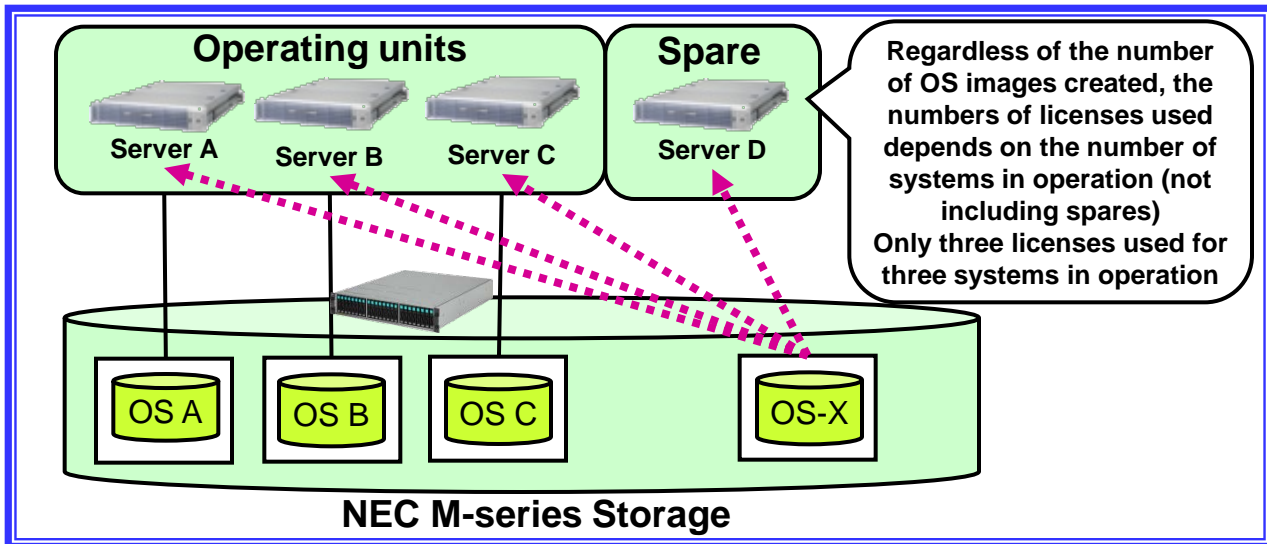

- With respect to Red Hat Enterprise Linux licenses, the subscription of a failed server is passed on to the spare. Thus only actual servers in operation (excluding spares) are counted. In the above illustration, only three licenses are used.

8. Precautions and Restrictions

8.3. OS

8.3.2. OS Memory Dump

- Red Hat Enterprise Linux 5 and Red Hat Enterprise Linux 6
 - By installing NEC Storage PathManager for Linux, memory dumps can be used after FC path switching. In such cases, set the dump source as the /dev/ddX (X is arbitrary) device. If an FC path error occurs while extracting from the dump source, then extraction will be interrupted.

- Using M Series with Windows Server 2008 and Windows Server 2008 R2
 - The path used to acquire the dump (hereafter called the dump path) is the path used to boot the OS. If the dump path is lost to PnP because of an error, the dump path will switch to an alternative path.
 - In an environment in which multiple paths exist for each FC port, dump extraction may not be possible if there is a path error.
 - Configure two paths between servers and storage so that dump extraction is assured.

8.3.3. Redundant Path Connections when Installing the OS

If there are redundant paths between the server and disk array when Windows or Linux is being installed, installation will fail. Disable redundant configurations before installing these systems. Redundant path configurations can be left intact when installing VMware ESX/ESXi.

8.3.4. Linux OS Logical Volume Manager

Whether it is a system area or a data area, a SAN Boot configuration using LVM (Logical Volume Manager) is not recommended. If LVM is to be introduced into a SAN Boot environment, be sure to conduct thorough verification tests.

8. Precautions and Restrictions

8.4. PathManager

8.4.1. NEC Storage PathManager Versions

The PathManager versions referred to in this manual are as follows (as of September 2012):

- NEC Storage PathManager for Windows → Ver. 5.0
- NEC Storage PathManager for Linux → Ver. 5.3
- NEC Storage PathManager for VMware → Ver. 1.0

8.4.2. Backup and Restore Disks in Linux OS with PathManager Installed

- In a Linux system with PathManager installed, if the OS is restored in a LUN or NEC M-series Storage that differs from the original installation (LUN replacement because of disk copying or error), the OS cannot be booted from that area because the information used by PathManager to recognize the LUN is different.
- When restoring the OS to a different LUN or NEC M-series Storage, return the various setup files to the sd device mount configuration before backing up with DeploymentManager, then execute the steps in "[5.3.4.2 Installation in a SAN Boot Environment](#)" after restoring the OS.

9. Appendix

9.1. Confirm FC Controller WWPN and WWNN

9.1.1. Confirm from IEEE Address Labels

- FC controllers have labels with the IEEE addresses of the FC ports (N8190-153 have a label for one port and N8190-154 have labels for two ports). The 16 digit numbers that start with "1000" are for WWPN and those that start with "2000" are for WWNN.

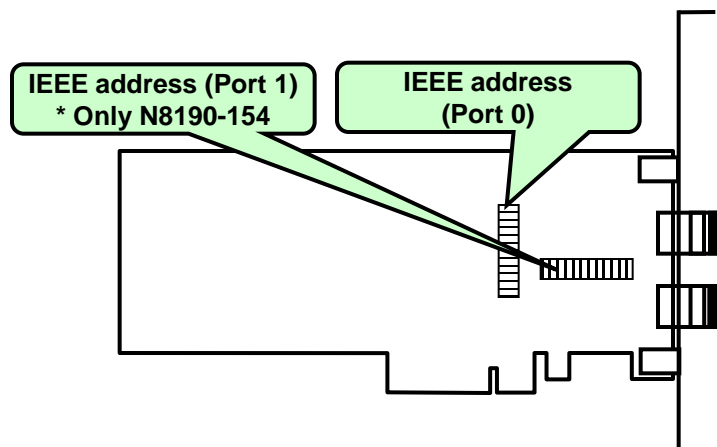

9.1.2. Confirm from the WWPN Address Label (only N8190-153)

- The WWPN address can be confirmed from the WWPN label on a N8190-153 bracket. Replacing the first "1000" numbers of the WWPN address with "2000" will give WWNN address.

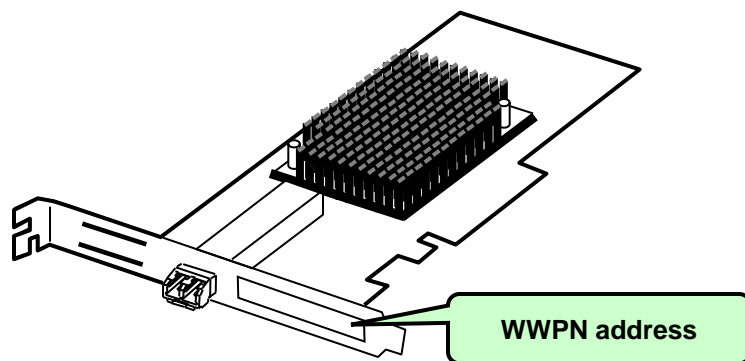

9. Appendix

9.1. Confirm FC Controller WWPN and WWNN

9.1.3. Confirm from the FC BIOS

If an FC controller is mounted, the WWPN and the WWNN can be checked from the FC controller by setting up the server BIOS. See section 4.2 for the instructions on setting up the server BIOS.

- (1) Simultaneously hold down the <Alt>+<E> or <Ctrl>+<E> keys when the following message is displayed during system startup.

```
!!! Emulex LightPulse x86 BIOS !!!, Version 2.02a2
Copyright (c) 1997-2008 Emulex. All rights reserved.

Press <Alt E> or <Ctrl E> to enter Emulex BIOS configuration
utility. Press <s> to skip Emulex BIOS
```

- (2) After the keys are recognized, the following message is displayed and the menu will come up.

```
Emulex BIOS configuration utility selected
Bringing the Link up, Please wait...
Bringing the Link up, Please wait...
```

- (3) A list of FC controller ports installed in the server are displayed. Input the number of the FC controller to check the WWPN /or WWNN and the details appear.

```
Emulex LightPulse BIOS Utility, UB2.02a2
Copyright (c) 1997-2008 Emulex. All rights reserved.

Emulex Adapters in the System:
```

1.	LPe12002-MB:	PCI Bus, Device, Function (05,00,01)
2.	LPe12002-MB:	PCI Bus, Device, Function (05,00,00)

Port 1 (points to Function 01)
Port 0 (points to Function 00)

- * For the N8190-154, the PCI Bus and Device are the same, and Functions are displayed for both the 00 and 01 ports. Function 00 corresponds to Port 0 of the FC controller and Function 01 corresponds to Port 1. The displayed order for the Port 0 and the Port differs according to the server.

9. Appendix

9.1. Confirm FC Controller WWPN and WWNN

(4) The value displayed next to "Port Name" is the WWPN of the FC controller port and the value next to "Node Name:" is the WWNN.

* The last 12 digits of the WWPN and WWNN for the same port are the same.

```
Adapter 01:          PCI Bus, Device, Function (05,00,01)
LPe12002 MB: Mem Base: FBB00000 Firmware Version: US1.11A5
Port Name: 10000000 C98E3121 Node Name: 20000000 C98E3121
Topology: auto Topology: Loop First (Default)
The BIOS for this adapter is Disabled

1. Configure Boot Devices
2. Configure This Adapter's Parameters
```

(5) Press the <ESC> key to return to the screen in (3), then check the rest of the WWPNs and the WWNNs.

NEC Express5800 Series
FC SAN Boot Configuration Guide

September 2012, first edition

NEC Corporation
5-7-1 Shiba, Minato-ku, Tokyo