



ActivBoard 500 Pro Mount System
with PRM-30a or PRM-35 projector



ActivBoard 500 Pro Mount System
with EST-P1 projector

THIS DOCUMENT CONTAINS SPECIFICATIONS FOR

ActivBoard
Projector Mount
Projector

DESCRIPTION

The ActivBoard 500 Pro with Dual-User Pen and Touch capability is available in 87" and 95" versions with integrated slim-line speakers and amplifier, ActivInspire Professional Edition, Promethean ActivOffice and Promethean Applications software. The Mount System includes a Cable Wall Box and choice of Extreme Short Throw or Short Throw projector.

SYSTEM OVERVIEW

Installation

ActivBoard Mount System is suitable for self-installation. Promethean recommends that all Mount Systems should be installed by a Certified Promethean Installer. Please visit www.PrometheanWorld.com/ActivCare/installation. The Projector Mount and the ActivBoard mount directly to the wall. Refer to the User Manual for guidelines on fixing points. Components supplied and minimum specifications stated have been tested and are required for optimal performance. Use of components not supplied by Promethean or not meeting minimum specifications may impact performance and affect warranty. Contact your Promethean partner or visit www.Prometheankb.com for more information. Operation of the ActivBoard 500 Pro requires installation of the driver included with the ActivInspire software and one open USB computer port. Specifications and access to ActivInspire software is available at www.PrometheanPlanet.com/ActivInspire. User with administrator/privileged access rights required to install driver and software

Warranty

For Promethean Warranty Information please visit: www.PrometheanWorld.com/ActivCare

Support

Online Support for all Promethean Products available from: www.Prometheankb.com

Complete System Weight (approx.)

ActivBoard 587 Pro including;
PRM-30a Projector 57.6kg (126.8lb)
PRM-35 Projector 54.6kg (120.2lb)
ActivBoard 595 Pro including;
PRM-30a Projector 65.6kg (144.5lb)
PRM-35 Projector 62.6kg (137.8lb)

ActivBoard 587 Pro including;
EST-P1 Projector 59.8kg (131.7lb)
ActivBoard 595 Pro including;
EST-P1 Projector 67.8kg (149.3lb)

UPGRADE AND ACCESSORY OPTIONS

ActivWand 50

Wireless, battery-free and extended reach input device for the ActivBoard – 540mm (21.2in) in length; “left click”, cursor and hover, just like a mouse

TECHNICAL DRAWING SPECIFICATIONS

ActivBoard 500 Pro Mount System with EST-P1 projector

DIMENSION	587 Pro	595 Pro
ACTIVBOARD 'A'	2105 [82.9]	2336 [92.0]
PROJECTOR 'B'	1379 [54.3]	1409 [55.5]
WALL BOX 'C' ±150 [6]	660 [26.0]	660 [26.0]
FIXING HEIGHT 'D'	920 [36.2]	950 [37.4]
TOTAL HEIGHT 'E'	2380 [93.7]	2410 [94.9]
MIN ROOM HEIGHT 'F'	2390 [94.1]	2420 [95.3]

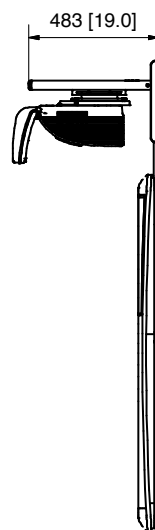
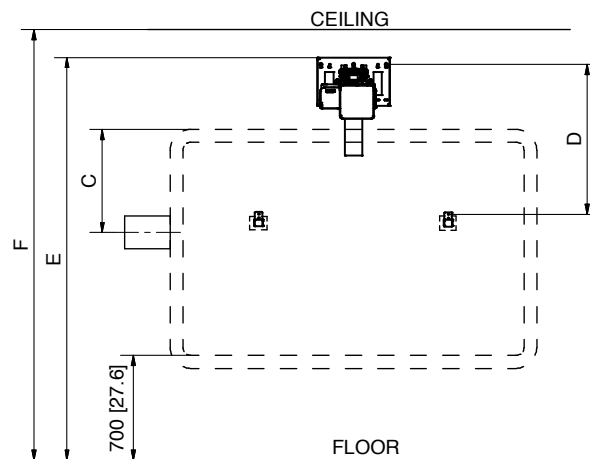
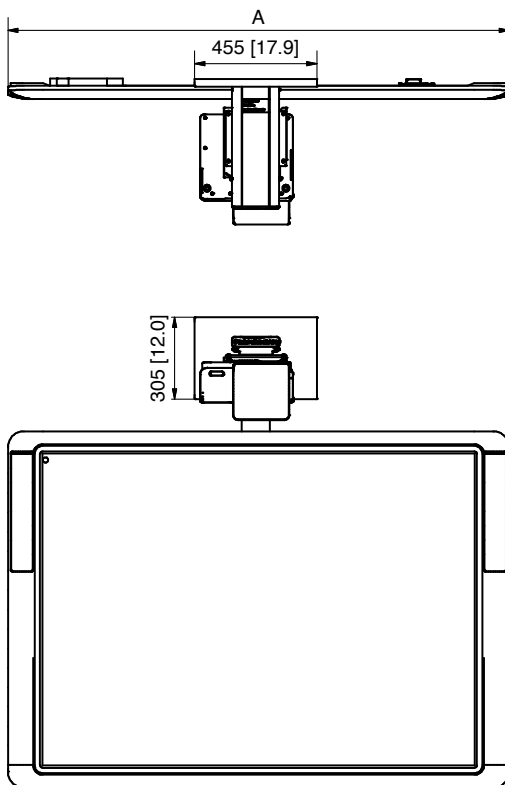

TECHNICAL DRAWING SPECIFICATIONS

ActivBoard 500 Pro Mount System with PRM-30a or PRM-35 projector

	PRM30a - 587 Pro	PRM30a - 595 Pro	PRM35 - 587 Pro	PRM35 - 595 Pro
ACTIVBOARD 'A'	2105 (82.9)	2336 (92.0)	2105 (82.9)	2336 (92.0)
PROJECTOR 'B'	1357 (53.4)	1442 (56.8)	1347 (53.0)	1367 (53.8)
THROW DISTANCE 'C' ±10 (0.4)	906 (35.7)	985 (38.8)	985 (38.8)	1100 (43.3)
WALL BOX 'D' ±150 (6)	660 (26.0)	660 (26.0)	660 (26.0)	660 (26.0)
FIXING HEIGHT 'E'	825 (32.5)	910 (35.8)	810 (31.9)	830 (32.7)
TOTAL HEIGHT 'F'	2295 (90.4)	2370 (93.3)	2270 (81.5)	2290 (90.2)
MIN ROOM HEIGHT 'G'	2305 (90.7)	2380 (93.7)	2280 (81.9)	2300 (90.6)

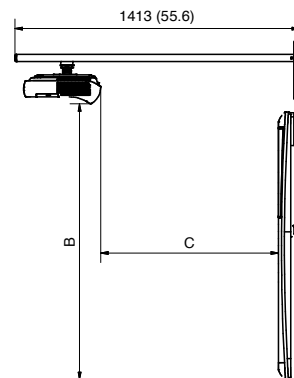
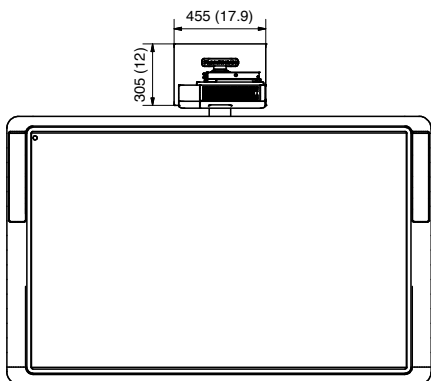
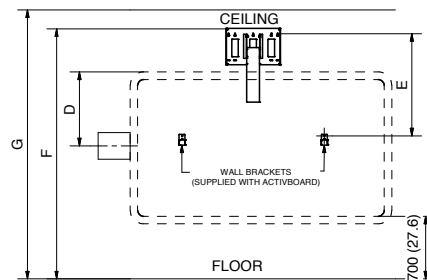
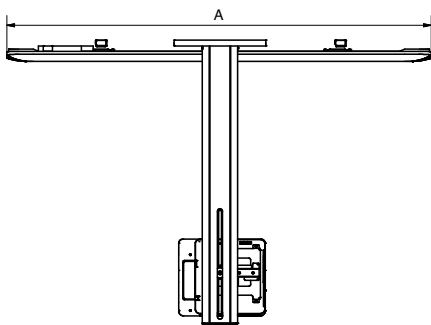

ACTIVBOARD GENERAL SPECIFICATIONS

Model	ActivBoard 500 Pro Range
Pen Internal Resolution	2730 points (lines) per inch
Pen Output Resolution	200 points (lines) per inch
Pen Tracking Rate	200 inches per second providing a fast response to pen commands
Pen Output Rate	160 coordinate pairs per second (single user) 80 coordinate pairs per second (dual user)
User Input	Cordless battery-free pen incorporating tip switch and side switch for full mouse functionality (ActivPen) and touch
Touch Resolution	200 points (lines) per inch
Touch Output Rate	80 coordinate pairs per second
Touch Response Rate	10 ms
Maximum Simultaneous Touches	2 with ActivInspire (Minimum requirement of 1.5 ActivInspire Professional Edition) 4 with Windows 7
Digitizing Technology	Passive Electromagnetic and Capacitive sensing interface
Power Requirement	Mains Powered; 18V Power Supply Unit
Connection to Computer	USB 2.0, 1 x 3m USB 2.0 data cable supplied
Connection to Peripherals	2 x USB ports on left hand side
Screen Surface	Low Glare Melamine
Certifications	UL, CE, FCC
Operating Temperature Range	0°C to +40°C (32°F to 104°F)
Storage Temperature Range	-20°C to +60°C (-4°F to 140°F)
Storage Humidity	10% to 90% (non-condensing)
Dual User Functionality	Pen: 1 Facilitator ActivPen and 1 Participant ActivPen can be used together in Dual-User Mode when using ActivInspire 1.5 Professional Edition and above. Pen and Touch: 1 Participant ActivPen and simultaneous additional two-touch gesture supported when using ActivInspire 1.5 Professional Edition and above.
Single User Functionality	Pen: 1 Facilitator ActivPen Touch: Two-touch gesture supported when using ActivInspire 1.5 Professional Edition and above.
Integrated USB Sound	Two integrated slim-line speakers and amplifier (with controls, inputs and outputs)
Packed Contents List	ActivBoard 587 Pro or ActivBoard 595 Pro, 2 Facilitator ActivPens, 2 Participant ActivPens, 1 AMP PSU, Wall Mounting Brackets, User Guide, Access to ActivInspire Professional Edition, Promethean ActivOffice and Promethean Applications via download. (ActivInspire Professional Edition is also available on DVD on request), 1 x 3m USB data cable

INTEGRATED USB SOUND SPECIFICATIONS

Amplifier Power Output	20W per channel RMS (<1% distortion)
Controls	Volume, Bass, Treble, on/off
Amplifier Frequency Response	40Hz to 18kHz +/-3dB (at 1W)
USB Sound	USB Sound supported for Minimum System Requirements stated
Connectivity – Inputs (4)	Stereo PC, Stereo CD/DVD, Mono Auxiliary, Microphone to PC
Connectivity – Outputs (2)	2 Stereo
Power Requirement	18V 5 Amp

ACTIVBOARD SPECIFICATIONS

Model	ActivBoard 587 Pro	ActivBoard 595 Pro
ActivBoard Size	87in	95in
Resolution	14600 x 9200	17200 x 9200
Screen Formats	16:10	16:9
Overall Dimensions	2105mm x 1329mm (82.9in x 52.3in)	2336mm x 1329mm (92in x 52.3in)
Active Area Dimensions	1865mm x 1175mm (73.4in x 46.3in)	2095mm x 1175mm (82.5in x 46.3in)
Active Area Diagonal	2196mm (86.5in)	2394mm (94.3in)
Actual Image Diagonal	2193mm (86.4in)	2392mm (94.2in)
Board Weight	40kg (88lb)	48kg (106lb)
Packed Weight	57kg (126lb)	65kg (143lb)
Packed Dimensions	2270mm x 1500mm x 110mm (89.4in x 59.1in x 4.3in)	2572 mm x 1495mm x 110mm (101.3in x 58.9in x 4.33in)

MINIMUM COMPUTER REQUIREMENTS

Operating Systems	Windows XP SP3 and above (XP/Vista/7); Mac OSX 10.4.11 – 10.6.4 (Tiger/Leopard/Snow Leopard); Linux Ubuntu 9.10 or 10.04; Debian Lenny; Linex Colegios 2010; Linkat 3; ALT_Linux (Russia)
PC	2.0 GHz Intel Core 2 Duo or faster for HD-quality videos, 1 GB of RAM is required to play HD-quality videos, 1024 x 768 resolution, 1.5 GB of Free Disk Space
Mac	2.0 GHz Intel Core 2 Duo, 512 MB of RAM, 1024 x 768 resolution, 3.0 GB of Free Disk Space
Linux	2.0 GHz Processor or faster for HD-quality videos, 1 GB of RAM is required to play HD-quality videos, 1024 x 768 resolution, 1.5 GB of Free Disk Space

Product Specifications

MOUNT SPECIFICATIONS

Projector Mount	For use with Short Throw Projector, aluminium arm extends 1415mm (55.7in) from the wall	For use with Extreme Short Throw Projector, aluminium arm extends 485mm (19.1in) from the wall
Room Height	Minimum room height 2400mm (94.5in)	Minimum room height 2400mm (94.5in)
Power	Power Outlets required for the projector, computer and ActivBoard	Power Outlets required for the projector, computer and ActivBoard
Weight (approx.)	Frame only: Approx. 9.9kg (22lb) excluding projector and cabling	Frame only: Approx. 8.8kg (22lb) excluding projector and cabling
Cable Management	Cables directed through the projector mount, mounting plate and behind the ActivBoard	Cables directed through the projector mount, mounting plate and behind the ActivBoard
Pack Weights & Dimensions	Box 1 of 1: 11.9kg (26.3lb) Dimensions: 1430mm x 325mm x 100mm (56.3in x 12.8in x 3.9in)	Box 1 of 1: 9.9kg (21.9lb) Dimensions: 715mm x 320mm x 120mm (28.1in x 12.6in x 4.7in)
Packed Contents List	Wall Plate, Cover, Projector Mount and Mounting Plate, VGA Cable plus Fixings	Wall Plate, Cover, Projector Mount and Mounting Plate, VGA Cable plus Fixings



ActivBoard Systems/Boards SS 07/11 V1.2 UK

©2011 Promethean Limited. All rights reserved. Promethean Ltd. is owner of a number of trademarks in several jurisdictions across the world. Any third-party product and company names are mentioned for identification purposes only and may be trademarks of their respective owners. [†]Applicable Terms and Conditions for warranty and support available at www.PrometheanWorld.com/ActivCare. All dimensions +/- 5mm (0.2in). All weights +/- 0.9kg (2lb). Product Specifications are subject to change without notice. www.PrometheanWorld.com

Product Specifications

PROJECTOR SPECIFICATIONS

Model	EST-P1 (DLP)	PRM-35 (DLP)	PRM-30a (LCD)
Native Resolution	WXGA (1280 x 800)	WXGA (1280 x 800)	WXGA (1280 x 800)
Compressed Resolution	up to 1080i	up to 1080i	up to 1080i
Typical Colours	16.77 million colours	16.77 million colours	16.77 million colours
Brightness (ANSI lumens)	2200 ANSI (normal) 2500 ANSI (high)	2100 ANSI (normal) 2500 ANSI (high)	1900 ANSI (normal) 2500 ANSI (high)
Contrast Ratio	2000:1	2000:1	500:1
Noise Level	27dB (normal) 31dB (high brightness mode)	32dB (normal) 36dB (high brightness mode)	29dB (normal) 36dB (high brightness mode)
Dimensions (w x d x h)	354mm x 319mm x 157mm (13.9in x 12.6in x 6.1in) not including lens 354mm x 411mm x 219mm (13.9in x 16.1in x 8.6in) including lens	306mm x 275mm x 97mm (12in x 3.8in x 10.1in)	382mm x 430mm x 129mm (15in x 16.9in x 5in)
Weight	9kg (19.8lb)	2.7kg (6lb)	5.7kg (12.5lb)
Aspect Ratio	16:10 (native), 4:3, 16:9	16:10 (native), 4:3, 16:9	16:10 (native), 4:3, 16:9
Power Consumption	290W (<1W standby)	230W (<1W standby)	317W (<0.8W standby)
Device Type	DLP Technology	DLP Technology	LCD Technology
Focus	Manual Focus	Manual Focus	Manual Focus
Zoom	N/A	Digital Zoom	Digital Zoom
Focal Length	F=2.4	F=2.86	Fixed
Projection Distance	0.39m ~ 0.56m (15in ~ 22in)	0.54m ~ 1.22m (21.3in ~ 48in)	0.54m ~ 1.22m (21.3in ~ 48in)
Projection Screen Size	1.98m ~ 2.79m (78in ~ 110in)	1.27m ~ 2.79m (50in ~ 110in)	1.27m ~ 2.79m (50in ~ 110in)
Lamp Type	220W lamp	230W lamp	230W lamp
Lamp Life	6000hrs (normal), 4000hrs (high)	6000hrs (normal), 4000hrs (high)	4000 hrs (normal), 3000 hrs (high)
Keystone Correction	Vertical: max ±15°	Vertical: max ±15°	Vertical: max ±20°
Operating Temperature	5°C ~ 35°C (41°F ~ 95°F)	5°C ~ 35°C (41°F ~ 95°F)	5°C ~ 35°C (41°F ~ 95°F)
Power Supply Voltage	100 - 240V AC, 50/60Hz	100 ~ 240V AC, 50/60Hz	100 ~ 240V AC, 50/60Hz
Horizontal Scan Rate	15Hz ~ 90kHz	15Hz ~ 90kHz	15Hz ~ 90kHz
Vertical Scan Rate	43Hz ~ 85Hz	50Hz ~ 85Hz	50Hz ~ 85Hz

CONTINUED ON NEXT PAGE



ActivBoard Systems/Boards SS 07/11 V1.2 UK

©2011 Promethean Limited. All rights reserved. Promethean Ltd. is owner of a number of trademarks in several jurisdictions across the world. Any third-party product and company names are mentioned for identification purposes only and may be trademarks of their respective owners. ¹Applicable Terms and Conditions for warranty and support available at www.PrometheanWorld.com/ActivCare. All dimensions +/- 5mm (0.2in). All weights +/- 0.9kg (2lb). Product Specifications are subject to change without notice. www.PrometheanWorld.com

PROJECTOR SPECIFICATIONS (CONTINUED)

Computer Compatibility	IBM PC and Compatibles; Apple Macintosh, iMac, and VESA Standards WSXGA+ (1,680 x 1,050), WXGA+ (1,440 x 900), WXGA (1,280 x 800, 1,280 x 768), UXGA (1,600 x 1,200), SXGA+ (1,400 x 1,050), SXGA (1,280 x 1,024), XGA (1,024 x 768), SVGA (800 x 600), VGA (640 x 480)	IBM PC and Compatibles; Apple Macintosh, iMac, and VESA Standards WSXGA+ (1,680 x 1,050), WXGA+ (1,440 x 900), WXGA (1,280 x 800, 1,280 x 768), UXGA (1,600 x 1,200), SXGA+ (1,400 x 1,050), SXGA (1,280 x 1,024), XGA (1,024 x 768), SVGA (800 x 600), VGA (640 x 480)	IBM PC and Compatibles; Apple Macintosh, iMac, and VESA Standards WSXGA+ (1,680 x 1,050), WXGA+ (1,440 x 900), WXGA (1,280 x 800, 1,280 x 768), UXGA (1,600 x 1,200), SXGA+ (1,400 x 1,050), SXGA (1,280 x 1,024), XGA (1,024 x 768), SVGA (800 x 600), VGA (640 x 480)
Video Compatibility	NTSC (3.58/4.43), PAL (B/D/G/H/I/M/N), SECAM (B/D/G/K/K1/L), HDTV (720p, 1080i, 1035i), EDTV (480p, 575i), SDTV (480i, 576i)	NTSC (3.58/4.43), PAL (B/D/G/H/I/M/N), SECAM (B/D/G/K/K1/L), HDTV (720p, 1080i, 1035i), EDTV (480p, 575i), SDTV (480i, 576i)	NTSC (3.58/4.43), PAL (B/D/G/H/I/M/N), SECAM (B/D/G/K/K1/L), HDTV (720p, 1080i, 1035i), EDTV (480p, 575i), SDTV (480i, 576i)
Inputs/Outputs	D-sub 15 (RGB) x 2 D-sub 15 (Monitor out) x 1 HDMI V1.3 only for Video x 1 S-Video x 1 Composite Video (RCA) x 1 USB control x 1 Networking LAN (RJ45) x 1 RS-232C (D-sub 9) x 1	D-sub 15 (RGB) x 2 D-sub 15 (Monitor out) x 1 HDMI V.1.3 only for Video x 1 S-Video x 1 Composite Video (RCA) x 1 USB control x1 Networking LAN (RJ45) x 1 RS-232C (D-sub 9) x 1	D-sub 15 (RGB) x 1 D-sub 15 (RGB) selectable x 1 HDMI (Digital RGB) x 1 S-Video x 1 Composite Video (RCA) x 1 RCA (white/red) x 1 Networking LAN (RJ45) x 1 RS-232C (D-sub 9) x 1 Stereo mini-jack x 1
Colour	Silver	Silver	Silver
Security	Kensington Lock, Security cable bar option, pin code security, remote control operated only	Kensington Lock, Security cable bar option, pin code security, remote control operated only	Kensington Lock, Security cable bar option, pin code security, remote control operated only
On-screen Menu	Arabic, Chinese (Simplified), Chinese (Traditional), Czech, Dutch, English, Finnish, French, German, Greek, Hungarian, Italian, Japanese, Korean, Norwegian, Polish, Portuguese, Russian, Spanish, Swedish, Thai, Turkish	Arabic, Chinese (Simplified), Chinese (Traditional), Czech, Dutch, English, Finnish, French, German, Greek, Hungarian, Italian, Korean, Norwegian, Polish, Portuguese, Russian, Spanish, Swedish, Turkish	Arabic, Chinese (Simplified), Chinese (Traditional), Danish, Dutch, English, Finnish, French, German, Hungarian, Italian, Japanese, Kazak, Korean, Norwegian, Polish, Portuguese, Portuguese (Brazilian), Romanian, Russian, Spanish, Swedish, Turkish
Advanced Features	Filter-less 3D Ready Crestron RoomView Express Quick Lamp Access Direct power on/off Closed Caption	Filter-less 3D Ready Crestron RoomView Express Quick Lamp Access Direct power on/off Closed Caption	Long Life Filter – 4000hrs Crestron RoomView Express Cable Management Cover Quick Lamp Access Direct power on/off Closed Caption
Packed Contents List	Projector, Power cord, computer cable (D-sub15 – D-sub15), wireless remote, owner's manual (CD - ROM & Quick Start Guide)	Projector, Power cord, computer cable (D-sub15 – D-sub15), wireless remote, owner's manual (CD - ROM & Quick Start Guide)	Projector, Power cord, computer cable (D-sub15 – D-sub15), wireless remote, owner's manual (CD - ROM & Quick Start Guide)
Pack Weights and Dimensions	Box 1 of 1: 13.5kg (29.7lb) Dimensions: 572mm x 496mm x 310mm (22.5in x 19.5in x 12.2in) Contents: Projector	Box 1 of 1: 4.9kg (10.8lb) Dimensions: 396mm x 341mm x 181mm (15.5in x 13.4in x 7.1in) Contents: Projector	Box 1 of 1: 9.5kg (20.9lb) Dimensions: 510mm x 470mm x 240mm (20in x 18.5in x 9.4in) Contents: Projector

ActivBoard Systems/Boards SS 07/11 V1.2 UK

©2011 Promethean Limited. All rights reserved. Promethean Ltd. is owner of a number of trademarks in several jurisdictions across the world. Any third-party product and company names are mentioned for identification purposes only and may be trademarks of their respective owners. ¹Applicable Terms and Conditions for warranty and support available at www.PrometheanWorld.com/ActivCare. All dimensions +/- 5mm (0.2in). All weights +/- 0.9kg (2lb). Product Specifications are subject to change without notice. www.PrometheanWorld.com

