

*User's manual*

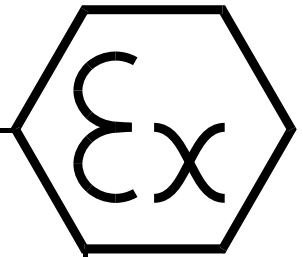

# Digital Indicator D122.A

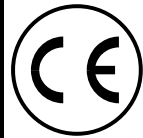

Edition of standards 2010, software version 1.7

User's manual for indicators

D122.A.0.x.x

D122.A.3.x.x

D122.A.5.x.x

D122.A.6.x.x



**Gönnheimer  
Elektronik GmbH**

<http://www.goennheimer.de> Email: [info@goennheimer.de](mailto:info@goennheimer.de)





Dr.-Julius-Leber-Straße 2  
67433 Neustadt/Weinstraße  
Postfach 10 05 07  
67405 Neustadt, Germany  
phone: +49 (6321) 49919- 0  
fax: +49 (6321) 49919 - 41

## Table of contents

<b>1</b>	<b>Operation instruction for Explosion protected device.....</b>	<b>4</b>
<b>2</b>	<b>Digital Indicator D122.A.....</b>	<b>4</b>
2.1	Short description.....	4
2.2	Features overview.....	5
2.2.1	Basic functions.....	5
2.2.2	Options.....	5
2.3	Conformity with Standards.....	5
2.4	Internal zener barrier option.....	6
2.5	Integrated 2-wire transmitter option.....	6
2.6	Special software option.....	7
2.7	Curve fitting.....	7
2.8	Square root-fitting.....	7
<b>3</b>	<b>Installation and Connection.....</b>	<b>8</b>
3.1	D122 with control panel housing.....	8
3.1.1	Installation control panel housing.....	8
3.1.2	Connecting D122 with control panel housing.....	8
3.2	Field housing D122.A.5 and D122.A.6.....	9
3.2.1	Connection D122 with field housing.....	9
3.3	Connecting D122A with zener barrier option.....	10
3.4	Connecting D122A with limit terminals (terminals 5/6 + 7/8).....	11
3.5	Initial operation.....	11
3.5.1	Default parameters.....	11
3.5.2	Ex works settings – Device reset.....	11
<b>4</b>	<b>Operating manual.....</b>	<b>12</b>
4.1	Front view.....	12
4.2	Keyboard.....	12
4.3	Configuration.....	13
4.3.1	How to set the parameters.....	14
4.3.2	Hysteresis and time delay setting.....	16
4.4	Configuration example.....	17
<b>5</b>	<b>Flow charts.....</b>	<b>20</b>
<b>6</b>	<b>Annex.....</b>	<b>26</b>
6.1	Specifications.....	26
6.2	Type code.....	27
6.3	Material specification.....	27
6.4	Marking.....	27
6.5	Failure messages.....	28
6.6	Transport, Storing, Repairs und Disposal.....	28
6.7	Dimensions.....	29
6.8	List of Parameters.....	30
6.9	Index.....	32

## The symbols WARNING, CAUTION, NOTE

 <b>Warning</b>	This symbol warns of a serious hazard. Failure to observe this warning may result in death or the destruction of property.
 <b>Caution</b>	This symbol warns of a possible failure. Failure to observe this caution may result in the total failure of the device or the system or plant to which it is connected.
 <b>Note</b>	This symbol highlights important information.

# 1 Operation instruction for Explosion protected device

## Application and Standards

This instruction manual applies to explosion-protected control panels of type of protection types below. This apparatus is only to be used as defined and meets requirements of EN 60 079 particularly EN60 079-14 "electrical apparatus for potentiality explosive atmospheres".

Use this manual in hazardous locations, which are hazardous due to gases and vapours according to the explosion group and temperature class as stipulated on the type label. When installing and operating the explosion protected distribution and control panels you should observe the respective nationally valid regulations and requirements.

## General Instructions

The device has to have a back-up fuse as stipulated. The mains connection must have a sufficient short circuit current to ensure safe breaking of the fuse. To achieve an impeccable and safety device operation, please take care for adept transportation, storage and mounting, as well as accurate service and maintenance. Operation of this device should only be implemented by authorised persons and in strict accordance with local safety standards.



The electrical data on the type label and if applicable, the "special conditions" of the test certificate TÜV 99 ATEX 1488 are to be observed.

For outdoor installation it is recommended to protect the explosion protected distribution and control panel against direct climatic influence, e.g. with a protective roof. The maximum ambient temperature is 40°C, if not stipulated otherwise.

## Intrinsically Safe Circuits

Erection instructions in the testing certificates of intrinsically safe apparatus are to be observed. The electrical safety values stipulated on the type label must not be exceeded in the intrinsically safe circuit. When interconnecting intrinsically safe circuits it is to be tested, whether a voltage and/or current addition occurs. The intrinsic safety of interconnected circuits is to be ensured. (EN 60079-14, section 12)

## Safety Measures: to read and to comply

 <b>Warning</b>	<p>Work on electrical installations and apparatus in operation is generally forbidden in hazardous locations, with the exception of intrinsically safe circuits. In special cases work can be done on non-intrinsically safe circuits, on the condition that during the duration of such work no explosive atmosphere exists. Only explosion protected certified measuring instruments may be used to ensure that the apparatus is voltage-free. Grounding and short-circuiting may only be carried out, if there is no explosion hazard at the grounding or short circuit connection.</p>
 <b>Warning</b>	<p><b>Danger of static charge!</b>  <b>Clean only with humid cloth!</b>  <b>Do not open when an explosive dust atmosphere is present!</b></p>

## 2 Digital Indicator D122.A

### 2.1 Short description

The digital Indicator D122 indicates measured values of intrinsically safe current circuits from 4 up to 20 mA in hazardous areas. The device is powered by measure current, therefore an extra power supply or batteries are unnecessary. The indicator measures the current, scales the measured value and displays finally the result on the LCD.

For trend analysis, the measured signal is also displayed on a 41 segment bargraph. It's possible to scale the bargraph separately to the digital value. The indicator D122 is available in several housings.

Furthermore with alarm monitoring option the indicator has two intrinsically safe alarm outputs. These outputs change their state, when the measured value exceeds his alarm limits. It's possible to choose open-circuit or closed-circuit connection.

Additional the alarm limits appear graphically on a second bargraph. On one look you're sure that the measured value is in its limits.

## 2.2 Features overview

### 2.2.1 Basic functions

- Loop-powered digital Indicator
- Connect like passive analogue indicators, voltage drop ca. 1V
- LC-Display up to 50 mm figure-height
- Scale by buttons and display
- Fast bargraph for trend observation (41 segments, refresh 4 times per second)
- Separately scaleable Bargraph (Zoom)
- Several housings available (control panel- and field housing)

### 2.2.2 Options

- Alarm monitoring: two intrinsically safe alarm outputs and an additional limit-bargraph on the display
- Limit-functions with hysteresis and time delay
- Field housing with additional (2<sup>nd</sup>) PG-Connector

## 2.3 Conformity with Standards

The explosion proof indicators type D122 meets requirements of listed standards in the attachment (Declaration of conformity). They were developed, manufactured and tested in accordance with state-of-the-art engineering practice and ISO9001:2008.

## 2.4 Internal zener barrier option

### Devices with type code D122.A.x.x.BM

The standard digital indicator D122 works exclusively in intrinsically safe 4..20 mA current circuits (Ex i). If the concerned measure current circuit is **not** intrinsically safe, an extra zener barrier or an isolated interface and a long additional cable to the interface outside the hazardous area and back is needed.

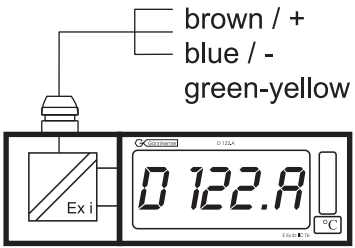
<p><i>Ex- area</i></p> <p>4..20 mA not intrinsically safe</p> <p>←</p> <p>brown / + blue / - green-yellow / PE</p> 	<p>In those cases, the option integrated zener barrier is very practical, because the interface is build in. A further advantage of an indicator with this option is that the <b>intrinsic safety proof is not required</b>. The ignition protection is <i>Ex m [ib] IIC T6</i> at ambient temperature of 45°C, <i>Ex m [ib] IIC T5</i> at 60 °C respectively.</p> <p><i>The terminal voltage in the measure circuit with internal zener barrier option is about 2 V.</i></p>
--	---

## 2.5 Integrated 2-wire transmitter option

### Devices with type code D122.A.x.x.MU

Using the integrated 2-wire transmitter for head mounting option, the D122 has an interface to an arbitrary sensor e.g. a PT 100.

The digital indicator series with field housing can be equipped with a customized intrinsically safe 2-wire transmitter for head mounting, according to DIN 43729 type B (max. height = 30 mm). With this option, it is possible to connect a sensor, e.g., a PT 100 directly to the digital indicator D122.

Customer can specify or provide the desired transmitter by order.

This option is only available for indicators with field housing. The depth of the field housing is increased from 64 to 82 mm.

A combination with the internal zener barrier option is not possible.

## 2.6 Special software option

Indicators D122.AS as well as totalizers D122.ZS have a special software option. With this option, it is possible to use these devices in any individual cases of measurement and indication.

## 2.7 Curve fitting

The curve fitting software **indicates the measure current in a non-linear way**. Consider the application of a filling-level meter for a sphere-tank. The measure current is linear to the filling-height of the liquid. Nevertheless, the function between the filling-height and the volume is non-linear, as shown in the figure below.

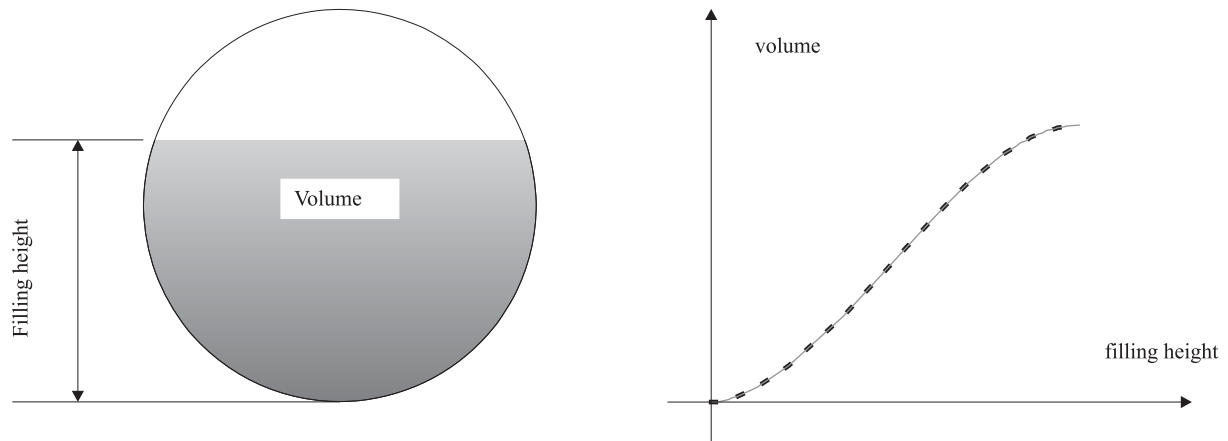

To get the correct quantity indication you require a **list of points**, which shows the connection between measure current and associated quantity inside of the tank. The curve fitting software of the D122.XS interpolates the curve between these points on your choice in a linear or a square way.

The **linear interpolation** generates imaginary **straight lines** between the selected points. A value on this line will be calculated on base of his distance to the previous selected point. This kind of interpolation requires **17 points** to scale 4 up to 20 mA.

On the other hand, the **square interpolation** needs a list of **33 points**, but it approximates the original curve much better than the linear one, so the **error between the original curve and the interpolated curve is much smaller**.

To put in the list of selected point enter the (extended) scale menu. The device displays the measure current and you have to enter the associated display value. See also related flow diagram.

## 2.8 Square root-fitting

To program a square root-function, e.g., to display the flow through a aperture, a special square root-fitting feature is available. For this option, it is not necessary to enter a list of points, but just a start- and a end-value (in previous example: associated flow by 4 and by 20mA measure current). The device calculates automatically the selected points for interpolation. Be prepared, this procedure will take some time. See also related flow diagram.

## 3 Installation and Connection

### 3.1 D122 with control panel housing

#### 3.1.1 Installation control panel housing

The digital indicators D122.A.0 and D122.A.3 are predicated for installation in a control panel.

#### How to insert the dimension symbol

Insert the dimension symbol (icon) before mounting. Do this by first removing the front frame as shown in the figure at left. Now remove the front panel from the housing as shown in the figure on the right.

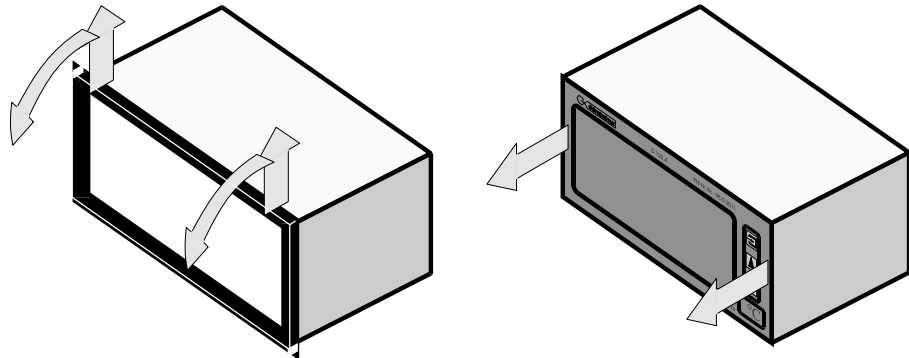

Cut the desired dimension-symbol from the set and pull it into its intended place on the right side of the panel. Make sure that the symbol is facing the front. Replace the front panel and frame.

#### Fixing

Fix the indicator into the control panel with the intend cramps.

#### 3.1.2 Connecting D122 with control panel housing



**Caution**

**Connect the indicator only to intrinsically safe 4..20 mA current circuits.**

The terminals of the indicators in the control panel housing are shown in figure 1. The terminals 5,6 and 7,8 are absent by indicators without alarm monitoring.



**Caution**

**Please regard the terminal maximum values of the attached EC- type certificate TÜV 99 ATEX 1488 .**



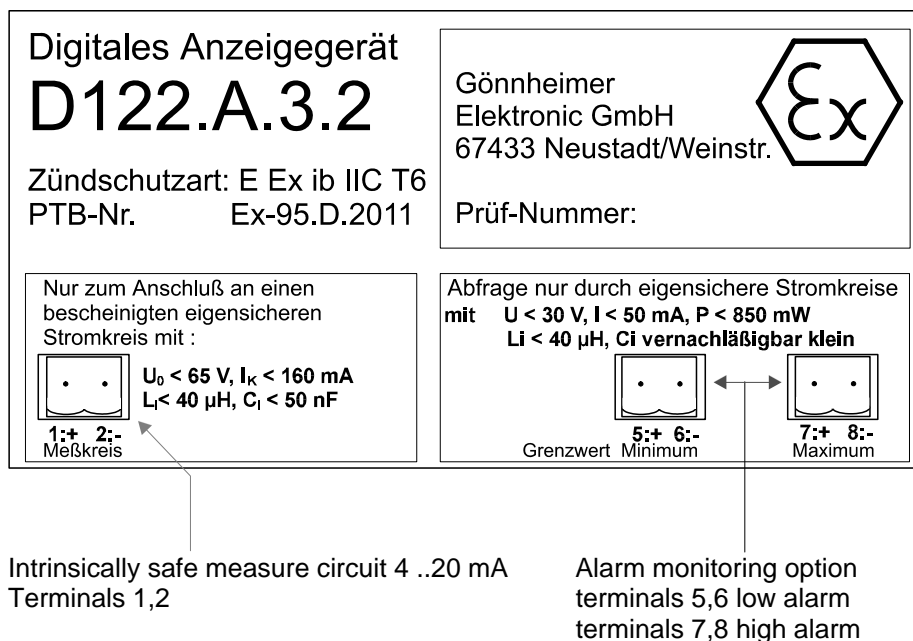

Figure 1: Terminals by indicators with control panel housing

## 3.2 Field housing D122.A.5 and D122.A.6

When mounting the housing box on a wall, be sure that it is securely supported by anchoring the screws into a stud or other solid surface.

### How to insert the Dimension-symbol

First, cut the desired dimension symbol out of the set. Then pull off the four screws of the cap and remove the cap from the housing. Now push the prepared dimension-symbol into the dimension-symbol-slot. Make sure that the symbol is facing the front. The dimension-symbol-slot lies below the display, on the internal side of the cap. Finally replace the cup on the housing.

### 3.2.1 Connection D122 with field housing

The terminals of the indicators with field housing are inside. The placement of the terminals is shown at the following figures.

Figure 2 shows the terminals of the indicator D122.A.5. Figure 3 shows the terminals of the indicator D122.A.6. The terminals 5,6 and 7,8 are absent by indicators without alarm monitoring.



Caution

**Please regard the terminal maximum values of the attached EC- type certificate TÜV 99 ATEX 1488 .**

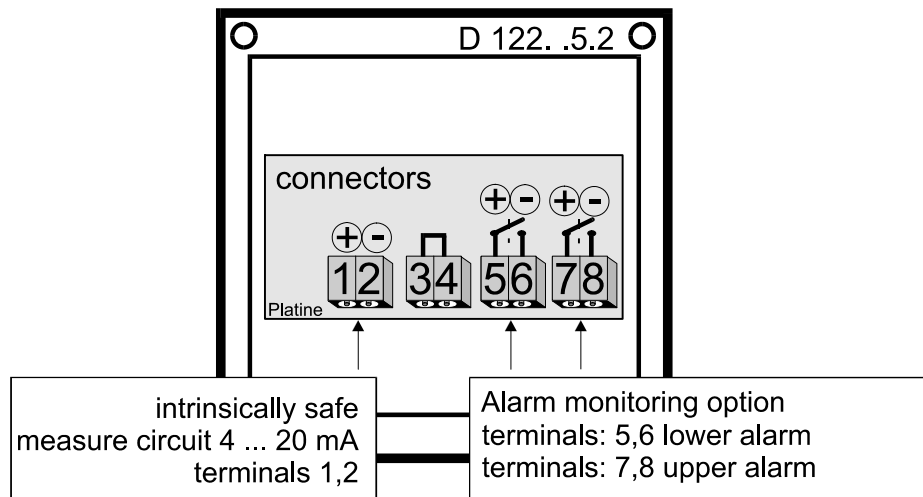

Figure 2: Terminals of the indicator D122.A.5

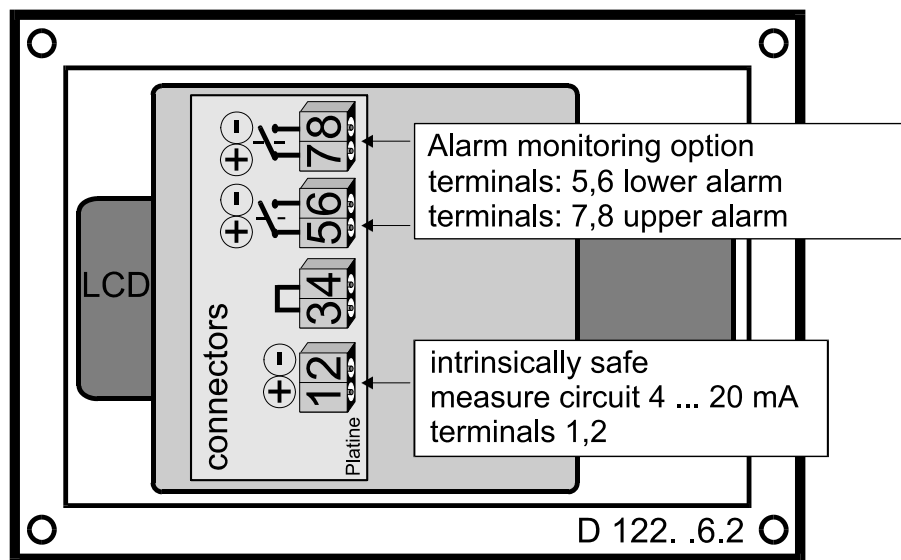

Figure 3: Terminals of the indicator D122.A.6

### 3.3 Connecting D122A with zener barrier option

Connect the D122.A.x.x.BM to a non intrinsically safe measure signal.



Inside of hazardous area the D122.A.x.x.BM cable must be connected in a certificated Ex e-connection box.

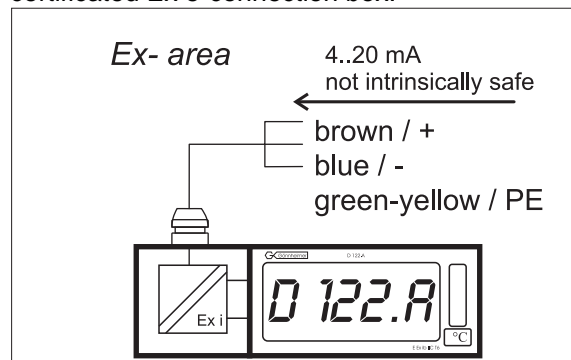

Figure 4: Connection of D122.A.x.x.BM

Cable colors	Cable	Connection
	Brown	+
	Blue	-
Green yellow	PE	

### 3.4 Connecting D122A with limit terminals (terminals 5/6 + 7/8)

Devices with type code D122.x.x.2.x

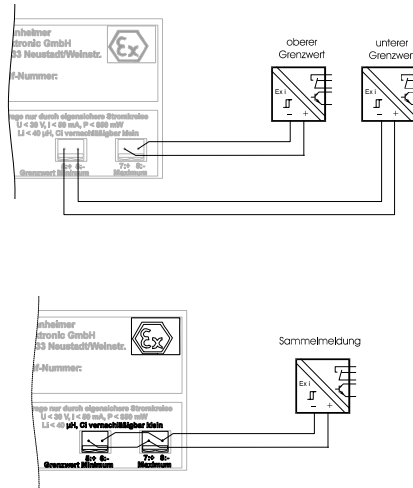

Figure 5 : limit monitoring with D122.x.x.2.x

### 3.5 Initial operation



#### Note

After connecting, a **display test** (all segments of the display are turned on) appears immediate during one second. Thereupon the display shows the **software version** of the indicator.

#### 3.5.1 Default parameters

The following parameters are active ex works:

<b>Scaling (display and bargraph)</b>	4 mA current -> 4.00 20 mA current -> 20.00
<b>Limits</b>	Low: 4.00 mA / High: 20.00 mA
<b>Hysteresis / Delay</b>	0.10 / 0 sec.
<b>alarm outputs (alarm monitoring)</b>	circuit-opening connection
<b>Code words</b>	CODE1: 0001 / CODE2: 0002

#### 3.5.2 Ex works settings – Device reset



#### Note

Press the Enter- and Right-button during the start sequence to reactivate the default parameters. (Hardware-Reset)

A reset activates also the ex works calibration.

## 4 Operating manual

### 4.1 Front view

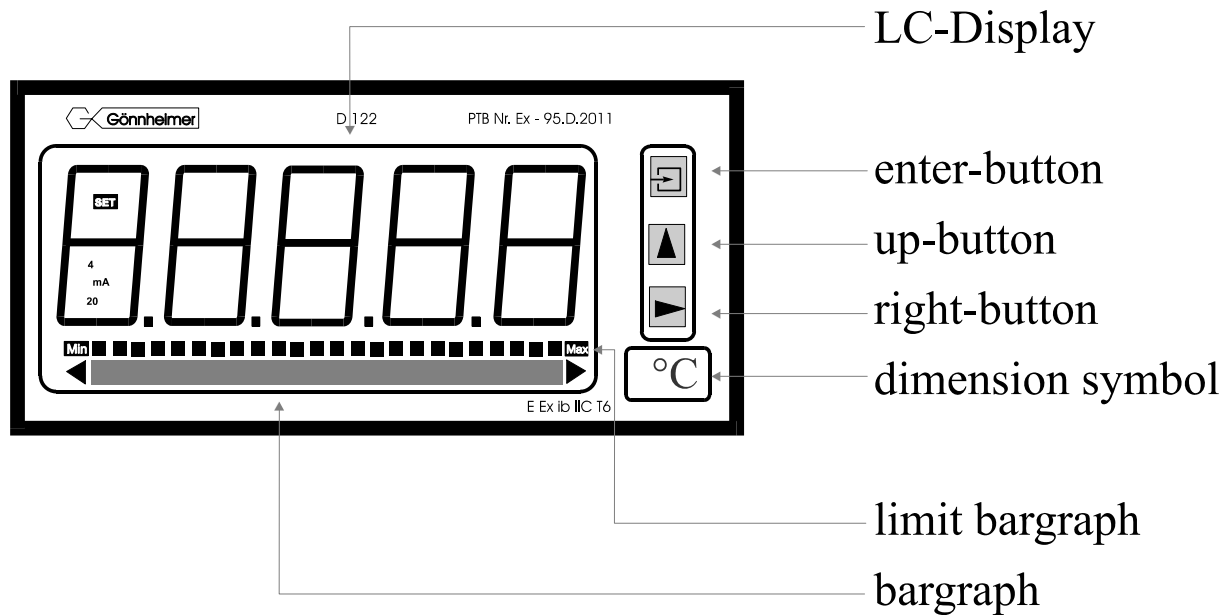

### 4.2 Keyboard

On the front side of the indicator are three buttons with several function symbols. With these three buttons, the user can activate each function and enter all parameters for any individual setting. The buttons are named by their functions:

#### *Enter-button*

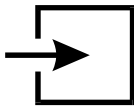

Pressing the *enter*-button starts the input menu. In general, the *enter*-button activates the menu item or accepts the manipulated value of a parameter.

#### *Up-button*



Functions of the up-button are:

1. current control button
2. modification of the selected figure
3. pass menu items

#### *Right-button*

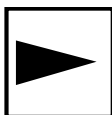

Functions of the right-button are:

1. change the display to limit view
2. select figures
3. pass menu items

## 4.3 Configuration

It is easy to set the parameters and change the configuration of the indicator. The parameters are logically grouped by a menu structure. See also the appropriate **flow diagram** in the appendix.



### Note

Note flow charts

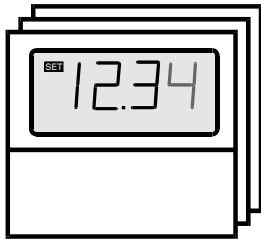

Indicators without the alarm monitoring option have not got the corresponding menu items.

**The Input views in the flow diagrams have additional boxes in their background**, because the Input views may be changed by pressing any of the buttons.

The procedure, to enter a value, is shown in the flow diagram 'Value input menu', see figure 13.

### ☞ Normal state

After connecting, the indicator D122 starts to initialise its configuration. The configuration data is stored in an internal EEPROM due to the previous run. By the first start, the D122 indicator initialises the default configuration.

Directly past starting sequence the indicator begins to display the measured current digital and analogous on the bargraph. This state is called the 'normal state' of the D122 and the indicator is also ready for inputs.

(See also flow diagram in figure 9)

### ☞ current control



Pressing and holding the *up*-button (**current control button**) the display shows the present current and the [mA] symbol.

(See also flow diagram in figure 9)

### ☞ limit view menu

(Only for indicators with the alarm monitoring option)

One touch on the *right*-button starts the limit view menu.

(See also flow diagram in figure 9)

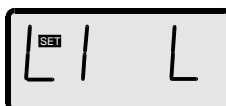
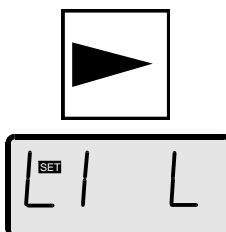

The display [limit low] appears on the screen. Press the *enter*-button to watch the value of the lower limit.



For passing the low limit press the *right*-button. The menu changes to the high limit. The screen shows now [limit high]. Confirm with the *enter*-button to display the value of the upper limit. Pressing the *right*-button for a second time quits the limit view menu and returns to normal state.

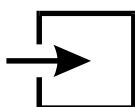

During watching the limit values it is possible to manipulate them by pressing the *enter*-button. The view changes to the

- ☑ Edit mode.



A blinking segment appears below the sign place. Pressing the *right*-button selects the figure and the *up*-button increments the selected figure. To accept the new limit value, press the *enter*-button.

(See also flow diagram in figure 13)

- ☑ Code protection



Before the menu gets to the edit mode the **code 2** must be entered, to **prevent a modification by unauthorised persons**. Entering a wrong code word stops the limit view menu immediately.

The default code 2 is [0002].



### Note

The interrogation of **code 2 can be switched off** by modifying the code 2 to **[0000]**. For this reason the flow diagram shows the code interrogation in stroked dots.

## 4.3.1 How to set the parameters

- ☑

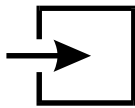

(See also flow diagram in figure 11)

Back in the normal state of the indicator we start the

- ☞ Input menu

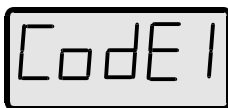

by pressing the *enter*-button.

The **configuration of the indicator is protected** against manipulations by unauthorised persons with the **code 1**. To get the input menu enter the code 1 default [0001]. It's **impossible to switch off the code 1** interrogation.

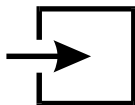

After entering the right code word the indicator proposes to join the



**Scale menu.** The figure on the left hand appears on the screen. To scale the **measured current**, the **bargraph** and to **set the decimal point** join the scale menu by confirming with the *enter*-button.

See also flow diagram in figure 12).

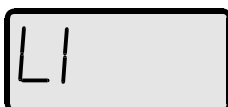

To pass the scale menu press the *right*-button. The following sub menu is called **limit menu**. This menu is naturally only available for indicators with the alarm monitoring option.

In the limit menu the user enters the limits, as well as the hysteresis and the time delay of the alarm outputs.

(See also flow diagram in figure 15)



The next two following items allow to manipulate the words for code 1 and code 2. The *enter*-button confirms the input and the corresponding code appears in edit mode.



Remember that the code word [0000] switches off the code 2.



Finally it's possible to calibrate the indicator with the following sub menu called calibration menu.

(See flow diagram in figure 16)



**Caution**

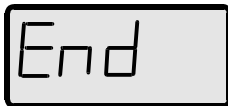

The indicator is already calibrated ex-works.

**In general, a further calibration is not necessary and only experienced persons are allowed to calibrate it. False calibration will result senseless Indication.**

To start calibration enter the code word 01234.

Now we reach the end of the input menu. Confirm the end with the *enter*-button. The indicator switches back to normal state.

If you want to repeat the input menu, press the *right*-button.



**Note**

If an invalid value is entered for any of the parameters, you will not be able to quit the input menu. Instead, the program switches automatically into edit mode to the found valid value.

### 4.3.2 Hysterese and time delay setting

#### Hysterese

A hysteretic curve prevents an unwanted fast switching of the alarm outputs.

The switching behavior of the low alarm (min) shows figure 6. The switching behavior of the high alarm (max) shows figure 7.

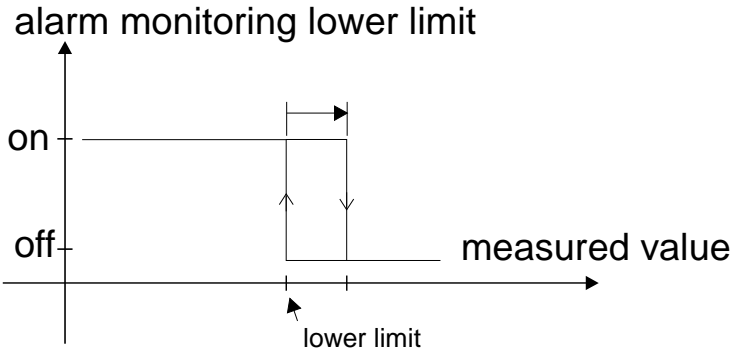

Figure 6: Hysteric curve low alarm

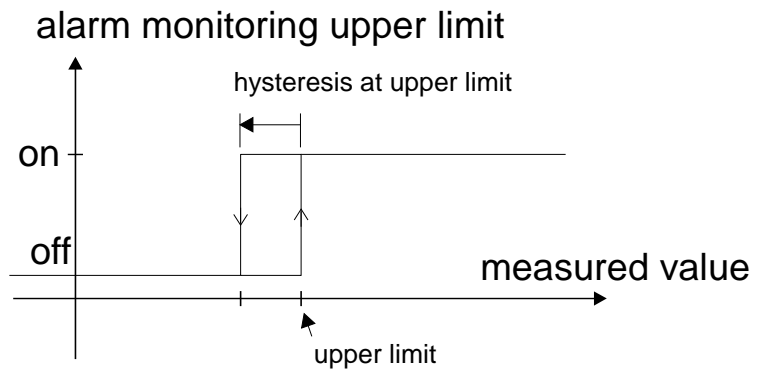

Figure 7: Hysteric curve high alarm

#### Time delay

The span of time ' $t_e$ ' is the difference between the first exceeding of the measurement above the upper limit and the switching of the high alarm (For the low alarm exists an analogous ' $t_e$ ').

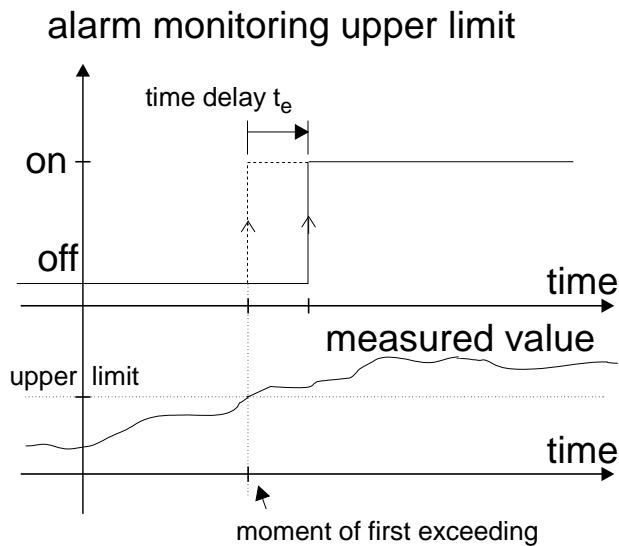

Figure 8: Time delay max respectively min

Note

If the measured current falls below the high limit during ' $t_e$ ', the  $t_e$ -timer resets.



## 4.4 Configuration example

See the following example of a temperature measurement for a successful parameter input.

### Situation

- desired range: +10°C ... 20°C
- sensor range: -20.0°C ... +30.0°C

### Adjustment

- |                           |   |
|---------------------------|---|
| 1] Measure range:         | -20,00 °C ... + 30,00°C<br>for 4 ... 20 mA            |
| 2] Bargraph:              | -5°C ... + 25°C                                       |
| 3] Limits:                | lower limit (min): +10°C<br>upper limit (max.): +20°C |
| 4] Hysterese:             | 0,5°C low and high limit                              |
| 5] Alarm monitoring mode: | circuit-opening connection                            |
| 6] Time delay:            | 15 seconds  |

### Procedure:

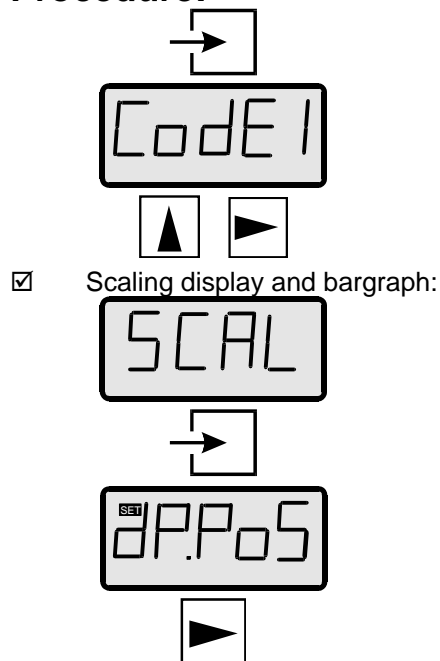

One touch on the enter-button quits the normal state and starts **the input menu**.

The menu interrogates for code 1.  
The default code 1 is [0001].

Enter the right code word using the arrow buttons.  
Finally hit the *enter*-button.

Join the scale menu pressing the *enter*-button.

First set the position of the decimal point. The position of the decimal point will be used for each parameter, like display, bargraph and limits.

Set the decimal point position after the second position, because we will enter [2000] for the high scale point afterwards.

Fortunately the default setting is on the desired position, so we can pass the item pressing the *right*-button.



Now the [scale point low] view appears.  
Confirm by pressing the *enter*-button and enter the **lower scale point** (-20°C) as follows:

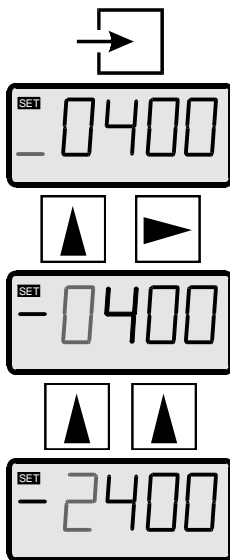

Choose the negative sign pressing the *up*-button.

Touch the *right*-button to select the first figure.  
Now hit the *up*-button two times ...

... and the figure '2' will be adjusted.

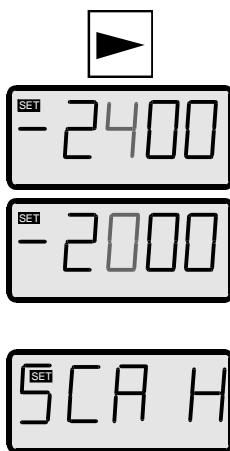

Press the *right*-button to select the next figure.

Hit the *up*-button until the figure '0' appears.

Confirm the lower scale point pressing the *enter*-button. Now the...

... item appears.

Repeat the input procedure for the upper scale point like the lower scale point. Enter [3000] for the upper scale point.  
(Confirm by hitting *enter*-button)

Enter the upper scale point correct figured 'as big as possible' (the first figures should not be '0')  
In this case you get most precision of the indicator.



### Note



Now scale the bargraph. Hit the *enter*-button.

Enter [-0500] (-5°C) for the lower bargraph scale point.  
Confirm by hitting the *enter*-button  
Enter [2500] (25°C) for the upper bargraph scale point.

Hitting *enter*-button accepts and quits the scale menu.

### Limits, Hysteretic curve and time delay

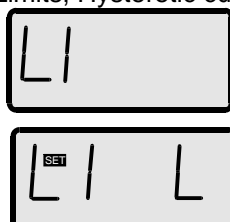

Start limit menu by pressing the *enter*-button.

Press the *enter*-button for a second time and enter [1000] (10°C) for the **lower limit** using the arrow buttons.  
Confirm by hitting the *enter*-button.  
(Remember, that the decimal point position is already set)

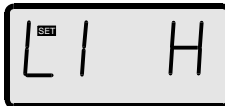

Press the *enter*-button and enter **[2000] (20°C)** for the **upper limit**.

Confirm by hitting the *enter*-button.



To select the **hysteresis of the lower limit** press the *enter*-button.

Now enter **[0050] (0,5°C)** using the arrow-buttons and confirm with the *enter*-button.



To select the **hysteresis of the upper limit** press the *enter*-button.

Now enter **[0050] (0,5°C)** using the arrow-buttons and confirm with the *enter*-button.

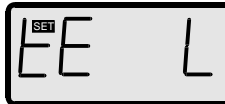

Now press *enter*-button to activate the time delay.

Enter **[0015]** (15 seconds) for both limits.

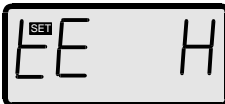

Confirm by hitting the *enter*-button.



Now define the circuit-opening connection first for the low alarm limit.

Choose the circuit-opening connection **[nc---**] (normal closed) using the *up*-button and confirm by pressing *enter*-button.



Define the circuit-opening connection for the upper alarm monitor by the same procedure.

Confirm by hitting the *enter*-button and quit the limit menu.

We pass simply the following menu items (manipulate code words and calibrate) using the *right*-button.

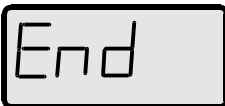

Finally quit the scale menu hitting the *enter*-button.

The indicator is back in normal state. The changes are immediately active and will be stored after turn off (disconnecting the indicator).

## 5 Flow charts

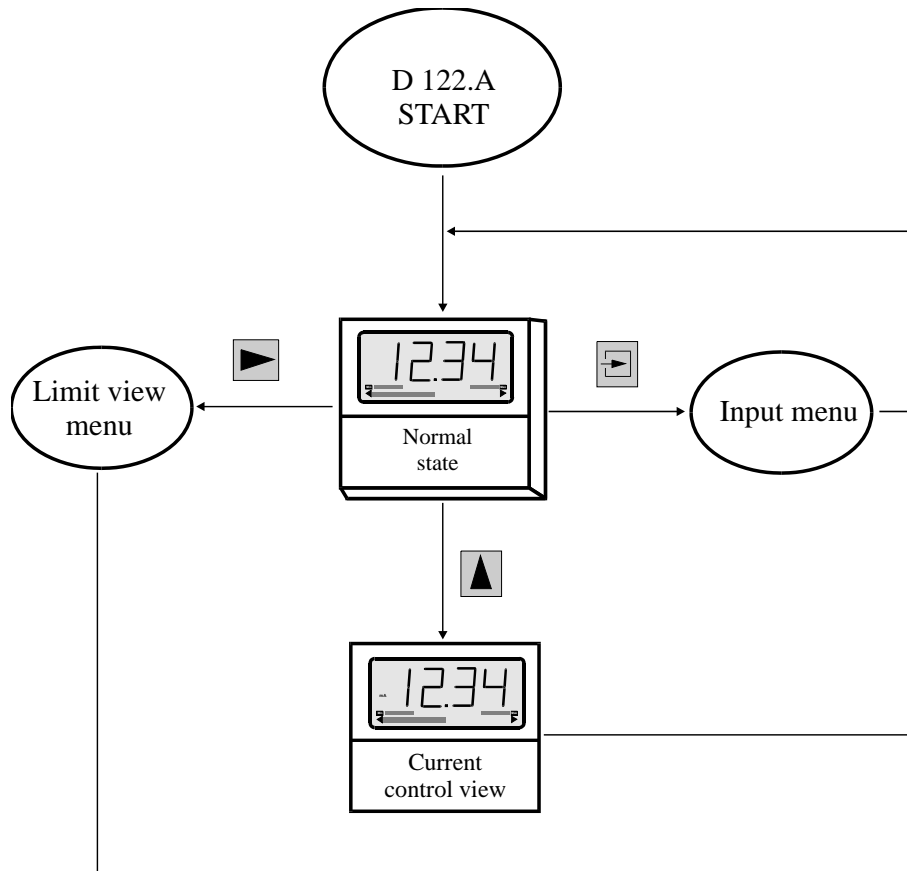

Figure 9: Flow diagram normal state

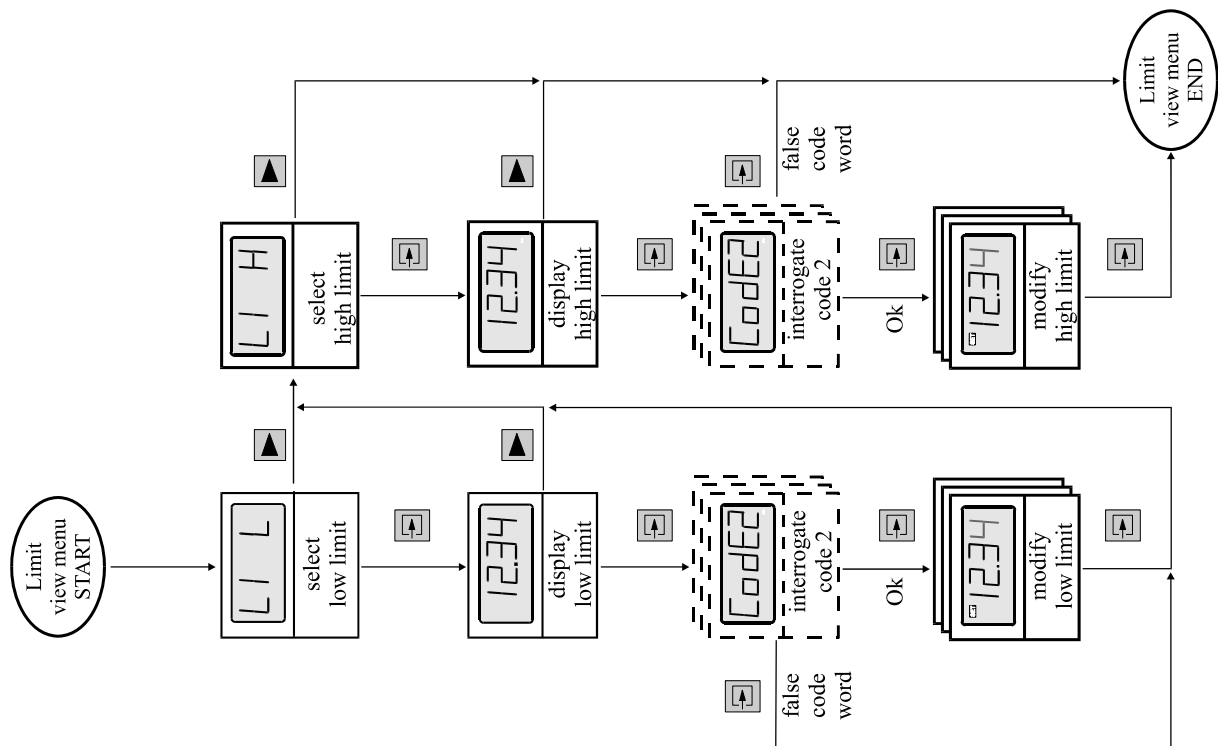

Figure 10 Flow diagram limit view

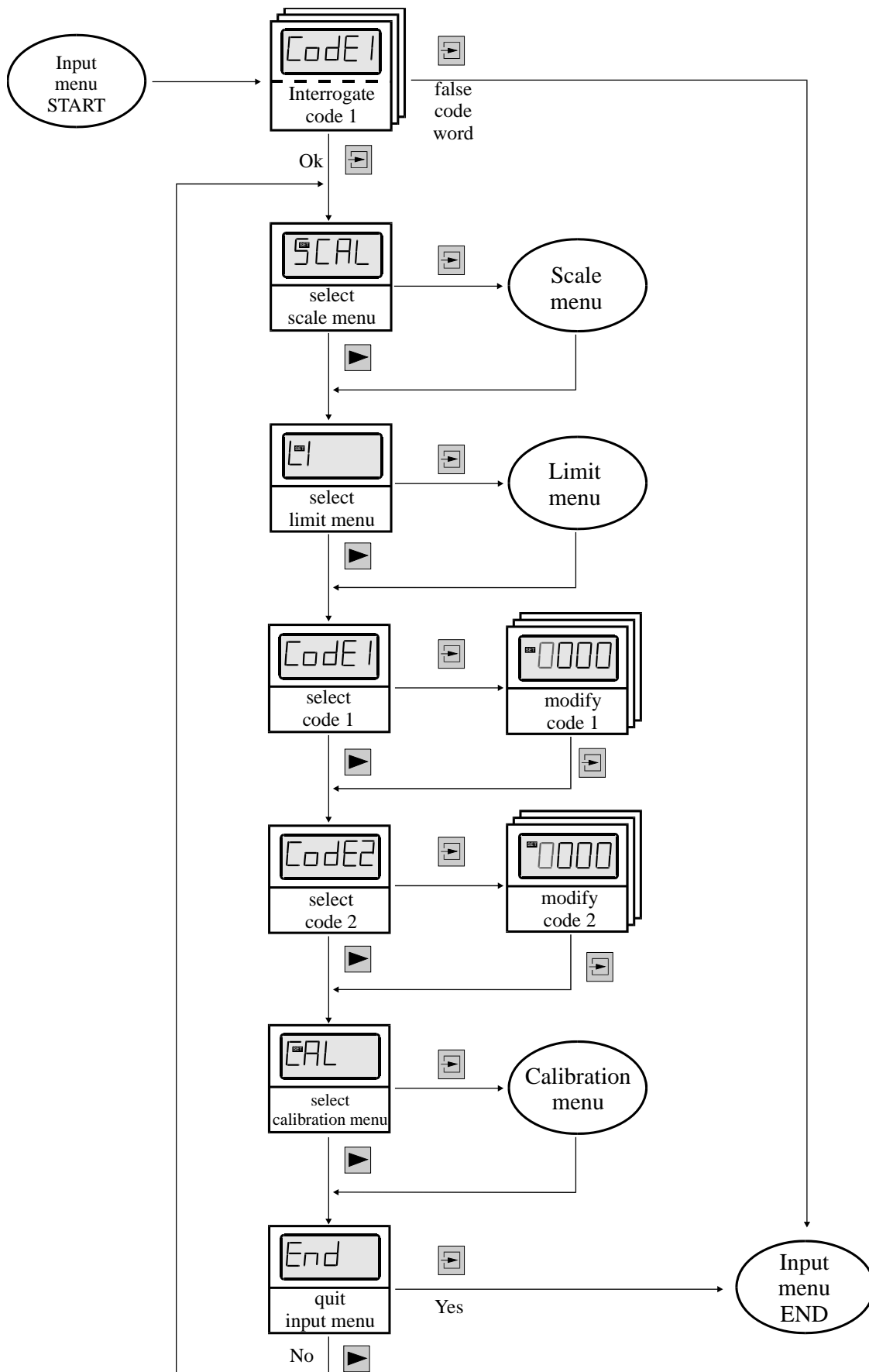

Figure 11: Flow diagram input menu

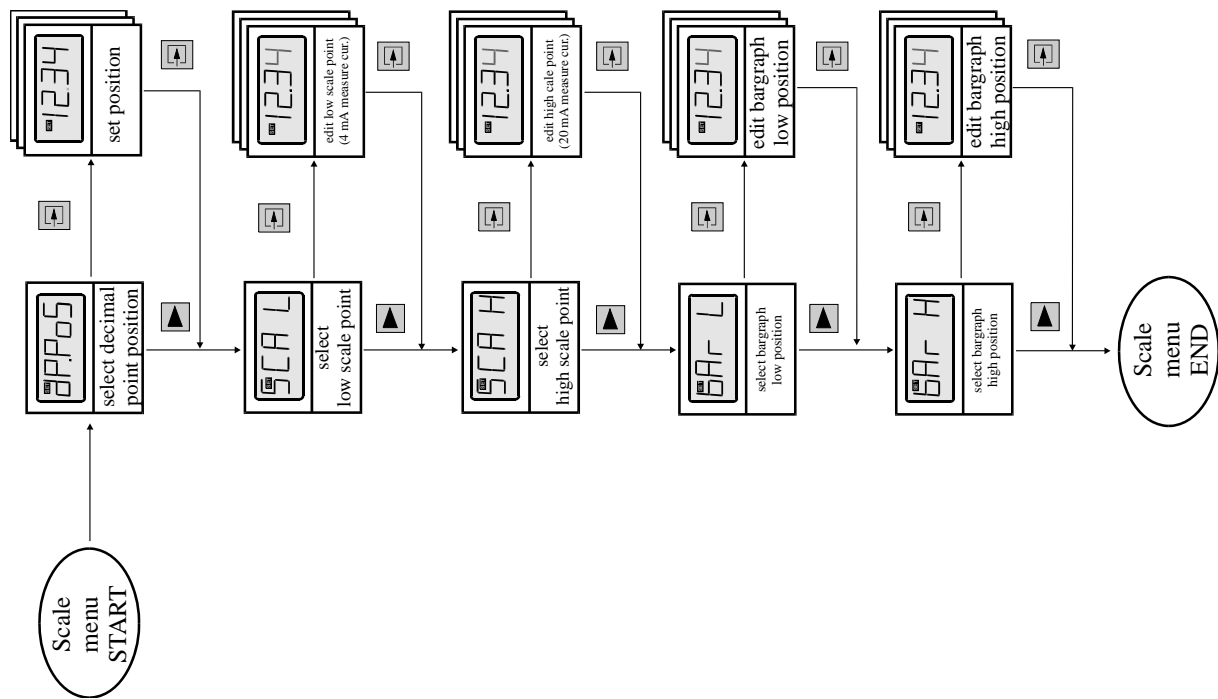

Figure 12: Flow diagram scale menu

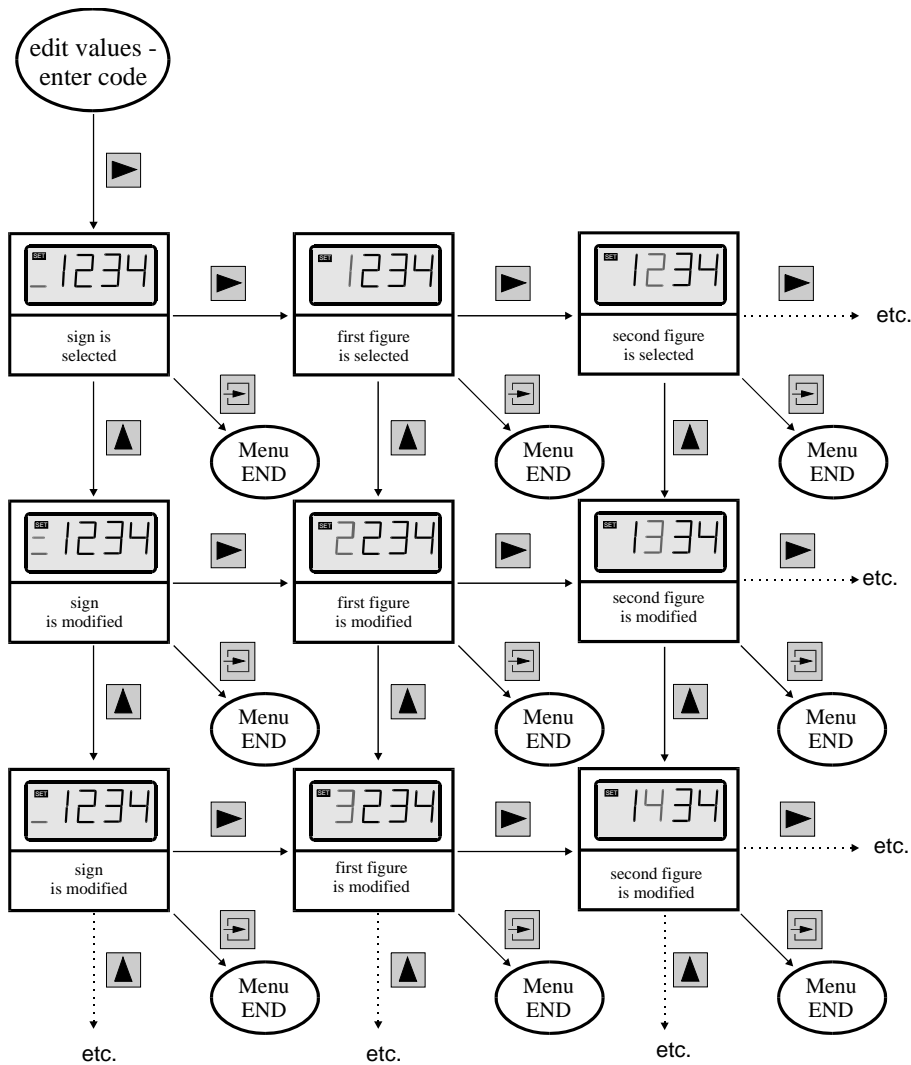

Figure 13: Flow diagram edit mode

Alternative (extended) scale menu for special software option only

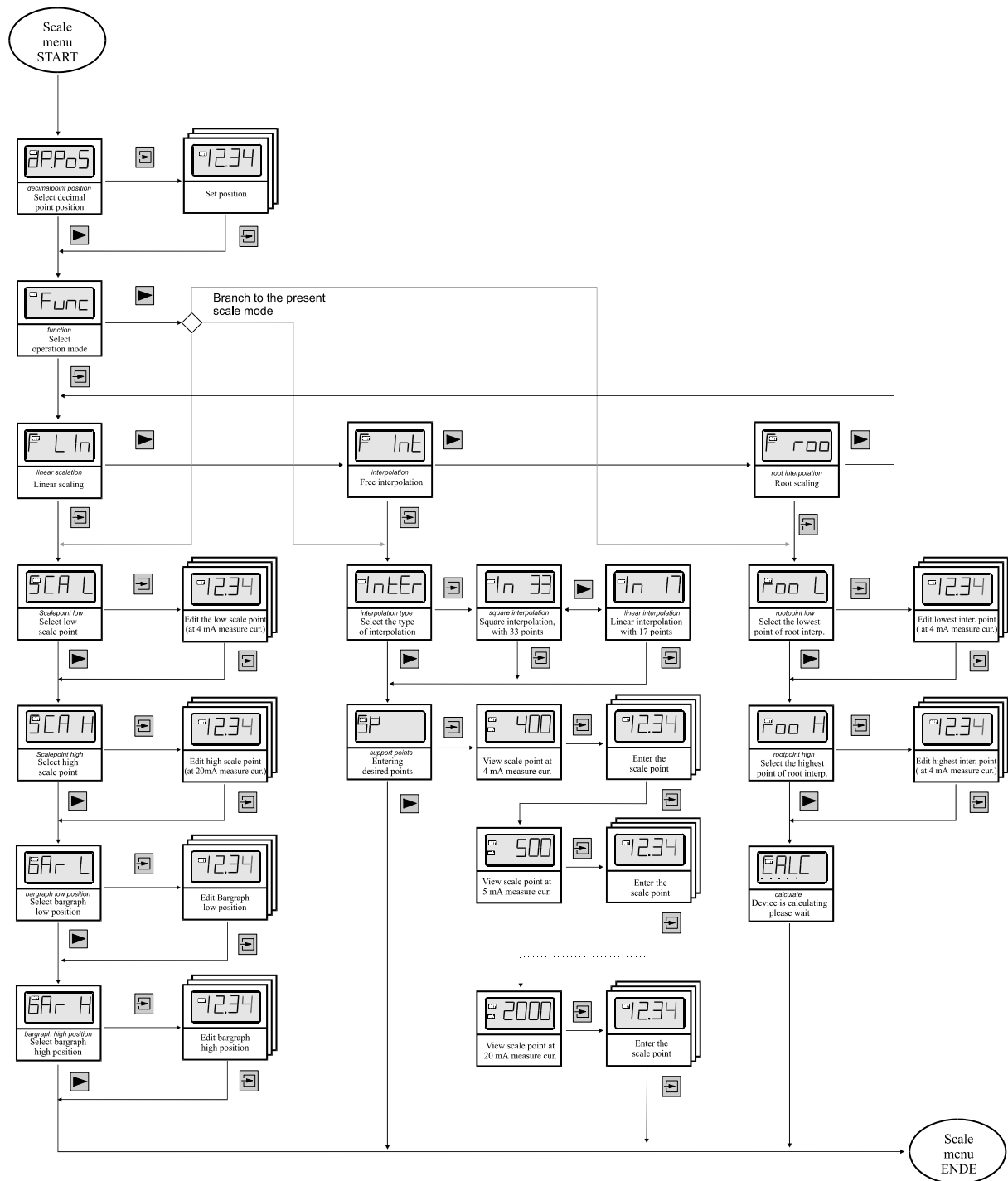

Figure 14: Flow diagram extended scale menu

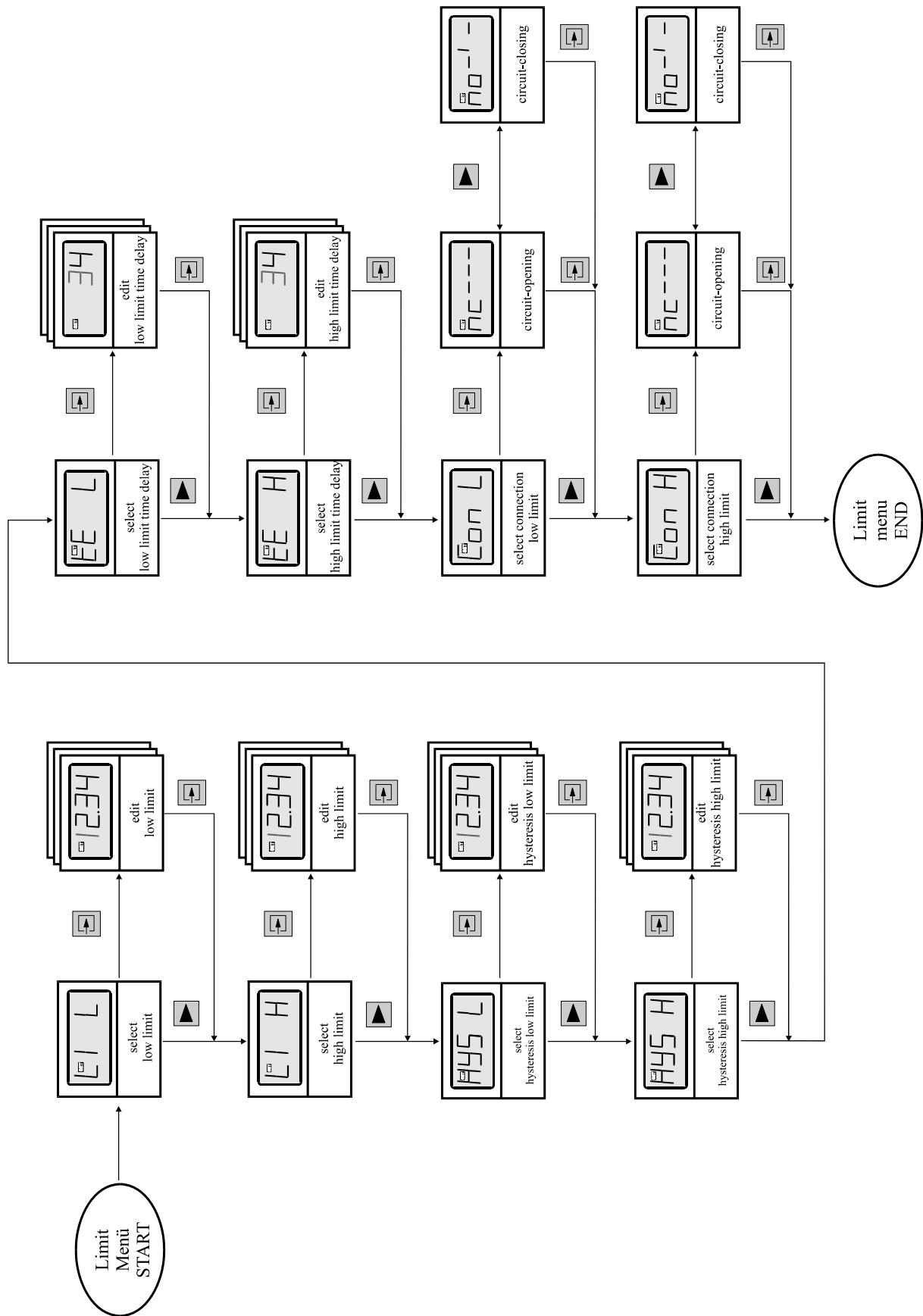

Figure 15: Flow diagram limit menu



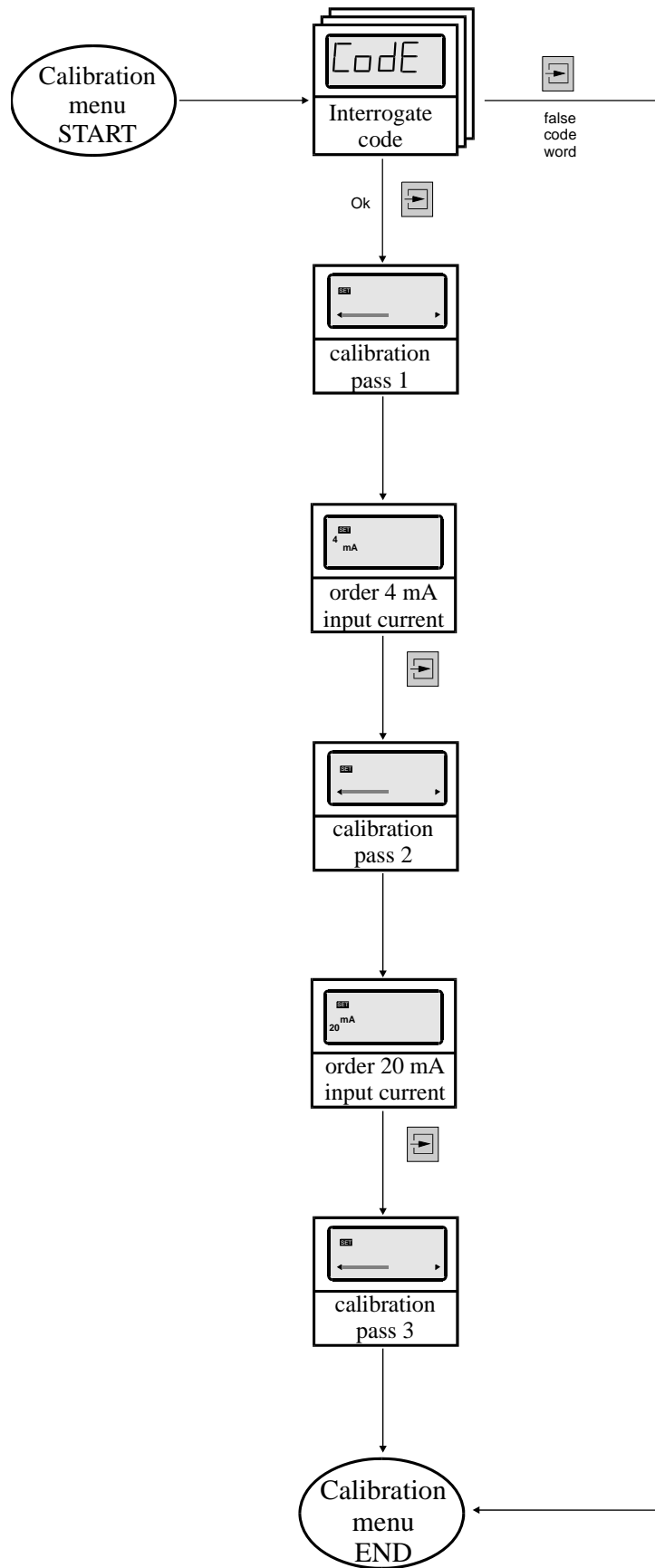

Figure 16: Flow diagram calibration menu

## 6 Annex

### 6.1 Specifications

	D122			
	D122.A.0	D122.A.3	D122.A.5	D122.A.6
Display	4½ -digit seven-segment LCD			3½-digits
Digit height	15mm	30mm	30mm	50mm
Display range	-19999 ... +19999			-1999 ... +1999
Dimension symbols	Selectable with defined symbols			
Decimal points	Selectable by keyboard			
Bargraph	41 segments			/
Alarm limits display Versions D122.A.□.2	- Via bargraph - Flashing 'max.' or 'min' display			
Alarm limit monitoring Version D122.A.□.2	By means of intrinsically safe control circuits (e.g. NAMUR or DIN 19234)			
Current control button	Direct display of current in measurement circuit			
Measurement circuit	Intrinsically safe measurement circuit 4 ...20 mA; Voltage drop ca. 1V			
Measurement circuit limits	No-load Voltage $U_i \leq 65$ V; short-circuit current $I_k \leq 160$ mA Internal inductance: $\leq 40$ $\mu$ H; Internal capacitance: $\leq 10$ nF, see certificate TÜV 99 ATEX 1488			
Limits with zener barrier option	$U_M = 250$ V see certificate TÜV 99 ATEX 1488			
Alarm monitoring limits	By intrinsically safe control circuits No-load Voltage $U_i \leq 30$ V; Short-circuit current $I_i \leq 160$ mA $P_{max}$ not greater than 850 mW; Internal inductance: $\leq 40$ $\mu$ H Internal capacitance is negligible, see certificate TÜV 99 ATEX 1488			
Explosion protection	Ex ib IIC T6 Gb at ambient temperature 45°C or Ex ib IIC T5 Gb at ambient temperature 60°C			
Housing	Acc. to control-panel standard DIN 43700		-	
Protection class	Front panel 40 up to IP 65		IP 65	
Dimensions HxWxD [mm]	48x96x62	72x144x80	134x138x64	138x184x64
Material	glass fibre strengthened Noryl		ABS	
Measuring error	0,1% $\pm$ 2 digits referring to measure range			
Temperature coefficient	< 0,01% of measure range / K			
Ambient temperature limit	-10°C ...+45°C for temperature class 6 or -10°C ...+60°C for temperature class 5 Indicators for -20°C ambient temperature on inquiry			

## 6.2 Type code

Device series D122		.	.	.
Device: Indicator .....		<b>.A</b>		
Indicator with curve fitting option .....		<b>.AS</b>		
Totalizer .....		<b>.Z</b>		
Totalizer with curve fitting option .....		<b>.ZS</b>		
Housing: Control panel housing 48 x 96 mm .....		<b>.0</b>		
Control panel housing 72 x 144 mm .....		<b>.3</b>		
Field housing (30 mm figure height) .....		<b>.5</b>		
Field housing (50 mm figure height) .....		<b>.6</b>		
Digital output: without .....			<b>.0</b>	
with 2 digital outputs .....			<b>.2</b>	
with reset input and pulse output .....			<b>.3</b>	
Additional option:				
Internal zener barrier <sup>1</sup> .....				<b>.BM</b>
Internal two wire readings recorder <sup>2</sup> .....				<b>.MU</b>



1: Not suitable for D122.x.0.x.x

2: For flied housings only, a combination with internal zener barrier (.BM) is not possible

## 6.3 Material specification

Device type	Material	manufacturing process
D122.x.0.x.x	Noryl	injection die casting
D122.x.3.x.x	Noryl	injection die casting
D122.x.5.x.x	ABS	injection die casting
D122.x.6.x.x	ABS	injection die casting
D122.x.7.x.x	Aluminum	die-casting

## 6.4 Marking

  0044	Marking according to 50014 ff	Marking according to EN 60079:2010
D122.x.x.x.0 D122.x.x.x.MU	II 2 G; EEx ia IIC T6 bei Ta bis 45°C II 2 G; EEx ia IIC T5 bei Ta bis 60°C	II 2 G; Ex ia IIC T6 Gb bei Ta bis 45°C II 2 G; Ex ia IIC T5 Gb bei Ta bis 60°C
D122.x.x.x.BM	II 2 G; EEx ia [ib] IIC T6 bei Ta < 45°C II 2 G; EEx ia [ib] IIC T5 bei Ta < 60°C	II 2 G; Ex ia [ib] IIC T6 Gb bei Ta < 45°C II 2 G; Ex ia [ib] IIC T5 Gb bei Ta < 60°C

## 6.5 Failure messages

At startup:

Message	Symptom	Bug-fix
<b>Error 1</b>	Error, general device fault	Turn off and turn on the device, if the fault remains, send the device back to Gönneheimer

## 6.6 Transport, Storing, Repairs und Disposal

<b>Transport</b>	Vibration-free in origin package, do not pitch, handle carefully
<b>Storing</b>	Store the device dry, inside of the origin package
<b>Disposal</b>	When the explosion proof multipurpose distribution, switching and control units are eventually disposed of, the national regulations governing the disposal of waste materials in the country concerned must be rigorously observed.
<b>Repairs</b>	Defective parts may only be replaced by the Manufacturer or by personnel specially trained and supervised by the Manufacturer. Only genuine spare parts from the Manufacturer may be fitted.

## 6.7 Dimensions

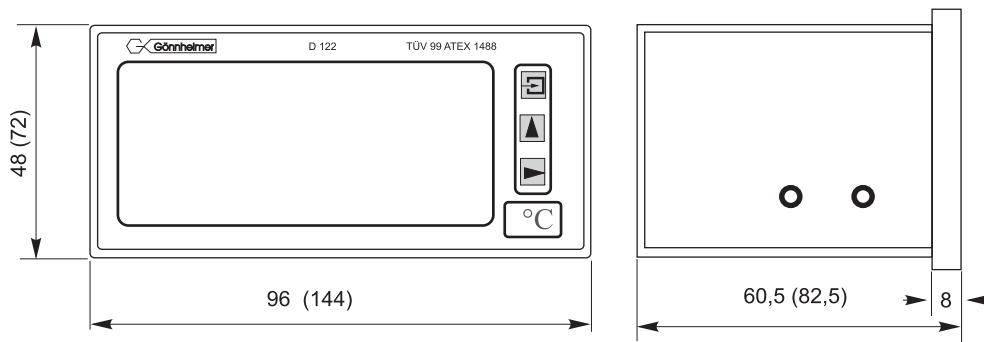

Figure 17: Control panel housing

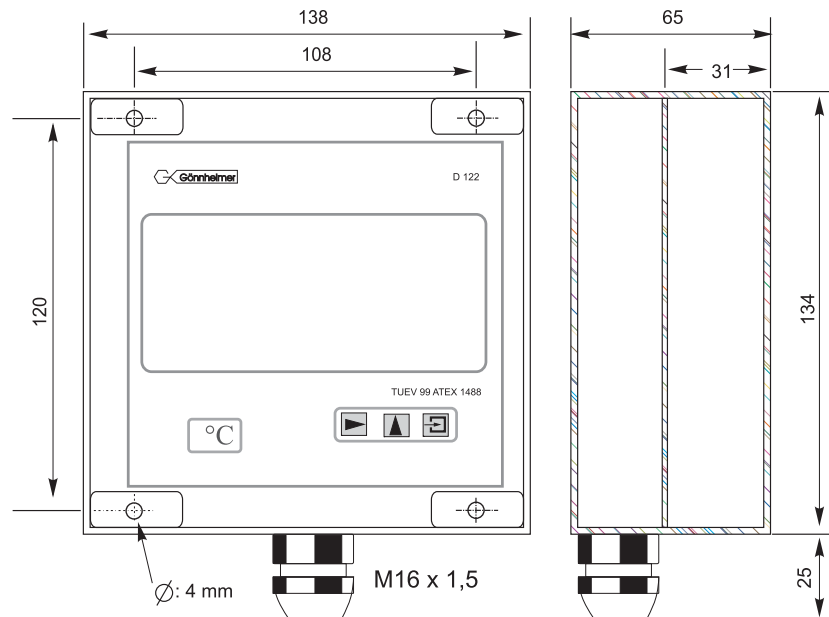

Figure 18: Field housing

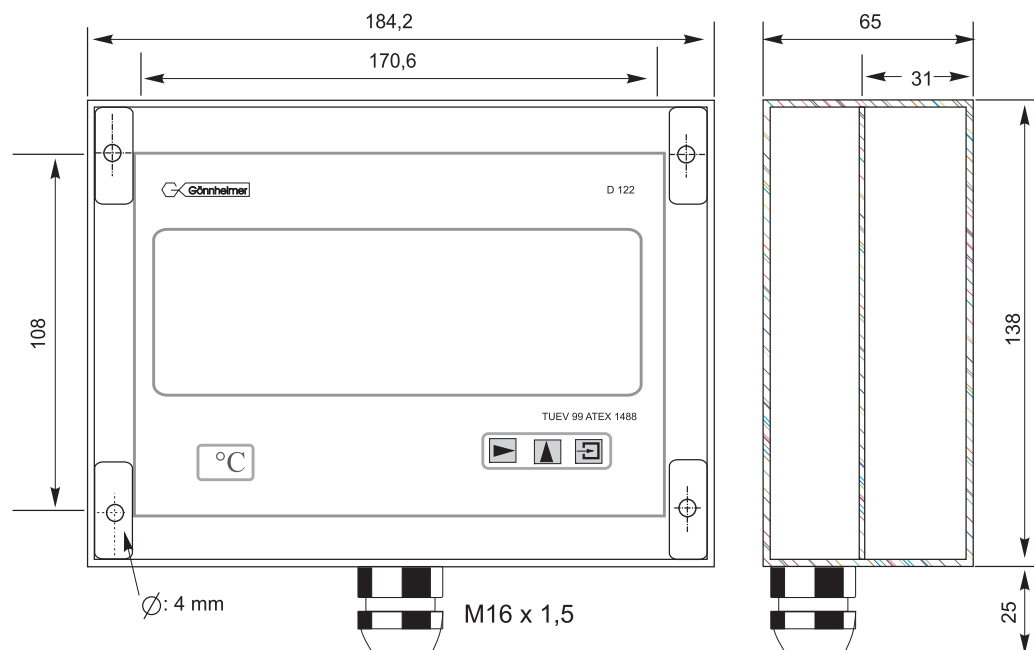

Figure 19: Field housing

## 6.8 List of Parameters

The customer is free to use this chart for archiving the parameters of his indicator D122.

Parameter	Description	Previous Display	Value
<b>Scale menu</b>			
Decimalpoint position		dP.PoS	0 0 0 0
Low scale point	Display at 4 mA input current	SCAL L	
High scale point	Display at 20 mA input current	SCAL H	
Bargraph low position	Display at starting bargraph	bAr L	
Bargraph high position	Display at full bargraph	bAr H	
<b>Limit menu</b>			
Low limit		LI L	
High limit		LI H	
Hysteresis of low limit		HYS L	
Hysteresis of high limit		HYS H	
Alarm connection of low limit	Choice between normal open (no) and normal closed (nc)	Con L	nc no
Alarm connection of high limit	Choice between normal open (no) and normal closed (nc)	Con H	nc no
Code word Nr. 1		CodE 1	
Code word Nr. 2		CodE 2	
<b>Only on Option Sondersoftware</b>			
Low scale point root function	Display at 4 mA input current	roo L	
High scale point root function	Display at 20 mA input current	roo H	

**Linear resp. square Interpolation**

	Choice between linear or square Interpolation	INTER	In 33	In17
Setpoint		400		
		450		
		500		
		550		
		600		
		650		
		700		
		750		
		800		
		850		
		900		
		950		
		1000		
		1050		
		1100		
		1150		
		1200		
		1250		
		1300		
		1350		
		1400		
		1450		
		1500		
		1550		
		1600		
		1650		
		1700		
		1800		
		1850		
		1900		
		1950		
		2000		

## 6.9 Index

### A

alarm limit monitoring 26

### C

closed-circuit connection 5, 17  
code protection 14  
configuration 13  
current control 13  
current control button 12

### D

decimal point 17  
dimension symbol 9

### E

ex works 11

### H

hardware-reset 11

hysteresis 5, 11, 14, 17

### L

limit high 13  
limit view menu 13  
lower scale point 17

### N

NAMUR 26  
Noryl 26

### P

parameter entering 14  
precision 18

### T

temperature 26  
time delay 16

---





(1) **EC- TYPE- EXAMINATION CERTIFICATE**  
(Translation)

(2) Equipment and protective systems intended for use in potential explosive Atmospheres – **Directive 94/9/EC**

(3) EC- type- examination Certificate number

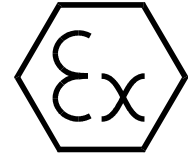

**TÜV 99 ATEX 1488**

(4) Equipment: Digital Indicator Type D122...

(5) Manufacturer: Gönzheimer Elektronik GmbH

(6) Address: D-Neustadt an der Weinstraße

(7) This equipment and any acceptable variation thereto are specified in the schedule to this certificate and the documents therein referred to.

(8) The TÜV Hannover/Sachsen-Anhalt e.V., TÜV CERT-Zertifizierungsstelle, notified body No. 0032 in accordance with Article 9 of the Council Directive 94/9/EC of March 1994, certifies that equipment has been found to comply with the Essential Health and Safety Requirements relating to the design and construction of equipment and protective systems intended for use potentially explosive atmospheres, given in Annex II to the Directive.

The examination and test results are recorded in the confidential report No. 99/PX24090

(9) Compliance with to essential Health and Safety Requirements has been assured by compliance with:

**EN 50 014:1997 EN 50 020:1994 EN 50 028:1988**

(10) If the sign "X" is places after the certificate number, it indicates that the equipment is subject to special conditions for safe use specified in the schedule to this certificate.

(11) This EC- type- examination Certificate relates only to the design and construction of the specified equipment in accordance with Directive 94/9/EC. Further requirements of this Directive apply to the manufacture and supply of this equipment.

(12) The marking of the equipment shall include the following:

 **II 2 (1) G EEx ia IIC T6 bzw. EEx m [ib] IIC T6**

TÜV Hannover/Sachsen-Anhalt e.V.  
TÜV CERT-Zertifizierungsstelle  
Am TÜV 1  
D-30519 Hannover

Hannover, 02.11.1999



Der Leiter



(13)

## SCHEDULE

(14) EC- TYPE-Examination CERTIFICATE No. TÜV 99 ATEX 1488

(15) Description of equipment

The digital indicator type D122 ... serves as direct indicator of measured values of intrinsically safe 4 ..20 mA current circuits in explosive endangered areas.

The maximum ambient temperature is 45°C in temperature class T6 and 60°C in the temperature class T5.

### Electrical details

Supply and  
signal current  
circuit  
(Terminal 1,2)

Exclusive connection to a certificated intrinsically safe current circuit with the following highest values:

$U_i = 65 \text{ V}$   
 $I_i = 160 \text{ mA}$

Effective internal inductivity 40  $\mu\text{H}$   
Effective internal capacity 10 nF

### Only Type D122.T.x.x.x

Supply and  
signal current  
circuit  
(Terminal 1,2)

Exclusive connection to a certificated intrinsically safe current circuit with the following highest values:

$U_i = 30 \text{ V}$   
 $I_i = 160 \text{ mA}$   
 $P_i = 1,6 \text{ W}$

Effective internal inductivity 40  $\mu\text{H}$   
effective internal capacity 10 nF

Terminals 3,4

Bridget

### Only TYP 122.x.x.x.BM with additional protection type moulding and the sign EEx m [ib] IIC T6 bzw. EEx m [ib] IIC T5

Input current  
circuit (wire)

$U_m = 250 \text{ V}$  and to connect to ground



Schedule EC- Type- Examination Certificate No. TÜV 99 ATEX 1488

---

### Any types

Alarm current circuits (Terminal 5,6; 7,8) Outputs:	Exclusive connection to a certificated intrinsically current circuit with the following highest values each current circuit:  $U_i = 30 \text{ V}$ $I_i = 160 \text{ mA}$ $P_i = 850 \text{ mW}$
Inputs:	$U_i = 30 \text{ V}$  Effective internal inductivity $\leq 40 \mu\text{H}$ the effective internal capacity is negligibly small

All current circuits are safe galvanically separated up to a nominal voltage of 90 V to each other. The input current circuit by the type D122.x.x.x.BM is internally connected to the supply and signal circuit.

- (16) Report No. 99/PX24090
- (17) Special conditions for safe area  
None
- (18) Essential health and safety requirements  
No additional



# 1. Amendment to the Conformity Certificate Nr. TÜV 99 ATEX 1488

Manufacturer: Gönzheimer Elektronik GmbH  
Dr.-Julius Leber-Str.2  
D-67433 Neustadt/Weinstraße

The digital indicator type D122 can also be manufactured according to the examination protocol, listed in the associated examination certificate.

The changes concern the enlargement around the type D122.x.7.x.x. and the application of type in explosion areas by dust up to ambient temperatures of 65°C. The marking for it is:

**II 2 D IP 65 T70°C**

Bases of the standards: EN 50281 1 1:1999

The electric data and all other information are valid consistently for this supplement.

The test documentation is listed in test report Nr. 04YEX551218

TÜV NORD CERT GmbH & Co. KG

Hannover, 17.02.2004

TÜV CERT-Zertifizierungsstelle  
Am TÜV 1  
0-30519 Hannover  
Tel.: 0511 986-1470  
Fax: 0511 986-2555

Der Leiter



## 2. Amendment to the Conformity Certificate Nr. TÜV 99 ATEX 1488

Manufacturer:           Gönzheimer Elektronik GmbH  
                               Dr.-Julius Leber-Str.2  
                               D-67433 Neustadt/Weinstraße

The digital indicator type D122 can also be manufactured according to the examination protocol, listed in the associated examination certificate. The change concerns the enlargement around the types D122.PA.7.0.0 and D122.FF.7.0.0 for the binding to intrinsically safe field busses Profibus PA respectively FF.H1.

The application of the supplemental types can occur in explosion-threatened areas, Which requires devices of the category 2. By the application in areas of explosion-threatened by dust, the at most allowed ambient temperature is +65°C.

By the application in areas explosion-threatened by gas is the maximum ambient temperature depending on the temperature class according to the following table:

Temperature classe	Ta
T6	Up to 45°C
T5	Up to 60°C

### Electrical data of the types D122.PA.7.0.0 and D122.FF.7.0.0

Signal and power supply circuit  
(terminal 1,3 and 2,4)

Ex- protection Intrinsically safe EEx ia IIC  
only to the connection in certified intrinsically  
safe circuits. Maximum ratings:

$$U_0 = 30 \text{ V}$$

$$I_0 = 660 \text{ mA}$$

$$P_0 = 1,6 \text{ W}$$

max reactances

$$L_0 = 0 \text{ } \mu\text{H}$$

$$C_0 = 0 \text{ nF}$$

The electrical data remains unchanged.

2. Amendment to the Conformity Certificate Nr. TÜV 99 ATEX 1488

---

The marking of the equipment:

 **II 2 (1) G EEx ia IIC T6 or T5; resp. II 2 D IP65 T70°C**

The marking of the further types remain unchanged.

The digital indicator type D122... according to the EC-type certificate TÜV 99 ATEX 1488 incl. 1. and this 2nd supplement also fulfils the demands of

EN 50 014 :1997 + A1+A2	General directives
EN 50 020:2002	Intrinsically safe "i"
EN 50 281-1-1:1998+A1	Electrical devices with protection by case - construction and check

All remaining data remain unchanged for this 2. Amendment.

The test documentation is listed in test report Nr. 04YEX551692

TÜV NORD CERT GmbH & Co. KG

Hannover, 03.11.2004

TÜV CERT-Zertifizierungsstelle  
Am TÜV 1  
0-30519 Hannover  
Tel.: 0511 986-1470  
Fax: 0511 986-2555

Der Leiter



### 3. Amendment

**to certification number:** TÜV 99 ATEX 1488

Device: Digital indicator type D122...  
 Manufacturer: Gönzheimer Elektronik GmbH  
 Dr.-Julius Leber-Str.2  
 Address: D-67433 Neustadt/Weinstraße  
 Germany  
 Order Number: 8000553381  
 Date of issue: 10.10.2006

**Changes:**

The digital indicator type D122 can also be manufactured according to the examination protocol, listed in the associated examination certificate. The change concerns the enlargement around the types D122.PA.7.0.3K and D122.FF.7.0.3K for the binding to intrinsically safe field busses Profibus PA respectively FF.H1 as a three channel indicator.

The application of the supplemental types can occur in explosion-threatened areas, which requires devices of the category 2. By the application in areas of explosion-threatened by dust, the at most allowed ambient temperature is +65°C.

The information to the allowed ambient temperature is valid consistently accordingly of the second supplement also for the supplemental types.

The electric data of the second supplement are changed as follows or complemented:

Electric data of the types D122. PA.7.0.0, D122.FF 7.0.0, D122. PA.7.0.3K and D122.FF.7.0.3K:

<p>Signal and power supply circuit (terminal 1,3 and 2,4)</p>	<p>By the application in by gas explosion-threatened areas in Ex protection Intrinsically safe EEx ia IIC.</p> <p>Field device FISCO to the connection with a device according to the FISCO model or</p> <p>Only to the connection in certified intrinsically safe circuits. Maximum ratings:</p> <p><math>U_0 = 30 \text{ V}</math>  <math>I_0 = 660 \text{ mA}</math>                  max reactances      <math>L_0 = 0 \text{ } \mu\text{H}</math>  <span style="margin-left: 150px;"><math>C_0 = 0 \text{ nF}</math></span></p> <p>By the application in by dust explosion-threatened areas max. limit input power</p> <p><math>P_0 = 1,6 \text{ W}</math></p>
---	---

The electrical data remains unchanged.



---

### 3. Amendment to the Conformity Certificate Nr. TÜV 99 ATEX 1488

---

The marking of the equipment:

 **II 2 (1) G EEx ia IIC T6 or T5; resp. II 2 D IP65 T70°C**

The marking of the further types remain unchanged.

The digital indicator type D122... according to the EC-type certificate TÜV 99 ATEX 1488 incl. 1. and this 2nd supplement also fulfils the demands of

EN 50 014 :1997 + A1+A2	General directives
EN 50 020:2002	Intrinsically safe "i"
EN 50 281-1-1:1998+A1	Electrical devices with protection by case - construction and check
DIN EN 60079-27:2006	Concept for intrinsically safe field bus systems (FISCO) and concept for non sparking field bus systems (FNICO)

The test documentation is listed in test report Nr. 06 YEX 553381.

(17) Special conditions for safe area

None

(18) Essential health and safety requirements

No additional

TÜV NORD CERT GmbH, Langemarckstraße 20, 45141 Essen, akkreditiert durch die Zentralstelle der Länder für Sicherheitstechnik (ZLS), Ident. Nr. 0044, Rechtsnachfolger der TÜV NORD CERT GmbH & Co. KG Ident. Nr. 0032

Der Leiter der Zertifizierungstelle

Schwedt

Geschäftsstelle Hannover, Am TÜV 1, 30519 Hannover, Tel.: +49 (0) 511 986-1455, Fax: +49 (0) 511 986-1590



# EG-Konformitätserklärung

Declaration of conformity / Déclaration de conformité

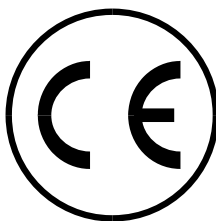

Communauté Européenne

Anbieter: Supplier: Fournisseur	<b>Gönzheimer Elektronik GmbH</b>
---------------------------------------	-----------------------------------

Anschrift: Address: Adresse:	Gewerbegebiet Nachtweide Dr.-Julius-Leber-Straße 2 67433 Neustadt/Weinstraße
------------------------------------	--

Produkt: Product: Produit:	D122, Anzeigegerät /Zähler
----------------------------------	-------------------------------

*Das oben beschriebene Produkt erfüllt die Schutzanforderungen der folgenden EG-Richtlinien / the product described above complies with the following EG- rules / le produit décrit ci-dessus accomplit CU- réglementations*

**2004/108/EG, 93/68/EWG, 94/9/EG**

*und ist konform mit / and is in conformity with / et est conforme á:*

EN 60079-0: 2009, Allgemeine Bestimmungen EN 60079-11: 2007, Eigensicherheit „i“ EN 60079-18: 2004, Vergusskapselung „m“ EN 61241-1:2004, Schutz durch Gehäuse "tD" EN 60079-27:2008, Feldbussysteme FISCO + FNICO EN 1127-1: 2008, ATEX- Grundnorm EN 61000-6-4: Fachgrundnorm Störaussendung; Teil 6-4: Industriebereich EN 61000-6-2: Fachgrundnorm Störfestigkeit; Teil 6-2: Industriebereich EN 60947-1: 2008, Niederspannungs-Schaltgeräte
--

*zusätzliche Angaben / additional information / informations supplémentaires:*

Qualitätsmanagement- System nach ISO EN DIN 9001:2008 Anerkanntes Qualitätssicherungssystem nach Richtlinie 94/9/EG
--

*EG- Baumusterprüfbescheinigung / EC- Type certification / Attestation d'examen ce de type*

TÜV 99 ATEX 1488
------------------

*Diese Konformitätserklärung ist gültig für alle Produkte, die ab dem Datum der Unterzeichnung in Verkehr gebracht werden*

Neustadt, den 11.03.2010

Gönzheimer (Geschäftsführer)