

**HIOKI**

---

---

**INSTRUCTION MANUAL**

**3511-50**

**LCR HiTESTER**

**HIOKI E. E. CORPORATION**

---

---



# Contents

<b>Introduction</b> .....	<b>i</b>
<b>Inspection</b> .....	<b>i</b>
<b>Safety Notes</b> .....	<b>ii</b>
<b>Notes on Use</b> .....	<b>iv</b>
<b>Layout of This Manual</b> .....	<b>v</b>
<b>Chapter 1 Product Overview</b> .....	<b>1</b>
1.1 Product Overview .....	1
1.2 Product Features .....	2
1.3 Names and Functions of Parts .....	3
1.3.1 Front View .....	3
1.3.2 Operation Section Details .....	4
1.3.3 Rear View .....	5
1.3.4 Side View .....	6
<b>Chapter 2 Before Starting Measurement</b> .....	<b>7</b>
2.1 Connecting the Power Cord .....	7
2.2 Connecting the Test Leads .....	8
2.2.1 Establishing the Connections .....	9
2.3 Turning the Power On and Off .....	10
<b>Chapter 3 Basic Functions</b> .....	<b>11</b>
3.1 Choosing the Testing Parameters .....	11
3.2 Setting the Test Frequency .....	12
3.3 Setting the Test Signal Level .....	12
3.4 Setting the Testing Speed .....	13
3.5 Setting the Equivalent Circuit Mode .....	14
3.5.1 Equivalent Circuit Mode .....	14
3.6 Setting the Ranging .....	16
3.6.1 Test Range .....	16
3.6.2 Auto Range .....	20
3.6.3 Hold Range .....	20
3.7 Open Circuit Compensation .....	21
3.7.1 Performing Open Circuit Compensation .....	21
3.7.2 Open Circuit Compensation Error .....	22
3.7.3 Canceling Open Circuit Compensation .....	22

3.8	Short Circuit Compensation .....	23
3.8.1	Performing Short Circuit Compensation .....	23
3.8.2	Short Circuit Compensation Error .....	25
3.8.3	Canceling Short Circuit Compensation .....	25
3.9	Setting the Trigger Signal .....	26
3.9.1	Setting the Trigger Mode .....	26
<b>Chapter 4</b>	<b>Other Functions .....</b>	<b>27</b>
4.1	Comparator Function .....	27
4.1.1	Operation Sequence .....	28
4.1.2	Setting the Upper and Lower Limits .....	28
4.1.3	Comparator Test Mode .....	30
4.2	Panel Save Function .....	31
4.2.1	Setting Panel Save .....	31
4.2.2	Aborting Panel Save .....	31
4.3	Panel Load Function .....	32
4.3.1	Setting Panel Load .....	32
4.3.2	Aborting Panel Load .....	32
4.4	Key Lock Function .....	33
4.4.1	Executing the Key Lock Function .....	33
4.4.2	Cancelling the Key Lock Function .....	33
4.5	Various Settings Made After Switching on Power .....	34
4.5.1	Setting Screen Flow After Power ON .....	34
4.5.2	Setting the Interface .....	35
4.5.3	Setting Beep .....	36
4.5.4	Executing System Reboot .....	37
4.6	Remote Function .....	38
4.6.1	Remote Mode .....	38
4.6.2	Cancelling the Remote Mode .....	38
4.7	The Residual Charge Protection Function .....	39
<b>Chapter 5</b>	<b>Applications .....</b>	<b>41</b>
5.1	Testing Using EXT I/O .....	41
5.1.1	The EXT I/O Connector .....	41
5.1.2	Pinouts for the EXT I/O Connector .....	42
5.1.3	Signal Lines for the EXT I/O Connector .....	43
5.1.4	Circuit Construction and Connections for the EXT I/O Connector .....	45
5.1.5	Electrical Characteristics of the Output Signals .....	46
5.1.6	I/O Signal Timing .....	47
5.1.7	Time Taken for Testing .....	48

5.2	Supplying DC Bias .....	50
5.2.1	How to Supply a DC Bias Voltage .....	51
5.2.2	How to Supply a DC Bias Current .....	52
5.3	9442 PRINTER (Option) .....	53
5.3.1	Preparation .....	53
5.3.2	Connection Method .....	55
5.3.3	Printing Results .....	56
5.4	Testing High Impedance Elements .....	57
5.5	Testing an Element in a Circuit .....	58
5.6	External Interference .....	59
5.6.1	Countermeasures Against Interference from the Power Supply Line .....	59
5.6.2	Countermeasures Against Noise from the Test Cables .....	60
<b>Chapter6</b>	<b>RS-232C Interface .....</b>	<b>61</b>
6.1	Overview .....	61
6.1.1	Introduction to the RS-232C Interface .....	61
6.1.2	Specifications .....	62
6.2	Connecting Method .....	63
6.2.1	Handshake .....	64
6.3	Operation .....	65
6.3.1	Communication Methods by the RS-232C .....	65
6.3.2	Message Format .....	66
6.3.3	Program Message .....	66
6.3.4	Response Messages .....	66
6.4	Headers .....	67
6.5	Data Formats .....	68
6.6	Delimiters .....	69
6.7	Separators .....	69
6.8	Abbreviation of Compound Commands .....	70
6.9	Output Queue .....	71
6.10	Input Buffer .....	71
6.11	Event Registers .....	72
6.12	Command Reference .....	74
6.12.1	Command Summary .....	74
6.13	Format of Command Explanations .....	76
6.14	Particular Commands .....	77
6.15	Commands Specific to the 3511-50 .....	80
6.16	Initialization Items .....	98
6.17	Sample Programs .....	99
6.18	Troubleshooting .....	103

<b>Chapter 7 Maintenance, Adjustment, and Disposal</b> .....	<b>105</b>
7.1 Maintenance and Servicing .....	105
7.2 How to Change the Power Supply Fuse and Change the Power Supply Voltage .....	106
7.3 Shipping the Unit .....	109
7.4 Troubleshooting .....	109
7.5 Disposing of the Unit .....	110
<b>Chapter 8 Specifications</b> .....	<b>113</b>
8.1 General Specifications .....	113
8.2 Testing Parameters and Calculation Equations .....	116
8.3 Test Accuracy .....	118
<b>Chapter 9 Options</b> .....	<b>121</b>

---

## Introduction

Thank you for purchasing the HIOKI "3511-50 LCR HiTESTER." To obtain maximum performance from the product, please read this manual first, and keep it handy for future reference.

### A request

We have tried to bring this manual as close to perfection as we could achieve.

If perchance you find any unclear portions, mistakes, omissions, or the like, we would be most obliged if you could please notify us of them via any HIOKI agent, or directly.

---

## Inspection

When you receive the product, inspect it carefully to ensure that no damage occurred during shipping. In particular, check the accessories, panel switches, and connectors. If damage is evident, or if it fails to operate according to the specifications, contact your dealer or Hioki representative.

Check the 3511-50 unit and the supplied accessories

Main unit

3511-50 LCR HiTESTER

Supplied accessories

- (1) Instruction Manual
- (2) Grounded three-core power cord (selected according to shipping destination)
- (3) Spare fuse for power supply (according to voltage specification)
  - 100 V, 120 V setting: 250 V F1.0AL 20 mm x 5 mm dia.
  - 220 V, 240 V setting: 250 V F0.5AL 20 mm x 5 mm dia.

**NOTE**

No interface boards and no test cables are supplied with the unit as standard equipment. You should order them separately, according to requirements.

## Safety Notes

This manual contains information and warnings essential for safe operation of the product and for maintaining it in safe operating condition. Before using the product, be sure to carefully read the following safety notes.





**This product is designed to conform to IEC 61010 Safety Standards, and has been thoroughly tested for safety prior to shipment. However, mishandling during use could result in injury or death, as well as damage to the product. Be certain that you understand the instructions and precautions in the manual before use. We disclaim any responsibility for accidents or injuries not resulting directly from product defects.**

The following symbols in this manual indicate the relative importance of cautions and warnings.

### Safety symbols



- The  symbol printed on the product indicates that the user should refer to a corresponding topic in the manual (marked with the  symbol) before using the relevant function.
- In the manual, the  symbol indicates particularly important information that the user should read before using the product.



Indicates a grounding terminal.



Indicates AC (Alternating Current).



Indicates a fuse.



Indicates that incorrect operation presents a significant hazard that could result in serious injury or death to the user.



Indicates that incorrect operation presents a possibility of injury to the user or damage to the product.



Advisory items related to performance or correct operation of the product.



## Overvoltage Categories

This product conforms to the safety requirements for CAT II measurement products.

To ensure safe operation of measurement products, IEC 60664 establishes safety standards for various electrical environments, categorized as CAT I to CAT IV, and called overvoltage categories. These are defined as follows.

- CAT I Secondary electrical circuits connected to an AC electrical outlet through a transformer or similar device.
- CAT II Primary electrical circuits in equipment connected to an AC electrical outlet by a power cord (portable tools, household appliances, etc.)
- CAT III Primary electrical circuits of heavy equipment (fixed installations) connected directly to the distribution panel, and feeders from the distribution panel to outlets.
- CAT IV The circuit from the service drop to the service entrance, and to the power meter and primary overcurrent protection device (distribution panel).

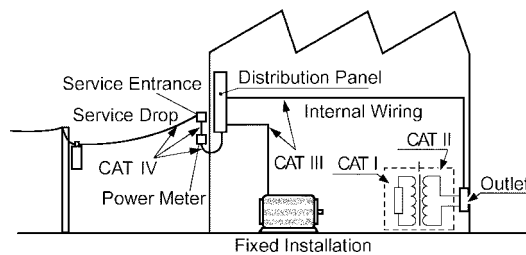

Higher-numbered categories correspond to electrical environments with greater momentary energy, so a measurement product designed for CAT III environments can endure greater momentary energy than one designed for CAT II. Using a measurement product in an environment designated with a higher-numbered category than that for which the product is rated could result in a severe accident, and must be carefully avoided.

---

## Notes on Use

Follow these precautions to ensure safe operation and to obtain the full benefits of the various functions.

---

---

**⚠ WARNING**

- **Before turning the product on, make sure the source voltage matches that indicated on the product's power connector. Connection to an improper supply voltage may damage the product and present an electrical hazard.**
  - **To avoid electric shock and ensure safe operation, connect the power cable to a grounded (3-contact) outlet.**
  - **Use this unit near the power supply socket.**
  - **The interior of the unit contains some components which are subject to high voltage, and therefore dangerous. Absolutely do not remove the cover panel.**
- 
- 

---

**⚠ CAUTION**

- Various connectors are present on the outside of the 3511-50. Never connect any cable to any of these connectors without first turning off the power supply and removing the power cord. Moreover, check the connections carefully in order to avoid any chance of setting up a short circuit etc..
  - In the event that the equipment malfunctions in any manner during use, turn off the power immediately, and contact your dealer or HIOKI representative.
  - Do not store or use the unit where it will be exposed to direct sunlight, high temperatures, high humidity, or condensation. If exposed to such conditions, the unit may be damaged, the insulation may deteriorate, and the unit may no longer satisfy its specifications.
  - This product should be installed and operated indoors only, between 0 and 40°C and 35 to 80%RH. However, it can be safely operated down to -10°C.
  - The unit should always be stored in a range from -10°C to 55°C, 80% RH or less.
  - Do not store or use the product where it could be exposed to direct sunlight, high temperature or humidity, or condensation. Under such conditions, the product may be damaged and insulation may deteriorate so that it no longer meets specifications.
  - Do not drop the unit or subject it to severe shock. Doing so can cause serious damage.
  - To avoid damage to the product, protect it from vibration or shock during transport and handling, and be especially careful to avoid dropping.
- 

### Warranty

HIOKI cannot be responsible for losses caused either directly or indirectly by the use of the unit with other equipment, or if ownership is transferred to a third party.

---

## Layout of This Manual

- Chapter 1 **Product Overview**  
Describes the product generally, and lists the parts and functions.
- Chapter 2 **Before Starting Measurement**  
How to connect the power cord etc., and important precautions before operation.
- Chapter 3 **Basic Functions**  
Description of operating procedures and normal measurement functions
- Chapter 4 **Other Functions**  
Special functions.
- Chapter 5 **Detailed Description of Applications**  
Various testing applications.
- Chapter 6 **RS-232C Interface**  
General description of RS-232C and explanation of related commands.
- Chapter 7 **Maintenance, Adjustment, and Disposal**
- Chapter 8 **Specifications**
- Chapter 9 **Options**



---

# Chapter 1

## Product Overview

---

---

### 1.1 Product Overview

The HIOKI 3511-50 LCR HiTESTER is capable of measuring the impedance of various devices. With a wide range of test frequencies (from 120 Hz to 1 kHz), the 3511-50 offers high-speed, high-accuracy measurement capabilities.

## 1.2 Product Features

- (1) Compact, lightweight single-function model  
Streamlined to provide a single function for test frequencies 120 Hz and 1 kHz, the 3511-50 is compact and lightweight.
- (2) High-speed measurement  
The 3511-50 is capable of high-speed measurement: 5 ms at test frequency 1 kHz, and 13 ms at 120 Hz.
- (3) Comparator function  
On the 3511-50, comparator functions are standard. Different comparators may be executed for two separate displayed parameters.
- (4) LED display  
Provides superior visibility.
- (5) Two interfaces  
The 3511-50 offers external I/O for sequencing and a standard RS-232C interface. An optional 9518-01 GP-IB INTERFACE is also available.

## 1.3 Names and Functions of Parts

### 1.3.1 Front View

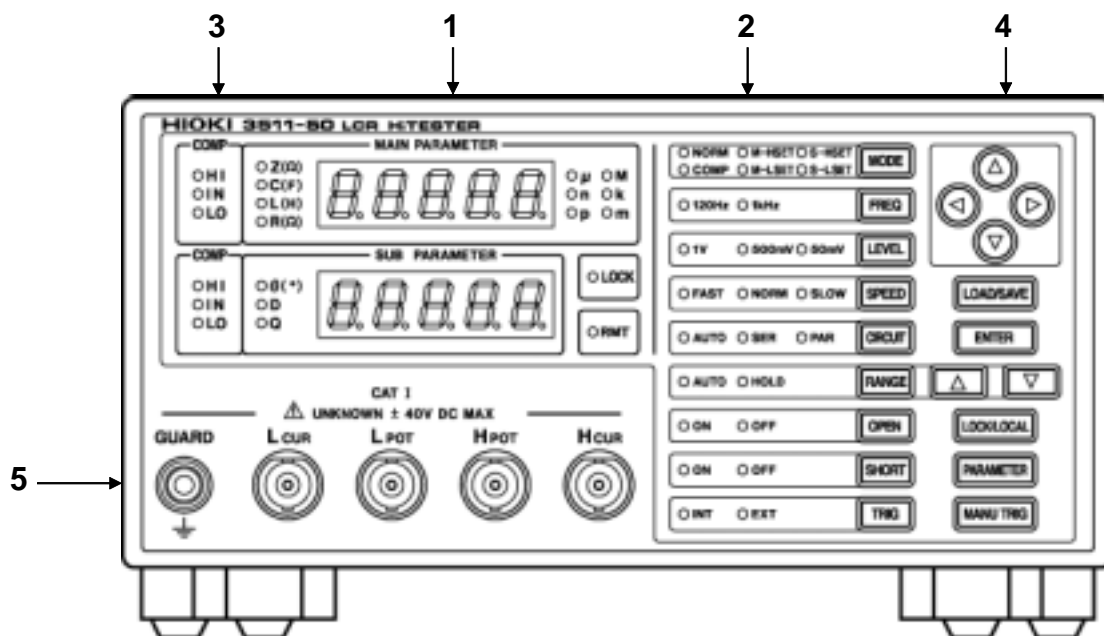

#### 1. Measurement display

Displays a testing parameter and corresponding measurement.

#### 2. Status display

Displays current test conditions, presets, and other information.

#### 3. Comparator judgment display

Displays judgment in comparator mode.

#### 4. Operation section

Use to set test conditions and to make other settings (see next page for more information).

#### 5. Test terminals

There are five test terminals:

$H_{CUR}$ : The test signal is supplied to this terminal.

$H_{POT}$ : Detected voltage high terminal

$L_{POT}$ : Detected voltage low terminal

$L_{CUR}$ : Test current detected terminal

**GUARD**: Guard terminal

These test terminals are designed according to the safety standard; Pollution Degree 2, Overvoltage Category I.

### 1.3.2 Operation Section Details

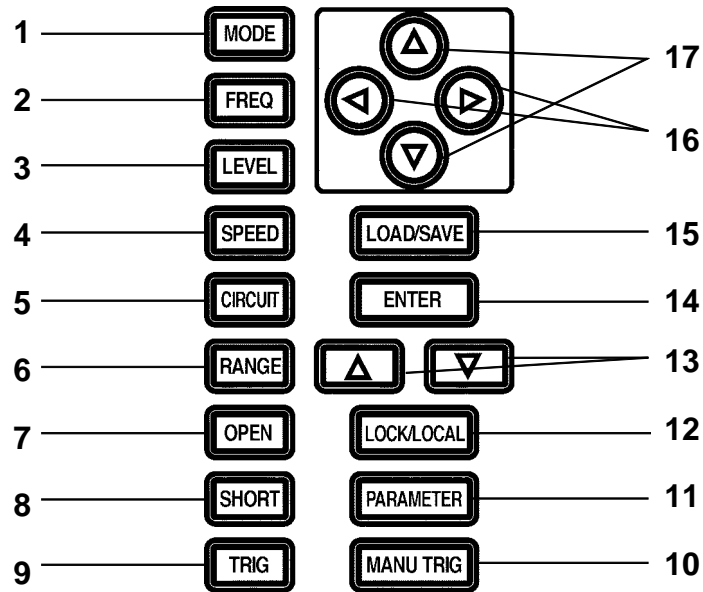

- |   |                                       |
|---|---------------------------------------|
| 1. Test mode selector key               | 10. Manual trigger key                |
| 2. Test frequency selector key          | 11. Testing parameter selector key    |
| 3. Test signal level selector key       | 12. LOCK/LOCAL key                    |
| 4. Testing speed selector key           | 13. Test range selector key (up/down) |
| 5. Equivalent circuit mode selector key | 14. ENTER key                         |
| 6. Test range selector key              | 15. LOAD/SAVE key                     |
| 7. Open circuit compensation key        | 16. Digit selector key (left/right)   |
| 8. Short circuit compensation key       | 17. Count-setting key (up/down)       |
| 9. Trigger mode selector key            |                                       |



### 1.3.3 Rear View

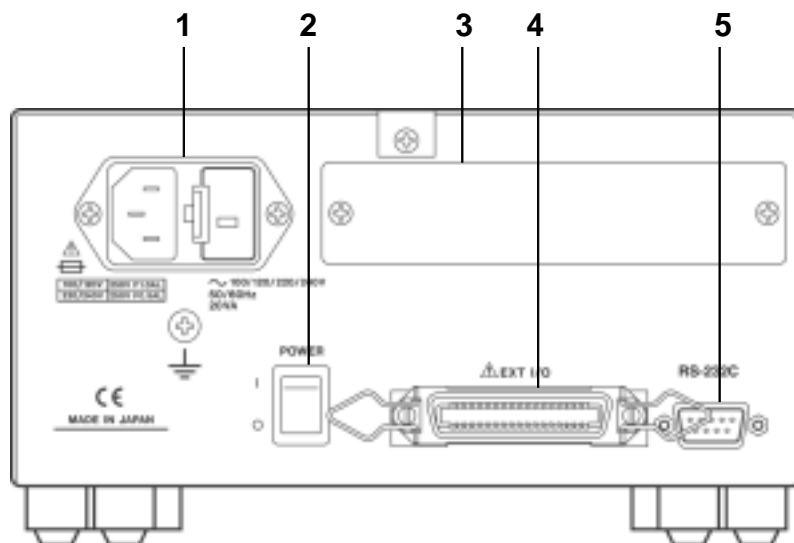

**1. Power input socket with voltage selector**

Connect the supplied power cord here.

**2. Power switch**

Turns the power for the unit on and off.

**3. Optional equipment interface**

The optional 9518-01 GP-IB INTERFACE is connected here.

**4. EXT I/O connector**

For input of an external trigger signal and output of comparator results.  
Compatible with sequencer connection.

**5. RS-232C connector**

Connect the RS-232C cable here.

---

### 1.3.4 Side View

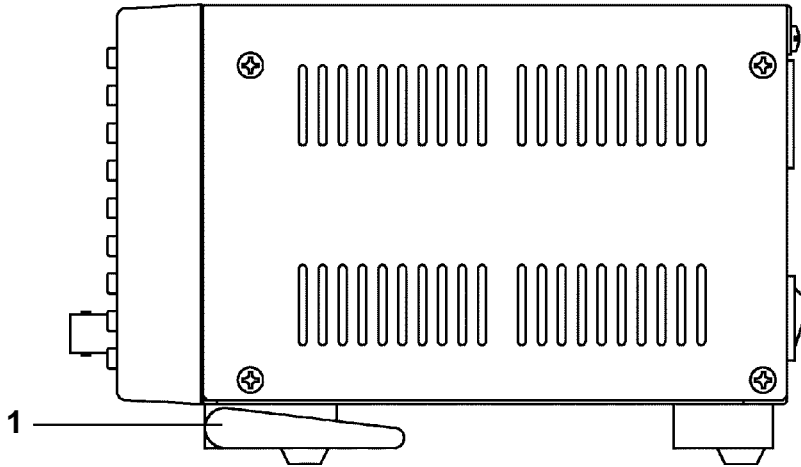

#### 1. Stand



Do not apply strong downward pressure with the stand extended. Damage to the stand will result.

---

# Chapter 2

## Before Starting Measurement



### 2.1 Connecting the Power Cord

#### WARNING

- When a 3511-50 unit is ordered, the supply voltage is set in the factory to the value specified, which can be 100 V, 120 V, 220 V, or 240 V.  
The maximum rated power (with all options fitted) is 20 VA.
- Before turning the product on, make sure the source voltage matches that indicated on the product's power connector. Connection to an improper supply voltage may damage the product and present an electrical hazard.
- The power supply voltage for this product is switchable. To avoid electrical accidents, check that the voltage selector is set correctly for the supply voltage you are using. (For details, refer to Section 7.2)
- To avoid electric shock and ensure safe operation, connect the power cable to a grounded (3-contact) outlet.

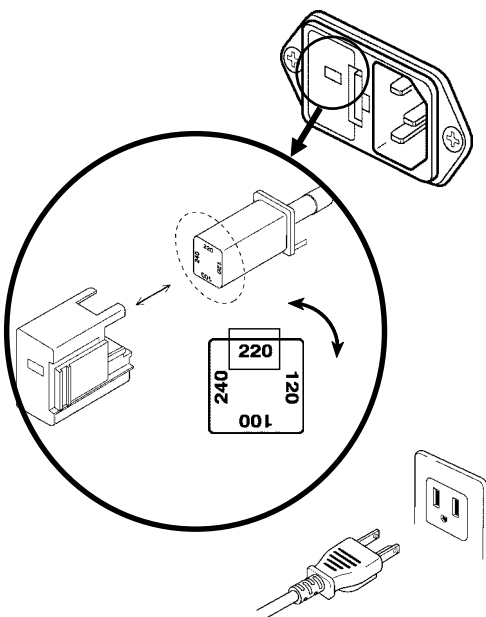

The power cord is connected according to the following procedure.

1. Check that the main power switch of the unit is off.
2. Check that the power supply voltage is correct, and connect the proper end of the power cord to the power input socket (with voltage selector) at the rear of the unit.
3. Plug the other end of the power cord into the power supply socket.

#### Grounding

Use the grounding type (three-wire) power cord supplied. The unit will be grounded automatically.



## 2.2 Connecting the Test Leads

The 3511-50 has five test terminals:

H<sub>CUR</sub> terminal (to which the test signal is supplied)

H<sub>POT</sub> terminal (detected voltage high terminal)

L<sub>POT</sub> terminal (detected voltage low terminal)

L<sub>CUR</sub> terminal (test current detected terminal)

GUARD terminal (connected to the chassis of the unit).

These test terminals are designed according to the safety standard; Pollution Degree 2, Overvoltage Category I.

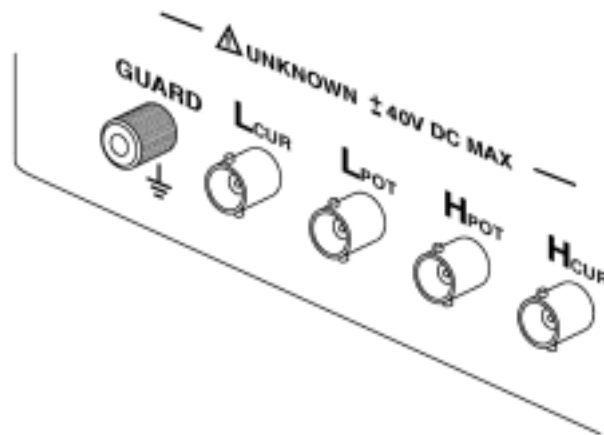



## 2.2.1 Establishing the Connections

2

### CAUTION

The maximum voltage which can be applied to the test terminals of the 3511-50 unit is 40 V DC. If a DC voltage greater than this is applied continuously, the unit may be damaged. For how to apply a DC bias voltage, refer to Section 5.2, "Supplying DC Bias."

If using a test lead set supplied by HIOKI, connect the red leads to the  $H_{CUR}$  terminal and to the  $H_{POT}$  terminal, and connect the black leads to the  $L_{CUR}$  terminal and to the  $L_{POT}$  terminal.

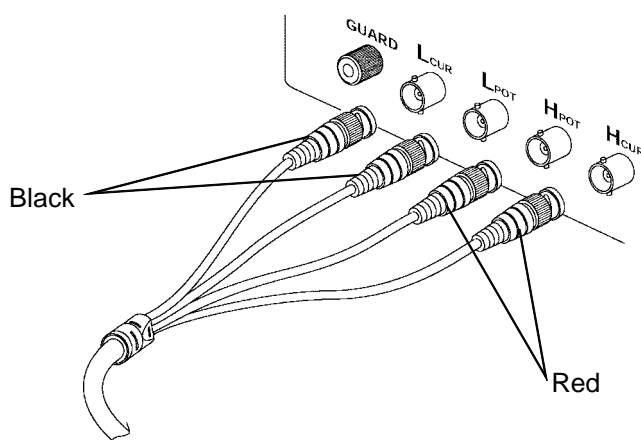

The unit is designed and adjusted for  $75 \Omega$  coaxial cable test leads. It is best to use HIOKI test leads.

The connections to the article to be tested are as shown in the following figure.

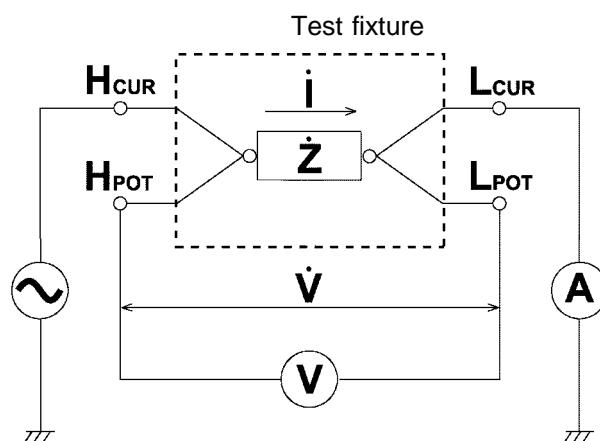

### NOTE

- No test cables are included with the 3511-50 unit. They must be purchased separately. For details, refer to Chapter 9, "Options."
- If all four terminals are left floating, the numbers which appear on the display are completely meaningless.

## 2.3 Turning the Power On and Off

### How to turn the power on

Turn on the power switch on the rear panel. All LEDs on the front panel light.

The test conditions will start off the same as they were when last the power was turned off.

**NOTE**

Wait for 60 minutes after turning on the power before starting testing, so as to allow the unit to warm up fully.

### How to turn the power off

Turn off the power switch on the rear panel. The test conditions will be preserved.

**NOTE**

Even if the power supply is interrupted because of a power failure or the like, the test conditions (settings) will not be lost; when the power is turned on again, the unit will return to its state just before the interruption. This happens, however, in the normal test mode or comparator execution mode only.

# Chapter 3

## Basic Functions

3

### 3.1 Choosing the Testing Parameters

Z- $\theta$	Impedance ( $\Omega$ ) - Impedance phase angle ( $^{\circ}$ )
C-D	Static capacitance (F) - Loss coefficient ( $=\tan \delta$ )
L-D	Inductance (H) - Loss coefficient ( $=\tan \delta$ )
L-Q	Inductance (H) - Q factor
R	Effective resistance ( $\Omega$ )

As shown above, the 3511-50 permits five possible combinations of testing parameters. Cycle through the combinations by repeatedly pressing . Use the LED lamps to the left of the measurement display to check on selected testing parameters.

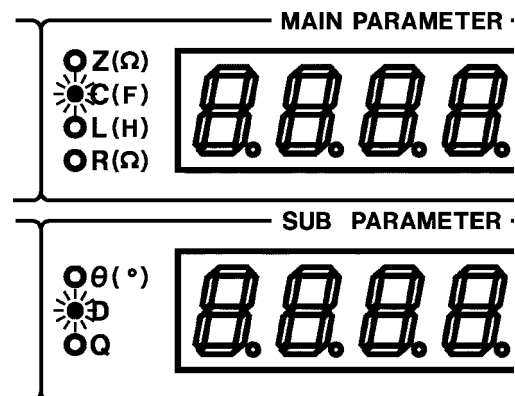

**NOTE**

Check polarity via the impedance phase angle. Except for impedance phase angle, all values are displayed as absolute values.

For details, refer to Section 8.2, "Testing Parameters and Calculation Equations."

---

## 3.2 Setting the Test Frequency

For the 3511-50's test frequency, you may specify either 120 Hz or 1 kHz.

### Procedure

Press  to toggle between 120 Hz and 1 kHz. Use the LED lamp to the left of the key to check on a set test frequency.



---

## 3.3 Setting the Test Signal Level

For the 3511-50's test signal level, you may specify 1 V, 500 mV or 50 mV.

### Procedure

Press  repeatedly to cycle through available settings: 1 V, 500 mV, and 50 mV. Use the LED lamp to the left of the key to check on a set test signal level.



### Precautions for changing test signal levels

The value of the test signal level may change according to the sample which is being tested. During measurement, keep in mind that inductance is often current-dependent.



## 3.4 Setting the Testing Speed

For testing speed, select from one of the following three levels, depending on the specific purpose. The slower the testing speed is, the more accurate are the results.

**FAST** : Low accuracy testing is performed at high speed.

**NORM** : The speed used for normal testing

**SLOW** : High accuracy testing is performed slowly.

### Procedure

Press  repeatedly to cycle through available settings: FAST, NORM, and SLOW. Use the LED lamp to the left of the key to check on a set testing speed.



### Testing speed

Test frequency	FAST	NORM	SLOW
120 Hz	13 ms	90 ms	400 ms
1 kHz	5 ms	60 ms	300 ms

### NOTE

The testing time values above are for reference only, valid when Z- $\theta$  is displayed and varying according to testing parameter setting conditions, range mode, OPEN/SHORT compensation, and other conditions.

---

## 3.5 Setting the Equivalent Circuit Mode

You may set an equivalent circuit mode. Automatic selection is also possible.

---

### 3.5.1 Equivalent Circuit Mode

The 3511-50 unit analyses the test sample in terms of a pure inductive component (L), an equivalent circuit construction composed of a pure capacitive component (C), and a pure resistive component (R), and calculates as though these components were connected in series, or alternatively connected in parallel. Therefore, it is possible for the user to select either a series equivalent circuit mode or a parallel equivalent circuit mode for this conceptual connection together of these L, C, and R components.

When the impedance of the sample being tested is relatively high, the parallel equivalent circuit mode should be selected manually, and when the impedance of the sample being tested is relatively low, the series equivalent circuit mode should be selected manually.

Generally, for a device such as an electrolytic capacitor or the like with a high D value (i.e., a low Q value), the test values obtained when testing using series equivalent circuit mode differ from those obtained when testing using parallel equivalent circuit mode. The greater the resistance component in the sample being tested, the more this difference in the test values appears.

For example, the test values for capacitors of the same capacitance which have different values of D in series equivalent circuit mode and in parallel equivalent circuit mode may be as follows:

	Series equivalent circuit mode	Parallel equivalent circuit mode
D = 0	C	C
D = 0.1	1.005C	0.995C
D = 0.5	1.118C	0.8944C

(Where C is the static capacitance)

Therefore it is necessary for the user clearly to understand the setting of this test mode, in order properly to assess test samples.

In general, parallel equivalent circuit mode should be used for elements which have relatively low capacitance and high impedance such as film capacitors and ceramic capacitors, since parallel resistance can cause great loss in this case; while series equivalent circuit mode should be used for elements which have relatively high capacitance and low impedance such as electrolytic capacitors, since series resistance can cause great loss in this case.

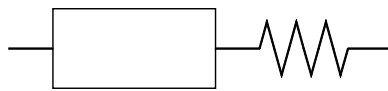

Series equivalent circuit

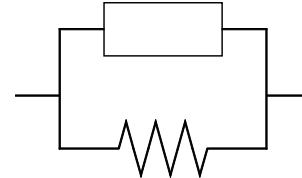

Parallel equivalent circuit

### Procedure

Press  repeatedly to cycle through available settings: AUTO, SER, and PAR.

**AUTO** : The series equivalent circuit mode or the parallel equivalent circuit mode is selected automatically according to the following table, following the measurement range.

Z, L, R-range number	C-range number	The equivalent circuit mode is set automatically.
1 to 5	6 to 10	Series equivalent circuit
6 to 10	1 to 5	Parallel equivalent circuit

**SER** : Series equivalent circuit mode

**PAR** : Parallel equivalent circuit mode

Use the LED lamp to the left of the key to check on a set equivalent circuit mode.



## 3.6 Setting the Ranging

You may set a test range. Automatic selection is also possible.

### 3.6.1 Test Range

A test range is set, with impedance as a reference. The range numbers, corresponding impedance ranges, and first parameter display ranges are as follows:

Frequency Range number	Z-display range *	R-display range
	Common to 120 Hz and 1 kHz	Common to 120 Hz and 1 kHz
10	009.00 to 200.00 MΩ	000.00 to 999.99 MΩ
9	0.9000 to 9.9999 MΩ	0.0000 to 9.9999 MΩ
8	090.00 to 999.99 kΩ	000.00 to 999.99 kΩ
7	09.000 to 99.999 kΩ	00.000 to 99.999 kΩ
6	0.9000 to 9.9999 kΩ	0.0000 to 9.9999 kΩ
5	090.00 to 999.99 Ω	000.00 to 999.99 Ω
4	09.000 to 99.999 Ω	00.000 to 99.999 Ω
3	0.9000 to 9.9999 Ω	0.0000 to 9.9999 Ω
2	0.0900 to 0.9999 Ω	0.0000 to 9.9999 Ω
1	0.0100 to 0.0999 Ω	0.0000 to 9.9999 Ω

\*: Range of impedance which can be measured within the accuracy guaranteed

Frequency Range number	Z-display range *	L-display range	
	Common to 120 Hz and 1 kHz	120 Hz	1 kHz
10	009.00 to 200.00 MΩ	000.00 to 999.99 kH	00.000 to 99.999 kH
9	0.9000 to 9.9999 MΩ	00.000 to 99.999 kH	0.0000 to 9.9999 kH
8	090.00 to 999.99 kΩ	0.0000 to 9.9999 kH	000.00 to 999.99 H
7	09.000 to 99.999 kΩ	000.00 to 999.99 H	00.000 to 99.999 H
6	0.9000 to 9.9999 kΩ	00.000 to 99.999 H	0.0000 to 9.9999 H
5	090.00 to 999.99 Ω	0.0000 to 9.9999 H	000.00 to 999.99 mH
4	09.000 to 99.999 Ω	000.00 to 999.99 mH	00.000 to 99.999 mH
3	0.9000 to 9.9999 Ω	00.000 to 99.999 mH	0.0000 to 9.9999 mH
2	0.0900 to 0.9999 Ω	0.0000 to 9.9999 mH	000.00 to 999.99 μH
1	0.0100 to 0.0999 Ω	000.00 to 999.99 μH	00.000 to 99.999 μH

\*: Range of impedance which can be measured within the accuracy guaranteed

Frequency Range number	Z-display range *	Frequency Range number	C-display range	
	Common to 120 Hz and 1 kHz		120 Hz	1 kHz
10	009.00 to 200.00 MΩ	1	000.00 to 999.99 pF	00.000 to 99.999 pF
9	0.9000 to 9.9999 MΩ	2	0.0000 to 9.9999 nF	000.00 to 999.99 pF
8	090.00 to 999.99 kΩ	3	00.000 to 99.999 nF	0.0000 to 9.9999 nF
7	09.000 to 99.999 kΩ	4	000.00 to 999.99 nF	00.000 to 99.999 nF
6	0.9000 to 9.9999 kΩ	5	0.0000 to 9.9999 μF	000.00 to 999.99 nF
5	090.00 to 999.99 Ω	6	00.000 to 99.999 μF	0.0000 to 9.9999 μF
4	09.000 to 99.999 Ω	7	000.00 to 999.99 μF	00.000 to 99.999 μF
3	0.9000 to 9.9999 Ω	8	0.0000 to 9.9999 mF	000.00 to 999.99 μF
2	0.0900 to 0.9999 Ω	9	00.000 to 99.999 mF	0.0000 to 9.9999 mF
1	0.0100 to 0.0999 Ω	10	000.00 to 999.99 mF	00.000 to 99.999 mF

\*: Range of impedance which can be measured within the accuracy guaranteed

**NOTE**

If the impedance exceeds the measurement range, the first parameter display is "UF" (underflow, i.e., impedance below the measurement range) or "OF" (overflow, i.e., impedance above the measurement range), and the second parameter display disappears.

To measure a parameter other than Z - i.e., C, L, or R - determine an appropriate range based on impedance. The following table presents appropriate ranges for C and L when D is equal to or smaller than 0.1 and those when  $\theta$  is equal to or smaller than  $6^\circ$ .

Test range	Z		R	
Frequency	Common to 120 Hz and 1 kHz		Common to 120 Hz and 1 kHz	
Range number	Range	Display range	Range	Display range
10	100 M $\Omega$	200.00 M $\Omega$	100 M $\Omega$	200.00 M $\Omega$
		009.00 M $\Omega$		009.10 M $\Omega$
9	10 M $\Omega$	9.9999 M $\Omega$	10 M $\Omega$	9.9000 M $\Omega$
		0.9000 M $\Omega$		0.9100 M $\Omega$
8	1 M $\Omega$	999.99 k $\Omega$	1 M $\Omega$	990.00 k $\Omega$
		090.00 k $\Omega$		091.00 k $\Omega$
7	100 k $\Omega$	99.999 k $\Omega$	100 k $\Omega$	99.000 k $\Omega$
		09.000 k $\Omega$		09.100 k $\Omega$
6	10 k $\Omega$	9.9999 k $\Omega$	10 k $\Omega$	9.9000 k $\Omega$
		0.9000 k $\Omega$		0.9100 k $\Omega$
5	1 k $\Omega$	999.99 $\Omega$	1 k $\Omega$	990.00 $\Omega$
		090.00 $\Omega$		091.00 $\Omega$
4	100 $\Omega$	99.999 $\Omega$	100 $\Omega$	99.000 $\Omega$
		09.000 $\Omega$		09.100 $\Omega$
3	10 $\Omega$	9.9999 $\Omega$	10 $\Omega$	9.9000 $\Omega$
		0.9000 $\Omega$		0.9100 $\Omega$
2	1 $\Omega$	0.9999 $\Omega$	1 $\Omega$	0.9900 $\Omega$
		0.0900 $\Omega$		0.0900 $\Omega$
1	100 m $\Omega$	0.0999 $\Omega$	100 m $\Omega$	0.0990 $\Omega$
		0.0100 $\Omega$		0.0110 $\Omega$

Test range	C				L			
Frequency	120 Hz		1 kHz		120 Hz		1 kHz	
Range number	Range	Display range	Range	Display range	Range	Display range	Range	Display range
10	1 F	999.99 mF	100 mF	99.999 mF	200 kHz	200.00 kHz	20 kHz	20.000 kHz
		013.50 mF		01.600 mF		012.00 kHz		01.450 kHz
9	14.5 mF	14.500 mF	1.7 mF	1.7000 mF	13 kHz	13.000 kHz	1.55 kHz	1.5500 kHz
		01.350 mF		0.1600 mF		01.200 kHz		0.1450 kHz
8	1.45 mF	1.4500 mF	170 $\mu$ F	170.00 $\mu$ F	1.3 kHz	1.3000 kHz	155 H	155.00 H
		0.1350 mF		016.00 $\mu$ F		0.1200 kHz		014.50 H
7	145 $\mu$ F	145.00 $\mu$ F	17 $\mu$ F	17.000 $\mu$ F	130 H	130.00 H	15.5 H	15.500 H
		013.50 $\mu$ F		01.600 $\mu$ F		012.00 H		01.450 H
6	14.5 $\mu$ F	14.500 $\mu$ F	1.7 $\mu$ F	1.7000 $\mu$ F	13 H	13.000 H	1.55 H	1.5500 H
		01.350 $\mu$ F		0.1600 $\mu$ F		01.200 H		0.1450 H
5	1.45 $\mu$ F	1.4500 $\mu$ F	170 nF	170.00 nF	1.3 H	1.3000 H	155 mH	155.00 mH
		0.1350 $\mu$ F		016.00 nF		0.1200 H		014.50 mH
4	145 nF	145.00 nF	17 nF	17.000 nF	130 mH	130.00 mH	15.5 mH	15.500 mH
		013.50 nF		01.600 nF		012.00 mH		01.450 mH
3	14.5 nF	14.500 nF	1.7 nF	1.7000 nF	13 mH	13.000 mH	1.55 mH	1.5500 mH
		01.350 nF		0.1600 nF		01.200 mH		0.1450 mH
2	1.45 nF	1.4500 nF	170 pF	170.00 pF	1.3 mH	1.3000 mH	155 $\mu$ H	155.00 $\mu$ H
		0.1350 nF		016.00 pF		0.1200 mH		014.50 $\mu$ H
1	145 pF	145.00 pF	17 pF	17.000 pF	130 $\mu$ H	130.00 $\mu$ H	15.5 $\mu$ H	15.500 $\mu$ H
		009.40 pF		00.940 pF		014.00 $\mu$ H		01.600 $\mu$ H

### Procedure

Press  to toggle between AUTO and HOLD.

AUTO : The most suitable test range is set automatically.

HOLD : The test range is fixed, and may only be altered manually.

Use the LED lamp to the left of the key to check on a set test range.



---

## 3.6.2 Auto Range

The most suitable test range is set automatically. Useful when measuring an unknown sample.

**NOTE**



Measurement requires more time.



---

## 3.6.3 Hold Range

Take measurements in the same range regardless of the value of the sample. This is useful for high-speed measurement.

Procedures (either 1 or 2 will do)

1. Press  to set HOLD mode.
2. Press  or . The range select key moves up or down.

As the range changes with  or , the range number appears on the measurement display for about a half-second, then returns to measurement mode.



## 3.7 Open Circuit Compensation

With open circuit compensation, it is possible to reduce the influence of the floating impedance of the test cables and thereby to enhance the accuracy of measurement. It is effective for test samples whose impedance is relatively high.

### NOTE

- With open circuit compensation set, compensated values for 120 Hz and 1 kHz are input. These are unrelated to test frequency setting conditions.
- The testing accuracy specified in the specification of the 3511-50 unit assumes that open circuit compensation and short circuit compensation is being performed, as appropriate.
- When you have changed the test cables, be sure to perform compensation again. Correct test values will not be obtained if you go on testing using the same old compensation values which were obtained before the cable change.
- Compensation is possible for the impedance range of 1 k $\Omega$  or greater.

### 3.7.1 Performing Open Circuit Compensation

#### Procedures

- (1) Make sure that the HIGH and LOW leads are not contacted together.

### NOTE

As closely as possible, route the test cable and set the probe-terminal distance during this procedure as if performing actual measurement. Execute the guarding process. For the guarding process, refer to Section 5.4, "Testing High Impedance Elements."

- (2) Press . Begin compensation upon confirmation that the first parameter measurement display (MAIN PARAMETER) is as shown. The LED lamp flashes during open circuit compensation.

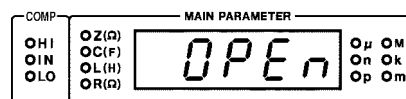

- (3) If compensation ends properly, the unit beeps once and returns to normal test mode.
- (4) Refer to the LED lamp to the left of the key to check for normal completion of open circuit compensation.

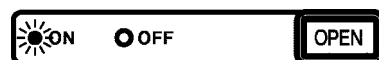

### NOTE

Open circuit compensation takes about 30 s.

If an error occurs during open circuit compensation, the unit beeps to notify you of the error. An error message appears, as shown, and compensation is aborted.

Press  to return the unit to normal test mode.

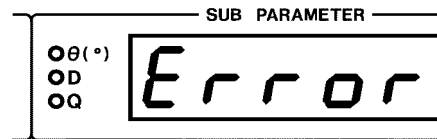

**NOTE**

If an error occurs, when you return to normal test mode after aborting open circuit compensation, the measurement value is not compensated for.

---

### 3.7.2 Open Circuit Compensation Error

The following are possible causes:

1. The circuit across HIGH and LOW terminals is not open.
2. The test cable is not connected correctly.
3. The impedance across the terminals does not reach 1 k $\Omega$ .

---

### 3.7.3 Canceling Open Circuit Compensation

Procedures

- (1) Press  with open circuit compensation ON. Open circuit compensation is canceled. The value compensated for is not saved.
- (2) The open circuit compensation will remain invalid until the compensation data is deleted and another open circuit compensation is performed.

---

## 3.8 Short Circuit Compensation

With short circuit compensation, it is possible to reduce the influence of the residual impedance of the test cables and thereby to enhance the accuracy of measurement. It is effective for test samples whose impedance is relatively low.

**NOTE**

- With short circuit compensation set, compensated values for 120 Hz and 1 kHz are input. These are unrelated to test frequency setting conditions.
- The testing accuracy specified in the specification of the 3511-50 unit assumes that open circuit compensation and short circuit compensation is being performed, as appropriate.
- When you have changed the test cables, be sure to perform compensation again. Correct test values will not be obtained if you go on testing using the same old compensation values which were obtained before the cable change.
- Compensation is possible for the impedance range of 1 k $\Omega$  or less.

---

### 3.8.1 Performing Short Circuit Compensation

#### Procedures

- (1) A shorting bar is used. This shorting bar is for short circuiting together the ends of the test leads. Use an object whose impedance is as low as possible.

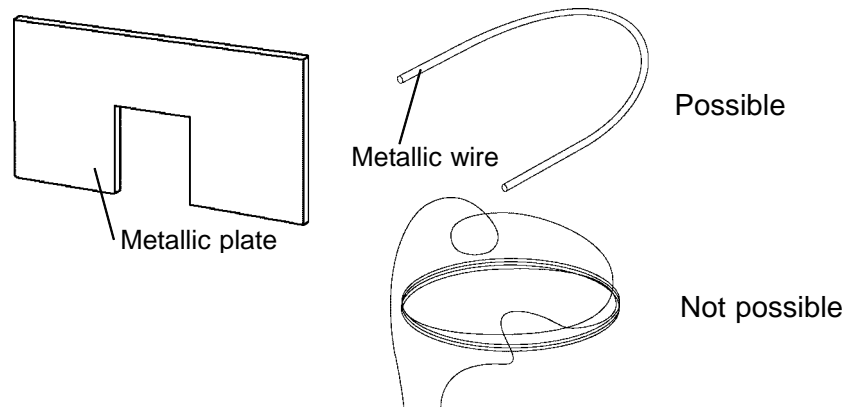

- (2) Short circuit together the HIGH and LOW leads. In order to keep external influences as low as possible, be sure to thrust the shorting bar in all the way.

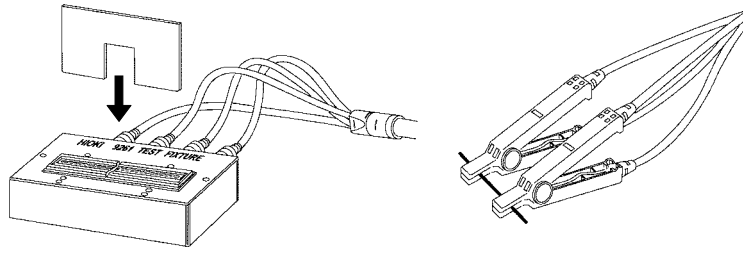

**NOTE**

As closely as possible, route the test cable during this procedure as if performing actual measurement.

- (3) Press **SHORT**. Begin compensation upon confirmation that the first parameter measurement display (MAIN PARAMETER) is as shown. The LED lamp flashes during short circuit compensation.

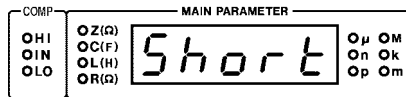

- (4) If compensation ends properly, the unit beeps once and returns to normal test mode.
- (5) Refer to the LED lamp to the left of the key to check for normal completion of short circuit compensation.



**NOTE**

Short circuit compensation takes about 30 s.

If an error occurs during short circuit compensation, the unit beeps to notify you of the error. An error message appears, as shown, and compensation is aborted.

Press **SHORT** to return the unit to normal test mode.

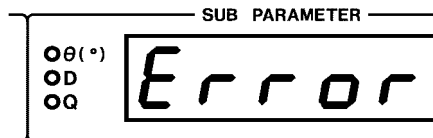

**NOTE**

If an error occurs, when you return to normal test mode after aborting short circuit compensation, the measurement value is not compensated for.

---

## 3.8.2 Short Circuit Compensation Error

The following are possible causes:

1. The circuit across HIGH and LOW terminals is not short.
2. The test cable is not connected correctly.
3. The impedance across the terminals exceeds 1 k $\Omega$ .

---

## 3.8.3 Canceling Short Circuit Compensation

Procedures

- (1) Press  with short circuit compensation ON. Short circuit compensation is canceled. The value compensated for is not saved.
- (2) The short circuit compensation will remain invalid until the compensation data is deleted and another short circuit compensation is performed.

---

## 3.9 Setting the Trigger Signal

The internal trigger or the external trigger can be set.

### **INT (Internal trigger mode):**

Continuous testing is performed while automatically generating an internal trigger signal.

### **EXT (External trigger mode):**

A trigger signal is input from the outside either manually or automatically.

---

### 3.9.1 Setting the Trigger Mode

Press  to toggle between INT and EXT. Use the LED lamp to the left of the key to check on a set test frequency.



#### (1) Internal trigger mode

Testing is performed continuously.

#### (2) External trigger mode

- Testing is performed with  (manual trigger).
- Press this key to perform testing once.
- Testing is performed with a trigger from the EXT I/O connector TRIG terminal.

#### **When inputting the trigger signal through the interface:**

Testing is performed once, when the "\*TRG" command is transferred from the interface. For details, see Chapter 6, "RS-232C Interface", or Chapter 6, "Command Reference for 3511-50" of the Instruction Manual for the optional 9518-01 GP-IB INTERFACE.

#### **When inputting the trigger signal through the EXT I/O connector:**

Testing is performed once, each time a negative sense pulse signal is supplied to the EXT I/O connector on the rear panel of the 3511-50. For details, refer to Section 5.1, "Testing Using EXT I/O."

---

# Chapter 4

## Other Functions

---

**4**

---

### 4.1 Comparator Function

With the upper and lower limits of the first and second parameters set, the 3511-50 compares measurements with the upper and lower limits and produces a judgment (HI, IN, or LO)\*, which is then displayed on the comparator judgment display. Moreover, a corresponding signal can be output via the EXT I/O connector on the rear panel of the 3511-50 unit.

\* HI: exceeds the upper limit; IN: within upper and lower limits; LO: below the lower limit

You can set comparator upper and lower limits in the first and second parameters, respectively. The judgment and the output of EXT I/O are displayed for each parameter. The AND result of judgment for both first and second parameters is also output from EXT I/O.

If power is switched off in comparator test mode, switching on the 3511-50 again will start it in comparator test mode.

**NOTE**

- Switching off power in the upper or lower limit setting mode invalidates the set upper or lower limit. If this occurs, the unit defaults to the previous settings.
- For parameters for which comparator judgment is unnecessary, the upper and lower limits can be set to OFF. In such cases, the parameters set to OFF are not compared for judgment.
- Test conditions during comparator execution are as for normal test, with one exception: the AUTO range is automatically switched to the HOLD range.

### 4.1.1 Operation Sequence

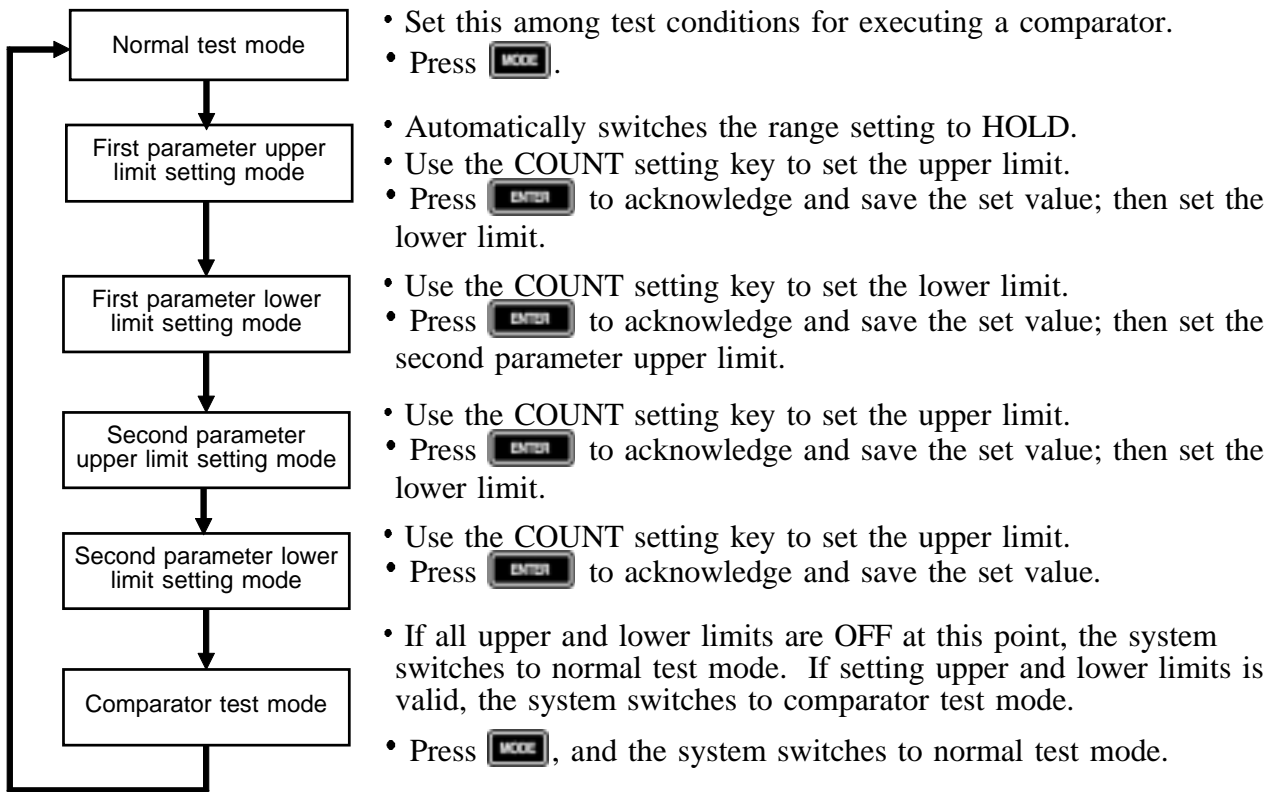



- Set this among test conditions for executing a comparator.
- Press **MODE**.
- Automatically switches the range setting to HOLD.
- Use the COUNT setting key to set the upper limit.
- Press **ENTER** to acknowledge and save the set value; then set the lower limit.
- Use the COUNT setting key to set the lower limit.
- Press **ENTER** to acknowledge and save the set value; then set the second parameter upper limit.
- Use the COUNT setting key to set the upper limit.
- Press **ENTER** to acknowledge and save the set value; then set the lower limit.
- Use the COUNT setting key to set the upper limit.
- Press **ENTER** to acknowledge and save the set value.
- If all upper and lower limits are OFF at this point, the system switches to normal test mode. If setting upper and lower limits is valid, the system switches to comparator test mode.
- Press **MODE**, and the system switches to normal test mode.

### 4.1.2 Setting the Upper and Lower Limits

(1) Press **MODE** to enter a desired setting mode, for either the upper or lower limit.

The current upper and lower limit settings are displayed in the status display next to **MODE**, and in the comparator judgment display.

Conditions being set	Status display 	Comparator judgment display 
First parameter upper limit	"M-HSET" lights.	"HI" lights to indicate the judgment result for the first parameter.
First parameter lower limit	"M-LSET" lights.	"LO" lights to indicate the judgment result for the first parameter.
Second parameter upper limit	"S-HSET" lights.	"HI" lights to indicate the judgment result for the second parameter.
Second parameter lower limit	"S-LSET" lights.	"LO" lights to indicate the judgment result for the second parameter.

Set values are displayed at the following locations.









First parameter upper and lower limits : First parameter measurement display

Second parameter upper and lower limits : Second parameter measurement display

If the upper or lower limit value is set to OFF, the displayed setting will be "----." Upper or lower limit values set to OFF are not used for comparison with a measurement.



- (2) Use the COUNT setting key to change the value digit by digit.



The value in the blinking digit may be altered. Navigate through the digits with the   keys, and through values with the   keys. To set the upper or lower limit to OFF, move the cursor to the left or right end with  . Continue pressing  if the cursor is at the left or  right extremes for 2 s or longer. The display changes to "-----." At the next step, press  to store the OFF setting.

Press the COUNT setting key when "-----" is displayed to redisplay the former value.

**NOTE**

- Upper and lower limits are stored as counts displayed, regardless of test conditions. As test conditions change, the absolute values indicated by the counts change accordingly.
- Use normal test conditions for comparator test conditions. Set upper and lower limits only after setting test conditions for the comparator to be used in normal test mode. For example, to set the upper limit to 0.999  $\mu\text{F}$  when test frequency is 120 Hz and test range is 1.45  $\mu\text{F}$  in C-D display, enter "09990."

- (3) Press  to store the setting, then move to the setting mode for the next upper and lower limits.

If you press  instead of , the mode switches to the next upper and lower limit setting mode without recording the setting.

**NOTE**

- The following verifications are not performed when upper and lower limits are saved. Note that incorrect upper and lower limit settings will produce incorrect judgments.
  1. Is the set value within the parameter display range?
  2. Is the relation between upper and lower limits correct?
- The comparator judgments are made in the following order:
  1. If the measured value is "OVER FLOW", HI is displayed, and the value is "UNDER FLOW", LO is displayed.
  2. Is the measured value greater than the lower limit or not? If not (NG judgment result), then LO is displayed.
  3. Is the measured value lower than the upper limit or not? If not (NG judgment result), then HI is displayed.
  4. If both 2 and 3 give an affirmative result, then IN is displayed.

No judgment is made if both upper and lower limits for a parameter are set to OFF.

### 4.1.3 Comparator Test Mode

Upon completion of all upper and lower limit setting, if upper and lower limit setting is not OFF, the system enters comparator measurement mode and outputs a judgment each time a measurement is made, as a result of comparison between the measurement and the upper or lower limit.

#### (1) Displaying judgment

Judgment for the first and second parameters is displayed in the comparator judgment display.

For parameters for which upper and lower limit setting is OFF, no judgment is displayed.





#### (2) Outputting judgment

- Judgment (LO, IN, or HI) for the first and second parameters and the AND result (valid when both parameters are IN) for both judgments are output from EXT I/O. For details, refer to Section 5.1, "Testing Using EXT I/O."
- Comparator judgments (IN or NG) are indicated by a beep. For more information on setting beeps to indicate judgment, see Section 4.5.3, "Setting Beep."

#### (3) Valid keys

In comparator test mode, test conditions cannot be changed, except for the trigger setting. To change test conditions, press  to switch to normal test mode.

The following are valid keys and key functions:

Key	Function
	Moves to normal test mode.
	Toggles the trigger setting between INT and EXT
	Valid only when trigger setting is EXT Press this once to permit one measurement.
	Moves to the panel LOAD/SAVE screen. You can save current test conditions or load previously saved test conditions.
	Switches key lock functions. Cancels remote mode.

## 4.2 Panel Save Function

The current test conditions may be saved to internal memory, up to a maximum of 99 panels (or combinations) of test conditions.

All the set conditions are saved when panel save is performed, including comparator upper and lower limits and OPEN/SHORT compensation values. You can read saved measurement conditions later with the panel load function.

### 4.2.1 Setting Panel Save

- (1) Press  repeatedly to cycle through available settings: panel load, panel save and normal test (or comparator test) modes. For more information on panel load mode, see Section 4.3, "Panel Load Function."
- (2) Enter panel save mode and specify the panel number to save. In panel save mode, only unsaved panel numbers are displayed. (The panel number at shipment is "01.")

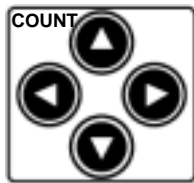

If all panels are used for the saving, when the panel mode is entered, "01" appears.



To overwrite a panel already in use, choose the panel number and correct.

Use the COUNT setting key to specify a panel number.

  keys increase/decrease the value.

  move the cursor to a digit to be set (up to two digits).



The LED for the digit under setting flashes.

**NOTE**

The set values must fall between 01 and 99.

- (3) After specifying a panel number, press . The 3511-50 saves the test conditions and reverts to normal or comparator test mode.

### 4.2.2 Aborting Panel Save

After specifying a panel number in panel save mode, press  instead of . The 3511-50 reverts to normal or comparator test mode without performing the panel save.

**NOTE**

- Under normal conditions of use, the average life of the backup battery for the internal memory is about 6 years.
- If the internal battery becomes exhausted, it is no longer possible to save the test conditions. You should have the battery changed by an approved HIOKI service facility (which is chargeable).

## 4.3 Panel Load Function

You can read or load saved test conditions from internal memory.

### 4.3.1 Setting Panel Load

- (1) Press **LOAD/SAVE** repeatedly to cycle through available settings: panel load, panel save and normal test (or comparator test) modes. For more information on panel save mode, see Section 4.2, "Panel Save Function."
- (2) Enter panel load mode and specify the panel number to load. Use the COUNT setting key to specify a panel number. If no test condition is set, as on shipment or reboot, "--" is displayed as a panel number. In this state, no panel number can be set.

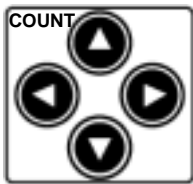

**▲ ▼** keys increase/decrease the value.

**◀ ▶** move the cursor to a digit to be set (up to two digits).

The LED for the digit under setting flashes.

Each time a panel number is specified, the test conditions for the corresponding panel are indicated by the LED lamp. You cannot select panel numbers that are not panel-saved.

**▲ ▼** permit automatic specification of a panel number if it is panel-saved.

**NOTE**

The set values must fall between 01 and 99.

- (3) After specifying a panel number, press **ENTER**. The 3511-50 loads the test conditions and reverts to normal or comparator test mode.

### 4.3.2 Aborting Panel Load

After specifying a panel number in panel load mode, press **LOAD/SAVE** instead of **ENTER**. The 3511-50 moves to panel save mode without performing the panel load. Press **LOAD/SAVE** again. The 3511-50 reverts to normal or comparator test mode.

## 4.4 Key Lock Function

When the key lock is turned on, all key switches on the front panel are disabled to protect settings.

### 4.4.1 Executing the Key Lock Function

Press **LOCK/LOCAL** for 2 s or longer. Use the LED lamp to the right of the second parameter measurement display (SUB PARAMETER) to check on the key lock condition.

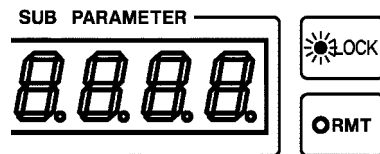

#### NOTE

- In the external trigger mode, the key lock does not apply to **MANU TRIG**. The external trigger can be activated manually.
- The key lock function can be set only in normal or comparator test mode.
- Note that, as long as **LOCK/LOCAL** is kept pressed, the key lock function is activated and inactivated alternately.

### 4.4.2 Cancelling the Key Lock Function

Press **LOCK/LOCAL** for 2 s or longer. The LED lamp goes out to indicate that key lock is canceled.

#### NOTE

Even if the power supply is interrupted, the key lock function is not canceled.

## 4.5 Various Settings Made After Switching on Power

---

Enter settings for conditions related to system reboot (initialization of all test conditions), interfaces, and beep sounds at comparator judgment immediately after switching on power.

---

### 4.5.1 Setting Screen Flow After Power ON

With power turned on, screens are displayed in succession in the following order:

1. All displays light.
2. Version information displayed
3. Interface setting
4. Beep sound setting
5. Test mode (normal test or comparator test)

To change a setting, press the COUNT setting key while screens 3 and 4 are displayed. Press  after screen 1 is displayed and before screen 2 is displayed. The system reboot setting screen appears before screen 3 is displayed.

## 4.5.2 Setting the Interface

You can print measurements by connecting an optional 9442 PRINTER to the RS-232C interface. This is possible only with the EXT trigger. Described below are procedures for switching the RS-232C interface settings to settings appropriate for the 9442 PRINTER and PC connection.

**NOTE**

To use the RS-232C interface, remove the 9518-01 GP-IB INTERFACE before switching on power. If you power on with the board (optional) inserted in the optional board slot, the RS-232C setting screen will not appear. Instead, the system will display "GP-iB" in the first parameter measurement display, and the 3511-50 GP-IB address in the second parameter measurement display.



### Procedures

Once power has been switched on, the 3511-50 displays version information, "rS232" in the first parameter measurement display and settings for the RS-232C interface in the second parameter measurement display for approximately 3 s.

Press the COUNT setting key as this information is displayed to switch the display in the second parameter measurement display between "PC" and "Print."

When connecting a PC and when not using the RS-232C interface, make sure "PC" is displayed. When using a 9442 PRINTER, make sure that "Print" is displayed.

Display in the first parameter measurement display	
--	--

Setting	Display in the second parameter measurement display
When connecting a PC When not using the RS-232C interface	
When using a 9442 PRINTER	

With a 9442 PRINTER, if no key input is made for approximately 3 s, the current setting is acknowledged, and the screen switches to the next screen (the "Beep sound setting" screen).

### 4.5.3 Setting Beep

Set the beep to be sounded when a comparator judgment is made.

The following three modes are available:

1. No beep
2. Beeps when judgment of both first and second parameters is "IN."
3. Beeps when judgment of one of the first or second parameters is not "IN."

#### Procedures

After power is switched on, the system displays the "Interface setting." For approximately 3 s, the system will display "bEEP" in the first parameter measurement display and the desired beep sound setting in the second parameter measurement display.

Press the COUNT setting key during this display. The indication in the second parameter measurement display cycles through "oFF," "in" and "Lo-Hi." If no key input occurs for 3 s, the current setting is acknowledged, and the system enters measurement mode.

Display in the first parameter measurement display	bEEP
--	------



Setting	Display in the second parameter measurement display
No beep	oFF
Beeps when judgment of both first and second parameters is "IN."	in
Beeps when judgment of one of the first or second parameters is not "IN."	Lo-Hi





## 4.5.4 Executing System Reboot



All test conditions are initialized to the conditions in force at shipment. All measurement conditions include panel-saved conditions.

### Procedures

Restart the 3511-50 while pressing . All displays will light, and in approximately 1.5 s, the Section switches to the version information screen. You can release the  key when this occurs.

The 3511-50 displays version information, "rESEt" in the first parameter measurement display and "no" in the second parameter measurement display.

Display in the first parameter measurement display	
Setting	Display in the second parameter measurement display
No system reboot	
System reboot	

Press the COUNT setting key to switch the display in the second parameter measurement display between "no" and "YES." Press  in either state. Pressing  in the "YES" state initializes all test conditions to the conditions in force at shipment and switches the screen to "Interface setting."

The conditions in force at shipment are as follows:

Test mode	Normal test mode
Test parameters	Z -θ
Test frequency	1 kHz
Test signal level	1 V
Test speed	NORM
Equivalent circuit mode	AUTO
Test range	AUTO
Open circuit compensation	OFF
Short circuit compensation	OFF
Trigger mode	INT (Internal trigger)
Key lock function	OFF
Beep sound setting	OFF (when a comparator judgment is made)
Panel save	All contents clear
Comparator	Upper and lower limits for the first and second parameters both OFF

---

## 4.6 Remote Function

---

### 4.6.1 Remote Mode

External control via an interface will place the 3511-50 in remote mode (remote control state), in which front panel key switch operations are disabled.

Use the LED lamp to the right of the second parameter measurement display (SUB PARAMETER) to check on the remote mode condition. This LED lamp lights when the 3511-50 enters remote mode.

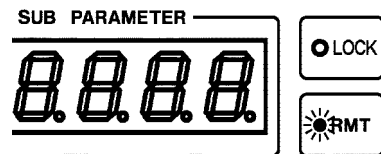

---

### 4.6.2 Cancelling the Remote Mode

Press  to cancel the remote mode. The LED lamp goes out to indicate that remote mode is canceled.

---

## 4.7 The Residual Charge Protection Function

**⚠ CAUTION**

- The quoted maximum voltage from which the unit can be protected by this function is for reference purposes only, and is not a guaranteed value. There may be danger of damage to the 3511-50 unit, depending upon the operational circumstances and upon how often such charged capacitors are connected. In general, you should not rely upon this protection function; be sure to discharge charged capacitors properly before connecting them to the test terminals.
- The residual charge protection function is for protection of the 3511-50 unit against the discharge of voltage present in charged capacitors, and is not capable of protecting the unit against DC voltage which is constantly applied such as a superimposed DC voltage. (The maximum voltage for supply to the test terminals of the 3511-50 unit is 40 VDC.) If this is done, there is a danger of damage to the unit. (For how to supply a DC bias voltage, refer to Section 5.2, "Supplying DC Bias".)

---

The 3511-50 has been enhanced by the incorporation of a residual charge protection function. If by mistake a charged capacitor is connected to the test terminals, this function protects the internal circuitry of the unit from discharge of such residual charge.

The maximum voltage from which the unit can be protected by this function is determined from the capacitance value of the sample under test by the following equation:

$$V = \sqrt{\frac{1}{C}}$$

V: Voltage (volts) (maximum 400 VDC)  
C: Capacitance (farads)



# Chapter 5

## Applications



5

### 5.1 Testing Using EXT I/O

#### 5.1.1 The EXT I/O Connector

This is a connector for output of comparator result signals, of a measurement finished signal (EOM), and of an analog measurement finished signal (INDEX), and for input of an external trigger signal, and a signal for performing selection of the number of the panel to be loaded.

Connector used :

57RE-40360-730B (D29) (made by DDK)

Compatible connector:

57-30360 (solder cup connector without rib, made by DDK)

57-30360R (solder cup connector with rib, made by DDK)

RC30-36P (made by HIROSE ELECTRIC CO.,LTD.)

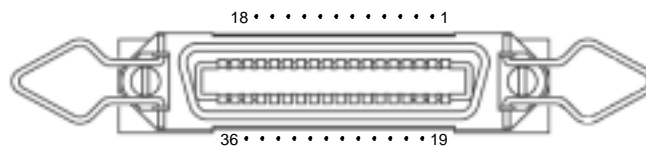

EXT I/O Connector pin numbering (seen from 3511-50)

## 5.1.2 Pinouts for the EXT I/O Connector

Pin number	I/O	Signal line name	Pin number	I/O	Signal line name
1	IN	TRIG	19	IN	BCD00
2	IN	BCD01	20	IN	BCD02
3	IN	BCD03	21	IN	BCD10
4	IN	BCD11	22	IN	BCD12
5	IN	BCD13	23	OUT	$\overline{\text{M-HI}}$
6	OUT	$\overline{\text{M-IN}}$	24	OUT	$\overline{\text{M-LO}}$
7	OUT	$\overline{\text{S-HI}}$	25	OUT	$\overline{\text{S-IN}}$
8	OUT	$\overline{\text{S-LO}}$	26	OUT	$\overline{\text{AND}}$
9	OUT	$\overline{\text{INDEX}}$	27	OUT	$\overline{\text{EOM}}$
10	-	Unused	28	-	Unused
11 to 14	IN	EXT DCV	29 to 32	OUT	INT DCV
15 to 18	IN	EXT COM	33 to 36	OUT	INT GND

### 5.1.3 Signal Lines for the EXT I/O Connector

**NOTE**

All input and output signals excluding BCD 00 to 03, BCD 10 to 13, and the power supply are all negative logic.

(1)  $\overline{\text{TRIG}}$

When the 3511-50 is set to external trigger mode, a negative logic signal is input from outside via this line. Testing is initiated once when this signal goes low level.

(2) BCD00, BCD01, BCD02, BCD03

For the panel number to load, choose the ones digit.

When a trigger signal is input in external trigger mode, the panel chosen is read and measurement begins.

(3) BCD10, BCD11, BCD12, BCD13

Choose the tens digit for the panel number to be loaded.

When a trigger signal is input in external trigger mode, the panel chosen is read and measurement begins.

BCD	Digit of 10				Digit of 1			
	BCD13	BCD12	BCD11	BCD10	BCD03	BCD02	BCD01	BCD00
0	0	0	0	0	0	0	0	0
1	0	0	0	1	0	0	0	1
2	0	0	1	0	0	0	1	0
3	0	0	1	1	0	0	1	1
4	0	1	0	0	0	1	0	0
5	0	1	0	1	0	1	0	1
6	0	1	1	0	0	1	1	0
7	0	1	1	1	0	1	1	1
8	1	0	0	0	1	0	0	0
9	1	0	0	1	1	0	0	1

All other combinations are invalid.

Example: When reading panel 15, set "0001 0101."

\*1 \*2 \*1: Digit of 10, \*2: Digit of 1

**NOTE**

Because the open state is "1", when specifying the panel number, be sure to set all signals.

(4)  $\overline{\text{M-HI}}$ ,  $\overline{\text{M-IN}}$ ,  $\overline{\text{M-LO}}$

These lines output the comparator result for the first parameter.

(5)  $\overline{\text{S-HI}}$ ,  $\overline{\text{S-IN}}$ ,  $\overline{\text{S-LO}}$

These lines output the comparator result for the second parameter.

(6)  $\overline{\text{AND}}$

This line outputs the logical AND of the comparator results for the first parameter and for the second parameter. This signal is output only if both the comparator results are IN.

(7)  $\overline{\text{INDEX}}$ 

Output during analog measurement. When testing speed setting is FAST and the range is HOLD, the sample can be changed after this signal is switched off (i.e., after start-up edge).

**NOTE**

- $\overline{\text{INDEX}}$  signal is output at each time of retest. If a measurement is made in AUTO range mode, the  $\overline{\text{INDEX}}$  signal may be output two or more times.
- If the testing speed is NORM or SLOW, the  $\overline{\text{INDEX}}$  signal is output two or more times to execute analog measurement more than once.
- When changing a sample via the  $\overline{\text{INDEX}}$  signal, set the testing speed to FAST and measure in the HOLD range.

(8)  $\overline{\text{EOM}}$ 

End of measurement signal.

## (9) EXT DCV, EXT COM

These are terminals for supplying a power supply voltage from an external device. This enables the 3511-50 unit to be connected to an external device while maintaining the isolation. The range of power voltage which can be connected is from 5 to 24 VDC.

## (10) INT DCV, INT COM

These lines output +5 VDC and COM from the 3511-50 unit.



## 5.1.4 Circuit Construction and Connections for the EXT I/O Connector

### ⚠ CAUTION

- The voltage of the external DC power supply to be connected to the EXT DCV and EXT COM terminals should be from 5 V to 24 V. Do not supply DC voltage greater than 24 V. If you do, there is a danger of damage to the unit.  
Moreover, for driving the circuitry, connect any device which is capable of providing an output current of more than 200 mA.
- The insulation of the signal lines is for eliminating mutual influences between the signals. Any device which is connected to the 3511-50 unit should always be properly protectively grounded. If proper connection to a protective ground is not established, there is a danger of damage to the insulation.

The circuit construction for the EXT I/O connector is shown in the figure. Except for the power supply lines, all of the input and output signal lines are insulated by photocouplers.

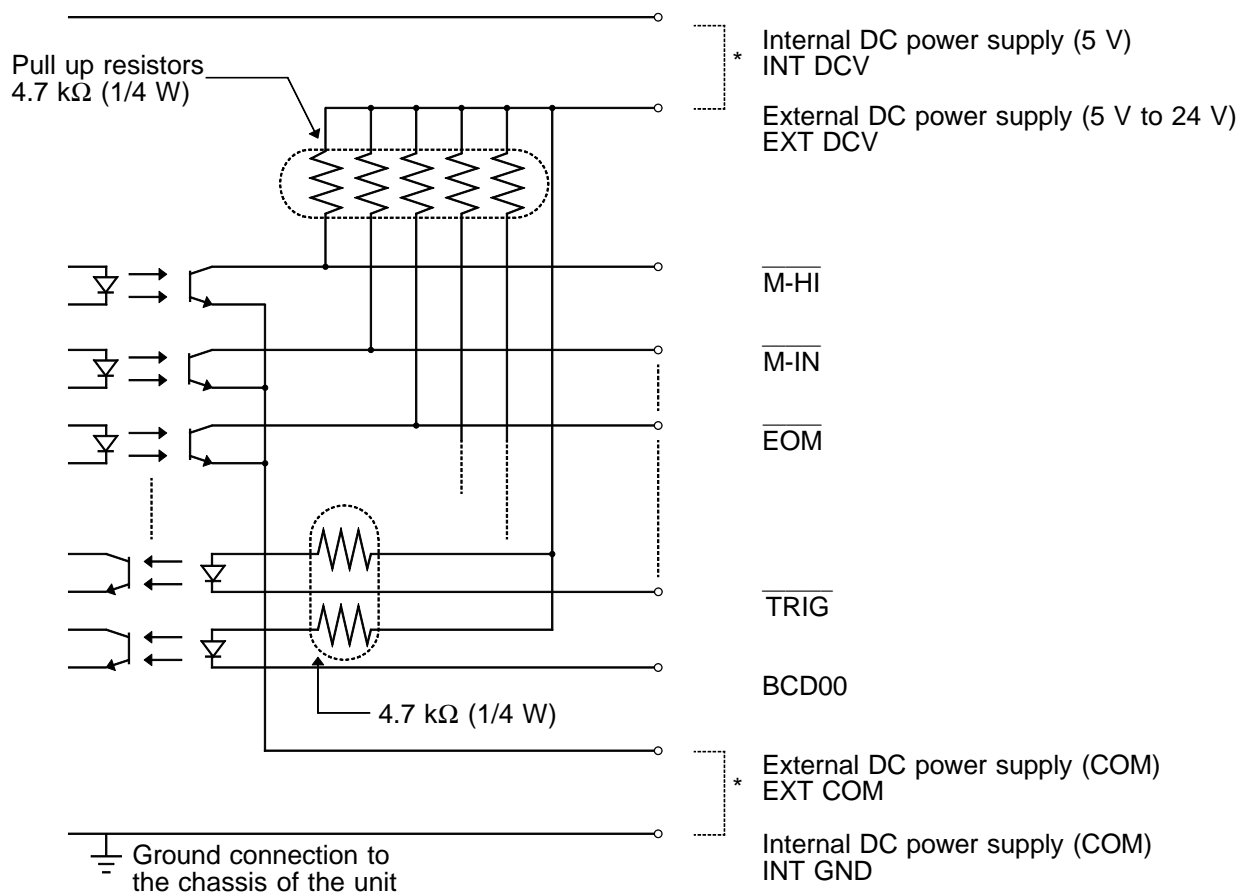

\* Can be connected when using the internal 5 V power supply.

Circuit construction

**NOTE**

- The internal DC power supply of 5 VDC is provided between INT DCV and INT GND. The maximum current capacity is 100 mA. Do not connect any external circuit whose current consumption is greater than 100 mA.
- INT GND is grounded to the chassis of the 3511-50 unit.
- The output signal low level output current is a maximum of 60 mA. If a current greater than this is required, you should connect a transistor circuit using a current amplifier driven by an external power source or the like externally.

---

## 5.1.5 Electrical Characteristics of the Output Signals

The output signals are the collector outputs of the photocouplers, and are connected to the external DC power supply (EXT DCV) via 4.7 k $\Omega$  pull-up resistors provided internally to the 3511-50 unit.

The relationship between the external DC power supply voltage, the voltage of the output signals, and the current, is as shown in the following table:

External DC power supply voltage	Output signals (internal pull-up resistors 4.7 k $\Omega$ )			
	High level	Low level		
		Output current 10 mA	Output current 40 mA	Output current 60 mA (max.)
5 V	5 V	0.9 V	1.1 V	1.2 V
12 V	12 V	0.9 V	1.1 V	1.2 V
24 V	24 V	0.9 V	1.1 V	1.2 V

Direct connection of a circuit whose input voltage  $V_{IL}$  is a maximum of 0.8 V or more is not possible.

In such a case, keep  $V_{IL}$  below 0.8 V by incorporating a transistor or a drive capable buffer circuit or the like.

## 5.1.6 I/O Signal Timing

With the test conditions for testing by the comparator having been set (with the trigger setting set to external trigger), when in this state a trigger signal is input via the EXT I/O connector, or when the **MANU TRIG** key is pressed, then the decision result is output on the comparator result output signal line of the EXT I/O connector.

An example of testing timing is as follows:

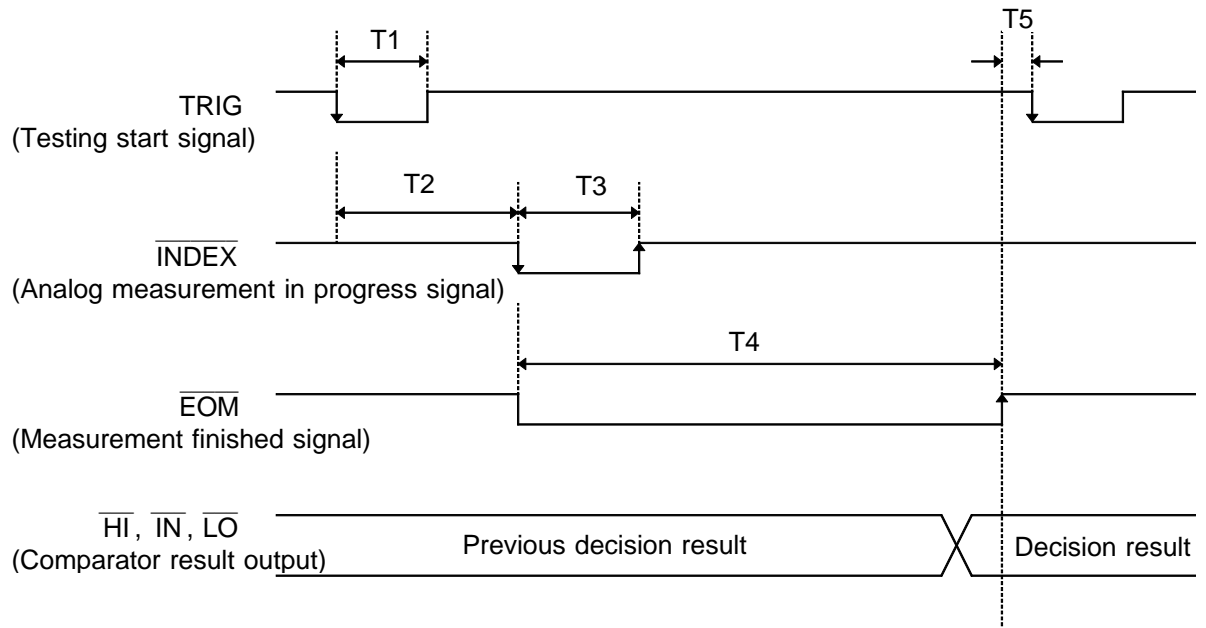

Symbol	Meaning	Timing (approximate)
T1	TRIG width (LOW) Minimum time period that trigger signal is low	100 $\mu$ s
T2	From TRIG (LOW) to INDEX (LOW) Time period from trigger to circuit response	500 $\mu$ s* <sup>1</sup>
T3	INDEX width (LOW) Minimum chucking time; chucking switching on INDEX (HIGH) possible	1 ms* <sup>2</sup>
T4	EOM width (LOW) Time period for testing	5 ms* <sup>2</sup>
T5	From EOM (HIGH) to TRIG (LOW) Minimum time period from end of testing to next trigger	0 s

\*1: With the panel load function, when a new panel number is loaded, the response time takes about 1 second.

\*2: Reference value with the following conditions; test frequency: 1 kHz, testing speed:FAST, and when measuring |Z|.

## 5.1.7 Time Taken for Testing

The time taken for testing varies according to the test conditions. The following values may be used for reference.

**NOTE**

These values are all for reference only. Do not rely upon them absolutely, because the actual time taken for testing depends upon many operational conditions.

(1) Analog testing signal (INDEX)

The output time (T3) of the analog testing signal (INDEX) taken according to the testing speed:

Measurements are averaged if the testing speed setting is NORM or SLOW. The INDEX signal is output for the number of times indicated in the table below.

Testing speed \ Test frequency	FAST		NORM		SLOW	
	T3	Number of times	T3	Number of times	T3	Number of times
120 Hz	8.3 ms	1	17 ms	4	67 ms	5
1 kHz	1 ms	1	4 ms	7	8 ms	24

(2) Testing finished signal (EOM)

Use the following equation to obtain the output time of the testing finished signal (EOM):

$$T4 = (A) + (B) + (C) + (D)$$

(A) The time taken for testing for Z-θ display, normal test mode, open/short circuit compensation off, and HOLD range:

Testing speed \ Test frequency	FAST	NORM	SLOW
120 Hz	13 ms	90 ms	400 ms
1 kHz	5 ms	60 ms	300 ms

(Allowance ±2 ms)

(B) The time taken for calculation varies according to the display parameters:

Testing speed \ Test frequency	Z-θ	C-D	L-D/Q	R
120 Hz	0 ms	1.5 ms	1.5 ms	1 ms
1 kHz	0 ms	1.5 ms	1.5 ms	1 ms

(Allowance ±2 ms)

- (C) The time taken for calculation varies according as to whether or not both open circuit compensation and also short circuit compensation are performed:

Open/short circuit compensation	Calculation time
Open and/or short circuit compensation performed	1 ms
Not performed	0 ms

(Allowance  $\pm 0.5$  ms)

- (D) The time taken for calculation varies according as to whether or not the comparator is operating:

Comparator operating	Calculation time
Normal testing	0 ms
When the comparator is operating	0.1 ms

(Allowance  $\pm 0.1$  ms)

## 5.2 Supplying DC Bias

---

**⚠ CAUTION**

The maximum voltage which can be applied to the test terminals of the 3511-50 unit is 40 V DC. If a DC voltage greater than this is applied continuously, the unit may be damaged.

---

Supplying DC bias means that a DC voltage is supplied as a bias to a sample for test whose characteristics are voltage dependent, such as an electrolytic capacitor or a ceramic capacitor.

Further, a DC current can be supplied as a bias to a sample for test whose characteristics are current dependent, such as a choke coil.

Since the 3511-50 unit has no DC bias input terminals, a DC bias must be supplied in the manner described in the following sections.

## 5.2.1 How to Supply a DC Bias Voltage

### CAUTION

- In order to avoid electric shock accident, be absolutely sure not to touch the test terminals while the DC bias voltage is being supplied to them.
- If you disconnect the sample under test from the test terminals with the DC bias voltage still being supplied, then the test sample is left charged, which is very dangerous. In order to avoid electric shock accident, be absolutely sure to discharge the test sample.
- Do not short circuit between the clips of the test probes with the DC bias voltage still being supplied. Doing so may damage the probes or cause a short circuit accident.

To supply a DC bias voltage to a capacitor or the like, proceed as follows. Use the optional 9268 DC BIAS VOLTAGE UNIT.

For details on using the 9268, refer to the Instruction Manual of the 9268. (Depending on the test frequency, test signal level, and test range, the 9268 cannot be used.)

If the 9268 is not used, refer to the following.

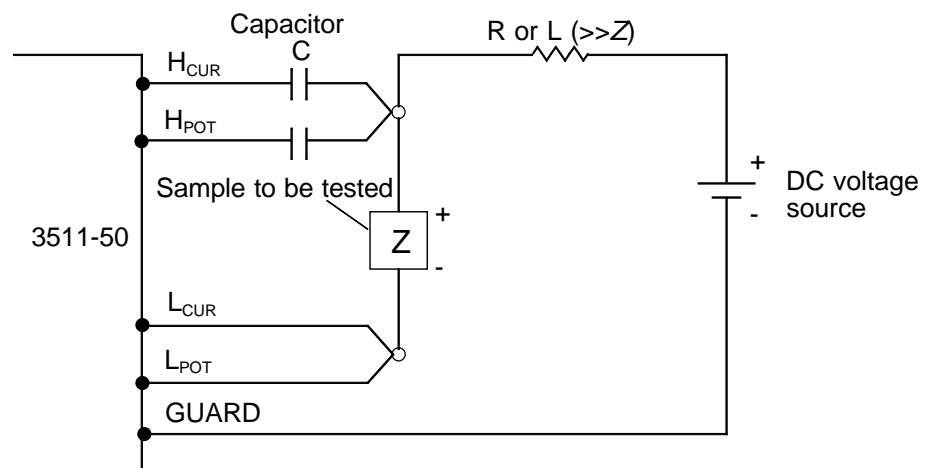

DC Bias Voltage Circuit

- Use a resistance (R) or inductance (L) which has a large enough impedance with reference to the sample under test (Z).
- Use a capacitor (C) which has a small enough impedance (i.e., a large enough capacitance) with reference to the sample under test (Z).
- Be careful about the polarity when connecting together the probes, the sample to be tested, and the DC voltage source.
- It takes a little time for the DC voltage which is being supplied to the sample under test to reach the set voltage, so you should wait for a certain stabilization time period (which depends upon the sample) before performing testing. Be careful, because if you perform testing before this stabilization time period has elapsed, the results will not be reliable.
- After testing is completed, drop the voltage of the DC voltage source to zero, and remove the sample under test from the probes after having discharged any electric charge which may have built up.
- If you have removed the sample under test from the probes without first having discharged the accumulated electric charge, you should be careful to do so immediately.

## 5.2.2 How to Supply a DC Bias Current

### ⚠ CAUTION

- In order to avoid electric shock accident, be absolutely sure not to touch the test terminals while the DC bias is being supplied to them.
- Do not short circuit between the clips of the test probes with the DC bias still being supplied. Doing so may damage the probes or cause a short circuit accident.

To supply a DC bias, use the optional 9269 DC BIAS CURRENT UNIT. For details on using the 9269, refer to the Instruction Manual of the 9269. (Depending on the test frequency, test signal level, and test range, the 9269 cannot be used.)

If the 9269 is not used, refer to the followings.

To supply a DC bias current to a transformer or a choke coil or the like, construct an external bias circuit as follows. (For details, refer to JIS C-6435.)

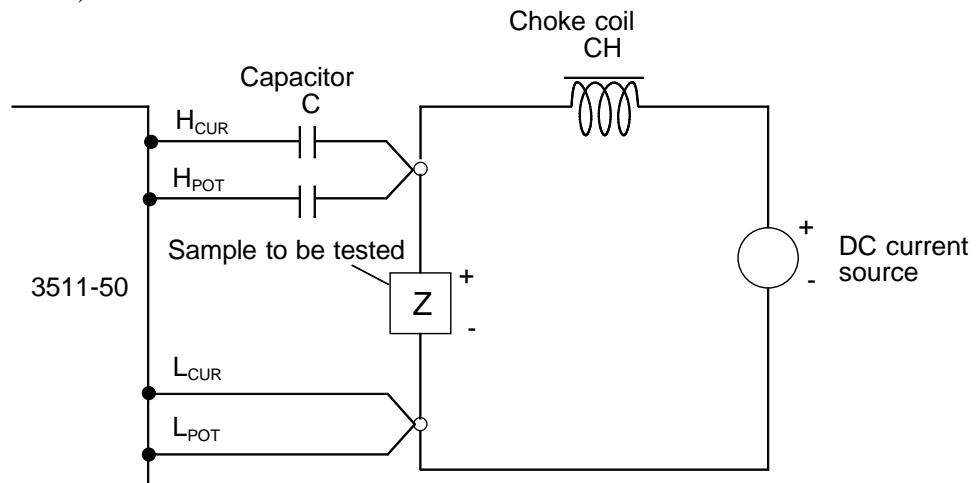

DC Bias Current Circuit

- Use a choke coil (CH) which has a large enough impedance with reference to the sample under test (Z).
- Use a capacitor (C) which has a small enough impedance (i.e., a large enough capacitance) with reference to the sample under test (Z).
- Be careful about the polarity when connecting together the probes, the sample to be tested, and the DC current source.
- Be careful not to magnetically saturate the choke coil (CH) with the DC bias current.
- It takes a little time for the DC current which is being supplied to the sample under test to reach the set value, so you should wait for a certain stabilization time period (which depends upon the value of the capacitor (C)) before performing testing. Be careful, because if you perform testing before this stabilization time period has elapsed, the results will not be reliable.



## 5.3 9442 PRINTER (Option)

The test values are printed out.

Use with the optional 9442 PRINTER, and 9444 CONNECTION CABLE.

### 5.3.1 Preparation

Use the 9442 PRINTER, the 9443\* AC ADAPTER, and the 1196 RECORDING PAPER. To connect the main unit and printer, use the 9444 CONNECTION CABLE. (All are options.)

9442	DPU-414	Seiko Instruments Inc.
*9443-01	PW-4007-J1	Seiko Instruments Inc. (for Japan)
*9443-02	PW-4007-E1	Seiko Instruments Inc. (for EU)
*9443-03	PW-4007-U1	Seiko Instruments Inc. (for U.S.A.)

#### Setting the 9442 PRINTER communication conditions

Change the settings of the software dip switches (DIP SW) to use the 9442 for the 3511-50.

#### **CAUTION**

- The 9442 is shipped with the function settings for use with the HIOKI 3166 CLAMP ON POWER HiTESTER. Before using, always change the settings of the DIP switches.
- For details on the operations and handling of the printer, refer to the operation manual supplied to the printer.
- For the printer, use the 1196 RECORDING PAPER (thermal paper, 10 rolls) or an equivalent.

- (1) Turn off the power.
- (2) Turn on the power while pressing the ON LINE button. Release the button after a list of the current settings starts printing out.
- (3) The print out of the current settings is followed by the prompt: "Continue? :Push 'On-line SW'", "Write?:Push 'Paper feed SW'". Press the ON LINE button to change the settings.
- (4) "Dip SW-1" is printed to make a settings for switch number 1 to 8 of DIP SW1. Refer to the next table.

### Software DIP SW1

■: Use these settings for the 3511-50

Switch No.	Function	ON (ON LINE)	OFF (FEED)
1	Input method	Parallel	Serial
2	Printing speed	High	Low
3	Auto loading	Enable	Off
4	CR function	Carriage return and line feed	Carriage return
5	DIP SW setting command	Enable	Disable
6	Printing density (set to 100%)		OFF
7		ON	
8		ON	

To set to ON, press the ON LINE button once and to set to OFF, press the FEED button once.

The setting is printed out after the ON LINE or FEED button is pressed to allow to confirm the new setting. To change the settings, repeat from step (1). When the setting for switch number 8 is made, the printer once again prompts with "Continue? :Push 'On-line SW'", "Write?:Push 'Paper feed SW'".

- (5) Set the switch number 1 to 8 of DIP SW 2 and 3 in the same way from step (3) referring to the following tables.

### Software DIP SW2

Switch No.	Function	ON (ON LINE)	OFF (FEED)
1	Print mode	Normal printing (40 columns)	Condensed printing (80 columns)
2	User-defined characters back-up	Enable	Disable
3	Character type	Ordinary characters	Special characters
4	Zero font	0	∅
5	International character set	ON	
6		ON	
7		ON	
8		ON	

## Software DIP SW3

Switch No.	Function	ON	OFF
1	Data bit length	8 bits	7 bits
2	Parity permission	None	With parity
3	Parity condition	Odd	Even
4	Flow control	H/W BUSY	XON/XOFF
5	Baud rate (19200 bps)		OFF
6		ON	
7		ON	
8			OFF

- (6) After setting for the switch number 8 of DIP SW 3 is made, press the ON LINE or FEED switch to complete settings. "Dip SW setting complete!!" is printed out.

## 5.3.2 Connection Method

**⚠ WARNING**

To avoid electrocution, turn off the power to all devices before plugging or unplugging any cables or peripherals.

- (1) Set the 9442 PRINTER referring to Section 5.3.1, "Preparation."
- (2) Connect the 9444 CONNECTION CABLE between the main unit and the printer.

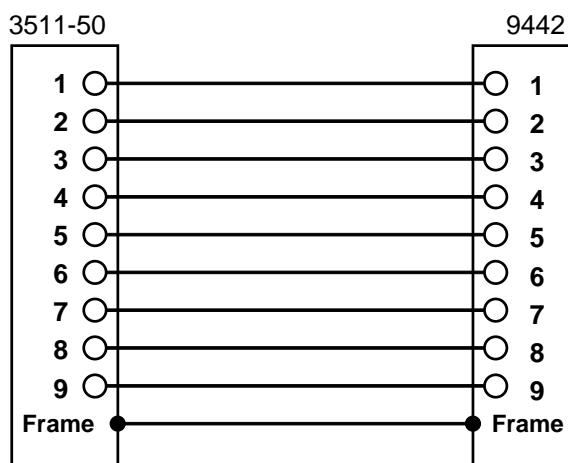

---

### 5.3.3 Printing Results

When the external trigger is set, the test values are printed out after the test is completed.

#### 1. Normal test

C	100.03n	F	D	0.0004
C	100.02n	F	D	0.0003

#### 2. Comparator operating

C	100.05n	F	HI	D	0.0005	HI
C	100.04n	F	IN	D	0.0003	IN

---

## 5.4 Testing High Impedance Elements

The measured value obtained when testing a high impedance element (such as, for example, a resistor with resistance higher than 100 k $\Omega$ ) is sometimes unreliable, because such an element is vulnerable to the effects of external interference and the like. In this case, reliable testing can be performed by the use of guarding, that is, connecting a metallic plate to the GUARD terminal and carrying out the measurement on the metallic plate.

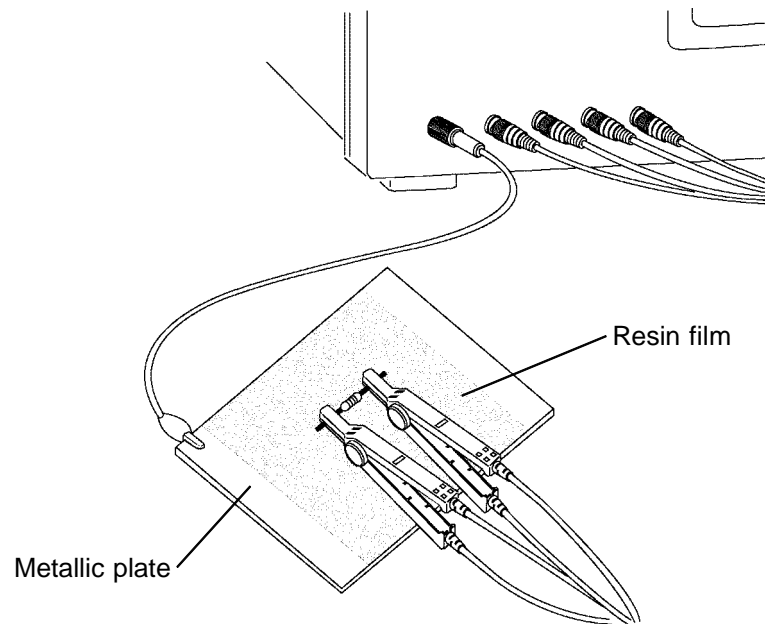

When testing against a metallic plate, the surface of the plate should be covered by a film of resin or the like, in order to prevent short circuiting together the terminals.

When the open circuit compensation is performed always execute the guarding process because of high impedance elements testing. If not, the compensation values do not stabilize. It is not possible to obtain the reliable measured value.

## 5.5 Testing an Element in a Circuit

Test an element in a circuit after guarding.

Referring to the following figure, when measuring a resistance value for the resistor  $R_2$ , even if the tips of the two probes are contacted against the ends of the resistor  $R_2$ , considering the sum of the current flowing through the resistor  $R_2$  and the current flowing through the resistors  $R_3$  and  $R_4$ , what is obtained is the resistance value for the parallel combination:

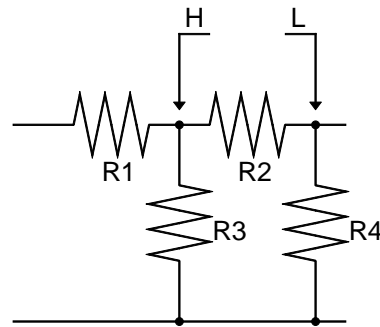

$$R = R_2 \times \frac{R_3 + R_4}{R_2 + R_3 + R_4}$$

If as shown in the next figure a guard terminal is used, the current flowing through the resistors  $R_3$  (not flowing through  $R_4$ ) is absorbed by this guard terminal, so that the resistance value for the resistor  $R_2$  is accurately measured.

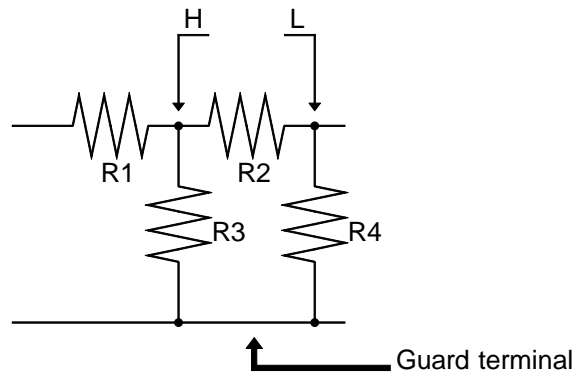

**NOTE**

- The accuracy of measurement will not be improved in cases where for example  $R_2 \gg R_3$  and  $R_3$  is close to zero.
- As shown in the figure below, it is not possible to use this type of separation process for testing of the impedance values of two resistors or other elements of identical types which are connected in parallel, or for testing of the impedance values of a coil and a capacitor which are connected in parallel.

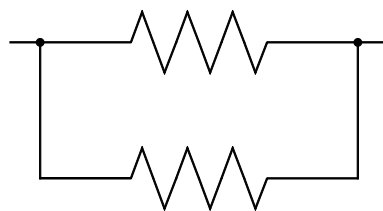

Two resistors in parallel

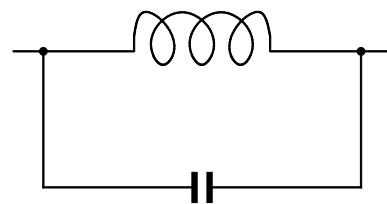

Coil and capacitor in parallel

---

## 5.6 External Interference

The 3511-50 is designed to be resistant to errors caused by interference from the test cables or the power supply line. However, if the level of the interference is particularly large, this can cause measurement errors or faulty operation.

Refer to the examples given below for examples of countermeasures which can be taken against interference which has caused faulty operation etc.

---

### 5.6.1 Countermeasures Against Interference from the Power Supply Line

If noise is present in the power supply line, its influence can be moderated by the following countermeasures:

(1) Grounding by using a protective ground wire

The 3511-50 unit is constructed so as to be provided with protective grounding via the ground lead in the power cord.

This protective grounding serves the important function, not only of avoiding the possibility of electric shock to the operator, but also of eliminating noise from the power supply line by the provision of an internal filter.

Be sure to connect the 3511-50 unit to a properly 3-wire power supply socket, using the grounded power cord which is supplied with the unit.

(2) Inserting a noise filter in the power supply line

Any excessive noise present in the power supply line can be suppressed by purchasing a socket type noise filter (generally available commercially) which can be inserted into the power supply socket, with the 3511-50 unit connected to the output of the noise filter.

Various types of such socket type noise filters are readily available from specialist manufacturers.

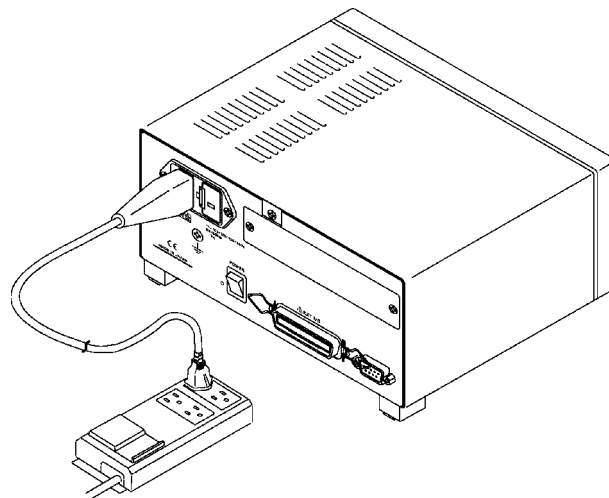

(3) Fitting an anti-interference ferrite core on the power cord

Pass the power cord through a commercially available anti-interference ferrite core, and fix it on the power cord as close as possible to the AC power inlet of the 3511-50 unit, so as to suppress noise from the power supply line. Further benefit can often be obtained by fitting another anti-interference ferrite core on to the power cord at its other end, as close as possible to the plug which connects to the power supply outlet. Moreover, if the internal diameter of the ferrite core allows, winding the power cord several times around the ferrite core may further reduce the amount of noise. Various types of such anti-interference ferrite cores or ferrite beads are readily available in the market from specialist manufacturers.

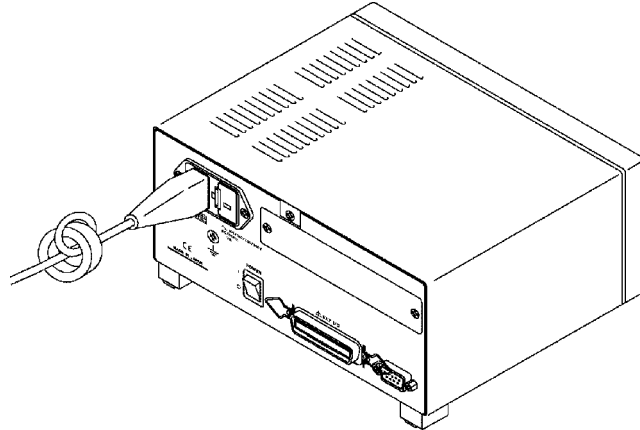

## 5.6.2 Countermeasures Against Noise from the Test Cables

If interference is producing noise in the test cables, its influence can be moderated by the following countermeasure.

### Fitting an anti-interference ferrite core on the test cables

Pass the test cables through a commercially available anti-interference ferrite core, and fix it close to the test terminals, so as to suppress noise from the test cables.

Moreover, if the internal diameter of the ferrite core allows, winding the test cables several times around the ferrite core (as with the power cord as described above) may further reduce the amount of noise.

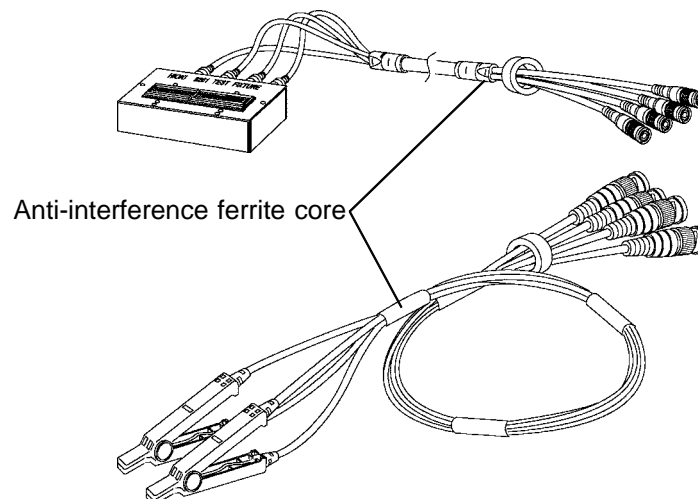



---

# Chapter6

## RS-232C Interface

---

---

### 6.1 Overview

---

#### 6.1.1 Introduction to the RS-232C Interface

It is possible to control all the functions of the 3511-50 (except for powering on and off) via the RS-232C bus.

## 6.1.2 Specifications

Transfer system	Start-stop synchronization		
Baud rate	9600 bps		
Data length	8 bits		
Parity	None		
Stop bits	1 bit		
Delimiter	CR+LF		
Handshake	hardware		
Electrical characteristic	Input voltage levels	ON	5 V to 15 V
		OFF	-15 V to -5 V
	Output voltage levels	ON	5 V to 9 V
		OFF	9 V to -5 V

### RS-232C connector

The connector on the 3511-50 is for terminal (DTE). Connect the RS-232C cable.

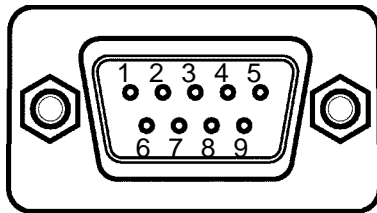

RS-232C interface connector pin assignments  
(D-subminiature 9-pin male)

### Signal assignments and explanation

Connector (Dsub) pin number	Circuit		Description
	RS-232C	CCITT	
1	---	---	Unused
2	BB(RxD)	104	Received Data
3	BA(TxD)	103	Transmitted Data
4	CD(DTR)	108/2	Data Terminal Ready
5	AB(GND)	102	Signal Ground
6	---	---	Unused
7	CA(RTS)	105	Request to Send
8	CB(CTS)	106	Clear to Send
9	---	---	Unused

## 6.2 Connecting Method

### ⚠ WARNING

In order to avoid electric shock, turn off the power to all devices before plugging in or unplugging the RS-232C connector.

### ⚠ CAUTION

- To avoid damage to the unit, do not short the connector and do not input voltage to the connector.
- Always fix the screws to connect the RS-232C cable.

When connecting the controller (DTE), use a cross cable which meets the connector specifications of both sides of the 3511-50 and the controller. Commands that contain data must be input in the specified data format. Refer to Chapters 3 to 5 for details about the various functions.

### Example

When connecting to the controller using a D-subminiature 9-pin connector

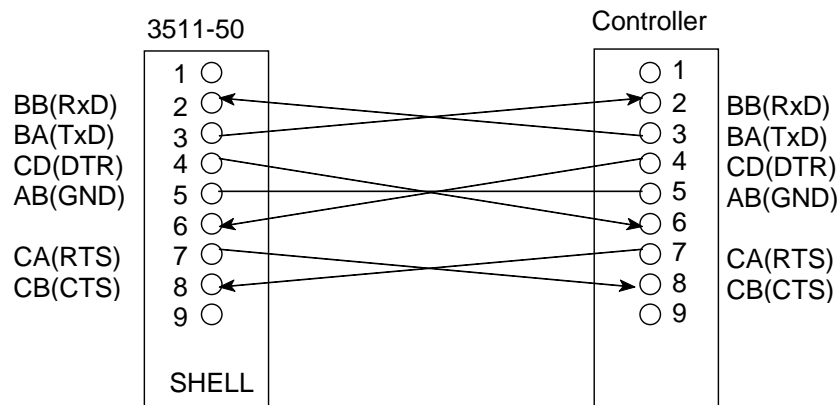

Specification: D-subminiature 9-pin female to D-subminiature 9-pin female connectors, with "crossed" data connections

## 6.2.1 Handshake

### Buffer flow control

#### (1) Controls when receiving

When the receiving buffer is more than 85 % full, CA (RTS) is set to OFF to indicate to the controller that the empty buffer capacity is low.

Processing of data in the buffer continues, and when the receiving buffer is less than 25 % full, CA (RTS) is set to ON to indicate to the controller that there is ample buffer capacity.

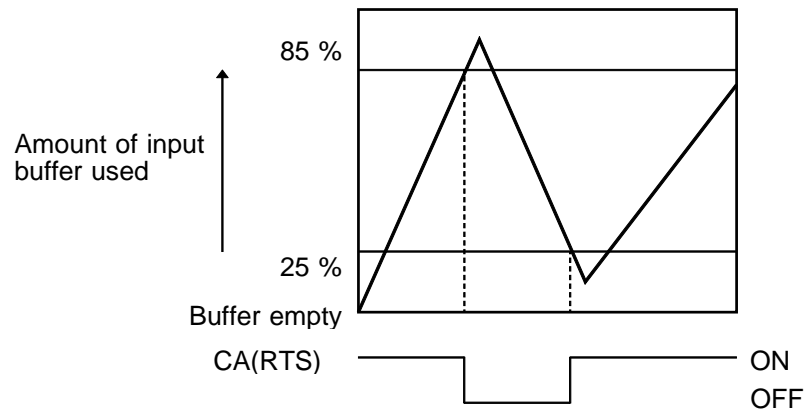

#### (2) Controls when transmitting

When CB (CTS) is found to be OFF, transmission is suspended; it is found to be ON transmission resumes.

## 6.3 Operation

### 6.3.1 Communication Methods by the RS-232C

In order to control the 3511-50 by the RS-232C, there are several kinds of messages.

Of these, program messages are those received by the 3511-50 from the computer, while response messages are those sent from the 3511-50 to the computer.

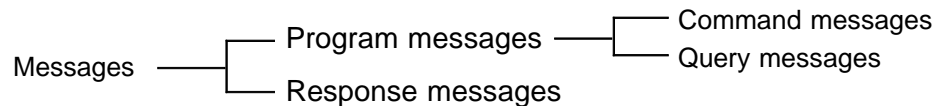

#### (1) Program messages

Program messages are command messages or query messages.

- **Command messages** are orders for controls of the 3511-50, such as for making measurement condition settings or for reset or the like.

Example :FREQUENCY <data>

(Command message which sets the frequency)

- **Query messages** are orders for responses relating to results of operation, results of measurement, or the state of 3511-50 settings. A question mark "?" is suffixed at the end of the command.

Example :FREQUENCY?

(Queries the current frequency)

#### (2) Response messages

It represents the response data for query messages from the 3511-50.

Example :FREQUENCY 1000

(Current frequency is 1 kHz.)

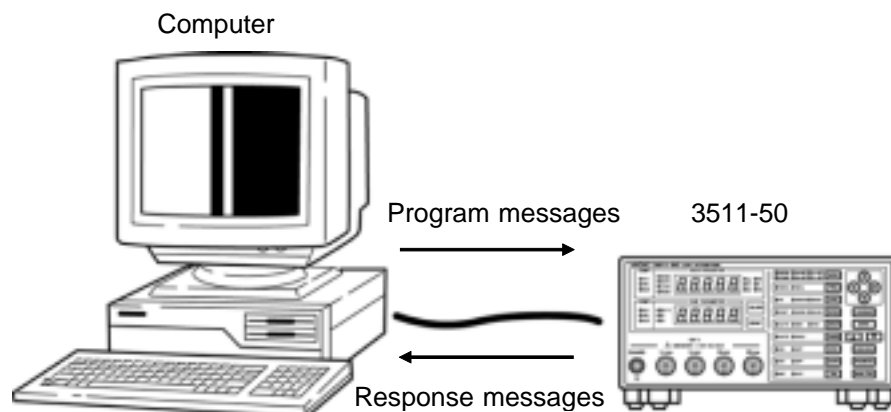

## 6.3.2 Message Format

The commands for the 3511-50 are as far as possible mnemonic. Furthermore, all commands have a long form, and an abbreviated short form.

## 6.3.3 Program Message

The program message is made up from header and data portions.

Example Command message to set frequency to 1 kHz

```
:FREQUENCY 1000
```

```

  ↑   ↑   ↑
  1   2   3

```

**1** Header portion

**2** Space separating header portion and data portion.

**3** Data portion (ASCII-format text or numeric values.

Some messages have no data portions...query messages, etc.)

A command header can be abbreviated. The whole command form is referred to as the "long form" and the abbreviated form as the "short form." In this manual, the short form is written in upper case letters, and then this is continued in lower case letters so as to constitute the long form. Either of these forms will be accepted during operation, but intermediate forms will not be accepted. Further, during operation both lower case letters and upper case letters will be accepted without distinction.

For "FREQUENCY", either "FREquency" (the long form) or "FREQ" (the short form) will be accepted. However, any one of "FREQU", or "FRE" is wrong and will generate an error.

## 6.3.4 Response Messages

It represents the response message for query messages from the 3511-50.

Response messages generated by the 3511-50 are in long form and in upper case letters.

Example :FREQUENCY 1000

(Current frequency is 1 kHz.)

**NOTE**

If an error occurs when the query message is received, the query does not produce response message.

## 6.4 Headers

### (1) Program message headers

There are three types of header: simple headers, compound headers, and particular headers.

- Simple header

A header consisting of a single word beginning with a letter.

Examples :HEADer etc.

- Compound header

A header consisting of a sequence of words separated by colons.

Examples :BEEPer:KEY, RANGe:AUTO, etc.

- Particular header

A header beginning with an asterisk (\*) to indicate that it is a particular command.

Examples \*RST etc.

### (2) Response message

Headers in response messages can be enabled or disabled by using the "HEADer" command.

Example When frequency is set to 1 kHz:

:FREQUENCY?

(Query message asking for the current setting of the frequency.)

Response message when headers are on.

:FREQUENCY 1000

↑  
1

↑  
2

**1** Header portion

**2** Data portion

Response message when headers are off.

1000

(Data portion only)

---

## 6.5 Data Formats

The 3511-50 uses character string data and decimal numeric data, and the type used varies according to the command in question.

### (1) Character data

Character string data must always begin with an alphabetic character, and the characters following can be either alphabetic characters or numerals. Although in character data either upper case letters or lower case letters are accepted, response messages output by the 3511-50 are always in upper case letters.

Example :TRIGger inT

### (2) Decimal data

The numeric data values are all represented in decimal, in three formats identified as NR1, NR2 and NR3, and each of these can appear as either a signed number or an unsigned number. Unsigned numbers are taken as positive. Further, if the accuracy of a numerical value exceeds the limit which the 3511-50 can deal, it is rounded off (5 and above is rounded up; 4 and below is rounded down).

NR1 format: Integer data

Examples +12, -23, 34

NR2 format: Fixed point numbers

Examples +1.23, -23.45, 3.456

NR3 format: Floating point numbers.

Examples +1E-2, -2.3E+4

The term "NRf format" includes all these three formats. When the 3511-50 is receiving it accepts NRf format, but when it is sending response messages it utilizes whichever one of the formats NR1 to NR3 is indicated in the specified command.

Examples :RANGe 6

:RANGe +6.012

:RANGe 0.0006E4



## 6.6 Delimiters

The term "delimiter" is used to refer to the following possibility for separating data sequences.

The 3511-50 recognizes a carriage return plus linefeed (CR+LF) as delimiters.

**NOTE**

The 3511-50 only begins to analyze a command after recognizing the delimiter.

## 6.7 Separators

### (1) Message unit separator

A semicolon (;) is used as a message unit separator when it is desired to set out several messages on a single line.

Example :RANGe:AUTO ON;:BEEP:KEY ON;\*IDN?

**NOTE**

When messages are combined in this way, if a syntax error occurs, all subsequent messages up to the next terminator will be ignored.

### (2) Header separator

In a message which has a header and data, a space (represented by " " in the examples) is used as the header separator to separate the header from the data.

Example :LEVel 1

### (3) Data separator

If a message has several data items, commas (,) are required as data separators for separating these data items from one another.

Example :COMParator:FLIMit <lower limit>,<upper limit>

## 6.8 Abbreviation of Compound Commands

When several compound commands have a common head portion (for example, :BEEPer:KEY and :BEEPer:COMParator, etc.), then, when and only when writing them directly following on from one another, this common portion (:BEEPer: in this example) can be omitted from each command except for the first one.

This common portion is called "the current path", by analogy with the general concept of the current directory in the directory structure of UNIX or MSDOS, and until it is cleared the analysis of following commands is performed by deeming them to be preceded by the current path which has been curtailed in the interests of brevity. This manner of using the current path is shown in the following example:

Normal expression

```
:BEEPer:KEY ON;:BEEPer:COMParator NG
```

Abbreviated expression

```
:BEEPer: KEY ON;COMParator NG
```

↑ This becomes the current path, and can be curtailed from the following commands.

The current path is cleared when the power is turned on, when a colon (:) appears at the start of a command, and when a delimiter is detected.

Messages with particular headers can be executed without relation to the current path. Further, they have no effect upon the current path.

With the 3511-50, there are 5 possible current paths:

:BEEPer:

:COMParator:

:CORRection:

:RANGe:

:USER:

---

## 6.9 Output Queue

Response messages accumulate in the output queue and are transmitted as data and cleared.

The output queue is also cleared when the power is turned off and turned on again.

The 3511-50 has an output queue of 300 bytes capacity. If the response messages overflow this limit of 300 bytes, a query error is generated, and the output queue is cleared.

---

## 6.10 Input Buffer

The 3511-50 has an input buffer of 300 bytes capacity. When more than 300 bytes of data are transmitted, when the buffer is full any subsequent bytes received will be ignored.

(When the controller handshake setting is not the same as the 3511-50.)

## 6.11 Event Registers

The 3511-50 includes three 8 bit event registers. It is possible to determine the status of the unit by reading these registers.

The event register is cleared in the following situations:

- When a "\*CLS" command is executed.
- When an event register query is executed. (\*ESR?, :ESR0?, :ESR1?)
- When the unit is powered on.

### (1) Standard event status register (SESR)

#### Standard event status register (SESR) bit assignments

Bit 7 PON	Power on flag. When the power is turned on, or on recovery from a power cut, this bit is set to 1.
Bit 6	Unused.
Bit 5 CME	Command error. When a command which has been received contains a syntactic or semantic error, this bit is set to 1. <ul style="list-style-type: none"> <li>• The command is not supported by the 3511-50.</li> <li>• There is a mistake in a program header.</li> <li>• The number of data parameters is wrong.</li> <li>• The format of the parameters is wrong.</li> </ul>
Bit 4 EXE	Execution error. When for some reason a command which has been received cannot be executed, this bit is set to 1. <ul style="list-style-type: none"> <li>• The designated data value is outside the set range.</li> <li>• The designated data value is not acceptable.</li> <li>• Execution is impossible because some other function is being performed.</li> </ul>
Bit 3 DDE	Device dependent error. When a command cannot be executed due to some cause other than a command error, a query error, or an execution error, this bit is set to 1. <ul style="list-style-type: none"> <li>• Execution is impossible due to an abnormality inside the 3511-50.</li> <li>• During open or short circuit compensation, valid data cannot be obtained.</li> </ul>
Bit 2 QYE	Query error. This bit is set to 1 when a query error is detected by the output queue control. <ul style="list-style-type: none"> <li>• When the data overflows the output queue.</li> <li>• When data in the output queue has been lost.</li> </ul>
Bit 1	Unused.
Bit 0	Unused.

## (2) Event status registers 0 and 1 (ESR0 and ESR1)

## Event Status Register 0 (ESR0) Bit Assignments

Bit 7 CEM	Compensation data measurement completed
Bit 6 SOF	Second parameter range overflow
Bit 5 SUF	Second parameter range underflow
Bit 4 MOF	First parameter range overflow
Bit 3 MUF	First parameter range underflow
Bit 2 IDX	Data sampling completed
Bit 1 EOM	Measurement completed
Bit 0	Unused

## Event Status Register 1 (ESR1) Bit Assignments

Bit 7	Unused
Bit 6 AND	Logical product (AND) of comparison results (bit1, bit4)
Bit 5 SLO	Second parameter below lower limit
Bit 4 SIN	Second parameter within limits
Bit 3 SHI	Second parameter above upper limit
Bit 2 FLO	First parameter below lower limit
Bit 1 FIN	First parameter within limits
Bit 0 FHI	First parameter above upper limit

## 6.12 Command Reference

### 6.12.1 Command Summary

Particular commands

Command	Explanation	Ref page
*CLS	Clears event register.	77
*ESR?	Queries standard event status register (SESR).	77
*IDN?	Queries device ID.	77
*RST	Device initialization.	78
*TRG	Performs sampling once.	78
*TST?	Queries the result of the self-test.	79
*WAI	Waits until all execution is fully completed.	79

Specific commands

Command	Function	Ref page
<b>Beep sound function</b>		
:BEEPPer:COMParator	Sets the beep sound for the comparator.	80
:BEEPPer:COMParator?	Queries the beep sound for the comparator.	80
:BEEPPer:KEY	Sets the beep sound for key input.	81
:BEEPPer:KEY?	Queries the beep sound for key input.	81
<b>Equivalent circuit function</b>		
:CIRCUit	Sets the equivalent circuit mode.	81
:CIRCUit?	Queries the equivalent circuit mode.	82
:CIRCUit:AUTO	Sets the automatic equivalent circuit mode.	82
:CIRCUit:AUTO?	Queries the automatic equivalent circuit mode.	82
<b>Comparator function</b>		
:COMParator	Enables and disables the comparator function.	83
:COMParator?	Queries the comparator function enablement.	83
:COMParator:FLIMit	Sets the lower and upper limit values for the first parameter.	83
:COMParator:FLIMit?	Queries the lower and upper limit values for the first parameter.	84
:COMParator:SLIMit	Sets the lower and upper limit values for the second parameter.	84
:COMParator:SLIMit?	Queries the lower and upper limit values for the second parameter.	84
<b>Open and short circuit compensation function</b>		
:CORRection:DATA?	Queries the open and short circuit compensation values.	85
:CORRection:OPEN	Enables and disables the open circuit compensation function.	85
:CORRection:OPEN?	Queries the open circuit compensation function enablement.	86
:CORRection:SHORT	Enables and disables the short circuit compensation function.	86
:CORRection:SHORT?	Queries the short circuit compensation function enablement.	86

Command	Function	Ref page
<b>Communication error confirmation</b>		
:ERRor?	Queries the RS-232C error.	87
<b>Event register</b>		
:ESR0?	Queries event status register 0.	87
:ESR1?	Queries event status register 1.	88
<b>Test frequency function</b>		
:FREQuency	Sets the test frequency.	88
:FREQuency?	Queries the test frequency.	88
<b>Headers</b>		
:HEADer	Enables and disables headers for the response message.	89
:HEADer?	Queries headers enablement.	89
<b>Test signal level function</b>		
:LEVel	Sets the test signal level.	89
:LEVel?	Queries the test signal level.	90
<b>Panel load function</b>		
:LOAD	Transfers the specified panel number.	90
<b>Normal testings</b>		
:MEASure?	Queries the data item.	91
<b>Parameter settings</b>		
:PARAMeter	Sets displayed parameters.	92
:PARAMeter?	Queries displayed parameters.	92
<b>Test range function</b>		
:RANGe	Sets test range.	93
:RANGe?	Queries test range setting.	94
:RANGe:AUTO	Sets the automatic test ranging.	94
:RANGe:AUTO?	Queries the automatic test range setting.	94
<b>Panel saving function</b>		
:SAVE	Saves the test conditions in specified panel number.	95
:SAVE?	Queries the panel number in which data is saved.	95
<b>Test speed function</b>		
:SPEEd	Sets the testing speed.	95
:SPEEd?	Queries the testing speed.	96
<b>Trigger function</b>		
:TRIGger	Sets the type of trigger.	96
:TRIGger?	Queries the trigger setting.	96
<b>ID function</b>		
:USER:IDENtity	Sets the user ID.	97
:USER:IDENtity?	Queries the user ID.	97

## 6.13 Format of Command Explanations

**Syntax** Specifies the syntax for the command (a space is represented by " " in this syntax).

**<data>** For a command that has parameters, specifies their format.

**Function** Specifies the function of the command.

**Example** These are simple examples of the use of the command.  
Note that all transmission messages are expressed in a "short form."

**Error** Specifies what types of error may occur.

**NOTE**

On the 3511-50, internal processing may involve a delay of 20 ms to 500 ms maximum from command receipt to start of analysis.



---

## 6.14 Particular Commands

### \*CLS

---

Clears the status byte register and the event registers.

**Syntax** \*CLS

**Function** Clears all the event registers (SESR, ESR0, ESR1) associated with the bits of the status byte register. Accordingly, also clears the status byte register. This has no effect upon the output queue.

**Error** If the data parameters are set after this command, a command error occurs.

### \*ESR?

---

Queries the contents of the standard event status register (SESR).

**Syntax** \*ESR?

**Function** Returns the contents of the standard event status register (SESR) as a numerical value in NR1 format between 0 and 255, and then clears standard event status register. No header is affixed to the response message.

**Example** Response            32  
Bit 5 of SESR has been set to 1.

128	64	32	16	8	4	2	1
bit 7	bit 6	bit 5	bit 4	bit 3	bit 2	bit 1	bit 0
PON	Unused	CME	EXE	DDE	QYE	Unused	Unused

Standard event status register (SESR)

**Error** If the response message is longer than 300 bytes, a query error is generated.

### \*IDN?

---

Queries manufacturer's name, model name, and software version.

**Syntax** \*IDN?

**Function** The response consists of the name of the manufacturer of the unit, the model name, and the software version.

No header is affixed to the response message.

First field        Manufacturer's name

Second field     Model name

Third field       Fixed for fifty

Fourth field     Software version

**Example** Response            HIOKI,3511,50,V01.00

**Error** If the response message is longer than 300 bytes, a query error is generated.

**\*RST**

---



---

Performs device initial setting.

**Syntax** \*RST

**Function** Resets the 3511-50. The items which are reset are listed below.

Test parameters	Impedance (Z), phase angle ( $\theta$ )
Test frequency	1 kHz
Test signal level	1 V
Test range	AUTO
Equivalent circuit mode	AUTO
Open circuit compensation	OFF
Short circuit compensation	OFF
Trigger setting	Internal trigger
Test speed setting	NORMAL
Beep sound setting	ON for key input, OFF for comparator
Comparator	Both first and second parameters Upper and lower limit values: OFF
Panel save	All contents clear

**Error** If the data parameters are set after this command, a command error occurs.

**\*TRG**

---



---

Issues external trigger.

**Syntax** \*TRG

**Function** In external trigger mode, performs measurement once.

**Example** Transmission :TRIGger EXTernal;\*TRG;:MEASure?

**Error** Executing this command in internal trigger mode generates an execution error.  
If the data parameters are set after this command, a command error occurs.  
Executing this command while the open or short circuit compensation is performed generates an execution error.

---



---

## \*TST?

Requests execution of, and queries the result of, the self test.

<b>Syntax</b>	*TST?
<b>Function</b>	Performs the self test of the 3511-50, and returns the result thereof as a numerical value in NR1 format between 0 and 3. No header is affixed to the response message. Bit 0: A ROM error occurred. Bit 1: A RAM error occurred. Bit 2: An I/O error occurred. Bit 3: An interrupt error occurred. Bits 4 to 7: Unused
<b>Example</b>	Response           6 A RAM error (bit 1) and an I/O error (bit 2) have occurred.
<b>Error</b>	If the response message is longer than 300 bytes, a query error occurs. Executing this command while the open or short circuit compensation is performed generates an execution error.

---



---

## \*WAI

Waits until all execution is fully completed.

<b>Syntax</b>	*WAI
<b>Function</b>	The unit goes into waiting state until the previous operation has been completed.
<b>Note</b>	All of the specific commands are in any case sequential commands except the :MEASure? query. Therefore, using this *WAI command has an effect upon only :MEASure? query.
<b>Example</b>	Transmission (If the frequency is set to 1 kHz) When using the *WAI command :FREQuency 120;*WAI;*TRG;;MEASure? The response for :MEASure? is the test value at frequency of 120 Hz. When not using the *WAI command :FREQuency 120;*TRG;;MEASure? The response for :MEASure? is the test value at frequency of 1 kHz.
<b>Error</b>	If the data parameters are set after this command, a command error occurs.

---

## 6.15 Commands Specific to the 3511-50

---

### :BEEPer:COMParator

---

Sets the beep sound for the comparator.

**Syntax** :BEEPer:COMParator <data>

**<data>** IN/NG/OFF (character data)

**Function** Sets the beep sound produced when the comparator makes decisions.  
IN: When the comparator result is within limits, a beep sound is emitted.  
NG: When the comparator result is out of limits, a beep sound is emitted.  
OFF: No beep sound is emitted.

**Example** Transmission :BEEPer:COMParator NG  
When the value is out of limits, a beep sound is emitted.

**Error** If <data> is other than character data described above, an execution error occurs.  
Executing this command while the open or short circuit compensation is performed generates an execution error.

---

### :BEEPer:COMParator?

---

Queries the beep sound for the comparator.

**Syntax** :BEEPer:COMParator?

**<data>** IN/NG/OFF (character data)

**Function** Returns the beep sound setting for when the comparator makes decision as character data.  
IN: When the comparator result is within limits, a beep sound is emitted.  
NG: When the comparator result is out of limits, a beep sound is emitted.  
OFF: No beep sound is emitted.

**Example** Response  
If headers are on :BEEPER:COMPARATOR NG  
If headers are off NG

**Error** If the response message is longer than 300 bytes, a query error is generated.

---

## :BEEPer:KEY

---

Enables and disables the beep sound for key input.

- Syntax** :BEEPer:KEY <data>
- <data>** ON/OFF (character data)
- Function** Sets the beep sound produced each time a key is pressed.  
 ON: A beep sound is emitted.  
 OFF: No beep sound is emitted.
- Example** Transmission :BEEPer:KEY ON  
 When a key is pressed, a beep sound is emitted.
- Error** If <data> is other than character data described above, an execution error occurs.  
 Executing this command while the open or short circuit compensation is performed generates an execution error.

---

## :BEEPer:KEY?

---

Queries the beep sound for key input.

- Syntax** :BEEPer:KEY?
- <data>** ON/OFF (character data)
- Function** Returns the beep sound setting for when a key is pressed as character data.  
 ON: A beep sound is emitted.  
 OFF: No beep sound is emitted.
- Example** Response  
 If headers are on :BEEPER:KEY ON  
 If headers are off ON
- Error** If the response message is longer than 300 bytes, a query error is generated.

---

## :CIRCuit

---

Sets the equivalent circuit mode.

- Syntax** :CIRCuit <data>
- <data>** SER/PAR (character data)
- Function** Sets the equivalent circuit mode.  
 SER: Series equivalent circuit mode  
 PAR: Parallel equivalent circuit mode
- Example** Transmission :CIRCuit SER  
 The series equivalent circuit mode is set.
- Error** If <data> is other than character data described above, an execution error occurs.  
 Executing this command while the open or short circuit compensation is performed generates an execution error.

---

## :CIRCUIT?

---

Queries the equivalent circuit mode.

- Syntax** :BEEP:KEY?
- <data>** SER/PAR (character data)
- Function** Returns the current equivalent circuit mode setting as character data.  
SER: Series equivalent circuit mode  
PAR: Parallel equivalent circuit mode
- Example** Response  
If headers are on :CIRCUIT SER  
If headers are off SER
- Error** If the response message is longer than 300 bytes, a query error is generated.

---

## :CIRCUIT:Auto

---

Sets the automatic equivalent circuit mode.

- Syntax** :CIRCUIT:AUTO <data>
- <data>** ON/OFF (character data)
- Function** Switches between automatic and manual setting of equivalent circuit mode.  
ON: Switches the automatic setting.  
OFF: Switches the manual setting.
- Example** Transmission ":CIRCUIT:AUTO ON"  
The equivalent circuit mode is switched to automatic selection (auto-ranging).
- Error** If <data> is other than character data described above, an execution error occurs.  
Executing this command while the open or short circuit compensation is performed generates an execution error.

---

## :CIRCUIT:Auto?

---

Queries the automatic equivalent circuit mode.

- Syntax** :CIRCUIT:AUTO?
- <data>** ON/OFF
- Function** Returns whether the equivalent circuit mode is automatically set as character data.
- Example** Response  
If headers are on ":CIRCUIT:AUTO ON"  
If headers are off "ON"
- Error** If the response message is longer than 300 bytes, a query error is generated.

---

## :COMParator

---

Enables and disables the comparator function.

- Syntax** :COMParator <data>
- <data>** ON/OFF (character data)
- Function** Turns the comparator function on and off.
- Example** Transmission :COMParator ON  
The comparator function is turned on.
- Error** If <data> is other than character data described above, an execution error occurs. Executing this command while the open or short circuit compensation is performed generates an execution error.

---

## :COMParator?

---

Queries the comparator function enablement.

- Syntax** COMParator?
- <data>** ON/OFF (character data)
- Function** Returns the current enablement state of the comparator function as character data.
- Example** Response  
If headers are on :COMPARATOR ON  
If headers are off ON
- Error** If the response message is longer than 300 bytes, a query error is generated.

---

## :COMParator:FLIMit

---

Sets the lower and upper limit values for the first comparator parameter.

- Syntax** :COMParator:FLIMit <low>,<high>
- <data>** <low> (lower limit value): OFF (character data) or numerical value in NR1 format  
<high> (upper limit value): OFF (character data) or numerical value in NR1 format
- Function** Sets the lower and upper limit values for the first comparator parameter (i.e. the principal measured value) as counts that are displayed on the screen. The numerical value can be in NRf format, but rounding is performed for figures beyond the last valid decimal place.
- Example** Transmission :COMParator:FLIMit 11234,12345  
The lower limit value is set to 11234, and the upper limit value is set to 12345.
- Error** If <data> is other than character data or numerical value described above, an execution error occurs. Executing this command while the open or short circuit compensation is performed generates an execution error.

---

## :COMParator:FLIMit?

---

Queries the lower and upper limit values for the first comparator parameter.

- Syntax** :COMParator:FLIMit?
- <data>** OFF (character data) or numerical value in NR1 format
- Function** Returns the lower and upper limit values for the first comparator parameter as character data or numerical value in order.
- Example** Response  
 If headers are on :COMPARATOR:FLIMIT 11234,12345  
 If headers are off 11234,12345
- Error** If the response message is longer than 300 bytes, a query error is generated.

---

## :COMParator:SLIMit

---

Sets the lower and upper limit values for the second comparator parameter.

- Syntax** COMParator: SLIMit:ABSolute <low>,<high>
- <data>** <low> (lower limit value): OFF (character data) or numerical value in NR1 format  
 <high> (upper limit value): OFF (character data) or numerical value in NR1 format
- Function** Sets the lower and upper limit values for the second comparator parameter. The numerical value can be in NRf format, but rounding is performed for figures beyond the last valid decimal place.
- Example** Transmission :COMParator:SLIMit 11234,12345  
 The lower limit value is set to 11234, and the upper limit value is set to 12345.
- Error** If <data> is other than character data or numerical value described above, a command error occurs.  
 Executing this command while the open or short circuit compensation is performed generates an execution error.

---

## :COMParator:SLIMit?

---

Queries the lower and upper limit values for the second comparator parameter.

- Syntax** COMParator:SLIMit?
- <data>** OFF (character data) or numerical value in NR1 format
- Function** Returns the lower and upper limit values for the second comparator parameter as character data or numerical value in order.
- Example** Response  
 If headers are on :COMPARATOR:SLIMIT 11234,12345  
 If headers are off 11234,12345
- Error** If the response message is longer than 300 bytes, a query error occurs.



---

## :CORRection:DATA?

---

Queries the open circuit and short circuit compensation values.

**Syntax** :CORRection:DATA?

**<data>** Residual impedance: Numerical value in NR3 format or OFF (character data)  
Phase angle: Numerical value in NR2 format or OFF (character data)

**Function** Returns the open and short circuits compensation values in the current test frequency in the following order.

<Residual impedance of short circuit compensation>

<Phase angle of short circuit compensation>

<Residual impedance of open circuit compensation>

<Phase angle of open circuit compensation>

When the compensation setting is OFF, returns the character data "OFF."

**Example** Response

If headers are on :CORRECTION:DATA OFF,OFF,247.45E+06,-21.58

If headers are off OFF,OFF,247.45E+06,-21.58

The short circuit compensation for the current test frequency is set to OFF, and open circuit compensation is 247.45 MΩ, -21.58° .

**Error** If the response message is longer than 300 bytes, a query error is generated.

---

## :CORRection:OPEN

---

Enables and disables the open circuit compensation function.

**Syntax** :CORRection:OPEN <data>

**<data>** ON/OFF (character data)

**Function** Enables and disables the open circuit compensation function.  
Specifying "ON" for <data> starts the reading of open circuit compensation data. Upon completion of data reading, the open circuit compensation function is set to ON.

**Example** Transmission :CORRection:OPEN ON

The open circuit compensation function is set to ON.

**Error** If <data> is other than character data described above, an execution error occurs.  
Executing this command while the comparator function is performed generates an execution error.

---

## :CORRection:OPEN?

---

Queries the open circuit compensation function enablement.

- Syntax** :CORRection:OPEN?
- <data>** ON/OFF (character data)
- Function** Returns the current enablement state of the open circuit compensation function as character data.  
 ON: The open circuit compensation function has been set to on.  
 OFF: The open circuit compensation function has been set to off.
- Example** Response  
 If headers are on :CORRECTION:OPEN ON  
 If headers are off ON  
 The open circuit compensation has been enabled.
- Error** If the response message is longer than 300 bytes, a query error is generated.

---

## :CORRection:SHORT

---

Enables and disables the short circuit compensation function.

- Syntax** :CORRection:SHORT <data>
- <data>** ON/OFF (character data)
- Function** Enables and disables the short circuit compensation function.
- Example** Transmission :CORRection:SHORT ON  
 The short circuit compensation function is enabled.
- Error** If <data> is other than character data described above, an execution error occurs. Executing this command while the comparator function is performed generates an execution error.

---

## :CORRection:SHORT?

---

Queries the short circuit compensation function enablement.

- Syntax** :CORRection:SHORT?
- <data>** ON/OFF (character data)
- Function** Returns the current enablement state of the short circuit compensation function as character data.  
 ON: The short circuit compensation function has been set to on.  
 OFF: The short circuit compensation function has been set to off.
- Example** Response  
 If headers are on :CORRECTION:SHORT ON  
 If headers are off ON  
 The open circuit compensation function has been enabled.
- Error** If the response message is longer than 300 bytes, a query error is generated.

## :ERRor?

Queries RS-232C communication condition errors.

**Syntax** :ERRor?

**Function** Returns the value of RS-232C communication condition errors as a numerical value in NR1 format from 0 to 7, and then clears RS-232C communication condition errors. No header is prefixed to the response message.

**<data>** Numerical data in NR1 format between 0 and 7

**Example** Response 4  
An overrun error has occurred.

128	64	32	16	8	4	2	1
bit 7	bit 6	bit 5	bit 4	bit 3	bit 2	bit 1	bit 0
Unused	Unused	Unused	Unused	Unused	Overrun error	Framing error	Parity error

RS-232C communication condition errors register

**Error** If the response message is longer than 300 bytes, a query error is generated.

## :ESR0?

Queries event status register 0.

**Syntax** ESR0?

**Function** Returns the value of event status register 0 (ESR0) as a numerical value in NR1 format between 0 and 255, and then clears event status register 0. No header is prefixed to the response message.

128	64	32	16	8	4	2	1
bit 7	bit 6	bit 5	bit 4	bit 3	bit 2	bit 1	bit 0
CEM	SOF	SUF	MOF	MUF	IDX	EOM	Unused

Event status register 0 (ESR0)

**Example** Response 4  
Bit 2 of ESR0 has been set to 1.

**Error** If the response message is longer than 300 bytes, a query error is generated.

---

## :ESR1?

---

Queries event status register 1.

**Syntax** ESR1?

**Function** Returns the value of event status register 1 (ESR1) as a numerical value in NR1 format between 0 and 255, and then clears event status register 1.  
No header is prefixed to the response message.

128	64	32	16	8	4	2	1
bit 7	bit 6	bit 5	bit 4	bit 3	bit 2	bit 1	bit 0
Unused	AND	SLO	SIN	SHI	FLO	FIN	FHI

Event status register 1 (ESR1)

**Example** Response           64  
Bit 6 of ESR1 has been set to 1.

**Error** If the response message is longer than 300 bytes, a query error is generated.

---

## :FREQUENCY

---

Sets the test frequency.

**Syntax** FREQUENCY <data>

**<data>** 120/1000 (numerical data in NR1 format)

**Function** Sets the test frequency.  
The numerical value can be in NRf format, but rounding is performed for figures beyond the last valid decimal place.

**Example** Transmission       :FREQUENCY 1000  
The test frequency is set to 1 kHz.

**Error** If <data> is other than numerical value described above, an execution error occurs.  
Executing this command while the open or short circuit compensation is performed generates an execution error.

---

## :FREQUENCY?

---

Queries the test frequency.

**Syntax** :FREQUENCY?

**<data>** 120/1000 (numerical data in NR1 format)

**Function** Returns the current test frequency setting as a numerical value in NR1 format.

**Example** Response  
If headers are on       :FREQUENCY 1000  
If headers are off       1000  
The test frequency has been set to 1 kHz.

**Error** If the response message is longer than 300 bytes, a query error is generated.

---

## :HEADer

---

Enables and disables headers for the response messages.

- Syntax** :HEADer <data>
- <data>** ON/OFF (character data)
- Function** Sets whether or not the 3511-50 will prefix headers to its response messages. When powering on, <data> is initially set to ON.
- Example** Transmission :HEADer ON  
Headers are prefixed to response messages.
- Error** If <data> is other than character data described above, an execution error occurs.

---

## :HEADer?

---

Queries whether or not headers on response messages are enabled.

- Syntax** :HEADer?
- <data>** ON/OFF (character data)
- Function** Returns whether or not headers on response messages are enabled as character data.
- Example** Response  
If headers are on :HEADer ON  
If headers are off OFF
- Error** If the response message is longer than 300 bytes, a query error is generated.

---

## :LEVel

---

Sets the test signal level.

- Syntax** :LEVel <data>
- <data>** 1/0.5/0.05 (numerical data in NR2 format)
- Function** Sets the test signal level.  
The numerical value can be in NRf format, but rounding is performed for figures beyond the last valid decimal place.
- Example** Transmission :LEVel 0.5  
The test signal level is set to 500 mV.
- Error** If <data> is other than numerical value described above, an execution error occurs. Executing this command while the open or short circuit compensation is performed generates an execution error.

## :LEVel?

---

---

Queries the test signal level.

- Syntax** :LEVel?
- <data>** 1/0.5/0.05 (numerical data in NR2 format)
- Function** Returns the current test signal level setting as a numerical value in NR2 format.
- Example** Response  
If headers are on :LEVEL 0.5  
If headers are off 0.5  
The test signal level has been set to 500 mV.
- Error** If the response message is longer than 300 bytes, a query error occurs.

## :LOAD

---

---

Loads the test conditions of the specified panel number.

- Syntax** :LOAD <data>
- <data>** Numerical data in NR1 format between 1 and 99
- Function** Sets the panel number which you wish to load.  
The numerical value can be in NRf format, but any digits after the decimal point will be rounded.
- Example** Transmission :LOAD 2  
The test conditions which are saved in panel number 2 are loaded.
- Error** If <data> is other than numerical value described above, an execution error occurs.  
If the panel number in which the settings have not been saved is selected, an execution error occurs.  
Executing this command while the open or short circuit compensation is performed generates an execution error.

## :MEASure?

Queries measured data items.

**Syntax** MEASure?

**Function** Returns the measured values of test data items as numerical values in NR2 and NR3 format.  
 With comparator measurement, the comparator decision results are also returned.  
 The first numerical value is the ANDed comparator decision result. If decision results for both the first and second parameters are IN, this value is 0. If either result is LO or HI, the value is 1.  
 The numerical values that follow the measured value are the decision results for each parameter. For each decision result, the following numerical values are returned.

Results	Numerical data
LO	-1
IN	0
HI	1

**Example** 1. During normal testing

When the measurement parameters are impedance ( $Z$ ) and phase angle ( $\theta$ ):

Transmission :MEASure?

Response

If headers are on Z 1.2345E+03,PHASE 0.28

If headers are off 1.2345E+03, 0.28

2. During comparator testing

Transmission :PARAmeter1 Z;;PARAmeter3 PHASe  
 :COMParator ON  
 :MEASure?

Response

If headers are on 0,Z 31.981E+03,0,PHASE -88.05,-1

If headers are off 0,31.981E+03,0,-88.05,-1

The decision result of the first parameter is IN, and that of the second parameter is LO.

**Error** If the response message is longer than 300 bytes, a query error is generated.  
 Executing this command while the open or short circuit compensation is performed generates an execution error.

## :PARAmeter

---

Sets the displayed parameters.

**Syntax** :PARAmeter <data>

**<data>** Numerical data in NR1 format between 1 and 5

**Function** Sets the displayed parameters.

The numerical value can be in NRf format, but any digits after the decimal point will be rounded.

The numerical value corresponding to the displayed parameters is as follows.

	First parameter	Second parameter
1	Z	$\theta$
2	C	D
3	L	D
4	L	Q
5	R	---

**Example** Transmission :PARAmeter 1

The first parameter is set to impedance, and the second parameter is set to phase angle.

**Error** If <data> is other than numerical value described above, an execution error occurs.

## :PARAmeter?

---

Queries the displayed parameters.

**Syntax** :PARAmeter?

**<data>** Numerical data in NR1 format between 1 and 5

**Function** Returns the displayed parameters as character data.

The numerical value corresponding to the displayed parameters is as follows.

**Example** Response

If headers are on :PARAMETER 1

If headers are off 1

The first parameter has been set to impedance, and the second parameter has been set to phase angle.

**Error** If the response message is longer than 300 bytes, a query error occurs.



## :RANGe

Sets the test range.

**Syntax** :RANGe <data>

**<data>** Numerical data in NR1 format between 1 and 10

**Function** Sets the test range.

The numerical value can be in NRf format, but any digits after the decimal point will be rounded.

If this command is executed, the setting of the :RANGe:AUTO command is automatically changed to OFF.

If this command is executed when the equivalent circuit mode is set to AUTO, the setting of the equivalent circuit mode (SER/PAR) is automatically changed to the most suitable setting.

The numerical value corresponding to the test range is as follows.

Test frequency Range number	First parameter				
	Z, R	C		L	
	120 Hz, 1 kHz	120 Hz	1 kHz	120 Hz	1 kHz
1	100 mΩ	145 pF	17 pF	130 μH	15.5 μH
2	1 Ω	1.45 nF	170 pF	1.3 mH	155 μH
3	10 Ω	14.5 nF	1.7 nF	13 mH	1.55 mH
4	100 Ω	145 nF	17 nF	130 mH	15.5 mH
5	1 kΩ	1.45 μF	170 nF	1.3 H	155 mH
6	10 kΩ	14.5 μF	1.7 μF	13 H	1.55 H
7	100 kΩ	145 μF	17 μF	130 H	15.5 H
8	1 MΩ	1.45 mF	170 μF	1.3 kH	155 H
9	10 MΩ	14.5 mF	1.7 mF	13 kH	1.55 kH
10	200 MΩ	1 F	100 mF	200 kH	20 kH

**Example** Transmission :PARAmeter 1;:RANGe 6  
The test range is set to 1 kΩ.

**Error** If <data> is other than numerical value described above, an execution error occurs. Executing this command while the open or short circuit compensation is performed generates an execution error.

---

## :RANGe?

---

Queries the test range.

- Syntax** :RANGe?
- <data>** Numerical data in NR1 format between 1 and 5
- Function** Returns the test range setting as numerical value in NR1 format.  
The numerical value corresponding to the test range is as follows.
- Example** Response  
If headers are on :RANGe 5  
If headers are off 5  
The test range has been set to range 5 (1 k $\Omega$  when the first parameter is impedance).
- Error** If the response message is longer than 300 bytes, a query error is generated.

---

## :RANGe:AUTO

---

Enables and disables the auto-range function.

- Syntax** :RANGe:AUTO <data>
- <data>** ON/OFF (character data)
- Function** Switches between automatic and manual setting of test range.  
ON: Switches the automatic setting.  
OFF: Switches the manual setting.
- Example** Transmission :RANGe:AUTO ON  
The test range is switched to automatic selection (auto-ranging).
- Error** If <data> is other than character data described above, an execution error occurs.  
Executing this command while the open or short circuit compensation is performed generates an execution error.

---

## :RANGe:AUTO?

---

Queries the autorange function enablement.

- Syntax** :RANGe:AUTO?
- <data>** ON/OFF (character data)
- Function** Returns whether the test range is automatically set as character data.
- Example** Response  
If headers are on :RANGe:AUTO ON  
If headers are off ON
- Error** If the response message is longer than 300 bytes, a query error is generated.

---

## :SAVE

---

Saves the test conditions in specified panel number.

- Syntax** :SAVE <data>
- <data>** Numerical data in NR1 format between 1 and 99
- Function** Saves the test conditions in specified panel number.  
The numerical value can be in NRf format, but any digits after the decimal point will be rounded.
- Example** Transmission :SAVE 3  
The test condition is saved in panel number 3.
- Error** If <data> is other than numerical value described above, a command error occurs.  
Executing this command while the open or short circuit compensation is performed generates an execution error.

---

## :SAVE?

---

Queries the panel number saved.

- Syntax** :SAVE? <data>
- <data>** Numerical data in NR1 format between 0 and 99
- Function** Returns 1 when the test conditions are saved in specified panel number, and returns 0 when not saved.  
The numerical value can be in NRf format, but any digits after the decimal point will be rounded.  
The response message has no headers.
- Example** Transmission :SAVE? 3  
Response 1  
The test condition is saved in panel number 3.
- Error** If <data> is other than numerical value described above, an execution error occurs.

---

## :SPEEd

---

Sets the testing speed.

- Syntax** :SPEEd <data>
- <data>** FAST/NORMAl/SLOW (character data)
- Function** Sets the testing speed.
- Example** Transmission :SPEEd NORMAl
- Error** If <data> is other than character data described above, an execution error occurs.  
Executing this command while the open or short circuit compensation is performed generates an execution error.

---

## :SPEEd?

---

Queries the testing speed.

- Syntax** :SPEEd?
- <data>** FAST/NORMAL/SLOW (character data)
- Function** Returns the setting of testing speed as character data.
- Example** Response  
 If headers are on :SPEED NORMAL  
 If headers are off NORMAL
- Error** If the response message is longer than 300 bytes, a query error is generated.

---

## :TRIGger

---

Sets the type of trigger.

- Syntax** :TRIGger <data>
- <data>** INTernal/EXTernal (character data)
- Function** Sets the type of trigger.  
 INTernal: Internal trigger mode  
 EXTernal: External trigger mode
- Example** Transmission :TRIGger INTernal  
 The trigger mode is set to internal trigger.
- Error** If <data> is other than character data described above, an execution error occurs.  
 Executing this command while the open or short circuit compensation is performed generates an execution error.

---

## :TRIGger?

---

Queries the trigger setting.

- Syntax** TRIGger?
- <data>** INTERNAL/EXTERNAL (character data)
- Function** Returns the trigger setting as character data.
- Example** Response  
 If headers are on :TRIGGER INTERNAL  
 If headers are off INTERNAL  
 The trigger mode has been set to internal triggering.
- Error** If the response message is longer than 300 bytes, a query error is generated.

---

## :User:IDENtity

---

Set the user ID.

- Syntax** USER:IDENtity <data>
- <data>** For example, AB-1234
- Function** The user can set an identity code.  
The ID is backed up in the same way as the main unit settings.  
The capital and lowercase letters, digits 0 to 9, and hyphen can be used.  
If an ID of eight or more characters is entered, the first seven characters are used.
- Example** Transmission :USER:IDEN AB-1234  
This sets the user ID to "AB-1234."
- Error** If <data> is other than character data described above, a command error occurs.

---

## :User:IDENtity?

---

Queries the user ID.

- Syntax** USER:IDENtity?
- Function** Returns a user ID as seven characters data <data>.
- Example** Response  
If headers are on :USER:IDENTITY AB-1234  
If headers are off AB-1234
- Error** If the response message is longer than 300 bytes, a query error is generated.  
If this command is executed without user ID setting, an execution error occurs.

## 6.16 Initialization Items

The following table shows which items are initialized and which not, under various conditions.

Item \ Initialization method	Powering on	*RST command	*CLS command
RS-232C communication conditions	---	---	---
Device specific functions (ranges etc.) *1	---	●	---
Output queue	●	---	---
Input buffer		---	---
Event registers	● <sup>*2</sup>	---	●
Current path	●	---	---
Headers on/off	●	●	---
Measurement resister	●	●	---

\*1: When the power is turned on, item is discriminated.

\*2: Except the PON bit (bit 7)

## 6.17 Sample Programs

The following sample programs are all written for the Microsoft Quick BASIC. For more details on the Quick BASIC, refer to the Quick BASIC documentation. All commands in the sample programs are used in the short form.

### (1) Open- and short-circuit compensation

#### Summary

This program carries out open- and short-circuit compensation on the 3511-50.

#### Program List

```

10 OPEN "COM1:9600,N,8,1,LF" FOR RANDOM AS #1
20 PRINT #1, ":HEAD OFF"
30 PRINT #1, "*CLS"
40 CORR.OPEN:
50 INPUT "Prepare unit for open circuit compensation, then press Enter", A$
60 PRINT "Collecting open circuit compensation data"
70 PRINT #1, ":CORR:OPEN ON"
80 OPEN.LOOP:
90 PRINT #1, ":ESR0?"
100 INPUT #1, A
110 IF (A AND 128) = 0 THEN GOTO OPEN.LOOP
120 PRINT #1, "*ESR?"
130 INPUT #1, A
140 IF (A AND 8) = 0 THEN GOTO CORR.SHORT
150 PRINT "Open circuit compensation failed"
160 GOTO CORR.OPEN
170 CORR.SHORT:
180 INPUT "Prepare unit for short circuit compensation, then press Enter", A$
190 PRINT "Collecting short circuit compensation data"
200 PRINT #1, ":CORR:SHOR ON"
210 SHORT.LOOP:
220 PRINT #1, ":ESR0?"
230 INPUT #1, A
240 IF (A AND 128) = 0 THEN GOTO SHORT.LOOP
250 PRINT #1, "*ESR?"
260 INPUT #1, A
270 IF (A AND 8) = 0 THEN GOTO CORR.END
280 PRINT "Short circuit compensation failed"
290 GOTO CORR.SHORT
300 CORR.END:
310 PRINT "Compensation operations completed"
320 CLOSE
330 END

```

#### Program comments

Line	Comment
10	Open the RS-232C circuit file.
20	Switch off headers for the response message.
30	Clear bits of each event registers.
70	Excute open circuit compensation.
90-110	Wait until the bit for the compensation completed is 128.
120-140	Wait the valid data cannot be obtained, the bit 3 of SESR is 1.
320	Close the RS-232C circuit file.

## (2) Basic settings and testing

### Summary

This program selects the test conditions for measurement on the 3511-50. It carries out a single test measurement, and displays the result on the screen.

### Program List

```
10 OPEN "COM1:9600,N,8,1,LF" FOR RANDOM AS #1
20 PRINT #1,":TRIG EXT"
30 PRINT #1,":FREQ 120"
40 PRINT #1,":RANG:AUTO ON"
50 PRINT #1,":LEV 1"
60 PRINT #1,":SPEE SLOW"
70 PRINT #1,"*TRG;:MEAS?"
80 LINE INPUT #1,A$
90 PRINT A$
100 CLOSE
110 END
```

### Program comments

Line	Comment
10	Open the RS-232C circuit file.
20	Select external trigger mode.
30	Set the test frequency to 120 Hz.
40	Enable auto-ranging.
50	Set the test voltage to 1 V.
60	Set the testing speed to SLOW.
70	Query the sampling data and measurement value.
90	Display the test results.
100	Close the RS-232C circuit file.

### Sample output

```
Z 1.0001E+03, PHASE 0.26
```

## (3) Saving the 3511-50 settings using the panel save function

### Summary

This program makes the settings for the 3511-50 and saves the settings to the panel number 1 as "TEST1."

### Program List

```
10 OPEN "COM1:9600,N,8,1,LF" FOR RANDOM AS #1
20 PRINT #1,":PAR 1"
30 PRINT #1,":FREQ 120"
40 PRINT #1,":LEV 1"
50 PRINT #1,":RANG:AUTO ON"
60 PRINT #1,":TRIG INT"
70 PRINT #1,":SPEE SLOW"
80 PRINT #1,":BEEP:KEY ON;COMP NG"
90 PRINT #1,":SAVE 1"
100 CLOSE
110 END
```

### Program comments

Line	Comment
10	Open the RS-232C circuit file.
20	Set displayed parameters to Z- $\theta$ .
30	Set the test frequency to 120 Hz.
40	Set the test voltage to 1 V.
50	Enable auto-ranging.
60	Select internal trigger mode.
70	Set the testing speed to SLOW.



- 80 Enables the beep sound by key input. The beep sounds when the comparator result is NG.
- 90 Save the settings to the panel number 1.
- 100 Close the RS-232C circuit file.

#### (4) Carrying out comparator testing

This program first makes the comparator settings.

At the end of testing, it displays the numbers of the samples which were outside the comparator limit.

##### Program List

```

10 OPEN "COM1:9600,N,8,1,LF" FOR RANDOM AS #1
20 PRINT #1, ":PAR 2"
30 PRINT #1, ":TRIG EXT"
40 PRINT #1, ":HEAD OFF"
50 PRINT #1, ":FREQ 120"
60 PRINT #1, ":RANG 5"
70 PRINT #1, ":LEV 1"
80 PRINT #1, ":COMP:FLIM 9000,11000"
90 PRINT #1, ":COMP:SLIM OFF,OFF"
100 NUM.SET:
110 INPUT "Number of samples to measure: "; X
120 IF X <= 0 THEN GOTO NUM.SET
130 OPTION BASE 1
140 DIM F.ALL(X), CP(X), F.CP(X), D(X)
150 PRINT #1, ":COMP ON"
160 INPUT "Prepare sample, then press Enter", A$
170 CLS
180 I = 1
190 MEAS.LOOP:
200 PRINT #1, "*TRG::MEAS?"
210 INPUT #1, F.ALL(I), CP(I), F.CP(I), D(I)
220 I = I + 1
230 IF I > X THEN GOTO MEAS.END
240 CLS
250 PRINT "Prepare sample number ";I;
260 INPUT ", then press Enter", A$
270 GOTO MEAS.LOOP
280 MEAS.END:
290 PRINT #1, ":COMP OFF"
300 CLS
310 PRINT "Sample nos. decided HI for C:";
320 FOR I = 1 TO X
330   IF F.CP(I) = 1 THEN PRINT I;
340 NEXT I
350 PRINT
360 PRINT "Sample nos. decided LOW for C:";
370 FOR I = 1 TO X
380   IF F.CP(I) = -1 THEN PRINT I;
390 NEXT I
400 PRINT
410 PRINT
420 PRINT "All measured results"
430 FOR I = 1 TO X
440   PRINT "Sample number"; I, CP(I), D(I)
450 NEXT I
460 CLOSE
470 END

```

**Program comments**

Line	Comment
10	Open the RS-232C circuit file.
20	Set displayed parameters to C-D.
30	Select external trigger mode.
40	Switch off headers for the response message.
50	Set the test frequency to 120 Hz.
60	Set the test range to range 5 (1.45 $\mu$ F).
70	Set the test voltage to 1 V.
80	Set the lower limit for C to 0.9000 $\mu$ F and upper limit to 1.1000 $\mu$ F.
90	Set the upper and lower limits for D to OFF.
130-140	Initialize values.
150	Switch on the comparator function.
190-280	Measurement loop Returns data as total results, measurement value of C, C desision, measurement value of D in order.
290	Switch off the comparator function.
310-340	Check HI decision for C.
360-390	Check LOW decision
460	Close the RS-232C circuit file.

**Sample output**

Sample no. decided HI for C: 25  
Sample nos. decided LOW for C:  
All measured results (C, D)  
Sample number 1: 1.0991E-06, 0.0010  
Sample number 2: 1.1002E-06, 0.0012  
Sample number 3: 1.0983E-06, 0.0019  
Sample number 4: 1.0991E-06, 0.0009  
Sample number 5: 1.1005E-06, 0.0012

## 6.18 Troubleshooting

If the RS-232C appears to be malfunctioning, refer to the information below before calling for servicing.

Symptom	Cause / Treatment
The RS-232C has stopped working completely.	Are the cables properly connected?
	Are all the devices powered on?
	Has the communication condition been correctly set?
Although a command has been transmitted, nothing has happened.	Using the "*ESR?" query, inspect the standard event status register, and check what type of error has occurred.
	Using the ":ERROR?" query, and check whether transmission error occurred on the RS-232C.
Sending several queries, produces only one response.	Has an error occurred?
	Send the queries one at a time, and read the responses individually. When you want to read them in all at once, try doing so by putting them all on one line separated by the message separator character.
The response message to a query differs from the display on the front panel of the 3511-50.	Due to the response message being produced at the instant that the 3511-50 receives the query, there is a possibility that it may not agree with the display at the instant that the controller reads it in.
Beeper sounds when *TRG command is transferred.	Is the trigger is set to internal trigger?
	*TRG command can be used for the external trigger setting. For the internal trigger setting, an execution error occurs.

### Service

If damage is suspected, check the "Troubleshooting" section before contacting your dealer or Hioki representative.



---

# Chapter 7

## Maintenance, Adjustment, and Disposal

---

---

### 7.1 Maintenance and Servicing

In order to use the 3511-50 safely, the following maintenance and checking procedures should be executed at the proper intervals.

- Be sure to read assiduously the various items highlighted in this manual for attention, in order to use the unit correctly.
- If the operation of the unit appears abnormal, first read Section 7.4, "Troubleshooting Checklist." If operation still appears abnormal, stop using the unit, and dispatch it for service at an approved HIOKI service facility.
- Getting the 3511-50 unit wet or letting oil or dust enter inside its casing will certainly damage it, and is quite likely to cause an electric shock accident or a dangerous conflagration. If the unit has gotten seriously wet, oily, or dusty, stop using it and send it for service at an approved HIOKI service facility.
- Periodic calibration is necessary in order to maintain and authenticate the accuracy of this testing device. When such calibration is necessary, you should utilize the services of an approved HIOKI calibration facility.
- A lithium battery is used in the 3511-50 for powering the backup memory. When this battery becomes unfit for service, and it is no longer possible to preserve the testing conditions, you should dispatch the unit to an approved HIOKI service facility for the lithium battery to be changed.
- Under normal conditions of use, the average life of the backup battery is about 6 years.
- Do not block the ventilation openings in the case of the 3511-50 unit with cloth or the like. If you do so, there is a danger of damaging the unit by overheating or even of causing a fire.

**NOTE**

HIOKI intend to maintain the supply of spare parts for maintenance and service of the 3511-50 unit for a minimum of seven years after the cessation of production.

**Cleaning the unit**

To clean the product, wipe it gently with a soft cloth moistened with water or mild detergent. Never use solvents such as benzene, alcohol, acetone, ether, ketones, thinners or gasoline, as they can deform and discolor the case.



## 7.2 How to Change the Power Supply Fuse and Change the Power Supply Voltage

The power supply fuse for the 3511-50 unit, and the power supply voltage selector, are housed in the power input socket on the rear panel.



- When changing the power supply fuse or changing the power supply voltage, in order to avoid the risk of electric shock accident, be quite sure first to turn the main switch of the 3511-50 unit off, and then to remove the power cord.  
Moreover, after finishing any operation, before reconnecting the power cord to the unit, be sure to check that the power supply voltage value indicated on the voltage selector housed in the power input socket on the rear panel is in agreement with the actual voltage value of the power supply line to which you intend to connect the unit.  
(The voltage indication is upside down.)
- Replace the fuse only with one of the specified characteristics and voltage and current ratings. Using a non-specified fuse or shorting the fuse holder may cause a life-threatening hazard.  
Fuse type:  
100 V, 120 V settings: 250 V F1.0 AL 20 mm x 5 mm dia.  
220 V, 240 V settings: 250 V F0.5 AL 20 mm x 5 mm dia.
- Before the 3511-50 is dispatched from the factory, it is set to the power supply voltage used at the destination specified for shipping, and the specified fuse for that power supply voltage is fitted, along with an identical spare fuse. If for any reason you intend to power the unit from a power supply whose voltage is different, be sure to change the fuse as well as altering the voltage selector setting.
- If you intend to use a power supply of a voltage other than the specified ones for powering the unit, use a fuse and voltage selector setting as follows:  
Actual power supply voltage 110 V : use settings for 120 V  
Actual power supply voltage 200 V : use settings for 220 V  
Actual power supply voltage 230 V : use settings for 240 V

---

### Changing the fuse, or altering the power supply voltage setting

- (1) Turn the power switch off, and then remove the power cord.
- (2) Using a slot head screwdriver or the like, bias sideways the catch which holds the fuse box into the power input socket as shown in the figure, and then remove the fuse box.

#### When changing the power supply fuse:

Change the power supply fuse for a new one of the same rating and specification.

#### When altering the power supply voltage setting:

- (1) Remove the voltage selector from the fuse box, and reinsert it after having rotated it so that the desired new power supply voltage setting appears in the display window as shown in the figure. Then recheck the setting value shown in the window.
- (2) Change the power supply fuse for a new one whose rating and specification are appropriate for the new power supply setting.
- (3) Replace the fuse box by reinserting it into the power input socket.



Illustrations showing changing the power supply fuse and changing the power supply voltage:

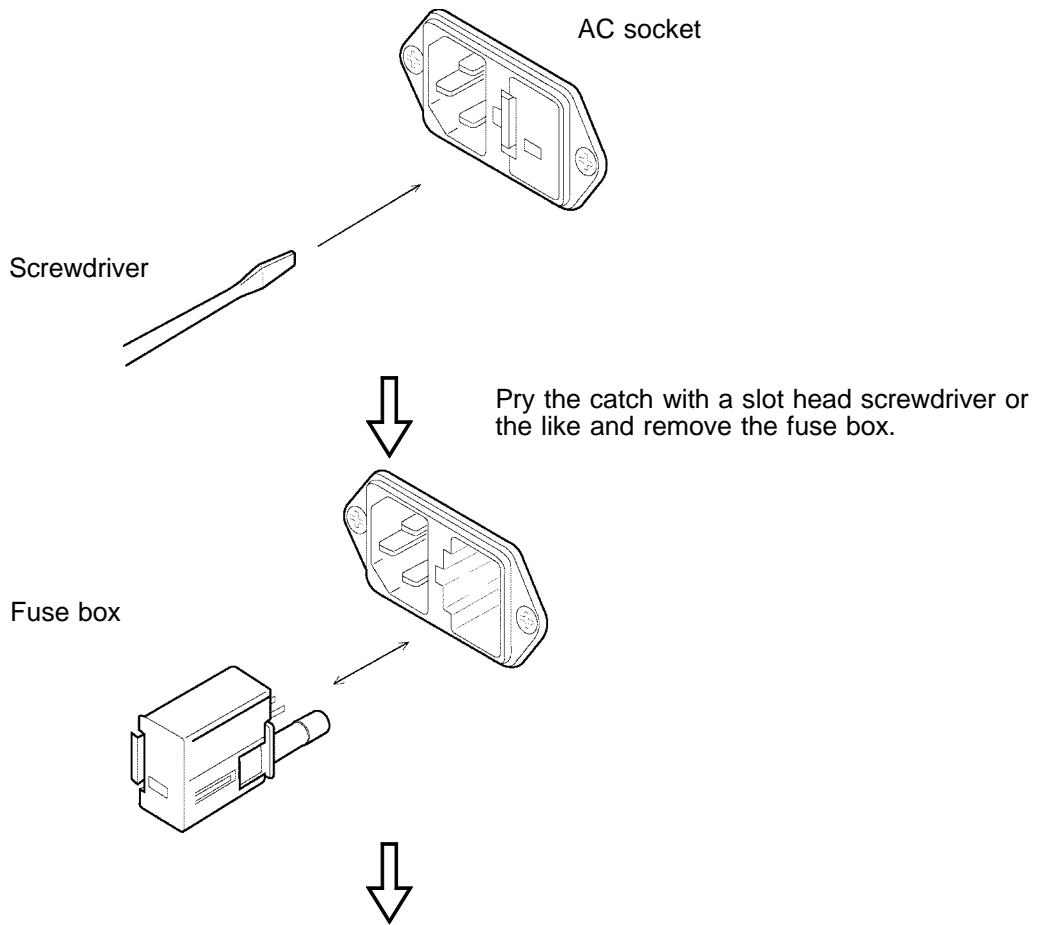

When changing the power supply fuse:

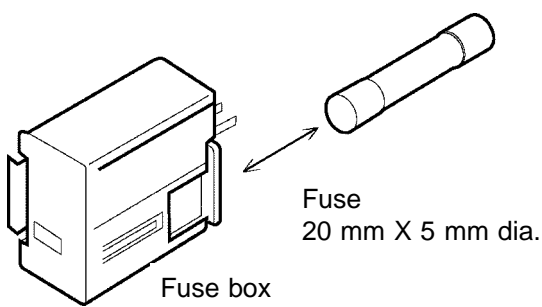

When altering the power supply voltage setting:

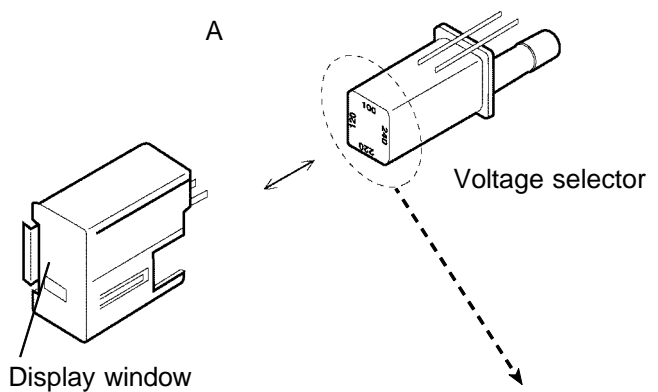

Remove the voltage selector, rotate it so that the figures which will appear in the display window represent the voltage of the power supply which will now be used, and then replace it.

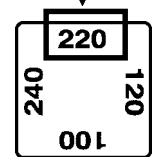

Portion A magnified



## 7.3 Shipping the Unit

If reshipping the unit, preferably use the original packing.

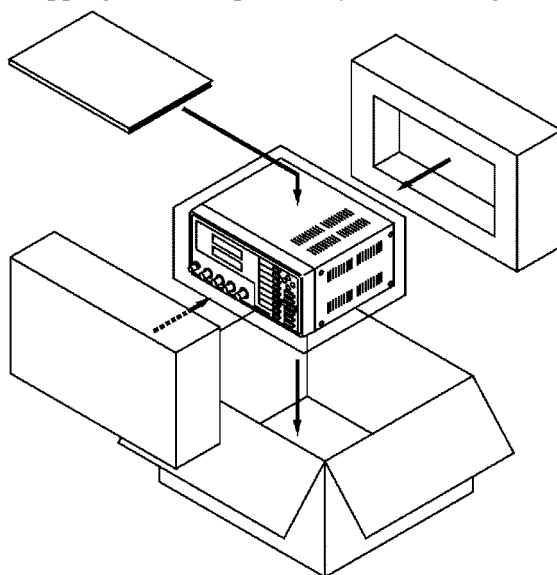

7

## 7.4 Troubleshooting

If the unit is not functioning properly, check the following items before sending it for repair.

Symptom	Cause	Solution
Nothing lights when the power is turned on.	Is the power cord disconnected?	Connect the power cord.
	Has the fuse blown?	Replace the fuse.
The keys do not operate.	Has the unit been put into the key lock condition?	Clear the key lock condition.
	Is the unit being remotely controlled through the GP-IB or RS-232C interface?	Set GP-IB or RS-232C to local.

If none of these is applicable, or if you have no idea of the problem, try resetting the system.

For the method of system reset, see Section 4.5.4, "Executing System Reboot."

If any of the following should occur, stop using the unit, disconnect the power cord and input cables, and contact your dealer or HIOKI representative.

- If you are certain that the unit is damaged.
- If the measurement is inoperative.
- If the unit was stored for a long period of time in high temperatures and humidity, or other undesirable conditions.
- If the unit was damaged in transit.

## 7.5 Disposing of the Unit

A lithium battery is used in the 3511-50 as a power source for recording test conditions.

### **WARNING**

- To avoid electrocution, turn off the power switch and disconnect the power cord and measurement cables before removing the lithium battery.
- When disposing of this product, remove the lithium battery and dispose of battery and product in accordance with local regulations.
- If the protective functions of the product are damaged, either remove it from service or mark it clearly so that others do not use it inadvertently.

#### Tools required for dismantling

- Phillips screwdriver 1
- Pair of tweezers 1

#### How to dismantle the unit

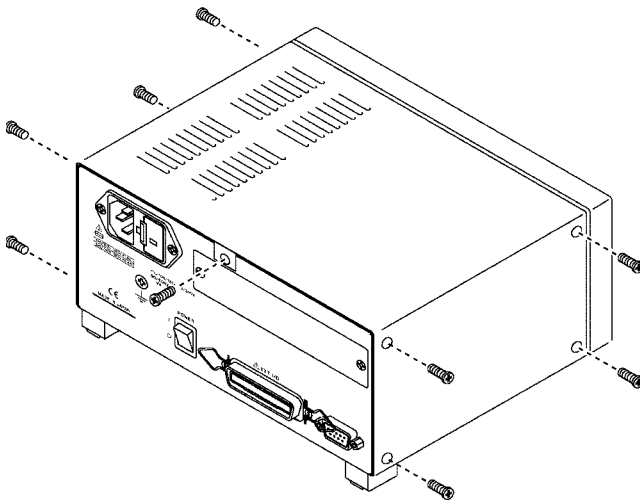

1. Remove the eight screws on the sides of the unit and the one screw at the back, as shown.
2. Remove the cover and four screws. Disconnect the connector, and remove the board.

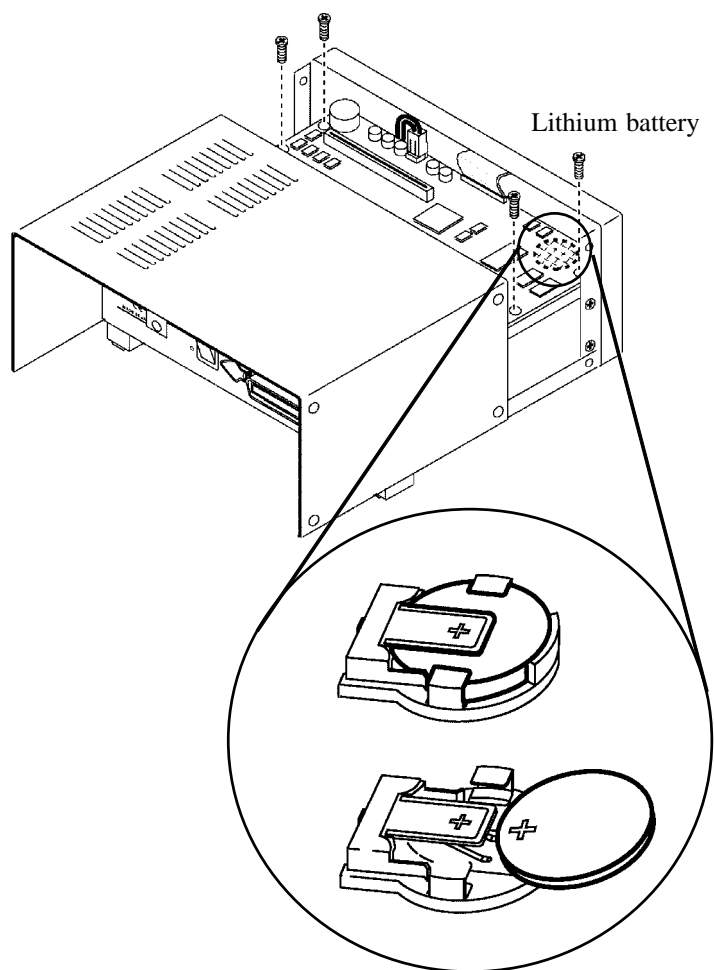

3. The battery holder is located in the position illustrated on the left. Insert a pointed tool, such as the tip of a tweezers, between the battery and the battery holder, and lift the battery to remove it.



# Chapter 8

## Specifications

### 8.1 General Specifications

Test parameters	$ Z $ (Impedance) $\theta$ (Phase angle) C (Capacitance) D (Loss coefficient, $\tan \delta$ ) L (Inductance) Q (Quality factor) R (Resistance)													
Test frequencies (FREQ)	120 Hz, 1 kHz (Frequency accuracy: $\pm 0.01\%$ or less)													
Output impedance	50 $\Omega$ $\pm$ 10 $\Omega$													
Test signal levels	50 mV, 500 mV, 1 V (Setting accuracy: $\pm 10\% \pm 5$ mV)													
Maximum short current	20 mA													
Residual charge protection	400 V max (for reference only) Where: $\sqrt{1/C}$ (C: capacitance of the sample under test in farads)													
Test ranges	Z, R: 0.0100 $\Omega$ to 200.00 M $\Omega$ (10 ranges) C: 00.940 pF to 999.99 mF (10 ranges) L: 01.600 $\mu$ H to 200.00 kH (10 ranges) D: 0.0001 to 1.9900 Q: 0.85 to 999.99													
Display	LED display													
Testing speed	Processing method: taken as the average of the waveform detected by the measurement circuit or the average of the calculated value. Measurement time depends on the time required for analog measurement and calculation. Measurement time depends on the test frequency and testing speed.													
	<table border="1"> <thead> <tr> <th>Testing speed \ Test frequency</th> <th>120 Hz</th> <th>1 kHz</th> </tr> </thead> <tbody> <tr> <th>FAST</th> <td>13 ms</td> <td>5 ms</td> </tr> <tr> <th>NORM</th> <td>90 ms</td> <td>60 ms</td> </tr> <tr> <th>SLOW</th> <td>400 ms</td> <td>300 ms</td> </tr> </tbody> </table>		Testing speed \ Test frequency	120 Hz	1 kHz	FAST	13 ms	5 ms	NORM	90 ms	60 ms	SLOW	400 ms	300 ms
Testing speed \ Test frequency	120 Hz	1 kHz												
FAST	13 ms	5 ms												
NORM	90 ms	60 ms												
SLOW	400 ms	300 ms												
Trigger function	Internal trigger (INT), external trigger (EXT)													

Zero compensation	<p>Open circuit compensation: Correction of residual admittance between the measurement terminals of the fixture. Operation is possible when, with the terminals open circuit, the impedance is at least 1 k<math>\Omega</math>.</p> <p>Short circuit compensation: Correction of residual impedance between the measurement terminals of the fixture. Operation is possible when, with the terminals short circuit, the impedance is less than 1 k<math>\Omega</math>.</p>
Comparator function	<p>Comparator setting: Upper and lower limits can be set for the main parameters (Z, C, L, R) and the sub-parameter (<math>\theta</math>, D), respectively.</p> <p>Comparator result output: LED lights for display of the comparator result. EXT I/O (HI, IN, LO, AND, INDEX, EOM)</p>
Panel save and load function	<p>99 sets of complete test conditions can be saved. The given test conditions can be read via key operation or using EXT I/O control signals.</p>
System reboot	All of the settings will revert to the factory settings.
Key lock function	This disables the operation of keys on the panel (excluding the manual trigger key).
Beep sound setting	There are settings corresponding to the comparator results.
Interfaces	<p>EXT I/O (External I/O for sequence) (Standard)</p> <p>RS-232C interface (Standard)</p> <p>9518-01 GP-IB INTERFACE (Option)</p>
Operating temperature and humidity range	0 to 40°C (32 to 104°F), 35 to 80%RH (no condensation)
Temperature and humidity range to guarantee specification	-10 to 55°C (14 to 131°F), up to 80%RH (no condensation)
Operating Environment	Indoors, up to 2000 m (6562 feet) ASL
Power supply	<p>Rated supply voltage: 100/120/220/240 VAC (switchable)</p> <p>Rated power frequency: 50/60 Hz</p> <p>Maximum rated power: 20 VA <math>\pm</math> 10% (with GP-IB installed)</p>
Dimensions and mass	<p>210W x 100H x 168D mm (8.27"W x 3.94"H x 6.61"D)</p> <p>2.5 kg (88.2 oz.)</p>
Accessories	<p>Instruction Manual</p> <p>Power cord (selected according to shipping destination)</p> <p>Spare fuse for power supply (selected according to shipping destination) (100 to 120 V: 250 VF1.0 AL, 200 to 240 V: 250 VF0.5 AL)</p>
Component replacement	Power supply fuse (refer to above)

Options	<p>9140 4-TERMINAL PROBE  9143 PINCHER PROBE  9261 TEST FIXTURE  9262 TEST FIXTURE (direct connection type)  9263 SMD TEST FIXTURE (direct connection type)  9268 DC BIAS VOLTAGE UNIT  9269 DC BIAS CURRENT UNIT  9165 CONNECTION CORD (for 9268, 9269/BNC-BNC/1.5 m)  9166 CONNECTION CORD (for 9268, 9269/BNC-clip/1.5 m)  9442 PRINTER  9443-01 AC ADAPTER (for printer, for Japan)  9443-02 AC ADAPTER (for printer, for EU)  9443-03 AC ADAPTER (for printer, for U.S.A)  9444 CONNECTION CABLE (for printer)  1196 RECORDING PAPER (for printer)  9518-01 GP-IB INTERFACE  9151-02 GP-IB CONNECTOR CABLE (2 m)  9151-04 GP-IB CONNECTOR CABLE (4 m)</p>	
Standards applying	<p>EMC</p> <p>Safety</p>	<p>EN61326-1:1997+A1:1998  EN61000-3-2:1995+A14:2000  EN61000-3-3:1995  Effect of radiated radio-frequency electromagnetic field:  A maximum of <math>\pm 20</math> count at 3 V/m  Effect of conducted <math>\pm</math> radio-frequency electromagnetic field:  A maximum of <math>\pm 120</math> count at 3 V</p> <p>EN61010-1:1993+A2:1995  (Power supply)  Pollution Degree 2 Overvoltage Category II  (anticipated transient overvoltage 2500 V)  (Test terminals)  Pollution Degree 2 Overvoltage Category I  (anticipated transient overvoltage 330 V)</p>

## 8.2 Testing Parameters and Calculation Equations

Normal circuit elements etc. are assessed with regard to their characteristics in terms of their impedance  $Z$ . The 3511-50 for subjects such circuit components to an alternating current signal at a certain test frequency, measures their voltage and current vectors, and from these values obtains the impedance  $Z$  and the phase angle  $\theta$ . It is then possible to obtain the following quantities from the impedance  $Z$  by displaying it upon the complex plane.

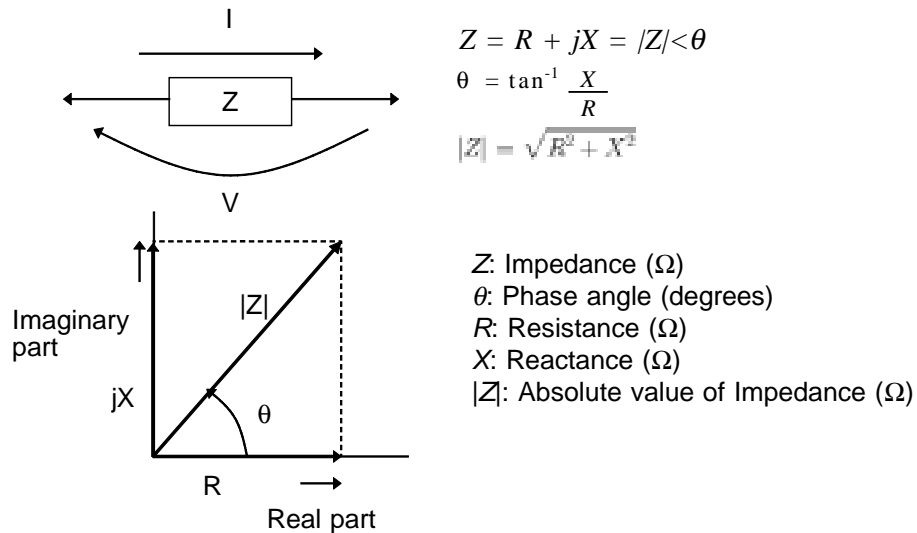

Moreover, it is possible to use the admittance  $Y$ , which as a characteristic of a circuit component is the reciprocal of the impedance  $Z$ .

By displaying the admittance  $Y$  upon the complex plane (just as was done for the impedance  $Z$ ) the following quantities can be obtained:

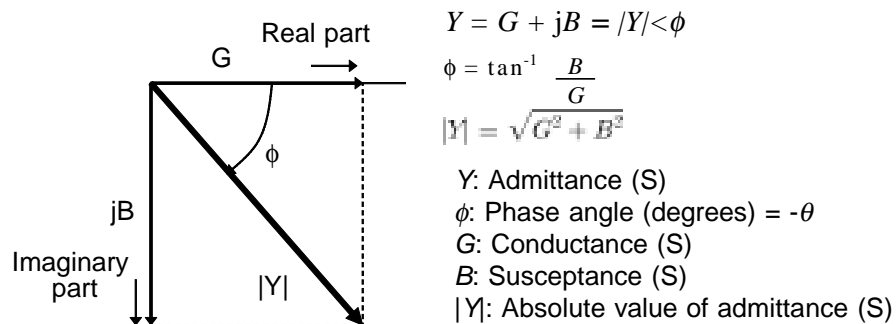



From the voltage  $V$  which is applied between the terminals of the sample under test, the current  $I$  which flows through the test sample at this time, the phase angle  $\theta$  between this voltage  $V$  and this current  $I$ , and the angular velocity  $\omega$  which corresponds to the test frequency, the 3511-50 can calculate the following components by using the calculation equations shown:

**NOTE**

The phase angle  $\theta$  is shown based on the impedance  $Z$ . When measuring based on the admittance, the sign of the phase angle  $\theta$  must be reversed.

Quantity	Series equivalent circuit mode	Parallel equivalent circuit mode
$Z$	$ Z  = \frac{V}{I} (= \sqrt{R^2 + X^2})$	
$R$	$R_s = ESR =  Z  \cos \theta$	$R_p = \frac{ Z }{\cos \theta}$
$L$	$L_s = \frac{ Z  \sin \theta}{\omega}$	$L_p = \frac{ Z }{\omega \sin \theta}$
$C$	$C_s = \frac{1}{\omega  Z  \sin \theta}$	$C_p = \frac{\sin \theta}{\omega  Z }$
$D$	$D = \left  \frac{1}{\tan \theta} \right $	
$Q$	$Q =  \tan \theta  (= \frac{1}{D})$	

$L_s$ ,  $R_s$ ,  $C_s$ : The measured values of  $L$ ,  $C$ , and  $R$  in series equivalent circuit mode.

$L_p$ ,  $R_p$ ,  $C_p$ : The measured values of  $L$ ,  $C$ , and  $R$  in parallel equivalent circuit mode.

## 8.3 Test Accuracy

### Basic accuracy

The basic accuracy is one of the values (% or absolute) provided in the Basic Accuracy Table for a respective parameter.

Basic accuracy conditions:

1. Common to all parameters

Test signal level	1 V
Temperature and humidity range	$23 \pm 5^\circ\text{C}$ , 80%RH or less
Test speed	SLOW
Cable length coefficient	0 m
Operation 60 minutes after the power is turned on	
Open circuit compensation and short circuit compensation both being performed	

2. C-measurement conditions:  $D \leq 0.1$
3. L-measurement conditions:  $D \leq 0.1$  ( $Q \geq 10$ )
4. R-measurement conditions:  $\theta \leq 6^\circ$

If the test condition is different from above, the coefficients 1 to 3 must be multiplied and 4 must be added to the basic accuracy. (Refer to each coefficient tables 1 to 4.)

#### NOTE

- When C, L, or R exceeds the range of D or  $\theta$  shown above, obtain the Z and  $\theta$  values of the sample from the calculation described in Section 8.2 (this is possible with Z- $\theta$  measurements for 3511-50). Determine accuracy using the following calculation.
- When the measurement range is 1 or 10, measurements at 50 mV of measurement signal level are handled only as reference values.

### Sample calculation of the accuracy value

When C = 160 nF, D = 0.2, test frequency = 1 kHz, signal level = 1 V, and speed = SLOW:

- (1) Find Z- $\theta$  (this is possible with Z- $\theta$  measurements for 3511-50).  
 $\theta = \tan^{-1}(1/D) = 78.69^\circ$   
 $Z = (1/\omega C) \times (1/\sin\theta) = 1.0144$  (k $\Omega$ )
- (2) Find the accuracies of Z and  $\theta$ .  
 Because a measurement is made at Range 6 based on the Z value of the sample, we obtain the Z accuracy of  $\pm 0.11\%$  and the  $\theta$  accuracy of  $\pm 0.08^\circ$ .
- (3) From the accuracies, find ranges that each of Z and  $\theta$  can take.  
 $Z_{\max} = 1.0155$  (k $\Omega$ ),  $Z_{\min} = 1.0133$  (k $\Omega$ )  
 $\theta_{\max} = 78.77^\circ$ ,  $\theta_{\min} = 78.61^\circ$
- (4) From the ranges of Z and  $\theta$ , determine ranges that each of C and D can take.  
 $C_{\max} = 1/(Z_{\min} \times \omega \times \sin\theta_{\min}) = 160.221$  (nF) ..... Accuracy: +0.14%  
 $C_{\min} = 1/(Z_{\max} \times \omega \times \sin\theta_{\max}) = 159.785$  (nF) ..... Accuracy: -0.14%  
 $D_{\max} = 1/\tan\theta_{\min} = 0.2015$  ..... Accuracy: +0.0015  
 $D_{\min} = 1/\tan\theta_{\max} = 0.1985$  ..... Accuracy: -0.0015
- (5) Hence the accuracy of C:  $\pm 0.14\%$ ; that of D:  $\pm 0.0015$

The coefficients corresponding to the following settings are calculated from each table and must be multiplied (4 must be added) to the basic accuracy.

### 1. Test signal level

	50 mV	500 mV	1 V
Coefficient	2	1.5	1

### 2. Test speed coefficient

	FAST	NORMAL	SLOW
Coefficient	3	1.5	1

### 3. Test cable length coefficient

	0 m	1 m
Coefficient	1	1.5

### Temperature coefficient

	Operating temperature = T (°C)
Coefficient	0.1 x basic accuracy x (T-23)

Accuracy table

Range No. (Z, L, R)	Z-θ		L-D		R	Range No. (C)	C-D	
10	Z	$\pm(2.00+0.11XZ_H)\%$	L	$\pm(2.00+1.00XfXL_H)\%$	R	1	C	$\pm(1.70+30/(fXC_L))\%$
	θ	$\pm(0.70+0.08XZ_H)^\circ$	D	$\pm(0.0120+0.0100XfXL_H)$			D	$\pm(0.0120+0.25/(fXC_L))$
9	Z	$\pm(0.15+0.16XZ_H)\%$	L	$\pm(0.17+1.17XfXL_H)\%$	R	2	C	$\pm(0.17+30/(fXC_L))\%$
	θ	$\pm(0.10+0.09XZ_H)^\circ$	D	$\pm(0.0020+0.0110XfXL_H)$			D	$\pm(0.0020+0.264/(fXC_L))$
8	Z	$\pm 0.30\%$	L	$\pm 0.34\%$	R	3	C	$\pm 0.34\%$
	θ	$\pm 0.19^\circ$	D	$\pm 0.0036$			D	$\pm 0.0036$
7	Z	$\pm 0.14\%$	L	$\pm 0.16\%$	R	4	C	$\pm 0.16\%$
	θ	$\pm 0.10v$	D	$\pm 0.0020$			D	$\pm 0.0020$
6	Z	$\pm 0.11\%$	L	$\pm 0.13\%$	R	5	C	$\pm 0.13\%$
	θ	$\pm 0.08^\circ$	D	$\pm 0.0016$			D	$\pm 0.0016$
5	Z	$\pm 0.08\%$	L	$\pm 0.09\%$	R	6	C	$\pm 0.09\%$
	θ	$\pm 0.05^\circ$	D	$\pm 0.0011$			D	$\pm 0.0011$
4	Z	$\pm 0.08\%$	L	$\pm 0.10\%$	R	7	C	$\pm 0.10\%$
	θ	$\pm 0.08^\circ$	D	$\pm 0.0016$			D	$\pm 0.0016$
3	Z	$\pm 0.35\%$	L	$\pm 0.39\%$	R	8	C	$\pm 0.39\%$
	θ	$\pm 0.18^\circ$	D	$\pm 0.0034$			D	$\pm 0.0034$
2	Z	$\pm 1.80\%$	L	$\pm 2.10\%$	R	9	C	$\pm 2.10\%$
	θ	$\pm 1.00^\circ$	D	$\pm 0.0179$			D	$\pm 0.0179$
1	Z	$\pm(1.00+0.15/Z_L)\%$	L	$\pm(0.90+30/(fXL_L))\%$	R	10	C	$\pm(0.60+1.50XfXC_H)\%$
	θ	$\pm(0.10+0.09/Z_L)^\circ$	D	$\pm(0.0021+0.264/(fXL_L))$			D	$\pm(0.0015+0.0108XfXC_H)$

Test condition:

Test speed: SLOW, Test signal level: 1 V, Open circuit compensation and short circuit compensation both being performed, Cable length coefficient: 0 m

1.  $Z_H$  is the impedance of the sample. (MΩ)
2.  $Z_L$  is the impedance of the sample. (Ω)
3.  $C_L$  is the static capacitance of the sample. (pF)
4.  $C_H$  is the static capacitance of the sample. (mF)
5.  $L_H$  is the inductance of the sample. (kH)
6.  $L_L$  is the inductance of the sample. (μH)
7.  $f$  is the test frequency. (kHz)
8.  $Q$  is the result of 1 divided by  $D$ .
9.  $R_H$  is the resistance of the sample. (MΩ)
10.  $R_L$  is the resistance of the sample. (Ω)

Range Number and Range Name Correspondence

Parameter Frequency Range No	Z, R	C		L	
	Common	120 Hz	1 kHz	120 Hz	1 kHz
10	200 MΩ	1 F	100 mF	200 kH	20 kH
9	10 MΩ	14.5 m F	1.7 mF	13 kH	1.55 kH
8	1 MΩ	1.45 mF	170 μF	1.3 kH	155 H
7	100 kΩ	145 μF	17 μF	130 H	15.5 H
6	10 kΩ	14.5 μF	1.7 μF	13 H	1.55 H
5	1 kΩ	1.45 μF	170 nF	1.3 H	155 mH
4	100 Ω	145 nF	17 nF	130 mH	15.5 mH
3	10 Ω	14.5 nF	1.7 nF	13 mH	1.55 mH
2	1 Ω	1.45 nF	170 pF	1.3 mH	155 μH
1	100 mΩ	145 pF	17 pF	130 μH	15.5 μH

# Chapter 9

## Options

### 9518-01 GP-IB INTERFACE

Compliance standard: IEEE-488.1 (1987)

Reference standard: IEEE-488.2 (1987)

For explanation of how to fit the 9518-01 GP-IB INTERFACE and for a detailed description of its commands etc., reference should be made to the user manual supplied with the 9518-01.

### 9140 4-TERMINAL PROBE

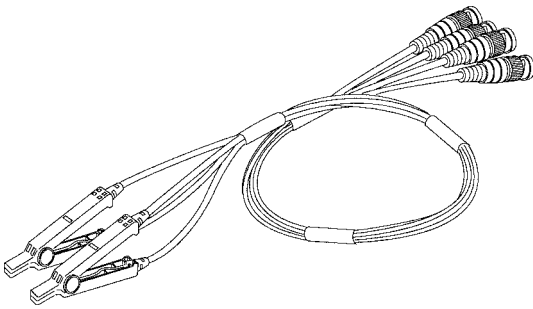

This is a crocodile clip type of test probe. This type of probe is very convenient for connection to a wide range of wires, from comparatively thin wires to comparatively thick ones.

### 9143 PINCHER PROBE

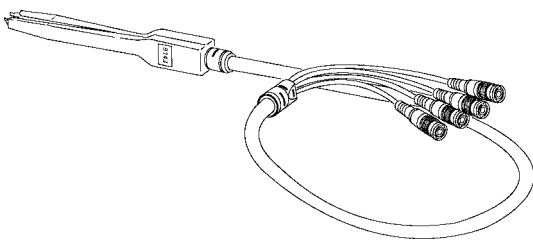

This tweezer type probe is very convenient for testing samples such as chips. The impedance range which can be measured by the 3511-50 using this probe varies according to the frequencies.

**NOTE**

When using a probe, it may happen that the values obtained vary because the contact resistance is altering due to alterations in the pinch pressure exerted. Therefore it is necessary to keep the pinch pressure as constant as possible.

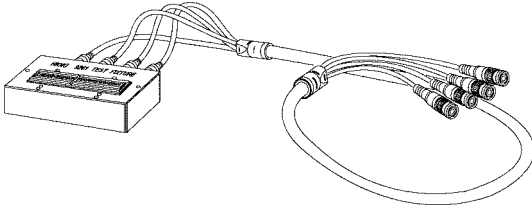
**9261 TEST FIXTURE**

Samples to be tested can be comparatively easily loaded into and removed from this type of fixture.

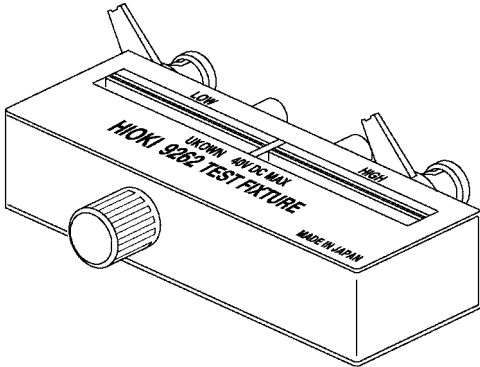
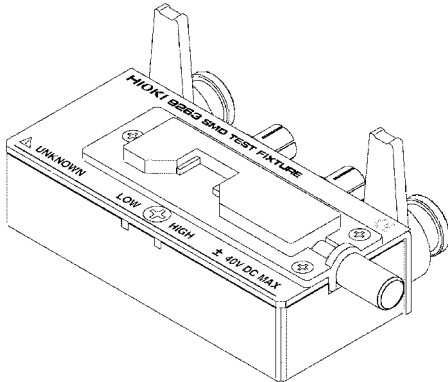
**9262 TEST FIXTURE****9263 SMD TEST FIXTURE**

This is very convenient for testing samples such as chips.

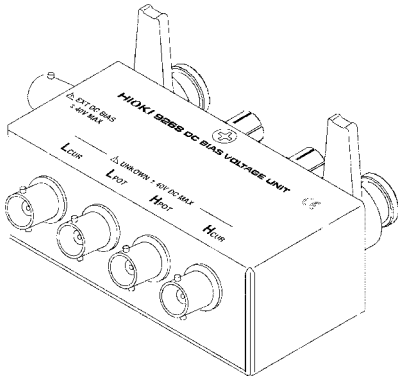
**9268 DC BIAS VOLTAGE UNIT**

Maximum input voltage: 40 VDC

## 9269 DC BIAS CURRENT UNIT

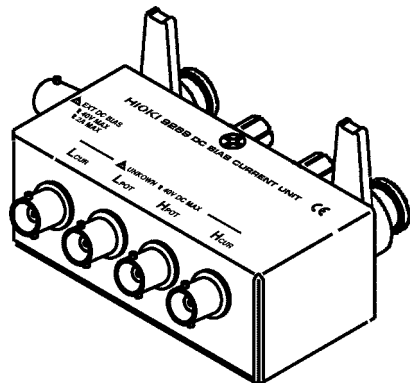

Maximum input voltage: 2 A

## 9442 PRINTER

The test values can be printed out.

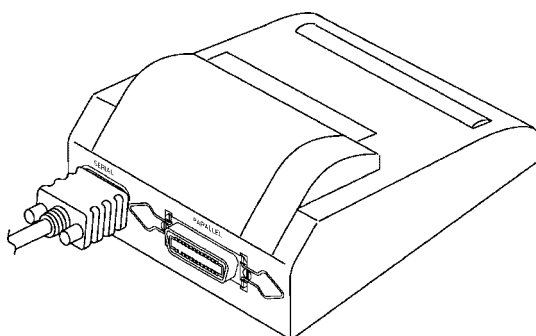

To use the printer, the following optional units are necessary.

9443-01 AC ADAPTER (for printer, for Japan)

9443-02 AC ADAPTER (for printer, for EU)

9443-03 AC ADAPTER (for printer, for U.S.A)

9444 CONNECTION CABLE

1196 RECORDING PAPER





**HIOKI**

**DECLARATION OF CONFORMITY**

Manufacturer's Name: HIOKI E.E. CORPORATION  
Manufacturer's Address: 81 Koizumi, Ueda, Nagano 386-1192, Japan  
Product Name: LCR HiTESTER  
Model Number: 3511-50  
Options: 9518-01 GP-IB INTERFACE  
9261 TEST FIXTURE  
9262 TEST FIXTURE  
9263 SMD TEST FIXTURE  
9268 DC BIAS VOLTAGE UNIT  
9269 DC BIAS CURRENT UNIT  
9140 4-TERMINAL PROBE  
9143 PINCHER PROBE  
9165 CONNECTION CORD  
9166 CONNECTION CORD  
9151-02 GP-IB CONNECTOR CABLE  
9151-04 GP-IB CONNECTOR CABLE

The above mentioned products conform to the following product specifications:

Safety: EN61010-1:1993+A2:1995  
EMC: EN61326-1:1997+A1:1998  
ClassB equipment  
Minimum immunity test requirement  
EN61000-3-2:1995+A14:2000  
EN61000-3-3:1995

Supplementary Information:

The product herewith complies with the requirements of the Low Voltage Directive 73/23/EEC and the EMC Directive 89/336/EEC.

19 July 2002

HIOKI E.E. CORPORATION

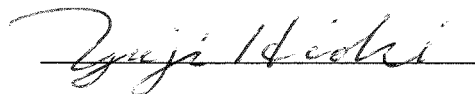

Yuji Hioki  
President

3511C999-02



## **HIOKI 3511-50 LCR HiTESTER**

### Instruction Manual

Publication date: July 2002                      Revised edition 2

Edited and published by HIOKI E.E. CORPORATION  
Technical Support Section

All inquiries to Sales and Marketing International Department

81 Koizumi, Ueda, Nagano, 386-1192, Japan

TEL: +81-268-28-0562 / FAX: +81-268-28-0568

E-mail: [os-com@hioki.co.jp](mailto:os-com@hioki.co.jp)

URL <http://www.hioki.co.jp/>

Printed in Japan 3511C981-02

- 
- 
- All reasonable care has been taken in the production of this manual, but if you find any points which are unclear or in error, please contact your supplier or the Sales and Marketing International Department at HIOKI headquarters.
  - In the interests of product development, the contents of this manual are subject to revision without prior notice.
  - Unauthorized reproduction or copying of this manual is prohibited.
- 
-

# **HIOKI** ---

**HIOKI E. E. CORPORATION**

**HEAD OFFICE**

81 Koizumi, Ueda, Nagano 386-1192, Japan  
TEL +81-268-28-0562 / FAX +81-268-28-0568  
E-mail: [os-com@hioki.co.jp](mailto:os-com@hioki.co.jp)

**HIOKI USA CORPORATION**

6 Corporate Drive, Cranbury, NJ 08512, USA  
TEL +1-609-409-9109 / FAX +1-609-409-9108

---

3511C981-02 02-07H



Printed on recycled paper

---