

MILLTRONICS

AIRANGER SPL

Instruction Manual PL-573

March 2001

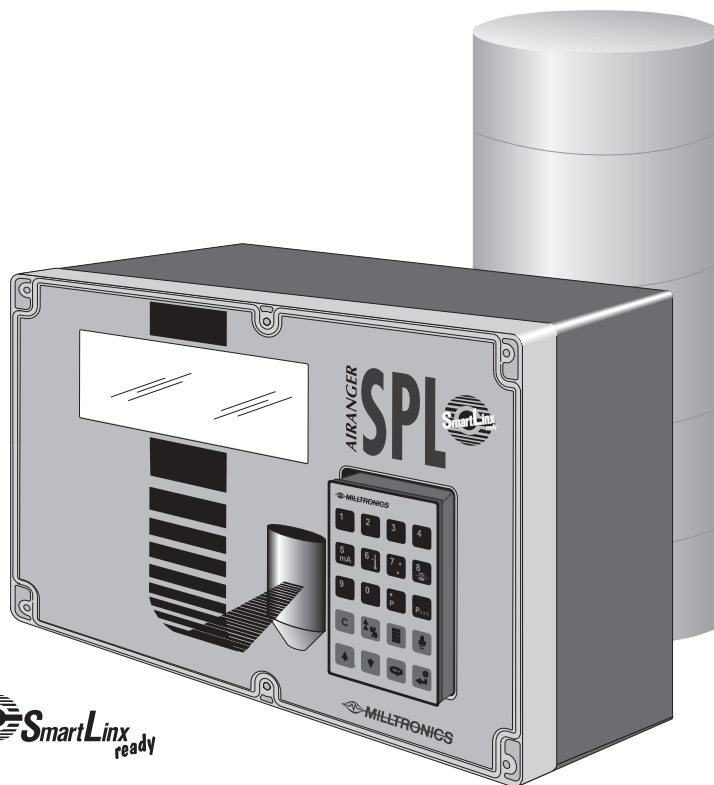

 **SmartLinx**
ready

AIRANGER SPL

Safety Guidelines

Warning notices must be observed to ensure personal safety as well as that of others, and to protect the product and the connected equipment. These warning notices are accompanied by a clarification of the level of caution to be observed.

Qualified Personnel

This device/system may only be set up and operated in conjunction with this manual. Qualified personnel are only authorized to install and operate this equipment in accordance with established safety practices and standards.

Warning: This product can only function properly and safely if it is correctly transported, stored, installed, set up, operated, and maintained.

Note: Always use product in accordance with specifications.

Copyright Siemens Milltronics Process Instruments Inc. 2000. All Rights Reserved	Disclaimer of Liability
This document is available in bound version and in electronic version. We encourage users to purchase authorized bound manuals, or to view electronic versions as designed and authored by Siemens Milltronics Process Instruments Inc. Siemens Milltronics Process Instruments Inc. will not be responsible for the contents of partial or whole reproductions of either bound or electronic versions.	While we have verified the contents of this manual for agreement with the instrumentation described, variations remain possible. Thus we cannot guarantee full agreement. The contents of this manual are regularly reviewed and corrections are included in subsequent editions. We welcome all suggestions for improvement. Technical data subject to change.

MILLTRONICS® is a registered trademark of Siemens Milltronics Process Instruments Inc.

Contact SMPI Technical Publications at the following address:

Technical Publications
Siemens Milltronics Process Instruments Inc.
1954 Technology Drive, P.O. Box 4225
Peterborough, Ontario, Canada, K9J 7B1
Email: techpubs@milltronics.com

For the library of SMPI instruction manuals, visit our Web site: www.milltronics.com

Table of Contents

Specifications	5
Electronics	5
Programmer	6
Transducer	6
Options	6
Cable	7
Introduction	9
About this Manual	9
About the AiRanger SPL	10
Important AiRanger SPL Features	13
Installation	15
AiRanger SPL	15
Mounting	16
Interconnection	17
Optional Smartlinx® Module	18
System Diagram	18
Communication	20
SmartLinx®	21
Level System Synchronization	22
Power	22
Programming	25
Display	25
Keypad	26
Program Mode Entry	27
Parameter Value Alteration	27
Parameter Reset Features	27
Special Parameters	28
Programming Security	28
Quick Start Parameters	29
Operation	31
Display	31
Keypad	32
System Performance Evaluation	33
Performance Test Results	34
Application Parameters	35
Volume Parameters (P050 to P055)	35
Failsafe Parameters (P070 to P072)	39
Relay Parameters (P100 to P104, P110 to P113, P129)	41
mA Output Parameters (P200 to P203, P210 to P215, P219)	48
Enhancement Parameters	51
Data Logging Parameters (P300 and P302)	52
Profile Records (P330 to P337)	53
Installation Records (P340 to P342)	56
Range Calibration Parameters (P650 to P654)	56
Temperature Compensation Parameters (P660 to P664)	59
Rate Parameters (P700 to P707)	60
Measurement Verification Parameters (P710 to P713)	62

Scanning Parameters (P725 to P729)	64
Display Parameters (P730 to P733, P740)	65
Peripheral Communication Support Parameters (P740 to P749).....	67
SmartLinx [®] Parameters (P750 to P792).....	68
Echo Processing Parameters (P800 to P807)	69
Advanced Echo Processing (P810,P816-P825,P830-P835,P840-P845,P850- P852).....	72
Test Parameters (P900 to P913).....	80
Measurement Parameters (P920 to P923).....	83
Master Reset (P999)	85
Technical Reference	87
Transmit Pulse	87
Echo Processing	87
Distance Calculation.....	88
Sound Velocity	88
Volume Calculation	89
Measurement Response	90
Application Examples.....	91
Communication Support.....	98
Maintenance	101
Troubleshooting Guide.....	103
Measurement Difficulties	104
Flashing “LOE” Display	104
Fixed Reading	105
Wrong Reading	106
Programming Charts	109

Specifications

Electronics

- Power:
 - o ac:
 - o 100/115/200/230 V ac $\pm 15\%$, 50/60 Hz, 31 VA
- Environmental:
 - o location
 - o indoor / outdoor
 - o altitude
 - o 2000 m max
 - o ambient temperature
 - o -20 to 50°C (-5 to 122°F)
 - o relative humidity
 - o suitable for outdoor (Type 4X / NEMA 4X / IP65 enclosure)
 - o installation category
 - o II
 - o pollution degree:
 - o 4
- Scan Points:
 - o 1 point per AiRanger SPL max.
 - o frequency independent
- Range:
 - o Level Measurement:
 - o 0.3 m (1 ft) to 60 m (200 ft) max.
- Accuracy:
 - o 0.25% of range or 6 mm (0.24"), whichever is greater
- Resolution:
 - o 0.1% of program range* or 2 mm (0.08"), whichever is greater
- Memory:
 - o EEPROM (non-volatile) no back-up battery required
- Programming:
 - o via removable programmer or optional Dolphin Plus
- Display:
 - o Custom Graphics backlit LCD with 51 mm (2 in) x 127 mm (5 in) viewing area
- Temperature Compensation:
 - o -50 to 150°C (-58 to 302°F)
 - o integral transducer sensor
 - o TS-3 temperature sensor
 - o programmable fixed temperature
- Temperature Error:
 - o with compensation: 0.09% of range
 - o fixed temperature: 0.17% / $^{\circ}\text{C}$ deviation from programmed temperature.
- Outputs:
 - o transducer drive: 150 to 315 V peak (transducer model dependent)
 - o relays:
 - o 4 alarm/control relays
 - o 1 form "C" SPDT contact per relay,
 - o rated 5 A at 250 V ac, non-inductive
 - o analog:
 - o 1 output max.
 - o 0.1% resolution
 - o 0-20 or 4-20 mA, scalable
 - o $750\ \Omega$, isolated, 30V rms

* program range is defined as the empty distance to the face of the transducer (P006) plus any range extension (P801).

- Communications: (see Options)
- SmartLinx[®] compatible
 - RS-232 / 485 port
 - Dolphin compatible
 - proprietary bipolar current loop for BIC-2 communication
- Enclosure:
- Type 4X / NEMA 4X / IP65
 - 285 mm W x 209 mm H x 92 mm D (11.2" W x 8.2" H x 3.6" D)
 - polycarbonate
- Weight:
- 2.7 kg (6 lb)
- Approvals:
- See device nameplate.

Programmer

- Power:
- 9 V (ANSI/NEDA 1604, PP3 or equivalent)
- Ambient Temperature:
- -20 to 50°C (-5 to 122°F)
- Keypad:
- 20 keys with tactile feedback
- Interface:
- non-invasive, digital, infra-red
- Enclosure:
- general purpose
 - 67 mm W x 100 mm H x 25 mm D (2.6" W x 4" H x 1" D)
 - ABS plastic
- Weight:
- 150 g (0.3 lb)

Transducer

- Compatible Models:
- ST Ultrason[®], LR, STH and Echomax[®] series
 - Refer to the associated instruction manual.

Options

- Temperature Sensor:
- TS-3
- Buffered Interface Converter:
- BIC-II, SPL bipolar communication current loop to remote RS232 or RS422 port
- SmartLinx[®] Modules
- protocol specific modules for interface with popular industrial communication systems. Refer to associated product documentation.
- Dolphin Plus:
- Milltronics Windows[®]-compatible interface and infrared ComVerter link
Refer to associated product documentation.

Cable

Transducer:	RG-62 A/U (or equivalent), 365m (1,200 ft) max. See transducer instructions for short extensions (in grounded metal conduit, separate from other wiring)
mA Output:	Belden 8760, shielded / twisted pair, 18 AWG (0.75 mm ²) or equivalent maximum separation 1,500 m (5,000 ft)
Synchronisation:	Belden 8760, shielded / twisted pair, 18 AWG (0.75 mm ²) or equivalent
Relays:	No shielded cable necessary
Bipolar current loop:	Belden 8760, shielded / twisted pair, 18 AWG (0.75 mm ²) or equivalent maximum separation 1,500 m (5,000 ft)
Temperature Sensor:	Belden 8760 shielded / twisted pair, 18 AWG (0.75 mm ²) or equivalent 365 m (1200 ft) per TS-3 maximum
RJ11 Link:	No shielded cable necessary maximum length 3 m (10 ft)
RS-232 Link:	Belden 8770, 3 conductor/shielded, 18 AWG (0.75mm ²) or equivalent maximum separation 15m (50ft)
RS-485 Link:	Belden 8770, 3 conductor/shielded, 18 AWG (0.75mm ²) or equivalent maximum separation 1200m (4000ft)
Smartlinx [®] module:	refer to the associated instruction manual.

Introduction

About this Manual

This instruction manual provides information specific to the AiRanger SPL (Single Point Level) monitor.

When references are made to other Milltronics products associated with an AiRanger SPL based level measurement system, refer to the associated product instruction manuals, if necessary.

After reading this Introduction and completing the physical Installation, first time system installers may wish to use the AiRanger SPL Quick Start Guide, PL-431 for step by step start up instructions.

<i>Specifications</i>	lists the environmental, physical, and operational characteristics associated with the SPL.
<i>Introduction</i>	introduces installers and operators to the SPL, with brief descriptions of key features.
<i>Installation</i>	provides a step by step procedure to install and interconnect a SPL based level measurement system.
<i>Programming</i>	defines program mode display and keypad functions, and general programming information.
<i>Quick Start Parameters</i>	details the minimum recommended programming required to prepare the SPL for RUN mode operation.
<i>Operation</i>	defines RUN mode display and keypad functions, including the RUN mode entry procedure and performance evaluation recommendations.
<i>Application Parameters</i>	details the programmable features which may be used to alter Run mode display, failsafe, relay, and mA output operation.
<i>Enhancement Parameters</i>	defines the programmable features used to enhance RUN mode operation. (Typically used as directed by the Troubleshooting Guide).
<i>Technical Reference</i>	provides detailed information for complex features and details 2 specific application examples.
<i>Troubleshooting Guide</i>	provides a quick reference to installation modification and programming remedies to overcome challenging operating conditions.
<i>Programming Chart</i>	provides a convenient space to record all programming for future reference.

REMEMBER!

"Programming is not complete until the Programming Chart is completed".

About the AiRanger SPL

Note:

The AiRanger SPL is to be used only in the manner outlined in this instruction manual.

This microprocessor based level monitor is designed specifically for bulk solids and liquid level measurement applications. A SPL level monitor, utilizing a single Milltronics ultrasonic transducer (ordered separately), accurately monitors vessel material level without material contact.

The *SPL* transmits electronic pulses to the ultrasonic transducer. The transducer converts the electronic pulses to ultrasonic pulses which are emitted from the transducer face in a narrow beam. The SPL measures the time from the pulse emission, to receiving the reflection (echo) from the material. Using the time measured, the SPL calculates the distance from the transducer face to the material.

The distance calculation is dependent upon the sound velocity within the vessel. When a Milltronics ultrasonic/temperature transducer is used, variable air temperatures are automatically compensated. For superior air temperature compensation, a Milltronics TS-3 temperature sensor may be used. A simple calibration feature compensates for *homogeneous* (consistent composition) atmospheres other than air.

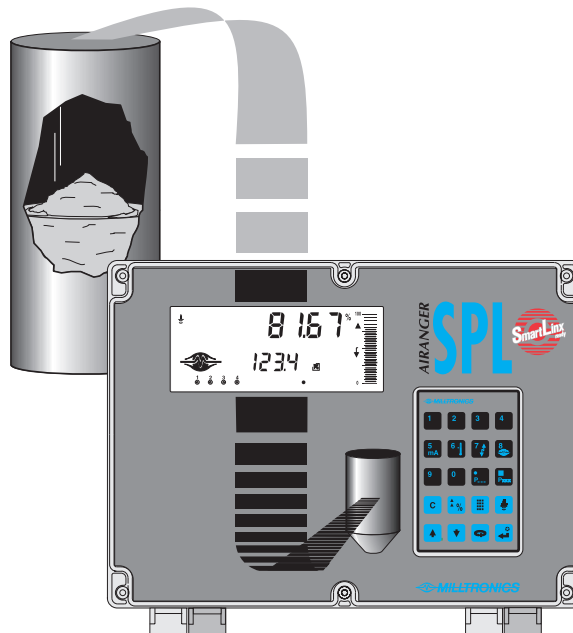

The SPL is capable of monitoring wheat in 60 m (200 ft) high silo's, acetone in 45 gallon barrels, or almost anything in between.

This material and measurement range versatility is accomplished by utilizing Milltronics patented Sonic Intelligence™. Sonic Intelligence provides high measurement reliability, regardless of changing conditions within the vessel monitored.

By utilizing ultrasonic echo ranging principles with Sonic Intelligence and velocity compensation, the SPL provides outstanding measurement accuracy, usually within 0.25% of range.

The distance calculation may be converted to space, material level, material volume, or remaining vessel capacity. The Reading chosen (and operating data) is displayed on the *Liquid Crystal Display* (LCD).

The relays and mA output may be used as preset (or programmed as desired) to activate alarms and/or operate remote monitoring equipment and/or process control equipment.

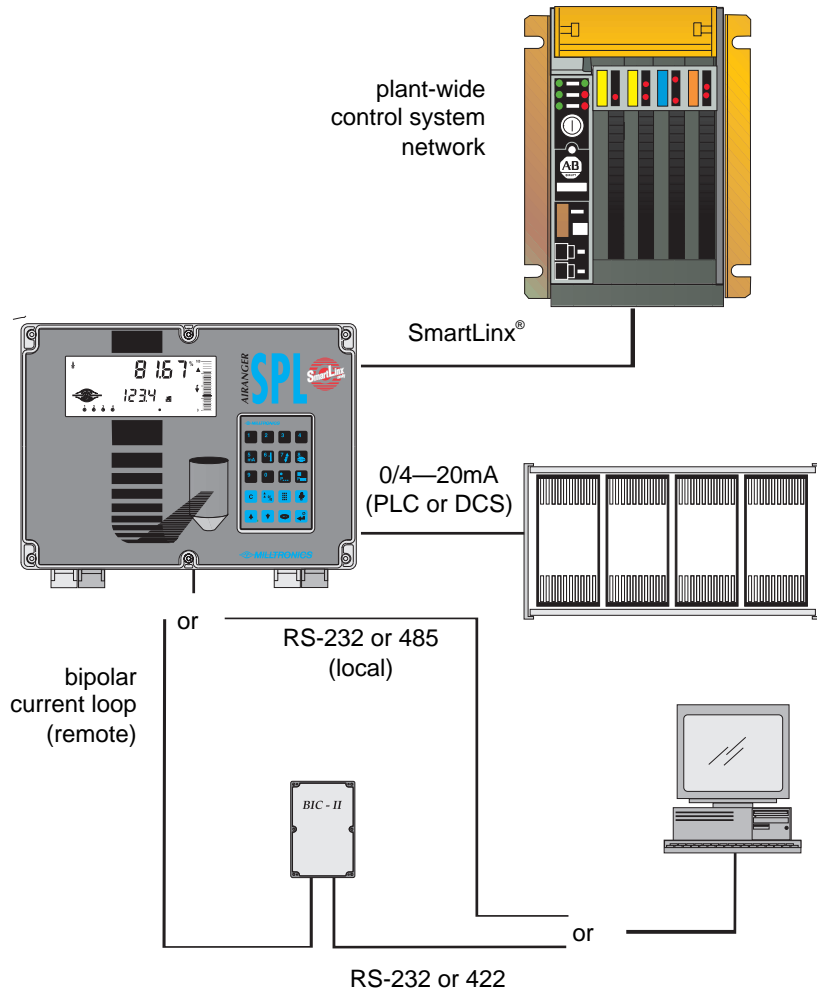

As well, the SPL may be connected to a Milltronics *BIC-II* (Buffered Interface Converter) to provide RS-232C and/or RS-422 communications for host computers, Distributed Control Systems, and *special* (capable of operating as a host device) Programmable Logic Controllers.

With the addition of a Milltronics Smartlinx[®] protocol specific 'plug-in' communications module, the SPL is compatible with popular industrial control system standards.

Programming can be done locally using the portable programmer keypad, or remotely through optional Dolphin Plus software or SmartLinx[®].

- The programmer transmits the keypad entries via infrared link to the SPL, and can be removed when not in use.
- Dolphin allows programming either through the portable ComVerter and infrared link or hardwired via the RS-232/485 communication port.
- SmartLinx[®] provides protocol specific hardware and software for interface with popular industrial communication systems.

While the SPL is typically used to monitor material level in open or closed vessels, any process which requires a distance measurement (within the system range) is a candidate for SPL application.

Refer to Technical Reference / Application Examples for detailed descriptions of a small sample of process measurement requirements to which the SPL may be applied.

Throughout this manual (unless stated otherwise) references to material level also apply to any material or object surface to be monitored by the SPL.

Important AiRanger SPL Features

Fixed Features

<i>Enclosure:</i>	Chemical resistant, light weight, dust tight, liquid tight, easy to work with.
<i>Backlit LCD:</i>	Large digits for Reading and programming value displays. Illuminated LCD insures readability under all lighting conditions. Custom Graphic Symbols for continuous indication of operating conditions.
<i>Programmer:</i>	20 tactile feedback keys for easy access to programming and operating functions. Magnetic mounting and infrared interface permit removal on programming completion.
<i>Communications:</i>	SmartLinx [®] Compatible Communications ready when equipped with an appropriate Milltronics SmartLinx module. Milltronics Peripherals The communication port provides connection for RS-232, RS-485 or Milltronics bipolar current loop. The current loop provides remote communication via Milltronics BIC II to the peripheral device. The BIC II converts the current loop to RS-232 or RS-422 signal Dolphin Compatible Communications Dolphin Plus is Milltronics' Windows95 [®] -compatible software. It offers local interface through the infrared ComVerter, or remote connection through the RS-232 or RS-485 port. The software provides an easy means for programming, uploading, or downloading parameters.
<i>Speed:</i>	Fast 16/32 bit microprocessor at 16.7 MHz clock speed. 1 vessel (point) per second scanning speed capability.
<i>Reliability:</i>	Surface Mount Technology (SMT), also provides for full features in a compact design. Sonic Intelligence [™] ensures all measurements are accurate and reliable. Immune to power interruptions. All programming is stored indefinitely. Dynamic operating data is retained for one hour and updated immediately on power resumption.

Programmable Features

Typically, a very small percentage of the programmable features require operator alteration. However, for demanding measurement requirements any operator programmable feature may be adjusted as desired.

Following is a list of some of the features that make the SPL easy to program, yet versatile enough to handle complex level measurement requirements.

General Features

<i>Direct Access:</i>	Any operator programmable feature may be accessed directly.
<i>Scroll Access:</i>	Single button "scroll forward", single button "scroll back", to key features.
<i>Operation:</i>	Select "level", "space", "distance", "difference", "average", or "tripper" operation.
<i>Material:</i>	Liquid or Solid; automatically adjusts echo processing with one entry.
<i>Response:</i>	Slow, medium, fast, surge, or immediate response to material level changes, one entry.
<i>Units:</i>	Display Readings in m, cm, mm, ft, in, %, or any other units desired.

Additional Features (use as desired)

<i>Volume:</i>	8 pre-programmed tank shape options. 2 universal tank shape programming methods
<i>Failsafe:</i>	Numerous failsafe options for process control equipment activation.
<i>Relays:</i>	8 functions including level, rate of change, pump control, temperature and more. Fixed or independent on/off setpoints
<i>mA Output:</i>	Based on level, space, distance, or volume 4 range selections, 0-20, 4-20, 20-0, or 20-4 mA Adjustable range and over-range limits

Installation

Note:

Installation shall only be performed by qualified personnel, and in accordance with local governing regulations.

The following procedure applies to all SPL level monitor installations. See Application Examples for additional installation requirements. Also, refer to the instruction manuals of all other equipment connected to the SPL for additional installation instructions.

AiRanger SPL

Location

Inspect all potential mounting locations. Choose a location suited to the SPL polycarbonate enclosure and the following location recommendations.

The ideal SPL mounting location:

- is conformant to the units specifications
- provides clearance to swing open the front cover and perform the required wiring connections
- provides access for viewing
- is vibration free

Avoid a location that is:

- exposed to continuous direct sunlight. (Otherwise, provide a sun shield.)
- close to high voltage or current runs, contactors, or SCR control drives

Cable/Conduit Entry Requirements

Determine the number of enclosure cable/conduit entries required for:

- Transducer
- TS-3 temperature sensor (if used)
- mA output (if used)
- Relays (if used)
- Synchronization (see Interconnection/Level System Synchronization)
- Power
- Communications: Smartlinx[®], RS-485, RS-232, bipolar.

Note:

Transducer cable must be run in a grounded metal conduit, separate from other wiring, (except TS-3 temperature sensor wiring, if applicable).

Mounting

Inspect all cartons and packaging for possible damage during shipment, before removing the SPL and associated equipment.

1. Loosen the 6 enclosure lid (captivated) screws and swing the lid open.
2. Remove the 4 Board B mounting screws (outer corners) and remove the circuit board assembly.
3. Drill sufficient holes in the enclosure bottom to meet enclosure cable/conduit entry requirements.
4. Attach the enclosure to the selected mounting surface. (4 predrilled screw holes provided.)
5. Attach the conduits/cable hubs to the enclosure. (Do not apply undue force.)
6. Reinstall the circuit board assembly.

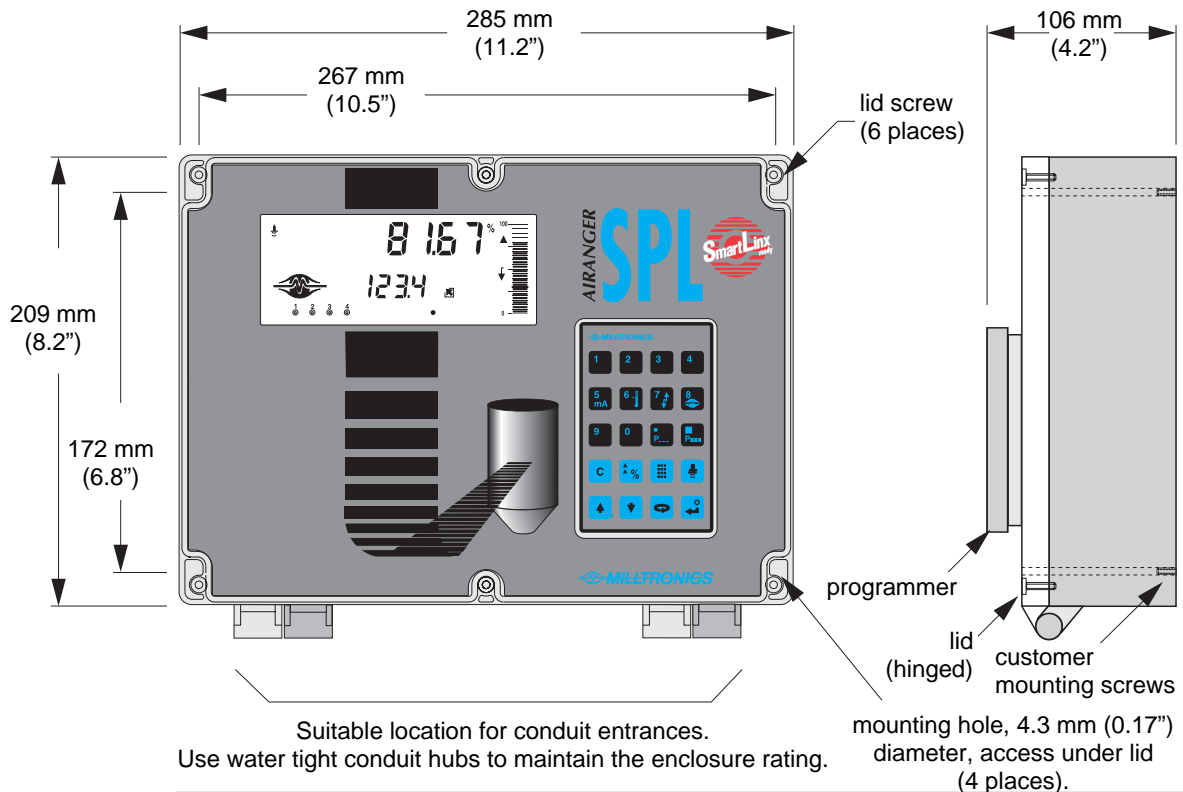

Warnings:

- **Non metallic enclosure does not provide grounding between connections. Use grounding type bushings and jumpers.**
- **This product is susceptible to electrostatic shock. Follow proper grounding procedures.**

Transducer Mounting

Objects near the transducer face cannot be reliably detected. Mount the transducer above the highest material level (away from the nearest monitored object) by the following *Nearest Distance*.

Nearest Distance	Transducer Types
0.45m (1.5ft)	XCT-8, XCT-12
0.3m(1 ft)	ST-H, ST-25, XRS-5, XKS-6, XPS-10, XPS-15, ST-50
0.6m (2 ft)	XPS-30, XPS-40
0.9m (3 ft)	ST-100, LR-21, XLT-30, XLS-30
1.2m.(4 ft)	LR-13
1.8m (6 ft)	XLT-60, XLS-60

Interconnection

Before interconnecting system components to the SPL terminals, verify all components have been installed in accordance with the associated product instruction manuals.

Connect all associated equipment cable shields to the SPL shield connections. To avoid differential ground potentials, do not connect cable shields to ground (earth) elsewhere. Insulate (tape) cable shields at all shield junctions to prevent ground loops.

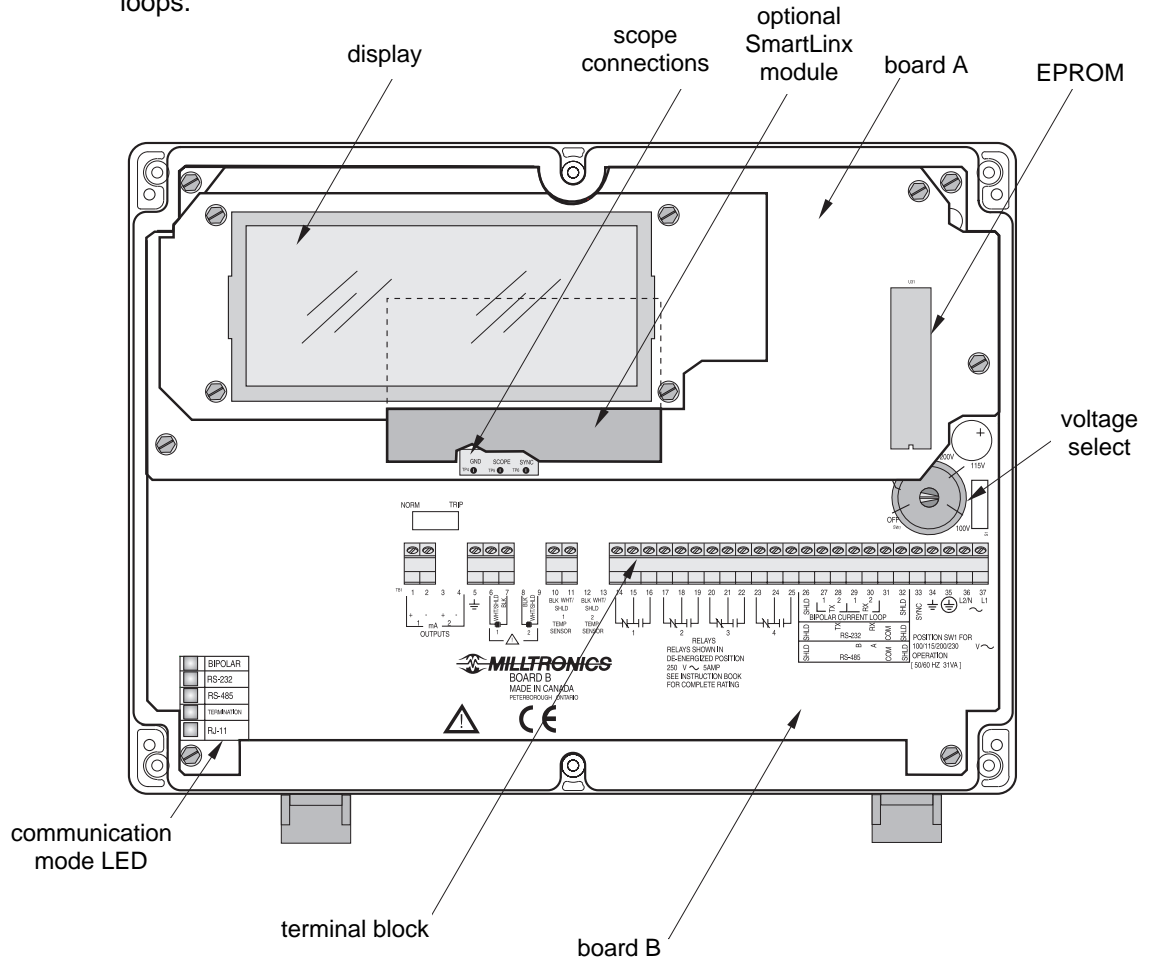

Installation



Warnings:

- All field wiring must have insulation suitable for at least 250V.
- Hazardous voltage present on transducer terminals during operation
- Relay contact terminals are for use with equipment having no accessible live parts and wiring having insulation suitable for at least 250V.

Optional Smartlinx® Module

The SPL is software/hardware ready to accept an optional Milltronics Smartlinx communications module that provides an interface to one of several popular industrial communications systems.

Your SPL may be shipped to you without a SmartLinx® module, for installation at a later date.

If you are ready to install you SmartLinx® module, or want to change it, follow the procedure as outlined on page 21.

System Diagram

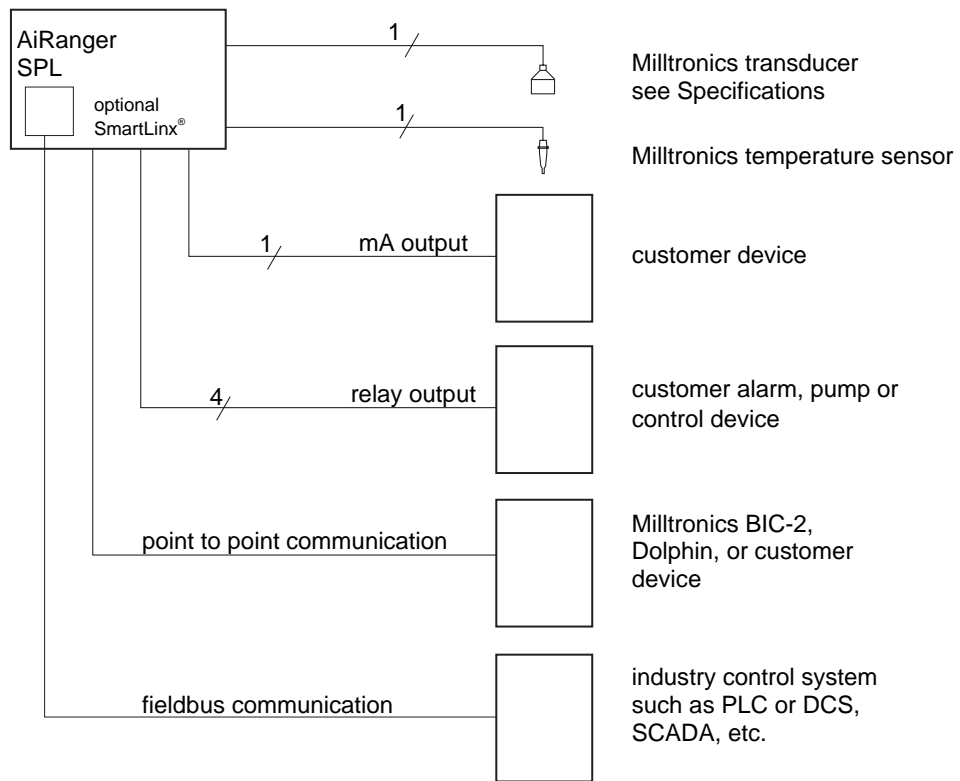

Note: Maximum system capability. Not all components or their maximum quantity may be required.

Transducer

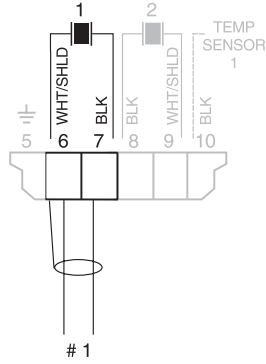

to transducer

Notes:

- Transducer cable must be run in a grounded metal conduit separate from other wiring (except TS-3 temperature sensor wiring, if applicable).
- **Hazardous voltage present on transducer terminals during operation.**

Temperature Sensor

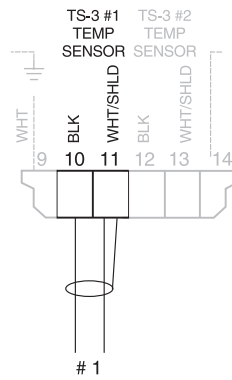

to TS-3

Note:

Use TS-3 temperature sensors only. Don't jumper the terminals if TS-3's are not used.

Relays

All relays are certified for use in equipment where the short circuit capacity of the circuits in which they are connected is limited by fuses having ratings not exceeding the rating of the relays.

Note:

Relays are shown in de-energized state.

See Specifications for ratings.

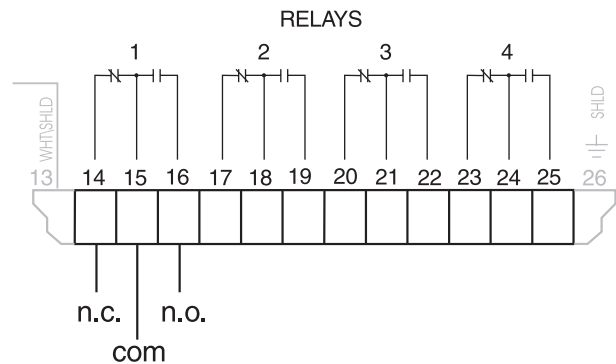

to customer's equipment

mA Output

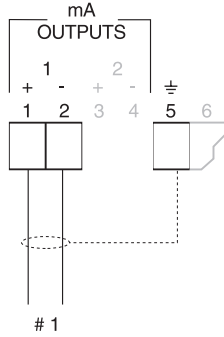

0/4-20mA isolated output to
750Ω max

Communication

Notes

- The communication protocol is automatically detected by the SPL and shown via LED on the motherboard.
- **Ground shield at one end only.**

Serial

RS-232

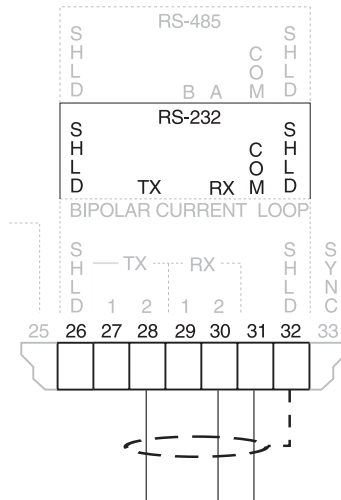

to customer device,
RS-232 port
15m (50 ft) max

RS-485

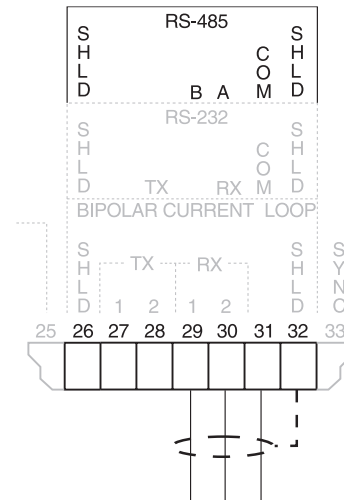

to customer device,
RS-485 port
1200m (4,000 ft) max

Bipolar Current

Connect the Milltronics BIC-II (if required) to the Peripheral Communications terminals as below.

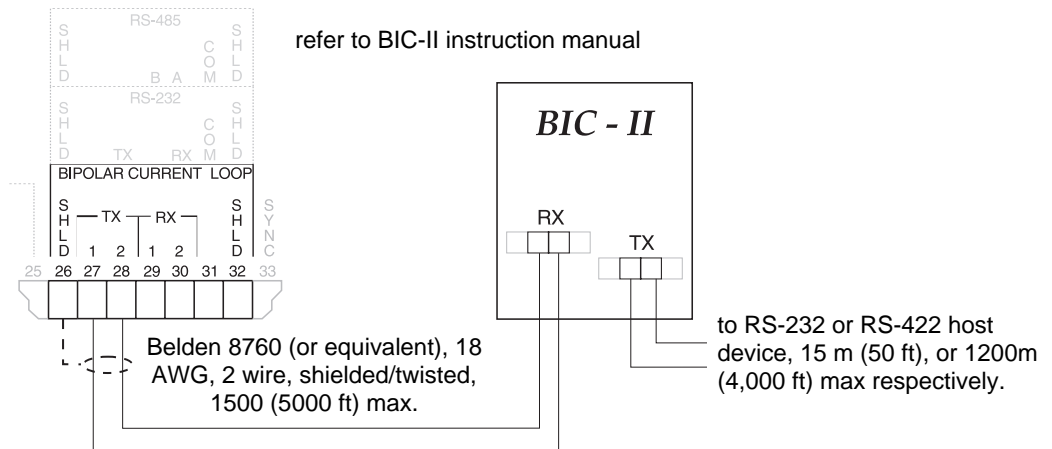

SmartLinx®

Refer to the appropriate SmartLinx® manual for installation and wiring.

Installation Procedure

With power off and SPL lid opened:

1. Remove the 4 LCD card screws and the card itself.
2. Remove the one dummy card screw and the card itself.
3. Mount the card by mating the connectors and secure the card in place using the two screws provided.

Note:

Refer to the Smartlinx® module documentation for any required hardware settings prior to replacing the LCD card or closing the SPL lid.

4. Replace the LCD card and secure in place using the screws removed in Step 1.

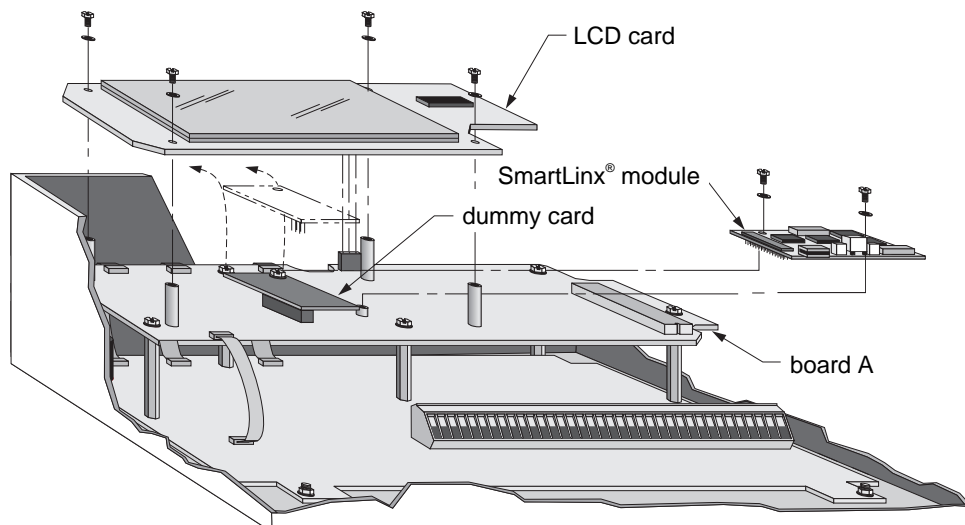

Level System Synchronization

Avoid mounting the SPL near another ultrasonic level monitor. Likewise, when more than one monitor is installed within a single plant/facility, ensure the transducer cables of each system are run in separate grounded metal conduits. If this system separation is impractical, or despite separation efforts measurement difficulties are encountered, system synchronization may be required.

To synchronize the SPL with another SPL...

1. Mount the level monitors together in one cabinet.
2. Ensure the level monitors share a common power (mains) supply, and ground (earth).
3. Interconnect the SYNC terminals of the level monitors to be synchronized.

Note:

To synchronize the SPL with other Milltronics ultrasonic level monitors, contact Milltronics or your local distributor.

Power

Note:

Before making the power connection, ensure proper voltage selection.

AC Supply Wiring

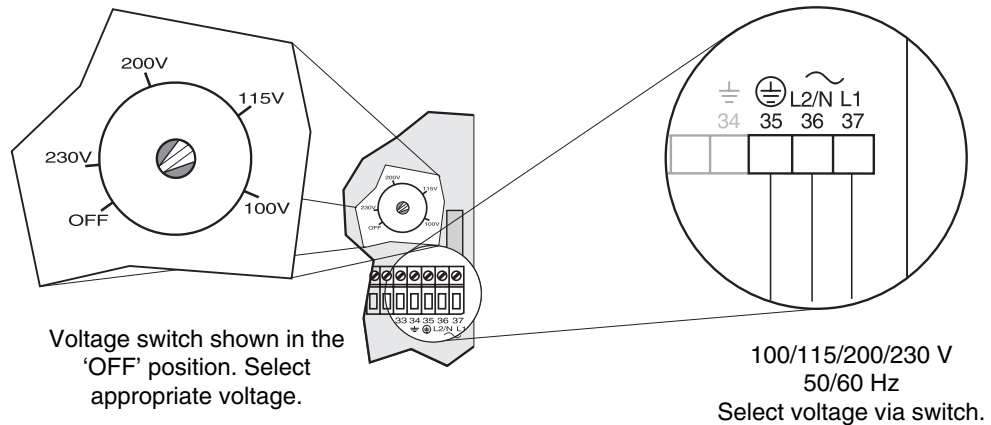

Notes:

- The equipment must be protected by a 15 A fuse or circuit breaker in the building installation.
- A circuit breaker or switch in the building installation, marked as the disconnect switch, shall be in close proximity to the equipment and within easy reach of the operator.
- Never operate the SPL with the enclosure lid open, or with the ground (earth) wire disconnected.
- Ensure that any associated alarm or control equipment is disconnected until satisfactory operation is verified.

Programmer

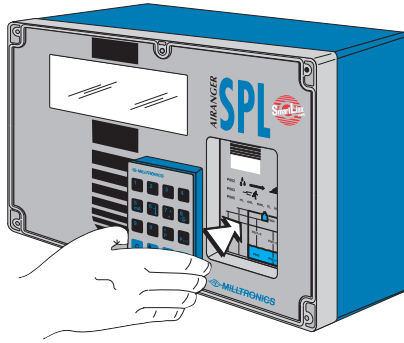

The hand programmer fits into the docking bay and is kept there by a magnet.

Use the hand programmer to change individual parameters.

Dolphin ComVerter

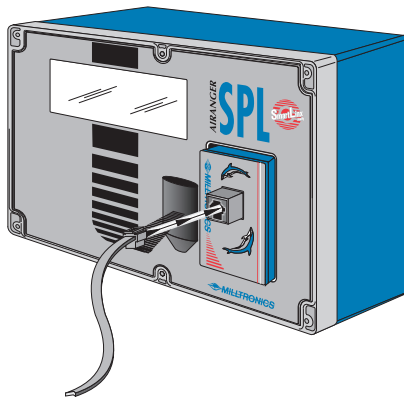

The ComVerter fits into the docking bay similarly to the hand programmer and provides communications with a PC running Dolphin Plus (available separately).

Programming

Operator programmable features are identified by a Point Number and Parameter Number. The Point Number refers to the Relay Number as identified by the Point Type indicators. Parameter Numbers have a preset Parameter Value for each Point Number.

Programming is accomplished by altering the preset Parameter Values as required to obtain the RUN mode operation desired. All operator programmable features are defined in the Quick Start Parameters, Application Parameters, and Enhancement Parameters sections of this instruction manual.

Display

In the program mode, the Point Type, Point Number, Parameter Number, and Parameter Value (as well as a variety of other programming information) may be viewed.

Note that many indicators are specific to certain programming conditions and therefore, all indicators are not displayed at any given time.

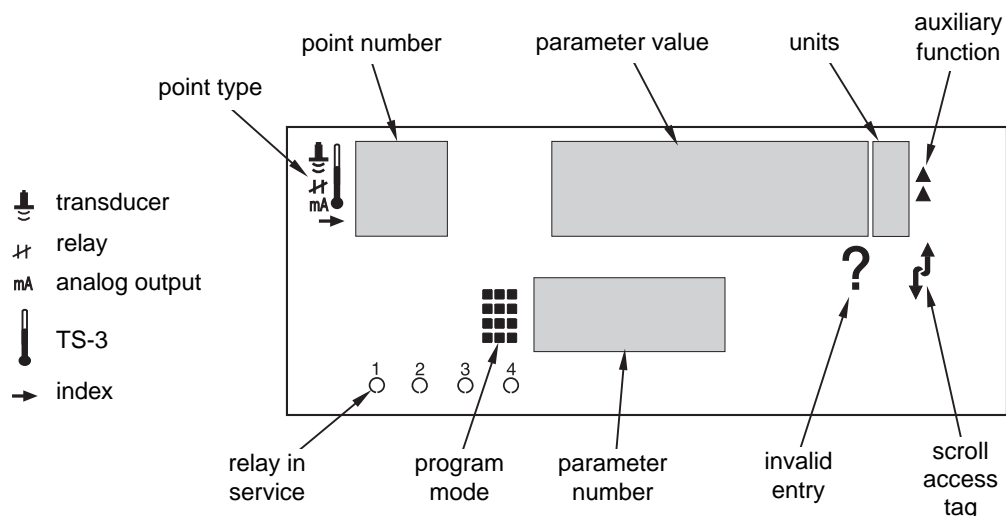

Display Segment	Description
Parameter Number	the programmable feature the Parameter Value pertains to.
Point Type	the Point Number refers to a Relay, mA Output, or TS-3.
Point Number	the Relay or Index number the Parameter Value pertains to.
Parameter Value	the current value of the Parameter Number for the Point Number displayed.
Percent	indicates the Parameter Value is displayed in percent.
Invalid Entry	indicates the value entered is questionable (are you sure?).
Auxiliary Function	indicates Auxiliary Function access (applies to only some Parameter Numbers).
Scroll Access Tag	indicates the Parameter Value may be scroll accessed.
Program Mode	indicates the program mode is accessed.

Keypad

In the program mode, use the SPL programmer keys to perform the identified functions.

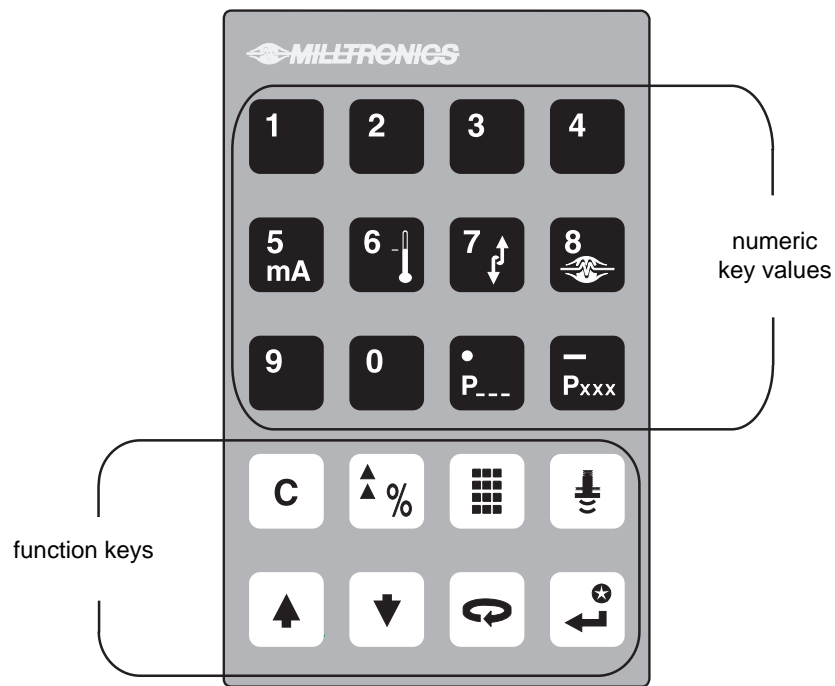



Key	Description
	shift access to Point Number, Parameter Number, or Parameter Value display.
	input the numeric value into the accessed display.
	input a Parameter Value decimal point (moves Profile and TVT Pointers left).
	input a negative Parameter Value (moves Profile and TVT Pointers right).
	delete the current Parameter Value display (initiate a parameter reset).
	store the current Parameter Value in memory (complete a parameter reset).
	switch the Parameter Value to % or Units (access Auxiliary Parameter Function).
	increase the accessed display value.
	decrease the accessed display value.
	take an ultrasonic measurement.
	enter the RUN mode.

Program Mode Entry

Upon initial power application, the SPL displays "OFF".



To enter the program mode...

1. Ensure the enclosure lid is secured by the 6 captivated screws.
2. Place the infrared programmer in the enclosure lid recess (no wiring or fastening required).
3. Press  



When the program mode is entered after RUN mode operation, all operating data is retained in memory. Relay status and mA output values are "held" at "last known" values (unless affected by a parameter alteration or  is pressed) until the RUN mode is re-entered. The RUN mode is automatically re-entered if the SPL is left unattended in the program mode for an extended period.

Parameter Value Alteration

In the program mode...

1. Press  as required to underline the Parameter Number display field and...
 - a. Key in the desired Parameter Number, (**direct access**) or...
 - b. Press  or  as required (**scroll access**).

(As preset, Quick Start Parameters, and previously altered parameters may be scroll accessed).

2. Press  as required to underline the Point Number display field and...
 - a. Key in the desired Point Number, (**direct access**) or...
 - b. Press  or  as required (**scroll access**).

To alter the Parameter Value for all Point Numbers at once, select Point Number 00.



3. With the desired Parameter Number and Point Number displayed...
Key in the desired Parameter Value and press .

Notes:

- Record each Parameter Value alteration on the appropriate Programming Chart for future reference, (especially should complete reprogramming be required).
- If Parameter Value alteration is not permitted, access the Lock parameter (P000) and enter the security code (See Programming Security).

Parameter Reset Features

On initial power up, all parameters are at "original" values. In many cases, when a Parameter Value is altered, associated Parameter Values are automatically altered accordingly. When a Parameter Number is accessed, if the preset Parameter Value displayed is acceptable, no entry is required.

To return an operator adjusted Parameter Value to the preset value, with the appropriate Point Number and Parameter Number displayed press , .

To reset all parameters to preset values, refer to Master Reset (P999).

Note:

Perform a Master Reset (P999) if the SPL was "bench tested" using arbitrary Parameter Values before system installation, following an EPROM replacement, or whenever complete reprogramming is required.

Special Parameters

Some Parameter Values are for display purposes only and cannot be operator altered. These are referred to as *view only* parameters. In the parameters sections of this instruction manual, View Only parameters are identified by a "(V)" beside the Parameter Number.

Some Parameter Values must be common for all Point Numbers. These are referred to as *global* parameters. When a global parameter is accessed, the Point Number display automatically switches to Point Number 00, and returns to the Point Number previously selected when a non-global parameter is accessed. In the parameters sections of this manual, Global parameters are identified by a "(G)" beside the Parameter Number.

Programming Security

All operator programming is retained in non-volatile memory, immune to power interruptions. When programming is complete, the programmer may be removed and locked away to prevent inadvertent programming alteration. As well the Lock (P000) parameter may be used.



Security Parameter

P000 (G) Lock

Use this feature (if desired) to secure all programming from inadvertent alteration.

Direct access (cannot be scroll accessed) this parameter after all programming is complete and enter any value (other than 1954) to activate the programming Lock.

When Lock is activated, the SPL may be switched from the RUN mode to the program mode and the value of any parameter may be viewed but not altered. To unLock, direct access this parameter and enter the value "1954".

This parameter cannot be reset by pressing , .

Values:

- 1954 = off (Parameter Value alteration permitted)
- 1 = control relays active during simulation
- other = activated (programming secured)

Quick Start Parameters

Alter the Quick Start Parameters as required to suit installation requirements.

Note:

If the Quick Start Guide (PL-431) was used, proceed to Application Parameters

Refer to Technical Reference Application Examples for assistance, if required.

P001 Operation

Enter the type of RUN mode operation desired.

Select:

"level", display Empty (P006) to material level distance .
"space", display Span (P007) to material level distance.
"distance", display transducer face to material level distance.
"out-of-service"the transducer is not fired, alarm relay(s) energize, pump relay(s) de-
energize, and mA output(s) go to the Empty vessel value.

Values:

0 = out-of-service
1 = level
2 = space
3 = distance (preset)

P002 Material

Enter the type of material to be monitored.

If the material presents a flat surface perpendicular to the transducer beam, select liquid.

Values:

1 = liquid or flat surface (preset)
2 = solid

P003 Measurement Response

Enter how quickly the SPL is to respond to changing measurements.

Note:

Slower Measurement Response improves stability and reliability.

Values:

1 = slow (0.1 m / min)
2 = medium (1 m / min) (preset)
3 = fast (10 m / min)
4 = surge (1.7 m / sec)
5 = immediate (17 m / sec)

P004 Transducer

Enter the type of transducer connected to the SPL.

Values:

0 = not entered	100 = ST-H	106 = XPS-40
1 = ST-25	101 = XCT-8	107 = XLT-30
2 = ST-50	102 = XPS-10	108 = XLT-60
3 = ST-100	103 = XCT-12	109 = XLS-30
4 = LR-21	104 = XPS-15	110 = XLS-60
5 = LR-13	105 = XPS-30	111 = XKS-6
		112 = XRS-5

P005 (G) Units

Enter the units of measure desired for programming Empty (P006) and Span (P007).

Values:

- 1 = metres (m) (preset)
- 2 = centimetres (cm)
- 3 = millimetres (mm)
- 4 = feet (ft)
- 5 = inches (in)

P006 Empty

Enter the maximum distance (transducer face to vessel bottom) to be measured, in Units.

This value is preset to 5.000 m (or equivalent Units programmed).

The value entered automatically sets Span (P007) to the maximum recommended value.

Values:

0.000 to 9999

P007 Span

Enter the maximum surface distance from Empty (P006).

Span is automatically preset to 1.1 x the blanking value (P800) less than the Empty value (P006), unless it is altered manually.

For "distance" Operation (P001 = 3), Span is preset to the Empty value (P006).

Enter a lower value if desired. If the automatic setting is not high enough, mount the transducer higher (see Installation Transducer Mounting) and enter the new Empty (P006) distance.

Values:

0.000 to 9999

Note:

With the Quick Start Parameters altered as required, proceed to Operation to identify / verify basic system performance.

Operation

With Quick Start parameter alteration complete, the SPL may be put into operation. (If Application or Enhancement Parameters are altered, Operation is altered accordingly from that indicated).

Display

In the RUN mode, the following values and indicators may be observed.

Note that many indicators are specific to certain operating conditions and therefore, all indicators are not displayed at any given time.

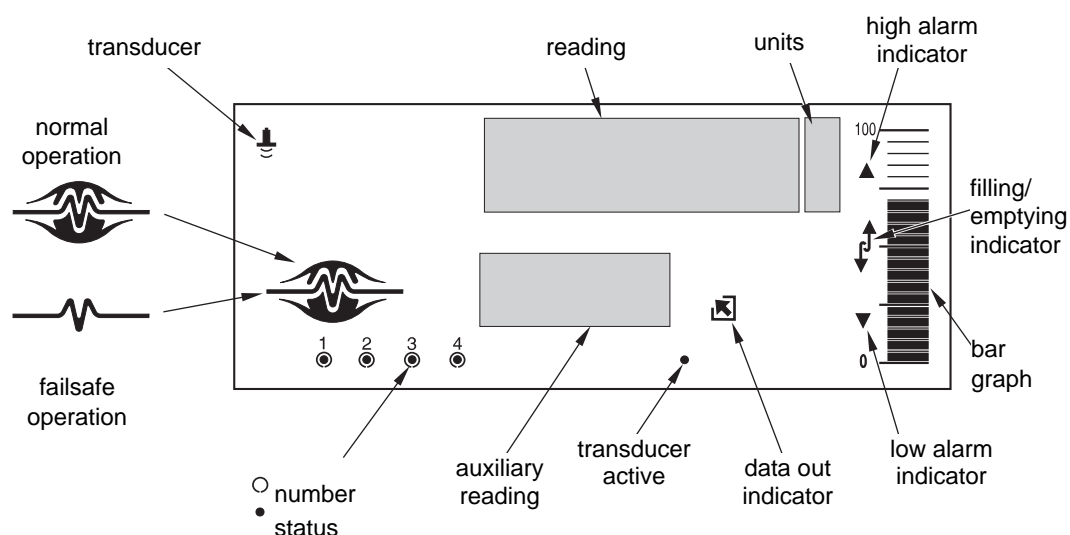

Display Segment	Description
Transducer	the current display pertains to a transducer measurement.
Reading	displays the level, space, or distance (flashes error messages, if any).
Percent	the Reading is in percent.
High Alarm	indicates level has risen above 80% (and not yet fallen below 75%).
Low Alarm	indicates level has fallen below 20% (and not yet risen above 25%).
Filling Indicator	indicates the vessel is filling.
Emptying Indicator	indicates the vessel is emptying.
Bar Graph	indicates the <i>absolute</i> (always a positive value) material level from 0 to 100%.
Data Out	indicates the SPL is transmitting data to the Peripheral Communications terminals.
Transducer Active	indicate the Point Number scanned (independent from the Point Number display).
Auxiliary Reading	as selected by the keypad (terminal numbers if transducer or TS-3 is wired wrong).
Relay Number	indicates the relays programmed for operation.
Relay Status	indicates the relay is de-energized (alarm is activated).
Normal Operation	indicates operating conditions are good and the Reading is reliable.
Failsafe Operation	indicates operating conditions are poor and the Reading may be incorrect.

Keypad

In the RUN mode, the following programmer keys perform the identified functions.

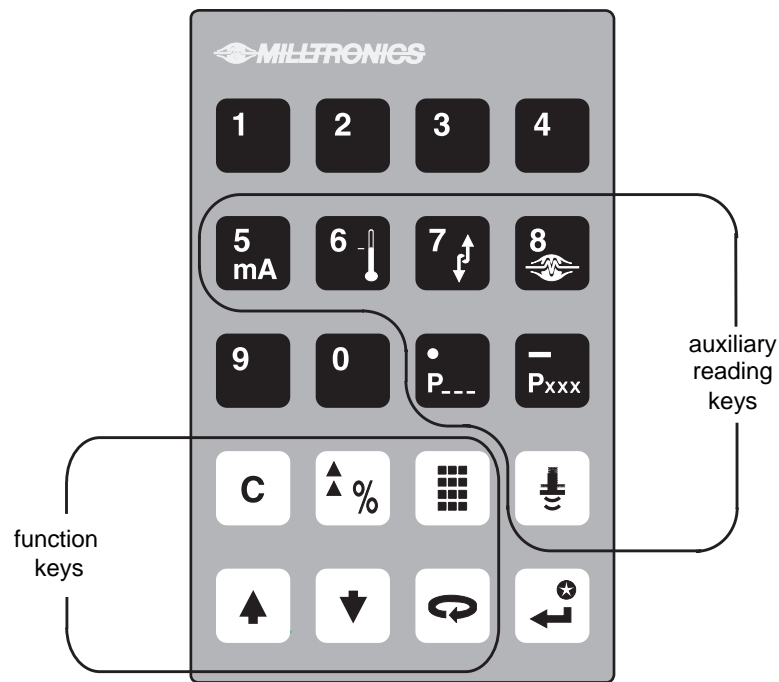

Key	Description
	selects the Auxiliary Reading "mA output value".
	selects the Auxiliary Reading "vessel atmosphere temperature".
	selects the Auxiliary Reading "rate of material level change".
	selects the Auxiliary Reading "failsafe time left" (in percent).
	selects the Auxiliary Reading "parameter value" (Key in any Parameter Number).
	selects the Auxiliary Reading "material level" (may be operator altered via P731).
	selects the Auxiliary Reading "distance" (material level to transducer face).
	initiates program mode access (see).
	switches the Reading between "Units/percent of Span" (completes program mode access).
	stops/starts the Point Number auto display scroll.

System Performance Evaluation

For initial RUN mode entry (or after any programming alteration), do not use the SPL to operate process control equipment until satisfactory system programming and performance is verified.

1. Press  to enter the RUN mode...

"----" may be displayed briefly while the SPL takes measurements and calculates the Reading.

If an alarm symbol is displayed, the corresponding relay is de-energized.

Point #	Alarm Indicator	Relay #
1	High Alarm	1
1	Low Alarm	2

2. Press  to display Readings in % (percent of Span, P007) based upon Operation (P001).

Operation	Level	Space, Distance*
Empty to Full =	0 to 100%	100 to 0%

* Objects close to the transducer face (0%) are not detectable.

3. Press  to observe the mA output value for the Point Number displayed (Auxiliary Reading).

Operation	Level	Space, Distance*
Empty to Full =	4-20 mA	20-4 mA

* Objects close to the transducer face (4 mA) are not detectable.

4. Press  to observe the *Failsafe Time Left* (time left in percent before failsafe activation).

Each time a valid measurement is made, this value (Auxiliary Reading) is reset to 100 and begins to fall toward 0 until the next valid measurement is made.

If the Failsafe Time Left reaches 0, the SPL flashes "LOE" in the Reading display.

All associated data is supplied to the Peripheral Communications terminals (27 and 28). If a BIC-II is connected, refer to Technical Reference BIC-II Support for message format and protocol information.

Performance Test Results

Monitor system performance carefully, under all anticipated operating conditions.

- A. If the SPL performs exactly as required, copy all Parameter Value alterations to the Programming Charts in the back of this instruction manual. (Altered Parameter Values may be scroll accessed). No further action is required. The SPL will continue performing reliably, with little or no maintenance.
- B. If a measurement difficulty is encountered (the "LOE" display persists after start up), or performance does not meet installation requirements, proceed to the Troubleshooting Guide
- C. If the SPL provides accurate and repeatable measurements, however alternate Reading units, failsafe action, relay, or mA output operation is desired, proceed to Application Parameters

If all operating conditions cannot be observed during the System Performance Evaluation, refer to Enhancement Parameters Reading Measurement (P920). Perform a Reading Measurement simulation to verify programming.

Ensure the Programming Charts are altered accordingly, and a new System Performance Evaluation is conducted, following any operation alteration or measurement difficulty remedy.

Note:

Connect (or enable) process control / alarm equipment to the SPL only after satisfactory performance is verified for all possible operating conditions.

Application Parameters

This section identifies the SPL operator programmable features which may be used to modify the SPL display, failsafe, relay, and/or mA output operation.

Volume Parameters (P050 to P055)

If Readings proportional to volume are desired, adjust the following parameters.

Note:

If Volume Conversion is not required, proceed to Reading Parameters.

P050 Tank Shape

Enter the Tank Shape option that matches the vessel monitored.

If the Tank Shape option selected, requires additional vessel dimension entry, the associated parameters (as indicated below) may be scroll accessed.

When Operation is "level" (P001 = 1), material volume is calculated. Alternatively, when Operation is "space" (P001 = 2), remaining vessel capacity is calculated.

In the RUN mode, Readings are displayed in percent of (and mA outputs are proportional to) maximum volume. To convert Readings to volumetric units, see Max Volume (P051).

Values:

0 = volume calculation not required (preset)

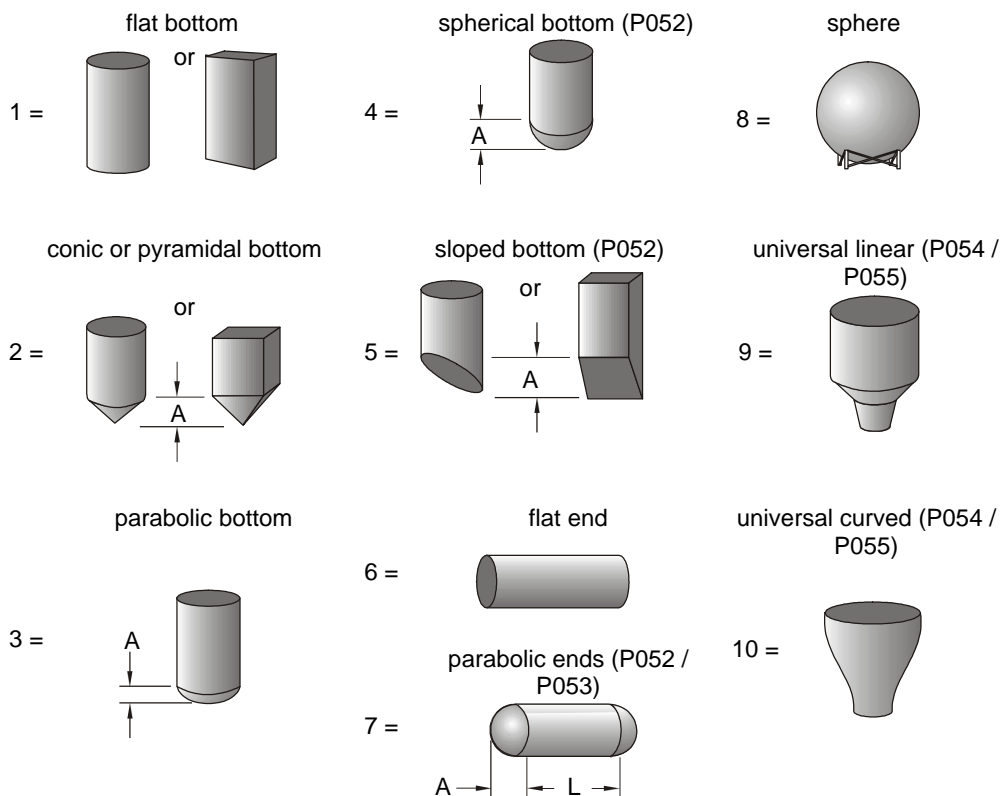

P051 Max Volume

Use this feature to display the Reading in volumetric units rather than percent.

Enter the vessel volume between Empty (P006) and Span (P007).

e.g. 1 If the volume = 3650 m³, enter 3650.

e.g. 2 If the volume = 267,500 US gallons, enter 267.5 (1000's of gallons).

Values:

0.000 to 9999

P052 Tank Dimension A

Enter the height of the tank bottom if P050 = 2,3,4, or 5, or the length of one end section of the tank if P050 = 7, in Units (P005).

Values:

0.000 to 9999

P053 Tank Dimension L

Enter the length of the tank (excluding both end sections) if P050 = 7, in Units (P005).

Values:

0.000 to 9999

P054 Level Breakpoints (Universal Volume Calculation)

Enter level breakpoints (where volume is known) if P050 = 9 or 10.*

Values:

0.000 to 9999







P055 Breakpoint Volumes (Universal Volume Calculation)

Enter the volume corresponding to each Level Breakpoint entered.*

Values:

0.000 to 9999

* To enter a Level Breakpoint or Breakpoint Volume...

1. Press   to display the index symbol, 
2. Scroll ( or ) or direct access the desired Breakpoint.
3. Key in the desired level or volume value.
4. Press .

Note:
Refer to Technical Reference Volume Calculation for breakpoint value selection.

Reading Parameters (P060 to P062)

If Reading alteration is required, alter the following parameters to:

- alter the number of decimal places displayed.
- convert to units other than Units (P005), % of Span (P007), or Max Volume (P051).
- reference measurements to some point other than Empty (P006) or Span (P007).

Note:

If alteration is not required, proceed to Failsafe Parameters.

P060 Decimal Position

Enter the maximum number of decimal places to be displayed in the Reading.

In the RUN mode, the number of decimal places displayed is automatically adjusted (if necessary) to prevent the number of Reading digits from exceeding display capabilities.

This value is automatically altered when Units (P005) or Max Volume (P051) are altered.

Values:

0 = no digits after the decimal point

1 = 1 digit after the decimal point

2 = 2 digits after the decimal point

3 = 3 digits after the decimal point

P061 Convert Reading

Enter the value to multiply the Reading by, (before display).

This feature is preset to 1.000 (no conversion).

e.g. If the Reading is currently displayed in feet, to display in yards, enter 3.

Note:

Avoid entering a value that, when multiplied by the maximum current Reading, could exceed 5 digits before the Decimal Position.

Values:

-999 to 9999

P062

Offset Reading

Enter the value to be added to the Reading, (before display).

This feature is preset to 0.000, (no offset).

e.g. To reference a material level to sea level, enter the distance in Units (P005), between Empty (P006) and sea level. (Enter a negative value if Empty is below sea level.)

This feature affects the SPL (and BIC-II, if used) Reading only. (Relays and mA output are not affected).

Values:

-999 to 9999

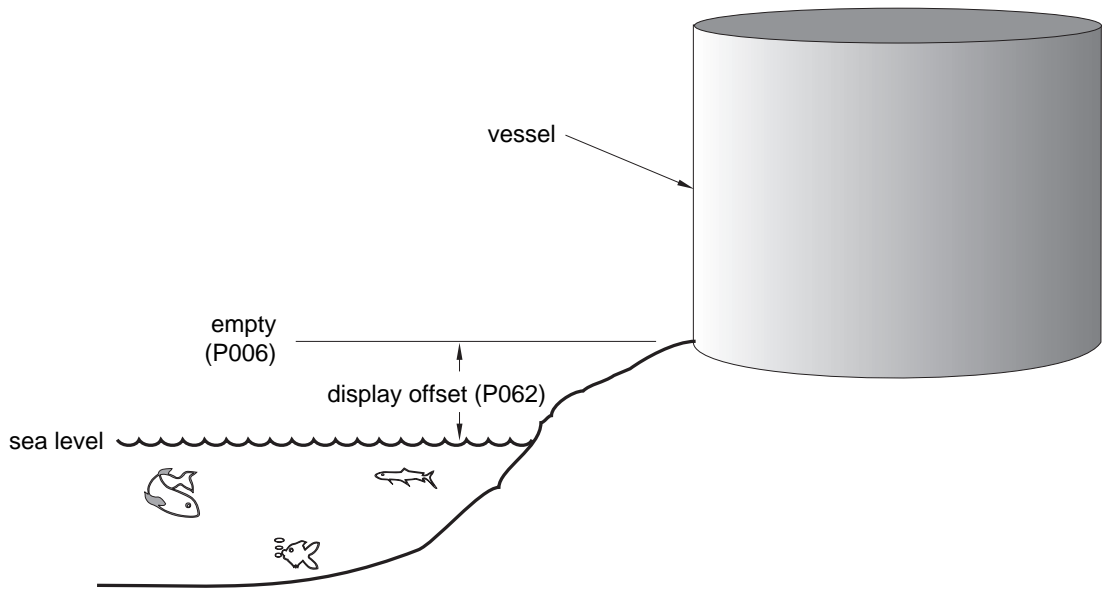

Failsafe Parameters (P070 to P072)

As preset, in the event of a measurement or technical difficulty, the SPL holds the Reading, Bar Graph, mA output, and relays at their last "known" values.

To operate process control equipment under these conditions, alter the following parameters as required.

Note:
If alternate Failsafe Operation is not required, proceed to Relay Parameters.

P070 Failsafe Timer

Enter the time to elapse (in minutes), upon a difficulty, before failsafe operation is activated.

In the RUN mode, when a difficulty first occurs, the Reading, Bar Graph, relay status, and mA output are held at "last known" values and the Failsafe Timer is activated.

When a valid measurement is made before the timer expires, the SPL advances to the "new" material level (if changed) as *normal* (per Measurement Response, P003) and the timer resets.

If the timer expires (before a valid measurement is made), the SPL advances to the Failsafe Material Level (P071) as restricted by Failsafe Advance (P072).

When a valid measurement is made after the timer expires, the SPL advances to the "new" material level (if changed), as restricted by Failsafe Advance (P072) and the timer resets.

If the timer expires due to a measurement difficulty, "LOE" flashes in the Reading display.

Technical difficulty messages flash in the Reading display before the timer expires. The offending terminal connections are displayed in the Auxiliary Reading display.

Display	Cause
"LOE"	weak echo (see Troubleshooting Guide).
"Short"	short circuited transducer cable, or defective transducer
"OPEn"	open circuited transducer cable, or Point Number is scanned but a transducer is not connected, or defective transducer
"Error"	reversed Ultrasonic/Temperature transducer terminal connections or wrong Transducer (P004) entered.

Note:
While a short duration Failsafe Timer value may be required (when process control equipment is used) avoid entering a value so short as to cause nuisance activation.

This feature is automatically altered when Measurement Response (P003) is altered.

Values:
0.000 to 9999

P071 Failsafe Material Level

Select the material level to be reported when the Failsafe Timer expires.

If "HOLd" (preset) is selected, in the RUN mode, the "last known" material level is held.





If "High" or "Low" are selected, the SPL advances to the Span (P007) level or Empty (P006) level as restricted by Failsafe Level Advance.

Select the Failsafe Material Level based upon the relay and/or mA output operation required during failsafe operation.

e.g. 1 To de-energize a high alarm relay (perhaps to stop material infeed), select "High".

e.g. 2 To force an "empty vessel" mA output (perhaps to have pumps stopped), select "Low".

To select High, Low, or HOLd...

1. Press  to display the Auxiliary Function symbol.
2. Press  or  as required to scroll access the desired option.
3. Press .

Alternatively, a specific Failsafe Material Level within -50 to 150% of Span (P007) may be entered directly in Units (P005), or % of Span (P007).

Values:

-999 to 9999

P072 Failsafe Level Advance

Select the restriction applied to the SPL advance to (and from) the Failsafe Material Level.

When "restricted" (preset), the SPL advances to the Failsafe Material Level (and to the "new" material level when a valid measurement is made) as determined by the Measurement Response (P003) or the Max Fill/Empty Rate (P700/P701) values entered.

Alternatively, when "immediate" is selected, the Failsafe Material Level (or "new" material level) is assumed immediately.

Otherwise, when "fast back" is selected, the Failsafe Level Advance is restricted, however the advance to the new material level (when a valid measurement is made) is immediate.

Values:

- 1 = restricted
- 2 = immediate
- 3 = fast back

Relay Parameters (P100 to P104, P110 to P113, P129)

If relays are to be used, alter the following parameters as required.

Note:

Otherwise, proceed to mA Output Parameters.

Relays may be programmed as Standard Alarms or for Custom Relay operation.

For *Standard Alarms* (relays operate based on material level), select the Relay Set Up (P100) desired and alter the Standard Alarm (P101 to P104) parameters as required, before proceeding to Relay Failsafe (P129).

For Custom Relay operation, select the Relay Set Up (P100) which most closely matches your requirements, and alter the Custom Relay Parameters (P110 to P113) as required, before proceeding to Relay Failsafe.

P100 (G) Relay Set Up

This parameter presets relays to operate as Standard Alarms. The *Relay Allocation* (relay / point number association) and Standard Alarm (P101 to P104) parameters are also preset.

Relay status during a measurement difficulty is dependent upon Failsafe programming. See Failsafe Parameters (P070 to P072) and Relay Failsafe (P129). As preset, relay status is "held" at "last known" material levels until a valid measurement is made.

Option	Relay #	Point #	Standard Alarm (as % of Span, P007)
1	1	1	(High Alarm) P101 = 80.00%
	2	1	(Low Alarm) P102 = 20.00%
	3		not programmed
	4		not programmed
2	1	1	(High Alarm) P101 = 80.00%
	2	1	(High High Alarm) P103 = 90.00%
	3		not programmed
	4		not programmed
3	1	1	(Low Alarm) P102 = 20.00%
	2	1	(Low Low Alarm) P104 = 10.00%
	3		not programmed
	4		not programmed
4	1	1	(High Alarm) P101 = 80.00%
	2	1	(Low Alarm) P102 = 20.00%
	3	1	(High High Alarm) P103 = 90.00%
	4	1	(Low Low Alarm) P104 = 10.00%

Independently altered Standard Alarms (P101 to P104), Relay Allocation (P110), Relay Function (P111) and Relay A/B Setpoints (P112/P113) are automatically reset when a Relay Set Up value is altered.

Values:

- 1 = Set Up 1
- 2 = Set Up 2
- 3 = Set Up 3
- 4 = Set Up 4

Standard Alarms (P101 to P104)

In the RUN mode, when the material level...

- rises to a High or High High Alarm value, the associated Alarm and Relay Status indicators are displayed and the allocated relay(s) de-energize.
- falls 5% of Span (P007) below the High or High High Alarm value, the associated Alarm and Relay Status indicators extinguish, and the allocated relay(s) energize.
- falls below the Low or Low Low Alarm value, the associated Alarm and Relay Status indicators are displayed and the allocated relay(s) de-energize.
- rises 5% of Span (P007) above the Low and Low Low Alarm value, the associated Alarm and Relay Status indicators extinguish, and the allocated relay(s) energize.

Note:

Enter all Standard Alarm material level values in Units (P005) or percent of Span (P007) as referenced to Empty (P006).

To display the current value (or enter a new value) in percent of Span,

Press  as required to display the % symbol.

P101 High Alarm

Enter the High Alarm material level for the Point Number displayed.

Values:

-999 to 9999 (preset to 80.00% of Span or equivalent Units)

P102 Low Alarm

Enter the Low Alarm material level for the Point Number displayed.

Values:

-999 to 9999 (preset to 20.00% of Span or equivalent Units)

P103 High High Alarm

Enter the High High Alarm material level for the Point Number displayed, (Relay Set Up 2 or 4 only).

Values:

-999 to 9999 (preset to 90.00% of Span or equivalent Units)

P104 Low Low Alarm

Enter the Low Low Alarm material level for the Point Number displayed, (Relay Set Up 3 or 4 only).

Values:

-999 to 9999 (preset to 10.00% of Span or equivalent Units)

- Notes:**
- "OFF" is displayed if the Relay Set Up (P100) selected does not use the Alarm parameter accessed.
 - "Ch" is displayed if a Custom Relay Parameter was previously operator altered.

Use Relay A/B Setpoints (P112/P113) instead.

If Custom Relay operation is not required, proceed to Relay Failsafe (P129).

Custom Relays (P111 to P113)

P111 Relay Function





Use this feature if alternate relay function, designation, or operation is required.

When accessed, the Parameter Type display changes to the Relay symbol and the Point Number display changes to the Relay Number (corresponding to the SPL terminals).

Function	Designation	Operation
Level	LL, L, H, or HH	Similar to Standard Alarms but with Relay A/B Setpoints
In Bounds	b1 or b2 *	Alarms when level is between the Relay A/B Setpoints
Out of Bounds	b1 or b2 *	Alarms when level is not between the Relay A/B Setpoints
Rate	r1 or r2 *	Level rate of change alarm with Relay A/B Setpoints
Temperature	Not applicable	Alarm is activated by independent Relay A/B Setpoints
LOE	Not applicable	Relay de-energizes in the event of Failsafe timer (P700) expiry
Cable fault	Not applicable	Relay de-energizes under transducer short or opened condition
Pump	Not applicable	With independent Relay A/B Setpoints

* The Relay Designation is not displayed but is included in the BIC-II (if used) data message.

To enter a Relay Designation...

1. Press  to display the Auxiliary Function symbol,
2. Press  or  to scroll access the desired relay designation and...
3. Press .

Note:

When the Relay Function is altered, affected Alarm Parameters (P101 to P104) display "ch" (changed) when accessed. Use the Relay A/B Setpoints (P112/P113) instead.

To reset the Relay Function to use Standard Alarms, enter the desired Relay Set Up (P100).

Values:

- 0 = off (relay always de-energized)
- 1 = level alarm (preset)
- 2 = in bounds alarm (not applicable to Point 3 differential level)
- 3 = out of bounds alarm (not applicable to Point 3 differential level)
- 4 = rate of change alarm
- 5 = temperature alarm
- 6 = LOE alarm
- 7 = transducer cable fault alarm
- 50 = pump control (non-sequenced)

Independent Relay Setpoints

Relay A and B Setpoint values set the critical points (based on the Relay Function) where, in the Run mode ...

- Relay status indicators are switched "ON" and "OFF"
- Alarm Indicators (if programmed) are switched "ON" or "OFF"
- Relays are "energized" and "de-energized"

For most Relay Functions, setpoint values represent material levels, entered in Units (P005) or percent of Span (P007) as referenced to Empty (P-006). Temperature alarm values are entered in degrees Celsius (°C).

Rate alarms are entered in Units / minute or percent of Span per minute. A positive value is entered for a filling rate alarm; negative for emptying.

	Setpoints		Action			When
	A	B	Status	Alarm	Relay	
Level H or HH	85%	70%	On	On	de-energizes	Level rises to 85%
			Off	Off	energizes	Level falls to 70%
Level L or LL	15%	30%	On	On	de-energizes	Level falls to 15%
			Off	Off	energizes	Level rises to 30%
In bounds ▲	80%	50%	On	On	de-energizes	Level falls to 78%
			Off	Off	energizes	Level rises to 82%
			On	On	de-energizes	Level rises to 52%
			Off	Off	energizes	Level falls to 48%
Out of bounds ▲	80%	50%	Off	Off	energizes	Level falls to 78%
			On	On	de-energizes	Level rises to 82%
			Off	Off	energizes	Level rises to 52%
			On	On	de-energizes	Level falls to 48%
Rate of change	+10%	+5%	Off	Off	de-energizes	Fill rate increases to 10%/min
			On	On	energizes	Fill rate decreases to 5%/min
	-10%	-5%	Off	Off	de-energizes	Empty rate increases to 10%/min
			On	On	energizes	Empty rate decreases to 5%/min
Temperature	60	55	On	On	de-energizes	Temperature rises to 60°C
			Off	Off	energizes	Temperature falls to 55°C
	-30	-25	On	On	de-energizes	Temperature falls to -30°C
			Off	Off	energizes	Temperature rises to -25°C
Pump	80%	20%	On	On	energizes	Start pump down on level at 80%
			Off	Off	de-energizes	Stop pump down on level at 20%
	20%	80%	On	On	energizes	Start pump up on level at 20%
			Off	Off	de-energizes	Stop pump up on level at 80%

* Values shown are for illustration purposes only. Enter values which apply to your particular installation.

▲ 2% factory set deadband, adjustable via P116

P112 Relay A Setpoint

Enter the critical point for the desired action to occur (based on the Relay Function selected).

Values:
-999 to 9999

Note:
Relay A/B Setpoint values cannot be exactly equal.

P113 Relay B Setpoint

Enter the critical point for the desired action to occur (based on the Relay Function selected).

Values:

-999 to 9999

P 116 Bound Alarm Deadband

For 'in bounds' and 'out of bounds' Relay Functions (P111 = 2 and 3 respectively), a deadband prevents relay chatter due to material level fluctuations at the upper or lower setpoint.

Enter deadband in % of span or units of P005. (Factory set at 2%).

The deadband value is applied above and below the upper and lower bound setpoints.

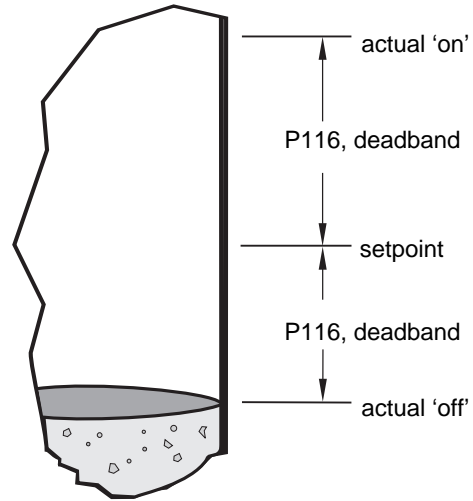

e.g. in bounds, lower setpoint

P129 Relay Failsafe

Use this feature for relay failsafe operation independent from the Failsafe Material Level (P071).

When accessed, the Parameter Type display changes to the Relay symbol and the Point Number display changes to the Relay Number (corresponding to the SPL terminals)

Select:

"OFF" to have the relay respond to the Failsafe Material Level (P071).

"HOLd" to hold the relay at the "last known" state until normal operation resumes,





"dE" to have the relay de-energize immediately, or

"En" to have the relay energize immediately.

When the Relay Function (P111) is set for:

- "alarm" (any option other than "pump"), this feature is preset to "OFF".
- "pump", this feature is preset to "dE".

To select an independent Relay Failsafe option value:

1. Press  to display the Auxiliary Function symbol,
2. Press  or  to scroll access the failsafe options.
3. Press , with the desired option displayed.

Values:

"OFF"

"HOLd"

"dE"

"En"

mA Output Parameters (P200 to P203, P210 to P215, P219)

If SPL mA outputs are to be used, alter the following parameters as required.

Note:
Otherwise, proceed to Operations.

When a mA Output Parameter is accessed, the mA symbol is displayed in the Point Type field and the mA output number (corresponding to the SPL terminals) is displayed in the Point Number field.

P200 mA Range

Enter the desired range of the mA output displayed.

Values:

0 = OFF

1 = 0 to 20 mA	20 mA = high level (unless P001 = 2 or 3, then 20 mA = low)
2 = 4 to 20 mA (preset)	

3 = 20 to 0 mA	20 mA = low level (unless P001 = 2 or 3, then 20 mA = high)
4 = 20 to 4 mA	

P201 mA Function

Use this feature to alter the automatic mA output/measurement relationship, if desired.

The mA Function automatically corresponds to "level", "space", or "distance" based upon Operation (P001). If a Tank Shape (P050) is programmed, the mA Function automatically corresponds to volume (unless the mA Allocation has been altered).

Values:

1 = level

2 = space

3 = distance

4 = volume

P203 (V) mA Value / Transducer

View the current value of the mA output.

This is the Auxiliary Reading displayed when [mA] is pressed in the RUN mode.

Values:

0.000 to 22.00

P210 0/4 mA Setpoint

Use this feature to reference the minimum mA output to any point in the measurement range.

Enter the material level (referenced to Empty, P006) corresponding to the minimum mA output.

This feature is preset to 0% or 100% of Span (P007) as determined by Operation (P001).

Typically, this value is entered in Units (P005) or percent of Span (P007). If mA Function is set for "volume", enter the value in the Max Volume (P051) units or in percent of Max Volume.

Values:

-999 to 9999

P211 20 mA Setpoint

Use this feature to reference the 20 mA output to any point in the measurement range.

Enter the material level (referenced to Empty, P006) corresponding to 20 mA.

This feature is preset to 0% or 100% of Span (P007) as determined by Operation (P001).

Typically, the value is entered in Units (P005) or percent of Span (P007). If mA Function is set for "volume", enter the value in the Max Volume (P051) units or as a percent of Max Volume.

Values:

-999 to 9999

P212 mA Min Limit

Use this feature to prevent the mA output from falling below the minimum acceptable mA input value (preset to 3.800 mA) of the device connected.

Values:

0.000 to 22.00

P213 mA Max Limit

Use this feature to prevent the mA output from exceeding the maximum acceptable mA input value (preset to 20.20 mA) of the device connected.

Values:

0.000 to 22.00

P214 4 mA Trim

Use this feature (in combination with 20 mA Trim) if the device connected to the mA output displayed is out of calibration, yet device recalibration is impractical.

Adjust this value (preset to 0.000) as required to make the device connected indicate 4.000 mA when this parameter is accessed.

Values:

-1.00 to 1.000

P215 20 mA Trim

Use this feature (in combination with 4 mA Trim) if the device connected to the mA output displayed is out of calibration, yet device recalibration is impractical.

Adjust this value (preset to 0.000) as required to make the device connected indicate 20.00 mA when this parameter is accessed.





Values:

-1.00 to 1.000

P219 mA Failsafe

Use this feature if mA output failsafe operation, independent from the Failsafe Material Level (P071) is desired.

To select an independent mA Failsafe option value:

1. Press  to display the Auxiliary Function symbol,
2. Press  or  to scroll access the failsafe options.
3. Press , with the desired option displayed.

Values:

"OFF" to have the mA output respond to the Failsafe Material Level (P071).

"HOLd" to hold the output at the "last known" value until normal operation resumes.

"LO" to produce the "Empty" mA output immediately on Failsafe Timer (P070) expiry.

"HI" to produce the "Span" mA output immediately on Failsafe Timer (P070) expiry.

Alternatively, to produce an immediate mA output at a specific value, enter the value required.

Values:

0.0 to 22.00

Enhancement Parameters

This section identifies all SPL operator programmable features designed for altering operation to suit individual operator preferences or overcome measurement difficulties.

Typically, these parameters are only altered as directed by the Troubleshooting Guide. If RUN mode performance requires improvement, access and alter the following parameters as required.

Note:
Otherwise, proceed to Operation.

Parameter category	Purpose	Page
Data Logging	to view previous maximum Temperature records	52
Profile Records	intended for use by Milltronics Service Personnel	53
Installation Records	to identify length of service and power failure occurrence	56
Range Calibration	to compensate for measurement offset and/or sound velocity	56
Temperature Compensation	to override automatic temperature compensation features	59
Rate	to override Measurement Response (P003)	60
Measurement Verification	to override Measurement Response (P003)	62
Scanning	to override automatic scanning delay or use Auxiliary Transducer	64
Display Parameters	to override the preset display operating characteristics	65
Peripheral Communications Support	Communication Support	67
SmartLinx [®]	Set up SmartLinx [®] Module	68
Echo Processing	to troubleshoot false echo detection	69
Advanced Echo Processing	intended for use by Milltronics Service personnel	72
Test Parameters	intended for use by Milltronics Service personnel	80
Measurement Parameters	to verify Application Parameter programming	83
Master Reset	to reset Parameter Values to factory settings	85

Note:
When an Enhancement Parameter is altered, return to the RUN mode to verify the performance desired is achieved, before making any other changes.

Data Logging Parameters (P300 and P302)

View the maximum Temperature recorded in the RUN mode.

P300 (V) Temperature, Transducer Max

Use this feature if vessel temperature is monitored by an Ultrasonic/Temperature transducer to view the highest temperature recorded (in ° C).

Values:

-50 to 150

P302 (V) Temperature, Sensor Max

Use this feature if vessel temperature is monitored by a TS-3 Temp Sensor to view the highest temperature recorded (in ° C).

When accessed, the TS-3 symbol is displayed in the Point Type field.

Values:

-50 to 150

Profile Records (P330 to P337)

The following parameters are for authorized Milltronics service personnel or Instrumentation Technicians familiar with Milltronics echo processing techniques.

Use these features to record and save a total of up to 10 Echo profiles, initiated manually (P330), or automatically (P331 et al). See Scope displays (P810) for echo profile viewing hardware / software requirements.

If 10 Echo Profiles are already saved, addresses 1 through 10 are filled, the oldest automatically initiated record is overwritten. Manually initiated records are not automatically overwritten. All records are automatically deleted in the event of a power interruption.

When a record is displayed, results are based on current programming (which may have been altered since the record was saved). This permits the effect on the echo profile to be observed when changing an echo parameter.

P330 Profile Record

In addition to serving as a library for profile records, this parameter provides two functions:

- manually records and saves echo profiles
- displays an echo profile, recorded manually or automatically, e.g. via an oscilloscope.

To select a record address:

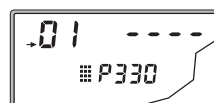

Starting with the initial parameter display:



e.g. initial parameter display

Press  until the address index is enabled



Pressing   selects the desired address, 1 to 10, and displays the associated parameter.

Value:

`----' = no record

`x#' = record

Where:

X = A, automatically initiated

 = U, manually initiated

= transducer number



e.g. address 2 selected, no record saved

To manually record a profile:

Press  to cause the transducer* to fire. An echo profile is recorded into the internal scope buffer for display.



To save a manual record:

Press  to copy the echo profile record in the scope buffer and save it in the selected address in the record library. The parameter value field displays the new record co-ordinates.



e.g. manually initiated record from transducer 1 saved in address 2

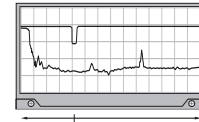

To display a record

Press   to copy the echo profile record in the selected address to the scope buffer, for display.



e.g. oscilloscope displays record in address 3

To delete a record:

Press   to delete the echo profile record in the selected address.

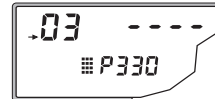

Parameter value returns to ` - - - - '.

e.g. record deleted, address 3 clear

* Access the Scope Displays (P810) parameter to select the Transducer.

P331 (G) Auto Record Enable

Use this feature (if desired) to enable/disable the Auto Profile Record function.

Values:
 0 = off
 1 = on

P333 (G) Auto Record Interval

Enter the time (in minutes) to elapse after an Auto Profile Record is saved before another Auto Profile Record can be saved (subject to all other restrictions).

Values:
 0.000 to 9999 (preset to 120 minutes)

Auto Record A/B Setpoint

Use Auto Record A Setpoint (P334) and Auto Record B Setpoint (P335) to define the boundaries within which the level must be, for the resultant Echo Profile to be considered for an Auto Profile Record.

If “ - - - - ” is displayed for either P334 or P335, Auto Profile Records are saved regardless of current level (subject to all other restrictions).

Enter the level value in Units (P005) or percent of Span (P007) as referenced to Empty (P006).

(Ensure the % Symbol is displayed before attempting to enter a value in percent, see Programming / Keypad).

P334 (G) Auto Record A Setpoint

Enter the critical level which, in conjunction with Auto Record B Setpoint, defines the boundaries for Auto Profile Records to be stored.

Values:

-999 to 9999

P335 (G) Auto Record B Setpoint

Enter the critical level which, in conjunction with Auto Record A Setpoint, defines the boundaries for Auto Profile Records to be stored.

Values:

-999 to 9999

P336 (G) Auto Record Filling/Emptying

Use this feature to restrict Auto Profile Records from being saved unless the level is rising, falling or either.

If the level changes at a rate in excess of the corresponding Filling/ Emptying Indicator (P702 / P703) values, the Echo Profile is saved subject to this and other Auto Profile Record restrictions).

Values:

0 = Auto Profile Record on filling or emptying (preset).

1 = Auto Profile Record on filling only.

2 = Auto Profile Record on emptying only.

P337 (G) Auto Record LOE Time

Use this feature to restrict Auto Profile Records from being saved unless an extended loss of echo (LOE) condition occurs.

If the LOE condition exceeds the period entered (in seconds) the Echo Profile is saved subject to this and other Auto Profile Record restrictions.

When set for "0" (preset), LOE is not required for an Auto Profile Record to be saved.

Values:

0.0 to 9999

Installation Records (P340 to P342)

P340 (V) Date of Manufacture

View the date of manufacture of this SPL.

Values:

YY:MM:DD

P341 (V) Run Time

View the accumulated number of days this SPL has been operating, since the Date of Manufacture.

Values:

0.000 to 9999

P342 (V) Start Ups

View the accumulated number of times power has been applied to the SPL (following a power interruption), since the Date of Manufacture (P340).

Values:

1 to 9999

Range Calibration Parameters (P650 to P654)

P650 Offset Calibration

Use this feature if the Empty (P006) value was estimated or if the reported material level is consistently high or low by a fixed amount (e.g. 2 cm).

Before using this feature, verify the:

- Empty (P006) value (as measured or estimated) was entered correctly.
- Vessel atmosphere Temperature (P664) is correct.
- Offset Reading (P062) value (if used) was entered correctly.

To perform an Offset Calibration:

With the material at a high steady level...

1. Press  to display the calculated distance*.
2. Repeat step 1 at least 5 times to overcome Echo Lock (P721) and verify repeatability.
3. Measure the actual distance* (e.g. with a tape measure).
4. Enter the actual value. (The Offset Correction amount is stored in P652).

Values:

-999 to 9999

P651 Sound Velocity Calibration

Use this feature if:

- The vessel atmosphere is other than "air".
- The vessel atmosphere temperature is unknown and a temperature sensing device is not used.
- The Reading accuracy is acceptable at higher material levels only.

To perform a Sound Velocity Calibration:

With the material at a low steady level...

1. Allow sufficient time for the vapour concentration to stabilize.
2. Press  to display the calculated distance*.
3. Repeat step 2 at least 5 times to overcome Echo Lock (P721) and verify repeatability.
4. Measure the actual distance* (e.g. with a tape measure).
5. Enter the actual value. (Velocity parameters P653 and P654 are adjusted accordingly).

Repeat this procedure if the vessel atmosphere type, concentration, or temperature varies from that present when the last sound velocity calibration was performed.

Values:

-999 to 9999

* When Operation (P001) is set for:

- "level", the distance is from Empty (P006) to the material/object surface.
- "space" or "tripper", the distance is from Span (P007) to the material/object surface.
- "distance", the distance is from the transducer face to the material/object surface.

P652 Offset Correction

View the amount of offset applied to the Reading.

This value is automatically adjusted when an Offset Calibration is performed.

Alternatively, if the amount of Offset Correction required is known (and performing an Offset Calibration is not desired), enter the amount to be added to the Reading before display.

Values:

-999 to 9999

P653 Velocity

View the current vessel atmosphere sound velocity.

This value is based on Velocity at 20°C (P654) for the current Temperature (P664), based on the sound velocity vs. temperature characteristics of "air".

When a Sound Velocity Calibration is performed, this value is automatically adjusted as required to suit the current atmosphere type, concentration, and temperature.

Alternatively, if the current sound velocity is known, enter the current sound velocity. (Refer to Technical Reference Sound Velocity).

The units used are m/s if P005 = 1, 2, or 3 (ft/s if P005 = 4 or 5).

Values:

50.01 to 2001 m/s (164.1 to 6563 ft/s)

P654 Velocity at 20°C

View the current vessel atmosphere sound velocity normalized to 20°C (68°F).

This value is used to calculate Sound Velocity (P653), using Temperature (P664) based on the sound velocity vs. temperature characteristics of "air".

After a Sound Velocity Calibration, this value may be checked to verify whether the vessel atmosphere is "air" (typically 344.1 m/s or 1129 ft/s).

Alternatively, if the vessel atmosphere sound velocity at 20°C (68°F) is known, and the sound velocity vs. temperature characteristics are similar to that of "air", enter the sound velocity.

The units used are m/s if P005 = 1, 2, or 3 (or ft/s if P005 = 4 or 5).

Values:

50.01 to 2001 m/s (164.1 to 6563 ft/s)

Temperature Compensation Parameters (P660 to P664)

P660 Temp Source

This feature is preset to "AUTO". On firing the transducer, the SPL scans the TS-3 temperature sensor. If a TS-3 sensor is not connected, the temperature measurement from the ultrasonic/temperature transducer is used. If the transducer used does not have an integral temperature sensor, the Temp Fixed (P661) value is used.

If the temperature of the atmosphere within the transducer beam varies with distance from the transducer, connect a TS-3 Temperature Sensor and an ultrasonic/temperature transducer and select "average".

Values:

- 1 = AUTO
- 2 = Temp Fixed
- 3 = Ultrasonic/Temperature Transducer
- 4 = TS-3 Temperature Sensor
- 5 = Average
- 6 = TS-3 SENSOR # 1

P661 Temp Fixed

Use this feature if a temperature sensing device is not used.

Enter the temperature (in°C) of the vessel atmosphere within the transducer beam. If the temperature varies with distance from the transducer, enter the average temperature. This value is preset to 20.00°C.

Values:

-50 to 150

P664 (V) Temperature

View the current vessel atmosphere temperature in C.

This is the value displayed when  is pressed in the RUN mode.

If Temp Source (P660) is set to any value other than Fixed Temp, the value displayed is the temperature measured. If Temp Source is set to Fixed Temp, the P661 value is displayed.

Values:

-50 to 150

Rate Parameters (P700 to P707)

P700

Max Fill Rate

Adjust the SPL response to increases in the actual material level (or advance to a higher Failsafe Material Level, P071).

Enter a value slightly greater than the maximum vessel filling rate.

This value (in Units (P005) or % of Span (P007) per minute) is automatically altered when Measurement Response (P003) is altered. See Technical Reference Measurement Response.

Values:

0.000 to 9999

P701

Max Empty Rate

Adjust the SPL response to decreases in the actual material level (or advance to a lower Failsafe Material Level, P071).

Enter a value slightly greater than the maximum vessel emptying rate.

This value (in Units (P005) or % of Span (P007) per minute) is automatically altered when Measurement Response (P003) is altered. See Technical Reference Measurement Response.

Values:

0.000 to 9999

P702

Filling Indicator

Enter the fill rate required to activate the LCD Material Filling indicator.

This value (in Units (P005) or % of Span (P007) per minute) is automatically set to 10% of the Max Fill Rate (P700).

Values:

-999 to 9999

P703

Emptying Indicator

Enter the empty rate required to activate the LCD Material Emptying indicator.

This value (in Units (P005) or % of Span (P007) per minute) is automatically set to 10% of the Max Empty Rate (P701) .

Values:

-999 to 9999

P704 Rate Filter

Use this feature to avoid Rate Value (P707) fluctuations due to a "splashing" material surface.

This value is automatically altered when Measurement Response (P003) is altered. See Technical Reference / Measurement Response.

This value automatically alters the Rate Update Time (P705) and / or Rate Update Distance(P706). Alternatively, these parameter values may be altered independently.

Enter the time period/distance the Rate Value is averaged before display update.

Values:

- 0 = rate display not required
- 1 = continuously averaged and updated
- 2 = 1 minute or 50 mm (2 in)
- 3 = 5 minutes or 100 mm (3.9 in)
- 4 = 10 minutes or 300 mm (11.8 in)
- 5 = 10 minutes or 1000 mm (39.4 in)

P705 Rate Update Time

Enter the time period (in seconds) over which the material level rate of change is averaged before Rate Value update.

Values:

0.000 to 9999

P706 Rate Update Distance

Enter the material level change (in metres) to initiate a Rate Value update.

Values:

0.000 to 9999

P707 (V) Rate Value

View the rate of material level change (in Units (P005) or % of Span (P007) per minute).

Note:

A negative rate indicates the vessel is emptying.

This is the value displayed when  is pressed in the RUN mode.

Values:

-999 to 999

Measurement Verification Parameters (P710 to P713)

P710 Fuzz Filter

Use this feature to stabilize the reported material level, due to material level fluctuations (such as a rippling or splashing liquid surface), within the Echo Lock Window (P713).

This value (in % of Span) is automatically altered when Measurement Response (P003) is altered. (See Technical Reference Measurement Response). The higher the value entered, the greater the fluctuation stabilized. (0 = off)

Values:

0 to 100

P711 Echo Lock

Use this feature to select the measurement verification process.

This value is automatically altered when Material (P002) and/or Measurement Response (P003) is altered. (See Technical Reference Measurement Response).

When set for "maximum verification" or "material agitator", a new measurement outside of the Echo Lock Window (P713) must meet the sampling criterion (P712).

For "total lock", Echo Lock Window (P713) is preset to "0". The SPL continuously searches for the best echo according to the algorithm chosen (P820). If the selected echo is within the window, the window is then centered about the echo. If not, the window widens with each successive shot until the selected echo is within the window. The window then returns to its normal width.

When Echo Lock is turned "off" the SPL responds immediately to a new measurement as restricted by the Max Fill / Empty Rate (P700/P701), however measurement reliability is affected.

Values:

0 = off

1 = maximum verification

2 = material agitator

3 = total lock

P712 Echo Lock Sampling

The sampling criterion sets the number of consecutive echoes appearing above or below the echo currently locked onto, that must occur before the measurements are validated as the new reading (for Echo Lock P711 values: 1 or 2).

P711 value	P712 preset value
1, max verification	5:5
2, material agitator	5:2

e.g. : P711 = 2, material agitator
P712 = 5:2

A new reading will not be validated unless 5 consecutive measurements higher or 2 consecutive measurements lower than the current readings occur.

Values:

x.y x = # of `above' echoes y = # of `below' echoes

Note:

Resetting P711 returns P712 to the respective preset values.

P713

Echo Lock Window

Use this feature to adjust the new measurement change permitted before Echo Lock is applied.

The Echo Lock Window is a "time window" (in msec) placed about the echo used to derive the Reading. When a new measurement falls within the window, the window is recentered and the new Reading is calculated. Otherwise, the new measurement is verified by Echo Lock (P711) before the SPL + updates the reading.

When "0" is entered (preset), the window is automatically calculated based on the Max Fill / Empty Rate (P700 / P701). This calculation is automatically performed when Measurement Response (P003) is altered. See Technical Reference Measurement Response.

For slower Measurement Response (P003) values the calculated Echo Lock Window is narrow. For faster values the window becomes increasingly wider, (When "immediate" is selected the window is normally wide open).

Values:

0.000 to 9999

Scanning Parameters (P725 to P729)

P726 **Level System Sync**

Use this feature if another level measurement system is mounted near the SPL.

See Installation Interconnection / Level System Synchronization.

Values:

0 = not required

1 = synchronize level monitors (preset)

P728 **Shot Delay**

Use this feature if transient acoustic noise within the vessel is causing measurement difficulties.

This value is automatically altered when Measurement Response (P003) is altered. (See Technical Reference / Measurement Response.)

Enter the delay between transmit pulse shots (in seconds).

Values:

0.1 to 4.0

P729 (V) **Scan Time**

View the time elapsed (in seconds) since the point displayed was last scanned. This value may be viewed as an Auxiliary Reading in the Run mode. See Operation / Keypad.

Values:

0.000 to 9999

Display Parameters (P730 to P733, P740)





P730 (G) Auxiliary Reading

Use this feature to display operator selected Auxiliary Readings temporarily.

Select "OFF" to display Auxiliary Readings temporarily. Select "HOLd" to display Auxiliary Readings until another Auxiliary Reading is selected.

(See Operation / Keypad for RUN mode Auxiliary Reading selection.)

To select the Auxiliary Reading operation desired.

1. Press  to display the Auxiliary Function symbol.
2. Press  or  to display the "OFF" or "HOLd" (preset) option as desired.
3. Press .

If desired, also enter the Parameter Number to default in the Auxiliary Reading display.

Values:

000 to 999

P731 (G) Auxiliary Reading Key

Use this feature to enable a specific Parameter Value to be monitored in the RUN mode.

Enter the Parameter Number whose value is to be displayed in the Auxiliary Reading field when  is pressed in the RUN mode.

(See Operation Keypad for RUN mode Auxiliary Reading selection.)

Values:

000 to 999 (preset to Material Measurement, P921)

P732 (G) Display Delay

Use this feature if the secondary message and reading change too quickly.

Enter the delay (in seconds) before the display changes to the secondary message (if one is there). For example, "OPEN" or "ERROR".

Values:

0.5 to 10 (preset to 1.5 seconds)

P733 (G) Scroll Access

Use this feature to select the programming mode parameter scroll access option desired.

Select:

"off" to scroll access all operator accessible parameters.

"smart" to scroll access Quick Start, previously altered, and tagged parameters.

"tagged" to scroll access operator tagged parameters only.

(Any accessed parameter may be *tagged* or *untagged* by pressing  .

 is displayed when a previously tagged or altered parameter is accessed.

Values:

0 = off

1 = smart (preset)

2 = tagged

Peripheral Communication Support Parameters (P740 to P749)

P740 Peripheral Communications

Use this feature to select the SPL to communication message format.

Select:

- | | |
|-------------|---|
| “off” | if the communication port is not used, to increase the SPL processing speed. |
| “normal” | to have messages transmitted in a continuous string of characters. (Requires less SPL processing time than formatted messages). |
| “formatted” | to have commas inserted between the message fields for easier message dissemination (when viewed on a monitor). |

Note:

Refer to Technical Reference / Communication Support if a Peripheral Communication is required.

Values:

- 0 = off
- 1 = normal messages (preset)
- 2 = formatted messages

P748 RS485 Termination

Single point termination may be required to minimize transmission reflections, on long cable runs typical of 500m or more. Turn on the termination if required.

Values:

- 0 = off
- 1 = on

P749 Serial Bus Type (V)

Displays the type of communication bus the SPL is currently set for. If there is no connection, the SPL defaults to RS-485. If a bus type other than RS-485 is connected, the SPL displays the type of bus it is, or is attempting to, communicate with.

Displays:

- 232 = RS-232
- 485 = RS-485 (default setting when nothing is connected)
- bPL = bipolar current loop
- rJ11 = for Milltronics use

SmartLinx[®] Parameters (P750 to P792)

Protocol Specific Parameters (P750-P789)

These parameters are specific to the SmartLinx[®] module installed. Refer to the module documentation for a list and description of the specific parameter requirements.

P790 Hardware Error

Use this feature to display the results of ongoing hardware tests within the communications circuitry. If any test does not meet the PASS requirements, communication halts and tests are repeated until PASS requirements are met. Communications then resumes.

Displays:

PASS: no problem

FAIL: faulty SmartLinx module or SPL

ERR1: unknown protocol, upgrade the SPL software

P791 Bus Error

This feature indicates if an error condition is occurring on the bus.

Displays:

0 = no error

∅ = error code, refer to the SmartLinx module documentation for explanation of the error code

P792 Bus Error Count

This register increments by 1 each time a bus error (P752) is reported. The register is factory set at 0 and can be preset to any value. The register is reset to 0 by the master reset (P999).

Echo Processing Parameters (P800 to P807)

P800 Near Blanking



Use this feature if the material level is incorrectly reported to be near the transducer face.

The *Near Blanking distance* (distance from the transducer face which is not ultrasonically measurable) is automatically set to minimum, when the Transducer (P004) value is entered.

Near Blanking may be extended to overcome measurement difficulties which cannot otherwise be corrected by transducer location, mounting, or aiming modification. (e.g. partial acoustic beam obstruction, standpipe open end detection, etc.)

Extend Near Blanking to 150 mm (6 in) beyond the incorrect distance measured.

Ensure the Near Blanking distance is less than Empty (P006) - Span (P007).

To reset the automatic Near Blanking value press  .

Values:

0.000 to 9999

P801 Range Extension

Use this feature if an incorrect level is reported (when material level is lower than Empty, P006).

Range Extension is the distance in Units (P005) or % of Span (P007) beyond Empty, which is still ultrasonically measurable.

If Empty is substantially higher than the actual vessel bottom, increase Range Extension such that Empty plus Range Extension is greater than the transducer to vessel bottom distance.

This value is automatically preset to 20% of Span (P007).

Values:

0.000 to 9999

P802 Submergence Transducer

Use this feature when the transducer connected is equipped with a submergence shield.

If the transducer is submerged, the SPL detects that the monitored surface is within the Near Blanking (P800) distance, to activate failsafe operation (subject to Failsafe Parameter programming).

Values :
 0 = off (preset)
 1 = submergence transducer

P803 Shot/Pulse Mode

Use this feature to increase response independent from Measurement Response (P003).

Select "short and long" to have short and long acoustic shots fired each time a vessel is scanned. Select "short" to have only short shots fired if the Echo Confidence (P805) produced by a short shot exceeds the short Confidence Threshold (P804).

This value is automatically altered when Measurement Response (P003) is altered. See Technical Reference Measurement Response.

Values:
 1 = short
 2 = short and long

P804 Confidence Threshold

Use this feature when an incorrect material level is reported.

The short and long Confidence Thresholds are preset to 10 and 5 respectively. If the Echo Confidence (P805) of a particular echo exceeds the Confidence Threshold, that echo is considered for evaluation by Sonic Intelligence™.

Values:
 x.y x = short (0 to 99), y = long (0 to 99)

P805 (V) Echo Confidence

Use this feature to monitor the effect of transducer aiming, location, and mechanical transducer / mounting isolation.

This is the value displayed when  is pressed for 4 seconds in the RUN mode.

Both short and long shot Echo Confidence is displayed.

"--" is displayed if the respective shot (short or long) was not included in the evaluation.

"E" is displayed if the transducer cable is open or short circuited.

"--:--" is displayed if no shots have been taken yet.

Values:
 x:y x = short (0 to 99), y = long (0 to 99)

P806 (V) Echo Strength

Use this feature to view the strength (in dB above 1 μ V rms) of the echo selected to base the distance calculation upon.

Values:

0 to 99

P807 (V) Noise

Observe the average and peak ambient noise (in dB above 1 μ V rms) being processed.

The noise level is a combination of transient acoustic noise and electrical noise (induced into the transducer cable or receiving circuitry itself).

Values:

x.y x = average (-99 to 99), y = peak (-99 to 99)

Advanced Echo Processing (P810,P816-P825,P830-P835,P840-P845,P850-P852)

Note:

The following Echo Processing parameters are intended for use by authorized Milltronics Service personnel or Industrial Instrumentation Technicians familiar with Milltronics ultrasonic echo processing techniques.

Anatomy of an Echo Profile

The relevant parts of an echo profile are listed here. These are visible in either Dolphin Plus or an oscilloscope.

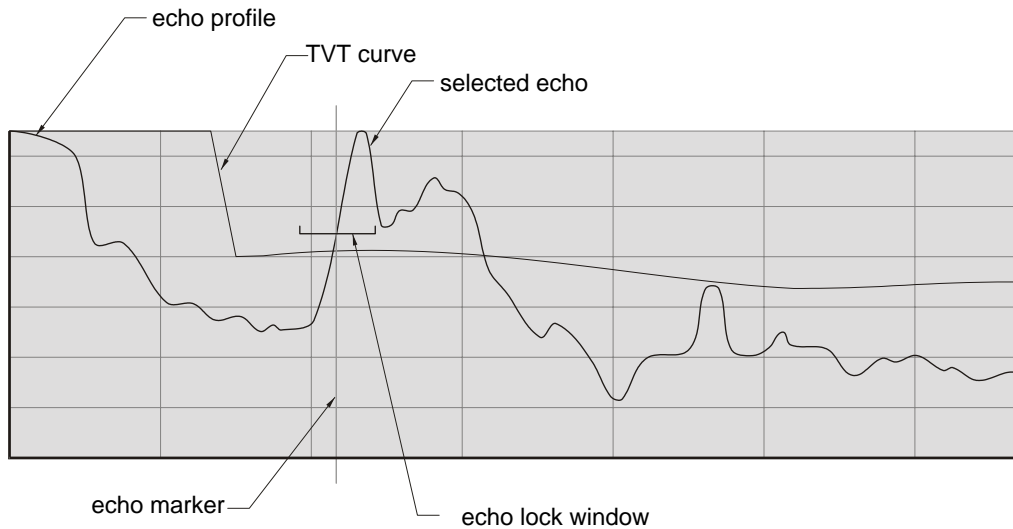

P810

Scope Displays

Use this feature to monitor the results of Echo Processing parameter alterations.



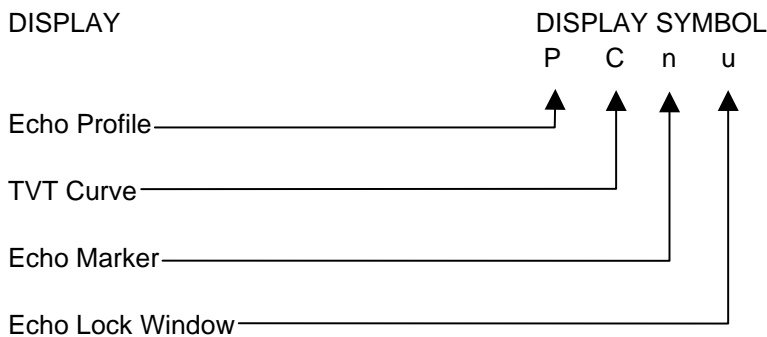

Connect an oscilloscope to Display Board TP4, TP5, and TP6.

Sweep = 10 μ s/div. to 1 ms/div. (x 100 for real time); Amplitude = 1 V/div.; Trigger = external

Observe any combination of the following Scope Displays:



To select the Scope Display desired...

1. Press  to display the Auxiliary Function symbol,
2. Press  or  to scroll access the desired Reading display symbols.
3. Press  with the desired display symbols displayed.

Alternatively, a 4 digit binary value may be entered, where a "0" turns the associated signal display "off", and a "1" turns the associated display "on".

e.g. 1110 = PCn_ = Echo Profile, TVT Curve, and Echo Marker displays on.

See Technical Reference Echo Processing for Scope Display illustrations.

Use the Scope Displays after pressing  (in the program mode) to observe the result of Echo Processing parameter alterations. (Take several measurements to verify measurement repeatability and overcome Echo Lock (P711) restrictions).

As preset, all displays are off.

P816 (V) Echo Time

Observe the time (in ms) between the transmit pulse and the processed echo.

Values:



0.000 to 9999

Profile Pointer Parameters

When a Profile Pointer Parameter is accessed, the Echo Lock Window scope display changes to a Profile Pointer display. The Profile Pointer may be moved to a number of points on the Echo Profile, to gain specific information dependent upon the Profile Pointer Parameter used.

To move the Profile Pointer to a specific point, enter the desired value. The Profile Pointer will move to the nearest acceptable Echo Profile point. The Profile Pointer is preset to "0".

Alternatively, to scroll the Profile Pointer along the Echo Profile...

1. Press  to display the Auxiliary Function symbol,
2. Press  or  to move the Profile Pointer to the left or right respectively.

When the Profile Pointer Parameters are exited and  is pressed or the RUN mode is entered, the Profile Pointer display automatically changes back to the Echo Lock Window display.

P817 (V) Profile Pointer Time

Observe the time (in ms) between the transmit pulse and the Profile Pointer.

Values:

0.000 to 9999

P818 (V) Profile Pointer Distance

Observe the distance (in P005 Units) between the transducer face and the Profile Pointer.

Values:
0.000 to 9999

P819 (V) Profile Pointer Amplitude

Observe the amplitude (in dB above 1 μ V rms) of the Echo Profile at the Profile Pointer position.

Values:
0 to 99





P820 Algorithm

Use this feature to select the Algorithm(s) (mathematical operations) which the Sonic Intelligence™ echo selection is to be based on.

This value is automatically altered by Material (P002).

If the wrong echo is processed, select an alternate algorithm, while observing the resultant echo processing displays.

To select an Algorithm...

1. Press  to display the Auxiliary Function symbol,
2. Press  or  to display the desired Reading display symbol(s),
3. Press  (when the desired Algorithm is displayed)

The material/vessel type most likely to benefit from a particular algorithm is included with the following option values.

Value	Description
ALF	long range Area, Largest, and First average (general purpose, solids)
A	long range Area only (coarse, heaped solids)
L	long range Largest only (liquids, open vessels)
F	long range First only (liquids, closed vessel)
AL	long range Area and Largest average (fine heaped solids)
AF	long range Area and First average (coarse flat solids)
LF	long range Largest and First average (general purpose, liquids)
bLF	short range Largest or First (general purpose)
bL	short range Largest only (solids and open vessel liquids)
bF	short range First only (closed vessel liquids)

P821**Spike Filter**

Activate the Spike Filter if interference spikes are observed on the long shot Echo Profile display.

Values:

0 = off

1 = on (preset)

P822**Narrow Echo Filter**

Use this feature (when monitoring solids (P002 = 2) only) if an echo from a partial transducer beam obstruction (seams, ladder rungs, etc.) is processed.

Enter the width of false echoes (in ms), to be removed from the long shot Echo Profile.

When a value is keyed in, the nearest acceptable value is entered.

Values:

0 = off (preset), greater = wider

P823**Reform Echo**

Use this feature if the reported material level fluctuates slightly though the material surface is still (when monitoring solid Material (P002 = 2) only).

Enter the amount (in ms) of long shot Echo Profile smoothing required to eliminate jagged peaks in the Echo Profile.

When a value is keyed in, the nearest acceptable value is entered.

Values:

0 = off (preset), greater = wider

P825**Echo Marker Trigger**

Use this feature when the reported material level fluctuates slightly, due to a variable rise in the leading edge of the true echo on the Echo Profile.

Enter the value (in percent of echo height) to ensure the Echo Lock Window intersects the Echo Profile at the sharpest rising portion of the Echo Profile representing the true echo. This value is preset to 50%.

Values:

5 to 95

P830 TVT Type

Use this feature to select the TVT Curve most suited to the material and vessel.

This feature is automatically altered when Material (P002) is altered.

Do not select "TVT SLOPES" when the "bF or bLF" Algorithm (P820) is selected.

Values:

- 1 = TVT Short Curved
- 2 = TVT Short Flat
- 3 = TVT Long Flat
- 4 = TVT Long Smooth Front
- 5 = TVT Long Smooth
- 6 = TVT Slopes

P831 TVT Shaper

Use this feature to turn the TVT Shaper "on" or "off".

Turn the TVT Shaper "on" before altering TVT Shaper Adjust. After TVT Shaper Adjust has been used to modify the TVT Curve (to avoid a false echo or pick up the true echo), this feature allows the TVT Shaper to be turned "on" and "off" while monitoring the effect.

Values:

- 0 = off
- 1 = on

P832 TVT Shaper Adjust

Use this feature to bias the shape of the TVT curve, in order to avoid it crossing false echoes from fixed objects.

Adjustment to this parameter is best done while viewing the echo profile on an oscilloscope (refer to P810). When using an oscilloscope, the Echo Lock Window display becomes the TVT Curve Pointer.

The TVT curve is divided into 40 breakpoints, accessible by enabling the point number as the breakpoint index field. Each breakpoint is normalized to a value of 0, as displayed in the parameter value field. By changing the breakpoint value, up or down, the intensity of the bias applied to that breakpoint of the curve is respectively changed. By changing the value of adjacent breakpoints, the effective bias to the shaper can be broadened to suit the desired correction. In the case of multiple false echoes, shaping can be applied along different points of the curve. Shaping should be applied sparingly in order to avoid missing the true echo.

To change a breakpoint ...

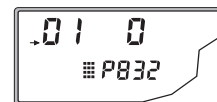



e.g. index, breakpoint1, value 0

Press  to select the Auxiliary function



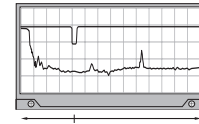
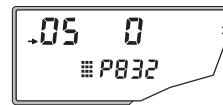

e.g. auxiliary function

Press   to scroll the breakpoint index through points 1 to 40, and move the curve pointer left or right respectively.



e.g. oscilloscope displays breakpoint 5, value 0

Press   to change the bias value of the breakpoint, -50 to 50.



e.g. breakpoint 5, value 14

Press  to enter the change in value.

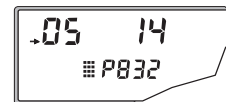

Note:
P831, TVT shaper, must be 'on'.

P833 TVT Start Min

Use this feature to adjust the TVT Curve height to ignore false echoes (or pick up true echoes) near the start of the Echo Profile.

Enter the minimum TVT Curve start point (in dB above 1 μ V rms).

This feature (preset to 45) should only be used if increased Near Blanking would extend farther than desired into the measurement range.

Values:

-30 to 225

P834 TVT Start Duration

Use this feature in conjunction with TVT Start Min (P833) to ignore false echoes (or pick up true echoes) near the start of the Echo Profile.

Enter the time (in ms) for the TVT Curve to decrease from the TVT Start Min (P833) point to the TVT Curve baseline.

Values:

0 to 9999

P835 TVT Slope Min

Enter the minimum slope (in dB/s) for the middle portion of the TVT Curve.

This feature (preset to 200) is used in conjunction with TVT Start Duration (when a long flat TVT Type is selected) to ensure the TVT Curve remains above false echoes which appear in the middle of the Echo Profile.

Alternatively, if TVT Type is set for "TVT SLOPES" (P830 = 6), this value is preset to 2000.

Use this feature to adjust the slope declination, as required.

Values:

0 to 9999

P840 Short Shot Number

Enter the number of short shots to be fired (and results averaged) per transmit pulse.

Values:

0 to 100

P841 Long Shot Number

Enter the number of long shots to be fired (and results averaged) per transmit pulse.

This value is automatically altered by Measurement Response (P003).

(See Technical Reference / Measurement Response).

Values:

0 to 200

P842 Short Shot Frequency

Use this feature to adjust the short shot transmit pulse frequency (in kHz).

This feature is automatically altered when Transducer (P004) is altered.

Values:

10.00 to 60.00

P843 Long Shot Frequency

Use this feature to adjust the long shot transmit pulse frequency (in kHz).

This feature is automatically altered when Transducer (P004) is altered.

Values:

10.00 to 60.00

P844 Short Shot Width

Use this feature to adjust the width (in ms) of the short shot transmit pulse.

This feature is automatically adjusted by Transducer (P004).

Values:

0.000 to 5.000

P845 Long Shot Width

Use this feature to adjust the width (in ms) of the long shot transmit pulse.

This feature is automatically adjusted by Transducer (P004).

Values:

0.000 to 5.000

P850 Short Shot Bias

Use this feature to slant the echo evaluation in favour of the short shot echo when both short and long shots are evaluated (see Shot Mode, P803). This feature is preset to 20.

Values:

0 to 100

P851 Short Shot Floor

Enter the minimum echo strength (in dB above 1 μ V rms), initiated from a short shot, to be considered for evaluation. This feature is preset to 50.

Values:

0 to 100

P852 Short Shot Range

Enter the maximum distance in Units (P005) to be measured using short shot echoes.

This feature is automatically altered when Transducer (P004) is altered.

Values:

0.000 to 9999

Test Parameters (P900 to P913)

Test Parameters are intended for use by Milltronics Service personnel.

P900 (V) Software Rev.

Access this parameter to determine the EPROM Rev. # without removing the enclosure lid.

Values:

00.00 to 99.99

P901 (V) Memory

Press  to activate the SPL memory test.

When the test is successful, "PASS" is displayed. Otherwise, one of the following values is displayed, indicating the type of memory failure.

Values:

PASS (memory test successful)

F1 = RAM

F2 = NOVRAM

F3 = EEPROM

F4 = EPROM

P902 (V) Watchdog

Press  to reset the microprocessor.

On successful completion (in about 15 seconds) the SPL enters the RUN mode.

P903 (V) Display

Press  to activate the display test.

All LCD segments and symbols are temporarily displayed.

P904 (G) Keypad

Press each keypad key in the following sequence:



As each key is pressed, the associated keypad number is displayed. On successful test completion "PASS" is displayed. "FAIL" is displayed if a key is pressed out of sequence or the programmer keypad malfunctions.

P905 Transmit Pulse

Press  to supply repeated transmit pulses to the transducer and/or view the transducer operating frequency (automatically altered by (P004) Transducer).

This feature may be used to monitor the transmit pulse with an oscilloscope connected to the transducer terminals.

Values:

10.00 to 60.00

P906 Communications

Press  to test the SPL communications circuitry.

Note:

Before activating this feature connect terminal block contacts 27 to 29 and 28 to 30.

On successful test completion, "PASS" is displayed. If "FAIL" is displayed, repeat the test. (The first test performed sets up the auto polarity function).

P907 Programmer Interface

Press  to activate the programmer interface (two way infrared communications) test.

On successful test completion, "PASS" is displayed. Otherwise, "FAIL" is displayed.

P910 Relay

Access this parameter to display the current state of the specified relay.

Press  to alter the relay state (energized / de-energized) or enter the value corresponding to the specific relay state desired.

Values:

0 = de-energized

1 = energized

P911 mA Output Value

Access this parameter to display the current value of the mA output.

Additionally, this feature may be used to enter a desired value. The mA output is immediately forced to the value entered, regardless of any restrictions programmed.

Values:

0.000 to 25.00

P912 Transducer Temperature

Access this parameter to display the vessel temperature in °C (as monitored by the connected ultrasonic / temperature transducer). "Err" is displayed if the transducer is not equipped with an integral temperature sensor.

Values:

-50 to 150

P913 Sensor Temperature

Access this parameter to display the vessel temperature in °C (as monitored by the connected temperature sensor). "OPEn" is displayed if a TS-3 is not connected.

Values:

-50 to 150

Measurement Parameters (P920 to P923)

Use these parameters to verify Application Parameter programming, when performing a dynamic material level test over at least 2 empty/fill cycles is impractical.

Access the following parameters to take an ultrasonic measurement and automatically:

- display the corresponding Reading in the Parameter Value field.
- set the mA output value accordingly.
- set the relay status accordingly.
- transmit the corresponding point data to the BIC-II (if used).



Note:

If measurements or simulation are desired, however SPL operation has not been verified, disable all associated process control equipment before accessing the following parameters.

To take an ultrasonic measurement, access one of the following parameters and press  (repeat 5 times to overcome Echo Lock, P711).

Alternatively, press  to simulate a rising and falling material level. During the simulation, the SPL will operate as though the material level was repeatedly cycling from full to empty to full, and so on, at a rate of 1% of Span (P007) per second. See Lock (P000) to activate control relays during simulation.

The simulation starts at level = 0, unless a specific level value was entered beforehand.

Press  to switch to the rising (or  for the emptying) simulation as required. Holding the key increases (or decreases) the simulated rate of rise (or fall), to 4% of Span per second.

Press  to end the simulation, when desired.

During a measurement or simulation, the SPL display responds as though in the RUN mode, however the value displayed in the Reading field is affected by the Measurement Parameter selected, and the material level is displayed in the Auxiliary Reading field.

P920 Reading Measurement

The Reading corresponds to all associated programming.

P921 Material Measurement

The Reading corresponds to the distance between Empty (P006) and the material level.

P922 Space Measurement

The Reading corresponds to the distance between the material level and Span (P007).

P923 Distance Measurement

The Reading corresponds to the distance between the material level and the transducer face.

P924 Volume Measurement

The Reading corresponds to the volume calculation in percent of Max Volume (P051).

Press  as required to display in Max Volume units.

P927 Distance Percent

Same as P923, plus alternate reading in % press .

Master Reset (P999)



P999 Master Reset

A *Global Master Reset* (reset all parameters to preset values) should be performed:

- to clear all operator programming from memory.
- after replacing the SPL EPROM with a different software revision number.

Following a Global Master Reset, complete reprogramming is required.

To perform a Global Master Reset:

1. With the Parameter Number field accessed, key in 999,
2. With the Point Number field accessed, key in 00,
3. Press  , "C.ALL" is displayed until the reset is complete.

Technical Reference

Transmit Pulse

The SPL transmit pulse consists of one or more electrical "shot" pulses, which are supplied to a transducer connected to the SPL terminals.

The transducer fires an acoustic "shot" for each electrical pulse supplied. After each shot is fired, sufficient time is provided for *echo* (shot reflection) reception, before the next (if applicable) shot is fired. After all shots of the transmit pulse are fired, the resultant echoes are processed.

The transmit pulse shot number, frequency, duration, delay, and associated measurement range are defined by parameters P803 and P840 to P852.

Echo Processing

Echo processing consists of echo enhancement, true echo selection, and selected echo verification.

Echo Enhancement is achieved by *filtering* (removing noise, P821 and P822) and *reforming* (connecting fragmented echo peaks, P823) the *echo profile* (digitized signal representing the echo signal received).

True echo selection is achieved by establishing the criteria which a portion of the echo profile must meet to be considered the *true echo* (echo reflected by the intended target).

Insignificant portions of the echo profile outside of the measurement range (Span P007 + Range Extension P801), below the TVT Curve (P830 to P835), and less than the Confidence Threshold (P804) and Short Shot Floor (P851) are automatically disregarded.

The remaining portions of the Echo Profile are evaluated using the Algorithm(s) (P820) and Short Shot Bias (P850) programmed. When a combination of Algorithms are used, the portion of the Echo Profile providing the best averaged Echo Confidence (P805), is selected as the true echo.

True echo verification is automatically achieved by comparing the position (relation in time after transmit) of the "new" echo to the previously accepted echo position.

If the new echo is within the Echo Lock Window (P713), the new echo is accepted and displays, outputs, and relays are updated as restricted by the Fuzz Filter (P710) and Rate Parameters (P700 to P703). If the new echo is outside of the Echo Lock Window, the new echo is not accepted until *Echo Lock* (measurement repeatability, P711) requirements are satisfied.

Echo Processing Displays (Scope Displays, P810)

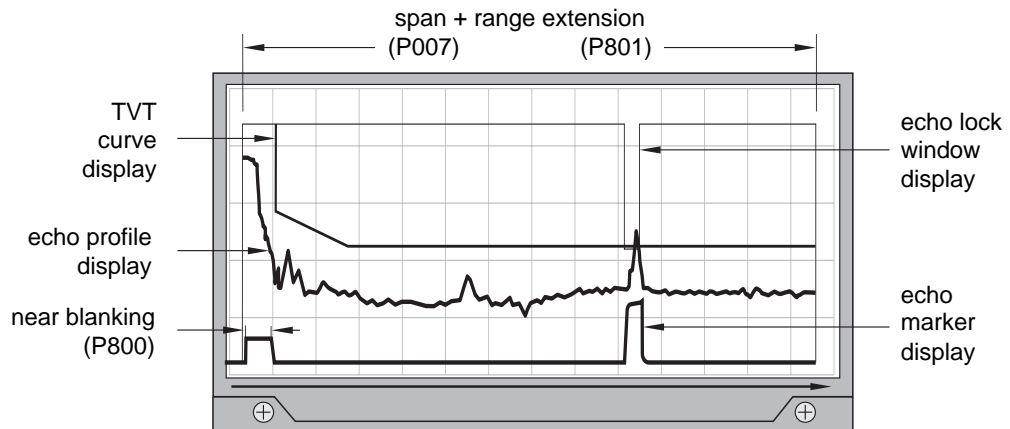

Distance Calculation

To calculate the transducer to material level (object) distance, the *transmission medium* (atmosphere) sound velocity (P653) is multiplied by the acoustic transmission to reception time period. The result (round trip distance) is divided by 2.

$$\text{Distance} = \frac{\text{Sound Velocity} \times \text{Time}}{2}$$

The Reading Value displayed is the result of performing any additional modification to the calculated distance (Operation P001, Units P005, Volume Conversion, P050 to P054, Reading Value, P060 to P063.)

Sound Velocity

The sound velocity of the transmission medium is affected by the type, temperature, and vapour pressure of the gas or vapour present. As preset, the SPL assumes the vessel atmosphere is air at 20°C (68°F). Unless altered, the sound velocity used for the distance calculation is 344.1 m/s (1129 ft/s).

Variable air temperature is automatically compensated when a Milltronics ultrasonic/temperature transducer is used. If the transducer is exposed to direct sunlight a TS-3 temperature sensor should be used.

Also, if the temperature varies between the transducer face and the object monitored, a TS-3 temperature sensor, mounted near the material surface (solids) or submerged (liquids), should be used in combination with the ultrasonic/temperature transducer. Then when Temp Source, (P660) is set for "both", the transducer and TS-3 temperature measurements are averaged.

Atmosphere composition other than air can pose a challenge for ultrasonic level measurement. However, excellent results may be obtained if the atmosphere is *homogeneous* (well mixed), at a fixed temperature, and consistent vapour pressure, by performing a Sound Velocity Calibration (P651).

The SPL automatic temperature compensation is based on the sound velocity/temperature characteristics of "air" and may not be suitable for the atmosphere present. If the atmosphere temperature is variable, frequent Sound Velocity Calibrations may be required to maintain optimum measurement accuracy.

Sound Velocity calibration frequency may be determined with experience. If the sound velocity in two vessels is always similar, future calibrations may be performed on one of the vessels and the resultant Velocity (P653) entered directly for the other vessel.

If the sound velocity of a vessel atmosphere is found to be repeatable at specific temperatures, a chart or curve may be developed. Then, rather than performing a Sound Velocity Calibration each time the vessel temperature changes significantly, the anticipated Velocity (P653) may be entered directly.

Volume Calculation

The SPL provides a variety of volume calculation features (P050 to P055).

If the vessel to be monitored does not match any of the 8 preset Tank Shape calculations, a Universal Volume calculation may be used. Use the level/volume graph or chart provided by the vessel fabricator (or create one based on the vessel dimensions).

From this graph, determine which Universal Volume calculation will provide the best results, and select the level vs volume breakpoints to be entered (32 max.). Generally, the more breakpoints entered, the greater the volume calculation accuracy.

Universal, Linear (P050 = 9)

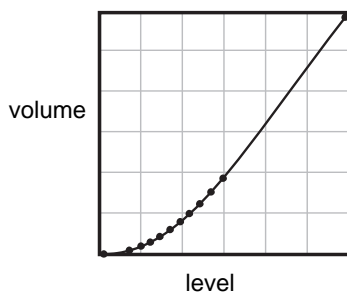

This volume calculation creates a piece-wise linear approximation of the level/volume curve. This option provides best results if the curve has sharp angles joining relatively linear sections.

Enter a Level Breakpoint at each point where the level/volume curve bends sharply (2 minimum).

For combination curves (mostly linear but include 1 or more arcs), ensure numerous breakpoints are entered along the arc, for best volume calculation accuracy.

Universal, Curved (P050 = 10)

This volume calculation creates a cubic spline approximation of the level/volume curve. This option provides best results if the curve is non-linear, and there are no sharp angles.

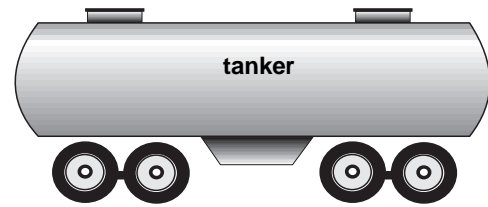
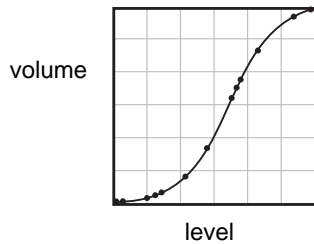

Select at least enough breakpoints from the curve to satisfy the following:

- 2 breakpoints very near the minimum level
- 1 breakpoint at the tangent points of each arc
- 1 breakpoint at each arc apex
- 2 breakpoints very near the maximum level

For combination curves, ensure at least 2 breakpoints are entered immediately before and after any sharp angle (as well as 1 breakpoint exactly at the angle) on the curve.

Measurement Response

The SPL Measurement Response (P003) to material level changes is designed to exceed the most demanding installation requirements.

If any of these parameters are independently altered, a Measurement Response parameter alteration automatically changes the independently altered value.

Note:

Slower Measurement Response provides greater measurement reliability. Faster independently set Max Fill/Empty Rates may be impeded by Echo Lock, Scan Delay and Shot Delay values.

The Measurement Response setting automatically adjusts various parameters affecting the SPL response to material level changes as in the table that follows.

#	Parameter Name (Units)	Values Dependent on Measurement Response (P003) Value				
		1(slow)	2(medium)	3(fast)	4(surge)	5(imm.)
P070	Failsafe Timer (min)	100	10	1	0.1	0
P700	Max Fill Rate (m/min)	0.1	1	10	100	1000
P701	Max Empty Rate (m/min)	0.1	1	10	100	1000
P702	Filling Indicator (m/min)	0.01	0.1	1	10	100
P703	Emptying Indicator (m/min)	0.01	0.1	1	10	100
P704	Rate Filter (option)	4	3	2	2	2
P710	Fuzz Filter (% of P007)	100	50	10	1	0
P711	Echo Lock (option)	1 or 2 (dependent on Material, P002)			0	0
P713	Echo Lock Window	(dependent on P701/P702 and time since last valid measurement)				
P728	Shot Delay (s)	0.5	0.5	0.5	0.2	0.1
P803	Shot/Pulse Mode (option)	2	2	2	1	1
P841	Long Shot Number (qty)	10	5	2	1	1

Application Examples

The following examples describe the use of SPL programmable features, to meet the needs of specific process measurement requirements.

It is highly unlikely that your specific installation will match one of these examples exactly.

However, by reviewing the example (or combination of examples) that matches your installation best, the relationship between SPL features and process measurement requirements may be more easily recognized.

Example #	Description
1	Level (or Material Volume) Measurement for a single vessel.
2	Space (or Remaining Vessel Capacity) Measurement for a single vessel.

Example 1 - Level Measurement

Material Level

This is the most common application of the SPL level monitor.

For this example we'll assume the following:

- one 30 m high cement silo is to be monitored.
- the maximum vessel filling rate is 0.08 m per minute.
- alarm indicators are required when the cement level exceeds 25 m or falls below 10 m.
- filling equipment is to be automatically deactivated at 27 m.
- in the event of a measurement difficulty, failsafe operation is to be activated in 2 minutes.
- if the difficulty doesn't subside, the filling process is to be stopped before a spill occurs.
- an XLT-30 transducer is mounted with its face flush with the top of the vessel.
- a TS-3 temperature sensor is connected to the Temp Sensor terminals.

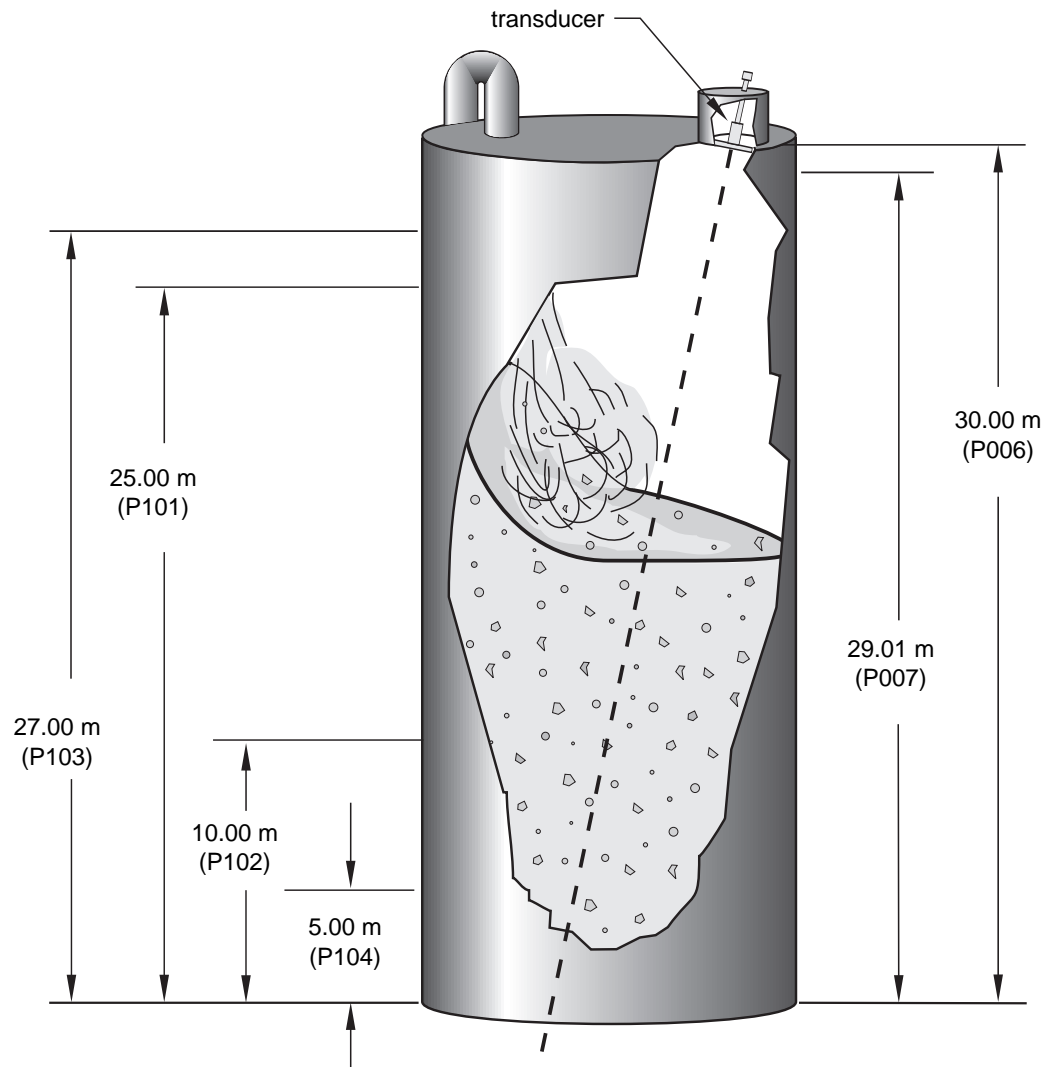

Parameter Settings

Number	Description	Instructions
P001	Operation	Enter "1" for <i>level</i> .
P002	Material	Enter "2" for <i>solid</i> .
P003	Measurement Response	Enter "1" for <i>slow</i> (0.1 m/min).
P004	Transducer	Enter "107" for <i>XLT-30</i> .
P005	Units	No entry required, (preset for <i>metres</i>).
P006	Empty	Enter "30" for transducer face to Empty equals <i>30.00 metres</i> .
P007	Span	No entry required, (preset to <i>29.01 metres</i>).
P070	Failsafe Timer	Enter "2" for failsafe activation after <i>2 minutes</i> without a valid echo.
P071	Failsafe Material Level	Enter "HI" for <i>advance to Span on "LOE"</i> .
P072	Failsafe Advance	No entry required. (preset to <i>restricted</i>).
P100	Relay Set Up	Enter "4" for <i>High, Low, High High, and Low Low</i> alarm relays.
P101	<i>High Alarm</i>	Enter "25" for <i>High Alarm at 25.00 m</i> .
P102	<i>Low Alarm</i>	Enter "10" for <i>Low Alarm at 10.00 m</i> .
P103	<i>High High Alarm</i>	Enter "27" for <i>High High Alarm at 27.00 m</i> .
P104	<i>Low Low Alarm</i>	Enter "5" for <i>Low Low Alarm at 5.000 m</i> .

With process control equipment disabled, enter the RUN mode to monitor system performance and alarm programming. Otherwise, perform a Reading Measurement simulation (P920).

When satisfied with system performance and programming:

- connect a high alarm indicator to Relay #1 (see P100 = 4).
- connect a low alarm indicator to Relay #2.
- connect a high high alarm indicator and filling equipment stop/start control to Relay #3.
- connect a low low alarm indicator to Relay # 4.

(Note that relays are de-energized in "power off" and "alarm" conditions).

For cement applications (or any very dusty dry solids), measurement difficulties during vessel filling are common. For this example (assume the maximum filling rate), failsafe operates as follows.

e.g.

09:15 am	Echo lost at 6.00 m, low alarm is still on, failsafe countdown begins.		
09:17 am	Failsafe activated,	actual level = 6.16 m,	reported level = 6.00 m.
09:57 am	Low alarm off,	actual level = 9.36 m,	reported level = 10.00 m.
12:27 pm	High alarm on,	actual level = 21.36 m,	reported level = 25.00 m.
12:47 pm	Infeed stopped,	actual level = 22.96 m,	reported level = 27.00 m.

When the dust settles (and the echo is regained) the reported level advances toward the actual level. When the reported level reaches 25.55 m (5% of Span less than the high high alarm trip point), the high high alarm goes off, restarting the infeed and filling the vessel to 27.00 m.

Material Volume

To perform a volume conversion for the preceding example, we'll assume:

- the vessel is cylindrically shaped with a flat bottom.
- the vessel volume for Empty to 29.01 m (Span) is 1457 m³.

Volume Parameter Settings

Number	Description	Instructions
P050	Tank Shape	Enter "1" for <i>vertical cylinder with flat bottom</i> .
P051	Max Volume	Enter "1457" for 1457 m ³ .

Now in the RUN mode the Reading represents material volume in m³.

Example 2 - Space Measurement

This mode of operation is commonly used when remaining vessel capacity is of more importance to the installation than the actual material level.

Space

For this example we'll assume the following:

- the vessel is a 3 ft diameter by 15 ft long cylinder (including the parabolic ends of 1.5 ft each).
- the maximum vessel filling rate is 1 ft per minute (slower at mid level).
- a mA output scaled from 4 mA at Full to 20 mA at Empty is required for PLC operation.
- in the event of a measurement difficulty, failsafe operation is to be activated in 6 seconds.
- if the difficulty doesn't subside, the mA output must immediately assume 22.00 mA.
- an XCT-8 transducer is mounted in a standpipe so that the face is 18 in. above the vessel top.
- a TS-3 temperature sensor is mounted in the vessel to monitor liquid temperature.

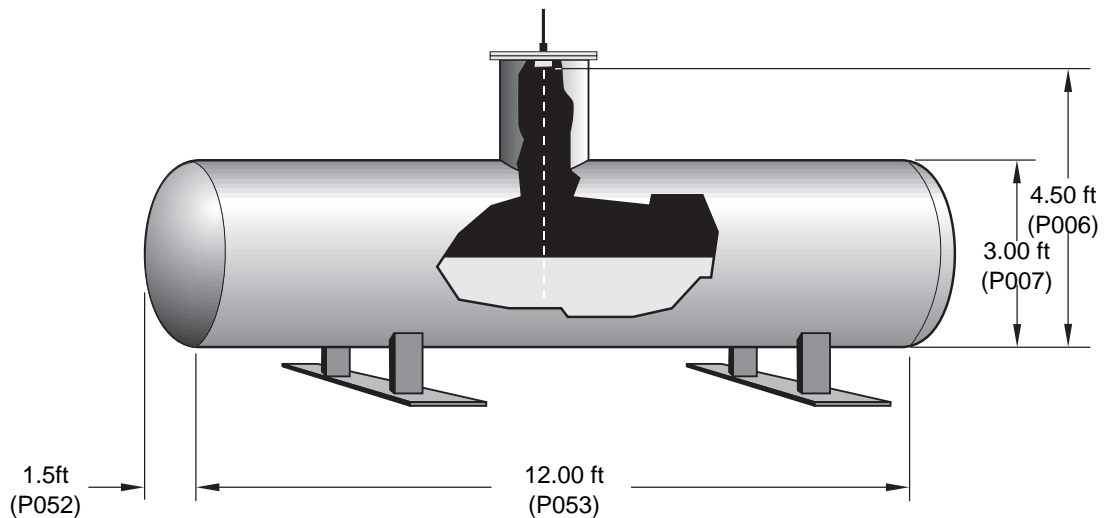

Parameter Settings

Number	Description	Instructions
P001	Operation	Enter "2" for <i>space</i> .
P002	Material	No entry required (preset for <i>liquid</i>).
P003	Measurement Response	Enter "4" for <i>surge</i> (100 m/min, Failsafe Timer = 0.1 minutes).
P004	Transducer	Enter "101" for <i>XCT-8</i> .
P005	Units	Enter "4" for <i>feet</i> .
P006	Empty	Enter "4.5" for <i>4.50 ft</i> (3 feet diameter plus 1.5 ft in standpipe).
P007	Span	Enter "3" for <i>3 ft</i> (vessel diameter).
P070	Failsafe Timer	No entry required, (preset by P003).

Parameter Settings for mA Output

Number	Description	Instructions
P200	mA Range	No entry required. (preset for <i>20 mA = low level</i> , P001 = 2.)
P213	mA Max Limit	Enter "22" for <i>22.00 mA</i> .
P219	mA Failsafe	Enter "20.2" for <i>20.20 mA</i> .

Parameter Setting for Temperature Averaging

Number	Description	Instructions
P660	Temp Source	Enter "5" for average <i>XCT-8</i> and <i>TS-3</i> temperatures.

With process control equipment disabled, enter the RUN mode to monitor system performance and alarm programming. (A Reading Measurement simulation (P920) may be performed to verify mA output programming).

When satisfied with system performance and programming, connect the mA output to the Programmable Logic Controller (PLC).

Note that on "power off" the mA output drops to 0.00 mA. During a power interruption, the "last known" mA output value is maintained in memory for 1 hour minimum. If power is interrupted beyond 1 hour, on power resumption, the mA output immediately assumes the "new value".

Remaining Vessel Capacity

To perform a volume conversion for the preceding example, complete the following programming.

Volume Parameter Settings

Number	Description	Instructions
P050	Tank Shape	Enter "7"* for <i>horizontal cylinder with parabolic ends</i> .
P051	Max Volume	Enter "117" for <i>117 cubic feet</i> (Use vessel fabricators value).
P052	Tank Dimension A	Enter "1.5" for <i>1.5 ft</i> (the horizontal length of one parabolic end).
P053	Tank Dimension L	Enter "12" for <i>12 ft</i> (the horizontal length, excluding parabolic ends).

* This is the only tank shape where the Span (P007) value must exactly equal the vessel height.

Now in the RUN mode, the Reading Value and mA output will represent remaining vessel capacity in cubic feet. If the mA output is still to be scaled to "space" (distance from material to Full in feet) set the mA Function (P201) to "2".

Application Assistance

The preceding examples describe only two ways in which the SPL can be applied to process measurement requirements.

The SPL can be used to monitor almost any process (within the temperature, measurement range, and chemical immunity capabilities of the system) where a distance measurement or determination of presence vs. lack of presence of an object is desired.

By thoroughly reviewing the Parameters sections, you may identify some interesting ways of using the SPL to monitor specific processes.

Milltronics has many years experience applying ultrasonic level measurement to a variety of processes in the mining, aggregate, lumber, grain, chemical, pulp and paper, water, and waste water industries.

If you encounter a difficulty applying the SPL to a process measurement requirement, or successfully apply the SPL to a "unique process" we may have never considered, contact Milltronics or your local distributor.

Communication Support

The SPL provides digital communication to a peripheral device, such as a computer or PLC, in one of three modes via the communication port, terminals 26 through 32. The mode of communication is established by the configuration of the connection made at the SPL, RS-232, RS-485 or bipolar current loop.

The SPL utilizes *simplex convention* communication protocol. Data messages are continuously transmitted at regular intervals (no poll is required) at 4800 baud. All data is transmitted in structured messages of ASCII characters consisting of 8 data bits, no parity, and 1 stop bit.

If Peripheral Communications (P740) is set for "formatted" messages, a comma is inserted between each message field (except immediately preceding the "End of Message" characters).

MT-00 Measurement Message

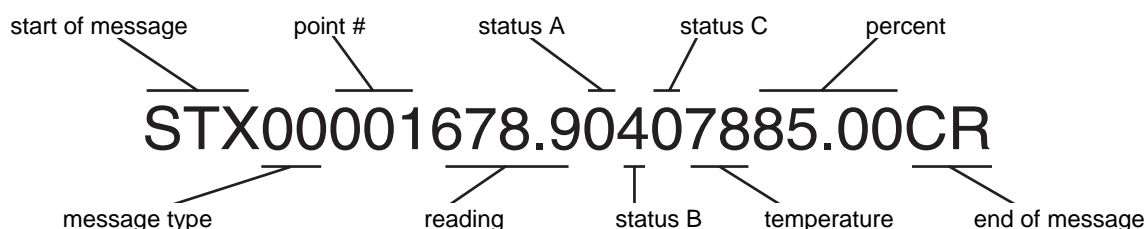

Field Name	Definition
Start Of Message	STX (\$02)
Message Type	2 characters, 00 (indicates the following data pertains to a scan point measurement)
Point #	3 characters, 001 to 003 (e.g. the message pertains to Point Number 1)
Reading	5 characters, 0.000 to 9999. (e.g. reading = 678.9, DDDD. = no data, EEEE. = overflow)

Status A

1 character, \$0 to \$F (convert to binary, e.g. temp, echo, and cable OK, not priority)

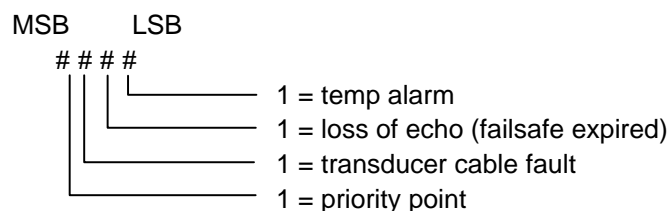

Status B

1 character, \$0 to \$F (convert to binary, e.g. scan point is in high alarm)

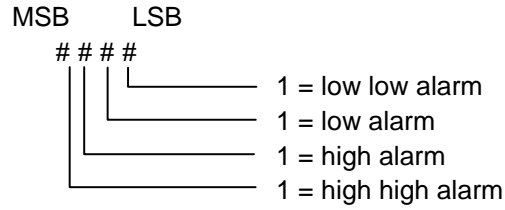

Status C

1 character, \$0 to \$F (convert to binary, e.g. scan point is not in rate or band alarm)

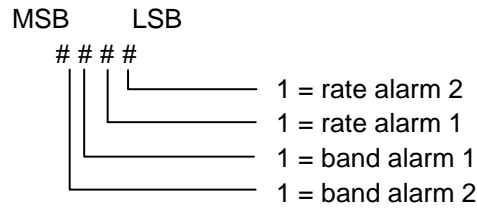

Field Name	Definition
Temp	2 characters, \$32 to \$FA (convert to decimal and subtract 100, e.g. temperature = 20 °C)
Percent	5 characters, 00.00 to 9999. (e.g. current level = 85.00% of span, EEEE. = field overflow)
End Of Message	CR (\$0D)

MT-01 Hold Message

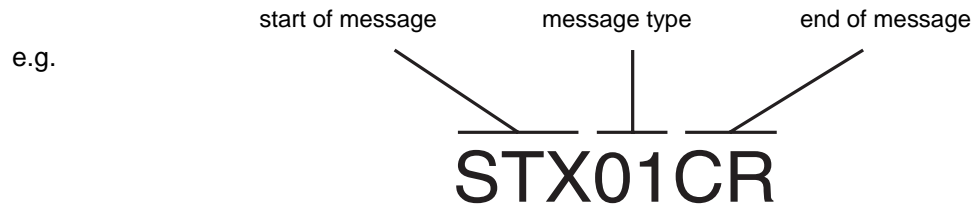

Field Name	Definition
Start Of Message	STX (\$02)
Message Type	2 characters, 01 (indicates the SPL was removed from the RUN mode)
End Of Message	CR (\$0D)

MT-03 Point Not Scanned

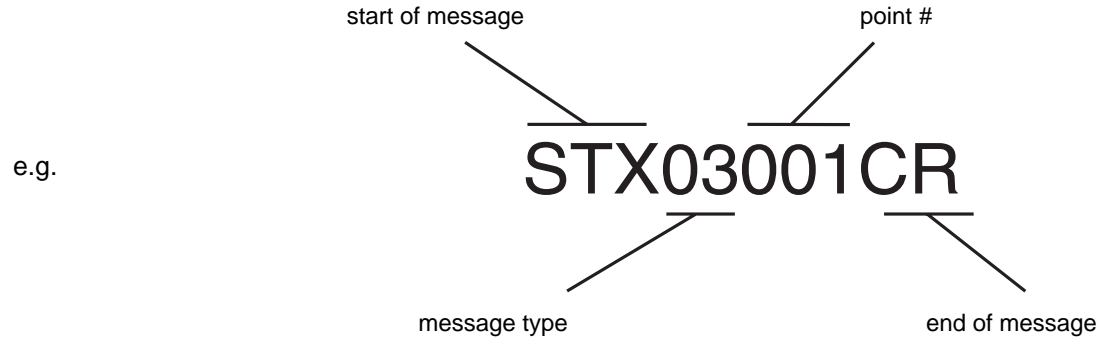

Field Name	Definition
Start Of Message	STX (\$02)
Message Type	2 characters, 03 (indicates the Point Number is not in service)
Point #	3 characters, 001 to 003 (e.g. Point Number 1)
End Of Message	CR (\$0D)

Maintenance

The SPL should require no maintenance or cleaning, though good housekeeping practices in and around the area of the enclosure are recommended.

Wipe out the area of the enclosure lid docking bay recess with a clean dry cloth (if necessary) before installing the programmer.

Transducer inspection, to verify the effectiveness of the self cleaning design, is recommended. If material build up on the transducer face is observed, to maintain maximum system performance, a schedule of regular cleaning should be adopted.

Troubleshooting Guide

Symptom	Cause	Action
Display blank, Transmit Neon not flashing, transducer not pulsing	No power	Check Power supply, wiring, and voltage switch.
No response to programmer.	Obstructed infrared interface, or defective programmer	Clean enclosure “docking bay” and programmer magnet slot.
Displays “Short” and “tb:(#)”.	Short circuited transducer cable or defective transducer.	Repair or replace as necessary.
Displays “Open” and “tb:(#)”.	Transducer not connected	Connect transducer, or remove from service (P001=0).
	Open circuited transducer cable, or defective transducer.	Repair or replace as necessary
Displays “Error” and “tb:(#)”.	Transducer connected wrong Wrong transducer (P004)	Reverse BLK and WHT wires Enter correct value
Displays “LOE”.	Weak or non-existent echo.	Relocate and/or re-aim transducer at material level or object. Proceed to Measurement Difficulties.
Displays “EEEE”.	Reading too high.	Select larger Units (P005), or lower Convert Reading (P061).
Reading fluctuates while material level is still, (or vice versa).	Incorrect measurement stabilization.	Alter measurement Response (P003) accordingly. See Technical Reference / Measurement Response.
Reading is fixed, regardless of the actual material level.	Transducer beam obstructed, standpipe too narrow, or transducer mounting resonant.	Relocate and/or re-aim transducer at material level or object Proceed to Measurement Difficulties.
Material level reported is always “off” by the same amount.	Incorrect Empty (zero) reference.	See Empty (P006), Reading Offset (P063), Offset Calibration (P650), and Offset Correction (P652).
Measurement accuracy improves as level nears transducer.	Incorrect Sound Velocity used for distance calculation.	use an ultrasonic/temperature transducer or a TS-3 temperature sensor. See Technical Reference Sound Velocity.
Reading is erratic, with little or no relation to material level.	True echo too weak or wrong echo being processed.	Relocate and/or re-aim transducer at material level or object Proceed to Measurement Difficulties.

Measurement Difficulties

If a measurement difficulty occurs for greater than the Failsafe Timer (P070) setting, "LOE" is flashed alternately with the Reading display. Under certain conditions, a measurement difficulty may cause the SPL to "lock on" to a false echo and report a fixed or wrong reading.

Flashing "LOE" Display

If "LOE" is displayed, ensure that the:

1. Material (object) surface monitored is within the maximum range of the transducer.
2. Transducer (P004) value matches the transducer used.
3. Transducer is located and aimed properly.

(See the Transducer manual for maximum range, mounting and rough aiming instructions.)

For optimum performance, adjust the transducer aiming while monitoring the Echo Confidence (P805) for various material levels over the measurement range. When complete, set the transducer aiming at the best angle for all levels.

To display Echo Confidence in the RUN mode:

Press  and hold for 4 seconds (Failsafe Time Left changes to the Short : Long Confidence display).

To display Echo Confidence in the program mode, access the Echo Confidence (P805) parameter.

To update the value displayed after each aiming adjustment...

Press  (5 times or more to verify stability)

If the condition persists (despite optimum aiming), optimize transducer performance. (See Enhancement Parameters Short Shot Frequency, P840 and Long Shot Frequency, P841).

Increase the Failsafe Timer (P070) value, if failsafe operation will not be compromised by the larger value.

If "LOE" is displayed only when a sloped bottom vessel is near Empty, the echo is probably being reflected away from the transducer. Install an empty "target plate" in the bottom of the vessel. When exposed (not covered by material), the target plate provides the reflective surface representative of an empty vessel.

Install a longer range transducer, enter the new Empty (P006) distance, and (if necessary) optimize aiming and frequency again.

If a longer range transducer is not available, connect an oscilloscope to the SPL, (see Enhancement Parameters Scope Displays, P810).

If a discernible echo is observed (representative of the material/object surface), reduce the Confidence Threshold (P804) while taking new measurements (in the RUN or program mode).

Sometimes, material simply cannot be detected during vessel filling. In these cases, set up failsafe operation such that the SPL "anticipates" the rate of material level increase and adjusts the reported Reading accordingly. This operation is reliable, as long as when the dust (or foam) settles a valid echo can be received. See Technical Reference Application Examples \ Example 1 - Level Measurement.

Fixed Reading

If the Reading is a fixed value, regardless of the transducer to material (object) surface distance, ensure the:

1. Transducer sound beam is free from obstruction.
2. Material (object) surface monitored is not within the Transducers' nearest measurable distance.
3. Transducer is not in contact with any metal object.
4. Material agitator (if used) is "on" while the SPL is operating.

If the fixed Reading represents a distance more than 3 metres (9 feet) from the transducer face, the SPL is probably detecting some vessel interior obstruction. Aim away from (or remove) the obstruction.

If the obstruction cannot be removed or avoided, the SPL *TVT* (Time Varying Threshold) Curve must be modified to reduce the Echo Confidence derived from the sound reflected by the obstruction. (See Enhancement Parameters Scope Displays, P810 and TVT Shaper, P832).

If the fixed Reading represents a minimal distance from the transducer face, the condition may be caused by a sound beam obstruction (check for this first), but could also be due to other factors.

If the material (object) surface is within the Transducers' *nearest distance* (see Installation Transducer Mounting), mount the transducer higher above (farther away from) the nearest object to be monitored.

If the transducer is mounted on a standpipe, grind smooth any burrs or welds on the inside or *open end* (the end that opens into the vessel). If the problem persists, install a larger diameter or shorter length standpipe, or *flare* (increase the diameter of) or cut the open end of the standpipe at a 45° angle.

For "ST-series" transducers only, ensure the non-metallic mounting hardware (supplied) is used. Often, loosening over tightened mounting hardware will mechanically isolate the transducer from a resonant metallic surface.

Regardless of the mounting type, if difficulties persist, optimize the Transducer operating frequencies (see Enhancement Parameters Short Shot Frequency (P840) and Long Shot Frequency (P841)).

If the preceding remedies have not produced satisfactory results, the false echo has to be ignored. Extend Near Blanking (P800) to a distance (from the transducer face) to just beyond the distance represented by the Reading. This also increases the nearest distance the material level/object may come within the transducer face and still be detected.

If increasing Near Blanking is unacceptable (the transducer cannot be mounted higher) see Auxiliary Transducer (P725). Otherwise, the TVT Curve must be raised in the area of the false echo.

Connect an oscilloscope to the SPL, (see Enhancement Parameters Scope Displays, P810). Adjust the TVT Start Min (P833), TVT Start Duration (P834), and TVT Slope Min (P835) slightly.

Continue making minor TVT Curve adjustments and taking new measurements while observing the Echo Marker position until the Echo Lock Window repeatedly locks onto the true echo. Verify the false echo is still ignored, regardless of the vessel material level, or empty/fill activity.

Wrong Reading

If the Reading is erratic, or jumps to some incorrect value periodically, ensure the:

1. Material (object) surface monitored, is not beyond the transducers maximum range.
2. Material is not falling in the transducer sound beam.
3. Material (P002) value matches the material monitored.
4. Measurement Response (P003) is not set too fast.
5. Transducer (P004) type entered matches the transducer used.

If the periodic incorrect value is always the same, see Fixed Reading. If the incorrect value seems to be random, verify the material surface to transducer distance is less than the Empty value entered plus 20%. If the material/object monitored is outside this distance, increase Range Extension (P801) as required.

If the material monitored is a liquid, check for splashing in the vessel. Decrease Measurement Response (P003) as required to stabilize the Reading, or install a stilling well (contact Milltronics or your local distributor).

Access the Noise (P807) parameter. If the peak value jumps wildly, verify the transducer cable shields are connected to the SPL shield terminals and not to ground elsewhere.

If the SPL is mounted in close proximity to (or transducer cables run near those of) another ultrasonic level monitor, see Level System Sync (P726).

Temporarily disable nearby SCR control drives, high voltage or current contactors. If the condition disappears, move the SPL to another location.

Set Echo Lock (P711) to "max verification" (response to material level changes may be slowed somewhat).

Increase the Confidence Threshold (small amounts at a time) while observing the results. If performance is not improved return the Confidence Threshold to the preset value.

Connect an oscilloscope to the SPL, (see Enhancement Parameters Scope Displays, P810). While monitoring the Echo Marker, select the Algorithm (P820) best suited to the material/conditions.

If the "Area" algorithm is used and narrow noise spikes are evident on the (long shot) Echo Profile, turn the Spike Filter (P821) on and/or widen the Narrow Echo Filter (P822). Also, if the true echo has jagged peaks, use Reform Echo (P823).

If multiple echoes appear on the Echo Profile, typical of a flat material profile (especially if the vessel top is domed), use the "first" Algorithm.

If the Echo Profile repeatedly switches from short to long, adjust the Short Shot Range (P852) to stabilize the "shot" mode used for the echo evaluation. Also, adjust the Short Shot Bias to increase (or decrease) the amount of preference given to short shot echoes over long shot echoes.

Should a stable measurement still not be attainable, contact Milltronics or your local distributor.

Programming Chart

#	Parameter Name	Altered Values for Point numbers.		
		1	2	3
Security				
P000	Lock (G)			
Quick Start				
P001	Operation			
P002	Material			
P003	Measurement Response			
P004	Transducer			
P005	Units (G)			
P006	Empty			
P007	Span			
Volume				
P050	Tank Shape			
P051	Max Volume			
P052	Tank Dimension A			
P053	Tank Dimension L			
P054	Level Breakpoints			record values on a separate sheet.
P055	Breakpoint Volumes			record values on a separate sheet.
Reading Value				
P060	Decimal Position			
P061	Convert Reading			
P062	Offset Reading			
Failsafe				
P070	Failsafe Timer			
P071	Failsafe material Level			
P072	Failsafe Level Advance			
Relays				
P100	Relay Set Up (G)			
P101	Hi Alarm			
P102	Lo Alarm			
P103	Hi Hi Alarm			
P104	Lo Lo Alarm			
P111	Relay Function			
P112	Relay A Setpoint			
P113	Relay B Setpoint			
P116	Bound Alarm Deadband			
P129	Relay Failsafe			

Programming Chart

#	Parameter Name	Altered Values for Point numbers.		
		1	2	3
mA Outputs				
P200	mA Range			
P201	mA Function			
P203	mA Value / Transducer (V)			
P210	0/4 mA Setpoint			
P211	20 mA Setpoint			
P212	mA Min Limit			
P213	mA Max limit			
P214	4 mA Trim			
P215	20 mA Trim			
P219	mA Failsafe			
Data Logging				
P300	Temp, Transducer max (V)			
P302	Temperature, Sensor max (V)			
P330	Profile Record			
P331	Auto Record Enable (G)			
P333	Auto Record Interval (G)			
P334	Auto Record A Setpoint			
P335	Auto Record B Setpoint			
P336	Auto Record Filling/Emptying			
P337	Auto Record LOE Time			
Installation Records				
P340	Date of Manufacture			
P341	Run Time			
P342	Start Ups			
Range Calibration				
P650	Offset Calibration			
P651	Sound Velocity Calibration			
P652	Offset Correction			
P653	Velocity			
P654	Velocity @ 20° C			
Temperature Compensation				
P660	Temp Source			
P661	Temp fixed			
P664	Temperature (V)			

Programming Chart

#	Parameter Name	Altered Values for Point numbers.		
		1	2	3
Rate				
P700	Max Fill Rate			
P701	Max Empty Rate			
P702	Filling Indicator			
P703	Emptying Indicator			
P704	Rate Filler			
P705	Rate Update Time			
P706	Rate Update Distance			
P707	Rate Value (V)			
Measurement Verification				
P710	Fuzz Filter			
P711	Echo lock			
P712	Reserved			
P713	Echo lock Window			
Scanning				
P726	Level System Sync (G)			
P728	Shot Delay (G)			
P729	Scan Time			
Display				
P730	Auxiliary Reading (G)			
P731	Auxiliary Reading Key (G)			
P732	Display Delay (G)			
P733	Scroll Access (G)			
Peripheral Communication Support				
P740	Peripheral Communications (G)			
P748	RS485 Termination			
P749	Serial Bus Type			
Smartlinx®				
P790	Hardware Error			
P791	Bus Error			
P792	Bus Error Count			

Programming Chart

#	Parameter Name	Altered Values for Point numbers.		
		1	2	3
Echo Processing				
P800	Near Blanking			
P801	Range Extension			
P802	Submergence Transducer			
P803	Shot/Pulse Mode			
P804	Confidence Threshold			
P805	Echo Confidence (V)			
P806	Echo Strength (V)			
P807	Noise (V)			
Advanced Echo Processing				
P810	Scope Displays			
P816	Echo Time			
P817	Profile Pointer Time			
P818	Profile Pointer Distance			
P819	Profile Pointer Amplitude			
P820	Algorithm			
P821	Spike Filter			
P822	Narrow Echo Filter			
P823	Reform Echo			
P824	(reserved)			
P825	Echo Marker Trigger			
P830	TVT Type			
P831	TVT Shaper			
P832	TVT Shaper Adjust			record values on a separate sheet
P833	TVT Start Min			
P834	TVT Start Slope			
P835	TVT Slope Min			
P840	Short Shot Number			
P841	Long Shot Number			
P842	Short Shot Frequency			
P843	Long Shot Frequency			
P844	Short Shot Width			
P845	Long Shot Width			
P850	Short Shot Bias			
P851	Short Shot Floor			
P852	Short Shot Range			

www.milltronics.com

MILLTRONICS

Siemens Milltronics Process Instruments Inc.
1954 Technology Drive, P.O. Box 4225
Peterborough, ON. Canada K9J 7B1
Tel: (705) 745-2431 Fax: (705) 741-0466
www.milltronics.com

© Siemens Milltronics Process Instruments Inc. 2001
Subject to change without prior notice



Printed in Canada