



**NO-FROST REFRIGERATOR-FREEZER  
MODEL ET16AKXL**

# Use and Care Guide

**Please read this Use and Care Guide before you do anything else...**

This booklet tells you how to start your refrigerator, clean it, move shelves and adjust controls. It even tells you what to do if you hear strange sounds or think something is wrong.

Treat your new refrigerator with care. Use it only to do what home refrigerators are designed to do.

## Safety First

**Child entrapment, and suffocation, are not things of the past. Junked or abandoned refrigerators are still dangerous...even if they will "just sit in the garage a few days." If you are getting rid of your old refrigerator, do it safely. Please read the enclosed safety booklet from the Association of Home Appliance Manufacturers. Help prevent accidents.**

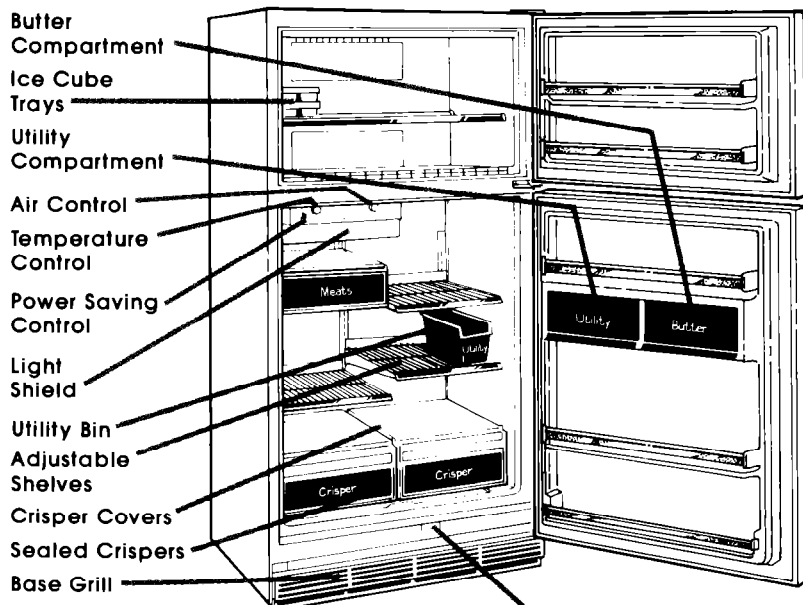

Model and Serial Number Plate

## Copy Your Model Number and Serial Number Here

If you have to call for service, the service technician will ask for your Model and Serial Numbers. Your refrigerator has these numbers on a plate just above the base grill. Copy them in the spaces below while you are thinking about it.

Keep this book in a handy place. Your warranty and sales slip should be kept with it.

Model No.	_____
Serial No.	_____
Purchase / Installation Date	_____

# Before you plug it in

## IMPORTANT

Before using your refrigerator, you are personally responsible for making sure that it...

- is installed and leveled on a floor that will hold the weight, and in an area suitable for its size and use.
- is connected only to the right kind of outlet, with the right electric supply and grounding.
- is used only for jobs expected of home refrigerators.
- is properly maintained.
- is out of the weather
- is used in an area where the room temperature will not fall below 55° F (13° C).
- is not run where there are explosive fumes.
- is not used by children or others who may not understand how it should be used.
- is not loaded with food before it has time to get properly cold.

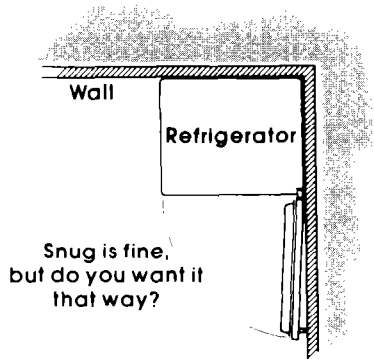

## Pick the Right Place.

Save steps by putting your refrigerator near the sink and next to a countertop. It **should not** be near a stove, radiator, water heater or any source of heat...including direct sunlight.

You can install it flush against the wall in back. Leave ½ inch (1.3 cm) clearance against cabinets on each side for ease of installation. Do you want it in a corner? Leave some room on the wall side if you want the doors to open wider.

Planning to add the automatic ice maker? Will the refrigerator be near a cold water pipe? Some people run the water line through the floor to the basement. Others run it behind the cabinets to the pipes under the sink.

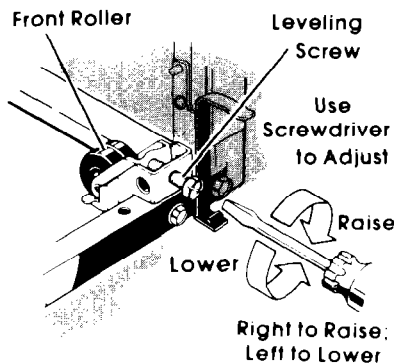

## Make Sure It's Level.

Your refrigerator is on rollers; the two front ones are adjustable for leveling.

Remove the base grill to uncover the leveling screws. With a screwdriver, turn each screw to the right to raise the front. Turn them to the left to lower the front. (If you have someone tilt the top of the refrigerator back while turning, it will be easier.)

Keep adjusting one or the other until the refrigerator won't rock. Then raise or lower both by the same number of turns until the refrigerator is level (use a level to check this). If you don't have a level, the refrigerator will be about right when you can open the doors part way and they will stay where you put them.

## Peel Off the Labels.

Remove the Consumer Buy Guide label and other inside labels before using the refrigerator. Any glue left can be taken off with rubbing alcohol.

**Do not remove the Tech Sheet fastened behind the base grill.**

## Wash It.

To clean your refrigerator before using it, check the washing instructions in this booklet.

## Plug It In.

A 120 Volt, 60 Hz., AC only, 15 ampere fused electrical supply is required. It is recommended that a separate circuit serving only this appliance be provided.

Do not use an extension cord. **Use a receptacle which cannot be turned off with a switch or pull chain.**

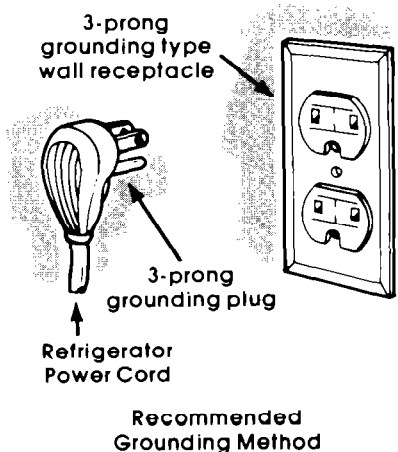

# Cleaning your refrigerator

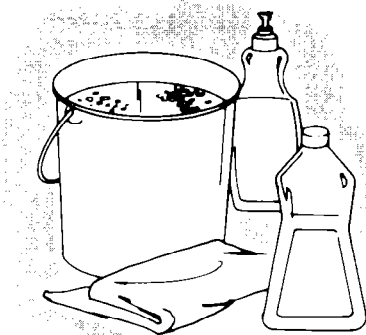

Both the refrigerator and freezer sections defrost automatically. But both should be cleaned about once a month to help prevent odors from building up. Of course, spills should be wiped up right away.

To clean your refrigerator, unplug it, turn the Temperature Control to OFF, take out all removable parts, and clean it according to the following directions.

## Inside.

You can wash the parts you take out in the sink with a **mild** soap or **mild** detergent and warm water. Harsh cleansers, scouring powders and solvents should **never** be used on any part of your refrigerator.

Wash the walls with a solution of two tablespoons (30g) of baking soda mixed with one quart (1L) of warm water. Rinse well and dry. Let the freezer warm up with the door open for 10 or 15 minutes so the cloth doesn't stick.

The inside of the door, including the gasket, should be washed with warm water and a mild soap or mild detergent.

Do not use cleaning waxes, concentrated detergents, bleaches or cleansers containing petroleum products. They can damage the gasket and plastic finish.

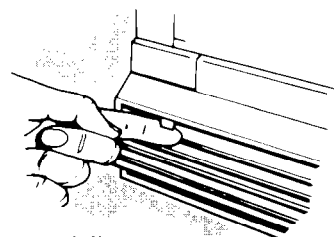

Lift Up the Grill-holding Tabs

## Outside.

Wash the outside with warm water and a mild detergent. Rinse well and dry.

Waxing is recommended in high humidity areas. Use a good auto paste wax or an appliance wax on painted metal surfaces. Do not use on plastic because it may damage these parts.

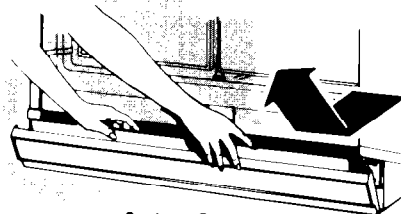

Swing Out; Lift Up

## Underneath.

To remove the base grill, open the door and lift up on the two tabs that show through the grill at both ends near the top. When you've lifted the tabs, swing the top of the grill forward. Lift the grill off the bottom supports.

The defrost water pan is on the left and the condenser is on the right. Pull out the defrost pan and wash. There may be tape holding it in place. Remove the tape and lift the pan over the wire brace in front of it. Make sure the notched corner is in the rear when you put it back, and that you push it all the way in. The defrost drain tube should point into the pan.

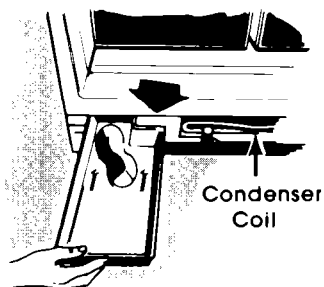

Notice the Notched Corner on the Defrost-water Pan

Clean dust from the condenser with a vacuum cleaner. The condenser should be cleaned every two or three months.

If your refrigerator has an ice maker, make sure you don't slide the refrigerator out farther than the ice-maker water supply line allows.

Heat is removed from your refrigerator and transferred to the condenser. From there, the heat is spread into the room. Dust on the condenser insulates it and reduces the heat leaving it. If the heat can't get out easily, the refrigerator will have to run longer to keep food cold.

## Energy Saving Tips

You can help your refrigerator use less electricity.

- Check door gaskets for a tight seal. Level the cabinet to be sure of a good seal.
- Clean the condenser coil regularly.
- Open the door as few times as possible. Think about what you need before you open the door. Get everything out at one time. Keep foods organized so you won't have to search for what you want. Close door as soon as food is removed.
- Go ahead and fill up the refrigerator, but don't overcrowd it so air movement is blocked.

- It is a waste of electricity to set the refrigerator and freezer to temperatures colder than they need to be. If ice cream is firm in the freezer and drinks are as cold as your family likes them, that's cold enough.
- Keep the Power Saving Control on OFF unless moisture forms on the refrigerator exterior.
- Make sure your refrigerator is not next to a heat source such as a range, water heater, furnace, radiator, or in direct sunlight.

# Using your refrigerator

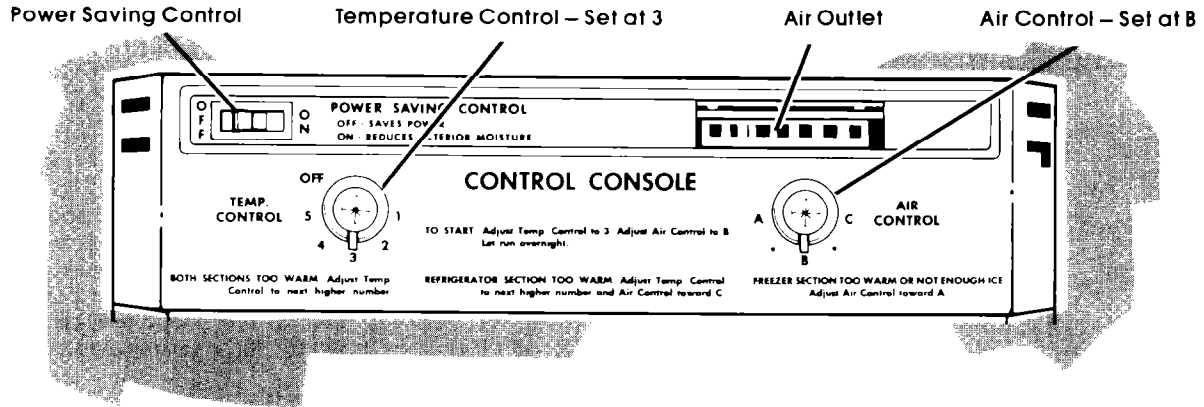

## Setting the Controls.

The Temperature Control and Air Control dials are on a console inside the refrigerator. To start the refrigerator, turn the TEMP. CONTROL dial to 3 and the AIR CONTROL dial to B. These are normal settings.

It takes time for your refrigerator to reach proper storage temperatures. When you first turn it on, it will run continuously until the interior gets properly cold. Before loading with food, be sure the refrigerator has cycled at least once (turned on, turned off, and on again). Controls will be set about right if your milk or juice is as cold as your family likes it, and when ice cream is firm.

The control console has directions for raising or lowering the temperatures, if needed.

## Power Saving Control.

The Power Saving Control inside your refrigerator controls electric heaters. These heaters help prevent moisture from forming on the outside of the refrigerator when humidity is high. Use the OFF setting when humidity is low. Use ON if moisture forms on the outside of the refrigerator.

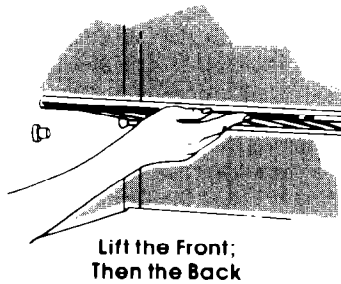

## Removing Non-Adjustable Shelves.

To remove a shelf, lift up the front. Then lift up at the back. To replace it, put the rear notches onto the shelf supports. Lower the front into place.

## Sounds you may hear.

Your new refrigerator may make sounds that your old one didn't. Because the sounds are new to you, you might be concerned about them. Don't be. Most of the new sounds are normal. Hard surfaces like the

floor, walls and metal cabinets can make the sounds seem louder.

The following chart describes the kinds of sounds that might be new to you, and what may be making them.

### Possible Sounds:

- Slight Hum; Soft hiss:
- Clicking or Snapping Sounds:
- Water Sounds:
- Ice Maker Sounds:
- Running Sounds:

### Probable Causes:

- Your refrigerator has two fans; you may hear the fan motors and moving air.
- The defrost timer makes a definite click when the refrigerator stops running. It also makes a sound when the refrigerator starts.
- When the refrigerator stops running, you may hear gurgling in the tubing for a few minutes after it stops. You may also hear defrost water running into the defrost water pan.
- If your refrigerator has an ice maker, you may hear a buzzing (from the water valve), trickling water and the clatter of ice dumped into the bin.
- Your refrigerator has a high-efficiency compressor and motor. It will run longer than older designs. It may even seem to run most of the time.

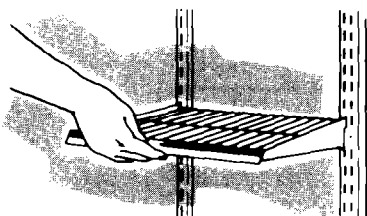

Tilt the Front;  
Lift the Back

### Adjusting the Shelves and Meat Pan.

Arrange your refrigerator shelves and meat pan to suit yourself. You can put two shelves together to make one full-width shelf, or put them on different levels.

To remove them, tilt up at the front. Then lift up at the back. When replacing them, keep them tilted; guide the rear hooks into the slots in the shelf bracket. Lower the front.

Before moving the meat pan itself, remove the pan by pulling it out, lifting the front and then pulling out the rest of the way.

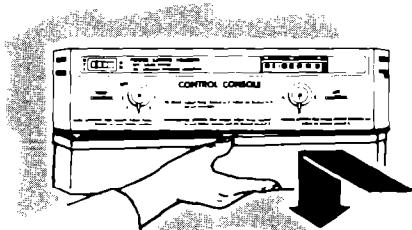

Push in the Center;  
Pull Down

### Reversing the Door Swing.

You can change the hinges on your refrigerator so the doors open the other way. If you rearrange your kitchen or move your refrigerator to a new kitchen, you might like your doors to open the other way. Refer to the enclosed instruction sheet.

### Removing the Light Shield.

You may want to remove the light shield when cleaning, or for changing the bulb. First, unplug the refrigerator. Then, push lightly on the upper center of the shield until the notched tab is free from the console. Pull down until the tab clears, then lift the back hooks out of their slots.

To replace it, do the reverse.

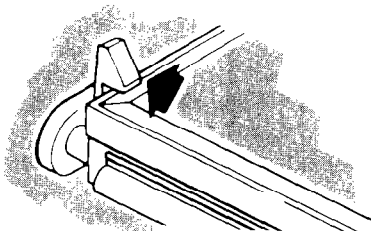

Push the Tab  
to Clear the Cover

### Removing the Crispers and Crisper Covers.

To remove the crispers, slide them out until they stop. Lift the front a little and slide them the rest of the way out.

Each cover is held in place by two pegs at the back and two notched tabs in the front. Press the tabs out of the way to lift the front. Lift the back off the pegs.

To put the covers back, replace the center leg. Replace each cover by first fitting the back notches over the pegs. Then push the front down into the notched tabs.

The center leg can be made shorter or longer to help level the crisper covers, if necessary. Turn the leg clockwise to make it longer. Turn it counter-clockwise to shorten it.

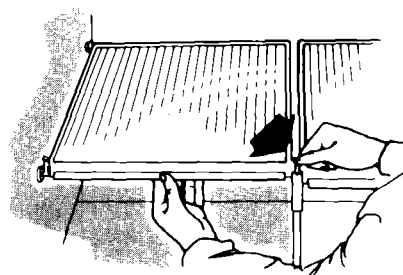

Snap Back Into Place

### ICE MAGIC<sup>®</sup> Automatic Ice Maker.

If you have the automatic ice maker accessory or plan to add one later (Part No. ECKMF-6), there are a few things you will want to know:

- The ON/OFF lever is a wire signal arm.
  - Down...for making ice automatically;
  - Up...to shut off the ice maker.
- Shake the bin occasionally to keep cubes separated, and to obtain increased storage capacity.
- It is normal for ice crescents to be attached by a corner. They will break apart easily.
- You will hear water running when ice maker is working. You'll hear ice fall into the bin. Don't let these sounds bother you.
- The ice maker will not operate until the freezer is cold enough to make ice. This can take overnight.
- Because of new plumbing connections, the first ice may be discolored or off-flavored. Discard the first few batches of ice.
- If ice is not being made fast enough and more ice is needed, turn the Temperature Control toward a higher number. Wait a day and, if necessary, turn the Air Control toward A.
- If you remove the ice bin, raise the signal arm to shut off the ice maker. When you return the bin, push it all the way in and lower the arm to the ON position.
- If cubes are stored too long, they may develop an off-flavor...like stale water. Throw them away. They will be replaced. Cubes in the ice bin can also become smaller by evaporation.

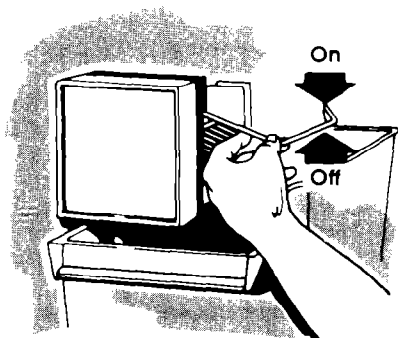

Raise Signal  
Arm to Stop Ice Maker.  
Lower Signal  
Arm to Start It.

## Vacation and moving care

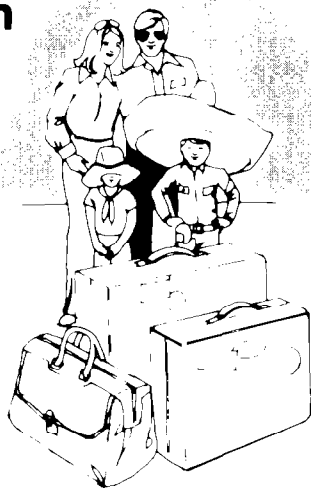

### Short Vacations.

No need to shut off the refrigerator if you will be away for less than four weeks. Use up perishables; freeze other items. If your refrigerator is equipped with an automatic ice maker, 1) turn it off; 2) shut off the water supply to the ice maker; 3) empty the ice bin.

### Long Vacations.

Remove all the food if you are going for a month or more. If your refrigerator is equipped with an automatic ice maker, turn off the water supply to the ice maker at least a day ahead. When the last load of ice drops, turn off the ice maker.

Unplug the refrigerator and clean it...rinse well and dry. Tape rubber or wood blocks to both doors...keeping them open far enough for air to get in. This will keep odor and mold from building up.

---

**Tape the blocks out of a child's reach...do not allow children near the refrigerator when the doors are blocked open.**

---

To restart refrigerator, see "Using Your Refrigerator."

### Moving.

If your refrigerator is equipped with an automatic ice maker, shut off the ice maker water supply a day ahead of time. Disconnect the water line. After the last supply of ice drops, lift the signal arm to turn off the ice maker.

Remove all food. Pack frozen foods in dry ice. Unplug the refrigerator and clean it thoroughly.

Remove everything that comes out. Wrap all parts well and tape them together so they don't shift and rattle.

Screw in the levelling rollers; tape the doors shut; tape the electric cord to the cabinet. When you get to your new home, put everything back and refer to page 2. If your refrigerator has an automatic ice maker, reconnect the water supply.

## Food storage guide

### STORING FRESH FOOD



There is a right way to package and store refrigerated or frozen foods. To keep foods fresher, longer, take the time to study these recommended steps.

**Leafy Vegetables**...Remove store wrapping. Trim or tear off bruised and discolored areas. Wash in cool water, drain and store in crisper. Cold, moist air helps keep leafy vegetables fresh and crisp. The crispers have sealing gaskets to help keep humid air in.

**Vegetables with Skins** (carrots, peppers)...Store in crisper, plastic bags or plastic container.

**Fruits**...Wash, let dry and store in refrigerator in plastic bags or crisper. Do not wash or hull berries until they are ready to use. Sort and keep berries in their store container in a crisper, or store in a loosely closed paper bag on a refrigerator shelf.



**Meat**... Meat is perishable and expensive...you won't want to waste an ounce of it through careless handling. The following list and chart give you packaging hints and time limits. Store meat in the meat pan.

**Fresh, Prepackaged Meat**...Store fresh meat in the store wrapping. Vacuum packaged meat can be frozen for as long as one month if the seal is not broken. If you want to keep it frozen longer, you should wrap it with special freezer wrapping material.

**Fresh Meat, Not Prepackaged**. Remove the market wrapping paper and re-wrap loosely in waxed paper or aluminum foil for storing it unfrozen.

**Cooked Meat**. Wrap or cover cooked meat with waxed paper, plastic wrap or aluminum foil. Store immediately.

**Cured or Smoked Meat and Cold Cuts**. Ham, bacon, sausage, cold cuts, etc., keep best in original wrappings. Once opened, tightly re-wrap in plastic wrap or aluminum foil.

**Canned Ham.** Store in refrigerator unless the label says it's okay to store on the shelf. Do not freeze.

**Fresh Poultry**...Loosely wrap in waxed paper or plastic wrap. The plastic wrap on poultry, as purchased, may be used for storage.

#### STORAGE CHART FOR FRESH AND CURED MEAT\*

Type	Approximate Time (days)
Variety Meats .....	1 to 2
Chicken .....	1 to 2
Ground Beef .....	1 to 2
Steaks and Roasts .....	3 to 5
Cured Meats .....	7 to 10
Bacon .....	5 to 7
Cold Cuts .....	3 to 5

\*If meat is to be stored longer than the times given, follow the directions for freezing.

**NOTE:** Fresh fish and shellfish should be used the same day as purchased.



**Eggs** ... Store without washing in the original carton or use the Utility Bin that came with your refrigerator.

**Milk**... Wipe milk cartons. For best storage, place milk on interior shelf.

**Beverages**...Wipe bottles and cans. Store on a door shelf or inside the refrigerator.

**Butter**...Keep opened butter in covered dish or in the Butter Compartment. When storing an extra supply, wrap in freezer packaging and freeze.

**Cheese** ... Store in the original wrapping until you are ready to use it. Once opened, re-wrap tightly in plastic wrap or aluminum foil.

**Condiments** ... Store small jars and bottles (cat-soup, mustard, jelly, olives) on the door shelves where they are in easy reach.

**Leftovers**...Cover leftovers with plastic wrap or aluminum foil to keep food from drying out and transferring food odors. Plastic containers with tight lids are fine, too.

## STORING FROZEN FOOD

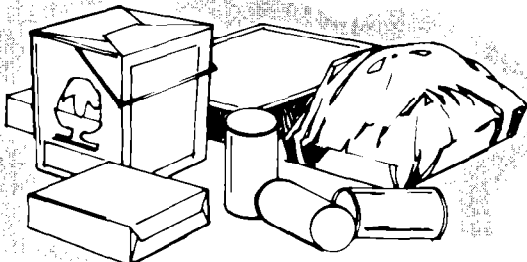

The freezer section is designed for storage of commercially frozen foods and for freezing foods at home.

**Packaging** – The secret of successful freezing is in the packaging. The wrap you use must be air, moisture and vapor proof. The way you close and seal the package must not allow air, moisture or vapors in or out.

Rigid polyethylene (plastic) containers with tight-fitting lids, straight-sided canning freezing jars, heavy-duty aluminum foil, plastic-coated paper and non-permeable plastic wraps (such as saran) are recommended. Note: Heat-sealed boiling bags are easy to use and can be used by themselves or as carton liners.

**IMPORTANT: Do not expect your freezer to quick-freeze any large quantity of food. Leave enough space for air to circulate around packages. Be careful to leave enough room at the front so the door can close tightly.**

#### STORAGE CHART FOR FROZEN FOOD

Storage times given in this chart are only a guide. For best use of freezer space, keep frozen foods for short times. Use, then replace as needed.

Bread .....	2 months
Cooked Dishes .....	2-3 months
Fish and Seafoods	
Fresh .....	6 months
Commercially Frozen .....	1-3 months
Fruits .....	6 months
Ice Cream .....	1 month
Concentrated Juice .....	4-6 months
Meats	
Bacon .....	Less than 1 month
Pork roasts, chops .....	3-4 months
Sausage .....	1-2 months
Beef, veal, lamb roasts .....	6 months
Ground meat .....	1-2 months
Poultry .....	3-4 months
Vegetables .....	6 months

**Ice Cream** ... Store in the freezer. Once the package is opened, place a piece of aluminum foil or waxed paper smoothly against the ice cream surface. This will prevent ice crystals from forming.

**Packaged Frozen Food** ... Store on freezer door shelf or in the freezer. If you plan to store it for a long time, re-wrap it with aluminum foil or plastic wrap.

**Frozen Meats\*** ... The following hints will help keep the quality in your frozen meats:

1. Freeze meat while fresh and in top condition.
2. Use only the recommended wrapping materials.
3. Prepare the meat for freezing before wrapping it. Trim off excess fat and remove bones when practical. Meat should not be salted because salt shortens freezer life.
4. Wrap tightly, pressing out as much air as possible.
5. Label and date it.
6. Refreezing defrosted meat is not recommended.

**Frozen Soups, Juices** ... Store on freezer door shelf or in the freezer.

\* Courtesy of National Live Stock and Meat Board

† Courtesy of U.S.D.A.

# If you need service or assistance, we suggest you follow these four steps:

## 1. Before calling for assistance...

Performance problems often result from little things you can find and fix yourself without tools of any kind.

### If your refrigerator will not operate:

- Is the electric cord plugged in?
- Is a fuse blown or a circuit breaker tripped?
- Is the Temperature Control dial turned ON?

### If your ice maker will not operate:

- Has the freezer had enough time to get cold? With a new refrigerator, this might take overnight.
- Is the signal arm ON...in the down position?
- Is the water valve turned on, and is water getting to the ice maker?

### If there is a rattling or jingling noise, or other unfamiliar sounds:

- Is something on top or behind the refrigerator making noise when the refrigerator is running?
- New features on your new refrigerator make new sounds. You may be hearing air flowing from the fans, timer clicks for the defrosting cycle, defrost water draining into the defrost pan. If you have an ice maker, you will hear water fill the molds and the ice drop into the bin.

### If there is water in the defrost pan:

- In hot, muggy weather, this is normal. The pan can even be half full. Make sure the refrigerator is level so the pan doesn't overflow.

### If the light doesn't work:

- Check fuses and circuit breakers. Make sure it's plugged in.
- The bulb may be burned out. Unplug the refrigerator, remove the light shield, replace the bulb with an appliance bulb no larger than 40 watts. Replace the light shield and plug in the cord.

### If the motor seems to run too much:

- Is the condenser, behind the base grill, free of dust and lint?
- On hot days, or if the room is warm, the motor naturally runs longer.
- If the door has been opened a lot, or if a large amount of food has been put in, the motor will run longer to cool down the interior.

**Remember:** Motor running time depends on different things: number of door openings, amount of food stored, temperature of the room, setting of the controls.

And, your new refrigerator may be larger than your old one so it has more space to be cooled. It also has a regular freezer instead of a frozen food compartment. All this means better refrigeration and may require more running time than your old one.

## 2. If you need assistance\* ...

Call Whirlpool COOL-LINE® service assistance telephone number. Dial free from:

Continental U.S. .... (800) 253-1301

Michigan ..... (800) 632-2243

Alaska & Hawaii ..... (800) 253-1121

and talk with one of our trained Consultants. The Consultant can instruct you in how to obtain satisfactory operation from your appliance or, if service is necessary, recommend a qualified service company in your area.

## 3. If you need service\* ...

Whirlpool has a nationwide network of franchised TECH-CARE® Service Companies. TECH-CARE service technicians are trained to fulfill the product warranty and provide after-warranty service, anywhere in the United States. To locate

TECH-CARE service in your area, call our COOL-LINE service assistance telephone number (see Step 2) or look in your telephone directory Yellow Pages under:

**APPLIANCES—HOUSEHOLD—  
MAJOR—SERVICE & REPAIR**

WHIRLPOOL APPLIANCES  
FRANCHISED TECH-CARE SERVICE

*SERVICE COMPANIES*  
XYZ SERVICE CO  
123 Maple

OR

**ELECTRICAL APPLIANCES—  
MAJOR—REPAIRING & PARTS**

WHIRLPOOL APPLIANCES  
FRANCHISED TECH-CARE SERVICE

*SERVICE COMPANIES*  
XYZ SERVICE CO  
123 Maple

999-9999

OR

**WASHING MACHINES, DRYERS  
& IRONERS—SERVICING**

WHIRLPOOL APPLIANCES  
FRANCHISED TECH-CARE SERVICE

*SERVICE COMPANIES*  
XYZ SERVICE CO  
123 Maple

999-9999

## 4. If you have a problem\* ...

Call our COOL-LINE service assistance telephone number (see Step 2) and talk with one of our Consultants, or if you prefer, write to:

Mr. Guy Turner, Vice President

Whirlpool Corporation Administrative Center  
2000 US-33 North, Benton Harbor, MI 49022

\*If you must call or write, please provide: model number, serial number, date of purchase, and a complete description of the problem. This information is needed in order to better respond to your request for assistance.



FSP is a registered trademark of Whirlpool Corporation for quality parts. Look for this symbol of quality whenever you need a replacement part for your Whirlpool appliance. FSP replacement parts will fit right and work right, because they are made to the same exacting specifications used to build every new Whirlpool appliance.



Benton Harbor, Michigan. Automatic Washers. Clothes Dryers. Freezers. Refrigerator-Freezers. Ice Makers. Dishwashers. Built-in Ovens and Surface Units. Ranges. Microwave Ovens. Compactors. Room Air Conditioners. Dehumidifiers. Central Heating and Air Conditioning Systems.