

Lifting equipment

This NORSOK standard is developed with broad petroleum industry participation by interested parties in the Norwegian petroleum industry and is owned by the Norwegian petroleum industry represented by ~~The~~ Norwegian Oil ~~Industry and Gas~~ Association (~~OLF~~) and The Federation of Norwegian ~~Industry/Industries~~. Please note that whilst every effort has been made to ensure the accuracy of this NORSOK standard, neither ~~OLF~~ ~~the Norwegian Oil and Gas Association~~ nor The Federation of Norwegian ~~Industry/Industries~~ or any of their members will assume liability for any use thereof. Standards Norway is responsible for the administration and publication of this NORSOK standard.

Standards Norway
~~Strandveien 18, P.O. Box 242~~ Telephone: + 47 67 83 86 00
~~N-1326 Lysaker~~ 1326 Lysaker Fax: + 47 67 83 86 01
~~NORWAY~~ NORWAY Email: petroleum@standard.no
~~Visiting address~~ Website:
www.standard.no/petroleum
~~Mustads vei 1, 0283 Oslo~~
Copyrights reserved

Formatert: Engelsk (USA)

Formatert: Engelsk (USA)

Formatert: Svensk (Sverige)

Formatert: Svensk (Sverige)

Formatert: Svensk (Sverige)

Formatert: Svensk (Sverige)

Formatert: Normal, Tabulatorstopp:
17 cm, Høyre

Formatert: Normal

Annex E (Normative) Lifts

Annex F (Normative) Portable units

Annex G (Normative) Cranes

Annex H (Normative) Foundations and suspensions

~~Annex I (Informative) Selection of elastic pennant — calculation example~~ Feil! Bokmerke er ikke definert. 174

Annex J (Informative) Lifting lugs and mating shackles

Annex K (Informative) High risk application

138

Formatert: Engelsk (Storbritannia)

141

Feltkode endret

Formatert: Engelsk (Storbritannia)

159

Feltkode endret

174

Feltkode endret

Formatert: Engelsk (Storbritannia)

197

Formatert: Engelsk (Storbritannia)

Feltkode endret

206206

Formatert: Engelsk (Storbritannia)

Formatert: Engelsk (Storbritannia)

Foreword

The NORSOK standards are developed by the Norwegian petroleum industry to ensure adequate safety, value adding and cost effectiveness for petroleum industry developments and operations. Furthermore, NORSOK standards are, as far as possible, intended to replace oil company specifications and serve as references in the authorities' regulations.

The NORSOK standards are normally based on recognised international standards, adding the provisions deemed necessary to fill the broad needs of the Norwegian petroleum industry. Where relevant, NORSOK standards will be used to provide the Norwegian industry input to the international standardisation process. Subject to development and publication of international standards, the relevant NORSOK standard will be withdrawn.

The NORSOK standards are developed according to the consensus principle generally applicable for most standards work and according to established procedures defined in NORSOK A-001.

The NORSOK standards are prepared and published with support by of The Norwegian Oil ~~Industry and Gas Association (OLF)~~, The Federation of Norwegian ~~Industry/Industries~~, Norwegian Shipowners' Association and The Petroleum Safety Authority Norway.

Annexes A, B, C, D, E, F, G and H are normative. Annexes I, J, and K are informative.

NORSOK standards are administered and published by Standards Norway.

Introduction

The main purpose of this NORSOK standard is to contribute to an acceptable level of safety for humans, the environment and material assets in the petroleum industry by giving technical requirements for lifting equipment.

Formatert: Skrift: Arial

During development of this NORSOK standard, due consideration has been given to relevant EU Directives, Norwegian regulations, European ~~StandardStandards~~ and International ~~standardsstandards~~, as well as other formal documents of relevance. It should be noted, however, that this NORSOK standard is not a standard, and it does not contain all the technical and administrative requirements of the applicable regulations and directives, see the foreword.

Formatert: Skrift: Arial

Formatert: Skrift: Arial

The expert group responsible for this NORSOK standard has agreed that the main safety philosophy and principal requirements of the standard shall be based on applicable safety and health requirements stated in relevant EU directives, e.g. the Machinery directive (2006/42/EC), ATEX directive (94/9/EC), LVD (2006/95/EC), EMC directive (2004/108/EC), PED (97/23/EC). This applies regardless of type of installation or unit on which lifting equipment is installed. Administrative requirements, however, (e.g. CE marking, declaration of conformity, requirements for EC Type-examination, etc.) do not form part of this NORSOK standard.

The requirements of this NORSOK standard are given in clause 4, clause 5 and in the annexes. The combination of all these requirements forms the technical basis the lifting equipment has to comply with. ~~In case of conflict between similar, but not identical requirements, the requirements of the annexes prevail over the common requirements of clause 5, which in turn prevails over the safety requirements of clause 4. However, this general rule may only be waived if the manufacturer makes use of a recognised solution and documents by means of a risk assessment that said solution gives an equal or better safety level than the conflicting requirement.~~The requirements in clause 4 shall always apply.

Formatert: Skrift: Arial

Order of precedence in case of conflict between similar but not identical requirements:

1. Group specific requirements in annexes
2. General requirements in annexes
3. Common requirements, Clause 5

For lifting equipment not specifically addressed in this standard, the requirements described in Clauses 4 and 5 still apply in addition to the general requirements in the applicable annexes.

1 Scope

This NORSOK standard is valid for technical requirements to lifting appliances and lifting accessories on all fixed and floating installations, mobile offshore units, barges and vessels, as well as on land based plants where petroleum activities are performed. This standard is also valid for material handling and the following equipment:

- Launching and recovery appliances for life saving equipment, with and without lifting function;
- Means of connection and release systems that are integrated parts of life saving equipment, as well as their anchorage in the life saving equipment;
- Portable units;
- Foundations and suspensions for lifting appliances;
- Lifts.

This standard may also be used for lifting equipment not specifically described in the annexes.

NOTE 1 For the safe use of lifting equipment, reference is made to NORSOK R-003 and NORSOK R-005.
NOTE 2 The application of this standard is regulated by references in [guidanceguidelines](#) to PSA Regulations or the responsible company's internal requirements.

Formatert: Skrift: 10 pkt

Formatert: Innrykk: Venstre: 0 cm,
Hengende: 0,25 cm

2 Normative and informative references

The following standards include provisions and guidelines which, through reference in this text, constitute provisions and guidelines of this NORSOK standard. Latest issue of the references shall be used unless otherwise agreed. Other recognized standards may be used provided it can be shown that they meet the requirements of the referenced standards.

NOTE Some clauses in this standard refer to specific clauses in the normative references. These references are based upon the editions available at the time of issuing this standard.

2.1 Normative references

CEN/TS 13001-3-2,	Cranes— General design— Part 3-2: Limit states and proof of competence of wire ropes in reeving systems
CEN/TS 13001-3-5,	Cranes - General design – Part 3-5: Limit states and proof of competence of forged hooks
Directive 97/68/EC,	Directive of the European Parliament and of the Council of 16 December December 1997 on the approximation of the laws of the Member States relating to measures against the emission of gaseous and particulate pollutants from internal combustion engines to be installed in non-road mobile machinery, amended by Directives 2001/63/EC, 2002/88/EC, 2004/26/EC and 2006/105/EC
DNV Standard for Certification No. 2.22, DNV-OS-E101, DNV OS-E406, DNV-OS-H101	Lifting Appliances Drilling Plant Design of free fall lifeboats Marine Operations, General
EN 81-1,	<u>Safety rules for the construction and installation of lifts - Part 1: Electric lifts</u>
EN 81-2,	<u>Safety rules for the construction and installation of lifts - Part 2: Hydraulic lifts</u>
EN 81-3,	<u>Safety rules for the construction and installation of lifts - Part 3: Electric and hydraulic service lifts</u>
EN 280,	<u>Mobile elevating work platforms - Design calculations - Stability criteria - Construction - Safety - Examinations and tests</u>

EN 349,	Safety of machinery – Minimum gaps to avoid crushing of parts of the human body
EN 614-1,	Safety of machinery – Ergonomic design principles – Part 1: Terminology and general principles
EN 614-2,	Safety of machinery – Ergonomic design principles – Part 2: Interactions between the design of machinery and work tasks
EN 818-1,	Short link chain for lifting purposes - Safety - Part 1: General conditions of acceptance
EN 818-2,	Short link chain for lifting purposes – Safety – Part 2: Medium tolerance chain for chain slings – Grade 8
EN 818-4,	Short link chain for lifting purposes - Safety - Part 4: Chain slings - Grade 8
EN 818-6,	Short link chain for lifting purposes - Safety - Part 6: Chain slings - Specification for information for use and maintenance to be provided by the manufacturer
EN 842,	Safety of machinery – Visual danger signals – General requirements, design and testing
EN 894-1,	Safety of machinery – Ergonomics requirements for the design of and control actuators – Part 1: General principles for human interactions with displays and control actuators
EN 894-2,	Safety of machinery – Ergonomics requirements for the design of and control actuators – Part 2: Displays
EN 894-3,	Safety of machinery – Ergonomics requirements for the design of and control actuators – Part 3: Control actuators
EN 953,	Safety of machinery – Guards – General requirements for the design and construction of fixed and movable guards
EN ISO 4413,	Hydraulic fluid power - General rules and safety requirements for systems and their components (ISO 4413:2010)
EN ISO 4414,	Pneumatic fluid power - General rules and safety requirements for systems and their components (ISO 4414:2010)
EN 1037,	Safety of machinery – Prevention of unexpected start-up
EN 1127-1,	Explosive atmospheres – Explosion prevention and protection – Part 1: Basic concepts and methodology
EN 1492-1,	Textile slings – Safety – Flat woven webbing slings made of man-made fibres for general purpose use
EN 1492-2,	Textile slings – Safety – Roundslings made of man-made fibres for general purpose use
EN 1492-4,	Textile slings – Safety – Lifting slings for general service made from natural and man-made fibre ropes
EN 1495,	Lifting platforms - Mast climbing work platforms
EN 1570-1,	Safety requirements for lifting tables - Part 1: Lifting tables serving up to two fixed landings
EN 1677-1,	Components for slings – Safety – Part 1: Forged steel components, Grade 8
EN 1677-2,	Components for slings – Safety – Part 2: Forged steel lifting hooks with latch, Grade 8
EN 1677-3	Components for slings - Safety - Part 3: Forged steel self-locking hooks - Grade 8
EN 1677-4,	Components for slings – Safety – Part 4: Links, Grade 8
EN 1679-1,	Reciprocating internal combustion engines – Safety – Part 1: Compression ignition engines
EN 1755,	Safety of industrial trucks - Operation in potentially explosive atmospheres - Use in flammable gas, vapour, mist and dust
EN 1808,	Safety requirements on Suspended Access Equipment - Design calculations, stability criteria, construction - Tests
EN 1834-1,	Reciprocating internal combustion engines – Safety requirements for design and construction of engines for use in potentially explosive atmospheres – Part 1: Group II engines for use in flammable gas and vapour atmospheres
EN 1993-1-1,	Eurocode 3: Design of steel structures - Part 1-1: General rules and rules for buildings

Formatert: Skriftfarge: Automatisk

Formatert: Skriftfarge: Automatisk

EN 1999-1-1,	Eurocode 9: Design of aluminium structures - Part 1-1: General structural rules	
EN 12077-2,	Cranes safety – Requirements for health and safety – Part 2: Limiting indicating devices	Formatert: Skrifffarge: Automatisk
EN 12079-1,	Offshore containers and associated lifting sets - Part 1: Offshore container - Design, manufacture and marking	Formatert: Skrifffarge: Automatisk
EN 12079-2,	Offshore containers and associated lifting sets - Part 2: Lifting sets - Design, manufacture and marking	
EN 12198-2,	Safety of machinery - Assessment and reduction of risks arising from radiation emitted by machinery – Part 2: Radiation emission measurement procedure	
EN 12385-1,	Steel wire ropes – Safety – Part 1: General requirements	
EN 12385-2,	Steel wire ropes – Safety – Part 2: Definitions, designation and classification	
EN 12385-3,	Steel wire ropes – Safety – Part 3: Information for use and maintenance	
EN 12385-4,	Steel wire ropes – Safety – Part 4: Stranded ropes for general lifting applications	
EN 12644-1,	Cranes – Information for use and testing – Part 1: Instructions	
EN 12644-2,	Cranes – Information for use and testing – Part 2: Marking	
EN 12999,	Cranes - Loader cranes	
EN 13000,	Cranes - Mobile cranes	
EN 13001-1,	Cranes – General design – Part 1: General principles and requirements	
EN 13001-2,	Cranes – General design – Part 2: Load actions	
EN 13001-3-1,	Cranes – General design – Part 3-1: Limit states and proof of competence of steel structures	
EN 13001-3-2,	Cranes – General design – Part 3-2: Limit states and proof of competence of wire ropes in reeving systems	
prEN 13001-3-3 ¹ ,	Cranes – General design – Part 3-3: Limit states and proof of competence of wheel/rail contacts	Formatert: Skrifffarge: Svart
EN 13135-1,	Cranes – Equipment – Part 1: Electrotechnical equipment	
EN 13135-2,	Cranes – Equipment – Part 2: Non-electrotechnical equipment	
EN 13155,	Cranes – Safety – Non-fixed load lifting attachments	
EN 13157,	Cranes - Safety - Hand powered cranes	
EN 13411-1,	Terminations for steel wire ropes - Safety - Part 1: Thimbles for steel wire rope slings	
EN 13411-3,	Terminations for steel wire ropes – Safety – Part 3: Ferrules and ferrule-securing	
EN 13411-4,	Terminations for steel wire ropes – Safety – Part 4: Metal and resin socketing	
EN 13411-6,	Terminations for steel wire ropes – Safety – Part 6: Asymmetrie Asymmetric wedge socket	
EN 13411-7,	Terminations for steel wire ropes – Safety – Part 7: Symmetric wedge socket	
EN 13414-1,	Steel wire rope slings – Safety – Part 1: Slings for general lifting service	
EN 13414-2,	Steel wire rope slings - Safety - Part 2: Specification for information for use and maintenance to be provided by the manufacturer	
EN 13414-3,	Steel wire rope slings - Safety - Part 3: Grommets and cable-laid slings	
EN 13463,	Non-electrical equipment for use in potentially explosive atmospheres	
EN 13478,	Safety of machinery - Fire prevention and protection	
EN 13557,	Cranes – Controls and control stations	
EN 13586,	Cranes – Access	
EN 13852-1,	Cranes – Offshore cranes – Part 1: General purpose offshore cranes	
EN 13852-2,	Cranes – Offshore cranes – Part 2: Floating cranes	
EN 13889,	Forged steel shackles for general lifting purposes. Dee shackles and bow shackles. Grade 6. Safety.	
EN 14492-1,	Cranes – Power driven winches and hoists – Part 1: Power driven winches	
EN 14492-2,	Cranes – Power driven winches and hoists – Part 2: Power driven hoists	

¹ To be published.

EN 14502-1,	Cranes - Equipment for the lifting of persons - Part 1: Suspended
EN 15011,	bases – bridge and gantry cranes
<u>EN 22915-1</u>	<u>Industrial trucks -- Verification of stability -- Part 1: General</u>
FEM 1.001, 3 rd edition 1998,	Rules for the design of hoisting appliances
IEC 60034,	Rotating electrical machines
IEC 60079 (all parts),	Explosive atmospheres (all parts)
IEC 60204-1,	Safety of machinery – Electrical equipment of machines – Part 1: General requirements
IEC 60204-32,	Safety of machinery – Electrical equipment of machines – Part 32: Requirements for hoisting machines
IEC 60300-3-11,	Dependability management – Part 3-11: Application guide – Reliability centred maintenance
IEC 60529,	Degrees of protection provided by enclosures (IP Code)
IEC 60812,	Analysis techniques for system reliability – Procedure for failure mode and effects analysis (FMEA)
IEC 61000-6-2,	Electromagnetic compatibility (EMC) – Part 6-2: Generic standards – Immunity for industrial environments
IEC 61000-6-4,	Electromagnetic compatibility (EMC) – Part 6-4: Generic standards - Emission standard for industrial environments
IEC 61892 (all parts),	Mobile and fixed offshore units – Electrical installations – (all parts)
IMDG Code,	International Maritime Dangerous Goods Code
IMO Resolution A.760 (18),	Symbols related to Life Saving Appliances and Arrangements
IMO Resolution MSC.82 (70),	Amendments to Resolution A.760 (18)
ISO 2307,	Fibre ropes -- Determination of certain physical and mechanical properties
ISO 2631-1,	Mechanical vibration and shock – Evaluation of human exposure to whole-body vibration – Part 1: General requirements
ISO 3864-1,	Graphical symbols – Safety colours and safety signs – Part 1: Design principles for safety signs and safety markings
ISO 3864-2,	Graphical symbols – Safety colours and safety signs – Part 2: Design principles for product safety labels
ISO 3864-3,	Graphical symbols – Safety colours and safety signs – Part 3: Design principles for graphical symbols for use in safety signs
ISO 6385,	Ergonomic principles in the design of work systems
ISO 7010,	Graphical symbols -- Safety colours and safety signs -- Registered safety signs
ISO 9001,	Quality management systems – Requirements
<u>ISO 10423 / API Spec 6A²</u> ,	Petroleum and natural gas industries -- Drilling and production equipment -- Wellhead and christmas tree equipment
ISO/TR 11688-1,	Acoustics – Recommended practice for the design of low-noise machinery and equipment – Part 1: Planning
ISO/TR 11688-2,	Acoustics – Recommended practice for the design of low-noise machinery and equipment – Part 2: Introduction to the physics of low- noise design
<u>ISO 11961 / API Spec. 5D² and 7²</u> ,	Petroleum and natural gas industries - Steel drill pipe
ISO 12100,	Safety of machinery – General principles for design – Risk assessment and risk reduction
ISO 12482-1,	Cranes – Condition monitoring – Part 1: General
ISO 12944-1,	Paints and varnishes – Corrosion protection of steel structures by protective paint systems – Part 1: General introduction
ISO 13200,	Cranes – Safety signs and hazard pictorials – General principles
<u>ISO 13535, / API Spec. 8C²</u> ,	Petroleum and natural gas industries - Drilling and production equipment - Hoisting equipment
ISO 13628-1,	Petroleum and natural gas industries - Design and operation of subsea production systems - Part 1: General requirements and recommendations
ISO 13628-4,	Petroleum and natural gas industries -- Design and operation of subsea production systems -- Part 4: Subsea wellhead and tree equipment
<u>ISO 13628-7 / API RP 17G²</u> ,	Petroleum and natural gas industries - Design and operation of subsea production systems - Part 7: Completion/workover riser systems

² Where ISO / API references are given, the standard with the latest revision shall apply

ISO 13702,	Petroleum and natural gas industries – Control and mitigation of fires and explosions on offshore production installations – Requirements and guidelines
ISO 13849-1,	Safety of machinery – Safety-related parts of control systems – Part 1: General principles for design
ISO 13850,	Safety of machinery – Emergency stop – Principles for design
ISO 13857,	Safety of machinery – Safety distances to prevent hazard zones being reached by upper and lower limbs
ISO/TR 14121-2,	Safety of machinery – Risk assessment – Part 2: Practical guidance and examples of methods
ISO 16467,	Packaging -- Transport packages for dangerous goods -- Test methods for IBCs
ISO 17894,	Ships and marine technology -- Computer applications -- General principles for the development and use of programmable electronic systems in marine applications
ISO 19901-6,	Petroleum and natural gas industries -- Specific requirements for offshore structures -- Part 6: Marine operations
ISO 21898,	Packaging -- Flexible intermediate bulk containers (FIBCs) for non-dangerous goods
LSA Code,	IMO SOLAS Life-saving Lifesaving appliances (LSA) Code, adopted by the Maritime Safety Committee by resolution MSC.48_(66), (concerning evacuation and life-saving appliances on mobile offshore units)
NMD Regulation 4.July 2007 No.853,	Electrical systems
NORSOK E-001,	Surface preparation and protective coating
NORSOK M-501,	Design of steel structures
NORSOK N-004,	Safe use of lifting equipment
NOKSOK R-003,	Safe use of lifting and transport equipment in onshore petroleum plants
NORSOK R-005,	Technical safety
NORSOK S-001,	Working environment
NORSOK S-002,	Mechanical completion and commissioning
NORSOK Z-007,	Risk based maintenance and consequence classification classification
NORSOK Z-008,	
US Federal Specification FF-T-791.B, Turnbuckle	
US Federal Specification RR-C-271,	Chain and attachments, welded and weldless

2.2 Informative references

DNV-OS-C501,	DNV Offshore Standard Composite Components
DNV OSS-308,	Verification of lifting appliances for the oil and gas industry
DNV-RP-A203,	Qualification of New Technology
DNV-RP-C203,	Fatigue Design of Offshore Structures
EN 1993-6,	Eurocode 3: Design of steel structures - Part 6: Crane supporting structures
NORSOK N-001,	Integrity of offshore structures

3 Terms, definitions and abbreviations

For the purposes of this NORSOK standard, the following terms, definitions and abbreviations apply.

3.1 Terms and definitions

3.1.1

activation system

interconnected parts necessary for powered or manual opening of the release mechanism, including the power supply and control system or manual control device

3.1.2

agreed

term used when operating conditions or other design parameters are to be specified, and an agreement has to be reached

NOTE The parties of the agreement are the manufacturer of the equipment in question, and the company's technical responsible for operation of the installation in question. The term is used in different contexts, e.g. "unless otherwise agreed", "to be agreed", "as agreed" etc.

3.1.3 availability

availability of an item to be in a state to perform a required function under given conditions at a given instant of time, or in average over a given time interval, assuming that the required external resources are provided

3.1.4 breaking load (breaking force)

the maximum load ~~reaced~~reached during a static tensile test to destruction of a lifting component or lifting accessories. Destruction is understood as actual breakage or ~~failiure~~failure to sustain a load due parts disconnecting as result of deformation.

NOTE: In this standard both ~~thermsterms~~ "breaking load" and "breaking force" are used, having the same meaning.

← **Formater:** Innrykk: Venstre: 0 cm,
Første linje: 0 cm

3.1.5 breaking load test

a static tensile test with the purpose of determining the actual breaking load (~~breakding~~breaking force) of a lifting component or lifting accessories in order to verify a specified minimum value

3.1.6 can

verbal form used for statements of possibility and capability, whether material, physical or casual

3.1.7 complex lifting appliances

power driven lifting appliances with high capacity and or high risks

NOTE Complex lifting appliances include, but are not limited to: offshore cranes, BOP cranes, drawworks, launching appliances for lifeboats, tower cranes, mobile cranes etc.

3.1.8 crane

lifting appliance whereby the load can be moved horizontally in one or more directions, in addition to the vertical movement

3.1.9 design temperature

design temperature is a reference temperature used as a criterion for the selection of materials. The design temperature is the lowest mean daily temperature, which is the lowest point on the mean daily temperature curve over the year for a specific area. The mean daily temperature is the statistical 24 hour mean temperature for a specific calendar day, based on and averaged over a number of years of observation.

3.1.10 extended harm

damage to material assets or the environment in addition to harm (physical injury or damage to health)

3.1.11 fail-safe component

component where the predominant failure mode is known in advance, and which is used such that the effect of such failure is less critical

3.1.12 harm

physical injury or damage to health

3.1.13

inherently safe design measure

protective measure which either eliminates hazards or reduces the risks associated with hazards by changing the design or operating characteristics of the machine without the use of guards or protective devices

3.1.14

installation

facility, plant or vessel involved in petroleum activities (excluding ships that transport petroleum in bulk)

NOTE Reference is made to PSA regulations for definition of petroleum activities.

Examples of installations include fixed installations, FPSO vessels, rigs, barges, crane barges, service vessels, onshore plants etc.

3.1.15

launching and recovery appliances

lifting appliance for lifesaving equipment

3.1.16

lay down area

deck area for temporary storage of loads and equipment

3.1.17

lifesaving equipment

evacuation equipment and rescue equipment

3.1.18

lifting accessories

components or equipment used between the lifting appliance and the load or on the load to grip it, but which is not an integrated part of the lifting appliance

NOTE The term "lifting accessories" equals "lifting gear" as defined by ILO Convention 167 and NORSOK R-003/R-005 and "loose gear" as defined by ILO Convention 152.

3.1.19

lifting appliance

machine or device used for vertical movement of a load, with or without horizontal movement

NOTE Include cranes, hoists, drilling hoisting equipment and launching and recovery appliances for life saving equipment, etc.

3.1.20

lifting components

components used as integral parts of lifting appliances and/or as part of lifting accessories.

NOTE: In some cases, lifting components may be lifting accessories on their own.

3.1.21

lifting equipment

common term for all equipment covered by the scope of this standard

3.1.22

lifting operation

all administrative and operational activities before, during and after a load is moved and until the lifting equipment is ready for a new load

3.1.23

lifting set

term used for single legged or multi legged slings

3.1.24

lifting zone

space between the working area and the maximum lifting height

3.1.25

LSA code

the IMO SOLAS [Life-saving/Lifesaving](#) appliances (LSA) Code, 2003 Edition, adopted by the Maritime Safety Committee (MSC) by resolution MSC.48(66) including the Revised recommendation on testing of life-saving appliances (resolution MSC.81(70)).

3.1.26

main lay down area

deck area for temporary storage of loads and equipment during normal logistics operation of the installation

Formatert: Skrift: Fet

Formatert: Term(s)

3.1.27

material handling

vertical and horizontal movement of a load

NOTE Material handling principles include all activities related to handling of goods and materials to and from and internally on the installation in all phases of its lifetime.

3.1.28

may

verbal form used to indicate a course of action permissible within the limits of this NORSOK standard

3.1.29

means of connection

mechanical parts (e.g. hooks, links, rings, etc.) intended for connection of the [life-saving/lifesaving](#) equipment to the launching and recovery appliance

NOTE The term "means of connection" covers both those parts which are integral to the [life-saving/lifesaving](#) equipment and those parts which are integral to the lifting appliance.

3.1.30

offboard lift

lifting operation between the offshore installation and a floating unit or the sea

3.1.31

offlead angle

angle from the vertical at which the hoist rope or chain leaves the lifting appliance, measured in the plane described by the vertical and the radial direction of the last sheave or drum, whichever is the last contact point with the structure of the lifting [appliance/appliance](#). Offlead angle is caused by the radial displacement of the hook/load

3.1.32

offshore crane

crane performing offboard lifting operations

3.1.33

onboard lift

lifting operation within the offshore installation

3.1.34

operating temperature limits

the operating temperature limits are the minimum and maximum environmental temperatures for normal operation of the lifting equipment, where all effects of high and low temperatures have been taken into account

3.1.35

personnel transfer carrier

basket suspended on cranes used for transfer of personnel between installations and ships

3.1.55

proof load (proof force)

specified load (force) to which a lifting component or lifting accessories are to be subjected during proof load test

NOTE: In this standard both ~~the~~terms "proof load" and "proof force" are used, having the same meaning.

Formatert: Skrift: 10 pkt,

Formatert: TermNum, Innrykk:
Venstre: 0 cm, Første linje: 0 cm

Formatert: TermNum

3.1.36

proof load test (proof force test)

a static tensile test with a specified proof load (proof force) to which lifting components or lifting accessories are subjected during or after manufacturing. After the test, the tested object shall meet a specified acceptance criterion with respect to deformation.

3.1.37

rated capacity (R)

maximum load that a lifting appliance is designed to lift under specific conditions

NOTE Rated capacity which corresponds to SWL used by International Labour ~~Organisation~~Organization (ILO).

3.1.38

redundant component

component or components which continue to perform a failed component's purpose or function without affecting the safe operation

3.1.39

release mechanism

parts of the means of connection that are moveable for the purpose of disconnecting the ~~life~~saving~~lifesaving~~ equipment from its launching and recovery appliance

3.1.40

release system

combination of release mechanism and activation system

3.1.41

reliability

ability of an item to perform a required function under given conditions for a given time interval

3.1.42

reliable component

component which is capable of withstanding all load conditions, disturbances and stresses, with a low probability of failures or malfunctions

3.1.43

rescue boat

boat designed to rescue persons in distress and to marshal survival craft.

NOTE Rescue boats are also commonly known as man over board (MOB) boats.

3.1.44

rescue equipment

rescue boats and personnel transfer carrier

3.1.45

risk

combination of the probability of occurrence of harm and the severity of that harm

3.1.46

safe working load

SWL

maximum working load that the lifting equipment is designed to lift under specific conditions

NOTE Safe working load corresponds to the term rated capacity (R) used by many standards.

3.1.47

shall

verbal form used to indicate requirements strictly to be followed in order to conform to this NORSOK standard and from which no deviation is permitted, unless accepted by all involved parties

3.1.48

should

verbal form used to indicate that among several possibilities one is recommended as particularly suitable, without mentioning or excluding others, or that a certain course of action is preferred but not necessarily required

NOTE The term 'should' means that other solutions can be chosen than the one recommended in the standard. It shall be documented that the alternative solution provides an equivalent level of safety.

3.1.49

sidelead angle

angle from the vertical at which the hoist rope or chain leaves the lifting appliance, measured in the plane described by the vertical and the transverse direction of the last sheave or drum, whichever is the last contact point with the structure of the lifting ~~appliance~~appliance. Sidelead angle is caused by the lateral displacement of the hook/load .

3.1.50

significant wave height

the average wave height (measured from trough to crest) of the highest one-third of individual wave heights occurring in a period of 20 min.

3.1.51

test

specific operation of lifting equipment, with or without a defined load, in order to determine whether the lifting equipment is suitable for use

3.1.52

test load

specified load that the lifting equipment shall withstand within the manufacturer's specified limits without resulting in permanent deformation or other defects

NOTE Thereby confirming that the design, materials and manufacture comply with specification and statutory requirements.

3.1.53

working area

vertical projection of all possible load positions

3.1.54

working load limit

WLL

maximum load that a lifting accessory is designed to lift at a specific configuration

Formatert: Skrift: Arial

Formatert: TermNum, Automatisk
tegnavstand mellom latinske og
asiatiske tegn, Juster mellomrom
mellom asiatiske tekst og tall

3.2 Abbreviations

ALARP	as low as reasonable practicable
ALS	accident limite state
ATEX	Atmosphères Explosibles
CE	Conformité Européenne
EMC	electromagnetic compatibility
EU	European Union
FAT	factory acceptance test
FMECA	failure mode, effects and criticality analysis
FPSO	floating production, storage and offshore loading
HVAC	heat, ventilation and air conditioning
IMO	International Maritime Organization
LS	life saving
NLS	non-life saving
NMD	Norwegian Maritime Directorate
PSA	<u>Petroleum Safety Authority Norway</u>
RCM	reliability centered maintenance
SLS	serviceability limit state
SWL	safe working load
UHF	ultra high frequency
ULS	ultimate limit state
VHF	very high frequency
WLL	working load limit

4 General safety requirements

4.1 Safety

Lifting equipment shall be designed, fabricated, tested, installed and maintained in such a way to reduce and minimise risks to humans, the environment and material assets.

All forms of energy including lifting and moving objects, represented or produced by lifting equipment, shall be controlled at any time in a safe manner.

The lifting equipment shall be designed such that no common cause failure or a single technical failure results in an unacceptable risk.

4.2 Fitness for use

To minimise the risk of human error during all phases of use, simplicity, comprehensibility, maintainability and recognisability shall be emphasised when designing the lifting equipment.

The selection of type and specification of requirements for lifting equipment shall be based on the specific conditions at the workplace, the work itself, and any risk that may arise during the work.

4.3 Reliability and availability

Lifting equipment shall be designed and constructed using well-proven components and safety principles, to ensure reliability by withstanding

- the operating stresses and loadings,
- the environmental influences,
- other relevant influences.

Lifting equipment shall be designed to ensure high availability and a minimum of “down-time” during the design life. In case of conflict between reliability, availability and/or safety, safety shall always prevail.

Formatert: Nummerert + Nivå: 1 +
Nummereringsstil: Punkt + Start på: 1
+ Justering: Venstre + Justert ved:
0,25 cm + Innrykk ved: 0,75 cm

4.4 Principle of safety integration

The designer shall aim to eliminate any risk throughout the design lifetime of the lifting equipment, including the phases of transport, assembly, disabling, scrapping and dismantling.

In selecting the most appropriate methods, the manufacturer shall apply the following principles of safety integration in the order given:

1. Eliminate and reduce risks as far as possible by implementation of inherently safe design measures
2. Safeguarding and complementary protection measures in relation to risks that cannot be eliminated
3. Inform the users of the residual risks due to any shortcomings of the protection measures adopted, etc.

The basic terminology, methodology and technical principles are given in ISO 12100.

A documented risk assessment shall be worked out for all lifting appliances. The documentation of risk assessment shall demonstrate that the requirements for performing the risk assessment have been met, and that the results with respect to the acceptance criteria are fulfilled.

The risk assessment principles are given in ISO 12100 and ISO/TR 14121-2.

For complex lifting appliances the risk assessment shall be developed using methods on component level, e.g. FMECA as described in IEC 60812.

4.5 Inherently safe design measures

Inherently safe design principles using reliable components shall be applied, see ISO 12100, clause 6.2. Dependent on the result of the risk assessment, fail-safe components or redundant components shall be used.

4.6 Safeguarding and complementary protective measures

Safeguarding and complementary protective measures shall be used to reduce or eliminate risks that ~~can~~ ~~not~~ cannot be avoided or sufficiently limited by inherently safe design measures. Reference is made to ISO 12100, clause 6.3.

4.7 Information for use

Information for use consists of communication links (e.g. text, words, signs, signals, symbols), or diagrams used separately or in a combination to convey information to the user. Information for use shall be supplied to further reduce risks that ~~can~~ ~~not~~ cannot be avoided or sufficiently reduced by inherently safe design measures or safeguarding and complementary protective measures. The information for use shall be an integral part of supply of lifting equipment. Reference is made to ISO 12100, clause 6.4.

4.8 Strength proportion

For lifting appliances where external influences may cause accidental overloading, the strength elements (structural and mechanical) of the lifting appliance shall be designed such that the consequences of such overloading which causes break down are known and minimised. During the risk assessment the possibility for accidental overloading must be evaluated, and a strategy to which element should fail first must be established. This requirement does not apply for lifting accessories and portable units.

For cranes and launching appliances for life saving equipment this requirement should be fulfilled by ensuring that the first element to fail is not the foundation or any other element which is essential for the structural integrity of the entire crane or launching appliance.

4.9 Maintenance

Lifting equipment shall be designed and arranged with means for efficient maintenance which ensure that the safe condition can be maintained for the specified design life. Critical areas subject to regular inspection or inspection after overload testing shall be accessible for inspection with the required inspection methods.

A high level of maintainability shall be ensured, i.e. that the maintenance can easily be performed.

Facilities, including safe access, for maintenance, inspection and testing of essential elements and functions shall be provided.

The maintenance shall be planned with the following priority:

1. Safety
2. Reliability
3. Availability

A maintenance programme shall be provided for all lifting equipment and shall include all important maintenance tasks highlighted and recommended in the risk assessment, see 4.11.

For cranes reference is made to ISO 12482-1 and relevant parts of NORSOK Z-008, as applicable.

If appropriate for complex lifting appliances, the maintenance programme shall be developed on component level, e.g. RCM as described in IEC 60300-3-11.

Lifting appliances and launching appliances for lifesaving equipment, which are infrequently used and exposed to corrosive atmosphere, should have a modular design, allowing parts to be easily dismantled and removed for temporary in-house storage and preservation. Alternatively the equipment should be designed for reliable in situ preservation.

4.10 Quality management system

The design, manufacturing and installation of lifting equipment shall be performed in accordance with a quality management system. The quality management system shall be in accordance with ISO 9001 or equivalent.

4.11 Risk assessment

4.11.1 General

Risk assessment shall be an integral part of the supply of design process for lifting equipment. This implies that the knowledge and experience of the design, manufacturing, installation, transportation, assembly, dismantling, use, maintenance, incidents, accidents and harm, etc. related to lifting equipment shall be collected and used by the designer in order to assess the risks of lifting equipment during all phases.

Risk assessment shall be an iterative process, and repeated after the application of risk reduction measures until an acceptable level of safety is obtained, see principle of evaluation of risks stated in 4.12.

The risk assessment shall be carried out in accordance with ISO 12100.

NOTE ISO 12100 gives a more comprehensive description of risk assessment.

The relevant method of analysing hazards and estimating risk shall be selected depending on the lifting equipment characteristics and the type of risks that are dominating. Examples of such methods are described in ISO/TR 14121-2, Annex A.

The risk assessment shall be documented as stated in 4.13 and used as input for the maintenance planning, see 4.4.

4.11.2 Determination of the limits

Determination of the limits of the lifting equipment is the first step in the risk assessment. Determination of the limits of the lifting equipment includes the technical properties and the performance of the lifting equipment, the personnel involved and the environmental constraints at all times.

Determination of limits of the lifting equipment shall include, but not be limited to

- use limits including intended use and foreseeable misuse,
- different modes of operation and operator interventions,
- space limits,
- time limits,
- ~~environmental~~Environmental limits.

← **Formatert:** Nummerert + Nivå: 1 +
Nummereringsstil: Punkt + Start på: 1
+ Justering: Venstre + Justert ved:
0,25 cm + Innrykk ved: 0,75 cm

4.11.3 Identification of hazards

All hazards, hazardous situations and events shall be systematically identified. The phases shall include, but not be limited to

- construction,
- assembly,
- FAT,
- transport,
- installation,
- commissioning,
- use and foreseeable misuse,
- maintenance and testing,
- repair,
- de-commissioning, dismantling and removal.

← **Formatert:** Nummerert + Nivå: 1 +
Nummereringsstil: Punkt + Start på: 1
+ Justering: Venstre + Justert ved:
0,25 cm + Innrykk ved: 0,75 cm

Further reference is ISO 12100.

4.11.4 Estimation of risks

The risk is the combination of the probability of occurrence of harm and the severity of that harm.

The severity of harm to health can be estimated by taking into account

- a) the severity of injuries or damage:
 - 1) slight;
 - 2) serious;
 - 3) fatal.
- b) the extent of harm:
 - 1) one person;
 - 2) several persons.

Or, in case of an extended harm of an economic and/or environmental nature:

- a) the severity of the extended harm in terms of cost or environmental damage:
 - 1) minor;
 - 2) major;
 - 3) catastrophic.
- b) the extent of the extended harm in terms of cost or environmental damage:
 - 1) slight;
 - 2) moderate;
 - 3) extensive.

The probability of occurrence of any harm shall be estimated by taking into account the exposure to a hazard, occurrence of a hazardous event, and the possibilities of avoiding the harm.

The exposure to a hazard is influenced by

- a) need for access to the hazard zone,
- b) time spent in the hazard zone,
- c) number of persons exposed,
- d) frequency of access.

The occurrence of a hazardous event is influenced by

- a) reliability and other statistical data,
- b) incident and accident history,
- c) risk comparison.

The possibilities of avoiding the harm are influenced by

- a) personal skills,
- b) how quickly the hazardous situation is developing,
- c) awareness of risk,
- d) possibility of escape.

4.11.5 Evaluation of risks

Risk evaluation shall be carried out to determine if risk reduction is required. If risk reduction is required, then appropriate risk reduction measures shall be selected and applied in accordance with 4.12, followed by repeated risk assessment. As a part of this iterative process, the designer shall check whether additional hazards are created or other risks are increased, when new measures are applied. If additional hazards do occur, they shall be added to the list of identified hazards, analysed and evaluated.

For standardised lifting equipment which is fully covered by the standards referred to herein, and which fully complies with the requirements stated, without additional hazards, the acceptance criteria in this NORSOK standard apply.

For non-standardised lifting equipment or standardised lifting equipment which partly or fully does not meet the requirements in this NORSOK standard, the remaining risks shall comply with the ALARP principle. The ALARP principle may be described as a reverse burden of proof, i.e. that risk reduction measures shall be implemented, if there is no evidence showing why not. The designer shall implement risk reduction measures unless it can be proven that there is a major inconsistency between cost and benefit.

4.12 Risk reduction

Risk reduction shall comprise all possibilities to reduce the risk, including redesign, design modification, protective measures and information for use.

The designer shall select the most appropriate measure following the three step method below:

- Step 1. Inherently safe design measures
- Step 2. Safeguarding and possible complementary protective measures
- Step 3. Information for use covering residual risks

For reference, see 4.4.

4.13 Documentation of risk assessment

Documentation of risk assessment shall demonstrate that the requirements for performing risk assessment have been met, and that the acceptance criteria are fulfilled.

The documentation shall include description of

- 1 the lifting equipment for which the assessment was made (e.g. specifications, limits, intended use) and any relevant assumptions that have been made (e.g. loads, strengths, safety factors),
- 2 the hazards and hazardous situations identified and the hazardous events considered in the assessment,
- 3 the information on which risk assessment was based:
 - 1) the data used and the sources (e.g. accident histories, experiences gained from risk reduction applied to similar lifting equipment);
 - 2) the uncertainty associated with the data used and its impact on the risk assessment.
- 4 the objectives to be achieved by protective measures,
- 5 the protective measures implemented to eliminate identified hazards or to reduce risk (e.g. from standards or other requirements),
- 6 residual risks associated with the lifting equipment,
- 7 the result of the risk assessment,
- 8 any forms completed during the assessment such as those given in ISO/TR 14121-2.

4.14 Verification

Lifting equipment shall be subjected to internal verification by the manufacturer to ensure compliance with requirements. Such internal verification shall be part of the technical construction file, see 5.25.

Before being taken into use, the lifting equipment shall be ~~controlled~~subjected to initial control by an enterprise of competence, in accordance with NORSOK R-003 Annex E and H or NORSOK R-005 Annex E and H, as applicable.

Devices for the lifting of persons or of persons and goods involving a hazard of falling from a vertical height of more than 3 m, shall be subject to an involvement by a Notified Body, if the Machinery Directive is applicable.

The need, extent, method and independency of third party verification of the lifting equipment shall be upon, dependent on the ~~complexity of the lifting appliance risk~~, DNV-OSS-308, or equivalent, should be as a reference.

Formatert: Engelsk (USA)

Formatert: Engelsk (USA)

Verification reports from third parties shall form part of the final documentation and made available to the end user.

4.15 Qualification of new technology

The solutions described in this NORSOK standard are generally accepted as qualified at the time of publication of this NORSOK standard. Other solutions may also be applied, provided they are sufficiently qualified in accordance with recognised methods. The procedures and principles in DNV-RP-A203 may be used for qualification of new technology.

5 Common requirements

5.1 Suitability

5.1.1 General

At the time of contract for the delivery of lifting equipment, parameters essential to ensuring that the lifting appliance is suitable and fit for use shall be exchanged and agreed upon. Such design parameters shall include, but not be limited to

- location of installation,
- type of installation,
- area of installation, arrangement, lay-out and load handling ~~area~~area,
- environment, including temperatures, radiation, wind and other weather conditions, if relevant,
- criticality of the loads to be lifted, and the importance of the lifting operation,
- rated capacity,
- specification of interface between lifting appliance and its foundation,
- specification of foundation reaction forces acting at the interface between the foundation and the lifting appliance (ref. 5.25.3 and Annex H)classification (utilization) (see also 5.8),
- design life,
- noise and emissions,
- operational limitations,
- anti-collision system,
- fire and gas shut down philosophy,
- automatic ~~shut down~~shutdown criteria,
- other relevant health, safety and environment requirements.

Formatert: Nummerert + Nivå: 1 + Nummereringsstil: Punkt + Start på: 1 + Justering: Venstre + Justert ved: 0,25 cm + Innrykk ved: 0,75 cm

Formatert: Nummerert + Nivå: 1 + Nummereringsstil: Punkt + Start på: 1 + Justering: Venstre + Justert ved: 0,25 cm + Innrykk ved: 0,75 cm

NOTE Complex lifting equipment, i.e. offshore cranes, launching appliances for life saving equipment, drawwork, lifts etc. will normally have an extensive interface to the installation, including power supplies, HVAC systems, fire & gas signals and shut downs, telecom, PA-systems, access routes, utility systems etc. In order to ensure that the HSE requirements are met and the equipment interfaces are compatible with the rest of the installation, the PSA requirements stated in the Facility regulation and applicable Company specifications will have precedence for these interfaces at the installation side in case of conflict with the requirements of this standard.

5.1.2 Lifting of personnel

Lifting equipment for the lifting of personnel shall be designed and equipped to minimise the risk for the personnel.

The structural and mechanical capacity of lifting equipment for the lifting of personnel shall be designed with a higher value risk coefficient, see 5.9 and the relevant annexes.

Lifting appliances for the lifting of personnel shall be equipped with additional safety features, see 5.9, 5.15 and the relevant annexes.

5.1.3 Mechanical interference

Lifting appliances shall be arranged and located with the aim not to interfere with other machinery or equipment.

Warning signals and anti-collision systems shall be provided on lifting appliances where mechanical interference with other machinery or equipment represents an unacceptable risk. If so, such equipment shall be specified by customer.

5.2 Materials and products

Materials and products used to construct lifting equipment, or products contained or created during the use of lifting equipment, shall not cause harm. The use of toxic or harmful liquids and substances shall be minimised.

5.3 Fire and explosion

5.3.1 Fire prevention and protection

Fire prevention and protection of lifting appliances shall be in accordance with applicable parts of [EN 13463](#), NORSOK S-001, and EN 13478.

Fire prevention and protection shall be marked in accordance with ISO 7010.

5.3.2 Hazardous areas

Lifting equipment shall be compatible with the classification of the area in which it is intended to be installed or used. Explosion protection shall be in accordance with applicable parts of IEC 60079-series.

All types of lifting ~~appliance~~ [equipment](#), fixed, mobile or temporary, electrical and non-electrical, installed or used in hazardous areas, shall comply with ATEX requirements, i.e. Zone 0, Zone 1 or Zone 2 according to EN 1127-1 [and applicable parts of EN 13463 series](#), as relevant for the hazardous area classification.

Electrotechnical equipment mounted externally (exposed to potential explosive atmosphere) on lifting appliances located in non-hazardous areas, shall as a minimum be classified for use in hazardous area Zone 2, see NORSOK S-001. Crane boom movements in zone 1 area require zone ~~1~~ [equipment](#) [equipment](#) in boom for parts of the boom entering zone 1 during operation.

Area classification shall be in accordance with IEC 61892 (all parts).

5.3.3 HVAC

HVAC in enclosed spaces of lifting appliances shall be in accordance with [relevant parts of](#) NORSOK S-001 and NORSOK S-002, if applicable.

[The HVAC system shall serve the crane cabin and the engine room. The engine room will either comprise of equipment for electrical hydraulic drive, diesel hydraulic drive or all electrical drive. The crane shall have local HVAC control. The HVAC system shall be suitable for operation as per Area Classification.](#)

[The following minimum requirements:](#)

- [The part of the HVAC system serving the cabin shall be designed to provide a comfortable working environment for the offshore crane operator. The heating / cooling system shall be able to keep an adjustable inside temperature within the range of 15 °C to 25 °C for all ambient air temperatures, for which the offshore crane has been designed.](#)

- ~~The HVAC system shall have capacity for keeping all windows clear for moist, and the noise limits inside the cabin shall not be exceeded when running on full capacity.~~
- ~~The control philosophy must allow for the cabin ventilation and the AC-unit to run separately.~~
- ~~Supply air to engine room and cabin shall be taken from unclassified area.~~
- ~~Supply and extract duct(s) to the engine room and the crane cabin shall be equipped with fire damper, if considered necessary because fire evaluation has concluded that there is a risk for escalation reduction by means of fire dampers, unless the use of shut-off dampers are considered sufficient.~~

5.3.4 Fire and gas detection

~~Complex lifting~~Lifting appliances ~~with control cabins and/or engine rooms~~ shall be equipped with fire and gas detection in accordance with NORSOK S-001 as applicable. Requirements additional to NORSOK S-001 shall be specified by customer.

5.3.5 Fire and gas alarms

Lifting appliances with control cabins shall be equipped with fire and gas alarms from the installation which enable the operator to terminate any lifting operations and bring the crane and the load to a safe position before activating a manual shut down. Reference is made to ISO 13702.

5.3.6 Shut-down system

Lifting appliances which represent a hazard if operated in an explosive atmosphere, shall be ~~equipped with~~protected by an automatic shut-down system which is activated upon confirmed gas detection ~~in~~on the ~~crane ventilation system or in the combustion air inlet~~installation, without delay, see NORSOK S-001.

Formatert: Engelsk (USA)

Lifting appliances for life saving appliances and for the lifting of personnel may be specially considered.

5.4 Ergonomics

5.4.1 General

Lifting equipment shall be designed in accordance with ergonomic principles in accordance with EN 614-1 and EN 614-2. In addition, ISO 6385 ~~shall~~and NORSOK S-002 ~~should~~ be used for guidance. ~~Relevant requirements in NORSOK S-002 shall be complied with.~~

5.4.2 Operator position

Control stations for lifting appliances shall be designed and constructed to avoid any risk related to the health and safety of the operator, and such that the operator can safely supervise and control the lifting operations. Design of displays and control actuators shall be in accordance with EN 894-1, EN 894-2 and EN 894-3.

5.4.3 Escape and access

Lifting appliances shall be equipped with access ~~and escape routes for personnel in accordance with EN 13586.~~

~~Lifting appliances shall be designed for safe access for operation (including operation of emergency systems in accordance with 5.15), operation,~~ inspection and maintenance in accordance with ~~NORSOK S-002, EN 13586.~~

~~Ladders, where there is a risk of falling, shall have self closing gates.~~

5.4.4 Marking

~~Unless otherwise specified in the annexes to this standard, or references given therein, all lifting equipment shall have the following marking:~~

- ~~the business name and full address of the manufacturer,~~
- ~~designation of the lifting equipment,~~
- ~~designation of series or type,~~

Formatert: Ingen punktmerking eller nummerering

- ~~serial number,~~
- ~~the year of construction, that is the year in which the manufacturing process is completed,~~
- ~~any legal marking (e.g. CE marking) if applicable~~

~~Lifting equipment designed and constructed for use in a potentially explosive atmosphere must be marked accordingly.~~

~~Lifting appliances shall be marked with their rated capacity (SWL "Safe Working Load"). For cranes, such marking shall be in accordance with EN 12644 2.~~

~~Lifting accessories shall be marked with their working load limit (WLL).~~

~~Lifting equipment must also be marked with full information relevant to its type and essential for safe use, as identified in the risk assessment.~~

~~Parts of lifting equipment that must be handled during use with other lifting equipment, its mass must be indicated legibly, indelibly and unambiguously.~~

~~Safety colours and safety signs of lifting equipment shall be in accordance with ISO 3864 1, ISO 3864 2, ISO 3864 3 and ISO 13200.~~

It shall be possible to evacuate personnel using stretchers from permanent control cabin and access provided for firefighting equipment.

NOTE The installation should be provided with access to the lifting appliance in accordance with NORSOK S-002.

5.4.55.4.4 Illumination

A main electric lighting system shall provide illumination of every part of the lifting appliances normally accessible to operators and maintenance personnel, taking its supply from the main source of electrical power.

An emergency lighting system shall provide illumination of the working area of every part of the lifting appliance normally accessible to operators and maintenance personnel, taking its supply from the emergency source of electrical power. Upon loss of the main power source, all emergency lighting shall automatically be supplied from the emergency source of power to ensure safe emergency operation and emergency escape.

Aircraft warning lights shall be installed on all lifting appliances representing a risk of obstruction for aircrafts. Illumination of working area shall be in accordance with NORSOK S-002, 5.6

5.4.65.4.5 Prevention of unexpected start-up

Powered lifting appliances shall have devices preventing unexpected start-up in accordance with EN 1037.

Lifting appliances with enclosed cabins and/or remote operated control stations, shall be equipped with a switch/device with which the operator can disable the main control levers.

5.4.75.4.6 Guards

Lifting appliances shall be equipped with fixed or moveable guards in accordance with EN 953 to protect persons from mechanical, thermal or other hazards as determined by the risk assessment or described in the annexes or references given in the annexes of this NORSOK standard.

5.4.85.4.7 Crushing hazard

For both operation and regular maintenance activities, exposed areas of lifting equipment shall be designed with safety zones and distances to prevent personnel being harmed or injured by moving parts. Reference is made to ISO 13857 and EN 349.

5.4.95.4.8 Falling objects

Any components fitted externally on lifting equipment and which may be subjected to vibrations or impacts from contact with other objects during operation, shall be analysed with respect to the hazard of falling objects. If such hazard is unacceptable, the components shall be secured with a double physical barrier against detachment.

NOTE An example of such mechanical component with a double physical barrier is a shackle pin secured in a shackle bow using a threaded nut locked by a split pin. Another example is an additional wire strap or a chain that is capable of catching and holding the falling object without damage.

Formatert: Note

Bolts used in lifting equipment shall normally be secured. Exceptions are bolts which represent no hazard.

The following methods/products are considered to be properly secured:

- ~~controlled~~ documented pretension to 70 % of yield; used for bolts where the clamping length is at least times the diameter;
- nut with split-pin through the bolt;
- through metal nuts;
- locking plates.

Formatert: Punktmerket + Nivå: 1 +
Justert ved: 0,25 cm + Innrykk ved:
0,75 cm

Other well proven methods and designs may also be used.

NOTE The handbook Best Practice Dropped Object Prevention issued by Working Together for Safety (SFS Samarbeid for sikkerhet) may be used for guidance.

5.4.105.4.9 Mechanical vibration and shock

Lifting equipment shall be evaluated for mechanical vibration and shock to humans in accordance with NORSOK S-002 and ISO 2631-1.

5.4.115.4.10 Handling and transport facilities

Lifting appliances shall be provided with facilities for handling and transport of major components, e.g. motors, gearboxes, pumps, sheaves, etc.

Detachable parts of lifting appliances weighing more than 25 kg shall be shaped to facilitate strapping or be equipped with attachment points, i.e. lifting lugs etc.

Reference is made to Annex B.

5.4.125.4.11 Hot surfaces

The temperature of hot surfaces (e.g. exhaust pipes and channels) shall not exceed the ignition temperatures of flammable mediums that can escape upon accidental leaks.

Shields and guards intended to prevent skin contact shall be fitted, if required.

5.5 Environmental conditions

5.5.1 Temperatures

The minimum and maximum operating temperatures shall be as specified in the annexes to this standard, unless otherwise agreed. The minimum and maximum operating temperatures shall be stated in the instructions for use.

The corresponding design temperature shall be determined by the manufacturer.

Lifting equipment designed to operate in cold climate where snow and ice may occur, shall be designed for minimum snow and ice accumulation and the instruction for use shall state any operational limitations caused by snow and ice.

5.5.2 Atmosphere

Lifting equipment shall be designed for operation in a marine atmosphere with 100 % relative humidity, unless otherwise agreed.

5.5.3 Radiation

Lifting equipment intended to be used in areas where it may be exposed to heat radiation from flares or burner booms etc., shall be fitted with heat radiation shielding and any operational limitations shall be stated in the instructions for use.

Wire ropes, sheaves etc., which are exposed to heat radiation shall be fitted with facilities for lubrication. Replacement intervals shall be compatible with local radiation levels. Lifting appliances shall be designed to limit radiation generation in accordance with EN 12198-2.

5.5.4 Wind

Where applicable for lifting appliances, wind loads shall be specified for both in service and out of service. Reference is made to specific requirements given in annexes for the equipment groups.

Where no specific wind loads are specified, the requirements stated in EN 13001-2, 4.2.3.1 and 4.2.4.2, apply.

5.5.5 Waves, sea induced motions and inclinations

Where applicable, lifting equipment shall be designed for dynamic impacts, load offsets and inclinations of the installation (on which the lifting equipment is located), that may occur when such equipment is in or out of service.

Reference is made to requirements in annexes for the equipment groups.

5.6 Operational loads

Lifting equipment except lifting accessories shall be designed for the in-service and out-of-service operational loads including the environmentally induced loads that may occur at/on the installation.

The operational limitations shall be stated in the instructions for use and in rated capacity information (e.g. load indicators, load tables, marking etc.) for the equipment.

5.7 Strength and stability – structure and mechanisms

5.7.1 General

The strength and stability of lifting equipment shall be calculated and documented in accordance with recognised international standards and design codes. If design standards are not specifically listed in the annexes, the method described in 5.7.2 to 5.7.6 shall be used.

5.7.2 Principles for proof of competence

Structural and mechanical strength of structural members and their connections, ropes, rope reeving components and load holding devices and other lifting components shall be documented by performing proof calculations in accordance with the principles of the limit state method described in EN 13001-1.

5.7.3 Loads, load actions, load combinations and load effects

Loads shall be selected/calculated, amplified by dynamic coefficients, multiplied by partial safety factors and superimposed into load combinations in accordance with EN 13001-2 in order to decide their resulting load effects in terms of upper and lower extreme values of nominal stresses or inner forces. Load combinations given in the annexes of this NORSOK standard shall be applied.

5.7.4 Limit states and proof of competence

The following parts of the CEN/TS 13001-3 series shall be used for the selection of limit design stresses/forces and for the proof of static strength, fatigue strength and elastic stability. The technical specifications listed below may also be applied to the selection of materials:

- EN13001-3-1 for structural members and welded, bolted and pinned connections;

Formatert: Punktmerket + Nivå: 1 +
Justert ved: 0,25 cm + Innrykk ved:
0,75 cm

- **CEN/TS** 13001-3-2 for wire ropes in reeving systems;
- prEN 13001-3-3 ¹⁾ for wheel/rail contact;
- CEN/TS 13001-3-5 for forged hooks.

Bolts of class 12.9 shall not be used in load bearing connections.

For fatigue design of steel structures DNV RP-C203 may be used as a supplement.

5.7.5 Mechanisms

Mechanisms are devices needed to start or stop a relative motion between two rigid parts of the lifting appliance, between the lifting appliance and its foundation, or between the lifting appliance and the lifted load. Thus motors, brakes, transmission systems and similar components are defined as mechanisms.

Strength of components that form parts of mechanisms shall be proved for loads defined in FEM 1.001, booklet 2, 2.5, applying the allowable stress method for the load combinations referenced in clause 5.7.3 of this standard. All partial safety factors shall be set to 1,0 for this purpose. If relevant (e.g. for lifting persons), the risk factor referenced in 5.9 shall be applied.

Components of mechanisms shall be checked for adequate safety against failure due to fracture, crippling, fatigue and excessive wear in accordance with FEM 1.001, booklet 4, 4.1.

Requirements given in EN 13135-2 shall also apply for certain components in mechanisms.

5.7.6 Brakes

Where the power transmissions of mechanisms are not able to hold the load or moveable part of a lifting appliance, a parking brake shall be provided. Unless otherwise stated in this NORSOK standard, brakes for slewing mechanisms, travel mechanisms, hoisting mechanisms and other winch driven mechanisms (e.g. luffing or telescoping) shall, in addition to the requirements of EN 13135-2, comply with the design requirements given in FEM 1.001, booklet 7, 7.5.3.

Brakes shall automatically be activated without undue delay when the motion control lever is returned to the neutral position, at power failure, control failure or at emergency stop.

5.8 Strength and stability – classification

The service condition should be specified according to EN 13001-1 by the following classification:

- | | |
|---------------------------|---------------------|
| • Working cycles | Classification of U |
| • Average displacement | Classification of D |
| • Load spectrum | Classification of Q |
| • Number of accelerations | Classification of P |

5.9 High risk applications

Lifting equipment intended to be used for the following high risk applications represent an increased severity of possible harm or extended harm in case of failure:

- Lifting of loads, moving the lifting appliance or parts of it, e.g. the boom, (with or without load) over pressurized or critical equipment, see Annex B.3.3 of this standard;
- Lifting of personnel;
- Lifting of certain loads that may represent severe consequences, such as e.g. explosives, flammables, dangerous chemicals or pressurised equipment.

NOTE: These high risk applications are also partly covered by clause 3.1.16 of NORSOK R-003 and R-005.

¹⁾ To be published.

Formatert: Punktmerket + Nivå: 1 +
Justert ved: 0,25 cm + Innrykk ved:
0,75 cm, Ikke juster avstand mellom
asiatisk og latinsk tekst

Formatert: Punktmerket + Nivå: 1 +
Justert ved: 0,25 cm + Innrykk ved:
0,75 cm

Formatert: Punktmerket + Nivå: 1 +
Justert ved: 0,25 cm + Innrykk ved:
0,75 cm

Formatert: Skrift: 8 pkt

Formatert: Innrykk: Venstre: 0 cm,
Hengende: 1,5 cm, Tabulatorstopp:
1,25 cm, Left + Ikke på 1,5 cm

Formatert: Skrift: 8 pkt

Lifting equipment for high risk applications shall be designed in order to reduce the probabilities and consequences of possible harm.

For lifting appliances, the relevant means addressed in clause 5.12.3 of EN13135-2 for high risk applications and the risk coefficient specified in EN13001-2, shall be evaluated and implemented, without causing additional risks.

In addition, Annex K (informative) describes means and methods to achieve an adequate level of safety for lifting appliances for high risk applications.

Development of new technology shall be subject to the requirements of Clause 4.15.

As a general rule, the risk coefficient for lifting of persons by using lifting appliances shall be taken as $\gamma_n = 1,5$.

As a general rule, the risk coefficient for lifting of persons by using lifting accessories shall be taken as $\gamma_n = 2,0$ unless the dynamic amplification factor has been determined for the particular case.

A verification level corresponding to at least Medium according to DNV-OSS-308 (or equivalent) should be applied, ref. 4.14.

Lifting appliances for high risk applications shall as a general rule be fitted with an EOS system in accordance with 5.15.3.

Other requirements for the high risk applications may be stated in the annexes.

NOTE: Equipment for lifting of persons which is supplied with an EC Type-examination certificate to the Machinery Directive is considered to have an adequate level of safety for that purpose, provided that this high risk application is confirmed by the manufacturer in the information for use.

Formatert: Innrykk: Venstre: 0 cm,
Første linje: 0 cm

5.10 Power systems

5.10.1 Electrical installations

Electrical powered lifting appliances shall be provided with relevant power supplies from the installation in accordance with NORSOK E-001.

Electrical installations of lifting appliances shall be in accordance with IEC 61892 (all parts).

5.10.2 Electrical motors

Electrical motors installed in lifting appliances shall be in accordance with applicable parts of IEC 60034.

5.10.3 Combustion engines

Combustion engines installed in lifting appliances shall be in accordance with EN 1679-1 and EN 1834-1.

Arrangement and exhaust of combustion engines shall be in accordance with the applicable area classification, see 5.3.

The requirements given in clause 5.5 of NORSOK R-001 apply to all combustion engines. In addition combustion engines shall have monitoring of exhaust gas temperature with temperature display at the crane driver's position. Audible and visual alarm shall be given at a temperature in accordance with engine manufacturer's specifications for max allowable exhaust gas temperature.

5.11 Electrotechnical equipment

Electrotechnical equipment of lifting equipment shall be in accordance with EN 13135-1, IEC 60204-1 and IEC 60204-32.

Minimum requirements for protection against water ingress and dust penetration to enclosures shall be as follows:

- For dry indoor located equipment areas: Grade ~~IP44~~IP20 according to IEC 60529
- For outdoor ~~located equipment~~: naturally ventilated areas and wash down areas : Grade IP56 according to IEC 60529
- other areas: IP 44 according to IEC 60529

← **Formatert:** Punktmerket + Nivå: 1 +
 Justert ved: 0,25 cm + Innrykk ved:
 0,75 cm

5.12 Non-electrotechnical equipment

Non-electrotechnical equipment of lifting equipment shall be in accordance with EN 13135-2.

5.13 Controls, control stations and control systems

Controls and control stations including any cableless controls, if relevant, shall be in accordance with EN 13557.

Control systems shall, as a general rule, be designed so that a fault in the control systems does not lead to a hazardous situation. Safety principles in IEC 60204-32 shall be applied.

Safety related parts of control systems for complex lifting appliances shall be in accordance with ISO 13849-1. Unless otherwise stated in this NORSOK standard or references made in the annexes, the required performance levels (PLr) for safety related parts of control systems shall be in accordance with Table 1. For definition of symbols, see ISO 13849-1.

Table 1 — Safety functions – required performance levels

Safety functions(hazard of malfunction)				
	Severity	Frequency/time of exposure	Possibility of avoiding the hazard	PLr
Emergency stop	S2	F1	P2	d
Limiters and indicators	S2	F1	P1	c

If the lifting appliance has safety related parts in control systems and safety functions not detailed in this NORSOK standard, the manufacturer shall determine the required performance level in accordance with ISO 13849-1, and demonstrate that the required performance level is achieved.

Programmable electronic systems shall follow the principles of ISO 17894.

If a lifting appliance is supplied with multiple control stations, only one station shall be available at a time.

5.14 Limiting and indicating devices

Limiting and indicating devices on lifting appliances shall be in accordance with EN 12077-2.

Visual danger signals shall be in accordance with EN 842.

5.15 Emergency systems

5.15.1 Emergency stop

Power operated lifting appliances shall be equipped with an emergency stop in accordance with ISO 13850.

5.15.2 Emergency lowering system

Power operated lifting appliances for suspended loads shall be equipped with an emergency lowering system in order to avoid hazard of swinging loads in the event of loss of normal lowering function. This system is not required if an emergency operation system is provided in accordance with 5.15.3.

The emergency lowering system shall enable a controlled lowering of the load upon a power failure, landing the load safely.

The activation switches or handles shall be of hold-to-run type, and shall be clearly and permanently marked. The control station for emergency lowering shall be positioned in a place that gives the operator a clear view of the load and the lifting zone. The system shall be simple to operate and shall be available without undue delay in order to avoid unacceptable risk. Unless a risk assessment justifies another value, emergency lowering should be able to land the load safely within 15 min after an unintended stop (including mobilising time for the system). A clear and unambiguous operation procedure for the system shall be included in the instructions for use and shall be permanently displayed at the control station.

5.15.3 Emergency operation system (EOS)

Lifting appliances for lifting of persons shall be equipped with an emergency operation system (EOS). Other lifting appliances may be required to be equipped with EOS in the specific annexes.

The system shall be able to move the load in any direction, in case of a main power failure or a control system failure, utilising a secondary independent power supply system and a secondary independent control system. The degree of independency is illustrated in Fig. 1:

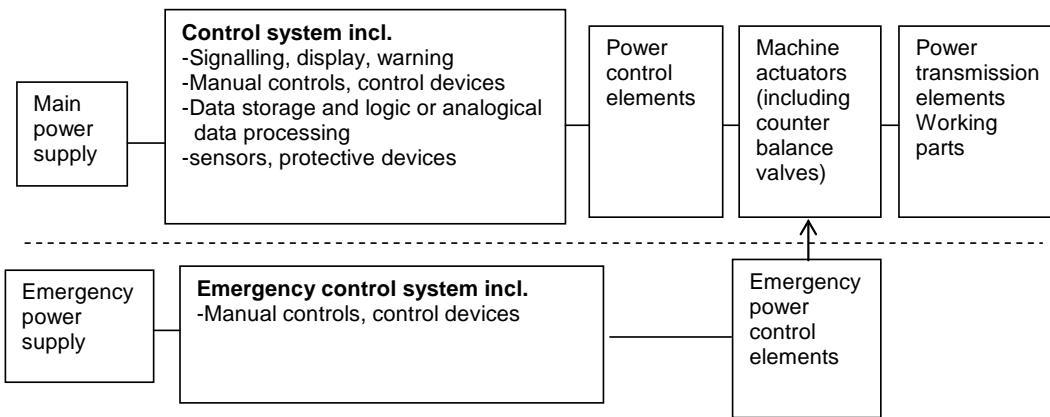

Fig. 1 Independency of emergency operation system-
NOTE For terminology, see EN ISO 12100.

The system shall be simple to operate and shall be available without undue delay in order to avoid unacceptable risk. Unless specified otherwise in the annexes the minimum hoisting and lowering speeds for SWL shall be 10 % of the minimum required speeds. Only one function may be operated at a time.

The control devices shall be of hold-to-run type, and shall be clearly and permanently marked. A separate emergency stop shall be provided for the emergency operation system.

A clear and unambiguous operation procedure for the system shall be included in the instructions for use and shall be permanently displayed at the control station.

Specific requirements applicable to different types of lifting appliances are given in the relevant annexes.

5.16 Communication

5.16.1 Telephone

Cranes and lifting appliances with an enclosed control station shall be fitted with a permanently installed telephone communication system.

5.16.2 UHF/VHF radio

Lifting appliances with an enclosed control station shall be fitted with permanently installed UHF and/or VHF radio facilities. It shall be possible for the crane driver to send/receive messages without removing the hands from the main control levers.

5.16.3 Loudspeaker/alarm horn

Lifting appliances with an enclosed control station shall be fitted with permanently installed external loudspeaker or alarm horn that can be operated by the crane driver without removing the hands from the main control levers.

5.17 Pneumatics

Pneumatic systems and components of lifting equipment shall be in accordance with EN ISO 4414.

5.18 Hydraulics

Hydraulic systems and components shall be in accordance with EN 4413.

The hydraulic system should be fitted with metallic tube connections for fluid power with elastomeric sealing rings in accordance with ISO 8434-1 or DIN 2354 combined with hydraulic pipes with cold formed tube ends. Cutting rings described in ISO 8434-1 or DIN 2354 should not be used. Cutting rings are normally the limiting factor for the working pressure tables of ISO 8434-1 / DIN 2354. When the tube fittings are used with cold formed tube ends the maximum working pressures may be increased. The maximum working pressure shall be confirmed and documented by the tube fitting manufacturer and the hydraulic pipe supplier.

Flexible hoses shall not be used between any load holding valves and hydraulic motors or cylinders.

Acceptance testing shall be performed in accordance with EN 4413 Clause 6, with the following additional test requirements:

- Hydraulic hoses for all pressure lines shall be pressure tested to 1.5 times the maximum working pressure for the system, limited to 70 Bar above the maximum working pressure.
- Piping and tube fittings according to above mention combination of industrial tube fittings and cold formed pipe ends may be ~~excepted~~omitted from pressure testing. The manufacturer of the lifting appliance shall however perform a one-time prototype test of each pipe dimension. The documented results shall be available on request.
- Piping and tube fittings other than above mention combination of industrial tube fittings and cold formed pipe ends shall be pressure tested to ~~to~~ 1.5 times the maximum working pressure of the system; limited to 70 Bar above the maximum working pressure.
- Hydraulic hoses and pipe fittings for the return lines and drain lines may be ~~excepted~~omitted from pressure testing.

NORSOK standard specifications for piping and pipe fittings for process plants and instrument tubing shall not be used for lifting appliances.

The test pressure holding time shall be minimum 5 min and the oil temperature shall be minimum 7 °C.

5.19 Electromagnetic compatibility (EMC)

5.19.1 EMC immunity

EMC immunity of lifting appliances shall be in accordance with IEC 61000-6-2.

5.19.2 EMC emission

EMC emission of lifting appliances shall be in accordance with IEC 61000-6-4.

5.20 Exhaust and noise emissions

Lifting appliances shall be designed for minimum noise emission according to ISO/TR 11688-1 and ISO/TR 11688-2. The A-weighted emission sound pressure level at the operator position with windows and doors

closed and the HVAC turned on, if applicable, shall be in accordance with the limits given in NORSOK S-002 Annex A.

~~Exhaust from combustion engines used in lifting appliances shall not exceed the allowable emission limits given in Directive 97/68/EC as amended by Directive 2002/88/EC and Directive 2004/26/EC.~~

5.21 Utility systems

5.21.1 Sight

Lifting appliances which have an enclosed control station shall have permanent means for window cleaning operated from inside the control station. In addition access means shall be provided for replacement of windshield wipers and manual cleaning of the windows from the outside.

5.21.2 Ventilation

Indoor climate of lifting appliances shall be in accordance with NORSOK S-002, 5.7.

5.21.3 Utility supplies

Lifting appliances shall have permanent arrangements for utility supplies (e.g. water, fuel, service air and electrical connections), as applicable. Details to be agreed upon.

Lifting appliances containing fuel, oil, grease etc. which represent a hazard to the environment, shall have permanent arrangements for enclosed drainage to tank.

5.22 Fabrication

Lifting ~~appliance~~equipment shall be fabricated in accordance with DNV Standard for certification of lifting appliances No. 2.22, ~~Ch.2, Section 2 Materials~~relevant sections regarding materials and fabrication, ~~unless stated otherwise in the annexes of this standard.~~ This includes e.g.

- material selection (unless selected in accordance with 5.7.4),
- material certificates,
- material quality,
- welding,
- forming (hot or cold),
- inspection and testing.

← **Formatert:** Punktmerket + Nivå: 1 +
Justert ved: 0,25 cm + Innrykk ved:
0,75 cm

For fabrication of foundations and suspensions, see requirements in Annex H.

5.23 Installation and assembly

Lifting appliances ~~and launching appliances for life saving equipment~~ shall be installed ~~and assembled~~ in accordance with the manufacturer's instructions.

Mechanical completion and commissioning should follow relevant parts of NORSOK Z-007.

Upon final installation, lifting appliances and launching appliances for life saving equipment shall be tested in accordance with the technical requirements of DNV Standard for ~~certification~~Certification of lifting appliances No. 2.22, ~~Ch.2, Section 2 Materials and fabrication, and relevant parts~~sections for testing, unless stated otherwise in the annexes of NORSOK Z-007this standard.

5.24 Corrosion protection

5.24.1 General

In selecting of materials and combination of materials used in lifting equipment, due consideration shall be given to environmental conditions with regards to risk of corrosion.

5.24.2 Surface preparation and protective coating

Surface preparation and protective coating shall be in accordance with NORSOK M-501 and/or ISO 12944-1.

5.24.3 Bolting

All bolts and nuts shall be made corrosion resistant either by stainless steel material quality, galvanizing (metalizing) or effective surface preparation and protective coating in accordance with 5.24.2.

All external bolt connections up to and including 10 mm diameter should be stainless steel A4 quality. Exceptions are bolts and nuts used on components subject to painting, and bolts used in special high yield connections such as hydraulic flanges, gear / hydraulic motor connections, boom flange bolts etc.

If bolts and nuts are galvanized, galvanizing shall be performed by the bolt/nut manufacturer or by a company approved by the bolt/nut manufacturer.

5.25 Technical construction file

5.25.1 General

A technical construction file shall be compiled by the manufacturer of lifting equipment.

The technical construction file shall address all requirements of this NORSOK standard, as applicable.

When 3rd party verification in accordance with 4.14 is agreed, the technical construction file shall be submitted to the 3rd party to the extent relevant for the agreed verification. The technical construction file shall be prepared and presented in such detail that a third party is able to perform a verification of the product according to the requirements of this NORSOK standard

5.25.2 Content

The technical file shall contain, as a minimum,

- unique identification details of the lifting equipment,
- design specification including design parameters,
- risk assessments including resulting risk reduction measures and residual risk level,
- applicable requirements for the lifting appliance,
- standards and codes used,
- technical information, such as GA drawings, detailed drawings with dimensions and cross sections relevant for strength analysis, material specifications, welding details, diagrams of power and control circuits, calculations, test reports etc.
- fabrication documentation, e.g. material certificates, fabrication procedures, welding documentation
- verification reports,
- formal statements, declarations and certificates,
- instructions for use, including inspection and maintenance instructions, including wear and tear tolerances, non-destructive examination (NDE) programmes if programs as applicable, and NDE programmes for examination after load tests performed during construction and installation.

← **Formatert:** Punktmerket + Nivå: 1 +
Justert ved: 0,25 cm + Innrykk ved:
0,75 cm

5.25.3 Instruction for use

The instruction for use shall be made available to the end user.

The instruction for use of lifting appliances shall be in accordance with EN 12644-1.

The instruction for use of lifting accessories shall be in accordance with EN 13155, 7.1.

The maintenance instructions shall include a maintenance programme in accordance with 4.9.

The maintenance instructions shall include information on training of operators and maintenance personnel. NDE programmes/programs shall be made both for regular inspections (if as applicable) and for examinations to be performed after overload testing during construction and installation.

In the case of complex lifting appliances, the information on training of operators and maintenance personnel shall take into account the local conditions on/at the installation and its location.

← **Formatert:** liste-bullet

Instruction for use shall include foundation reaction forces acting at the interface between the foundation and the lifting appliance. The foundation reaction forces shall include the load effects from the most severe load combinations applicable to the foundation interface, including dynamic factors and effects from environmental conditions and motions of the installation. Any partial safety factors, risk coefficients or consequence factors included in the given foundation reaction forces shall be clearly stated, ref. Annex H.

5-25-45.26 Marking

Unless otherwise specified in the annexes to this standard, or references given therein, all lifting equipment shall have the following marking:

- the business name and full address of the manufacturer,
- designation of the lifting equipment,
- designation of series or type,
- serial number,
- the year of construction, that is the year in which the manufacturing process is completed,
- any legal marking (e.g. CE-marking) if applicable

Lifting equipment designed and constructed for use in a potentially explosive atmosphere must be marked accordingly.

Lifting appliances shall be marked with their rated capacity (SWL "Safe Working Load"). For cranes, such marking shall be in accordance with EN 12644-2.

Lifting accessories shall be marked with their working load limit (WLL).

Lifting equipment must also be marked with full information relevant to its type and essential for safe use, as identified in the risk assessment.

Parts of lifting equipment that must be handled during use with other lifting equipment, its mass must be indicated legibly, indelibly and unambiguously.

Safety colours and safety signs of lifting equipment shall be in accordance with ISO 3864-1, ISO 3864-2, ISO 3864-3 and ISO 13200.

Formatert: Ingen punktmerking eller nummerering

Annex A (Normative) Launching and recovery appliances for life saving equipment

A.1 General (Group A)

A.1.1 Introduction

The requirements of this annex apply in addition to the requirements stated in sections 1-5 in the main part of this Standard. Some of the requirements given in this annex may require new and unproven technology. Unproven technical solutions shall be qualified in accordance with 4.15.

This annex contains technical requirements concerning lifting and lowering facilities of launching and recovery appliances for life saving equipment. This annex also covers suspension and hang-off points for lifesaving equipment and means of connection and release systems that are integral part of the ~~life saving~~ lifesaving equipment.

Reference is also made to NORSOK S-001 and NORSOK S-002.

This annex does not cover outfitting and other technical facilities that are not related to launching, hang-off or recovery of the ~~life saving~~ lifesaving equipment. For such equipment, reference is made to national and international regulations and equipment specific standards, e.g. DNV-OS-E406 for free fall lifeboats.

The supplier shall ensure that interfaces regarding operational and technical aspects between launching and recovery appliances, the installation and the lifesaving equipment are in compliance with this NORSOK standard.

The structural strength of launching and recovery appliances for lifesaving equipment shall comply with the requirements of this NORSOK standard. Dynamic coefficients and risk coefficients shall be applied in accordance with A.1.4, A.1.5 and A.1.6.

Launching and recovery appliances shall be in accordance with NMD Regulation 4 July 2007 No. 853 concerning evacuation and life-saving appliances on mobile offshore units, section 8. In addition, other specific sections from said NMD Regulations as referred to in this annex, apply. Certain requirements from the LSA Code become applicable through references in the said NMD Regulation. In case of conflicting requirements in this NORSOK standard and said NMD Regulation, the following applies:

- the most stringent requirements for structural and mechanical strength apply;
- otherwise the requirements of this NORSOK standard apply.

NOTE

NOTE 1: ~~Required rated capacity in said NMD Regulations may is in some cases different from required rated capacity in this standard. In such cases checking the strength according to NMD Regulations shall be done with reference to rated capacity required by those Regulations, whereas checking the strength according to this standard shall be done with reference to the rated capacity required by this standard.~~

NOTE 2: Whenever references are made to the said NMD Regulation, only those requirements of the referred ~~sections~~ sections which are related to launching or recovery appliances shall apply, as well as hang-off relief arrangement, release systems, means of connections and their attachment to the ~~life saving~~ lifesaving equipment. Any ~~requiorments~~ requirements in referred sections of NMD Regulation, which are related only to the ~~life saving~~ lifesaving equipment, which are not relevant for launching or recovery, are not within the scope of this standard.

For lifting accessories used in launching and recovery appliances for life saving equipment, reference is also made to Annex C.

For cranes used as launching and recovery appliances for life saving equipment, reference is also made to Annex G.

Formatert: Punktmerket + Nivå: 1 + Justert ved: 0,25 cm + Innrykk ved: 0,75 cm

Formatert: Ingen punktmerking eller nummerering

Formatert: Skrift: 8 pkt

Formatert: Skrift: 8 pkt

Formatert: Skrift: 8 pkt

Formatert: Skrift: 8 pkt

Formatert: Skrift: 8 pkt

The requirement for efficient hand gear for recovery of lifeboats and rescue boats given in the LSA code, section 6.1.2.6, is not comprised by this NORSOK standard.

Mechanical joining devices of hinged type shall not be used as hang off equipment or as means of connection belonging to any kind of life saving equipment or launching/recovery appliances for such equipment.

NOTE: Mechanical joining devices are often referred to as "connecting links".

Formatert: Skrift: 8 pkt

A verification level corresponding to at least Medium according to DNV-OSS-308 (or equivalent) should be applied, ref. 4.14.

Formatert: Skrift: 8 pkt

A.1.2 Group overview

Table A.1 lists the groups of launching and recovery appliances covered by this annex.

Table A.1 – Groups of launching and recovery appliances

Launching and recovery appliances for life saving equipment							
	Groups						
	Evacuation equipment					Rescue equipment	
	A.1 Free fall lifeboats	A.2 Lifeboats launched by falls and a winch	A.3 Escape chutes	A.4 Rafts	A.5 Escape lines	A.6 Rescue boats	A.7 Personnel transfer carriers

A.1.3 Structural and mechanical strength, proof of competence

Structural and mechanical strength of launching and recovery appliances for life saving equipment, their structural members, machinery, ropes, rope reeving components and means of connection shall be documented by performing proof calculations in accordance with the principles of the limit state method as described in 5.7.

Structural and mechanical strength of the means of connection which are integral parts of the life saving equipment and their anchorage to the life-saving equipment shall be documented in the same way.

The proof of competence shall be performed for the ULS and the ALS.

In addition, fatigue shall be checked in accordance with NORSOK N-003 and N-004 for load cycles induced by waves and wind.

A.1.4 Loads and operational limitations

A.1.4.1 Operational limitations

Launching and recovery appliances shall be designed to be installed, maintained, tested and used within the limitations described by the following sets of conditions:

- NLS (non- life saving) condition;
- LS (life-saving) condition.

Formatert: Punktmerket + Nivå: 1 +
Justert ved: 0,25 cm + Innrykk ved:
0,75 cm

The NLS condition is applicable for operation during installation and maintenance.

The LS condition is applicable for operation during a real life saving situation, i.e. evacuation or rescue.

The conditions are defined by

- environmental conditions in terms of max wind speed and max significant wave height,

Formatert: Punktmerket + Nivå: 1 +
Justert ved: 0,25 cm + Innrykk ved:
0,75 cm

- operational situations as sidelead and offlead,
- max static angle of heel for the installation in the damaged stability condition.

The NLS and LS conditions are defined in Table A.2.

The design temperature T_D shall be taken as $-20\text{ }^\circ\text{C}$, unless otherwise agreed.

It is the responsibility of the supplier of the ~~life-saving~~lifesaving equipment to ensure and document that safe operation can be achieved in the specified operational conditions. Care shall be taken to ensure that connecting and detaching the ~~life-saving~~lifesaving equipment to/from its launching and recovery appliance at sea can be done in a safe manner without exposing personnel to risk.

Table A.2 – NLS and LS conditions

Equip. group	NLS condition ^d				LS condition ^e			
	Max. wind speed ^a (m/s)	Max. sign. wave height, Hs (m)	Max. angle of heel in any direction (°)	Max. offlead/sidelead angle in any direction (°)	Max. wind speed ^a (m/s)	Max. sign. wave height, Hs (m)	Max. angle of heel in any direction ^b (°)	Max. offlead/sidelead angle in any direction (°)
A.1	10	1,0	Ref. Annex G, clause G.3.3 (cranes used offshore)	10	36	16	17	N/A
A.2	10	1,0		10	36	16	17	N/A
A.3	10	1,0		10	36	16	17	^c
A.4	10	1,0		10	36	16	17	N/A
A.5	15	N/A		10	36	N/A	17	N/A
A.6	10	3,0		10	17	6,0	N/A	17
A.7	10	3,0		10	17	6,0	N/A	17

^a Mean wind velocity, $v_m(z)$ at 10 m height above sea (10 min), see EN 13001-2, 4.2.3.1. Mean wind velocity shall be recalculated into 3 s gust winds at the actual height of the launching appliance above sea level.

Example: 17 m/s (10 min) corresponds to ~25 m/s (3 s gust wind).

^b The angle of heel for the damaged host facility shall be set to 17° unless other host facility specific values are known. For damaged host condition of 17° (or another known host specific value), the actions from environmental loads may be reduced by 20%. For intact host condition (0° heel), environmental load shall be applied without reduction.

^c Max angle of heel is considered to include offlead/sidelead

^d For the NLS condition, maximum values are to be understood as design criteria and corresponding operational limit for this condition. Higher values may be agreed for the NLS condition.

^e For the LS condition, maximum values are to be understood as design criteria, but not operational limits for life-saving.

A.1.4.2 Rated capacity

Unless otherwise stated in the subsequent clauses of this annex, the rated capacity for launching and recovery appliances shall be taken as the gross mass of a fully equipped life-saving equipment when boarded with its full complements of persons, i.e. crew and passengers.

For the purpose of calculating the rated capacity of launching and recovery appliances, the weight of each person in the life saving equipment (e.g. life boat, rescue boat) shall be set to 100 kg.

A.1.4.3 Loads and load combinations

Structural and mechanical strength of launching and recovery appliances shall be proved for loads and load combinations. The following tables shall be used instead of Table 10 in EN 13001-2:

- Group A.1: Tables A.3 and Table A.4
- Group A.2: Table A.5
- Group A.6: Table A.6

← **Formatert:** Punktmerket + Nivå: 1 +
Justert ved: 0,25 cm + Innrykk ved:
0,75 cm

Loads for the ULS shall be determined, based on the NLS and LS conditions.

Loads for the ALS shall be determined, based on extreme wind conditions, extreme wave conditions or earthquake. Extreme wind and wave conditions are conditions with mean wind velocity (10 min at 10 m

above sea) or wave height corresponding to 10 000 year return period. Extreme weather conditions are to be determined for the particular installation in accordance with NORSOK N-002.

ULS loads are to be determined for load combinations A, B and C with partial safety factors (γ_p) as defined in EN 13001-2.

ALS loads are complementary to the requirements in EN 13001-2. The ALS loads are entered into load combinations C2 and C8 in the above mentioned tables, with partial safety factors set to $\gamma_p = 1,0$

**Table A.3 – Load combinations for Group A.1 – Launching appliances for free fall lifeboats
Lifeboat in stowed position and launched by primary means of launching**

Categories of loads	Loads		Reference		Load combinations A				Load combinations B					Load combinations C				Formatert tabell
			EN 13001-2	NORSOK R-002	Partial safety factors γ_p	A1	A2	A4	Partial safety factors γ_p	B1	B2	B4	B5	Partial safety factors γ_p	C2	C3	C7	
Regular	Gravitation acceleration, Impacts	Mass of the launching appliance	4.2.2.1	-	*)	1	Φ_1	-	*)	1	Φ_1	-	-	*)	1	1	1	1
		Mass of the hoist load (NOTE 1)	4.2.2.2	-	1,34	1	Φ_3	-	1,22	1	Φ_3	-	-	1,1	1	-	-	1
		Masses of launching appliance and hoist load travelling on uneven surface	4.2.2.3	-	1,22	-	-	Φ_4	1,16	-	-	Φ_4	Φ_4	-	-	-	-	-
	Acceleration from drives other than hoist drive	Masses of the launching appliance and hoist load	4.2.2.4	-	1,34	-	-	Φ_5	1,22	-	-	Φ_5	-	-	-	-	-	-
	Displacements		4.2.2.5	-	**)	1	1	1	**)	1	1	1	1	**)	1	1	1	1
Occasional	Environmental actions (NOTE 4)	Wind loads	4.2.3.1	Table A.2	-	-	-	-	1,22	1	1	1	1	1,16	-	1	-	-
		Wave induced accelerations	-	-	-	-	-	-	1,22	1	1	1	1	-	-	-	-	-
		Snow and ice loads	4.2.3.2	-	-	-	-	-	1,22	1	1	1	1	-	-	-	-	-
		Temperature variations	4.2.3.3	-	-	-	-	-	1,16	1	1	1	1	1,05	1	-	-	-
	Skewing		4.2.3.4	-	-	-	-	-	1,16	-	-	-	1	-	-	-	-	-
Exceptional	Extreme wind – stowed position		4.2.4.2	A.1.4.3	-	-	-	-	-	-	-	-	-	1,0	1	-	-	-
	Static test load		-	A.1.14	-	-	-	-	-	-	-	-	-	1,1	-	1	-	-
	Test load for release mechanism		-	A.1.5.5	-	-	-	-	-	-	-	-	-	1,1	-	-	Φ_2	-
	Excitation of the foundation		4.2.4.8	A.1.4.3	-	-	-	-	-	-	-	-	-	1,0	-	-	-	1

	(NOTE 2)																		
Risk coefficient, γ_n (NOTE 3)	4.3.2	5.9	-	1,5	-	1,5	-	1,0											
*) See EN 13001-2, clause 4.3.3, 4.3.4 and Table 7										**) See EN 13001-2, 4.3.5									
NOTE 1	Mass of the hoist load shall be taken as rated capacity from A.2.3 for load combinations A1, A2, A4, B2, B2, B4 and B5. For load combination C2, the mass of hoist load may be taken as mass of empty lifeboat. For load combination C7, the mass of hoist load shall be taken as the test load for release mechanism.																		
NOTE 2	Accelerations resulting from earthquake or extreme wave with wave height corresponding to 10 000 year return period, whichever gives the highest accelerations, must be applied to both mass of the hoist load and mass of the launching appliance in all degrees of freedom for the particular installation.																		
NOTE 3	<u>The risk coefficient shall be applied to mass of the hoist load and moveable parts of mass of the launching appliance. Static parts of mass of the launching appliance need not be multiplied with the risk coefficient.</u>																		
NOTE 4	<u>3s gust wind shall be applied without simultaneous action from wave induced accelerations. Wave induced accelerations shall be applied in combination with simultaneous action from a mean wind speed averaged over a 60s period.</u>																		
Key																			
A1:	ULS: Suspended lifeboat with no wind or other environmental loads. This load combination shall be applied for lifeboat in stowed position suspended from each mechanism, i.e. primary means of launching, secondary means of launching, means of retrieval and hang-off relief arrangement. . For skidding arrangements, this load combination shall also be applied in the most unfavourable position at the skidding track during launching.																		
A2:	ULS: Sudden release of load (drop of lifeboat) as result of activating the release function of the primary means of launching. $\Phi_3 = -1,0$ to be applied for calculating the peak reaction load effects in the main structure caused by drop of lifeboat.																		
A4:	ULS: Travelling on an uneven surface or track with no wind or other environmental loads, if part of the launching sequence for primary means of launching.																		
B1:	ULS: Lifeboat in stowed position suspended from primary means of launching in the LS condition. For skidding arrangements, this load combination shall also be applied in the most unfavourable position at the skidding track during launching. For means of retrieval, secondary means of launching and hang-off relief arrangement, this load combination shall be applied for stowed position in the NLS condition.																		
B2:	ULS: Sudden release of load (drop of lifeboat) as result of activating the release function of the primary means of launching in the LS condition. $\Phi_3 = -1,0$ to be applied for calculating the peak reaction load effects in the main structure caused by drop of lifeboat.																		
B4:	ULS: Travelling on an uneven surface or track in the LS condition, if part of the launching sequence for primary means of launching.																		
B5:	ULS: Travelling on an uneven surface and skewing in the LS condition, if part of the launching sequence for primary means of launching.																		
C2:	ALS: Lifeboat in the stowed position suspended in primary means of launching in combination with loads from extreme wind conditions corresponding to wind speed with 10000 year return period.																		
C3:	ULS: <u>For Primary means of launching:</u> Static overload testing in NLS conditions with test load of 2,2 times the rated load for the particular mechanism capacity (see A.2.3), <u>i.e. primary means of launching and</u> . <u>For hang-off relief arrangement:</u> <u>Static overload testing in NLS conditions with test load of 2 times the rated capacity (see A.2.3).</u>																		
C7:	ULS: Dynamic impact in hang-off relief arrangement in case of testing the function of release mechanism for primary or secondary means of launching by dropping the lifeboat into the hang-off relief arrangement.																		
C8:	ALS: Lifeboat in the stowed position suspended in primary means of launching in combination with loads due to external excitation of the foundation.																		

Formatert tabell

Formatert: Ikke Hevet / S

**Table A.4 – Load combinations for Group A.1 – Launching appliances for free fall lifeboats
Lowering by secondary means of launching and hoisting by means of retrieval**

Categories of loads	Loads		Reference		Load combinations A			Load combinations B			Load combinations C		
			EN 13001-2	NORSOK R-002	Partial safety factors γ_p	A1	A3	Partial safety factors γ_p	B1	B3	Partial safety factors γ_p	C3	C6
Regular	Gravitation acceleration, Impacts	Mass of the launching appliance	4.2.2.1	-	*)	Φ_1	1	*)	Φ_1	1	*)	Φ_1 (NOTE 4)	1
		Mass of the hoist load (NOTE 1)	-	A.1.5.3	1,34	Φ_2	1	1,22	Φ_2	1	1,1	-	-
	Inertia forces due to acceleration from hoist drives		4.2.2.4	-	1,34	-	Φ_5	1,22	-	Φ_5	-	-	-
	Displacements		4.2.2.5	-	**)	1	1	**)	1	1	**)	1	1
Occasional	Environmental actions (NOTE 6)	Wind loads	4.2.3.1	Table A.2	-	-	-	1,22	1	1	1,16	1	-
		Snow and ice loads	4.2.3.2	-	-	-	-	1,22	1	1	-	-	-
		Temperature variations	4.2.3.3	-	-	-	-	1,16	1	1	-	-	-
Exceptional	Static and dynamic test load (NOTE 1)		4.2.4.3	A.1.14	-	-	-	-	-	-	1,1	Φ_6 (NOTE 2)	-
	Mass of the hoist load (NOTE 1) during emergency braking.			A.1.5.4	-	-	-	-	-	-	1,1	-	Φ_2
Risk coefficient, γ_r (NOTE 3 and 5)			4.3.2	5.9	-	1,5		-	1,5		-	1,0	← 1,5

*) See EN 13001-2, clause 4.3.3, 4.3.4 and Table 7 **) See EN 13001-2, 4.3.5

NOTE 1 Mass of the hoist load shall be taken as rated capacity from A.2.3 for load combinations A1, A3, B1 and B3. For load combination C3, mass of the hoist load shall be taken as the test load. For load combination C6, mass of the hoist load shall be taken as the rated capacity.

NOTE 2 For the dynamic load test, coefficient Φ_6 is to be calculated according to equation (A.3) with $V_R=0,5V_{Hmax}$. For the static load test, $\Phi_6 = 1$

NOTE 3 The risk coefficient of 1,5 is only applicable if lifting or lowering persons is part of the intended use, see A.2.4.2.1 and A.2.4.3, and when performing proof of competence with rated capacity for lifting persons, see A.2.3. When performing proof of competence with rated capacity (without persons), the risk coefficient may be set to 1,0.

NOTE 4 For dynamic overload testing Φ_1 is taken from EN 13001-2 clause 4.2.2.1. For static overload testing $\Phi_1 = 1$.

NOTE 5 The risk coefficient shall be applied to mass of the hoist load and moveable parts of mass of the launching appliance. Static parts of mass of the launching appliance need not be multiplied with the risk coefficient.

NOTE 6 3s gust wind shall be applied without simultaneous action from wave induced accelerations. Wave induced accelerations shall be applied in combination with simultaneous action from a mean wind speed averaged over a 60s period.

Key

- A1: ULS: Pick-up of lifeboat from sea with means of retrieval in NLS conditions without environmental actions from wind, snow/ice or temperature variations. The effect of waves shall be taken into account.
- A3: ULS: Acceleration of hanging lifeboat at start of descent or start of hoisting in NLS conditions without environmental actions from wind, snow/ice or temperature variations.
- B1: ULS: Pick-up of lifeboat from sea in NLS conditions in combination with environmental actions.
- B3: ULS: Acceleration of hanging lifeboat at start of descent or start of hoisting in NLS conditions with environmental actions from wind, snow/ice and temperature variations.
- C3: ULS: Static and dynamic overload testing in NLS conditions with the following test loads: ~~2,2~~ 2 times rated capacity for static load testing of structure, 1,5 times rated capacity for static load testing of winches, and 1,1 times rated capacity for dynamic load testing. The rated capacity for the particular mechanisms are specified in A.2.3C6:
ULS: Secondary means of launching with a test load equal to 1,1 times the rated capacity (with and without persons, see A.2.3) in combination with loads caused by emergency braking during lowering at full speed.

Table A.5 – Load combinations for Group A.2 – Launching appliances for lifeboats launched by falls and a winch

Categories of loads	Loads		Reference		Load combinations A			Load combinations B			Load combinations C							
					Partial safety factors γ_p	A1	A1	A3	Partial safety factors γ_p	B1	B3	Partial safety factors γ_p	C1	C2	C3	C6	C7	C8
Regular	Gravitation acceleration, Impacts	Mass of the launching appliance	4.2.2.1	-	*	Φ_1	1	1	*	Φ_1	1	*	Φ_1	1	Φ_1 (NOTE 4)	1	1	1
		Mass of the hoist load (NOTE 1)	-	A.1.5.3	1,34	Φ_2	1	1	1,22	Φ_2	1	1,1	-	1	-	-	-	1
	Inertia forces due to acceleration from hoist drives		4.2.2.4	-	1,34	-	-	Φ_5	1,22	-	Φ_5	-	-	-	-	-	-	-
	Displacements		4.2.2.5	-	**	1	1	1	**	1	1	**	1	1	1	1	1	1
Occasional	Environmental actions	Wind loads	4.2.3.1	Table A.2	-	-	-	-	1,22	1	1	1,16	-	-	1	-	-	-
		Wave induced accelerations	-	-	-	-	-	-	1,22	1	1	-	-	-	-	-	-	-
		Snow and ice loads	4.2.3.2	-	-	-	-	-	1,22	1	1	-	-	-	-	-	-	-
		Temperature variations	4.2.3.3	-	-	-	-	-	1,16	1	1	1,05	-	1	-	-	-	-
Exceptional	Re-entry during lowering	Mass of the hoist load (NOTE 1)	-	A.1.5.3	-	-	-	-	-	-	-	1,1	Φ_2	-	-	-	-	-
	Extreme wind – stowed position		4.2.4.2	A.1.4.3	-	-	-	-	-	-	-	1,0	-	1	-	-	-	-
	Static and dynamic test loads (NOTE 1)		4.2.4.3	A.1.14	-	-	-	-	-	-	-	1,1	-	-	Φ_6 (NOTE 2)	-	-	-
	Mass of the hoist load (NOTE 1) during emergency braking.		-	A.1.5.4	-	-	-	-	-	-	-	1,1	-	-	-	Φ_2	-	-
	Test load for release mechanism		-	A.1.5.5	-	-	-	-	-	-	-	1,1	-	-	-	-	Φ_2	-

Formatert: Innrykk: Vens cm
Formatert tabell

	Excitation of the foundation (NOTE 3)	4.2.4.8	A.1.4.3	-	-	-	-	-	-	-	1,0	-	-	-	-	-	1
Risk coefficient, γ_n		4.3.2	5.9	-	1,5	-	1,5	-	1,0	1,0	1,0	1,0	1,5	1,0	1,0	1,0	1,0

*) See EN 13001-2, clause 4.3.3, 4.3.4 and Table 7

**) See EN 13001-2, 4.3.5

Formatert tabell

NOTE 1 Mass of the hoist load is to be taken as the rated capacity as defined in A.1.4.2 for load combinations A1, A3, B1, B3 and C1. For load combination A11, the mass of hoist load shall be taken as 1,1 times the rated capacity as defined in A.1.4.2. For load combinations C2 and C8, the mass of hoist load may be taken as mass of empty lifeboat. For load combination C3, mass of the hoist load shall be taken as the test load. For load combination C6, the mass of the hoist load shall be taken as the test load of 1,1 times the rated capacity as defined in A.1.4.2.

NOTE 2 For the dynamic load test, coefficient Φ_6 is to be calculated according to equation (A.3) with $V_R=0,5V_{Hmax}$. For the static load test, $\Phi_6 = 1,0$

NOTE 3 Accelerations resulting from earthquake or extreme wave with wave height corresponding to 10 000 year return period, whichever gives the highest accelerations, must be applied to both mass of the hoist load and mass of the launching appliance in all degrees of freedom for the particular installation.

NOTE 4 For dynamic overload testing Φ_1 is taken from EN 13001-2 clause 4.2.2.1. For static overload testing $\Phi_1 = 1$.

Key

- A1: ULS: Pick-up of lifeboat from sea in NLS conditions without environmental actions from wind, snow/ice or temperature variations. The effect of waves on dynamic factor shall be taken into account
- A11: ULS: Lifeboat suspended from hang-off relief arrangement.
- A3: ULS: Acceleration of hanging lifeboat at start of descent or start of hoisting in NLS conditions without environmental actions from wind, snow/ice or temperature variations.
- B1: ULS: Pick-up of lifeboat from sea in NLS conditions in combination with environmental actions.
- B3: ULS: Acceleration of hanging lifeboat at start of descent or start of hoisting in NLS conditions with environmental actions
- C1: ULS: Re-entry during launching in LS conditions.
- C2: ALS: Lifeboat in the stowed position ready for launching in combination with loads from extreme wind conditions corresponding to wind speed with 10000 year return period.
- C3: ULS: Static and dynamic load testing in NLS conditions with a the following test loads: 2,2 times rated capacity for static load testing of structure, 1,5 times rated capacity for static load testing of winches, and 1,1 times rated capacity for dynamic load testing. The rated capacity is specified in A.1.4.2.
- C6: ULS: Launching appliance with a test load equal to 1,1 times the rated capacity (ref. A.1.4.2) in combination with loads caused by emergency braking during lowering at full speed in mode for maintenance and installation.
- C7: ULS: Dynamic impact in hang-off relief arrangement in case of testing the function of release mechanism by dropping the lifeboat into the hang-off relief arrangement.
- C8: ALS: Launching appliance with hoist load in combination with loads due to external excitation of the foundation

At the time of publication of this NORSOK standard, hoisting/lowering is the only motion of a typical launching and recovery appliance for lifeboats launched by falls and a winch. Table A.5 summarises the load combinations to be analysed for such appliances. A more detailed analysis of load combinations is needed for launching and recovery appliances with other movements. For such appliances, reference is made to EN 13001-2, Table 10.

Table A.6 – Load combinations for Group A.3 – Escape chutes

TO BE DEVELOPED

Table A.7 – Load combinations for Group A.4 – Rafts

TO BE DEVELOPED

Table A.8 – Load combinations for Group A.5 – Escape lines

TO BE DEVELOPED

Table A.9 – Load combinations for Group A.6 – Launching appliances for rescue boats

Categories of loads	Loads		Reference		Load combinations A			Load combinations B			Load combinations C ←						
			EN 13001-2	NORSOK R-002	Partial safety factors γ_p	A1	A11	A3	Partial safety factors γ_p	B1	B3	Partial safety factors γ_p	C1	C2	C3	C6	C8
Regular	Gravitation acceleration, Impacts	Mass of the launching appliance	4.2.2.1	-	*)	Φ_1	1	1	*)	Φ_1	1	*)	Φ_1	1	Φ_1 (NOTE 4)	1	1
		Mass of the hoist load (NOTE 1)	-	A.1.5.3	1,34	Φ_2	1	1	1,22	Φ_2	1	1,1	-	1	-	-	1
	Inertia forces due to acceleration from hoist drives		4.2.2.4	-	1,34	-	-	Φ_5	1,22	-	Φ_5	-	-	-	-	-	-
	Displacements		4.2.2.5	-	**)	1	1	1	**)	1	1	**)	1	1	1	1	1
Occasional	Environmental actions	Wind loads	4.2.3.1	Table A.2	-	-	-	-	1,22	1	1	1,16	-	-	1	-	-
		Wave induced accelerations	-	-	-	-	-	-	1,22	1	1	-	-	-	-	-	-
		Snow and ice loads	4.2.3.2	-	-	-	-	-	1,22	1	1	-	-	-	-	-	-
		Temperature variations	4.2.3.3	-	-	-	-	-	1,16	1	1	1,05	-	1	-	-	-
Exceptional	Re-entry during hoisting	Mass of the hoist load (NOTE 1)	-	A.1.5.3	-	-	-	-	-	-	-	1,1	Φ_2	-	-	-	-
		Extreme wind – stowed position	4.2.4.2	A.1.4.3	-	-	-	-	-	-	-	1,0	-	1	-	-	-
	Static and dynamic test loads (NOTE 1)		4.2.4.3	A1.15	-	-	-	-	-	-	-	1,1	-	-	Φ_6 (NOTE 2)	-	-
	Mass of the hoist load (NOTE 1) during emergency braking.		-	A.1.5.4	-	-	-	-	-	-	-	1,1	-	-	-	Φ_2	-
	Excitation of the foundation (NOTE 3)		4.2.4.8	A.1.4.3	-	-	-	-	-	-	-	1,0	-	-	-	-	1
Risk coefficient, γ_n			4.3.2	5.9	-	1,5			-	1,5		-	1,0	1,0	1,0	1,5	1,0

*) See NS-EN 13001-2, clause 4.3.3, 4.3.4 and Table 7

**) See EN 13001-2, 4.3.5

NOTE 1 Mass of the hoist load is to be taken as the rated capacity as defined in A.1.4.2 for load combinations A1, A11, A3, B1, B3 and C1. For load combination C6, mass of

the hoist load shall be taken as the test load of 1,1 times the rated capacity. For load combinations C2 and C8, mass of the hoist load may be taken as mass of the empty rescue boat.

NOTE 2 For the dynamic load test, coefficient Φ_6 is to be calculated according to equation (A.3) with $V_R=0,5V_{Hmax}$. For the static load test, $\Phi_6 = 1,0$

NOTE 3 Accelerations resulting from earthquake or extreme wave with wave height corresponding to 10 000 year return period, whichever gives the highest accelerations, must be applied to both mass of the hoist load and mass of the launching appliance in all degrees of freedom for the particular installation.

NOTE 4 For dynamic overload testing Φ_1 is taken from EN 13001-2 clause 4.2.2.1. For static overload testing $\Phi_1 = 1$.

Key

- A1: ULS: Pick-up of rescue boat from sea in NLS conditions without environmental actions from wind, snow/ice or temperature variations. The effect of waves on dynamic factor shall be taken into account.
- A11: ULS: Rescue boat suspended from hang-off relief arrangement.
- A3: ULS: Acceleration of hanging rescue boat at start of descent or start of hoisting in NLS conditions without environmental actions from wind, snow/ice or temperature variations.
- B1: ULS: Pick-up of boat rescue boat from sea in LS conditions in combination with environmental actions.
- B3: ULS: Acceleration of hanging rescue boat at start of descent or start of hoisting in NLS conditions with environmental actions.
- C1: ULS: Re-entry during hoisting in LS conditions.
- C2: ALS: Rescue boat in the stowed position ready for launching in combination with loads from extreme wind conditions corresponding to wind speed with 10 000 year return period.
- C3: ULS: Static and dynamic load testing in NLS conditions with a the following test loads: 2,2 times rated capacity for static load testing of structure, 1,5 times rated capacity for static load testing of winches, and 1,1 times rated capacity for dynamic load testing. The rated capacity is specified in A.1.4.2.
- C6: ULS: Launching appliance with a test load equal to 1,1 times the rated capacity (see A.1.4.2) in combination with loads caused by emergency braking during lowering at full speed, or triggering of the overspeed protection device (when provided), whichever gives the highest dynamic effect.
- C8: ALS: Launching appliance with hoist load in combination with loads due to external excitation of the foundation.

At the time of publication of this NORSOK standard, hoisting/lowering is the only motion of a typical launching and recovery appliance for rescue boats. Table A.9 summarises the load combinations to be analysed for such appliances. A more detailed analysis of load combinations is needed for launching and recovery appliances with other movements. For such appliances, reference is made to EN 13001-2, Table 10.

Table A.10 – Load combinations for Group A.7 – Personnel transfer carriers

TO BE DEVELOPED

Page intentionally left blank.

← **Formatert:** Annex-head2

A.1.4.4 Lateral loads on means of connection

In order to avoid failure of means of connection ~~and their anchorage in hull~~ as result of a moderate deviation in direction of forces, ~~a lateral (out-of-plane) force~~ ~~the proof of competence calculations for of connection forming part of the lifesaving equipment shall be applied~~ take into account a deviation angle of 17° in the most unfavourable direction ~~to means of connection that are rigidly connected to the life saving equipment. The lateral force shall not be less than 10% of the part of from the maximum static weight of the life saving direction corresponding to statically suspended lifesaving equipment to be carried by the means of connection. The lateral force shall act at the point of contact with the means of forming part of the launching appliance, and shall be considered as mass of the hoist load in terms of dynamic factors and partial safety factors given in A.1.4.3 and A.1.5.~~

Formatert: Standardskrift for avsnitt

Formatert: Standardskrift for avsnitt

Formatert: Standardskrift for avsnitt

Formatert: Standardskrift for avsnitt

Formatert: Standardskrift for avsnitt

A.1.4.5 Clearance to structure

Launching and recovery appliances for life saving equipment on non ship-shaped installations shall be arranged and located to give a minimum safe clearance to structure.

The minimum safe distance measured from the nearest edge of the life-saving equipment to installation structure when the ~~life saving~~ lifesaving equipment is hanging vertically below the suspension point with no heel or trim of the host installation, are given in table A.11.

Table A.11 – Minimum safe distances

Type	Min. distance
A.2, A.3, A.4	$\tan 20^\circ \times H$
A.6	$\tan 15^\circ \times H$, minimum 8m

Where H is the ~~height~~ height from stored position to sea

A.1.5 Dynamic effects

A.1.5.1 General

The dynamic effects resulting from inertial effects during acceleration of drives and hoisting and gravity effects are generally given as various dynamic coefficients, Φ . All dynamic coefficients shall be calculated in accordance with EN 13001-2, except Φ_2 which shall be calculated in accordance with the requirements of this annex. Φ_2 may vary for each load combination as described herein.

If necessary, means shall be provided to limit the dynamic coefficient Φ_2 to the following maximum values:

- 2,5 for life saving equipment where personnel is standing;
- 4,0 for life saving equipment where personnel is sitting with seat belts.

Formatert: Punktmerket + Nivå: 1 + Justert ved: 0,25 cm + Innrykk ved: 0,75 cm

For the purpose of limiting the dynamic coefficient Φ_2 , the following means may be applied:

- additional elastic elements to reduce the total system stiffness, e.g. an elastic pennant placed between the hoist medium and means of connection;
- passive shock absorbers forming integral part of the launching appliance, its hoisting machinery or the means of connection (either part of the launching appliance or part of the ~~life saving~~ lifesaving equipment).

Formatert: Punktmerket + Nivå: 1 + Justert ved: 0,25 cm + Innrykk ved: 0,75 cm

For the purpose of strength calculations, the minimum dynamic coefficient Φ_2 shall be no less than 1,5 in any load combinations.

A.1.5.2 Dynamic coefficient Φ_2 for load combination A1 and B1 (pick-up from sea)

Offshore there will be relative motions between the base of the lifting appliance and the ~~life saving~~ lifesaving equipment lifted from or lowered to the sea. For calculation of inertial and gravity effects

acting on the hoist load at the time of pick-up from sea in load combinations A1 and B1, the dynamic coefficient ($\Phi_{2,A1}$ or $\Phi_{2,B1}$) shall be calculated in accordance with equation (A.3).

A.1.5.3 Dynamic coefficient Φ_2 for load combination C1 (re-entry)

Re-entry implies that the launching appliance is reloaded due to the wave motions if the release mechanism does not open after the ~~life-saving~~ lifesaving equipment has landed on the sea, or during hoisting if hoisting velocity is less than the vertical wave velocity. Re-entry during hoisting is considered more unfavourable than re-entry during lowering.

The dynamic coefficient $\Phi_{2,C1}$ for re-entry is the ratio between the maximum dynamic force created in hoist rope(s) during re-entry, and the mass of hoist load. Equation (A.3) may be used as a simplified method for calculating $\Phi_{2,C1}$. If the simplified method does not sufficiently limit the dynamic coefficient according to the limit values stated above, the maximum force created in the hoist rope(s) shall be determined by a more detailed study, e.g. calculations, simulations or model tests, taking into account the wave period, the lowering or hoisting speed, the stiffness of the launching and recovery appliance and the moment of inertia of the winch drum.

A.1.5.4 Dynamic coefficient Φ_2 for load combination C6 (emergency cut-out)

The dynamic coefficient $\Phi_{2,C6}$ for the impact on the hoist load occurring when lowering at full speed and activating emergency stop, or triggering an overspeed protection device (when provided), in the upper position, shall be calculated in accordance with equation (A.4).

If the value F_{bra} necessary for calculating $\Phi_{2,C6}$ is not known by measurements, $\Phi_{2,C6}$ may be calculated according to equation (A.3) with $v_R = v_{Hmax}$ (or v_R set to triggering speed for overspeed protection device, when provided).

A.1.5.5 Dynamic coefficient Φ_2 for load combination C7 (test of release mechanism)

If the release mechanism of lifeboats is to be tested when the lifeboat is hanging in the stowed position with hang-off relief arrangement connected, the impact caused by sudden drop into the hang-off relief arrangement shall be taken into account by applying a dynamic coefficient $\Phi_{2,C7}$. The maximum dynamic force in the hang-off relief arrangement shall be established based on an equation for energy conservation from kinetic to potential energy, taking into account the stiffness of the hang-off relief arrangement, the possible drop height and pretension of the hang-off relief arrangement. The dynamic coefficient $\Phi_{2,C7}$ is the ratio between the maximum dynamic force and the weight of the hoist load.

A.1.5.6 Use of shock absorbers

~~If shock~~ Shock absorbers are needed may be used to limit the dynamic force during any of the above situations, the dynamic coefficient shall be calculated as the ratio between the maximum dynamic force created in hoist rope(s) during the stroke of the absorbing element and the weight of the hoist systems.

Formatert: Ikke juster avstand mellom asiatisk og latinsk tekst, Ikke juster avstand mellom asiatisk tekst og tall

~~The shock absorber must be designed and adjusted to work in the actual load range (normally between F_0 and F_{max}).~~

The dynamic factor is determined as:

$$\psi = \frac{F_{max}}{F_0} \quad \psi = \frac{F_{max}}{F_0} \quad (A.1)$$

Formatert: Skrift: Arial, 10 pkt

Formatert: Skrift: Arial, 10 pkt

Formatert: Tabulatorstopp: Ikke på 15 cm

Formatert: Skrift: Arial, 10 pkt

where:

F_0 is the static force at hook

Formatert: Ikke Hevet / Senket

F_{max} is the maximum dynamic force at hook

Formatert: Ikke Hevet / Senket

F_{max} is calculated from the energy equation (A.2), see Figure A.1

Formatert: Normal

$$\frac{1}{2} \cdot m \cdot v_R^2 = \int_{x_0}^{x_{max}} (F(x) - F_0) dx \quad (A.2)$$

The dynamic force in a single mass hoisting system equipped with a shock absorber may in principle be described as a function of time:

$$F(t) = kx + cv + ma \quad (A.2)$$

where:

- k = stiffness of the hoisting system
- $m = F_0/g$ = total mass at hook of hoist load
- v_R is the relative velocity between hook and deck at liftoff
- c = damping coefficient
- x_0 is the vertical deflection at hook due to static load
- x_{max} is the vertical deflection at hook due to dynamic load
- $F(x)$ is the force at hook as a function of the vertical deflection at hook
- $F_{(x_{max})} = F_{max}$

- v = velocity of hoist load
- a = acceleration of hoist load

During an excitation of a hoisting system equipped with a shock absorber which is designed to work efficiently in the actual load range, the maximum dynamic force in the system will be reduced compared with a system without a shock absorber.

Figure A.1 - Effect of shock absorber

Formatert: Skrift: ArialMT, 9,5 pkt, Fet

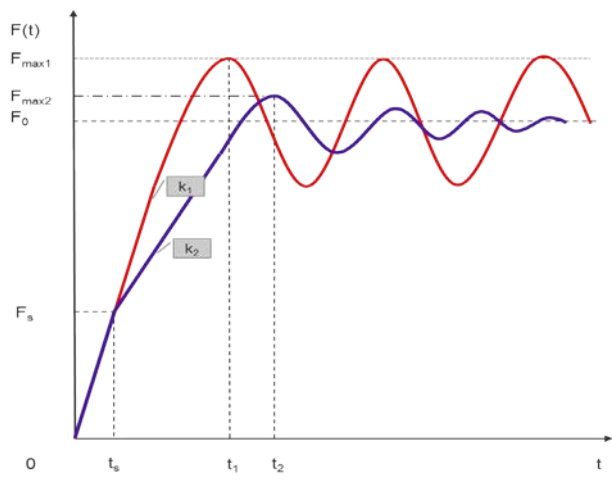

Formatert: Skrift: ArialMT, 9,5 pkt

Formatert: Ikke juster avstand mellom asiatick og latinsk tekst, Ikke juster avstand mellom asiatick tekst og tall

where:

- $F(t)$ = Force at hook
- F_{max1} = Maximum dynamic force at hook without shock absorber

- F_{max2} = Maximum dynamic force at hook with shock absorber
- F_0 = Static force at hook
- F_s = Force when shock absorber stroke motion starts
- 0 = Hook unloaded
- t = time
- t_s = time when the shock absorber stroke motion starts
- t_1 = time at maximum dynamic force at hook without shock absorber
- t_2 = time at maximum dynamic force at hook with shock absorber
- k_1 = stiffness at hook without shock absorber
- k_2 = stiffness at hook with shock absorber

The effect of shock absorber may be taken into consideration in the calculations of the dynamic factor provided that test results from representative testing at realistic conditions indicate that the maximum dynamic forces at hook are significantly and durably reduced.

Such calculations may be done by computer simulations and the theory of logarithmic decrement.

The reliability of shock absorbers shall be ensured by maintenance programs and condition monitoring.

Formatert: Ikke juster avstand mellom asiatisk og latinsk tekst, Ikke juster avstand mellom asiatisk tekst og tall

Formatert: Ikke juster avstand mellom asiatisk og latinsk tekst, Ikke juster avstand mellom asiatisk tekst og tall

Formatert: Normal, Ikke juster avstand mellom asiatisk og latinsk tekst, Ikke juster avstand mellom asiatisk tekst og tall, Tabulatorstopp: Ikke på 15,25 cm

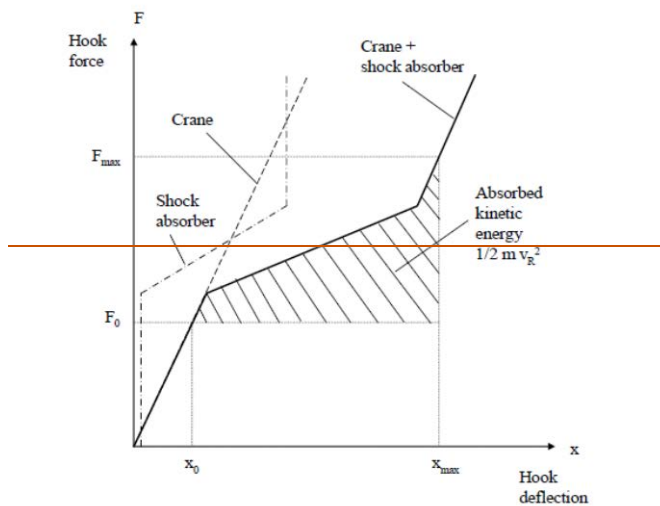

A.1.5.7 Expressions for dynamic coefficient Φ_2

$$\phi_2 = 1 + k_{\Delta} \cdot v_R \cdot \sqrt{\frac{C}{g * R_n}} \quad (\text{A.3})$$

$$\phi_2 = \frac{F_{bra}}{R_n} \quad (\text{A.4})$$

where

- C is the stiffness (in N/m) (weight of hoist load divided by the corresponding hook deflection)
- R_n is the rated capacity (in N) (static weight of the hoist load, i.e. the [life-saving/lifesaving](#) equipment)
- v_R is the relative velocity (in m/s) between the load and hook at the time of pick-up
- g is the gravity acceleration (9,81 m/s²)
- F_{bra} is the maximum rope force (in N) at emergency braking during lowering at full speed in the upper position
- k_{Δ} is a reduction factor depending on the shape of the particular [life-saving/lifesaving](#) appliance (e.g. rescue boat, life boat, life raft) to be lifted out of the sea water, taking into account that lift off from water gives a gradually increased dynamic load compared to an immediate load lift off from e.g. a boat deck. The value of this factor is to be set to 1,0 by default, unless a lower value has been demonstrated by tests.

v_R shall be calculated as follows:

$$v_R = v_H + \sqrt{v_D^2 + v_C^2} \quad (\text{A.5})$$

where

- v_H is $+0,5 \cdot v_{Hmax}$ for pick-up in waves with stepless variable speed control
- v_H is $+1,0 \cdot v_{Hmax}$ for pick-up in waves with variable speed in 2 or more steps
- v_H is $+1,0 \cdot v_{Hmax}$ for re-entry during hoisting
- v_H is $-1,0 \cdot v_{Hmax}$ for re-entry during lowering
- v_{Hmax} is the maximum steady state hoisting or lowering velocity (in m/s) for the rated capacity to be lifted or lowered
- v_D is the vertical velocity (in m/s) of the sea surface or deck on which the life saving equipment is located given by equation (A.6)
- v_C is the vertical velocity (in m/s) of the lifting appliance due to wave motions given by expression (A.7). If the actual velocity for the host installation in question is known and less than v_C given by expression (A.7), the [actual/actual](#) velocity may be used instead provided that value can be documented.

$$v_D = \frac{K_1 * H_s}{H_s + K_2} \quad (\text{A.6})$$

$$v_C = K_3 * H_s \quad (\text{A.7})$$

where

- H_s is the significant wave height for the operational limitation in m
- $K_1 = 5,3$ (m/s)
- $K_2 = 5,5$ (m)
- $K_3 = 0$ for bottom fixed installations (/s)

$K_3 = 0,25$ for semi submersible installations (/s)
 $K_3 = 0,50$ for monohull installations (FPSO, etc.) (/s)

The stiffness (C) of the launching and recovery appliance shall be calculated taking into account all elements from the means of connection via the ropes through to the support structure. Elastic pennant, if installed, may also be taken into consideration.

$$\text{Stiffness may be calculated according to: } C = \frac{R_n}{\sum \Delta L_n} \quad (\text{N/m}) \quad (\text{A.8})$$

where
 $\sum \Delta L_n$ is the sum of all the contribution to the total hook deflection in m.

For steel wire ropes the elastic deflection may be taken from the following equation:

Elastic deflection of rope [m]:

$$\Delta L_s = \frac{R_n \cdot L_w}{E_w \cdot A_w \cdot 10^3} \quad (\text{m}) \quad (\text{A.9})$$

where

L_w is the rope length in mm

NOTE 1 For recovery (pick-up) operations, the rope length shall be calculated with the means of connection at 1 m above the lowest operational level. For emergency braking, the elevation of the means of connection should be taken to be not lower than 3 m below the upper position.

NOTE 2 Equation (A.9) is based on single fall. For multiple falls, the number of falls must be taken into account.

E_w is the modulus of elasticity as specified by the rope manufacturer for steel wire ropes in N/mm^2

Area of rope [mm^2]:

$$A_w = \frac{\pi \cdot D_w^2}{4} \cdot C_F \quad (\text{A.10})$$

where

D_w is the nominal rope diameter in mm

C_F is the fill factor of the actual nominal rope construction

A.1.6 Hoisting and lowering velocities

Hoisting and lowering velocities shall be in accordance with Table A.12.

Table A.12 – Hoisting and lowering velocities for launching and recovery appliances

Group		Lowering	Hoisting
NLS condition			
A.1	Sec. means of launching	V_{Hmin}	
	Means of retrieval		V_{Hmin}
A.2		V_{Hmin}	V_{Hmin}
A.6		As for LS condition	As for LS condition
LS condition			
A.1	Sec. means of launching		
	Means of retrieval		
A.2		1,0 m/s ± 10%	
A.6		V_{Hmin}	V_{Hmin}

For group A.1 and A.2, $V_{Hmin} = 0,2$ m/s for the transport phase between stowed position and sea level (up or down). For the phase where the ~~life-saving~~ lifesaving appliance is lifted out of sea or landed at sea, V_{Hmin} shall be calculated in accordance with formula A.11.

For group A.6, V_{Hmin} shall be calculated in accordance with formula A.11 both for the transport phase and for lift-off / landing at sea.

$$V_{Hmin} = K_0 * \sqrt{V_D^2 + V_C^2} \quad (A.11)$$

where:

~~For group A.1 and A.2:~~

- ~~Lifeboats arranged for horizontal lifting with 2 point lifting:~~
 - ~~$K_0 = 0,5$ for loads in the range 0-50% of rated capacity for group A.1 and A.2~~
- ~~Lifeboats arranged to enable pivoting around a transverse axis during lifting:~~
 - ~~$K_0 = 0,3$ for loads in the range 0-50% of rated capacity~~

For group A.6:

- $K_0 = 0,5$ for loads in the range 0-100% of rated capacity for group A.6
- V_D is given by equation (A.6)
- V_C is given by equation (A.7)

Formatert: Skrift: Calibri, 11 pkt

Formatert: Mellomrom Etter: 10 pkt, Ikke legg til avstand mellom avsnitt med samme stil, Linjeavstand: Flere 1,15 li, Punktmerket + Nivå: 2 + Justert ved: 2,27 cm + Innrykk ved: 2,9 cm, Tabulatorstopp: Ikke på 1 cm + 13,69 cm

Formatert: Skrift: Calibri, 11 pkt, Engelsk (USA)

Formatert: Punktmerket + Nivå: 1 + Justert ved: 0,63 cm + Innrykk ved: 1,27 cm

A.1.7 Risk coefficient according to EN 13001-2, 4.3.2

For the lifting of personnel all single critical load carrying structure and all machinery components including wire ropes, means of connection and their anchorage in the life saving equipment shall be designed with a risk coefficient of

$\gamma_n = 1,5$, in accordance with 5.9.

For load combinations not related to lifting of persons, the risk coefficient may be set to $\gamma_n = 1,0$. Reference is made to load combinations described in tables in clause A.1.4.3 for detailed application of risk coefficient.

NOTE This requirement addresses the subject of increased mechanical strength during the lifting of persons, see Machinery Directive, Annex I, Clause 6.1.1.

A.1.8 Limit states and proof of competence

A.1.8.1 General

The characteristic resistance (R_k) of material, members, connections and components shall be derived from the subsequent sections or references given in the subsequent sections. The limit design resistance (R_d), in terms of stresses and forces, to be applied for the proof of competence, shall be based on the characteristic resistance and resulting resistance coefficients (γ_R) as described herein or as described in the references given.

In general the limit design resistance is expressed as:

$$R_d = \frac{R_k}{\gamma_R} \quad (\text{A.12})$$

NOTE₃ The characteristic resistance may be different properties for different materials, e.g. yield limit for some components and breaking strength for other components.

Formatert: Skrift: 8 pkt

Formatert: Innrykk: Venstre: 0 cm,
Første linje: 0 cm

Formatert: Skrift: 8 pkt

A.1.8.2 Structural members and connections

For launching appliances and load bearing parts of life saving equipment (e.g. anchorage for means of connection), the limit design resistance for structural members and their bolted, pinned and welded connections shall be taken from the following references:

- Steel structures: EN13001-3-1, Cranes – General design – Part 3-1
- Aluminium structures: EN 1999-1-1
- Composite structures: DNV-OS-E406 Sec. 6 C

Formatert: Punktmerket + Nivå: 1 +
Justert ved: 0,25 cm + Innrykk ved:
0,75 cm

Composite materials shall be selected and documented in accordance with criteria given in Sec. 5 of DNV-OS-E406. Methods described in DNV-OS-C501 may be used to calculate and document their material properties.

Means of connection made from rolled structural steel or aluminium are considered as structural members.

A.1.8.3 Ropes, chains, means of connections and other lifting components

A.1.8.3.1 General

The characteristic resistance (R_k) of ropes, chains, means of connection and other lifting components shall be their breaking force. The design strain (S_d) for these components shall be calculated for all relevant load combinations listed in Table A.3 to Table A.10.

A.1.8.3.2 Steel wire ropes in running reeving systems

Rope length

Steel wire ropes used for launching of life saving equipment to sea shall have a minimum effective length which takes into account the most unfavourable situation such as inclination of the installation or lowest astronomical tide, the lowest point of wave trough and drift off in LS condition according to Table A.2.

NOTE: The lowest point of wave trough should be taken as $1xH_s$ below sea level.

Formatert: Skrift: 8 pkt

Formatert: Skrift: 8 pkt

Rope reeving

Single fall rope reeving should be used, unless it can be verified that sufficient measures are provided to avoid twisting of multiple rope falls.

Formatert: Skrift: Fet, Ingen understreking

Formatert: Normal

Strength requirements

Rope strength shall be checked for 2 conditions:

- Running reeving systems, and
- Straight pull at end terminations

For ropes in running reeving systems, the characteristic resistance (R_k) shall be taken as their breaking force (F_u).

For ropes at end terminations, the characteristic resistance (R_k) shall be taken as $F_u \times \gamma_e$, where γ_e is the end termination factor, with the following values:

- Ferrules and ferrule-securing according to EN 13411-3: $\gamma_e = 0,9$
- Metal and resin socketing according to EN 13411-4: $\gamma_e = 1,0$
- Asymmetric wedge sockets according to EN 13411-6: $\gamma_e = 0,8$
- Symmetric wedge sockets according to EN 13411-7: $\gamma_e = 0,8$

Formatert: Punktmerket + Nivå: 1 + Justert ved: 0,25 cm + Innrykk ved: 0,75 cm

The minimum tensile strength for steel wire ropes shall be $1\,770\text{ N/mm}^2$, and the maximum tensile strength shall be $1\,960\text{ N/mm}^2$ according to EN 12385-4.

Wire ropes shall be of rotation resistant construction with steel core according to EN 12385-1, EN 12385-2, EN 12385-3 and EN 12385-4.

Limit states and proof of competence of ropes in running reeving systems shall be calculated according to **CEN/TS EN** 13001-3-2.

Note Friction forces in the reeving system need not be included for the lowering operation where it will function as an additional friction brake. For recovery operation the friction forces shall be included where appropriate.

The design strain (S_d) for ropes is the rope force ($F_{Sd,s}$) resulting from the load actions. The limit design resistance for ropes is the limit design rope force ($F_{Rd,s}$), expressed as

$$F_{Rd,s} = \frac{F_u}{\gamma_{rb}} \quad (A.13)$$

where

$F_{Sd,s}$ is the design rope force according to [CEN/TSEN 13001-3-2](#), clause 5, as resulting from the load combinations in this NORSOK standard

$F_{Rd,s}$ is the limit design rope force

F_u is the minimum breaking force as specified by the rope manufacturer

γ_{rb} is the minimum rope resistance factor according to [CEN/TSEN 13001-3-2](#), 5.4, (minimum 2,0).

The proof of static strength of steel wire ropes shall be as follows:

$$F_{Sd,s} \leq F_{Rd,s} \quad (A.14)$$

NOTE Proof of fatigue strength in accordance with [CEN/TSEN 13001-3-2](#), clause 6, is not considered necessary for group A. For these appliances corrosion will normally be the governing replacement criterion.

Bending diameters

The bending diameter ratio (D/d) on rope sheaves and drums shall be minimum 16

Terminations of wire ropes

Terminations of wire ropes shall be in accordance with the following standards:

- Ferrules and ferrule-securing EN 13411-3
- Metal and resin socketing EN 13411-4
- Asymmetric wedge sockets EN 13411-6
- Symmetric wedge sockets EN 13411-7

← **Formatert:** Punktmerket + Nivå: 1 + Justert ved: 0,25 cm + Innrykk ved: 0,75 cm

A.1.8.3.3 Chains, means of connection and other lifting components

Standardised, metallic components

Standardised components, such as chains, [shackles](#), links, forged steel components and forged hooks shall be ~~of grade 8 complying with~~ [according to Annex C and](#) the following ~~standards:~~ [additional requirements:](#)

- ~~Chains:~~ [EN 818-2](#)
- ~~Forged steel components:~~ [charpy v-notch tested to minimum. 42J at -20 °C.](#)
- ~~shackles of grade 8 according to~~ [EN 1677-1 should be used](#)
- ~~Forged hooks with latch:~~ [EN 1677-2](#)
- ~~Links:~~ [EN 1677-4](#)

← **Formatert:** Normal, Punktmerket + Nivå: 1 + Justert ved: 0 cm + Innrykk ved: 0,63 cm

These components shall be selected with a breaking force resulting from the following equations, whichever gives the greatest breaking force:

$$BF \geq M \cdot g \cdot 6 \quad (A.15)$$

$$BF \geq M \cdot g \cdot \phi_2 \cdot \gamma_p \cdot \gamma_n \cdot \gamma_{rb} \quad (A.16)$$

where

- BF is the minimum required breaking force (kN) for the selection of components
- M is the mass of hoist load (tonnes) for the particular load combination
- g = 9,81 m/s² is the gravity constant
- Φ₂ is the dynamic factor for the particular load combination
- Y_p is the partial safety factor for the particular load combination
- Y_n is the risk coefficient, i.e. 1,0 or 1,5 as applicable in accordance with the particular load combination
- Y_{rb} = 1,8 is the component resistance factor

For hook shaped components made of steel forgings, the proof of competence may alternatively be performed in accordance with CEN/TS 13001-3-5 with the following additional requirement:

Specific resistance coefficient shall be set to $\gamma_{sm} = 1,0$.

Non-standardised, metallic components

Means of connection made from components that are not shaped in accordance with any standardised components and which are not made from rolled structural steel or aluminium (ref. A.1.8.2), shall have a breaking force equal to that required for standardised components. In addition these components shall be able to withstand a manufacturing proof force (MPF) without permanent deformation. The manufacturing proof force shall be:

$$MPF \geq \frac{BF}{1,6} \quad (A.17)$$

Standardised non-metallic components

Standardised non-metallic components, such as roundslings or slings made from man-made or natural fibre webbings or ropes shall be made in accordance with the following standards:

- Flat woven webbing slings: EN 1492-1
- Roundslings: EN 1492-2
- Slings from fibre ropes: EN 1492-4

Exception: Elastic pennants for rescue boats lifted by offshore cranes, see A.7.4.1.

These components shall be selected with a breaking force resulting from equation (A.16) with resistance factor $\gamma_{rb} = 2,3$, but the breaking force shall not be less than 7 times the rated capacity.

A.1.8.4 Strength proportions

For launching and recovery appliances of group A.2 and A.6 the requirement in 4.8 shall be documented by calculations, showing that the launching appliance will not be detached from the installation before other load bearing parts have collapsed.

A.1.9 Motion limiters

For all groups except A.5, a motion limiter in accordance with EN 12077-2 shall be provided for the hoisting motion and any other recovery motions to prevent hoisting or moving the life saving equipment beyond the stowed position. Brakes shall be applied when the motion limiter is activated.

Formatert: Tabulatorstopp: 15 cm, Left

Formatert: Punktmerket + Nivå: 1 + Justert ved: 0,25 cm + Innrykk ved: 0,75 cm

Means shall be provided to prevent excessive pulling forces in the hoist rope(s) caused by hoisting the life saving equipment against an obstruction in the event of failure of the motion limiter for the upper position. This may be achieved by use of one of the following measures:

- a backup motion limiter in accordance with EN 12077-2, or
- limiting the pulling force in the winch rope, e.g. by limiting hydraulic pressure.

For all groups except A.5, a motion limiter in accordance with EN 12077-2 shall be provided for the lowering motion to prevent rope pay-out after the life saving equipment is been seaborne. Brakes shall be applied when the motion ~~limiter~~ limiter is activated.

A.1.10 Backup brake

Mechanisms on launching and recovery appliances for life saving equipment shall be equipped with a backup brake in addition to the brake as required by 5.7.6 (primary brake), when specified for the particular equipment group in the subsequent clauses of this annex.. The backup brake shall be designed according to the same requirements given for the primary brake given in 5.7.6.

Primary and backup brakes shall be arranged for individual testing.

The backup brake shall preferably act directly on the winch drum, but a load path fully independent from the primary brake will be considered acceptable.

The backup brake shall be of a different type or make than the primary brake.

Where hydraulic cylinders are used, two independent cylinders shall be provided for each function such that one cylinder is capable to stop and hold the load, in case of a failure of the other cylinder.

A.1.11 Secondary independent power and control system

Unless otherwise stated for the particular groups of launching and recovery appliances, powered launching and recovery appliances for the lifting or lowering of persons shall be equipped with a secondary independent power system and a secondary independent control system for the powered movements. The secondary power system shall not be affected by failures in the primary power system, and the secondary independent control system shall not be affected by failures in the primary control system.

NOTE: Secondary independent power and control system is equivalent with emergency operation system according to 5.15.3.

Formatert: Skrift: 8 pkt

Formatert: Skrift: 8 pkt

Formatert: Skrift: 8 pkt

For such appliances, the secondary independent power and control system shall be operated from the control station and shall be simple to activate and operate.

The secondary independent power system shall have sufficient capacity to hoist and lower the same load as the primary power system.

A.1.12 Securing arrangement for training and maintenance

For training and maintenance purposes, when the life saving equipment is not intended to be launched, a fail-safe securing arrangement including an interlock system is to be provided to prevent unintended operation or release.

The securing arrangement may be such that launching is not physically possible when the securing arrangement is in place and that launching is only possible when the securing arrangement is removed.

The securing arrangement including attachments to structure shall be durably marked for identification and for prevention of misuse.

NOTE: The securing arrangement as required by this clause is not intended for hang-off purposes, but hang-off may be used for securing when the requirements for securing arrangement are fulfilled.

Formatert: Skrift: 8 pkt

Formatert: Skrift: 8 pkt

A.1.13 Procedures

Clear and unambiguous procedures shall be provided for

- primary means of launching,
- secondary means of launching,
- maintenance and installation facilities,
- ~~life saving~~ lifesaving operations (i.e. evacuation or rescue).

Formatert: Punktmerket + Nivå: 1 +
Justert ved: 0,25 cm + Innrykk ved:
0,75 cm

Easily understandable operations instruction and permanent sign plates in accordance with EN 12644-2 and IMO Resolution A.760 (18), as amended by IMO resolution MSC.82 (70), shall be posted at the launching station.

A.1.14 Testing

A.1.14.1 General

Launching and recovery appliances together with means of connection and their anchorage in life saving equipment shall undergo testing as specified in the following sub clauses to prove that the requirements given in this NORSOK standard, are met.

Testing is required to be performed in the following phases:

- I. Prototype tests
- II. Production tests
- III. Installation tests

Prototype tests are intended to demonstrate that certain design requirements are met and they are often of a destructive nature. Prior to prototype testing the equipment shall be inspected to document that it is built in accordance with fabrication and layout drawings for the equipment.

Production tests and installation tests are intended to be performed on each individual produced unit in order to demonstrate a certain quality or performance.

Production tests are to be performed at the manufacturer's site prior to shipment to the final installation. Installation tests are to be performed after being installed at the final installation.

The time and place of testing shall be in accordance with Table A.13, i.e. either as production test, installation test or both.

Prior to production testing (or installation testing, as applicable) the equipment shall be inspected to document that it is identical to the equipment subjected to prototype tests. During installation tests, the lifeboat shall be tested in combination with its dedicated launching appliance

All tests shall be documented with detailed test procedures with acceptance criteria, and test reports confirming the results of the tests.

After production and installation tests involving testing with overload, the equipment shall be examined by use of suitable NDE-methods.

A.1.14.2 Tests for Group A.1 – Free fall lifeboats and their launching and recovery appliances

Free fall lifeboats and their launching and recovery appliances shall be tested in accordance with Table A.13.

Formatert: Venstre: 2,5 cm, Høyre: 2,5 cm, Topp: 2,5 cm, Bunn: 2,5 cm, Brekke: 21,59 cm, Høyde: 27,94 cm, Topptekstavstand fra kant: 1,25 cm, Bunnstekstavstand fra kant: 1,25 cm

| Page intentionally left blank.

Table A.13 – Tests for group A.1

Object		System	Test	Phase			
Launching appliance	Lifeboat			Prototype (I)	Production (II)	Installation (III)	
X	X	Primary means of launching	Release test 200%	A1			
X	X		Tensile test, means of connection	A2			
	X		Tensile test, means of connection anchorage in hull	A3			
	X		Actuator force, primary means of launching	A4			
	X		Function test of activation system (manually operated actuator)	A6	B2		
	X		Function test of activation system (powered actuator)	A7	B3		
X	X		Launch test, lifeboat arrangement	A5 (Empty and 110%)	B1 (110%)	B1 (110%)	
X	X		Dynamic overload test, mechanisms for positioning	A8 (120%)	B1 (110%)	B1 (110%)	
X	X		Launch simulation, 110% and empty lifeboat	A9		B4	
X			Static overload test 220%	A10		B5	
X	X		Proof load test, means of connection		B7		
	X		Ice test release mechanism, primary means of launching	A16			
X	X		Secondary means of launching	Tensile test, means of connection	A2		
	X			Tensile test, means of connection, anchorage in hull	A3		
X		Static overload test, main structure		A12	B8	B8	
X		Static overload test, winches		A13	B9		
X	X	Dynamic overload test, winches		A14	B10	B10	
X	X	Proof load test, means of connection			B7		
X		Speed test			B11	B11	
X		Dynamic overload test, mechanisms other than hoisting			B12	B12	
X		Function testing			B13	B13	
	X	Release test		A15	B14		
X	X	Means of retrieval	Tensile test, means of connection	A2			
	X		Tensile test, means of connection, anchorage in hull	A3			
X			Static overload test, main structure	A12	B8	B8	
X			Static overload test, winches	A13	B9		
X	X		Dynamic overload test, winches	A14	B10	B10	
X	X		Proof load test, means of connection		B7		
X			Speed test		B11	B11	
X			Dynamic overload test, mechanisms other than hoisting		B12	B12	

Object		System	Test	Phase		
Launching appliance	Lifeboat			Prototype (I)	Production (II)	Installation (III)
X			Function testing		B13	B13
X	X	Hang-off relief arrangement	Tensile test, means of connection	A2		
	X		Tensile test, means of connection anchorage in hull	A3		
X	X		Launch simulation (if hang-off relief arrangement is used for arresting the lifeboat during simulation)	A9		B4
X	X		Static overload test 200%	A11	B6	
X	X		Proof load test, means of connection		B7	

A.1.14.2.1 Prototype tests for Group A.1

Test No. A1 – Release test 200%, primary means of launching

The means of connection shall be loaded with a suspended load equal to or greater than 200 % of the rated capacity (see A.2.3) of the primary means of launching. The load may be the lifeboat itself with test loads, or a dummy load connected to the means of connection in a realistic manner. The means of connection and direction of load shall be oriented in the same way as it will be when installed on the host facility without heel or trim. The release mechanism shall be opened by the activation system. The test is considered successful if the load is released, and if there is no damage on the means of connection or the release system.

Test No. A2 – Tensile test, means of connection

Means of connection for which breaking force is the characteristic resistance (ref. A.1.8.3.3) shall be subjected to a tensile test load to verify that the breaking force is equal to or greater than the breaking force specified in A.1.8.3.3. The direction of the test load shall reflect the final installation of the host facility without heel or trim. The test load shall be gradually increased to a value of at least the breaking force specified in A.1.8.3.3. The test is considered successful if there is no failure to the means of connection or release mechanism at a load less than the breaking force. In this context the term “failure” means: the means of connection do not disconnect due to breakage or elastic or permanent deformation.

Test No. A3 – Tensile test, means of connection anchorage in hull

Means of connection shall be subjected to a tensile test load when they are fixed to their anchorage in the lifeboat hull. The direction of the load shall reflect the final installation of the host facility without heel or trim. The test load shall be gradually increased to a value corresponding to at least 250% of the rated capacity of the corresponding mechanism (ref. A.2.3) for the means of connection. The test is considered successful if there are no damage or permanent deformations that reduce the structural strength in the hull material.

Test No. A4 – Actuator force, primary means of launching

The actuator force required to open the release mechanism when the means of connection are loaded with a force equal to 100 % of the rated capacity (see A.2.3) shall be measured. The actuator shall then be subjected to a force equal to twice this force. The test is successful if there is no damage to the actuator and if the same actuator is successfully used in the prototype test No. A5.

Test No. A5 – Launch test, lifeboat arrangement

This test shall be performed for 2 different loading conditions; one with empty lifeboat and one with lifeboat loaded with loads giving a total weight corresponding to 110% of rated capacity for primary means of launching (see A.2.3). For both loading conditions, the lifeboat shall be suspended from the primary means of launching in the launching appliance with the launching appliance oriented in the upright position, i.e. corresponding to final installation on the host facility without heel or trim. For both loading conditions, the release mechanism shall be opened by the activation system, and the lifeboat launched to sea. The test is considered successful if the lifeboat is released and launched to sea with the predicted trajectory in air. The test shall be repeated for both loading conditions with the launching appliance oriented in the most unfavourable heel/trim angles up to 17° in any direction. The actuator subjected to prototype test No. A4 shall be used for this test.

NOTE If the host facility specific value for angle of heel for the damaged host facility is known, this test may be performed at the host specific angle of heel ~~in stead~~ instead of 17°. Reference is made to Table A.2.

Test No. A6 – Function test of activation system for release mechanism, manually operated actuator

For primary means of launching the following requirements shall be demonstrated by functional tests:

- the number of strokes required to open the release mechanism and release the lifeboat is within the range given in A.2.4.1.2, for loading conditions corresponding to empty lifeboat and 110 % of the rated capacity (see A.2.3) of the primary means of launching;
- the manual force required to operate the enabling device or the manual operating device does not exceed the value given in A.2.4.1.2, for the same loading conditions;
- it is not possible to open the release mechanism with the actuator when the enabling device is not activated.

Formatert: Punktmerket + Nivå: 1 +
Justert ved: 0,25 cm + Innrykk ved:
0,75 cm

Formatert: Punktmerket + Nivå: 1 +
Justert ved: 0,25 cm + Innrykk ved:
0,75 cm

Test No. A7 – Function test of activation system for release mechanism, powered actuator

For primary means of launching the following requirements shall be demonstrated by functional tests:

- the energy source provided for the powered operated actuator has sufficient amount of potential energy to open the release mechanism and release the lifeboat in two subsequent trials without recharging between the two releases, for loading conditions corresponding to empty lifeboat and 110 % of the capacity (see A.2.3) of the primary means of launching (whichever is the most unfavourable/unfavorable);
- the energy source is capable of producing an actuator force of at least two times the force measured in prototype test No. A4;
- it is not possible to open the release mechanism by operating only one of the control devices;
- each of the two control devices returns to neutral position after activation.

Test No. A8 – Dynamic overload test, mechanisms for positioning the lifeboat during launching sequence, prior to release

Any mechanisms used for positioning the lifeboat during the launching sequence, prior to release, shall be tested as follows: With the launching appliance in an upright position, corresponding to no heel or trim of the host installation, a load equal to 120 % of the rated capacity for the primary means of launching shall be suspended from the suspension point of the primary means of launching, resting at the skidding arrangement or other mechanism in a realistic manner simulating load action from the weight of the lifeboat. The mechanism shall move the load from one extreme position to the next extreme position and back again, using machinery and power source similar to that of the final installation. The test shall be repeated with the launching appliance inclined to 17° in the most unfavourable directions of heel and trim. The same tests shall be performed with a load equal to a fully equipped lifeboat without persons. The tests are considered successful if the launching appliance is able to perform the required motions for both loading conditions, and there is no damage or permanent deformation after the tests.

NOTE If the host facility specific value for angle of heel for the damaged host facility is known, this test may be performed at the host specific angle of heel instead of 17°. Reference is made to Table A.2.

Test No. A9 – Means of launch testing by simulation

The means of launch testing by simulation, as required by DNV-OS-E406 Sec. 11 A500, shall be demonstrated in accordance with a prescribed procedure describing (a) realistic functional test(s) to positively confirm that the activation system is working properly and the release mechanism is fully opened and unloaded. The test of a system using skidding tracks is considered successful if the lifeboat has moved min. 100mm along the skidding track after the release mechanism is fully opened and unloaded. For the purpose of this test, the lifeboat shall be suspended in the primary means of launching with two loading conditions, one with loads corresponding to 110 % of the rated capacity (see A.2.3) of the primary means of launching, and one corresponding to empty lifeboat. The two independent activation systems (as required by A.2.4.1.2) shall be tested separately for both loading conditions. In order to avoid exposing persons to risk, a purpose built system for remote operation of the activation systems may be utilised.

Care must be taken to ensure that the involved components and structures are able to absorb any shock loadings during load transfer, ref. load combination C7, Table A.3. Peak loads must be measured during this test to confirm the dynamic factor used in load combination C7, Table A.3.

Test No. A10 – Static overload test, primary means of launching

A test load corresponding to 220% of the rated capacity of primary means of launching (see A.2.3) shall be suspended from the attachment point for means of connection for the primary means of launching. The test is considered successful if there is no damage or permanent deformation to the main structure, skidding track or means of connection after the tests. The test load may be the lifeboat itself, or a dummy load with identical footprint on the skidding track and same location of the centre of gravity.

Test No. A11 – Static overload test, hang-off relief arrangement

A test load corresponding to 200% of the rated capacity of the hang-off relief arrangement (see A.2.3) shall be suspended from the attachment point(s) for the hang-off relief arrangement. The test load may be the lifeboat itself, or a dummy load with identical footprint on the skidding track and same location of the centre gravity. Alternatively, if this test represents the same loading on the skidding track as test No. A10, a realistic tensile load corresponding to 200% of the rated capacity of the hang-off relief arrangement may be applied

the attachment point(s) for the hang-off relief arrangement without loading the skidding track. The test is considered successful if there is no damage or permanent deformation to the main structure, skidding track or means of connection after the test.

Test No. A12 – Static overload test, main structure for secondary means of launching and means of retrieval
A load equal to ~~220~~200 % of the ~~fully loaded lifeboat~~rated capacity shall be suspended from the main structure of the appliance for secondary means of launching and means of retrieval, respectively, without loading winches. The load shall be applied in the most unfavourable position of the launching appliance or means of retrieval, simulating a realistic load path for the weight of the lifeboat. The tests are considered successful if there is no damage or permanent deformation to the main structure.

Test No. A13 – Static overload test, winches

A load equal to 150 % of the rated capacity (see A.2.3) of the means of retrieval or secondary means of launching, shall be suspended from the means of connection forming part of the hoist rope of the winch for the means of retrieval and secondary means of launching, respectively. The load shall be applied with the hoist rope at the outermost layer on the winch drum. If the winch is equipped with both primary and secondary brakes for the purpose of lifting/lowering persons, both brakes shall be applied during this load test.

For winches equipped with primary and secondary brakes for the purpose of lifting/lowering persons, the following test shall be performed in addition: a load equal to 150 % of the rated capacity for lifting persons (see A.2.3) shall be suspended from the means of connection forming part of the hoist rope of the winch. The load shall be applied with the hoist rope at the outermost layer on the winch drum. The test shall be applied for the primary brake (with the secondary brake disabled) and the secondary brake (with the primary brake disabled) separately.

The tests are considered successful if the brakes are able to hold the load, either separately or in combination as tested.

Test No. A14 – Dynamic overload test, winches

A load equal to 110 % of the rated capacity of the secondary means of launching shall be suspended from the means of connection forming part of the hoist rope, when the winch is installed in the main structure. The load shall be hoisted and lowered repeatedly at full speed, and it shall be demonstrated that the winch is capable of hoisting, lowering, stopping and holding the load without sag.

The load shall be lowered at full speed, starting from the uppermost position of the lifeboat. The lowering motion shall be stopped by the most severe method, e.g. sudden application of winch brakes or emergency stop, immediately after the lowering speed has reached its maximum. If the winch is equipped with both primary and secondary brakes for the purpose of lifting/lowering persons, both brakes shall be applied simultaneously during this load test. For winches with lowering speed 0,5 m/s or higher, the maximum dynamic peak force on the test load, corresponding to F_{bra} in equation (A.2), shall be recorded during the stop. The instruments used for measuring the peak load shall be able to record load samplings at a rate of 200 samplings/second and have an accuracy within +/5%. The test is considered successful if both of the following acceptance criteria are met:

- the brakes brings the winch movement to a complete stop;
- the recorded peak force is equal to or less than the force F_{bra} used in equation (A.2) to calculate the dynamic coefficient $\Phi_{2,C6}$ as defined in A.1.5.4 for load combination C6.

For winches equipped with primary and secondary brakes for the purpose of lifting/lowering persons, the following tests shall be performed in addition: a load equal to 110 % of the rated capacity for lifting of persons (see A.2.3) shall be suspended from the means of connection forming part of the hoist rope, when the winch is installed in the main structure. The load shall be lowered at full speed, starting from the uppermost position of the lifeboat. The lowering motion shall be stopped by the most severe method, e.g. sudden application of both winch brakes by emergency stop, immediately after the lowering speed has reached its maximum. The maximum dynamic peak force on the test load, corresponding to F_{bra} in equation (A.2), shall be recorded during the stop. The test is considered successful if the recorded peak force is equal to or less than the force F_{bra} used in equation (A.2) to calculate the dynamic coefficient $\Phi_{2,C6}$ as defined in A.1.5.4 for load combination C6.

The test shall be repeated with the application of each brake separately, i.e.:

- stopping by sudden application of primary brake when secondary brake is disabled, and
- stopping by sudden application of secondary brake when primary brake is disabled

These tests are considered successful if both brakes are able to bring the lowering motion to a complete stop.

Test No. A15 – Release test means of connection for secondary means of launching

A test shall be performed to verify that the release mechanism ~~can not~~ be opened when loaded with a force greater than 10 % of the rated capacity of the means of connection. In addition the functionality requirements in A.2.4.2.5 shall be demonstrated.

Test No. A16 – Ice test release mechanism, primary means of launching

The release mechanism for primary means of launching shall be arranged in a cold room at -30°C and loaded with a suspended load corresponding to 100% of its rated capacity. A 3,5 cm thick uniform layer of icing should be built onto it by spraying cold fresh water from angles above 45 degrees from horizontal, with intermittent pauses to let icing form. The release mechanism shall then be opened with the intended type of actuator. The test is considered successful if the load is released by applying a force less than twice the force required to open the release mechanism when loaded by the same load in non-icing condition (ref. test No. A4).

A.1.14.2.2 Production and installation tests for Group A.1

Test No. B1 – Launch test, lifeboat arrangement

The lifeboat shall be suspended from the primary means of launching in its dedicated launching appliance with loading condition corresponding to 110 % of the rated capacity (see A.2.3) of the primary means of launching, with the launching appliance oriented in the upright position (i.e. corresponding to final installation on the host facility without heel or trim). For this loading condition, the release mechanism shall be opened by the activation system, and the lifeboat launched to sea. The test is considered successful if the lifeboat is released and launched to sea with the predicted trajectory in air. Any mechanism for positioning the lifeboat prior to release shall be operated in accordance with the launching procedure (without external power).
. In order to avoid exposing persons to risk, a purpose built system for remote operation of the activation systems may be utilised.

Test No. B2 – Function test, release system (manually operated actuator)

Function tests No. A6 shall be performed using the installed activation system intended to be used in a real evacuation situation.

Test No. B3 – Function test, release system (powered actuator)

Function tests No. A7 shall be performed using the installed activation system intended to be used in a real evacuation situation.

Test No. B4 – Means of launch testing by simulation.

Test No. A9 shall be performed.

Test No. B5 – Static overload test, primary means of launching

The test described in test No. A10 shall be performed as installation test, but may upon agreement be omitted if proof of competence calculations for primary means of launching including interface to host installation are performed by an independent 3rd party and verified by an Enterprise of Competence.

Test No. B6 – Static overload test, hang-off relief arrangement

Test No. A11 shall be performed as production test.

Test No. B7 – Proof load tests for means of connection

Means of connection, both those forming part of the lifeboat and those forming part of the launching appliance, shall be subjected to a static overload test with a force corresponding to the following values for the applicable mechanisms (see A.2.3):

- primary means of launching: 220% of the rated capacity,
- secondary means of launching: 200% of the rated capacity,

- means of retrieval: 200% of the rated capacity,
- hang-off relief arrangement: 200% of the rated capacity.

Means of connection forming part of the lifeboat hull shall be fixed to their anchorage in hull during this test.

The tests are considered successful if there is no damage or permanent deformation to the means of connection or the lifeboat hull after the tests.

Test No. B8 – Static overload test, main structure for secondary means of launching and means of retrieval

Test No. A12 shall be performed both as production test and installation test. When performed as installation test, the test is considered successful when also the interface to the host installation is examined and there is no damage or permanent deformation after the test.

Test No. B9 – Static overload test, winches

Test No. A13 shall be performed as production test.

Test No. B10 – Dynamic overload test, winches

Test No. A14 shall be performed as production and installation tests.

During installation test, the tests described in the first paragraph of test No. A14 shall be performed with the suspended lifeboat with loads corresponding to 110 % of the rated capacity for the means of retrieval and secondary means of launching, respectively. During production test, the tests may be performed with a test load.

Test No. B11 – Speed test

The hoisting and lowering speed of the means of retrieval and secondary means of launching shall be measured when hoisting or lowering a load equal to the rated capacity for the mechanism. The tests are considered successful if the speeds are within the limits described in A.1.6. In case of gravity lowering with two independent constant speed control devices, the lowering speed test shall be performed for each speed control device separately, with the other speed control device disabled or adjusted to a higher speed. Both speed control devices shall be adjusted to correct speed after the test.

Test No. B12 – Dynamic overload test, mechanisms other than hoisting

With the launching appliance in an upright position, corresponding to no heel or trim of the host installation, the lifeboat with loads corresponding to 110 % of the rated capacity for the secondary means of launching and means of retrieval shall be suspended from the suspension point of the secondary means of launching and means of retrieval. All mechanisms (i.e. skidding, luffing, slewing, telescoping etc.) shall be moved in their full operating range in both directions at full speed in sequence, one at a time. If the movement of the skidding mechanism loaded by the weight of the lifeboat is part of the cycle, the lifeboat shall be supported by the skidding tracks during this test. There shall be at least two stops of each motion during the cycle. The test is considered successful if the launching appliance is able to perform all the required motions, all motions can be stopped and held in position by their respective braking systems, and there is no damage or permanent deformation after the tests.

Test No. B13 – Function testing – Secondary means of launching and means for retrieval

The following functions shall be tested for secondary means of launching and means of retrieval:

- Emergency stop (ref. 5.15.1)
- Emergency operation (ref. A.2.4.2.4 and A.2.4.3.4)
- Motion limiters (ref. A.2.4.2.3 and A.2.4.3.3)
- Control station (ref. A.2.4.2.2.4 and A.2.4.3.2.4)

Test No. B14 – Release test – Secondary means of launching

Test No. A15 shall also be performed as a production test.

A.1.15 Fabrication

Structures shall be fabricated in accordance with a recognized standard. For the purpose of complying with this standard, the following fabrication standards are considered recognized:

- NORSOK M-101

- DNV-OS-C401

Load bearing components covered by Annex C of this standard shall follow the fabrication requirements given in Annex C.

Other load bearing components shall follow the fabrication requirements given in clause 5.22 of this standard.

A.2 Appliances for free fall lifeboats (Group A.1)

A.2.1 General

The requirements in this subclause apply in addition to the requirements in A.1 for launching and recovery appliances of Group A.1. Relevant requirements in DNV-OS-E406 apply in addition to the requirements in this annex. In case of conflicting requirements between this annex and DNV-OS-E406, the requirements of this annex prevail.

The requirements listed in A.2.2.1 to A.2.5 describe an acceptable design. Alternative designs are acceptable if the risk assessment (see 4.11) proves that the alternative design results in an equal or better safety, fitness for use, reliability and availability, than the requirements in this annex.

The following requirements from NMD Regulation 4 July 2007 No. 853 apply for launching and recovery appliances of free fall lifeboats:

- section 11, 1st paragraph;
- section 11, 3rd paragraph.

← **Formatert:** Punktmerket + Nivå: 1 +
Justert ved: 0,25 cm + Innrykk ved:
0,75 cm

A.2.2 Limits of the launching and recovery appliances for free fall lifeboats

A.2.2.1 General

Launching and recovery appliances of Group A.1 consist of the parts and sub-systems in A.2.2.2 to A.2.2.4.

A.2.2.2 Main structure

The main structure of the launching and recovery appliance for free fall lifeboats is the structure that is directly loaded by the weight of the lifeboat when it is suspended from its primary or secondary means of launching, its means of retrieval or its hang-off relief arrangement. This includes foundation for mechanical equipment, e.g. winches, sheaves etc.

A.2.2.3 Primary means of launching

The primary means of launching is the main lifeboat launching system, normally based on gravity free fall or skidding combined with free fall. This includes skidding track, means of connection, release system and securing arrangement.

A.2.2.4 Secondary means of launching

The secondary means of launching is an alternative lifeboat launching system, normally based on gravity lowering or power lowering by a lifting appliance. This includes a winch and fall system with its machinery and control system as well as means of connection, release mechanism, release system and securing arrangement. The purpose of the secondary means of launching is not to launch the lifeboat in an emergency situation.

A.2.2.5 Means of retrieval

The means of retrieval is a lifting appliance designed for retrieval of the lifeboat from sea to its stowed position on the host facility. The means of retrieval is normally the same mechanism as the secondary means of launching.

A.2.2.6 Hang-off relief arrangement

The hang-off relief arrangement is lifting accessories and means of connection intended for keeping the lifeboat in the stowed position when the lifeboat is disconnected from the primary means of launching, the secondary means of launching and the means of retrieval.

A.2.3 Rated capacity

When performing the proof of competence in accordance with A.1, the rated capacity for the different mechanisms shall be taken as follows:

- primary means of launching: _____ fully loaded lifeboat;
- secondary means of launching: _____ 1,1 x fully loaded lifeboat;
- means of retrieval: _____ 1,1 x fully loaded lifeboat;
- hang-off relief arrangement: _____ 1,1 x fully loaded lifeboat.

Formatert: Punktmerket + Nivå: 1 +
Justert ved: 0,25 cm + Innrykk ved:
0,75 cm

NOTE: The factor 1,1 to calculate rated capacity for means of retrieval and hang-off relief arrangement is introduced in order to have sufficient capacity to recover and stow the lifeboat with 110% test loads without overloading the mechanism. The factor 1,1 to calculate rated capacity for secondary means of launching is a natural consequence since it will normally be the same winch as the means of retrieval.

Formatert: Skrift: 8 pkt

Formatert: Skrift: 8 pkt

Formatert: Skrift: 8 pkt

“Fully loaded lifeboat” means the gross mass of a fully equipped lifeboat when boarded with its full complements of persons (crew and passengers).

Main structure shall be proved for the load effects resulting from applicable loads on all the mechanisms, whichever gives the highest load effects.

If secondary means of launching and means of retrieval is intended to be used with persons inside the lifeboat, the proof of competence shall also be performed with rated capacity for lifting persons. Rated capacity for lifting persons with these mechanisms shall as a minimum be taken as empty (fully equipped) lifeboat with crew of 3 persons. When performing proof of competence with rated capacity for lifting persons, the risk coefficient given in A.1.7 shall be applied.

A.2.4 Functional and safety requirements

A.2.4.1 Primary means of launching

A.2.4.1.1 General

The primary means of launching shall be capable of launching the lifeboat in any possible loading condition, i.e. from empty lifeboat with crew of three persons to the fully loaded lifeboat. The launching shall not depend upon external energy supply, other than gravity or stored mechanical power which is independent of the host installation's power supplies.

A.2.4.1.2 Release system for the primary means of launching

The release mechanism and activation systems shall comply with the following clauses of DNV-OS-E406 in addition to the requirements of this subclause:

- Sec. 7, C101;
- Sec. 11, A400;
- Sec. 11, A500.

Formatert: Punktmerket + Nivå: 1 +
Justert ved: 0,25 cm + Innrykk ved:
0,75 cm

The release mechanism and activation systems shall be capable of operating in all specified environmental conditions, including icing.

The release mechanism shall be designed in such a way that it will not be forced open by the self weight of the lifeboat, i.e. an external force from an actuator shall be necessary to open the release mechanism. The actuator and release mechanism shall be interconnected in the positive mode in accordance with ISO 12100, 6.2.5.

The two independent activation systems for the release mechanism, as required by DNV-OS-E406 Sec. 7, C101, may consist of manually operated or powered actuators.

Manually operated actuators shall have a manual operating device (e.g. hydraulic hand pump or manual jacking system) for each actuator and an enabling device (e.g. hydraulic by-pass valve or mechanical coupling device) placed out of reach for the operator of the manual operating device. The enabling device shall need a continuous manual force to be kept in the “enable” position. The number of required strokes for the manual operating device shall be in the range of 5 to 25. The maximum manual force required to operate the enabling device or the manual operating device shall not exceed 250 N.

Each powered actuator shall have its own source of stored energy and its own control system incorporating two manually operated control devices named “launch”, which are required to be activated simultaneously to start moving the release mechanism. The control devices shall be protected against inadvertent operation and shall be placed such that one operator ~~can not~~cannot activate both control devices simultaneously. The control devices shall return to neutral position when released. The energy sources shall have a capacity of twice the amount of energy needed to open the release mechanism. It shall be possible to visually control the amount of stored energy.

Each actuator shall be designed to produce a force exceeding two times the force required to open the release mechanism with the fully loaded lifeboat.

A.2.4.2 Secondary means of launching

A.2.4.2.1 General

The secondary means of launching shall be capable of launching the lifeboat in any possible loading condition, i.e. from empty lifeboat up to the rated capacity for the mechanism as specified in A.2.3.

NOTE The requirements for secondary means of launching given in this clause are intended for launching devices utilising a winch and falls. Other solutions may also be considered, but at the time of publication of this NORSOK standard no other solutions are considered sufficiently qualified. Other solutions must be qualified in accordance with 4.15.

Some of the requirements given in the subsequent subclauses are given based on the assumption that the secondary means of launching is intended to lower the lifeboat with a crew of three. If lowering the lifeboat with persons inside is not part of the intended use, the requirements in A.2.4.2.2.1 and A.2.4.2.2.3 do not apply, see also A.2.4.2.4 for emergency operation.

A.2.4.2.2 Launching mechanism

A.2.4.2.2.1 Constant speed control

In case secondary means of launching is based on gravity lowering by a winch, the lowering speed shall be controlled by two independent constant speed control devices. The speed control devices shall be able to control the lowering motion within the speed limit given in A.1.6. In case of failure in one of the speed control devices, the speed should not exceed 1,5 m/s.

A.2.4.2.2.2 Winch brakes, primary brakes

Winches shall be equipped with brakes (primary brake) in accordance with 5.7.6.

A.2.4.2.2.3 Winch brakes, backup brakes

Winches shall also be equipped with backup brakes in accordance with A.1.10.

A.2.4.2.2.4 Control station

A control station for the secondary means of launching shall be located outside the lifeboat with the following control devices:

- start device to enable power supply to the launching and recovery appliance;
- stop device to disable power supply to the launching and recovery appliance;
- emergency stop for emergency purposes to stop all motions;
- movement control device for starting, stopping and variable speed control of the lowering motion, either stepless variable speed or variable speed in 2 or more defined steps. The movement control device must be of the hold-to-run type, i.e. return to neutral position when released.

← **Formatert:** Punktmerket + Nivå: 1 +
Justert ved: 0,25 cm + Innrykk ved:
0,75 cm

The control station for the secondary means of launching shall not influence on the primary means of launching and shall be located so that the operator has a clear view to the life boat in all positions.

A.2.4.2.3 Motion limiter

A motion limiter for the lowering motion shall be installed to prevent ropes from running off the drum or be wound on the drum in the wrong direction when the lifeboat is seaborne. The setting point of the motion limiter shall take into account the most unfavourable situation caused by possible sidelead and offlead, wave trough and the lowest astronomical tide. When the lower motion limit has been reached, at least 2 windings of wire rope shall remain on the winch drum.

A.2.4.2.4 Emergency operation

In case of a main power failure or a control system failure, one of the following emergency solutions shall be available, as applicable:

- If the secondary means of launching is intended to be used with persons on board the lifeboat, it shall be possible to recover the lifeboat by use of the emergency operation system for means of retrieval (ref. A.2.4.3.4).
- If the secondary means of launching is intended to be used without persons on board the lifeboat, it shall be possible to lower the lifeboat to sea by means of an emergency lowering system in accordance with 5.15.2.

A.2.4.2.5 Release system for the secondary means of launching

A manually operated actuator shall be provided for opening of the release mechanism of the secondary means of launching.

The opening and closing of release mechanism shall be possible from within the lifeboat or through a hatch opening. Opening of the release mechanism shall require two deliberate actions by the operator and shall only be possible when the means of connection are offloaded.

The release system shall be physically protected against inadvertent use.

The release mechanism shall be designed in such a way that it will not be forced open by the self weight of the lifeboat, i.e. an external force from an actuator shall be necessary to open the release mechanism. The actuator and release mechanism shall be interconnected in the positive mode in accordance with ISO 12100, 6.2.5.

It shall be possible to visually check that means of connection are fully engaged and that the release mechanism is secured.

NOTE: Shackles and hooks in accordance with Annex C (clause C.11.1 and C.16.3, respectively) are considered to comply with the above requirements.

A.2.4.3 Means of retrieval

A.2.4.3.1 General

The means of retrieval shall be capable of hoisting the rated capacity given in A.2.3 from sea surface to the stowed position.

NOTE The requirements for means of retrieval given in this clause are based on means of retrieval combined with secondary means of launching utilising a winch and falls. Other solutions may also be considered, but at the time of publication of this NORSOK standard, no other solutions are considered sufficiently qualified. Other solutions must be qualified in accordance with 4.15.

Some of the requirements given in the subsequent subclauses are given based on the assumption that the means of retrieval is intended to hoist the lifeboat with a crew of three. If hoisting the lifeboat with persons

inside is not part of the intended use, the requirements in A.2.4.3.2.3 do not apply; see also A.2.4.3.4 for emergency operation.

Formatert: Annex-head4

A.2.4.3.2 Hoisting mechanism

A.2.4.3.2.1 General

A powered winch shall be provided for hoisting the lifeboat with a minimum speed as given in A.1.6.

A.2.4.3.2.2 Winch brakes, primary brakes

Winches shall be equipped with brakes (primary brake) in accordance with 5.7.6.

A.2.4.3.2.3 Winch brakes, backup brakes

Winches shall also be equipped with backup brakes in accordance with A.1.10.

A.2.4.3.2.4 Control station

The control station described in A.2.4.2.2.4 shall also incorporate a movement control device for starting, stopping and variable speed control of the hoisting motion, either stepless variable speed or variable speed in 2 or more defined steps. The movement control device shall be of the hold-to-run type.

A.2.4.3.3 Motion limiters

Motion limiters for the hoisting motion and any other recovery motions shall be provided in accordance with A.1.9.

Prior to reaching the upper stop position, the hoisting speed shall be automatically reduced by at least 50%.

A.2.4.3.4 Emergency operation

In case of a main power failure or a control system failure, one of the following emergency solutions shall be available, as applicable:

- If the means of retrieval is intended to be used with persons on board the lifeboat, it shall be possible to recover the lifeboat by use of secondary independent power and control system in accordance with A.1.11
- If the means of retrieval is intended to be used without persons on board the lifeboat, it shall be possible to lower the lifeboat to sea, or alternatively back to the storage position, by means of an emergency lowering system in accordance with 5.15.2.

Formatert: Skrift: Trebuchet MS, 9 pkt, Skriftfarge: Svart

Formatert: Ingen punktmerking eller nummerering

A.2.4.4 Hang-off relief arrangement

Hang-off relief arrangement is the system required by DNV-OS-E406 sec.7, C102.

The hang-off relief arrangement shall be designed to keep the lifeboat in the stowed position when it is disconnected from the primary and secondary means of launching. Suspension points and means of connection for the hang-off arrangement forming integral parts of the lifeboat shall have easy access so that it is possible to connect without entering the lifeboat. The hang-off relief arrangement shall be designed so that it is not possible to attach any of its components to the wrong suspension points or means of connection.

A.2.4.5 Skidding systems

In addition to the limit states described in A.1.8, the proof of ~~compentence~~ competence shall be performed for the serviceability limit state (SLS) for the skidding tracks. The verification of serviceability limit state shall be based on deflection criteria for the skidding tracks.

In-plane and out-of-plane deflection criteria for the skidding tracks shall be established with the aim to obtain the predicted trajectory in air during launching and to avoid lifeboat derailing due to deflected skidding tracks. The deflection criteria should be obtained from the lifeboat manufacturer.

The SLS shall be proven for load combinations A1 and B1 in Table A.3. When performing proof of competence for the SLS, the partial safety factors and risk coefficients given in Table A.3 shall be applied.

A.2.5 Marking

Means of retrieval and secondary means of launching shall be clearly marked to advise the user if the lifting or lowering of lifeboat with persons inside is allowed or not. Marking shall be provided in both cases, e.g.:

- “This winch/means of retrieval/secondary means of launching is intended for lifting/lowering the lifeboat with persons inside during installation, maintenance or training. Maximum number of persons is <number of persons>”, or
- Lifting/lowering of persons is NOT ALLOWED with this winch/means of retrieval/secondary means of launching”.

Formatert: Punktmerket + Nivå: 1 +
Justert ved: 0,25 cm + Innrykk ved:
0,75 cm

This marking shall be provided at the operator station.

A.3 Appliances for lifeboats launched by falls and a winch (Group A.2)

A.3.1 General

The requirements in this subclause come in addition to the requirements in A.1 for launching and recovery appliances of Group A.2.

The requirements listed in A.3.2 to A.3.8 describe an acceptable design. Alternative designs are acceptable if the risk assessment, see 4.11, proves that the alternative design results in an equal or better safety, fitness for use, reliability and availability, than the requirements in this annex.

NOTE The requirements in this subclause of Annex A apply to launching appliances for lifeboats with two suspension points, i.e. one fore and one aft, with single fall or multiple falls at each suspension point. Other solutions (e.g. one suspension point) may also be considered, but at the time of publication of this NORSOK standard, such solutions are not considered sufficiently qualified. Other solutions must be qualified in accordance with 4.15.

The following requirements from NMD Regulation 4 July 2007 No. 853 apply for launching and recovery appliances of Group A.2:

- section 11, 1st paragraph;
- section 11, 2nd paragraph, including subclauses a through d, and g through h

Formatert: Punktmerket + Nivå: 1 +
Justert ved: 0,25 cm + Innrykk ved:
0,75 cm

A.3.2 Mode selector

Launching and recovery appliances of Group A.2 shall have a control device (mode selector) for manual selection of two distinguished different operational modes, i.e. mode for installation and maintenance, and mode for emergency evacuation. The mode selector shall be protected against unintended use. The mode selector shall be located at the control station outside the lifeboat. Clear indication of the selected mode shall be provided. The indication shall be visible both from the lifeboat captains position inside the lifeboat and at the control station outside the lifeboat.

The two operational modes shall have separate functional characteristics as described in A.3.3 and A.3.4, such that the functions of each mode ~~can not~~ cannot influence or affect the other. A summary of the functional characteristics of the two operational modes is given in Table A.14.

Table A.14 - Modes and functional characteristics overview

	Launching appliance functional characteristics	Mode for installation and maintenance	Mode for emergency evacuation
During wire rope suspended lifeboat	Start	Yes	"Launch"
	Stop	Yes	No
	Emergency stop	Yes	No
	Power hoisting and power lowering by variable speed control	Yes	No
	Gravity lowering by two independent constant speed controls	No	Yes
	Re-entry overload protection	No ¹⁾	Yes
	Primary brake	Yes	No
	Backup brake	Yes	No
	Motion limiter up	Yes	No
	Motion limiter down	Yes	No
	Secondary independent power- and control system	Yes	No
During seaborne lifeboat	Primary release system	No	Yes
	Back up release system	Yes	Yes
NOTES:	¹⁾ Protection system need needs not to be de-activated in mode for installation and maintenance.		

A.3.3 Mode for installation and maintenance

A.3.3.1 General

When the mode selector is in the position for installation and maintenance the requirements in A.3.3.2 to A.3.3.6 applies.

A.3.3.2 Control station

A control station shall be located outside the lifeboat with the following control devices:

- a) start device to enable power supply to the launching and recovery appliance;
- b) stop device to disable power supply to the launching and recovery appliance;
- c) emergency stop for emergency purposes to stop all motions;
- d) mode selector;
- e) indication of selected mode;
- f) movement control devices for hoisting and lowering and, if applicable, any other movements. All movement control devices shall be of the hold-to-run type, i.e. return to neutral position when released. All movements shall have variable speed control, either stepless variable speed or variable speed in 2 or more defined steps.

The control station must be located so that the operator has a clear view to the life boat during all movements.

A.3.3.3 Winch brakes

Primary and backup brakes shall be operative as described in 5.7.6 and A.1.10.

A.3.3.4 Motion limiters

Motion limiters for the upper and lower position of the lifeboat shall be provided in accordance with A.1.9.

The motion limiter for the upper position shall stop the movement at the level for boarding the lifeboat. Prior to reaching the upper stop position, the hoisting speed shall be automatically reduced by at least 50%.

A.3.3.5 Backup release system

Operation of the backup release system described in A.3.4.7.3 shall be possible in the mode for installation and maintenance.

A.3.3.6 Secondary independent power and control system

In case of unintended stops as result of power failure or failure in the control system, secondary independent power and control systems in accordance with A.1.11 shall be available in mode for installation and maintenance.

A.3.4 Mode for emergency evacuation (“Pull and go”)

A.3.4.1 General

The launching shall not depend upon external energy supply, other than gravity or stored mechanical power which is independent of the host installation’s power supplies.

When the mode selector is in the position for emergency evacuation the following applies:

Before any movement of the lifeboat can be initiated the securing arrangement in A.1.12 need to be removed.

A.3.4.2 Launch devices

The emergency evacuation shall be activated from within the lifeboat by the simultaneous operation of two control devices named “launch”. The “launch” devices shall be placed such that one operator ~~can not~~ cannot activate both control devices simultaneously. The control devices must return to neutral position when released. Activation of the “launch” devices shall initiate the lowering motion. A duplicate “launch” device may also be arranged outside the lifeboat for remote operation for test purposes only. The “launch” devices shall be protected against inadvertent operation.

Any lashing systems for stowing the lifeboat must prevent the launch devices from being activated until lashing systems have been removed.

A.3.4.3 Lowering mechanism and speed control

The lowering motion shall only depend on gravity or stored mechanical energy. Once the lowering motion has started it shall continue regardless of any crew intervention until the lifeboat is seaborne.

The lowering speed shall be controlled by two independent constant speed control devices. The speed control devices shall be able to control the lowering motion within the speed limit given in A.1.6. In case of failure in one of the speed control devices, the speed should not exceed 1,5 m/s.

A.3.4.4 Disabled safety features

No other safety features shall be operational during the descent, except for those ensuring the release mechanism to be secured.

A.3.4.5 Release system

Once the lifeboat is seaborne, the release mechanisms for both the wire rope suspensions shall be opened automatically by the primary activation system.

A.3.4.6 Release mechanism

The release mechanism shall be designed in such a way that it will not be forced open by the self weight of the lifeboat, i.e. an external force from an actuator shall be necessary to open the release mechanism. The actuator and release mechanism shall be interconnected in the positive mode in accordance with ISO 12100, 6.2.5.

Dynamics caused by initiation of the emergency evacuation from installation deck elevation or oscillation during the descent (boat acceleration) shall not cause the release mechanism to open unintentionally.

The release mechanisms connecting the wire rope falls to the lifeboat shall operate at all possible rope fleet angles with and without tension in the wire rope falls when the boat is seaborne.

A.3.4.7 Activation systems

A.3.4.7.1 General

The release system shall have two independent activation systems for opening the release mechanisms, i.e. primary activation system and backup activation system. Both activation systems shall be designed to open the release mechanisms under the load of a fully loaded life boat. Both activation systems must be clearly marked with instructions for use.

A.3.4.7.2. Primary activation system

The primary activation system consists of the following parts:

- a power source (i.e. stored potential energy) for each release mechanism;
- an actuator for each release mechanism;
- a control system incorporating a detection system for detection of seaborne lifeboat
- one -1- manually operated mechanical locking device to prevent unintended opening of the release mechanism (e.g. locking of the release mechanism, the actuator or the element isolating the power source)

The following requirements apply to the primary activation system:

- It shall not be possible to release the lifeboat from the means of connection prior to activation of the launch devices,
- A single failure in the control system, or a common cause failure, shall not lead to unintended release,
- The control system for detection of seaborne lifeboat and releasing stored energy to the actuator is considered as safety related parts of control system and shall fulfil a required performance level (PLr) equal to "e" in accordance with ISO 13849-1.
- The manually operated locking device shall be arranged for rapid unlocking by a single operation at any time. In order to prevent unintended operation, the locking device shall be sealed. It shall be possible to visually check the position of the locking device from the operator's position. The locking device shall be clearly marked with conditions for unlocking.

NOTE: The manually operated locking device is intended to be unlocked only in a real evacuation situation, and at safe distance from sea level during training.

When the condition for release is detected, the control system shall initiate movement of the actuators to open both release mechanisms within 1 s after detection of seaborne lifeboat.

A.3.4.7.3 Backup activation system

For the event of malfunctioning of the primary activation system, a manually operated backup activation system for opening both release mechanisms simultaneously shall be provided. The backup release system shall be available for both operational modes.

The activation system for the backup release system shall be operated from within the boat and shall require two deliberate actions by the operator.

Operation of the backup activation system shall only be possible when the lifeboat is seaborne.

The backup activation system shall be physically protected against inadvertent use.

A.3.4.8 Re-entry overload protection

Unless the manufacturer can demonstrate by calculations, simulations or model tests that the dynamic coefficient, $\Phi_{2,C1}$, is within the limit described in A.1.5, the launching appliance or the lifeboat shall be arranged with a protective device or system to limit the dynamic coefficient, $\Phi_{2,C1}$, as specified.

A.3.5 Hang-off relief arrangement

A hang-off relief arrangement shall be provided to keep the lifeboat in the stowed position when it is disconnected from the launching system. Suspension points and means of connection for the hang-off arrangement forming integral parts of the lifeboat shall have easy access so that it is possible to connect without entering the lifeboat. The hang-off relief arrangement shall be designed so that it is not possible to attach any of its components to the wrong suspension points or means of connection.

The hang-off relief arrangement shall be marked with rated capacity in accordance with A.1.4.2.

A.4 Appliances for escape chutes (Group A.3)

Appliances for launching and recovery of escape chutes shall be in accordance with clause 6.2 of the LSA code.

A.5 Appliances for rafts (Group A.4)

TO BE DEVELOPED

A.6 Appliances for escape lines (Group A.5)

TO BE DEVELOPED

A.7 Appliances for rescue boats (Group A.6)

A.7.1 General

Launching and recovery of rescue boats may be performed by general purpose offshore cranes or dedicated rescue boat cranes or davits especially designed for such operations.

This clause applies to dedicated rescue boat cranes or davits especially designed for such operations. Reference is made to Annex G for general purpose offshore cranes intended for lifting rescue boats.

This clause also applies to the means of connection that form integral parts of the rescue boat, including their release mechanisms, release systems and anchorage to the hull.

NOTE The requirements in this clause of Annex A apply to launching appliances for rescue boats with one suspension point, with single fall or multiple falls. Other solutions (e.g. multiple suspension points) may also be considered, but at the time of publication of this NORSOK standard, such solutions are not considered sufficiently qualified. Other solutions must be qualified in accordance with 4.15.

The requirements in this clause apply in addition to the requirements in A.1 for launching and recovery appliances of Group A.6.

The launching and recovery appliances shall be able to operate a fully loaded rescue boat in all positions.

The following requirements from NMD Regulation 4 July 2007 No. 853 apply for launching and recovery appliances for rescue boats:

- section 11, 1st paragraph;
- section 11, 4th paragraph, including sub clauses a) and c)

The following requirements from NMD Regulation 4 July 2007 No. 853 apply for means of connection and release systems that form integral part of the rescue boat:

- section 9, 2nd paragraph, including subclauses c and d

The dynamic coefficient, Φ_2 , shall not exceed 3 in any load combination for launching and recovery appliances of group A.6.

← **Formatert:** Punktmerket + Nivå: 1 +
Justert ved: 0,25 cm + Innrykk ved:
0,75 cm

← **Formatert:** Punktmerket + Nivå: 1 +
Justert ved: 0,25 cm + Innrykk ved:
0,75 cm

A.7.2 Functional and safety requirements for the launching and recovery appliances

A.7.2.1 General

The requirements listed in A.7.2.2 to A.7.2.8 describe an acceptable design. Alternative designs are acceptable if the risk assessment, see 4.11, proves that the alternative design results in an equal or better safety, fitness for use, reliability and availability, than the requirements in this annex.

A.7.2.2 Motion limiters

Motion limiters for the upper and lower position of the lifeboat shall be provided in accordance with A.1.9.

The motion limiter for the upper position shall stop the movement at the level for boarding the lifeboat. Prior to reaching the upper stop position, the hoisting speed shall be automatically reduced by at least 50%.

A.7.2.3 Control station

A control station shall be located on the host installation. The following control devices shall be arranged at the control station:

- a) start device to enable power supply to the launching and recovery appliance;
- b) stop device to disable power supply to the launching and recovery appliance;
- c) emergency stop for emergency purposes to stop all motions;
- d) movement control devices for hoisting and lowering and, if applicable, any other movements. All movement control devices shall be of the holt-to-run type, i.e. return to neutral position when released.

All movements shall have variable speed control, either stepless variable speed or variable speed in 2 more defined steps;

- e) control devices for emergency operation system (EOS);
- f) operating and indicating devices for rope tensioning system (if provided).

The control station must be located so that the operator has a clear view to the rescue boat during all movements.

A.7.2.4 Gravity lowering

In case of gravity lowering, the lowering speed shall be controlled by two independent constant speed control devices. The speed control devices shall be able to control the lowering motion within the speed limit given in A.1.6. In case of failure in one of the speed control devices, the speed should not exceed 1,5 m/s.

A.7.2.5 Secondary independent power and control system

In case of unintended stops as result of power failure or failure in the control system, secondary independent power and control systems in accordance with A.1.11 shall be provided. The secondary independent power and control system shall be operable within 1 min after an unintended stop.

For launching and recovery appliances utilising gravity lowering, the secondary independent power and control system is only required for the hoisting motion and any other motions necessary for recovering the rescue boat to its stowed position.

A.7.2.6 Brakes

Mechanisms for all motions under the influence of gravity shall be provided with brakes in accordance with 5.7.6 (primary brake) and a backup brake in accordance with A.1.10.

A.7.2.7 Rope tensioning system

If a rope tensioning system is provided, the following requirements apply:

- When activated, the system shall provide a tension force at the means of connection on the rescue boat not higher than 50% of the rated capacity of the launching and recovery appliance when the control device for the hoisting movement is operated to its full hoisting position;
- The system shall be able to maintain tension in the winch rope at any time in the LS condition, i.e. both when winch is pulling rope in and when winch rope is being pulled out;
- It shall not be possible to activate the system when the winch is loaded;
- Activation of the system shall be possible only by two deliberate actions by the operator. When the first action is performed, a visual signal shall be provided to indicate that the system is ready. When the second action is performed a different visual signal shall be provided to indicate that the system is active;
- The system shall automatically be re-set to the un-activated state when command for full hoisting force is given. It shall also be possible for the operator to manually de-activate the system by a single action at any time;
- A fault in the control system for rope tensioning system shall be detected and render the system inactive, giving a visual and acoustic alarm to the operator, without increasing the risk represented by the hoisting system.
- Operating devices and indicating devices for the rope tensioning system shall be clearly marked.

A.7.2.8 Overspeed protection

An overspeed protection device shall be implemented to prevent free fall or excessive lowering speed without exposing persons or equipment to unacceptable accelerations. When overspeed is detected, both primary brake and backup brake shall be applied and dynamic coefficient, $\Phi_{2,C6}$, shall not exceed 3. In order to prevent unintended triggering of the overspeed protection device, the triggering speed shall exceed the drum rotation speed necessary for operation of the rope tensioning system (if provided).

For gravity lowering systems provided with two mechanically independent constant speed control devices, overspeed protection need not be implemented.

A.7.3 Means of connection, release mechanism and systems

Release mechanism shall be placed on and operated from the rescue boat.

The release mechanism shall have an off-load release capability in accordance with clause 4.4.7.6.7.1 of the LSA Code.

Any handles or non load-bearing parts of means of connection shall be designed to prevent incorrect attachment to each other.

Means of connection, including release mechanism, shall be calculated and tested in accordance with A.7.6.

A.7.4 Elastic pennant for lifting rescue boat with offshore crane

A.7.4.1 General

When lifting a rescue boat (group A.6) with offshore crane, an elastic pennant shall be utilised in order to limit the dynamic impact acting on the load bearing ~~structural~~ parts of the boat and the personnel on board.

The elastic pennant shall be ~~selected and dedicated~~ designed for the maximum gross mass of the particular rescue boat to be lifted and the ~~expected~~ intended service.

Service is defined by the combination of:

- maximum steady state hoisting speed for the offshore crane(s) to be used for lifting the ~~boat~~ rescue boat, when lifting a load equal to the maximum gross mass of the rescue boat, and
- type of host installation on which the offshore crane is located (i.e. bottom fixed, semisubmersible or monohull shaped/FPSO).

The elastic pennant shall consist of a single legged sling made from 8-strand plaited construction man made fibre rope (Polyamid) in accordance with EN 1492-4.

NOTE Other rope constructions may also be considered, but at the time of publication of this NORSOK standard, this is the most commonly used rope construction for this purpose and other constructions are not considered sufficiently qualified. Other rope constructions must be qualified in accordance with 4.15.

The sling shall have spliced eyes with thimbles and permanent fittings in both ends. Consideration shall be given to the weight of end-connections and risk of entanglement and harm to personnel operating the equipment.

Links, rings etc used as means of connection shall be in accordance with A.1.8.3. using factors from load combinations described in A.7.6.2. Means of connection in the lower end of the pennant shall be designed such that incorrect attachment and snagging hazards are avoided.

The sling length shall be calculated by taking into account the maximum allowable dynamic factors and safety factors given in A.7.4.3. However, sling length shall not be less than 8m.

It is assumed that the offshore crane is designed with sufficient hoisting/lowering velocity to avoid re-entry in the LS (life saving) condition.

A.7.4.2 Working load limit (WLL)

A.7.4.2 Working load limit (WLL)

The working load limit, WLL_{R002A} (tonnes), for an elastic pennant including its end fittings shall be ~~equal to or greater than~~ compatible with the gross mass of the fully equipped rescue boat with its full complement of persons. The working load limit relates to a specific service as described in A.7.4.1.

Formatert: Normal, Mellomrom Før: 6 pkt, Etter: 6 pkt, Tabulatorstopp: 1,5 cm, Left

Formatert: Skrift: Arial, 10 pkt, Engelsk (Storbritannia)

Formatert: Listeavsnitt, Punktmerket + Nivå: 1 + Justert ved: 0,63 cm + Innrykk ved: 1,27 cm

Formatert: Normal

Formatert: Normal, Mellomrom Før: 6 pkt, Etter: 6 pkt, Tabulatorstopp: 1,5 cm, Left

Formatert: Normal, Mellomrom Før: 6 pkt, Etter: 6 pkt, Tabulatorstopp: 1,5 cm, Left

NOTE The WLL for elastic pennants for rescue boats is labelled with the index "R002A" in order to it from lifting slings for general service.

Formatert: Normal

A.7.4.3 Safety factors Selection of rope diameter

Ropes for elastic pennants shall be selected with the specified minimum breaking load, MBL (tonnes) and kN giving a static spring rate in order to satisfy the following requirements for static and dynamic safety factors: factor not less than 10.

Formatert: Normal, Mellomrom Før: 6 pkt, Etter: 6 pkt, Tabulatorstopp: 1,5 cm, Left

Static safety factor, SF_{Stat} , is the ratio between the 90 % of MBL and WLL:

$$SF_{Stat} = \frac{90\% MBL}{WLL_{R002A} \cdot g} \geq 10 \quad (A.18)$$

Feltkode endret

where:

- MBL is the specified minimum breaking load (in kN) for the fibre rope used in the elastic pennant
- $g = 9,81 \text{ m/s}^2$ is the acceleration of gravity.

Formatert: Listeavsnitt, Punktmerket + Nivå: 1 + Justert ved: 1,92 cm + Innrykk ved: 2,55 cm

Formatert: Skrift: Arial, 10 pkt, Engelsk (Storbritannia)

Formatert: Skrift: Arial, 10 pkt, Engelsk (Storbritannia)

Formatert: Skrift: Arial, 10 pkt, Engelsk (Storbritannia)

The criterion described in expression (A.18) is used to select a rope diameter having the necessary MBL giving a static safety factor not less than 10.

Dynamic safety factor, SF_{Dyn} , is the minimum required safety factor based on dynamic factor, partial safety factor, risk coefficient and rope resistance factor as follows:

$$SF_{Dyn} = \phi \cdot \gamma_p \cdot \gamma_n \cdot \gamma_{rb} \quad (A.19)$$

Formatert: Ikke juster avstand mellom asiatisk og latinsk tekst, Ikke juster avstand mellom asiatisk tekst og tall

Formatert: Skrift: ArialMT, 9,5 pkt

where

γ_p is the partial safety factor

$\gamma_p = 1,34$ for load combination A

$\gamma_p = 1,1$ for load combination C

$\gamma_n = 1,5$ is the risk coefficient as described in 5.0

$\gamma_{rb} = 2,3$ is the rope resistance factor for fibre ropes

$$\phi = 1 + \frac{V_R}{g} \sqrt{\frac{K}{WLL_{R002A}}} \quad (A.20)$$

$$V_R = 0,5 \times V_{WLL} + \sqrt{V_D^2 + V_C^2} \quad (A.21)$$

where

V_{WLL} (m/s) is the maximum steady state hoisting velocity the crane is able to lift the gross mass of the rescue boat

V_D (m/s) is given by expression (A.6) in A.1.5.7

V_C (m/s) is given by expression (A.7) in A.1.5.7

K is the static stiffness (in kN/m) for the elastic pennant

NOTE The dynamic factor, ϕ , is only dependent on the characteristics of the fibre rope used in the elastic pennant, in addition to the relative velocity and WLL. For the purpose of calculating the dynamic factor, the crane is assumed to be indefinitely stiff.

Formatert: Normal

The dynamic factor, ϕ , and the dynamic safety factor, SF_{Dyn} , shall be calculated for load combinations (LC) A

Formatert: Innrykk: Venstre: 0 cm, Første linje: 0 cm

and C, where

LCA is pick-up of rescue boat from sea in the NLS condition

LCC is pick-up of rescue boat from sea in the LS condition

Formatert: Innrykk: Første linje: 1,27 cm

It is assumed that the offshore crane is designed with sufficient hoisting/lowering velocity to avoid re-entry in the LS condition.

The dynamic safety factor, SF_{Dynt} , shall not exceed the static safety factor, SF_{Stat} in any load combination.

The dynamic factor, Φ , shall not exceed 2,5 for LCA and 3,0 for LCC.

Formatert: Skrift: 8 pkt

NOTE Increasing the static safety factor contributes to increased operational risk when handling the elastic pennant in rough seas due to heavier equipment and larger dimensions. A higher static safety factor also gives less elasticity, i.e. increases the dynamic factor. Keeping the static safety factor as low as possible is therefore desirable, although not less than 10.

Formatert: Normal

A.7.4.4

A.7.4.4 Calculation of minimum required rope length for the elastic pennant

The static stiffness of the elastic pennant must provide a sufficiently low dynamic factor. The static stiffness varies in inverse ratio to the length of the elastic pennant as shown in A.7.4.5. There are two main criteria to be considered:

- The lifted rescue boat must be protected against excessive dynamics, i.e. the dynamic factors given in A.7.6.2 must not be exceeded for the load combinations LCA and LCC defined in A.7.6.2.
- The elastic pennant itself must be protected against excessive dynamics, i.e. the dynamic safety factor SF_{Dynt} must not exceed the actual static safety factor SF_{Stat} for load combinations LCA and LCC defined in A.7.6.2.

Applying these two main criteria for both LCA and LCC makes a total of 4 criteria to be met by the selected rope length:

1: $\Phi_{LCA} \leq 2,5$

2: $\Phi_{LCC} \leq 3,0$

3: $SF_{Dynt,LCA} \leq SF_{stat}$

4: $SF_{Dynt,LCC} \leq SF_{stat}$

NOTE: LCA is pick-up of rescue boat from sea in the NLS condition.

LCC is pick-up of rescue boat from sea in the LS condition

Formatert: Innrykk: Første linje: 1,27 cm

Dynamic safety factor, SF_{Dyn} , is the product of dynamic factor, partial safety factor, risk coefficient and rope resistance factor as follows:

$$SF_{Dyn} = \phi \cdot \gamma_p \cdot \gamma_n \cdot \gamma_{rb} \quad (A.19)$$

Feltkode endret

where:

γ_p is the partial safety factor

$\gamma_p = 1,34$ for load combination A

$\gamma_p = 1,1$ for load combination C

$\gamma_n = 1,5$ is the risk coefficient as described in 5.9

$\gamma_{rb} = 2,3$ is the rope resistance factor for fibre ropes

The dynamic factor, ϕ , at pick-up from sea is given by the following expression:

$$\phi = 1 + \frac{V_R}{g} \sqrt{\frac{K}{WLL_{R002A}}} \quad \text{is the dynamic factor for pickup of rescue boat from sea} \quad (A.20)$$

NOTE: The dynamic factor, ϕ , is only dependent on the characteristics of the fibre rope used in the elastic pennant, in addition to the relative velocity and WLL. For the purpose of calculating the dynamic factor, the crane is assumed to be indefinitely stiff.

Formatert: Normal

Formatert: Innrykk: Venstre: 0 cm, Første linje: 0 cm

where:

$$V_R = 0,5 \times V_H + \sqrt{V_D^2 + V_C^2} \quad (A.21)$$

Feltkode endret

V_R (m/s) is the relative velocity (in m/s) between rescue boat and crane hook at pick-up

Feltkode endret

V_H (m/s) is the maximum steady state hoisting velocity the crane is able to lift the gross mass of the rescue boat

Feltkode endret

V_D (m/s) is given by expression (A.6) in A.1.5.7

Feltkode endret

V_C (m/s) is given by expression (A.7) in A.1.5.7

K is the static stiffness (in kN/m) for the elastic pennant, as described in A.7.4.5.

Feltkode endret

A.7.4.5 Static stiffness

Formatert: Normal, Mellomrom Før: 6 pkt, Etter: 6 pkt, Tabulatorstopp: 1,5 cm, Left

Elastic pennants shall be designed with a sufficiently low static stiffness, K (kN/m), necessary for obtaining the required dynamic safety factor and dynamic factors given in A.7.4.3.

Key factors for determining the static stiffness are the pennant length and force-elongation curve documented by type testing in accordance with A.7.4.5 for the particular rope construction and rope diameter. The pennant length used in the calculations shall be the length between splices.

For the purpose of this NORSOK standard the static stiffness is based on a simplified linear force-elongation curve crossing the real force-elongation curve at 0% of MBL and 20% of MBL.

When force-elongation curves are presented by rope manufacturers as dimensionless curves showing force-strain normalized to MBL, the static stiffness (K) is determined from the dimensionless static stiffness (K') read from such curves as follows:

$$K = K' \times MBL/L \quad (A.22)$$

where: L is the length between splices of the particular pennant, measured at reference tension according to ISO2307

NOTE: Reference is made to the calculation example in Annex I for a more detailed description of the static stiffness.

A.7.4.56 Testing

Test requirements given in EN 1492-4 shall apply with the following additional requirements:

The manufacturer of elastic pennants shall perform type tests in accordance with EN 1492-4, 6.3, on each nominal rope size

NOTE This requirement is complementary to the requirement for general purpose slings, for which representative type test are performed for groups of sizes

The manufacturing test specified in EN 1492-4, 6.5, shall be performed on at least one sample of elastic pennant made from the same rope drum.

NOTE: ~~The test sample need not have the same length as the final delivered elastic pennant, as long as the distance between the tails of splices on the test sample is not less than 15 times the nominal rope diameter (ref. EN 1492-4, clause 6.3.2)~~

The force-elongation curve for the particular rope construction and nominal rope size shall be documented by type testing, following the procedure of chapter 9 in ISO 2307 with the following additional requirements:

- ~~The test sample shall be subjected to 10 cycles during the bedding-in procedure in chapter 9.5 of ISO 2307,~~
- ~~The force-elongation curve to be used for calculating the static stiffness shall be obtained by continuous recording of the force and elongation coordinates during tensile test up to 50% of MBL in accordance with chapter 9.6 of ISO 2307.~~

A.7.4.67 Marking

In addition to the marking specified in EN 1492-4, clause 7, the sling shall be labelled "R-002A Elastic pennant". The label shall also be marked with the ~~maximum steady state hoisting velocity (m/s) for which the elastic pennant is intended to lift the rescue boat service for which it is designed, see A.7.4.1.~~

A.7.4.78 Certificate

The manufacturer's certificate for the elastic pennant shall be labelled "R-002A Elastic pennant" in addition to the information required in EN 1492-4, clause 8. ~~The working load limit (WLL_{R002A}) as calculated according to this standards shall be stated instead of the working load limit according to EN 1492-4.~~

The certificate shall state the ~~maximum steady state hoisting velocity (in m/s) for service to which the elastic pennant-WLL_{R002A} is intended to lift the rescue boat related, ref. A.7.4.2.~~

~~The certificate for the elastic pennant shall identify the rescue boat which include links or other components permanently attached to the elastic pennant is intended to lift.~~

A.7.4.89 Calculation example

An informative example of how to select diameter and length of the elastic pennant is given in Annex I.

A.7.5 Instructions for use of elastic pennants

Elastic pennants shall be accompanied with instructions for use as specified in Annex A and Annex C (as appropriate) of EN 1492-4. In addition the following instructions shall be stated:

Formatert: Normal, Mellomrom Før: 6 pkt, Etter: 6 pkt, Tabulatorstopp: 1,5 cm, Left

Formatert: Normal

Formatert: Skrift:

Formatert: Normal, Ikke legg til avstand mellom avsnitt med samme stil

Formatert: Skrift:

Formatert: Normal, Mellomrom Før: 6 pkt, Etter: 6 pkt, Tabulatorstopp: 1,5 cm, Left

Formatert: Normal, Mellomrom Før: 6 pkt, Etter: 6 pkt, Tabulatorstopp: 1,5 cm, Left

Formatert: Engelsk (USA)

Formatert: Engelsk (USA)

Formatert: Engelsk (USA)

Formatert: Engelsk (USA)

Formatert: Skrift: Calibri, 11 pkt, Skrifffarge: Egendefinert farge(RGB(31;73;125)), Engelsk (USA)

Formatert: Engelsk (USA)

Formatert: Normal, Mellomrom Før: 6 pkt, Etter: 6 pkt, Tabulatorstopp: 1,5 cm, Left

- this elastic pennant is only intended for lifting and lowering ~~the~~ rescue boat within the working load limit related to the service as stated in the certificate ~~only~~. Any other use of the elastic pennant is prohibited;
- this elastic pennant shall only be used to lift the rescue boat in a straight lift. No choking is allowed;
- this elastic pennant is intended for use in training operations in wave conditions up to and including 3 m significant wave height. It is also intended for real rescue operations in wave conditions up to and including 6 m significant wave height;
- a thorough examination shall be performed after each training operation;
- the elastic pennant shall be replaced immediately if it has been used in rescue operations in wave conditions exceeding 3 m significant wave height;
- the elastic pennant shall be replaced every second year, regardless of condition as determined by visual examination.

Formatert: Ingen punktmerking eller nummerering

Formatert: Skrift: Calibri, 11 pkt, Skriftfarge: Egendefinert farge(31;73;125)), Engelsk (USA)

Formatert: Engelsk (USA)

A.7.6 Load bearing parts of rescue boats

A.7.6.1 General

The proof of competence shall be carried out in accordance with A.1.3, A.1.7 and A.1.8 for means of connection and their anchorage points which are integral part of the rescue boat.

A.7.6.2 Load combinations

For the purpose of proof calculations, the mass of hoist load shall be taken as the weight of the fully equipped rescue boat with its full complement of persons (crew and passengers).

The following load combinations shall be applied to rescue boats:

Load combination A:

Pick-up from sea in the NLS condition.

- Dynamic factor: $\Phi_2 = 2,5$
- Partial safety factor: $\gamma_p = 1,34$
- Risk coefficient: $\gamma_n = 1,5$

Load combination C:

Pick-up from sea in the LS condition.

- Dynamic factor: $\Phi_2 = 3,0$
- Partial safety factor: $\gamma_p = 1,1$
- Risk coefficient: $\gamma_n = 1,5$

The load combinations shall take into account lateral deviation angles of loads as specified in A.1.4.4.

A.7.6.3 Load testing

Individual components of means of connection shall be subjected to a proof load test in accordance with A.1.8.3.3.

The assembled rescue boat shall be subjected to prototype testing and production tests in accordance with the requirements of the LSA Code.

A.7.7 Instructions for use of offshore cranes

The crane shall be equipped with a detailed instruction for rescue boat operations. The instruction shall be summarised in a procedure for training and emergency operations. The procedure shall be included in the emergency preparedness plan for the installation.

The procedure for rescue boat operations shall include, but not be limited to

- authority and responsibility for involved personnel,
- planning and precautions,
- announcement routines,

Formatert: Punktmerket + Nivå: 1 + Justert ved: 0,25 cm + Innrykk ved: 0,75 cm

- crane information,
- rescue boat information,
- any equipment to be used,
- manning and personnel qualifications,
- personnel safety equipment,
- communication equipment and procedure,
- operational limitations, including dynamic load charts which describe the option for deliberate exceeding the ~~suppliers~~ supplier's recommendation during emergency operations.

A dynamic load chart shall be calculated for the actual rescue boat that is to be lifted.

The dynamic load chart shall clearly state the conditions upon which it is based and, if relevant, the type and specification of the elastic fibre rope sling that is to be used.

The dynamic load chart shall differentiate between training operations and emergency operations.

NOTE In an emergency where the offshore crane is to be used for handling the rescue boat, it is to be noted that this operation has to be authorised by the installation management in each case. In an emergency situation the operational risks as well as the technical risks for the rescue team have to be balanced against the actual conditions and the probability of a successful rescue operation.

A.7.8 Instructions for use of dedicated rescue boat cranes or davits

The rescue boat crane or davit shall be equipped with a detailed instruction for rescue boat operations. The instruction shall be summarised in a procedure for training and emergency operations. The procedure shall be included in the emergency preparedness plan for the installation.

The procedure for rescue boat operations shall include but not be limited to

- authority and responsibility for involved personnel,
- planning and precautions,
- announcement routines,
- crane/davit information,
- setting of personnel lift mode,
- rescue boat information,
- any equipment to be used,
- manning and personnel qualifications,
- personnel safety equipment,
- communication equipment and procedure,
- operational limitations, including dynamic load charts which describe the option for deliberate exceeding the suppliers recommendation during emergency operations.

← **Formater:** Punktmerket + Nivå: 1 +
Justert ved: 0,25 cm + Innrykk ved:
0,75 cm

A dynamic load chart shall be calculated for the actual rescue boat that is to be lifted. The calculation shall take into account the applicable damping effect of an elastic sling, motion compensator or shock absorber.

The dynamic load chart shall clearly differentiate between training operations and emergency operations.

NOTE In an emergency where the crane or davit is to be used for handling the rescue boat, this operation has to be authorised by the installation management in each case. In such situations the operational risks as well as the technical risks for the rescue team, have to be balanced against the actual conditions and the probability of a successful rescue operation.

A.8 Personnel transfer carriers (Group A.7)

Personnel transfer carriers shall be designed to be picked up from a supply vessel to a fixed or floating offshore installation in a sea state corresponding to significant wave height (Hs) of at least 3m.

The proof of competence for personnel transfer carriers and its dedicated lifting sets shall be performed in accordance with Annex F, as described for group F.5, taking into account:

- The weight *W* specified in Annex F is the Maximum Gross Mass (tonnes), corresponding to the sum of:
 - Tara weight (tonnes) of the ~~basket~~ carrier, and

- Payload (tonnes) of the basketcarrier, taken as at least:
 - Payload = $n \cdot (m_p + m_e)$

where:

 - n is the number of persons allowed in the carrier and shall not be less than 2
 - $m_p \geq 0,100$ tonnes is the minimum mass of each person
 - $m_e \geq 0,040$ tonnes is the minimum mass of luggage or other equipment for each person
- The design factor (DF) given in clause F.7.2.3.8 of Annex F shall be increased by multiplying with a factor of 1,5.
- Unless detailed calculations of the dynamic amplification factor (DAF) justifies other values when the carrier is lifted from a supply vessel to the intended installation at the intended sea states, DAF shall be as specified for offboard lifting in section F.7.2.3.5 of Annex F.
- If the weight W is less than 2 tonnes, the proof of competence shall be made for W=2 tonnes.
- The crane hoisting speed shall be assumed no less than 2 m/s

The carrier shall be designed for lifting personnel that are sitting.

The seats shall be equipped with seat belts that are easy to disconnect.

The carrier shall be designed to protect passengers from harmful accelerations/decelerations when the carrier is subjected to a vertical impact speed of minimum 4 m/s due to relative speed between boat deck and carrier at lift off or landing, and when the carrier is subjected to a horizontal impact speed of minimum 2 m/s due to swinging against an obstruction. A damaged carrier may be acceptable when subjected to the horizontal impact, but the load bearing capacity shall not be reduced.

The carrier shall be designed to facilitate transport of at least one injured person on a stretcher together with medical personnel.

The carrier shall be equipped with two dedicated lifting sets with independent lifting points in the carrier and with independent top links. The top links to be attached to the crane hook should have minimum internal dimensions 270 × 140 mm. Each individual lifting set shall be designed for the full load when calculated in accordance with the above requirements. The lifting sets shall be permanently attached to independent lifting points of the carrier with means requiring tools to remove.

The length of the lifting sets shall be sufficient to allow necessary slack-off after landing on a vessel deck to prevent snagging due to vessel motions.

The carrier must be designed to protect the passengers from entangling with the lifting sets or the crane hook after landing on a vessel deck.

The carrier must be designed to float in an upright position if immersed into the sea.

Annex B (Normative) Material handling principles

B.1 Concept principles

Material handling principles cover all activities related to handling of goods and materials to and from and at the installation in all phases of its lifetime.

The installation shall be designed to ensure that the number of lifting operations is minimized, and with sufficient lay-down, storage areas and transportation routes for safe and efficient operation of the installation. Due consideration shall be given to the different phases of use of the installation, including all operations, regular maintenance, shutdowns for major overhaul and simultaneous operations. To facilitate use of fork lift truck or trolley, all transportation routes shall be planned without any obstructions and thresholds. Transportation routes shall be dimensioned for the weight and size of equipment that will be transported to and from the area.

Operators of lifting appliances shall have a clear view of load and handling areas in regular use.

When designing areas for maintenance, the safest lifting equipment and lifting concepts shall take preference. Concepts for material handling that are impervious to weather conditions, shall take preference.

In order to avoid unnecessary shut down of process systems in the operation period, the installation shall be designed with safe lifting and transport routes for all equipment that has to be dismantled regularly for service, testing and control, see B.3.3.

Priorities of preference for lifting equipment are as follows:

- a) Automated (handsfree) material handling concepts for frequently repeated operations
- a)b) Forklift trucks/personnel and goods lifts/lorries with cranes/mobile cranes/.
- b)c) Permanent crane/lifting foundations.
- d) Lorries with cranes/mobile cranes
- e)e) Temporary/other mobile lifting equipment.
- e)f) Rigging equipment.

Due consideration shall be given to the effect of inclinations and motions on floating installations and vibrations from other equipment. Types of lifting equipment shall be selected in order to avoid the exposure of employees to risks from uncontrolled horizontal or vertical movements from the lifting appliances, or load colliding with employees, moving unintentionally, coming loose unintentionally or free falling. In addition, the environment shall be considered, in areas where material handling equipment is used and stored.

The criticality and economic importance of the load (special process equipment), shall be reflected when selecting the safety level for lifting and transport equipment to handle the load, e.g. additional lifting and braking systems and emergency lowering facilities, see 4.11.4, 5.1.1 and 5.9.

Bulk hose transfer stations on offshore installations shall be designed with hoses on power driven hose reels or similar solution. The hose end should have an automatic connection system for connection to the supply vessel.

B.2 General requirements

Projects for development of new installations shall establish the following documents:

- general material handling philosophy in accordance with B.5;
- offshore crane study in accordance with B.6;
- material handling plan in accordance with B.7.

← **Formatert:** Punktmerket + Nivå: 1 +
Justert ved: 0,25 cm + Innrykk ved:
0,75 cm

NOTE: Offshore crane study is not relevant for onshore petroleum installations.

Formatert: Skrift: 8 pkt

Formatert: Skrift: 8 pkt

The above mentioned documents shall be used as basis for:

- general design of the installation with respect to optimised material handling,
- detailed engineering of material handling,
- purchase ~~specificaitons~~ specifications of equipment,
- planning of material handling during operation, maintenance and decommissioning of the installation

The project shall ensure that necessary documentation from suppliers is incorporated into the documents.

Modification projects shall update existing philosophies, studies and plans, if relevant.

If the installation consists of more than one deck elevation, and is permanently manned, it shall be equipped with a sufficient number of personnel and goods lifts. The size and capacity of these lifts shall be adjusted to the size/weight of the largest/heaviest items to be transported by the lift, but the minimum capacity shall be 1 500 kg. The personnel and goods lift shall give access to the main transportation routes at all deck levels. Good access to main workshop/stores shall be given priority.

Lifting of equipment of more than 25 kg shall be done by means of mechanical lifting.

If lifting or transporting of loads weighing more than 25 kg is required, there shall be enough space for the use of lifting and transportation gear.

Permanent ~~arrangements (e.g. monorails, lifting lugs)~~ equipment shall be installed for material handling of equipment/objects > 200 kg and which require regular maintenance, if it is not reachable for a fork lift truck or other movable lifting appliances.

Minimum requirements for material handling of equipment are given in Table B.1.

Table B.1 – Requirements for material handling

Weight	Maintenance interval		
	Yearly < 2 years	2 years to 5 years	> 5 years
25 to 200 kg	A	B	C
200 kg to 2 tonnes	A	B	B
> 2 tonnes	A	A	A

Key
A: Permanently installed lifting ~~arrangement~~ equipment, e.g. ~~monorails~~ cranes or suspensions such as runway beams/pad eyes for assembly of hoists.
B: A description (material handling plan) for material handling of equipment with use of temporary lifting equipment. The plan shall include documentation of structural capacity of all lifting points of more than 200 kg.
C: No requirements for documentation of material handling.

Lifting equipment intended for infrequent use, but exposed to wind, rain, snow or sea spray, shall be designed for easy and safe dismantling, re-installation and storage in warehouse.

Permanently installed lifting equipment, which are exposed to wind, rain, snow or sea spray, shall be designed with extra protection against corrosion, and preferably be parked/stored in a weather protected garage.

When installing lifting equipment near flares, burners and exhaust outlets on the installations, due consideration shall be given to the effects of thermal exposure on the lifting equipment during the lifetime of the installation, e.g. on sensitive electric components, non-metallic materials, steel wire ropes, ventilation of cabin, oil temperature etc.

Dedicated areas for operation of mobile cranes and loader cranes on onshore installations

A suitable number of permanent areas for operation of mobile cranes and loader cranes shall be arranged at onshore installations. The areas shall be located for maximum crane coverage and view from the control stations and to minimize any risk during the lifting operations. The ground shall be dimensioned for the maximum expected ground pressure from stabilisers. The area shall be clearly and permanently marked and be included in the material handling plan.

Offshore cranes

Offshore cranes in accordance with Annex G shall be located in places which give the best combination of crane coverage and a clear view of the handling areas and supply vessels from the operator cabins.

The offshore cranes shall cover the deck area and lay down/storage and handling areas including the entire pipe deck (installations with drilling or work-over facilities only). For offshore installations with more than one offshore crane, common lay down areas that are reachable by two offshore cranes, shall be provided. Lay down areas close to the crane pedestals (i.e. at shorter radius than ~~minium~~minimum working radius) shall be avoided.

The offshore cranes shall have the outreach necessary to avoid offlead in conjunction with handling of loading hoses to/from supply vessels.

The offshore cranes, including crane hooks, shall not be planned used as hang-off points for other material handling equipment.

Offshore crane boom rests shall be provided.

A dedicated area with access for maintenance (e.g. replacement of crane hooks and steel wire ropes), with an arrangement for storage of main load and whip line hooks, shall be provided. The need for a separate working platform for this purpose shall be considered.

A device for load testing of the main cranes should be installed in the deck structure, if specified by the crane manufacturer.

B.3 Working areas

B.3.1 General

Main lay down areas for regular material handling shall be clearly visible from the control station of the lifting appliances that handles loads to and from such areas.

Remotely operated lifting operations where no personnel are exposed to suspended loads when the load is automatically connected and disconnected, can be performed when supervised (observed) by a camera.

The working areas shall be designed to withstand the loads that will be placed in the area. Working areas and lay down areas shall normally be located in a safe zone and provided with heavy-duty barriers to prevent damage to adjacent equipment.

On floating installations, attachment points for sea fastening of cargo shall be provided. Lifting appliances and their working areas shall be located so as to minimise the risk of load handling, impacts and dropped object damage to systems and structures.

Information regarding the extension and weight capacities of working and lay-down areas shall be available to the operator of the crane in use.

Lay down areas shall be designed such that the signaller and slinger easily can escape to a safe position.

On offshore installations, hose loading stations and rescue boat shall be visible from the offshore crane cabins if the rescue boat is to be launched by offshore crane.

Walls close to working areas and lay down areas should as far as possible have clean surfaces without obstructions, e.g. flood lights, cable trays, piping, etc.

B.3.2 Bumpers and protective structures

Suitable bumpers for impact protection against horizontal and vertical loads shall be provided where necessary in the working and lay down areas where lifting equipment is used. The impact protection shall have a design able to absorb the energy induced by the lifting appliances and their loads without being

damaged in a way that causes unacceptable risk and/or possible harm, and shall facilitate means for personnel escape in danger zones. Bumpers shall preferably be made of vertical elements facing the load handling area to prevent loads from snagging the bumper. Bumpers should have a conspicuous colour distinguished from the ~~surroundings~~ surroundings.

Suitable protective structures for swinging loads shall be provided for protection of escape routes, lighting fixtures, instrumentation, piping and other equipment near the working and storage areas. On floating installations, working and lay down areas shall be equipped with reinforced impact protection, designed to take up the loads induced by the installation's motions and the motions induced by the lifting appliances. Protective structures should be ~~colored~~ coloured in accordance with local ~~color~~ colour coding schedule for cordon-off at the installation.

B.3.3 Lifting zones

The term "dropped object" in this subclause means the load, parts of the load, any lifting accessories or crane booms which have the potential of being dropped or moved unintentionally within the lifting area as a consequence of a mechanical or system failure.

All areas within the working area of lifting appliances shall be evaluated and classified according to the consequences of dropped objects, and this shall be reflected in the lifting restriction charts for the installation, see B.5 and table B.2.

Table B.2 – Classification of lifting areas

Red areas	Areas where the consequence of dropped object is unacceptable to the installation or to personnel, and lifting is not permitted. Typical examples are areas with process equipment containing pressurised hydrocarbons or flammable or toxic gas/liquids, normally manned areas and areas with essential (for safety) electric equipment or cables. In red areas, such equipment or normally manned areas are not protected against dropped objects.
Yellow areas	Areas where the consequence of dropped objects is serious for the installation and for personnel. A risk assessment shall be performed, and lifting shall be according to strict procedures only. Typical examples are areas with process equipment containing pressurised hydrocarbons or flammable or toxic gas/liquids, normally manned areas and areas with essential (for safety) electric equipment or cables. In yellow areas, such equipment or normally manned areas are protected against dropped objects. The dropped object protection has defined limits regarding its protective effect, such as e.g. allowable lifting height, size, shape or weight of load etc.
Green areas	Areas planned and laid out for routine lifting operations. No restriction for routine lifts.

Predefined lifting zones should be defined as green areas. Areas where lifting will be performed, shall as a minimum be defined as yellow or green. All yellow areas shall have predefined lifting restrictions according to the loads expected to be handled in or above the area.

The green areas and dropped object protection devices in yellow areas shall be checked for impact from dropped objects according to the actions and accidental limit state defined in NORSOK N-003 and N-004. DNV-RP-C204 may also be used as reference. The impact loads for design of the deck area and protection devices shall be selected in accordance with relevant weight, size and drop height expected for the specific location.

Lifting operations in red areas ~~and outside defined limits in yellow areas,~~ may exceptionally be considered if the following types of measures have been implemented in accordance with an operational risk assessment:

- Consequence reducing measures,
- Probability reducing measures,
- Contingency plans

In addition, lifting equipment shall be ~~designed~~ designed and manufactured with built-in measures for high risk application in accordance with clause 5.9.

NOTE: This standard does not cover operational risk assessment and corresponding measures. Reference is given to authority regulations (PSA).

Formatert: Skrift: 8 pkt

Formatert: Skrift: 8 pkt

B.3.4 Shafts/hatches

Vertical handling of loads in shafts should preferably be by use of personnel and goods lift.

Shafts that will be used for lifting operations shall be designed in such a way that loads cannot get trapped or stuck.

Hatches that are opened and closed frequently should be hinged. Hatches shall be designed with a dedicated system for closing/opening and be arranged for securing in open position.

B.3.5 Lifting operations between installation and vessel

Unprotected critical equipment that can be damaged by falling loads (e.g. risers, pipelines, cables, subsea wellheads and equipment) shall not be installed in areas on and by the side of installations intended for loading and unloading of vessels. There shall be no drain or liquid outlets in the area that can harm the vessel or persons on board. There shall be no exhaust outlets in the area that can harm lifting appliance or lifting wire and reduce the view of the vessel. The installation shall be designed without obstructions that reduce the view of the vessel from the lifting appliance.

B.3.6 Transportation routes

~~Primarily~~Primarily, transportation of equipment on the installation shall be done by machine driven vehicles (e.g. forklift trucks on offshore installations, lorries at onshore installations) or manually operated trolleys.

The main transportation routes on an offshore installation should be designed for forklift trucks with a minimum capacity of 1 500 kg. To avoid unnecessary use of barriers, main gangways at the installation shall not be crossing under or be placed near the lifting routes of main lay down areas.

The need for protection barriers along transportation routes intended for transportation of large/heavy equipment, and in locations where forklift trucks are used, shall be evaluated. The protection barriers shall not obstruct access to equipment, valves, etc.

Entrances directly into transportation routes, shall be designed to avoid hazardous situations, such as collisions between personnel, transport equipment, automatic doors etc.

Transportation routes shall be sized to allow transportation of the largest/heaviest item from its location to the lay down area.

Transportation routes shall, where required, be designed for special transportation remedies, such as heavy lifts and/or forklift trucks, air film transporters etc. Transportation routes shall not contain steps or thresholds.

B.4 Material handling in a project

In parallel with the engineering of the installation, the engineering of lifting equipment for maintenance shall be carried out.

The feasibility of the material handling shall ~~preferably~~ be verified and documented, preferably by use of 3-D design tools.

Alternatively the feasibility can be verified as described below. Permanent lifting equipment shall preferably be installed and certified early in the construction phase, enabling its use during the rest of the construction phase; hence verifying the suitability and the safety of the lifting equipment.

Facilities, including safe access for maintenance, inspection and testing of essential elements and functions, shall be provided.

B.5 General material handling philosophy – Concept phase

A general philosophy for material handling in the project/module/installation shall be developed and approved by the company early in the concept phase. It shall be revised as the design changes, and finally issued as an as-built version.

The material handling philosophy shall as a minimum describe the following:

- a) main material handling equipment, e.g. main cranes, goods lift, mobile lifting beams, forklift truck, mobile cranes, lorries with cranes etc. including sizes and capacities;
- b) main material handling routes: to and from warehouse, to and from workshops, to and from pipe deck, to and from drill floor, to and from kitchen, to and from supply vessel, to and from quay, to and from
- c) ~~design~~ criteria for all transport routes/roads and parking spaces for mobile cranes, e.g. minimum axle load, free width and free height;
- d) lifting restriction charts for the installation, including philosophy for lifting across process areas;
- e) maximum allowable lifting heights, coverage and restrictions for the main cranes;
- f) lay down and storage areas including function, size and location, also covering lay down/storage areas for and handling of temporary, company provided and hired equipment;
- g) lifting areas, including sketches, which are not visible from the crane cabins;
- h) weather constraints (waves and wind);
- i) definition of largest/heaviest item to be handled per area including description of transportation route and type of handling equipment;
- j) deck load/ground capacities on all areas in the installation. Both loading areas, transport routes and areas between equipment. The deck load/ground capacities shall include allowable evenly distributed load, point loads, drop loads and forklift truck capacities, see also B.3.3;
- k) evaluation of concurrent crane operations on pipe deck – can be verified and documented by 3D design tool;
- l) requirements for dropped object protection;
- m) goods handling to/from helideck;
- n) load categories for ~~monorails~~ runway beams, hoists and pad eyes;
- o) requirements for use of rigging equipment and loose lifting equipment at the installation;
- p) material handling through shafts and hatches;
- q) standardization of the lifting equipment, limiting the number of different types of equipment.

B.6 Offshore crane study – Engineering phase

An offshore crane study document, based on the principles of the material handling philosophy, shall be prepared and maintained throughout the engineering phase. The feasibility of the material handling by means of the offshore crane shall be verified and documented by use of 3-D design tools. The document shall as a minimum contain the following elements:

- a) definition of all relevant documents for transmittal to the authorities;
- b) basis for location of offshore cranes and other main cranes;
- c) ~~visibility~~ line of sight from crane drivers position to lay down areas and lifting routes, and exceptions, if
- d) ~~line of sight~~ line of sight from crane drivers position to load handling area at supply vessel and lifting routes;
- e) ~~description~~ description of handling with offshore cranes to and from the supply vessels and internally on the topsides;
- f) ~~listing~~ listing of the most common lifting operations including frequency of these;
- g) ~~description~~ description of safe lifting routes for the most common lifting operations;
- h) ~~the most favourable~~ the most favourable location and arrangement of crane cabin, due to i.e. height above the most elevated crane-handling area, loading/unloading of vessels, blind zones, man-machine interface;
- i) ~~description~~ description of maximum allowable lifting heights, coverage and restrictions;
- j) ~~requirements~~ requirements for dropped object protection;
- k) ~~description~~ description of crane outfitting related to safety, alarms, communication, lightning, etc.;
- l) ~~description~~ description of situations where the crane booms shall be brought to the rest position and the frequency of these;
- m) ~~description~~ description of weather constraints (waves and wind);
- n) ~~evaluation~~ evaluation of concurrent crane operations on pipe deck;

- | a) description of crane operations involving transportation of personnel, e.g. rescue boat, personnel basket, etc.;
- | b) description of operational range, safe lifting routes and lay down areas for offshore cranes, if offshore cranes are to be used for transferring loads from one side of the installation to the other;
- | c) description of protection against heat radiation from flare, burners and exhaust outlets on crane cabins, crane systems and wires;
- | d) plot plan showing:
 - 1) crane locations,
 - 2) offshore crane operation range with and without jib, minimum radius and radius for heaviest lift,
 - 3) maximum allowable lifting heights,
 - 4) maximum weight capacities for lay down areas and transportation ways,
 - 5) lay down areas, including allowable loads (areas not visible from the crane cabin shall be highlighted),
 - 6) hose loading stations,
 - 7) tote tank area,
 - 8) access and transportation ways, including allowable loads,
 - 9) permanent and temporary restriction areas,
 - 10) dropped object protection,
 - 11) crane maintenance platform(s), including location for facilities for re-reeving and replacement of wire rope,
 - 12) storage for crane hooks,
 - 13) crane boom rests,
 - 14) rescue boat.

B.7 Material handling plan

The material handling philosophy, in the final as-built version, shall be included in the material handling plan.

This material handling plan shall identify all equipment that needs to be handled, and describe the method, equipment and the transport route to be used when lifting out the unit, transporting it to its destination, and replacing it. The document shall be part of the operational documentation for the installation.

Equipment of more than 25 kg and that requires regular maintenance according to B.2, Table B.1 or replacement during the design life of the installation, shall be included in the document.

When modifying the installation, the material handling plan shall be revised to reflect any changes made to areas, systems, equipment or lifting/transport facilities.

The material handling plan shall as a minimum contain the following:

- a) description of all material handling equipment, e.g. main cranes, personnel and goods lift, fork lift trucks, trolleys, air film transporters, elephant cranes, A-frames, mobile cranes, lorries with cranes etc. including tag numbers (when required), sizes and capacities;
- b) description of standardized sizes of foundations and suspensions for lifting equipment, as applicable, see Annex H;
- c) requirements for certification and marking of foundations and suspensions;
- d) description of the main material handling philosophy for internal transport on the installation;
- e) description of function, size and location of lay down and storage areas including areas for and handling of temporary, company provided and hired equipment;
- f) description of all items of more than 25 kg to be handled, including identification numbers, location, weight, size, expected maintenance/replacement intervals, type of lifting equipment/arrangement, lifting/handling procedure, transport route etc. In cases where the equipment vendor has incorporated comprehensive handling procedures in the maintenance manual, this can be referred to in the report. The material handling description for such equipment can be simplified by just defining the required lifting/transportation equipment and transport routes;
- g) requirements for transportation routes/roads including width and height in the different areas;
- h) description of goods handling to/from helicopter deck, if applicable;
- i) description of loading hose handling including hose replacement;
- j) description of areas where special protection of equipment is required, e.g. dropped object protection, truck barriers, swinging load protection etc.;
- k) material handling drawings based on equipment arrangement drawings or 3D plots including piping and valves containing the following:
 - 1) all equipment to be handled including lifting lugs, ~~monorails~~ runway beams, access ways etc.;

- 2) table containing all equipment identification numbers to be handled with corresponding identification numbers for the lifting equipment to be used;
 - 3) load capacities for lay down areas and transportation routes/roads.
- l) Dedicated areas for operation of mobile cranes and loader cranes on onshore installations

Annex C
(Normative)
Lifting accessories and lifting components – Group (G11)

C.1 General

The requirements of this annex apply in addition to the requirements stated in Clause 1 to Clause 5.

The requirements given in this annex are applicable only for lifting accessories intended for onshore and onboard lifting, unless offboard lifting is explicitly stated for particular groups or sub groups of this annex. Lifting accessories for offboard lifting shall in addition comply with applicable requirements in Annex F.

Fixed or detachable dedicated lifting points mounted on an object (e.g. machines, unit, structures etc.) are not subject to certification by an enterprise of competence according to NORSOK R-003 Annex H or R-005 Annex E, unless they are intended for repeatedly detachment and reuse. Requirements for fixed and detachable dedicated lifting points are given in Annex F, Group F5.

C.2 Group overview

The groups of lifting accessories covered by this annex are listed in Table C.1.

Table C.1 – Group overview and test requirements

Group no.	Group type	Sub. groups	Test requirements (see C.7.1)
R1	Chain sling	Sling with or without hook in the leg ends. Single and multiple legs	1
R2	Fibre sling	Flat woven webbing slings and round slings.	1
R3	Steel wire rope sling	- Sling with or without hook in the leg ends. Single and multiple legs - Grommets.	1 and 2, or 1 and 3 4
R4	Loose lifting components	- Shackles - Eye bolts/Nuts - Clamps - Lifting forks.	1 1 1 1
R5	Spreader and special designs	- Spreader beam, lifting beam, lifting frames - Pad eye flange - Magnet lifter - Vacuum lifter - Mechanical gripper	1, 2 or 4 2 or 4 1 1 1
R6	Load carrier	- Baskets for use on shore and internally offshore (inboard/onboard) - Big bag intended for multiple lifting and single lifts Note-NOTE Offshore load carriers – se Annex F Portable units.	2 1
R7	Forerunner/pennant offshore crane	-Single and double legs	2 or 3

Complementary requirements apply in addition to the requirements given in references under general requirements. In some cases, when particularly stated, the complementary requirements except or replace requirements given in references under general requirements. Complementary requirements are stated with reference to

- design
- materials,
- fabrication/manufacturing processes, tolerances and testing,
- information for use and maintenance,
- manufacturer's certificate,
- marking.

← **Formatert:** Punktmerket + Nivå: 1 +
Justert ved: 0,25 cm + Innrykk ved:
0,75 cm

C.4 Marking

It should be noted that legal marking may be required in addition to the marking requirements of this annex, e.g. CE-marking according to European directives, where such directives apply.

C.5 Design

Lifting accessories shall be designed to operate in a minimum operational temperature of -20 °C unless otherwise specified in standards referred to in this annex.

Bolts used in lifting accessories shall as a principle be secured with two mechanisms. Ref. 5.4.9.

C.6 Materials and fabrication

No material grades other than those mentioned in the references listed in general requirements for specific groups and sub groups of this annex should be used, unless explicitly stated in the complementary requirements in this annex. Other material grades may be used when qualified for the specific application in accordance with 4.15.

When complementary requirements for materials or fabrication are given under the specific groups or sub groups of this annex, materials selection and fabrication shall ~~be performed in accordance~~ comply with 5.22.

C.7 Load testing and documentation

C.7.1 Load test requirements

Each manufactured lifting accessory shall be subjected to a proof load test. Alternatively, samples from production may be selected for break load testing, or a ~~design verification~~ design verification by an enterprise of competence may be performed. One ~~or~~ or more of the following methods are available and shall be selected in accordance with the test requirements shown in Table C.1:

1. standard component tested during production in accordance with references listed in general requirements for specific groups and sub groups of -this annex. No additional test requirements;
2. test load 2 x WLL (or 2 x gross mass). (See Table C.2 for series and Table C.3 reduced test load over 25 t). For assembled slings, the test shall be performed either for each assembly or each individual leg. Spreader beams, lifting beams and lifting frames ~~with a WLL > 20t~~ shall be tested with test loads according to ILO Form No. 3. Spreader beams, lifting beams and lifting frames with a WLL > 20t intended to be used with a particular lifting appliance may be tested together with that lifting appliance with test loads according to ILO Form No. 2. Single and multi-~~sheave blocks with a WLL > 20t~~ shall be tested with test loads according to ILO Form No. 3. Sheave blocks intended to be used with a particular lifting appliance may be tested together with that lifting appliance with test loads according to ILO Form No. 2;
3. breaking load test on a sample length from each coil of rope with actual type of end terminations(see Table C.2 for series);
4. design verification ~~of~~ by enterprise of competence. A verification level corresponding to at least Medium according to DNV-OSS-308 (or equivalent) should be applied;
5. according to ISO 13535 / API Spec. 8C.

~~When combining chain components with fibre slings or steel wire rope slings, the whole lifting accessory shall be tested with 2x WLL.~~

Table C.2 - Test load 2 x WLL for series

Total number of units in a series	Proof load test, number of units to be tested from each series	Breaking load test, number of units to be tested from each batch.
1 to 5	1	1
6 to 10	2	1
11 to 20	3	1
21 to 40	4	1
> 40	10% unless otherwise agreed with enterprise of competence	> 1 To be agreed with enterprise of competence

Table C.3 - Reduced test load over 25 t

WLL (tonnes)	Static test load (tonnes)
WLL ≤ 25	2 x WLL
25 < WLL ≤ 30	55
30 < WLL ≤ 35	65
35 < WLL ≤ 40	70
40 < WLL ≤ 45	75
45 < WLL ≤ 50	85
50 < WLL ≤ 55	90
55 < WLL ≤ 60	95
60 < WLL ≤ 65	100
65 < WLL ≤ 70	110
70 < WLL ≤ 75	115
75 < WLL ≤ 80	120
80 < WLL ≤ 85	125
85 < WLL ≤ 90	130
90 < WLL ≤ 95	135
95 < WLL ≤ 100	145
100 < WLL ≤ 110	155
110 < WLL ≤ 120	165
120 < WLL ≤ 130	175
130 < WLL ≤ 140	190
140 < WLL ≤ 150	200
150 < WLL ≤ 160	215
160 < WLL ≤ 170	230
170 < WLL ≤ 180	240
WLL > 180	1,33 x WLL

C.7.2 Documentation

In addition to the technical file required by 5.25, each lifting accessory shall be accompanied by a certificate issued by an enterprise of competence prior to use in accordance with Annex E of NORSOK R-003, or NORSOK R-005, as applicable. The certificate shall state the applied test load in accordance with C.7.1.

C.8 Chain slings (Group R1)

C.8.1 General requirements

The requirements given in the following references apply:

Chains for chain slings:
See group R9 – Lifting components

Single-leg and multi-leg slings:

EN 818-4 Short link chain for lifting purposes – Safety – Part 4: Chain slings – Grade 8
EN 818-6 Short link chain for lifting purposes - Safety - Part 6: Chain slings - Specification for information for use and maintenance to be provided by the manufacturer

Components for upper and lower terminals of chain slings:
See group R9 – Lifting components

C.8.2 Complementary requirements for chain slings

C.8.2.1 Design

Mechanical joining devices of hinged type shall not be used in chain sling assemblies.

NOTE Mechanical joining devices are often referred to as "connecting links".

C.8.2.2 Materials

All lifting components in chain slings ~~shall~~should be of grade 8.

Other grades of similar or better quality may be used if they satisfy requirements of a recognized standard applicable for lifting equipment and with documented Charpy values 42J at -20 °C (27J at -20°C in fusion line).

Formatert: Mellomrom Før: 6 pkt,
Etter: 6 pkt, Tabulatorstopp: 1,5 cm,
Left

Formatert: Engelsk (USA)

Formatert: Engelsk (USA)

Formatert: Innrykk: Venstre: 0,63 cm

C.8.2.3 Marking

The marking tag and its means of attachment to the sling assembly required by EN 818-4, Clause 7, shall be made of corrosion resistant material. The total weight of the tag and its means of attachment to the sling assembly should have a mass of less than 70 g.

C.9 Fibre slings (Group R2)

C.9.1 General requirements

The requirements given in the following references apply:

EN 1492-1 Textile slings - Safety - Part 1: Flat woven webbing slings, made of man-made fibres, for general purpose use
EN 1492-2 Textile slings - Safety - Part 2: Roundslings, made of man-made fibres, for general purpose use
EN 1492-4 Textile slings - Safety - Part 4: Lifting slings for general service made from natural and man-made fibre ropes

C.9.2 Complementary requirements fibre slings

C.9.2.1 Design

Lifting slings made from fibre ropes shall have eyes with thimbles.
Mechanical joining devices of hinged type shall not be used in fibre sling assemblies.

NOTE Mechanical joining devices are often referred to as "connecting links".

C.9.2.2 Manufacturer's certificate

No complementary requirements.

C.9.2.3 Information for use and maintenance

For the purpose of complying with this NORSOK standard, the information described in EN 1492-1, Annex D, shall be provided in the manufacturer's instructions for flat woven webbing slings.

For the purpose of complying with this NORSOK standard, the information described in EN 1492-2, Annex C, shall be provided in the manufacturer's instructions for roundslings.

For the purpose of complying with this NORSOK standard, the information described in EN 1492-4, Annex B and Annex C, shall be provided in the manufacturer's instructions for flat fibre rope slings.

The minimum contact diameter for connection to shackles, links or hooks and when the sling is used in choked hitch or basket hitch shall be provided for all types of fibre slings.

For flat woven webbing slings, both minimum and maximum diameter to be inserted in the eyes shall be stated.

C.9.2.4 Marking

The minimum contact diameter stated in the user manual shall also be marked on the slings. For flat woven webbing slings, the maximum diameter of objects to be inserted in the eyes shall also be marked on the sling.

C.9.2.5 Material

Fibre slings should as a general rule be made from polyester. However, if fibres slings are intended to be used in alkaline environment, slings made from polypropylene should be preferred.

C.10 Steel wire rope slings (Group R3)

C.10.1 General requirements

The requirements given in the following references apply:

Steel wire ropes for slings:

See group R9 – Lifting components

Single-leg and multi-leg slings:

EN 13414-1 Steel wire rope slings - Safety - Part 1: Slings for general lifting service

EN 13414-2 Steel wire rope slings - Safety - Part 2: Specification for information for use and maintenance to be provided by the manufacturer

EN 13414-3 Steel wire rope slings - Safety - Part 3: Grommets and cable-laid slings.

Termination of steel wire ropes;

EN 13411-1 Terminations for steel wire ropes - Safety - Part 1: Thimbles for steel wire rope slings

EN 13411-3 Terminations for steel wire ropes - Safety - Part 3: Ferrules and ferrule-securing

Components for upper and lower terminals of steel wire rope slings:

See group R9 – Lifting components

C.10.2 Complementary requirements for steel wire rope slings

C.10.2.1 Design

Ferrule terminations shall be tapered in the wire end.

Mechanical joining devices of hinged type shall not be used in steel wire rope sling assemblies.

NOTE Mechanical joining devices are often referred to as "connecting links".

Wire rope grips shall not be used as terminations for steel wire rope slings.

Single-leg and two-leg slings used as forerunners/pennants on offshore cranes when lifting to and from supply vessels (sealift offshore) are not covered by this group (R3). Forerunners/pennants shall be group R7.

The safety factor (SF) for casing slings shall not be less than 6,0.

For casing sling the following wire type should be used:

Ø 20 mm 6 x 36 + 1FC length 8 m – 300 mm soft eyes.

Formatert: Ikke Hevet / Senket

C.10.2.2 Materials

All components for upper and lower terminal fittings (e.g. links, hooks) on steel wire rope slings ~~shall~~ should be of grade 8.

Other grades of similar or better quality may be used if they satisfy requirements of a recognized standard applicable for lifting equipment and with documented Charpy values 42J at -20 °C (27J at -20°C in fusion line).

Formatert: Engelsk (USA)

Formatert: Innrykk: Hengende: 0,25 cm

C.10.2.3 Marking

The marking tag and its means of attachment to the sling assembly required by EN 13414-1, clause 7, shall be made of corrosion resistant material. The total weight of the tag and its means of attachment to the sling assembly should have a mass of less than 70 g.

The ferrules in one end of the steel wire ropes forming part of a sling assembly shall be legibly and indelibly marked with the sling manufacturer's name, symbol or mark and the traceability code identifying the sling assembly with the certificate.

When marking is on a load-bearing ferrule or the master link, care must be taken to ensure that the mechanical properties of the ferrule or link are not impaired.

C.11 Loose lifting components (Group R4)

C.11.1 Shackles

C.11.1.1 General requirements

The minimum requirements given in the following ~~references~~reference apply:

EN 13889 Forged steel shackles for general lifting purposes - Dee shackles and bow shackles - Grade 6 – Safety

~~RR-C-271 U.S. Federal Specification~~

Alternatively the following reference may be used:

RR-C-271 U.S. Federal Specification

NOTE For offboard lifting of objects offshore, the requirements of F.3 and F.7.2.4.4. apply in addition. For launching and recovery appliances for lifesaving equipment, the requirements of A.1.8.3.3 apply in addition.

Formatert: Skrift: Ikke Fet

C.11.1.2 Complementary requirements for shackles

C.11.1.2.1 Design

Shackles shall be a type with double locking, e.g. nut plus split pin.

C.11.2 Eye bolts/nuts

C.11.2.1 General requirements

The requirements given in the following references apply:

EN 1677-1 Components for slings – Safety – Part 1: Forged steel components, Grade 8.

C.11.2.2 Complementary requirements for eye bolts/nuts

C.11.2.2.1 Design

The working load limit (WLL) for eye bolts and nuts shall apply in the most unfavourable direction.

The breaking load and proof load stated in the references listed in general requirements shall be tested with the test load acting both in the direction of the bolt/nut axis and in the most unfavourable direction transverse to the bolt axis.

C.11.2.2.2 Information for use and maintenance

For eye nuts, information regarding the necessary grade of mating bolt material shall be stated.

Measures for tightening the eye bolt or eye nut shall be stated.

Measures to prevent unscrewing the eye bolt or eye nut shall be stated.

C.11.2.2.3 Marking

The eye bolt/nut shall be marked with WLL for the load acting in the most unfavourable direction.

C.11.3 Clamps

C.11.3.1 General requirements

The requirements given in the following references apply:

EN 13155 Cranes – Safety – Non-fixed load lifting attachments

C.11.3.2 Complementary requirements for clamps

C.11.3.2.1 Design

Clamps intended to be used as suspensions on beams shall be designed in accordance with the additional requirements in Annex H.

C.11.3.2.2 Materials

Materials shall be selected with steel quality and maximum thickness for resistance to brittle fracture for lowest working temperature -20 °C in accordance with EN 13155, Table A.3.

For clamps intended to be used at lower operating temperatures than -20 °C, materials shall be selected in accordance with C.6.

C.11.3.2.3 Fabrication

The fabrication requirements in C.6 apply.

C.11.4 Lifting forks

C.11.4.1 General requirements

The requirements given in the following references apply:

EN 13155 Cranes – Safety – Non-fixed load lifting attachments

C.11.4.2 Complementary requirements for lifting forks

C.11.4.2.1 Materials

Materials shall be selected with steel quality and maximum thickness for resistance to brittle fracture for lowest working temperature -20 °C in accordance with EN 13155, Table A.3.

For lifting forks intended to be used at lower operating temperatures than -20 °C, materials shall be selected in accordance with C.6.

C.11.4.2.2 Fabrication

The fabrication requirements in C.6 apply.

C.12 Spreaders and special design (Group R5)

C.12.1 Spreader beams, lifting beams and lifting frames

C.12.1.1 General requirements

The requirements given in the following references apply:

EN 13155 Cranes – Safety – Non-fixed load lifting attachments

C.12.1.2 Complementary requirements for lifting beams, spreader beams and lifting frames

C.12.1.2.1 Materials

Materials shall be selected with steel quality and maximum thickness for resistance to brittle fracture for lowest working temperature -20 °C in accordance with EN ~~43455, Table A.3~~[13001-3-1](#).

For equipment intended to be used at lower operating temperatures than -20 °C, materials shall be selected in accordance with C.6.

C.12.1.2.2 Fabrication

The fabrication requirements in C.6 apply.

C.12.1.2.3 Information for use and maintenance

Unless the equipment complies with the additional requirements of Annex F, a statement should be given in the instructions to inform that the equipment is only intended for onboard lifting.

C.12.2 Pad eye flanges

C.12.2.1 General requirements

Pad eye flanges shall be designed in accordance with Annex F.

C.12.2.2 Complementary requirements for pad eye flanges

C.12.2.2.1 Design

The working load limit (WLL) for pad eye flanges shall be specified in steps corresponding to standardised shackle dimensions, see group R.4.

Pad eye dimensions recommended in Annex J may be used. Pad eye pin holes shall have a diameter for which a pin of standard shackle with corresponding WLL will fit into. The pad eye thickness shall fit into the opening of a standard shackle with corresponding WLL.

The proof of competence for structural strength of pad eye flanges shall be performed in accordance with Annex F, taking into account the dynamic factor as described for onboard lifts.

A minimum of four bolts shall be used for connection of the pad eye flange to the load.

C.12.2.2.2 Materials

Materials shall be selected with steel quality and maximum thickness for resistance to brittle fracture for lowest working temperature -20 °C in accordance with EN 13155, Table A.3.

For equipment intended to be used at lower operating temperatures than -20 °C, materials shall be selected in accordance with C.6.

For plates or flanges transferring forces in the thickness direction, materials with documented through thickness properties shall be used.

Bolts shall have grade 8.8.

C.12.2.2.3 Fabrication

The fabrication requirements in C.6 apply.

Pad eye shall be welded to the flange by use of full penetration welds. Fillet weld shall not be used.

A static load test shall be performed on each unit with a test load equal to 2·WLL. The test load shall be applied in all directions for which the pad eye flanges are intended to be oriented during normal use.

C.12.2.2.4 Information for use and maintenance

Instructions should be given to prevent rotation of the flange and load when lifting with single leg wire rope sling.

Instructions should be given regarding necessary pretension of the bolts needed to ensure metallic contact between flange and load during lifting, and to ensure evenly distribution of load in the bolts.

C.12.3 Magnet lifter

C.12.3.1 Introduction

Magnet lifters are normally designed as lifting beams. Reference is made to section C.5.1 for requirements for the lifting beam. The following subsections describe the requirements for magnet attachments used in magnet lifters.

C.12.3.2 General requirements

The requirements given in the following references apply:

EN 13155 Cranes – Safety – Non-fixed load lifting attachments
DNV-OS-E101, Drilling Plant

In case of conflicting requirements given in the above references, the most stringent requirement applies.

C.12.3.3 Complementary requirements for magnet lifters

C.12.3.3.1 Design

Safety related parts of control systems for operation of magnets, e.g. indicators, warning devices or devices for two-action control, shall fulfil a required performance level C in accordance with ISO 13849-1.

For the purpose of complying with this NORSOK standard, any exceptions for "no-go areas" given in EN 13155 are not allowed.

C.12.3.3.2 Information for use and maintenance

The geometrical shape and range of sizes intended to be lifted with the magnets shall be described in the user instructions. In addition a clear warning shall be stated not to lift other shapes or sizes than those described in the instructions.

C.12.4 Vacuum lifter

C.12.4.1 Introduction

Vacuum lifters are normally designed as lifting beams. Reference is made to C.12.1 for requirements for the lifting beam. The following subsections describe the requirements for vacuum attachments in vacuum lifters.

C.12.4.2 General requirements

The requirements given in the following references apply:

C.12.4.3 Complementary requirements for vacuum lifters

Vacuum attachments shall be dimensioned to hold at least a load corresponding to 3 times the working load limit for each attachment at the end of the working range and the beginning of the danger range respectively at all intended angles of tilt.

Non self priming vacuum lifters shall have an indicator that confirms sufficient vacuum for safe lifting.

Safety related parts of control systems for operation of vacuum attachments, e.g. indicators, warning devices or devices for two-action control, shall fulfil a required performance level C in accordance with ISO 13849-1.

For the purpose of complying with this NORSOK standard, any exceptions for “no-go areas” given in EN 13155 are not allowed.

C.12.5 Mechanical gripper for pipe handling

C.12.5.1 Introduction

Mechanical grippers are normally part of lifting beams or a lifting appliance. Reference is made to C.12.1 for requirements for the lifting beam. The following subclauses describe the requirements for mechanical grippers used in lifting beams or as permanent load holding devices on lifting appliances.

C.12.5.2 General requirements

The requirements given in the following references apply:

DNV-OS-E101 Drilling Plant

C.12.5.3 Complementary requirements for mechanical grippers for pipe handling

C.12.5.3.1 Design

Safety related parts of control systems for operation of mechanical grippers, e.g. indicators, warning devices or devices for two-action control, shall fulfil a required performance level C in accordance with ISO 13849-1.

Grippers may be equipped with means for emergency operation in case of power failure. Such means shall require the use of external tools or power source (e.g. hydraulic hand pump) to open the grippers.

C.12.5.3.2 Information for use and maintenance

The geometrical shape and range of sizes intended to be lifted with the mechanical gripper shall be described in the user instructions. In addition a clear warning shall be stated not to lift other shapes or sizes than those described in the instructions.

In case grippers are equipped with means for emergency operation, clear instructions must be given to off-load the grippers and secure the load from falling or uncontrolled movements prior to opening the grippers.

C.13 Load carriers (Group R6)

C.13.1. Baskets for onshore plants and onboard lifting on offshore installations

C.13.1.1 General requirements

Baskets shall be designed in accordance with Annex F of this NORSOK Standard.

For baskets made from aluminium, proof of competence shall be performed in accordance with the requirements given in the following references:

EN 1999-1-1 Eurocode 9: Design of aluminium structures - Part 1-1: General structural rules

C.13.1.2 Complementary requirements for baskets

C.13.1.2.1 Design

The proof of competence for baskets shall be performed in accordance with Annex F, as described for group F.5, taking into account

- the weight W specified in Annex F is the maximum gross mass (tonnes), corresponding to the sum of
 - tara weight (tonnes) of the basket,
 - pay load (tonnes) of the basket.
- the dynamic amplification factor (DAF) shall be as specified for onboard lifting in Annex F.

For the purpose of calculating the structural strength of the basket floor, an evenly distributed load may be assumed.

The floor in the basket shall be drained.

Any door in the side of the basket shall have a locking mechanism to prevent inadvertent opening. The door with hinges and locking mechanism shall be designed to withstand a load corresponding to 25 % of the max gross mass without permanent deformation when applied in the most severe position. Hinges shall have grease nipples.

Baskets shall have pockets for transport with fork lift trucks.

For aluminium baskets, the resistances and resistance factors for materials, members and connecting devices shall be taken from EN 1999-1-1.

C.13.1.2.2 Materials

Materials for steel structures shall be selected in accordance with C.6.

Materials for aluminium structures shall be selected in accordance with EN 1999-1-1.

C.13.1.2.3 Fabrication

The fabrication requirements in clause C.6 apply.

Each basket shall be tested with a static load corresponding to twice the max gross mass, suspended from the dedicated lifting set.

C.13.1.2.4 Information for use and maintenance

Information for use shall be given in compliance with relevant parts of EN 12644-1, as applicable. The instructions must clearly state that the basket is not intended for lifting persons.

A statement should be given in the instructions to inform that the basket is only intended for onboard lifting.

C.13.1.2.5 Marking

Baskets shall be marked with

- manufacturer's name and address,
- type designation,
- max gross mass (tonnes),
- payload (tonnes),
- year of manufacture,
- identification for traceability to manufacturer's certificate,
- warning against offboard lifting ,
- warning against lifting persons.

Marking signs shall be permanently attached to the basket with adequate means to prevent the sign from loosening.

Formatert: Punktmerket + Nivå: 1 + Justert ved: 0,25 cm + Innrykk ved: 0,75 cm

Formatert: Innrykk: Første linje: 0 cm, Punktmerket + Nivå: 1 + Justert ved: 0,25 cm + Innrykk ved: 0,75 cm

Formatert: Punktmerket + Nivå: 1 + Justert ved: 0,25 cm + Innrykk ved: 0,75 cm

Formatert: Punktmerket + Nivå: 1 + Justert ved: 0,25 cm + Innrykk ved: 0,75 cm

C.13.2 Intermediate bulk containers and big bags

C.13.2.1 General requirements

The requirements given in the following references apply:
ISO 21898 Packaging – Flexible intermediate bulk containers (FIBCs) for non-dangerous goods
IMDG Code
ISO 16467 Packaging – Transport packaging for dangerous goods – Test methods for IBCs

The requirements for certification and marking according to ISO 21989 shall also be complied with for IBCs used for transportation of dangerous goods.

All IBCs for transport of dangerous goods must be certified according to Chapter 6.5 in the IMDG Code.

C.13.2.2 Marking

Marking signs shall be permanently attached to the equipment with adequate means to prevent the sign from loosening.

C.14 Forerunner/pennant for offshore crane (Group R7)

C.14.1 Introduction

Forerunners/pennants for offshore cranes are intended both for onboard and offboard lifting.

C.14.2 General requirements

The general requirements given for group R3 also apply for Group R7.

C.14.3 Complementary requirements for forerunners/pennants

C.14.3.1 Design

Steel wire ropes used in forerunners/pennants shall be of ~~construction 6 x 36~~ construction suitable for this application and be compatible with thimbles, hooks, links and other components that are used in the forerunner/pennant.

Spliced eyes shall not be used for termination of steel wire ropes used in forerunners/pennants.

Ferrule-secured eyes shall be fitted with thimbles according to EN 13411-3.
Ferrule terminations shall be tapered in the wire end.

Mechanical joining devices of hinged type shall not be used in steel wire rope sling assemblies.

Hooks with latch according to EN 1677-2 shall not be used.

Hooks shall be of self-locking type in accordance with EN 1677-3. The locking mechanism shall be protected against inadvertent opening due to entanglement with any obstruction during lifting.

Hooks shall have a swivelling element, or swivel of grade 8 according to EN 1677-1 shall be permanently fitted between the hook and the steel wire rope eye. Swivels or swivelling elements of hooks shall incorporate a thrust bearing.

The top link to be attached to the crane hook should have minimum internal dimensions 270 mm x 140 mm.

The components of the forerunners/pennants shall be selected with documented breaking force (~~BF, BF~~) (in kN, kiloNewton) as follows:

- top link, BF = 5,0 x WLL x g
- hook, BF = 5,0 x WLL x g
- wire, BF = 6,0 x WLL x g for WLL up to and including 10 T.
– BF = 5,0 x WLL x g for WLL above 15 T.

Where g is equal to 9,81 m/s²

← **Formatert:** Punktmerket + Nivå: 1 +
Justert ved: 0,25 cm + Innrykk ved:
0,75 cm

For WLL between 10 T and 15 T linear interpolation to be used for calculating the BF.

Forerunners/pennants should have a working load limit of at least 8 T. The crane owner may specify a lower working load limit, but not less than 50 % of the cranes rated capacity.

NOTE A working load limit of 8T is typical for a crane with rated capacity 15 T.

C.14.3.2 Materials

Materials for components for upper and lower terminals of forerunners/pennants shall be selected in accordance with the requirements given in the references in general requirements and the following additional requirements:

- top link shall meet the material requirements given in DNV Standard for Certification No. 2.7-1. Containers, clause 8.4.
- hooks shall be in accordance with DNV Standard for Certification No. 2.22 Lifting Appliances.

Formatert: Punktmerket + Nivå: 1 +
Justert ved: 0,25 cm + Innrykk ved:
0,75 cm

C.14.3.3 Information for use and maintenance

The user manual must clearly state that forerunners shall be subjected to thorough examination by a qualified user every 14th day. The method of inspection, focus areas and discard criteria shall be described.

C.14.3.4 Marking

The complementary requirements listed in C.10.2.4 also apply to forerunners/pennants.

C.15 Elastic forerunner/pennant for rescue (MOB) boats (Group R8)

C.15.1 General requirements

The ~~requirements~~ requirements given in the following references apply:

- EN 1492-4 Textile slings - Safety - Part 4: Lifting slings for general service made from natural and man-made fibre ropes
- EN 1677-4 Components for slings – Safety – Part 4: Links, Grade 8

Formatert: Punktmerket + Nivå: 1 +
Justert ved: 0,25 cm + Innrykk ved:
0,75 cm

C.15.2 Complementary requirements for elastic forerunners/pennants for rescue boats

C.15.2.1 Design

The requirements in A.7.4 and A.7.5 apply to elastic forerunners/pennants for rescue boats. Such elastic forerunners/pennants are intended for both onboard and offboard lifting.

NOTE A calculation example is shown in Annex I.

C.15.2.2 Marking

The marking tag and its means of attachment to the sling assembly required by A.7.4.6 shall be made of corrosion resistant material. The total weight of the tag and its means of attachment to the sling assembly should have a mass of less than 70 g.

C.16 Lifting components (Group R9)

C.16.1 Chains

C.16.1.1 General requirements

The requirements given in the following references apply:

- EN 818-1 Short link chain for lifting purposes - Safety - Part 1: General conditions of acceptance.

Formatert: Punktmerket + Nivå: 1 +
Justert ved: 0,25 cm + Innrykk ved:
0,75 cm

NORSOK standard

- EN 818-2 Short link chain for lifting purposes – Safety – Part 2: Medium tolerance chain for chain slings – Grade 8.

C.16.2 Steel wire ropes

C.16.2.1 General requirements

The requirements given in the following references apply:

- EN 12385-1 Steel wire ropes - Safety - Part 1: General requirements.
- EN 12385-2 Steel wire ropes - Safety - Part 2: Definitions, designation and classification
- EN 12385-4 Steel wire ropes - Safety - Part 4: Stranded ropes for general lifting applications

← **Formatert:** Punktmerket + Nivå: 1 +
Justert ved: 0,25 cm + Innrykk ved:
0,75 cm

C.16.2.2 Complementary requirements for steel wire ropes

C.16.2.2.1 Marking

The steel wire rope when supplied for installation on a winch drum shall be permanently marked at both ends.

C.16.3 Hooks for slings

C.16.3.1 General requirements

The requirements given in the following references apply:

- EN 1677-1 Components for slings – Safety – Part 1: Forged steel components, Grade 8.
- EN 1677-3 Components for slings – Safety – Part 3: Forged steel self-locking hooks – Grade 8

← **Formatert:** Punktmerket + Nivå: 1 +
Justert ved: 0,25 cm + Innrykk ved:
0,75 cm

C.16.4 Links and joining devices

C.16.4.1 General requirements

The requirements given in the following references apply:

- EN 1677-1 Components for slings – Safety – Part 1: Forged steel components, Grade 8.
- EN 1677-4 Components for slings – Safety – Part 4: Links, Grade 8

← **Formatert:** Punktmerket + Nivå: 1 +
Justert ved: 0,25 cm + Innrykk ved:
0,75 cm

C.16.4.2 Complementary requirements for links and joining devices

Mechanical joining devices of the hinged type shall not be used.

C.16.5 Open/close spelter sockets

C.16.5.1 General requirements

The requirements given in the following references apply:

- EN 13411-4, Terminations for steel wire ropes – Safety - Part 4: Metal and resin socketing

← **Formatert:** Punktmerket + Nivå: 1 +
Justert ved: 0,25 cm + Innrykk ved:
0,75 cm

C.16.5.2 Complementary requirements for open/close spelter sockets

C.16.5.2.1 Design

The socket shall have a minimum breaking load greater than the minimum breaking load of the steel wire rope.

C.16.5.2.2 Manufacturer's certificate

The socketing manufacturer shall issue a certificate, based on the original rope manufacturer's and socket manufacturer's certificates, containing the following details:

- socketing manufacturer's name and address;
- reference to unique identification mark on the socketed medium, that gives traceability to the certificate;
- statement that the socketing process is performed in accordance with EN 13411-4;
- rope details from original rope manufacturer's certificate;
- reference to the original rope manufacturer's name and certificate no.;
- reference to the original socket manufacturer's name and certificate no.

← **Formatert:** Punktmerket + Nivå: 1 +
Justert ved: 0,25 cm + Innrykk ved:
0,75 cm

The socket shall be accompanied by a certificate issued by the socket manufacturer, containing the following details:

- socket manufacturer's name and address;
- model or type designation of socket;
- serial no. or other unique identification of the socket;
- minimum breaking load of socket.

← **Formatert:** Punktmerket + Nivå: 1 +
Justert ved: 0,25 cm + Innrykk ved:
0,75 cm

C.16.5.2.3 Marking on socket and socketed medium

The socket shall be marked with the following details:

- socket manufacturer's unique identification;
- model or type designation of socket;
- serial no. or other unique identification of the socket;
- minimum breaking load of socket.

← **Formatert:** Punktmerket + Nivå: 1 +
Justert ved: 0,25 cm + Innrykk ved:
0,75 cm

In addition to the marking required by EN 13411-4, Clause 7, the socketed medium shall be marked with a unique identification for traceability to the certificate issued by the socketing manufacturer. The marking shall be performed in accordance with EN 13411-4, Clause 7.

C.16.5.2.4 Information for use and maintenance

The socket and socket resin system shall be accompanied with instructions issued by the socket manufacturer and socket resin system manufacturer, as applicable, covering all necessary instructions as foreseen in EN 13411-4.

C.16.5.2.5 Fabrication/manufacturing processes

The socketer's competence shall be documented.

C.16.6 Wedge sockets

C.16.6.1 General requirements

The requirements given in the following references apply:

EN 13411-6, Terminations for steel wire ropes – Safety - Part 6: Asymmetric wedge socket
EN 13411-7, Terminations for steel wire ropes – Safety - Part 7: Symmetric wedge socket

C.16.6.2 Manufacturer's certificate

In addition to the information required by EN 13411-6 and -7, the manufacturer's certificate shall contain the following ~~in formation~~ information:

- Minimum breaking load
- Manufacturing proof test load

← **Formatert:** Punktmerket + Nivå: 1 +
Justert ved: 0,25 cm + Innrykk ved:
0,75 cm

C.16.7 Swivels

C.16.7.1 General requirements

The requirements given in the following references apply:

- RR-C-271, U.S. Federal Specification
- EN 1677-1, Components for slings – Safety – Part 1: Forged steel components, Grade 8.

← **Formatert:** Punktmerket + Nivå: 1 +
Justert ved: 0,25 cm + Innrykk ved:
0,75 cm

C.16.7.2 Complementary requirements for swivels

Threaded load bearing parts of the swivel shall be protected against unscrewing.

C.16.8 Turn buckles

C.16.8.1 General requirements

The requirements given in the following references apply:

- EN 1677-1 Components for slings – Safety – Part 1: Forged steel components, Grade 8.
- FF-T- 791.B U.S. Federal Specification: Turnbuckle

← **Formatert:** Punktmerket + Nivå: 1 +
Justert ved: 0,25 cm + Innrykk ved:
0,75 cm

C.16.8.2 Complementary requirements for turn buckles

C.16.8.2.1 Design

The turnbuckle shall be equipped with means to lock adjustable rods from unintended disengagement.

~~C.16.8.2.2 Marking~~

~~The rods shall be marked with maximum adjustable length to ensure sufficient length of engaged threaded parts~~

C.16.9 Pulley blocks and hook blocks, single and multiple sheaves

C.16.9.1 General requirements

The requirements given in the following references apply:

Manually operated pulley blocks and deflection pulleys:

- EN 13157 Cranes – Safety – Hand power lifting equipment

Hook blocks, pulley blocks deflection pulleys and sheaves/sheave houses to be used as integral parts of powered lifting appliances:

- EN 13135-2 Cranes – Equipment – Part 2: Non-electrotechnical equipment
- EN 13001-1 Cranes – General design – Part 1: General principles and requirements
- EN 13001-2 Cranes – General design – Part 2: Load actions
- EN 13001-3-1 Cranes – General design – Part 3-1: Limit states and proof of competence of steel structures
- ~~CEN/TS~~ 13001-3-2 Cranes – General design – Part 3-2: Limit states and proof of competence of wire ropes in reeving systems
- CEN/TS 13001-3-5 Cranes - General design – Part 3-5: Limit states and proof of competence of forged hooks

← **Formatert:** Punktmerket + Nivå: 1 +
Justert ved: 0,25 cm + Innrykk ved:
0,75 cm

← **Formatert:** Punktmerket + Nivå: 1 +
Justert ved: 0,25 cm + Innrykk ved:
0,75 cm

C.16.9.2 Complementary requirements for pulley blocks and hook blocks, single and multiple sheaves

C.16.9.2.1 Design

Hook blocks, pulley blocks, deflection pulleys and sheaves/sheave houses to be used as integral parts of powered lifting appliances shall be designed for the dynamic load effects specified by the manufacturer of the powered lifting appliance.

For single sheave blocks, the rated capacity shall be understood as half the maximum head pull. For blocks without becket this equals maximum line pull.

For multi sheave blocks, the rated capacity shall be understood as maximum head pull.

Pulley blocks that are separable for the purpose of easy assembly shall be designed to prevent unintentional separation/opening that can lead to falling objects (both during assembly and operation) or derailing of wire rope. Separable parts shall be secured in accordance with 5.4.9.

C.16.9.2.2 Information for use and maintenance

Rated capacity shall be described in detail and include illustrations to explain line pull and head pull.

Maintenance instructions must give clear and unambiguous details on how to measure groove wear on sheaves and bearing wear. Reference marks on sheaves for wear measurement must be illustrated. Required intervals for wear measurements and discard criteria shall be given.

C.16.9.2.3 Marking

Sheaves shall be permanently marked with reference marks, either stamped or embedded on the sheave circumference, for measuring groove wear (depth).

The rated capacity to be marked on both manually operated pulleys and pulley blocks/hook blocks.

C.16.10 Ferrule terminations

C.16.10.1 General requirements

The requirements given in the following references apply:

- EN 13411 – 3, Termination for steel wire ropes Safety - Part 3: Ferrules and ferrule-securing.

C.16.10.2 Complementary requirements for ferrule terminations

Ferrule terminations shall be tapered in the wire end.

← **Formatert:** Punktmerket + Nivå: 1 +
Justert ved: 0,25 cm + Innrykk ved:
0,75 cm

C.16.11 Wire rope grips

C.16.11.1 General requirements

None

C.16.11.2 Complementary requirements for wire rope grips

C.16.11.2.1 Design

Wire rope grips shall be of a type with two gripping surfaces. U-bolt clamps shall not be used on lifting equipment.

Wire rope grips should be designed to prevent incorrect assembly.

C.16.11.2.2 Instructions for use and maintenance

The user manual shall state the reduction of steel wire rope braking load resulting from the use of wire rope grips.

The user manual shall give assembly instructions with respect to

- correct number of grips and distance between grips,
- required bolting torque and preparation of bolts (e.g. lubrication requirements),
- type/size of grips ~~v.s.~~ different rope constructions.

← **Formatert:** Punktmerket + Nivå: 1 +
Justert ved: 0,25 cm + Innrykk ved:
0,75 cm

C.17 Special designed lifting accessories in drilling area SDLA (Group R10)

C.17.1 Introduction

Special designed lifting accessories in the drilling area, hereafter referred to as SDLA, comprises, but is not limited to, the following equipment: [listed in Table D.8 Group D.7.](#)

- elevators;
- elevator links (“bails”);
- handling tools;
- running tools;
- hanger tools;
- lifting nipples;
- lifting caps;
- lifting subs;

Formatert: Ingen punktmerking eller nummerering

Formatert: Engelsk (Storbritannia)

NOTE As a reminder, reference is made to C.1 regarding application of this NORSOK standard in its entirety.

Reference is also given to Annex D clause D.1 for interpretation of the term “Lifting accessories” in the drilling area.

C.17.2 General requirements

The requirements given in the following references apply:

- ISO 13535 / [API Spec. 8C](#) Petroleum and natural gas industries – Drilling and production equipment – Hoisting equipment
- ISO 10423 / [API Spec. 6A](#) Petroleum and natural gas industries – Drilling and production equipment – Wellhead and christmas tree equipment
- ISO 11961 / [API Spec. 5D](#) Petroleum and natural gas industries – Steel drill pipe
- ISO 13628-1 Petroleum and natural gas industries – Design and operation of subsea production systems – Part 1: General requirements and recommendations
- ISO 13628-4 Petroleum and natural gas industries – Design and operation of subsea production systems – Part 4: Subsea wellhead and tree equipment
- ISO 13628-7 / [API RP. 17G](#) Petroleum and natural gas industries – Design and operation of subsea production systems – Part 7: Completion/workover riser systems

Formatert: Punktmerket + Nivå: 1 + Justert ved: 0,25 cm + Innrykk ved: 0,75 cm

C.17.3 Complementary requirements

C.17.3.1 Design

SDLAs shall comply with the requirements given in the references in general requirements as applicable.

Although not mentioned in the scope of ISO 13535 / [API Spec. 8C](#), the requirements given in that standard apply to all types of SDLAs, unless stricter requirements are given in the other references in general requirements.

All types of SDLAs shall be designed for one or more specified working load limit(s) (WLL).

Formatert

NOTE The term “[Working Load Limit](#)” in [Safe working load](#)” used for this [NORSOK standard sub group](#) is equivalent with the term “[Safe working load](#)” in [ISO 13535-Working Load Limit](#)” used for other sub groups of this annex.

Formatert: Innrykk: Venstre: 0 cm, Første linje: 0 cm

If it is possible to use the SDLA for picking up tubulars or other loads from a horizontal position, the workig load limit (WLL) for the SDLA shall be specified for the most unfavourable direction. Alternatively, different WLLs may be specified for horizontal and vertical positions.

Formatert: Skrift: 8 pkt

For the purpose of calculating the WLL according to this NORSOK standard, the design load according to ISO 13535 / [API Spec. 8C](#) shall be divided by a dynamic coefficient of 1,33.

Formatert: Skrift: Fet

Formatert: Mellomrom Før: 6 pkt, Etter: 6 pkt, Tabulatorstopp: 1,5 cm, Left

C.17.3.2 Elevators

C.17.3.2.1. General

The working load limit for elevators shall be stated both for lifting the load in vertical and horizontal position.

The working load limit for lifting the load in horizontal position shall be taken as the maximum weight of a single tubular for which the elevator is intended to handle (maximum diameter).

Elevators shall be designed for lifting the load horizontally with the most unfavorable orientation of the elevator, i.e. with the opening sector facing downwards.

All structural members of an elevator, including suspension points, doors, hinges and locking elements, shall be designed to withstand the design load(s) in accordance with ISO 13535 / [API Spec. 8C](#).

Means shall be provided to operate the elevator without the need to be in contact with pinch points.

All pinned and bolted connections (e.g. in hinges and suspension points), shall be secured against unintended loosening.

Elevator suspension points shall be designed with means to prevent the elevator links to disconnect from the suspension points. These means shall not be loaded by the elevator links when the load is moved from vertical to horizontal position, unless they are designed for the horizontal WLL in accordance with ISO 13535 / [API Spec. 8C](#).

Elevators shall be designed to facilitate verification (e.g. by visual observation) that the size and profile of the load is compatible with the corresponding inside size and shape of the elevator.

Elevators with inserts shall be designed in a way, to easily verify that the correct inserts for the actual pipe dimension are used. Elevators with inserts shall have means to prevent inserts from falling out of the elevator.

C.17.3.2.2 Locking, securing and indication

The locking mechanisms on elevators shall in addition to the locking element(s) have a securing device and an indication device.

The locking mechanism, including locking element(s), securing device and indication device, shall be protected against external influence (e.g. impacts) that may affect their integrity.

The locking element(s) shall be designed according to a "self closing" principle, i.e. when the load acts in the opening direction(s), the forces transferred to the locking element(s) shall act in the closing direction of the locking element(s).

The securing device shall be a mechanical restraint device that prevents the locking element(s) to be opened unintentionally, e.g. by external impacts. It shall not be possible to unlock the locking element(s) when the securing device is engaged in the "secured" position. It shall not be possible to disengage the securing device when the elevator is loaded.

The indication device shall positively indicate for visual observation on the elevator when the elevator is locked and secured. The indication device shall indicate "locked and secured" by a positive mechanical action between the securing device and the indication device. The indication device shall be mechanically restricted from indicating "locked and secured" when the securing device is not in the "secured" position. The securing device and the indication device may be combined. The indication device shall not depend on any manual intervention by the operator. Whenever the elevator is unlocked or unsecured the indication device shall clearly and unambiguously indicate that the elevator is unlocked and unsecured.

C.17.3.2.3 Manually operated elevators

For manually operated elevators the locking element(s) shall be engaged by a positive mechanical action between the closing movement of the elevator door(s) and the movement of the locking element(s) to the "locked" position, i.e. engagement of the locking element(s) shall not depend on springs or gravity. It shall not be possible to close the elevator completely if the locking element(s) is (are) in the "locked" position prior to closing. An attempt to close the elevator when the locking element(s) is (are) in the "locked" position shall

result in an aperture of at least 20 mm between the adjacent surfaces of the closing parts of the elevator, in order to give a clear visual observation that the elevator is not properly closed.

The securing device on manually operated elevators shall engage automatically to the "secured" position when the locking element(s) is_(are) engaged. The securing device shall be prevented by mechanical restriction from engaging in the "secured" position when the locking element(s) is (are) not in the "locked" position.

Release of the load from the elevator shall require at least two separate manual actions by the operator, e.g. one action for disengaging the securing device and one action for opening the locking element(s).

C.17.3.2.4 Powered (remote operated) elevators

Powered (remote operated) elevators shall have a pre-defined sequence for all movements, i.e. opening/closing the door(s), engaging/disengaging the locking element(s) and engaging/disengaging the securing device. The sequence shall not be influenced by the operator.

The control system for powered elevators shall be integrated with the control system for the drilling hoisting machine.

Reliable signals shall be provided to the control system for the hoisting machinery when the elevator is in the closed, locked and secured condition. Hoisting movements shall be prevented until the secured indication signal is given. In the case of power loss in locked and secured position the elevator shall remain locked and secured. Means shall be provided to unsecure and unlock the elevator manually when unloaded, only. The safety related parts of the control system shall fulfill ISO 13849-1 performance level d. ~~Power and control cable/hoses shall be provided with quick couplings for their connection to the drilling hoisting machine.~~ Means shall be provided to prevent incorrect connection. The connections and their arrangement shall prevent ingress of moisture and contaminations that may influence the power and signal transmission when they are disconnected. For hydraulic elevators, means shall be provided to enable pressure relief prior to maintenance operations.

C.17.3.3 Lifting subs, caps, nipples and tools (handling, running and hanger tools used for lifting) according to Group D.7 of Table D.8

These types of SDLAs shall be secured with double barriers to avoid any part of the tool to disconnect (e.g. unscrew) from the load or the lifting appliance.

NOTE For screwed connections, a verified torque in accordance with the ~~manufacturers~~ manufacturer's instructions, may be regarded as the second barrier.

Means shall be provided for the operator to verify that these types of SDLAs with non-threaded connections are correctly connected to the load and the lifting appliance. For SDLAs where the load holding elements interfacing with the profiles of the load are not visible from the outside of the SDLA, indicating devices visible from the outside shall be provided. Indicating devices shall be visible from all sides of the SDLA. The indicating devices shall give a clear and unambiguous indication that the load holding elements are in correct (locked) position and secured. The indicating devices must be designed to prevent indication of "locked and secured" if the SDLA is not locked and secured.

All SDLAs shall be provided means for connection of standardised lifting accessories for safe handling the SDLA without load.

C.17.3.4 Testing

SDLAs shall be proof tested in accordance with Table C.1.

For SDLAs with WLL specified for different directions (e.g. vertical and horizontal), the SDLA shall be proof load tested in each specified direction with a test load corresponding the specified WLL for each direction.

C.17.3.5 Information for use

The working load limit (WLL) of the SDLA must be clearly shown in the user manual. For SDLAs with multiple WLLs, each WLL and its corresponding direction must be explained.

Detailed instruction, including figures/pictures, must be given in the user manual to describe how the SDLA is connected and secured to the lifting appliance and to the load. The interpretation of any indicating devices must be unambiguously described in the user manual.

For SDLAs connected with threads to the load or to the lifting appliance (e.g. Derrick Drilling Machine), the necessary torque to be applied must be specified in the user manual together with any preparation requirements (e.g. lubrication). A clear warning must be provided to inform the user that no lifting is allowed until the specified torque(s) have been applied.

Wear tolerances of load carrying elements for connection to the lifting appliance or to the load must be given in the user manual.

In addition to the user manual, a one-sheet assembly instruction with illustrations and operational limitations shall accompany the SDLA.

The user manual shall clearly state the safe working load (SWL) corresponding to the load rating.

C.17.3.6 Manufacturer's certificate

The manufacturer's statement of compliances required by ~~in~~ ISO 13535 / API Spec. 8C, 11.3 a), shall also state compliance with this NORSOK standard and state the safe working load (SWL) corresponding to the load rating.

Formatert

C.17.3.7 Marking

All SDLAs shall be marked with their WLL. For SDLAs with one -1- WLL, the marking shall indicate the WLL for the most unfavourable direction for which the load is possible to be applied. For SDLAs with more than one WLL for different directions, the WLL for each direction shall be marked with a clear indication for which direction the different WLLs apply.

Formatert: Skrift: Ikke Fet, Engelsk (Storbritannia)

Formatert: Skrift: 10 pkt, Engelsk (USA)

Formatert: Mellomrom Før: 0 pkt, Etter: 0 pkt, Tabulatorstopp: Ikke på 1,5 cm

SDLA solely intended for being lifted by the derrick drilling machine (DDM) may be marked with load rating only, in accordance with ISO 13535/API Spec. 8C.

C.18 Carriers for lifting persons (Group R11)

C 18.1 Suspended work platform (work basket) for use onshore and onboard on offshore installations

C 18.1.1 General requirements

The requirements given in the following references apply:

- EN 14502-1, Cranes – Equipment for lifting persons – Suspended basket
- Annex F of this standard

C.18.1.2 Complementary requirements for suspended work baskets

C.18.1.2.1 Design

The proof of competence for work baskets shall be performed in accordance with Annex F, as described for group F.5, taking into account the following:

- the weight W specified in Annex F is the maximum gross mass (tonnes), corresponding to the sum of tare weight (tonnes) of the basket
- pay load (tonnes) of the basket, taken as at least $\text{payload} = n \cdot (m_p + m_e)$

where

n is the number of persons allowed on the platform and shall not be less than 2

$m_p \geq 0,090$ tonnes is the minimum mass of each person

$m_e \geq 0,040$ tonnes is the minimum mass of tools and other equipment for each person

- the risk coefficient given in Table F.4 shall be increased by multiplying with a factor of 1,5 of 2,0.

Formatert: Punktmerket + Nivå: 1 + Justert ved: 0,25 cm + Innrykk ved: 0,75 cm

Formatert: Punktmerket + Nivå: 1 + Justert ved: 0,25 cm + Innrykk ved: 0,75 cm

Formatert: Punktmerket + Nivå: 1 + Justert ved: 0,25 cm + Innrykk ved: 0,75 cm

The dynamic amplification factor (DAF) shall be as specified for [inboard/onboard](#)/onshore lifting in Annex F.

Work baskets shall have pockets for transport with fork lift trucks.

NOTE Lifting persons with fork lift trucks is not allowed.

Lifting sets shall have a working load limit corresponding to not less than twice the max gross mass of the work basket.

Work baskets shall have two dedicated lifting sets with independent lifting points in the work basket and with independent top links. The lifting sets shall be permanently attached to the work basket with means requiring tools to remove. The top link to be attached to the crane hook should have minimum internal dimensions 270 mm x 140 mm. For lifting appliances with only one suspension rope, one top link is to be attached directly to the crane hook and the other top link shall be attached above any swivelling elements of the hook.

For aluminium work baskets, the resistances and resistance factors for materials, members and connecting devices shall be taken from EN 1999-1-1.

Work baskets shall have a roof in accordance with EN 14502-1.

The anchorage points for personal protective equipment against fall from a height shall be located above the persons in the baskets.

Work baskets shall have anchorage points for evacuation equipment, e.g. descending devices. The number of anchorage points shall be equal to the number of persons allowed in the work basket.

The work basket shall be designed to withstand impact forces corresponding to a horizontal impact against a rigid structure at a horizontal speed of 1 m/s. Permanent deformations are acceptable, but it shall be demonstrated by calculations that no load bearing members will suffer loss of load bearing capacity.

For the purpose of performing the proof of competence for the work basket floor, the payload of the platform shall be distributed according to EN 280, 5.2.3.1, in the most unfavourable way in terms of stresses.

When the work basket is suspended without persons or other loads, there shall be no inclination.

The work basket shall be designed to limit the inclination to maximum 7° from the horizontal when an inclination test load as described in C.18.1.2.3 is placed in the most unfavourable position on the basket
The side protection of work baskets shall be designed to withstand internal manual forces according to EN 280, 5.2.3.4.

Any hinged doors shall be equipped with lubrication points on the hinges.

C.18.1.2.2 Materials

Materials for steel structures shall be selected in accordance with C.6.

Materials for aluminium structures shall be selected in accordance with EN 1999-1-1.

The work basket shall be protected against corrosion if the materials selected are not corrosion resistant.

C 18.1.2.3 Fabrication

The fabrication requirements in C.6 apply.

Each work basket shall be tested with a static load corresponding to a total weight of 2x max gross mass suspended from the dedicated lifting set. Each lifting set shall be tested separately.

An inclination test shall be performed with an inclination test load equal to the pay load. The centre of gravity of the inclination test load shall be not less than 0,5 m above the floor and not further than 0,3 m from the side protection of the work basket. In this loading condition the static inclination of the work basket shall not exceed 7° from the horizontal.

C.18.1.2.4 Information for use and maintenance

For baskets intended to be used on offshore installations, a statement shall be given in the instructions to inform that the basket is not intended for offboard lifting on offshore installations. The instructions must clearly state that the work basket is only intended to be used with lifting appliances designed and manufactured for the purpose of lifting persons.

The instructions must describe how the top links shall be attached to the crane. A statement shall be given to inform that no other lifting accessories (e.g. forerunners) shall be used between the crane hook and the lifting set of the work basket.

C 18.2 Stretcher intended for lifting of personnel using lifting appliances

TO BE DEVELOPED

C 18.3 Personnel transfer carrier

Personnel transfer carriers are intended for both onboard and offboard lifting. Requirements for such carriers are given in Annex A.

C.18.4 Man riding harness

C 18.4.1 General requirements

The requirements given in the following references apply:

- EN 813, Personal fall protection equipment - Sit harnesses

← **Formatert:** Punktmerket + Nivå: 1 +
Justert ved: 0,25 cm + Innrykk ved:
0,75 cm

C 18.4.2 Complementary requirements

Man riding harnesses shall be equipped with shoulder straps and attachment point in front. The attachment point shall be located at a height to avoid contact between the face and means of attachment, and to avoid instability of personnel.

Annex D (Normative) Lifting equipment in drilling area

D.1 General (Group D)

Lifting equipment in the drilling area shall, ~~in addition to fulfil~~ the requirements ~~stated in Clause 1 to Clause 5, also fulfil~~ in DNV-OS-E101, Chapter 1 and Chapter 2 ~~in addition to Clause 1 to Clause 5 in this standard.~~

~~NOTE:~~ For verification requirements, reference is made to Clause 4.14. For principles of safety integration, reference is made to Clauses 4.2 through 4.4, and Clauses 4.11 through 4.13.

Functional requirements given in NORSOK D-001 also apply.

For lifting appliances used in the drilling area where “DNV Lifting appliances, Standard for Certification No.2.22” is referred to in DNV Drilling Plant, an alternative approach is to use EN 13001 series for the structural parts.

For definition of lifting appliances and lifting accessories, reference is made to 3.1.4619 and 3.1.4718.

For the purpose of this annex

- the term “lifting appliances” also include the load bearing parts of the drilling machine where the drilling machine is connected when lifting the drill string, tubulars or other loads,
- the term “lifting accessories” also includes the load bearing equipment used to connect the drill pipes, tubulars or other loads to the drilling machine or other lifting appliances. ~~Requirements for lifting accessories in the drilling area are given in Annex C, see references given for groups D.6 and D.7~~

~~NOTE~~ Typical lifting accessories in drilling operations: ~~Elevators, lifting nipples, lifting caps, lifting subs, pup joints for lifting, running tools used for lifting, lifting tools, handling tools, etc.~~

- ~~The drill string, pup joints, casings, risers and down hole equipment, however, are regarded as parts of the load in drilling operations. Equipment intended for the lifting of loads outside of the well centre is regarded as lifting accessories. Equipment used for lifting solely within casings and risers in well centre, may be considered as not being lifting accessories.~~

~~Equipment used for lifting~~

- ~~Requirements for lifting accessories in the drilling area are given in Annex C, see references given for groups D.6 and D.7~~

~~NOTE~~ Typical lifting accessories in drilling operations: ~~Elevators and links (bails), lifting nipples, lifting caps, lifting subs, pup joints for lifting, running tools used for lifting, lifting tools, handling tools, etc.~~

~~The drill string, pup joints, casings, risers and down hole equipment, however, are regarded as parts of the load in drilling operations. Equipment used for lifting solely within casings and risers in well centre, may be considered as not being lifting accessories. However, when such equipment is intended for handling loads outside of the well centre it shall be regarded as lifting accessories and be rated for a working load limit corresponding to the load experienced when used for lifting outside of the well.~~

Formatert: Skrift: 8 pkt

Formatert: Skrift: 8 pkt

Formatert: Skrift: 8 pkt

Formatert: Punktmerket + Nivå: 1 +
Justert ved: 0,25 cm + Innrykk ved:
0,75 cm

Formatert: Ingen punktmerking eller
nummerering

Formatert: Skrift: 10 pkt, Engelsk
(USA)

Formatert: Punktmerket + Nivå: 1 +
Justert ved: 0,25 cm + Innrykk ved:
0,75 cm

Formatert: Skrift: 10 pkt, Engelsk
(USA)

Formatert: Ingen punktmerking eller
nummerering

D.2 Group overview

The following tables include an informative list of equipment typically used in drilling operations.
 NOTE The list is not necessarily exhaustive.

Table D.1 – Lifting equipment in the drilling area

	Groups					
	D.1	D.2	D.3	D.4	D.5	D.6
Lifting appliances	Conventional draw work including top drive/drill drilling machine (DDM)	Cylinder operated hydraulic draw work (RAM rig) including top drive/drill drilling machine (DDM)	Vertical pipe handling (VPH) machine	Horizontal to vertical (HTV) pipe handling machine including catwalk machine	X-mas tree /BOP carrier	Miscellaneous lifting equipment in the drilling area
Lifting accessories	D.7 Drilling Special designed lifting (SDLA)					▲

- Slettede celler
- Sammenslåtte celler
- Slettede celler
- Slettede celler
- Slettede celler
- Formatert: Skrift: 10 pkt, Ikke Fet
- Formatert: Engelsk (Storbritannia)

Table D.2 – Group D.1 Conventional drawwork including top drive/DDM

Subgroup Drawing Ref.	Equipment description	Main function	Typical names	Lifting equipment (Yes/No)
1	Drawwork	Winch to lift drill string load through several parts of wire rope in crown block and travelling block.	Drawwork	Yes
2	Fastline wheel	Wire sheave for wire coming from drawwork. Fast rotation.	Fastline wheel	Yes
3	Crown block	Multi sheaved wire block mounted in upper part of derrick.	Crown block	Yes
4	Deadline wheel	Wire sheave for wire entering the dead line anchor (small oscillating movements due to wire rope elasticity).	Deadline wheel	Yes
5	Travelling block	Multi sheaved wire block suspended in the drilling line/wire rope parts.	Travelling block	Yes
6	Drilling line	Wire rope pulled by draw work.	Drilling line Drill line	Yes
7	Deadline anchor	Anchorage unit for the dead end of the drilling line. Often combined with a load cell to indicate and record variation of hook load and weight on bit during drilling.	Deadline anchor	Yes
8	Derrick drilling machine (DDM)	A machine that turns the drill string. It consists of one or more motors (electric or hydraulic) connected with appropriate gearing to the main shaft. The DDM is suspended from the travelling block, so the rotary mechanism is free to travel up and down the derrick, guided in vertical guide rails. Drill string load is transmitted through the main shaft, swivel, connection connecting links to the travelling block.	DDM Top drive	Yes
Other equipment shown in drawing but not included in Group D.1				
9	Derrick	Drilling tower structure for suspension of crown block/drill string load. Support for derrick mounted equipment.	Derrick Drilling tower	No
10	Drill line drum	Storage drum for excessive length of wire rope (drilling line) – used during cut and slip operation.	Drill line drum	No
11	Slips	A wedge formed device used to grip the drill string in a relatively non damaging manner and suspend it in the rotary table.	Slips	No
12	Rotary Table	The revolving or spinning section of the drill floor that provides power to turn the drill string. Often a backup system for rotating the drill string when a DDM is installed.	Rotary table	No
13	Heave compensator	Compensates for vertical rig movements to reduce the drill string movements relative to the sea bed.	Heave compensator	No
14	Active heave compensator	Used to further reduce drill string movements relative to the sea bed.	Active heave compensator	No
15	Racker equipment	See Group D.3		
16	Tubular feeding machine (TFM)	See Group D.4		
17	Horizontal to vertical (HTV) arm	See Group D.4		
18	Elevators and elevator suspensions	See Group D.7		
19	Guide track and dolly	Dolly for guiding the DDM	Guide track and dolly	No

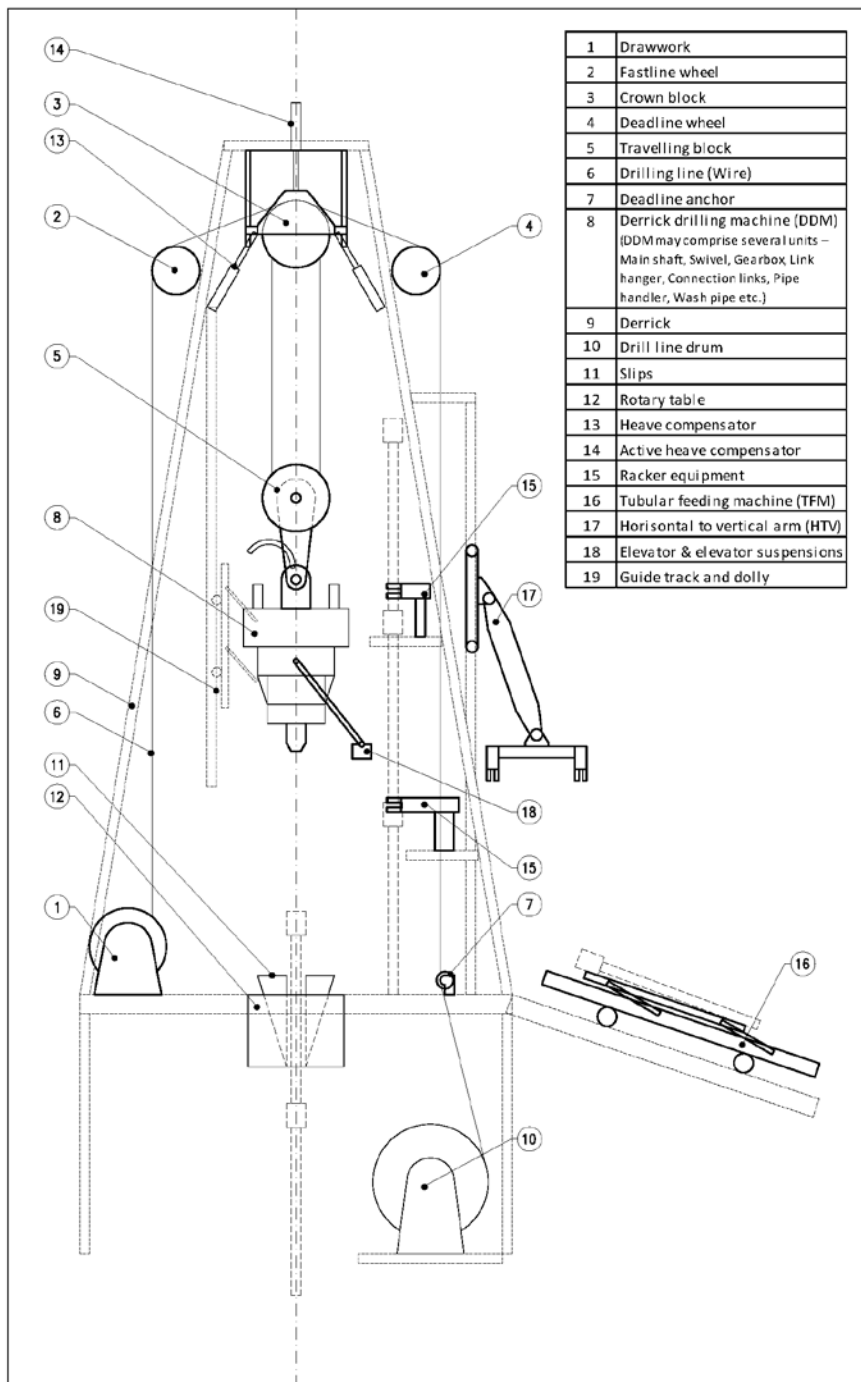

Figure D.1 – Conventional drawwork including top drive/DDM

Table D.3 – Group D.2 Cylinder operated hydraulic drawwork including top drive/DDM

Subgroup Drawing Ref.	Equipment description	Main function	Typical names	Lifting equipment (Yes/No)
1	Hydraulic lifting cylinders	Hydraulic cylinders for lifting of travelling yoke, DDM and drill string load.	Ram rig cylinders Lifting cylinders	Yes
2	Accumulators	Accumulators for connection to the lifting cylinders and hoisting system.	Ram rig accumulators	Yes
3	Travelling yoke	Structure connected to the cylinder rods and guided by the derrick structure. The yoke include sheaves for drilling line, mud hoses, hydraulic hoses and electrical cables.	Travelling yoke	Yes
4	Yoke sheaves	Wire sheaves for main hoisting of drill string	Yoke sheaves	Yes
5	Wire rope	Wire rope for DDM suspension via wire sheaves in travelling yoke and fixed ends anchorage in deck structure.	Hoisting wire rope Ram rig wire rope	Yes
6	Wire rope anchor	Anchor points for wire rope. Attached directly to deck structure or via equalizer mechanisms.	Wire rope anchorage	Yes
7	Derrick drilling machine (DDM)	See Group D.1	DDM Top drive	Yes
Other equipment shown in drawing but not included in Group D.1				
8	Derrick	Drilling tower structure for guiding the travelling yoke. Support for derrick mounted equipment.	Derrick Drilling tower Ram rig	No
9	Guide track and dolly	Dolly for guiding the DDM	Guide track and dolly	Yes (if used for lifting) No (if guiding only)

NOTE New designs shall be classified according to definition in D.1.

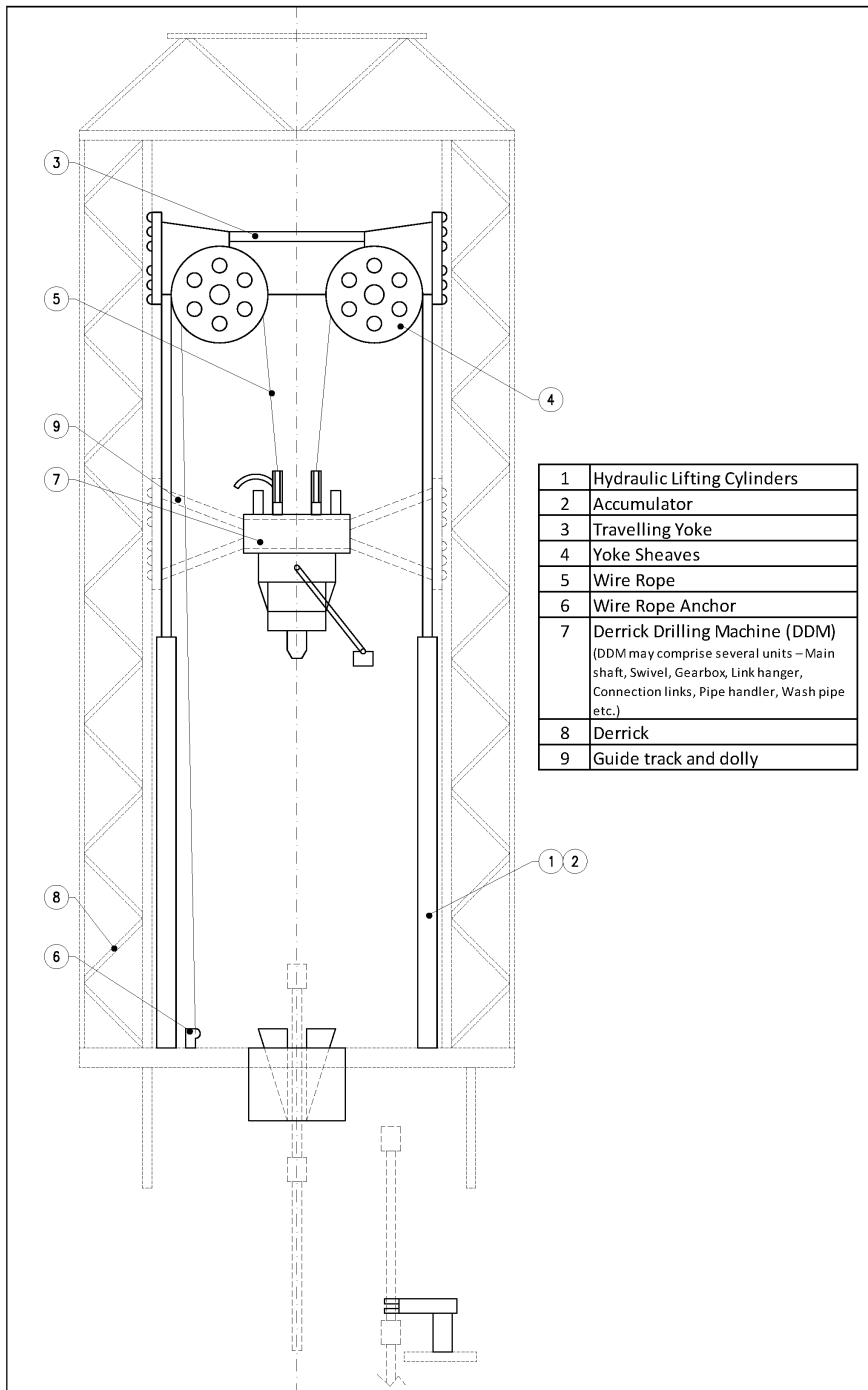

Figure D.2 – Cylinder operated hydraulic drawwork including top drive/DDM

Table D.4 – Group D.3 Vertical pipe handling (VPH) machines

Subgroup	Equipment description	Main function	Typical names	Lifting equipment (Yes/No)
1	Racking equipment	Either to grip, lift, guide, transport and position tubulars vertically inside drilling structure (derrick).	Star racker Hydra racker Bridge crane Upper racking arm (URA) Upper guiding arm (UGA) Intermediate racking arm (IRA) Lower lifting arm (LLA) Lower guiding arm (LGA)	Yes (if used for lifting) No (if guiding only)
2	Finger boards	Storage rack for tubulars – fixed or adjustable.	Drill pipe finger board Casing finger board Riser finger board Belly board	No
3	Manipulator arms	Normally to guide or assist when tubulars are entering the drill floor area or setback area. Sometimes also used for lifting.	Drill floor manipulator arm (DFMA) Multi manipulator arm (MMA) Tail in arm Power scoop arm Monkey tail	Yes (if used for lifting) No (if guiding only)
4	Mouse hole	An opening in the drill floor near the rotary table, but between the rotary table and the V-door, that enables rapid connections while drilling. May be a hole with a fixed bottom at a certain depth or have a mobile bottom to lift the tubulars stored in the hole.	Mouse hole	Yes (if mobile) No (if fixed)

Table D.5 – Group D.4 Horizontal to vertical (HTV) pipe handling machines

Subgroup	Equipment description	Main function	Typical names	Lifting equipment (Yes/No)
1	Pipe rack crane	To lift and transport tubulars from pipe deck area to TFM or directly to drill floor.	Pipe rack crane Pipe deck pipe handler (PDPH) Pipe handling crane Knuckle boom crane Triplex crane Dino	Yes
2	Tubular feeding machines (TFM)	To transport tubulars from storage area to drill floor vicinity or setback area. Horizontal transportation or inclined at an angle.	Tubular feeding machine Tubular shuttle Catwalk machine Tubular chute Riser chute	Yes (when vertical motion of load) No (when horizontal motion only)
3	HTV arms	To transport tubulars from a horizontal or inclined position at the TFM to a vertical position at drill floor area or setback area.	Eagle Eagle light	Yes

Table D.6 – Group D.5 X-mas tree/BOP handling systems

Subgroup	Equipment description	Main function	Typical names	Lifting equipment (Yes/No)
1	BOP cranes	To lift and transport x-mas tree/BOP stacks.	BOP crane Overhead crane Gantry crane	Yes
2	x-mas tree/BOP Transporter	To safely transport/lift/guide the x-mas tree/BOP from the parked/storage position to the well centre and vice versa.	x-mas tree/BOP transporter x-mas tree/BOP trolley x-mas tree/BOP carrier	Yes (when vertical motion of load) No (when horizontal motion only)

Table D.7 – Group D.6 Miscellaneous lifting equipment in the drilling area

Subgroup	Equipment description	Main function	Typical names	Lifting equipment (Yes/No)
1	Man-rider winch	.A winch specially designed for lifting one person.	Man-rider winch	Yes
2	Man riding harness			Yes
3	Access basket	A working basket or personnel basket installed at the end of a fixed or telescopic jib. Slewing and topping movements are normally included to facilitate access to large areas either within the derrick or in the moon pool area.	Access basket Cherry picker Casing stabbing basket	Yes
4	Casing stabbing board	A power driven working platform operating along a guided vertical track.		Yes
5	Utility Winch	Winch used for miscellaneous lifting operations.	Utility winch Tugger winch	Yes
7	Guideline winches	Winch used for installation and tensioning of guide wires.		Yes <u>No, unless used for lifting of loads/anchoring weights</u>
8	Wire line equipment	Equipment used for well intervention.	Wire line cranes SIMOPS crane Wire line winch Wire line masts	Yes, <u>unless used for lifting solely within casings and risers in well centre</u>

Formatert: Engelsk (Storbritannia)

Formatert tabell

Formatert: Engelsk (Storbritannia)

9	Tong lift system	Simple lifting device to keep rig tong in correct height position during make-up/break out. Often consisting of a hydraulic cylinder, wire, wire sheave block and block suspension. NOTE The tong itself is considered as a load and not lifting equipment.	Tong lift system Tong lift cylinder	Yes
10	Escape line	Means for evacuation from the derrick		Yes
11	Miscellaneous slings	Lifting accessories normally predefined for a special task.	Hang off line Master bushing lifting arrangements	Yes (when vertical motion of load) No (when horizontal motion only)

Formatert tabell

Formatert: Engelsk (Storbritannia)

Formatert: Engelsk (Storbritannia)

Table D.8 – Group D.7 **DrillingSpecial designed** lifting accessories (SDLA)

Subgroup	Equipment description	Main function	Typical names	Lifting equipment (Yes/No)
1	One component miscellaneous lifting tools	Tools to connect the tubulars and equipment to the lifting appliance/drilling machine for lifting in and out of the drilling area.	Lifting nipples Lifting caps Lifting adaptors Lifting sub Pup joints for lifting	Yes
2	Miscellaneous lifting tools	Tools to connect the tubulars and equipment to the lifting appliance/drilling machine for lifting in and out of the drilling area.	Riser lifting Lifting tools Handling tools Running tools Hanger tools Etc.	Yes when used for lifting
3	Miscellaneous slings	Lifting accessories normally predefined for a special task.	Hang off line Master bushing lifting arrangements	Yes (when vertical motion of load) No (when horizontal motion only)
43	Elevator	A mechanism that may be closed around drillpipes or other drillstring components to facilitate lowering them into the wellbore or lifting them out of the wellbore. In the closed	Drillpipe elevator Casing elevator Drill collar	Yes

		position the elevator forms a load-bearing ring around the component.	elevator Tubing elevator etc.	
54	Elevator links	A device that connects the elevator either directly to the travelling block or via the DDM.	Elevator links Bails	Yes

D.3 Design criteria

D.3.1 Design loads

Design loads shall be applied in accordance with DNV-OS-E101, Ch.2, Sec.1, Subsections H and I.

Depending on the type of lifting appliance DNV-OS-E101, gives further references to other standards, e.g. API spec. 8C, "DNV -Standard for Certification No. 2.22, and "FEM, Rules for the Design of Hoisting Appliances "

It is important to note that API defines "Load Rating" as follows: "*Maximum operating load, both static and dynamic, to be applied to the equipment*"

This is a different approach compared to the definition of "Rated capacity" used in this NORSOK standard.

For lifting accessories, see Annex C.

D.3.2 Environmental conditions

To obtain a safe design the buyer of the lifting equipment shall give information regarding the environmental conditions for the installation at the elevation level where the lifting equipment shall be located.

Wind forces, horizontal and vertical accelerations are important basic information for the calculation of realistic forces acting on the equipment both during operational, non-operational and accidental conditions.

D.3.3 Loading and utilization data

The buyer shall, in agreement with the supplier, decide the required service lifetime, load spectrum and utilization data to be applied for the calculations.

For further information regarding group classification of lifting appliances see "DNV -Standard for Certification No. 2.22, Lifting appliances" and "FEM1.001, Rules for the Design of Hoisting Appliances, Booklet 2".

Some guidance data will be given for the selection of appliance group and dynamic factor for different type of equipment, see D.6 to D.7.

D.4 Conventional drawwork including top drive/DDM (Group D.1)

In addition to the general requirements given in D.1, the following requirements apply:
Conventional drawworks are defined as complex lifting appliances, ref. main part of this NORSOK standard.

D.5 Cylinder operated hydraulic drawwork including top drive/DDM (Group D.2)

In addition to the general requirements given in D.1, the following requirements apply:
Cylinder operated drawworks are defined as complex lifting appliances, ref. main part of this NORSOK standard.

For a cylinder operated hydraulic drawwork the components directly controlling the load shall be regarded as main load path components. Typical examples are pressurized valve block units controlling the cylinders.

These components shall be designed as if the components were a part of the hydraulic cylinder regarding material selection, safety factor and pressure test requirements.

These main components of the cylinder operated drawwork shall be thoroughly considered in the safety analysis.

D.6 Vertical pipe handling (VPH) machines (Group D.3)

D.6.1 Dynamic factor

For vertical pipe handling (VPH) machines the dynamic factor shall reflect the actual working condition of the handling machine and shall not be less than 1,3 independent of type of installation – fixed or floating.

The dynamic factor to be used for each individual machine depends on the stiffness of the load handling system. A machine with a flexible jib or a wire suspended load may be calculated using the minimum value of 1,3.

A stiffer system e.g. where the tubulars are handled directly by a gripper claw and driven vertically e.g. by a rack and pinion drive and supported to a rigid structure, the dynamic factor shall be increased to minimum 1,6 unless measured or proved otherwise.

When entering pipe joints into the mouse hole, the mobile bottom to receive the vertical pipe is normally not visible. A dynamic factor of 2,0 is thus often applied for the calculations. A reduced dynamic factor may be used if verified by the design, e.g. installed shock absorbers.

D.6.2 Appliance group

As a guidance, based on a study of typical VPH operations onboard a drilling rig:

Table D.9 – Appliance ~~groupe~~group

Equipment description	Particulars concerning nature of use	Appliance group
Racking equipment	These machines are in operation when building stands, storing stands in the set back area, tripping out and tripping in stands.	A5 (Q1/U6)

Assumptions: 20 years of operation, drilling 5 wells per year, water depth 1 500 m, total depth 5 400 m.

Further estimated appliance groups:

Table D.10 – Appliance ~~groupe~~sgroups

Equipment description	Particulars concerning nature of use	Appliance group
Manipulator arms	These machines are in operation when tubulars are entering the drill floor area and/or the set back area.	A4 (Q1/U5) or A5 (Q1/U6)
Mouse hole	These machines are in operation when building stands, i.e. a reduced number of operating cycles.	A2 (Q1/U3)

NOTE Standard for "Bridge and Gantry Cranes" – EN 15011 is referred to in Annex G4. The typical name "Bridge crane" as listed in Table D.4, Subgroup 1, should not be regarded as a "Bridge and Gantry Crane" according to EN 15011. This "Bridge crane" is a part of the racking system and should be designed as specified in D.1.

D.7 Horizontal to vertical (HTV) pipe handling machines (Group D.4)

D.7.1 Dynamic factor

For HTV machines the dynamic factor shall reflect the actual working condition of the handling machine and shall not be less than 1,3 independent of type of installation – fixed or floating.

The dynamic factor to be used for each individual machine depends on the stiffness of the load handling system. A machine with a flexible jib or a wire suspended load may be calculated using the minimum value of 1,3.

When pipes are laid down onto the tubular feeding machine a dynamic factor of minimum 1,8 shall be used. This applies for the TFM when at standstill in a loading operation.

D.7.2 Appliance group

By way of guidance based on a study of typical HTV operations onboard a drilling rig:

Table D.11 – Appliance ~~groupes~~groups

Equipment description	Particulars concerning nature of use	Appliance group
Horizontal to vertical (HTV) pipe handling machines.	These machines are in operation to transport pipes from the main crane landing area to pipe deck and further from pipe deck to drill floor.	A4 (Q1/U5)

Assumptions: 20 years of operation, drilling 5 wells per year, water depth 1 500 m, total depth 5 400 m.

Additional requirements for lifting accessories see Annex C.

D.8 X-mas tree/BOP handling systems (Group D.5)

D.8.1 General

Gantry type cranes in this group shall be designed according to G.4.

D.8.2 Appliance group

Estimated appliance groups:

Table D.12 – Appliance ~~groupes~~groups

Equipment description	Particulars concerning nature of use	Appliance group
X-mas tree/BOP handling systems BOP cranes x-mas tree/BOP transporter	These machines are in operation when handling the BOP, i.e. very seldom. The load is, however, often high relative to SWL.	A2 – A3

D.8.3 Additional requirements

Lifting equipment used for lifting BOPs or x-mas trees shall have a rated capacity indicator in accordance with EN 12077-2. If the load is lifted by more than one independent lifting appliance the rated capacity indicator shall give information for each individual lifting appliance.

Guiding system to control possible horizontal movements shall be installed on floating installations.

NOTE This type of crane is defined as a complex lifting appliance.

D.9 Miscellaneous lifting equipment in the drilling area (Group D.6)

D.9.1 Manrider winch

See Annex G.7.3, Group G7

D.9.2 Man riding harness

See Annex C, 11.4 Group R11

D.9.3 Access basket

See Drilling plant Ch 2. sec.5 I "Man riding equipment" and relevant requirements in EN 280

D.9.4 Casing stabbing board:

See Drilling plant Ch 2. sec.5 I "Man riding equipment" and relevant requirements in EN 280

D.9.5 Utility winch

See Annex G.7, [Group G7](#)

D.9.6 Guideline winches

See Annex G.7.1, [Group G7](#)

D.9.7 Wireline equipment

See Annex G ([Group G7](#) or [G20](#)) [unless used for lifting solely within casings and risers in well centre.](#)

D.9.8 Tong lift system

See Lifting appliances 2.22

D.9.9 Escape line

See Annex A Group E5

[D.9.10 Miscellaneous slings](#)

[See Annex C Group R1 and R3](#)

D.10 Drilling lifting accessories (Group D.7)

D.10.1 One component miscellaneous lifting tools

See Annex C, Group R10

D.10.2 Miscellaneous lifting tools

See Annex C, Group R10

~~D.10.3 Miscellaneous slings~~ [Elevator](#)

~~See Annex H, Foundation and suspensions, Annex C~~

~~D.10.4 Elevator~~

See Annex C, Group R10

~~D.10.5~~ [Elevator links](#)

See Annex C, Group R10

Annex E (Normative) Lifts

E.1 General

This annex applies to lifts on offshore petroleum installations and lifts in the process areas at petroleum installations on shore.

The requirements of this annex apply in addition to the relevant requirements stated in Clause 1 to Clause 5 and Annex B.

E.2 Group overview

Different types of lifts are grouped as presented in Table E.1

Table E.1 – Lift groups

Group No.	Group	Sub. groups	Relevant standard
E1	Electric lifts	Lifts for transportation of persons and goods	EN 81-1
E2	Hydraulic lifts	Lifts for transportation of persons and goods	EN 81-2
E3	Service lifts	Goods lift up to 300 kg	EN 81-3
E4	Rack and pinion lifts	Lifts for transportation of persons and goods	Safety measures shall be in accordance with EN 81-1
E5	Goods lift	Goods lift above 300 kg	Clause 1 to Clause 5 Relevant requirements <u>requirements</u> of EN 81-3

E.3 Additional requirements for all lifts group E1, E2, and E4

E.3.1 General

Lifts shall be designed to operate in a minimum operational temperature of -20 °C unless otherwise specified in standards referred to in this annex.

Fire protection shall be in compliance with the general area classification

For floating installations, lifts and associated guides and components, shall be constructed to allow for the relevant movements. As an addendum to EN standards, ISO 8383 should be used for relevant parts.

Lifts shall not be considered as a part of escape routes. However, it shall be possible to escape from the lift and the hoist way with the lift at any elevation. This may require a hatch in the lift car roof and permanent ladder in the well. The lift car shall automatically be prevented from moving, when personnel is/are escaping from the well. The lift should to be manually reset from outside the well. The escape system shall be risk evaluated. Alternatively the escape system can be arranged outside the projection of the lift car roof.

Escape from legs/shafts/columns of an installation shall be considered separately. If use of lift is necessary to ensure adequate and effective escape, the lift system shall satisfy special

requirements, e.g. concerning transport of injured personnel on stretchers, protection, ventilation, power supply. Relevant requirements in NS-EN 81-72 should be considered.

Passenger and goods lift(s) shall be provided if living quarters has more than one floor level. The lift(s) shall provide access to all main levels, and at least one lift shall be dimensioned to accommodate a standard stretcher (2 200 mm x 650 mm), with an inside cabin floor dimension of minimum 2 400 mm x 1 200 mm.

Any continuation of internal lift(s) from ~~the~~ the living quarters to any levels outside the living quarters, should be considered divided by appropriate smoke and sound barrier(s).

Wire terminations by use of U-bolt clamps on tensioned part of wire ropes is prohibited.

The design of rigid screens, protecting rotating/ moving equipment, shall enable easy inspection and maintenance of the protected equipment.

Audible and visual alarm in the central control room shall be automatically activated if the lift goes out of service (unintended stop between landing doors).

Upon low alarm for HC gas detection (20 % LEL) in the area, surrounding the lift well, lifts shall automatically go to next floor level and stop. Continued use of the lift shall be prohibited. Upon high alarm for HC gas detection (30 % LEL) in the area surrounding the lift well, the lift shall stop.

E.3.2 Lift well

Lifts shall have a totally enclosed lift well.

Every landing entrance shall incorporate a sill of sufficient strength to withstand the passage of loads being introduced into the car. A slight counter slope shall be provided in front of each landing sill to avoid water from washing, sprinkling, etc., draining into the well. Landings entrances, exposed to weather, shall have a drain to prevent water from coming in to the well.

It shall be possible to transport goods consistent with the capacity of the lift, by means of pallet jack, in and out of the lift, without obstruction from door thresholds or without damaging the threshold.

The distance between lift car sill and well wall, may in special circumstances be increased to 0,25 m.

If it is not acceptable to mount a socket outlet in the pit, one socket shall be placed ~~near by~~ nearby, outside the pit.

Alarm in pit can be omitted if work procedures establish that radio communication always shall be present when working in the pit.

If a drain point is located at the bottom of the lift pit, it shall be gas tight and have a fail-safe mechanism against drying out.

-The well shall be provided with electric lighting giving a permanent intensity of illumination of at least 50 lux even when all the doors closed. Installation of emergency lighting in the well shall be considered in accordance with NORSOK S-001.

E.3.3 Lift car

Switch for illumination of the car can be omitted if there is an information sign in the main switchboard, and the contactors for the light circuit, is protected against unintended deactivation.

Lift cars shall be equipped with a telephone connected to the main telephone system (private automatic branch exchange) at the installation.

PA system shall be installed in the lift car.

E.3.4 Materials and fabrication

Materials and fabrication may be in accordance with relevant NORSOK standards.

E.3.5 Documentation

The lift shall be certified by an approved enterprise of competence.

Annex F (Normative) Portable units

F.1 General (Group F)

For portable units the requirements of this annex apply in addition to the requirements stated in Clause 1 to Clause 5.

~~NOTE:~~ It is assumed that ~~practices for slinging, lifting and lowering operations~~ are planned and performed in accordance with NORSOK R-003 or NORSOK R-005.

Formatert: Skrift: 8 pkt

Formatert: Skrift: 8 pkt

Formatert: Skrift: 8 pkt

Formatert: Skrift: 8 pkt

Portable units of groups indicated in Table F.1 shall be documented in accordance with NORSOK R-003, Annex E or R-005 Annex E, as applicable. Lifting sets for all groups shall be documented in accordance with NORSOK R-003, Annex E or R-005 Annex E, as applicable.

Portable units of groups indicated in Table F.1 are subject to the provisions for Enterprise of competence given in NORSOK R-003 Annex H or R-005 annex H, as applicable. Lifting sets for all groups are subject to the provisions for Enterprise of competence given in NORSOK R-003 Annex H or R-005 Annex H, as applicable.

The portable units shall be designed to facilitate safe lifting. The following requirements apply. Some exceptions are specifically mentioned in the standard text for group F.4 and F.5 (exceptions mentioned in referenced documents are not accepted).

- the envelope formed by the projected outline of the unit and its lifting set shall be smooth without geometrical details giving risk of entanglement between lifted unit and surrounding or between lifted and lifting set. Examples of such envelopes are shown in -Figure F.1. All groups of portable units shall be free from protruding parts outside the envelope of the unit, i.e. details and parts that may catch or damage other load, load carriers or structures are not allowed. Protruding parts representing a risk for overload to crane in case of entanglement to the vessels during lifting operation are not allowed;
- portable units with door handles, hinges, hatch cleats and similar details shall be arranged in a recessed or protected fashion to avoid becoming catch points or contacting points that may complicate lifting and handling operations. Deflector plates should be designed such that the angle between the outer plane (e.g. of bottom rail or wall) and the free edge of the plate is not more than 35°;
- portable units shall be designed to prevent the lifting set from being entangled to the underside or outer corners of the unit;
- avoid elements on top of the portable unit that create a risk of entangling. The top of all open portable units with permanent internal fittings, machinery or other installations where crane hooks or forerunners/pendants or lifting set may snag, shall be protected with grating, plates or canvas cover. This may be fixed, hinged or removable. Top protection shall be capable of being secured;
- stacking points on top of portable units shall not be located at corners outside the shackle attachment point to avoid entanglement with cargo rails, openings, surrounding structures, other portable units etc., see Figure F.1 and Figure F.2;
- pad eyes for connection to lifting set should be oriented to ensure that the resulting sling force on each pad eye acts in the plane of the pad eye (+/- 2°);
- the lever arm effect in bolted connections, causing tension load in bolts and bending stresses in flanges shall be taken into account in the design ~~calculations~~ [calculations](#).

Formatert: Punktmerket + Nivå: 1 +
Justert ved: 0,25 cm + Innrykk ved:
0,75 cm

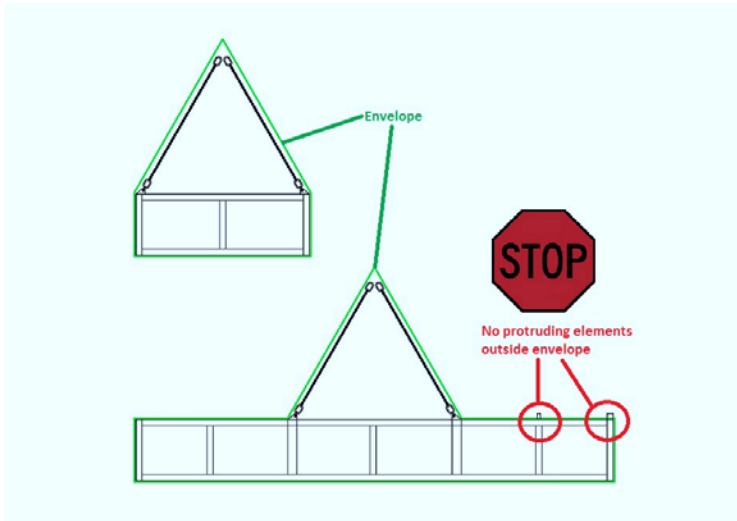

Figure F.1 - Envelope of unit represented by frame and sling arrangement

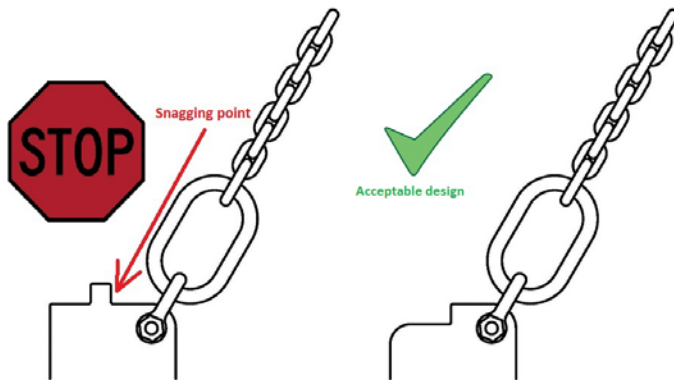

Figure F.2 – Example of unacceptable stacking pins representing a risk for entanglement to vessel, structure, sling set or other load

F.1.1 Testing and documentation of lifting sets

Lifting sets shall be tested and accompanied by documentation in accordance with Annex C as required for groups R1, R2 or R3 as applicable.

F.2 Group overview

Table F.1 gives an overview of object groups covered by this annex.

Table F.1 – Groups of portable units

Group no.	Group	Description	Subject to NORSOK R-003 or R-005 Annex H and E
F1	Offshore containers	Portable unit with a maximum gross mass not exceeding 25 000 kg, for repeated use in the transport of goods or equipment, handled in open seas, to, from or between fixed and/or floating installations and ships.	Unit and lifting set
F2	Offshore service containers	Portable unit built and equipped for a special service task, mainly for temporary installation, e.g. are laboratories, workshops, stores, power plants, control stations.)	Unit and lifting set
F3	Offshore portable units	Portable unit or package with a primary structure frame and maximum gross weight not exceeding 100 tonnes, for repeated or single use, as defined in DNV Standard for Certification No. 2.7-3 clause 1.1.5 Type A	Unit and lifting set
F4	Heavy lift units and units for subsea lifting	Heavy lift units are portable units with a maximum gross weight equal to or exceeding 50 tonnes planned to be lifted as suspended load onshore or offshore. Units for subsea lifting are portable units intended for lifting through wave zone and lowering in deep water to landing on seabed.	Lifting set only
F5	Lifted objects	This group includes any loads not belonging to the other groups, which are not in themselves lifting equipment, but fitted with attachment points for lifting accessories for lifting onshore, internally on an offshore installation or between installation and vessel. Lifted objects also includes include objects with detachable transport skid/cradle. Examples of lifted objects may be <ul style="list-style-type: none"> machines, components or equipment with fixed or detachable dedicated lifting points, modules or structures with lifting point for(s) intended for lifting during installation, maintenance and decommissioning. <p>Typical unit weights from 2 tonnes to 50 tonnes but may be used for lifts up to 100 tonnes.</p>	Lifting set only

Formatert: Punktmerket + Nivå: 1 +
Justert ved: 0,25 cm + Innrykk ved:
0,75 cm

F.3 Offshore containers (Group F1)

Offshore containers and their dedicated lifting sets shall be in accordance with DNV standard for certification No. 2.7-1 April 2006, or EN 12079—1 and EN 12079—2.

NOTE: Certification requirements given in DNV standard for certification No. 2.7-1 are not mandatory requirements of this NORSOK standard.

Formatert: Skrift: 8 pkt

Formatert: Skrift: 8 pkt

In order to avoid mix of shackles of different specifications, only grade 8 shackles shall be selected with safety factor in accordance with DNV Standard for Certification No. 2.7-1 or EN 12079-2.

Offshore containers intended for transport of dangerous goods shall also be certified in accordance with the IMDG code.

F.4 Offshore service containers (Group F2)

Offshore service containers shall be designed and manufactured in accordance with DNV standard for certification No. 2.7-2 December 1995. Lifting sets shall be in accordance with group F.1.

~~NOTE:~~ Certification requirements given in DNV standard for certification No. 2.7-2 are not mandatory requirements of this NORSOK standard.

Formatert: Skrift: 8 pkt

Formatert: Skrift: 8 pkt

The offshore service container shall also comply with applicable requirements of NORSOK Z-015 and local installation specific additional requirements.

F.5 Offshore portable units (Group F3)

Offshore portable units and their dedicated lifting sets shall be designed and manufactured in accordance with DNV standard for certification No. 2.7-3 May 2011. Only units designed for operational class R60 is acceptable for use on the Norwegian continental shelf, even if their use is intended to less severe sea states.

~~NOTE:~~ Certification requirements given in DNV standard for certification No. 2.7-3 are not mandatory requirements of this NORSOK standard.

Formatert: Skrift: 8 pkt

Formatert: Skrift: 8 pkt

For the purpose of this NORSOK standard, only portable offshore units of type A according to DNV Standard for Certification No. 2.7-3 ~~is are~~ included in group F.3. Types B, C, D and E and their dedicated lifting sets are to be considered as group F5.

F.6 Heavy lift units and units for subsea lifting (Group F4)

Heavy lift units offshore and units for subsea lifting and their dedicated lifting sets shall be designed in accordance with DNV-OS-H101, DNV Rules for the planning and execution of marine operations, January 1996 as amended, Part 1 Chapter 3 and 4, Part 2 Chapter 5, or ISO 19901-6 Specific requirements for offshore structures -- Part 6: Marine operations, or other recognised guidelines/standards such as e.g. GL Noble Denton Guidelines for Marine Lifting Operations, 0027/ND.

Heavy lift units onshore and their dedicated lifting sets shall be designed in accordance with relevant parts of DNV Rules for the planning and execution of marine operations, January 1996 as amended, Part 1 Chapter 3 and 4, Part 2 Chapter 5, or ISO 19901-6 Specific requirements for offshore structures -- Part 6: Marine operations, or other recognised guidelines/standards such as e.g. GL Noble Denton Guidelines for Marine Lifting Operations, 0027/ND.

Units for subsea lifting shall be analysed in accordance with DNV-RP-H103, which gives guidance for modelling and analysis of marine operations including lifting through wave zone and lowering of objects in deep water to landing on seabed.

~~NOTE:~~ Units for ~~sub-sea~~subsea lifting, that are planned for repetitive lifting operations, may be designed in accordance with the requirements of DNV Standard for Certification No. 2.7-3 Clause 3.11 Subsea Application.

Formatert: Skrift: 8 pkt

Formatert: Innrykk: Venstre: 0 cm, Første linje: 0 cm

Formatert: Skrift: 8 pkt

Formatert: Skrift: 8 pkt

Formatert: Skrift: 8 pkt

Formatert: Skrift: 8 pkt

If the requirements in F.1 could not be fully met, risk reducing measures to protect the lifting set from damage should be described in instructions for lifting. Instructions should be provided to ensure that portable units with protruding parts are placed with some open space > 1,5 m around the load, or by use of bumpers and guides, to minimize risk of entanglement with other loads or structures.

In cases where the lifting set may be damaged by catching its lifted object, the lifting set should be designed or equipped to enable securing the lifting set. Such securing may be temporary, such as e.g. ropes, plastic strips etc. The instructions shall describe proper securing.

F.7 Lifted objects (Group F5)

F.7.1 General

Group F5 includes objects and lifting sets that do not belong in any of the groups F1 to F4. This group of lifts often have typical characteristics, e.g.:

- permanent structure or equipment to be installed as a new part of the installation, or moved / removed as part of platform modification or removal.
- objects that ~~can not~~ cannot be lifted with the aid of a load carrier;
- often unsymmetrical lifting sets due to defined location of the ~~center~~ center of gravity (COG) or unsymmetrical configuration of lifted object;
- if a transport cradle is required, the cradle is often designed with defined supports for the machine or equipment to be transported and sometimes bolted or locked to the equipment;
- in some special cases the lifting lugs may partly be located on the lifting cradle and partly on the equipment to be transported.

Formatert: Punktmerket + Nivå: 1 +
Justert ved: 0,25 cm + Innrykk ved:
0,75 cm

As an alternative to the requirements given in the subsequent clauses, design and manufacturing according to DNV 2.7-3 may also be acceptable for types B, C, D and E defined in DNV 2.7-3. Only units designed for operational class R60 is acceptable for use on the Norwegian continental shelf, even if their use is intended to less severe sea states.

Lifting sets intended for lifting objects onshore or ~~inboard~~ onboard on an offshore installation shall comply with Annex C. For the purpose of considering the use of such lifting sets for complex rigging, the calculation method described in the subsequent sections should be used. A lifting arrangement drawing in accordance with F.7.2.4.1 shall be prepared for complex rigging arrangements. The marking requirements in F.7.4 do not apply for such lifting sets.

NOTE: Complex rigging arrangement is understood as those having some of the characteristics listed above.

F.7.2 Design

F.7.2.1 General design requirements

Objects to be lifted between installation and vessel should be designed with fixed lifting points.

If two 2-legged slings are selected to function as a four legged sling, the lift shall be calculated as for a four legged sling.

The lifting arrangement shall be designed in accordance with the following design principles:

- for offshore lifts the top link shall be easily accessible by the slinger without climbing on the load. The top link shall be located at a maximum height of 1.3 m above deck;
- all offshore lifts with weight above 25 tonnes should have two separate top links. For loads with weight of more than 25 tonnes the top links shall be laid down together along the deck at least 1,5 m from the load;
- 2 or 3 lifting points if possible. More than 4 should be avoided;
- working angle (from vertical) should be between 15 degrees and 45 degrees. If the sling angle is less than 15 degrees special considerations shall be given to the sling length tolerances and tolerances of the CoG location. Otherwise all loads shall be considered to be taken by one sling;
- hook to be positioned vertically above COG to give a steady lift;
- equal length slings to be used as far as possible;

- large differences in sling lengths shall be avoided;
- wire rope for lifting slings shall have a minimum diameter of 13 mm;
- lifting chains shall have a minimum diameter of 8 mm.

NOTE Normal fabrication tolerances in sling lengths and shift in COG may lead to all load transferred in one sling leg if sling angle from vertical is less than 15 degrees.

Slings should be protected from edges, friction and abrasion, whether from the load or the lifting appliance.

As a general rule the lifting lugs/attachment points should be located higher than the COG of the load to be sure the lift do not tip over.

If the requirements in F.1 could not be fully met, risk reducing measures to protect the lifting set from damage should be described in instructions for lifting. Instructions should be provided to ensure that portable units with protruding parts are placed with some open space > 1,5 m around the load on the supply vessel to minimize risk for entanglement to other load or openings in cargo rail.

In cases where the lifting set may be damaged by catching its lifted object, the lifting set should be designed or equipped to enable securing the lifting set. Such securing may be temporary, such as e.g. plastic strips. The instructions shall describe proper securing

F.7.2.2 Lifting set terminology

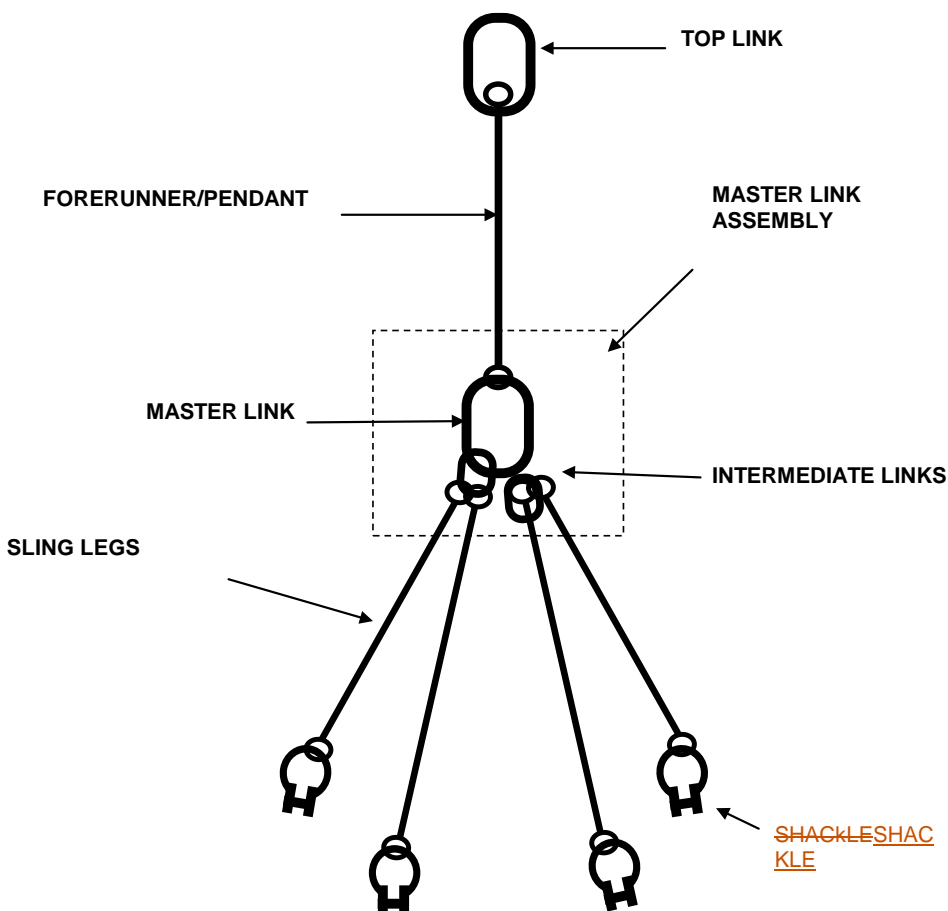

Figure F.3 - Terminology

F.7.2.3 Lifting design load factors

F.7.2.3.1 Summary of design load factors and resistance factors

The factors relevant for lifting design are summarized in Table F.42.

Table F.42 - Factors relevant for lifting design

APPLICATION	TO FIND	Load factors					Resistance factor	
		W _{COG}	SKL	DAF	DF = (γ _p · γ _e)		1/γ _e	γ _{Rm}
					γ _p	γ _c		
Lifting accessories								
Sling design	MBL	X	X	X	X	X	X	X
Shackle selection	MBL	X	X	X	X	X		X
Master link/ Forerunner	MBL			X	X	X	X	X
Check of structural capacity during lifting								
Check of structure capacity	Design capacity	X	X	X	X	X		X
Lifting lug design	Design capacity	X	X	X	X	X		X

← Formatert: Venstre

F.7.2.3.2 Working load limit (WLL)

The working load limit (WLL) for the complete sling set for group F.5 is defined as follows:

$$WLL = W * W_{CF} \tag{F.1}$$

where

- WLL = weight of the lifted object W including weight contingency and excluding the lifting sling set
- W = estimated weight of the lifted object
- W_{CF} = weight contingency factor as defined in the table below

The weight of the lifted object shall be multiplied with a contingency factor according to Table F.23 based on the method used defining the weight.

Table F.23 - Determination of weight contingency factor

METHOD TO DETERMINE THE WEIGHT	W_{CF}	COMMENT
Weighing	1,03	Incl. weighing by platform crane with calibrated loadcell within ± 3 % accuracy.
Detailed calculation, based on up-to-date drawings	1,1	NOTE Possibility of significant weight development during construction and fabrication.
Detailed calculation, based on less updated drawings/info	$\geq 1,2$	W_{CF} to be assessed specifically. A factor of 1,5 or more should be considered for demolition lift.

F.7.2.3.3 Centre of gravity (COG) envelope factor W_{COG}

For weighed objects or objects with a simple weight pattern: $W_{COG} = 1,0$

For unweighed objects or objects with a complex weight pattern: $W_{COG} = 1,1$

Examples of structures with simple weight pattern are single elements, pipes or equipment, simple trusses or deck sections, or packages where weight and centre of gravity (COG) can be accurately calculated.

F.7.2.3.4 Skew load factor (SKL)

Skew loads are additional loads from redistribution due to equipment and fabrication tolerances and other uncertainties with respect to force distribution in the rigging arrangement.

The following SKL values should be used when the rigging fulfils the following ~~criteria~~criteria:

- sling lengths within fabrication tolerances;
- approximately symmetrical sling configuration with a working angle not more than 45 degrees from the vertical.

Tabell F.34 - Skew load factor - usual rigging design and slings within tolerances

LIFTING CONFIGURATION	SKL
Single hook 4 point lift without spreader bar (statically indeterminate)	1,25
Single hook 4 point lift with 1 or 2 floating spreader bars	1,10
Tandem lift and 4 point lifts (statically determinate)	1,00
3 point lift or less (statically determinate)	1,00

If the rigging has a less optimal design or geometry, an increased SKL shall be considered. Reference is made to DNV's "Rules for planning and execution of marine operations", Pt.2 Ch.5 Section 2.3.

NOTE With a rigid load the majority of the weight may be taken by only three, or even two, of the legs, with the remaining legs only serving to balance the load.

F.7.2.3.5 Dynamic amplifying factor (DAF)

Standard dynamic amplifying factor to be used when designing lifted objects and their corresponding lifting ~~accessories shall~~accessories shall be:

Onshore lifts and onboard lifts on fixed or floating installations:

$$DAF = 1,5 \text{ for } WLL \leq 50 \text{ tonnes}$$

NOTE: The DAF for lifting accessories shall never be selected less than 1.5 for loads up to 50 tonnes in order to comply with safety factors according to machinery directive and NMD. For onboard lifting on bottom supported installations and for onshore lifting, spreader beams, lifting beams and lifting frames may be designed in accordance with the requirements of Annex C, Clause C.12.1 unless actual DAF exceeds 1.2.

Formatert: Skrift: 8 pkt

Formatert: Skrift: 8 pkt

Formatert: Skrift: 8 pkt

The following dynamic factor shall be used for the design of lifting arrangement on objects for offboard lifting by offshore crane.

Offboard

Offroad lifts: $DAF = 1,09 + 0,41 \cdot \sqrt{\frac{50}{WLL}}$ for $WLL \leq 50$ tonnes (F.2-1)

Offboard, onboard and onshore lifts: $DAF = 1,7 - 0,004 \cdot WLL$ for $WLL > 50$ tonnes (F.2-2)

Figure F.4 shows typical DAF values for onshore, onboard and offboard lifting

For all lifts from 50 tonnes to 100 tonnes designed according to this NORSOK standard, the dynamic factor DAF shall be selected with a linear reduction from 1,5 at 50 tonnes to 1,3 at 100 tonnes.

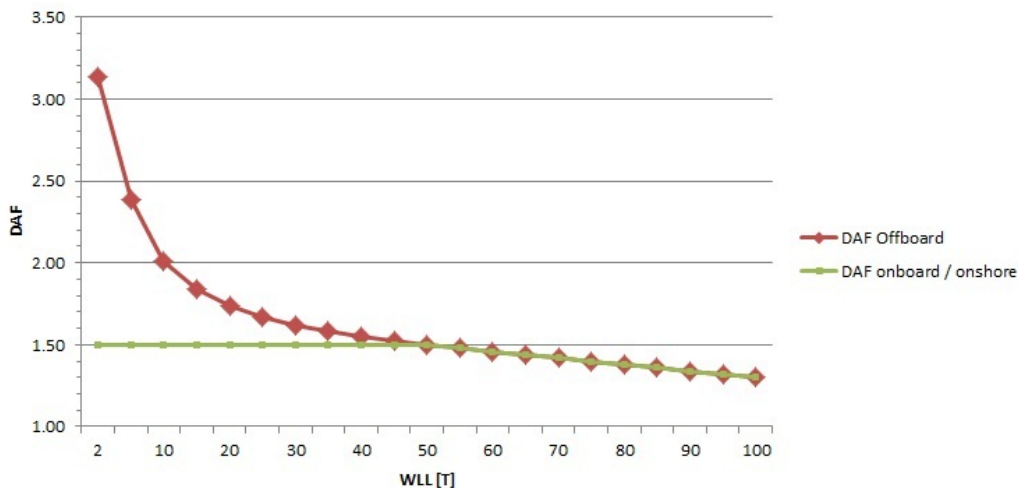

Figure F.4 – Dynamic amplification factor (DAF)

F.7.2.3.6 End termination factor γ_e

End termination factor:

Wire rope slings:

Ferrule secure termination EN 13411-3

Spliced terminations EN 13411-2

Chain slings EN 818-2

Fibre slings spliced termination EN 1492-4

Fibre, endless Soft slings and webbing slings EN 1492-1 and EN 1492-2

$\gamma_e = 0,9$

$\gamma_e = 0,8$

$\gamma_e = 1,0$

$\gamma_e = 0,9$

$\gamma_e = 1,0$

Formatert: Ingen understreking

Formatert: Innrykk: Venstre: 1 cm

Formatert: Utheving

F.7.2.3.7 Material resistance factor, γ_{Rm}

Material resistance factor for:

Lifting accessories:

Check against minimum breaking load (MBL):

Wire rope slings:	$\gamma_{Rm} = 2,0$
Chain slings:	$\gamma_{Rm} = 1,8$
Shackle and rings (incl. master links)	$\gamma_{Rm} = 1,8$
Fibre slings	$\gamma_{Rm} = 2,8$

Structural members and sections:

Check against characteristic resistance:

Lifting lugs and structural parts	$\gamma_{Rm} = 1,15$
Bolts and welds	$\gamma_{Rm} = 1,3$

For structures, bolted connections, welded connections and lifting lug design the material resistance factor may be selected according to above factors or other recognised standards like EN 13001-3-1 and EN 1993-1-1 Eurocode 3 may be used.

NOTE: Capacity of structural parts, bolts and welds are checked against yield limits for steel in accordance with recommended standards. Lifting accessories like slings, shackles and rings are checked against minimum breaking load. Thus, the safety levels for all load bearings components are considered to be approximately equal.

Formatert: Skrift: 8 pkt

Formatert: Skrift: 8 pkt

F.7.2.3.8 Design factor (DF)

The design factor DF is defined as:

$$DF = \gamma_p \cdot \gamma_c \quad (F.3)$$

where

γ_p = partial load factor

γ_c = consequence factor

Table F.45 - Design factors (DF)

ELEMENT CATEGORY	γ_p	γ_c	DF ($\gamma_p \cdot \gamma_c$)
Lifting points including attachments to object	1,34	1,25	1,68
Single critical elements supporting the lifting point	1,34	1,25	1,68
Lifting equipment (spreader bar, shackles, slings etc.)	1,34	1,25	1,68
Main elements which are supporting the lift point	1,34	1,10	1,48
Other structural elements of the lifted object	1,34	1,0	1,34

F.7.2.4 Lifting arrangement

F.7.2.4.1 Lifting arrangement drawing

A lifting arrangement in this context consists of the lifted load and its dedicated lifting set. A lifting arrangement drawing shall be prepared. The following information (not limited to) shall be stated on the lifting arrangement drawing:

- net/gross weight of lifted object;
- GA-drawing of the lifting arrangement, showing the geometry of the load, including location of **center** of gravity, and the sling assembly;

- WLL for the complete lifting set. Note that this particular WLL shall not include DAF. Thus it will express the maximum allowed weight of lifted object;
- WLL and MBL for each individual component of the lifting arrangement;
- working angles (angle between vertical and sling leg);
- sling and shackle type specification;
- material specification;
- certificate requirements;
- operational limitations;
- sling lengths and fabrication tolerances;
- reference to applicable standards.

F.7.2.4.2 Structural design

Design load in accordance with F.7.2.3 should be chosen for proof of competence of structural components. Standard lifting lugs as specified in Annex J should preferably be selected.

F.7.2.4.3 Steel wire rope slings specification

Wire rope slings shall be selected by specifying the following:

- wire rope type/construction;
- standard (NS-EN 12385-4 subsidiary NS-EN 13414-1);
- minimum breaking load (MBL) (excluding end termination factor γ_e);
- sling length (far inside eyes) in mm;
- end termination design.

Recommended construction/types:

- Steel Wire 6X36-CFS 1770 or 1960 N/mm² (6-strand rope with Fibre Core);
- Steel Wire 6x36/41/49 CWR (IWRC) 1770 or 1960 N/mm² (6-strand rope with Steel Core).

F.7.2.4.4 Shackles and rings

~~The Shackles shall be in accordance with C.11.1 and the following apply: shackles design standard shall be additional requirements for offboard lifts:~~

- ~~Grade 8 according to U.S. Fed. Spec RR-C-271 (Type IV – Grade B), or EN 13889 grade 8;~~
- ~~anchor) should be used, charpy v-notch tested to minimum 42J at -20 °C.~~

- ~~Anchor type (Bow shackle, H-) shackle should be used;~~
- ~~safety shackle (bolt and nut with split pin) shall be used;~~
- ~~ring design standard shall be EN 1677-4;~~

~~charpy test by minimum:~~

- ~~42J at -20 °C.~~

F.7.2.4.5 Chains

The following apply:

~~Chain slings should shall be welded Grade 8 short link chain according in accordance with C.16.1.1 and the following additional requirements for offboard lifts:~~

- ~~Documented Charpy v-notch tested to EN 818 minimum 42J at -20°C (27J at -20°C in fusion line).~~

~~Other grades of similar or better quality may be used if they satisfy requirements of a recognized standard applicable for lifting equipment and with documented Charpy values 42J at -20 °C (27 J at -20 °C in fusion line).~~

Formatert: Skrift: Fet, Engelsk (Storbritannia)

Formatert: Skrift: Ikke Fet, Engelsk (USA)

Formatert: Mellomrom Før: 0 pkt, Etter: 0 pkt, Punktmerket + Nivå: 1 + Justert ved: 0 cm + Innrykk ved: 0,63 cm, Tabulatorstopp: Ikke på 2 cm

Formatert: Ingen punktmerking eller nummerering

Formatert: Skrift: Ikke Fet, Engelsk (USA)

Formatert: Mellomrom Før: 0 pkt, Etter: 0 pkt, Punktmerket + Nivå: 1 + Justert ved: 0 cm + Innrykk ved: 0,63 cm, Tabulatorstopp: Ikke på 2 cm

Formatert: Skrift: 11 pkt, Fet, Engelsk (Storbritannia)

Formatert: Ingen understreking

Formatert: Ingen punktmerking eller nummerering

F.7.2-4.6 Rings

Rings shall be in accordance with C.16.4.1 and the following additional requirements for offboard lifts:

- Documented Charpy v-notch tested to minimum 42 J at -20 °C (27J at -20°C in fusion line).
- Other grades of similar or better quality may be used if they satisfy requirements of a recognized standard applicable for lifting equipment and with Charpy values as specified herein;
- documented Charpy values/temperature: 42 J/- 42J at -20 °C (27 J/-27J at -20°C in fusion line).

F.7.3 Examples of calculations

F.7.3.1 Lifting point load

Heaviest loaded lifting point will normally be the point closest to COG. This point will have a maximum vertical reaction for design, P_{LP}, as illustrated by Figure F.4.

4 part sling arrangement

3 part sling arrangement

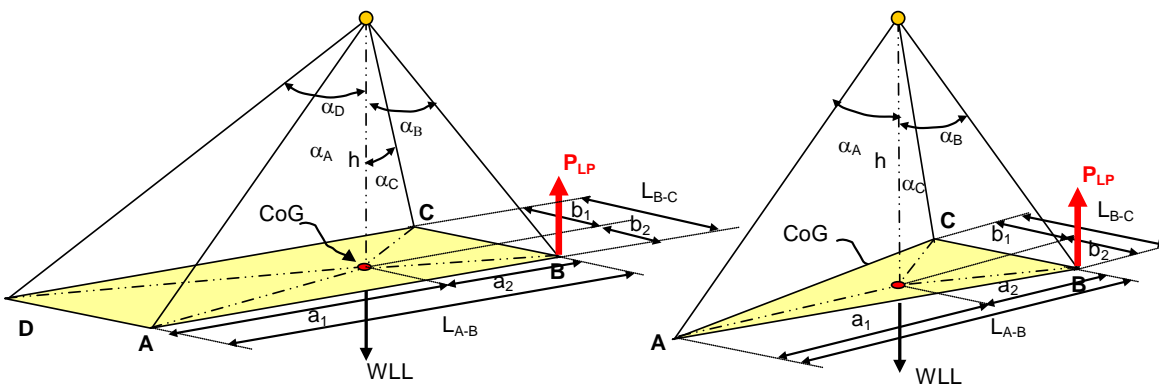

Figure F.4 - Heaviest loaded lifting point B, with vertical reaction P_{LP}

4-point lift

For a 4 point simply symmetrical lift with b₁ > b₂ and a₁ > a₂ as illustrated in Figure F.4, the vertical reaction P_{LP} may be expressed by the equilibrium equation as follows:

For a 4 point non-symmetrical lift a more detailed analysis is recommended.

$P_{LP} \approx$	$\frac{WLL \cdot b_1 \cdot a_1 \cdot W_{COG} \cdot SKL \cdot DAF}{L_{A-B} \cdot L_{B-C}}$	(F.4)
------------------	---	-------

3-point lift

For a 3 point non-symmetrical lift, with b₁ > b₂ and a₁ > a₂ as illustrated in Figure F.5, the vertical reaction P_{LP} in heaviest loaded point B may be found by equilibrium as follows:

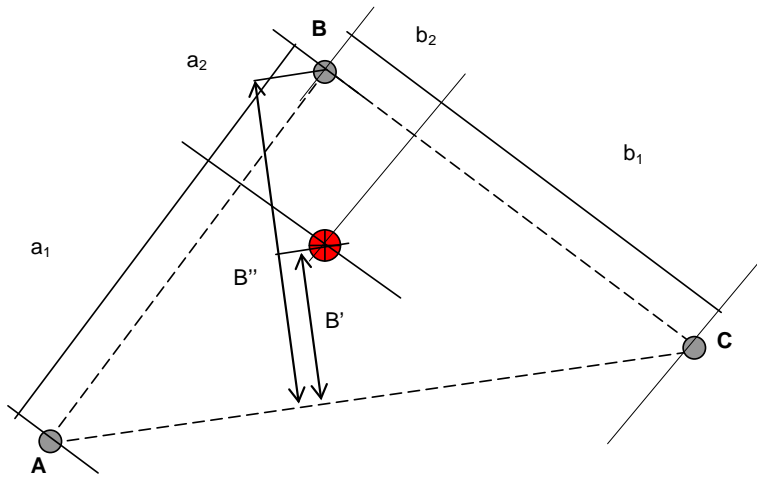

Figure F.5 - 3-point lift - Vertical design reaction P_{LP}

$$P_{LP} \approx \frac{WLL \cdot B' \cdot W_{COG} \cdot SKL \cdot DAF}{B''} \quad (F.5)$$

2-point lift

For a 2 point non-symmetrical lift, with $L_1 < L_2$ as illustrated in Figure F.6, the vertical reaction P_{LP} in heaviest loaded point B may be found by equilibrium as follows:

D

$$P_{LP} \approx \frac{WLL \cdot W_{COG} \cdot SKL \cdot DAF \cdot L_2}{(L_1 + L_2)} \quad (F.6)$$

1-point lift

For a 1 point **non-symmetrical** lift, the vertical reaction P_{LP} may be found as follows:

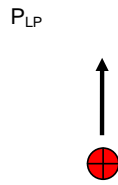

Figure F.7 - 1-point lift - Vertical design reaction P_{LP}

$$P_{LP} \approx WLL \cdot DAF \quad (F.7)$$

F.5.3.2 Required Shackle Size

Determination of required shackle:

F.7.3.2 Required shackle size

Determination of required shackle:

$$MBL_{SHACKLE} \geq \frac{P_{LP} \cdot \gamma_{Rm} \cdot DF}{\cos \alpha_B} \quad (F.8)$$

where $\gamma_{Rm} = 1,8$ for shackles.

The rated WLL for the shackle will then be:

$$WLL_{Shackle} \geq MBL_{shackle} / SF_m$$

where SF_m is the safety factor as specified by the shackle manufacturer.

The WLL of ~~shackles~~ shackles (marked on the shackle) shall not be less than the static sling force in each leg of a lifting set resulting from the weight of the lifted object.

F.7.3.3 Required slings

The sling leg(s) shall be selected on the basis of minimum breaking load MBL in (F.9):

$$NORSOK \text{ standard } MBL_{SLING} = \frac{P_{LP} \cdot \gamma_{Rm} \cdot DF}{\cos \alpha_B \cdot \gamma_e} \quad (F.9) \quad \text{Page } 99$$

where γ_{Rm} and γ_e is given in F.7.2.3.7 and F.7.2.3.6, respectively.

Note When ordering slings it should be noted to the manufacturer that end termination factor is included in the calculations.

F.7.3.4 Master link and top link

Required master link and top link to be selected from supplier catalogue on the basis of minimum breaking load.

$$MBL_{ML} \geq WLL \cdot DAF \cdot DF \cdot \gamma_{Rm} \quad (F.10)$$

F.7.4 Marking of lifting sling sets

Lifting sling sets shall be marked with the following information:

- Manufacturer's identifying mark;
- Numbers and/or letters identifying the sling with the certificate required by Annex C;
- The working load limit (according to this standard);
- Any legal marking (e.g. CE-marking where Machinery Directive applies);
- "Offboard lift"
- Reference to a rigging design drawing with specified sling angles for the lift

The marking tag and its means of attachment to the sling assembly required shall be made of corrosion resistant material. The total weight of the tag and its means of attachment to the sling assembly should have a mass of less than 70 g.

F.7.5 Design load for lifting lugs and supporting structure

Determination of design load:

$$P_P = \frac{P_{LP} \cdot DF}{\cos \alpha_B} \quad (F.11)$$

Lifting lugs shall be designed with a minimum lateral load of $0.05 \cdot P_P$ (3 deg offset) acting at the centre of the shackle bow.

Reference is given to Annex J for proof of competence for lifting lugs.

F.7.6 Alternative selection of lifting sets

As an alternative to detailed calculation and certification of lifting sets according to the requirements stated in this standard, wire rope slings according to EN 13414-1 or chain slings according to EN 818-4, grade 8, or other recognised standards can be used for offshore lifting of group F5 items by applying a dynamic reduction factor R_{DAF} to the lifted weight:

$$R_{DAF} = 0,73 + 0,27 \cdot \sqrt{\frac{50}{Lifted\ weight}} \quad (F.12)$$

Table F.5 can be used for determination of the minimum working load limit WLL_{min} of the lifting set for the lifted object.

Table F.56 - Enhancement factor

Lifted weight (tonnes)	Dynamic reduction factor R_{DAF}	Min required working load limit (WLL _{min})
0,5	-	4,0
1,0	-	4,0
1,5	-	4,0
2	2,08	4,16
4	1,68	6,74
6	1,51	9,06
8	1,41	11,24
10	1,33	13,34
12	1,28	15,37
14	1,24	17,36
16	1,21	19,32
18	1,18	21,24
20	1,16	23,14
22	1,14	25,01
24	1,12	26,87
26	1,10	28,71
28	1,09	30,54
30	1,08	32,36
32	1,07	34,16
34	1,06	35,95
36	1,05	37,74
38	1,04	39,51
40	1,03	41,27
42	1,02	43,03
44	1,02	44,78
46	1,01	46,53
48	1,01	48,27
50	1,00	50,00

F.7.7 Materials and fabrication

Materials selection and fabrication shall be performed in accordance with 5.22.

F.7.8 Testing and documentation of lifted ~~objects~~ objects

Lifted objects need not be tested.

Fixed or detachable dedicated lifting points mounted on an object (e.g. machines, unit, structures etc.) are not subject to certification by an enterprise of competence according to NORSOK R-003 Annex H or R-005 Annex E, unless they are intended for repeatedly detachment and reuse.

Lifted objects shall be accompanied by a statement for lifting, issued by the manufacturer of the lifted object. The statement for lifting shall contain at least the following information:

- manufacturers name and address;
- identification of the lifted object and its lifting points;
- – “NORSOK R-002-F5 Offboard Lift” (when applicable);
- ~~“NORSOK R-002-F5”;~~
- ”
- maximum gross mass of the lifted object, in kg;
- reference to a rigging design drawing with specified sling angles for the lift;
- a sentence declaring that the lifted object and its lifting points are designed, manufactured and inspected for lifting;
- any limitations related to lifting operation;
- name and position of person ~~authorised~~authorized to sign the statement;
- date and signature.

Annex G (Normative) Cranes

G.1 General (Group G)

The requirements of this annex apply in addition to the requirements stated in Clause 1 to Clause 5.

G.2 Group overview

An overview of the crane groups is presented in Table G.1

Table G.1 – Crane overview

Group no.	Group
G1	Mobile cranes
G2	Tower cranes
G3	Slewing jib cranes
G4	Bridge and gantry cranes
G5	Offshore cranes
G6	Floating cranes
G7	Winches and hoists - Power driven winches - Power driven hoists - Manrider winches
G8	Loader cranes
G9	Cable cranes
G10	Hand powered hoists and trolleys
G20	Other cranes

G.3 Design criteria

G.3.1 Design loads

Design loads for cranes shall be applied in accordance with 5.7 and standards referred to within this annex, whichever gives the most stringent requirement.

The design load shall be established reflecting the maximum operating load, both static and dynamic, to be applied for design calculations.

For load combinations reference is also given to DNV Standard for certification No. 2.22 Lifting Appliances,

G.3.2 Operating temperature limits and inclination angles

Cranes shall be designed to operate in a minimum operational temperature of -20 °C unless otherwise agreed or specified in standards referred to in this annex.

The minimum and maximum operating temperature (T_{Omin} and T_{Omax}) is the minimum and maximum environmental temperature for normal operation of the crane, where all effects of high and low temperatures have been taken into account.

G.3.3 Inclination angles

Cranes used onshore shall be designed for a minimum inclination from the horizontal of 1° in all directions.

Formatert: Skrift: Fet

Cranes used offshore shall be designed for a minimum inclination from the horizontal according to Table G.2.

Table G.2 – Inclination angles

Location	Inclination angle	
	Heel	Trim
Bottom fixed installations, tension leg platforms, jack-ups and submersibles (fixed)	1°	1°
Semi submersible/ jack-up (floating)	3°	3°
Barges of length less than 4 times breadth	3°	2°
Ships and vessels having shipshape hull properties	5°	2°

The resulting maximum inclination from heel and trim of the installation for which the crane is designed, shall be taken into account in the design loads and shall be stated in the information for use.

G.3.4 Horizontal loads due to operational motions

For cranes mounted on floating units or vessels, horizontal loads due to operational motions are

- a) inertia forces due to acceleration or deceleration of horizontal motions,
- b) centrifugal forces,
- c) forces transverse to rail resulting from reeling and skew motion,
- d) buffer loads.

The horizontal loads shall be taken into account in the design loads.

G.3.5 Wind loads

Cranes located outdoor in exposed areas shall be designed for loads due to wind in accordance with EN 13001-2. The wind velocities shall unless otherwise agreed between the buyer and the manufacturer, be taken as follows:

- a) 25 m/s for in service;
- b) 63 m/s for out of service.

NOTE These wind velocities are to be understood as a 3 s gust wind. Wind velocities are often given as 10 min mean wind velocity. A 3 s gust wind velocity of 25 m/s will correspond to about 17 m/s 10 min mean wind velocity, but may depend on surrounding structures on the platform.

G.3.6 Fixed load lifting attachments

Fixed load lifting attachments such as wire rope terminations, shackles, swivels, hooks and similar components shall be designed and equipped to minimize the risk of unintended entanglement.

NOTE This requirement can be met by a "slim and rounded" geometry, avoiding sharp edges/ protruding (extended) parts or installing additional protection such as plastic cones on wire rope terminations. Reference is made to 5.4.9.

Lifting accessories used in cranes shall comply with the requirements of Annex C.

G.3.7 Lifting of persons

~~For the lifting of persons, the methods of decreasing the probability of failure in accordance with EN 13135-2, 5.12.3.2, shall be applied.~~

~~The risk coefficient γ_n for cranes designed for the lifting of persons, shall be minimum 1,5.~~

~~The required performance level for cranes lifting personnel shall be d in accordance with ISO 13849-1.~~

~~See also item 5.9 and annex K High risk applications~~

~~Text in this Clause has been deleted. Requirements are given in Clause 5.1.2~~

G.3.8 Cranes for temporary use offshore

Powered cranes intended for temporary use on an offshore installation shall also comply with NORSOK Z-015.

G.4 Cranes with emergency operation system (EOS)

For cranes equipped with EOS in accordance with 5.15.3 the EOS shall have means to control the main functions of the crane (i.e. hoisting/lowering, luffing, slewing, telescoping, travelling), in case of an emergency where it is necessary to continue the lifting operation and secure the load and the crane, if a single failure has occurred in the normal operation system, see Figure G.1.

The EOS shall be initiated and controlled from the control station, with operator view to the crane and the load. The EOS shall be capable of handling all loads within the rated capacity.

The manual controls of the EOS shall be "hold to run" and shall be clearly and permanently marked.

Only one motion need to be operational at a time.

An emergency stop device for the EOS which shut off the emergency power supply and stops all motions shall be in reach of the crane operator at the control station.

The EOS shall be operational within 1 min from standstill of the normal operation system, and the crane operator has initiated the EOS.

With reference to the schematic representation of EOS in Figure G.1, the EOS shall as a minimum comprise emergency manual controls, emergency power control elements, and an emergency power supply. These elements including their means of connections shall be additional to and independent of the main power and control system.

Duplication of elements in the normal operating system will fulfil the requirement of an EOS if it can be documented and proven that the normal operating system is fully redundant of any single failure in these elements.

During operation of the EOS, limiting and indicating devices, as well as protective systems, need not be available. However, emergency stop shall be available during operation of EOS.

The aim of the EOS shall be to operate the crane at reduced speed in an emergency situation regardless of any single failure of the main functions of the crane, except for failures in working parts, power transmission elements and machine actuators, where it is beyond state of the art to provide an EOS. Examples are winches, brakes and hydraulic cylinders.

← **Formater:** Mellomrom Etter: 10 pkt,
Linjeavstand: Flere 1,15 li

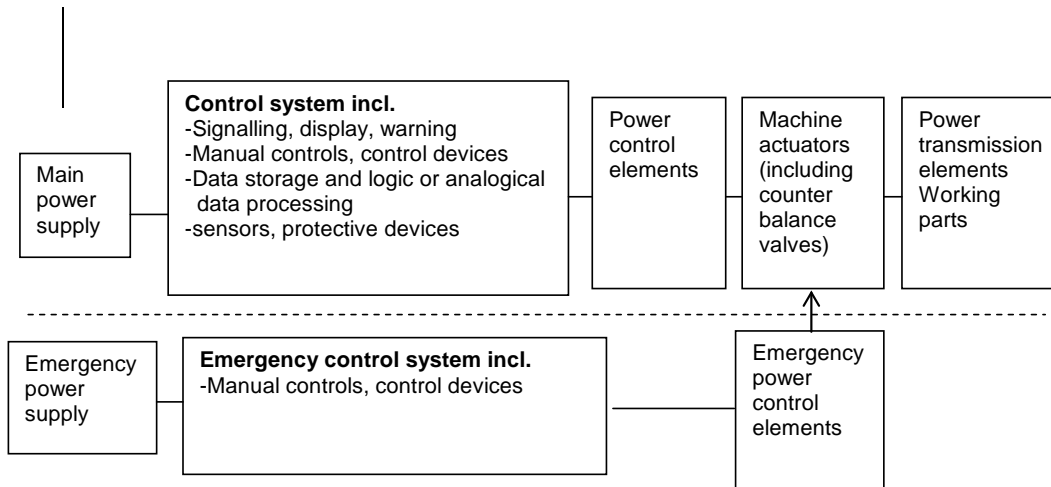

Figure G.1 Schematic representation of EOS

NOTE For terminology, see EN ISO 12100.

G.5 Emergency stop

All power driven cranes, winches and hoists shall be equipped with an emergency stop function in accordance with EN ISO13850.

G.6 Main switch

All power driven lifting appliances shall be equipped with a lockable main power supply isolation device, e.g. valve or switch.

G.7 Mobile cranes (Group G1)

The design shall be in accordance with EN 13000, taking into account the additional design criteria given in G.43.

G.8 Tower cranes (Group G2)

Tower cranes shall be designed in accordance with EN14439, taking into account the additional design criteria given in G.43.

G.9 Slewing jib cranes (Group G3)

Slewing jib cranes shall be designed in accordance with EN14985, taking into account the additional design criteria given in G.43.

Loader cranes in accordance with EN 12999 mounted on a fixed foundation may also be used as slewing jib cranes, provided the requirements in G.14 are fulfilled.

G.10 Bridge and gantry cranes (Group G4)

G.10.1 Design

Bridge and gantry cranes shall be designed in accordance with EN 15011, taking into account the additional design criteria given in G.43.

For bridge and gantry cranes used in the drilling area, the requirements of Annex D also apply.

G.10.2 Machinery

Hoist and travelling machinery shall have completely enclosed and sealed gearboxes with oil bath lubrication.

Cranes on floating installations and vessels shall be furnished with rack and pinion drives and parking brakes for travelling.

G.10.3 Brakes

Brake adjustment mechanisms shall be protected against inadvertent use.

G.10.4 Access

The crane shall be designed with facilities for easy inspection and maintenance. Permanent access platforms shall be provided for inspection and maintenance of electrical motors, main electrical cabinets and hoist machinery.

Grease lubrication points shall be centralized where possible and accessible from walkways and access platforms.

G.10.5 Weather protection

Machinery on cranes permanently located outdoor shall be protected against exposure to rain, snow, wind and sun.

G.10.6 BOP and X-mas tree cranes

For BOP and X-mas tree cranes, see D.5.

G.10.7 Anti collision protection

Where there is a risk of collision between cranes running on the same rails, system for detection/motion limiters, proximity warning and automatic ramp down and stop of relevant motions shall be installed.

G.11 Offshore cranes (Group G5)

G.11.1 Size and capacity

Offshore cranes shall be capable of offboard lifting with relevant loads in accordance with crane study according to Annex B clause B.6 ~~at significant wave height of 6m and 25 m outreach. In normal operation at significant wave height $H_s = 0$. Unless other capacities are justified by the offshore crane shall as a study, the following minimum be able to lift a load of 15 tonnes at a horizontal distance of 32 m from the side of the installation, measured at sea level. requirements apply;~~

- The crane shall be able to lift a load of 15 tonnes from a supply vessel at a horizontal distance of 32 m from the outside of the installation, measured at sea level, at a significant wave height $H_s = 0$ m.
- The crane shall be able to lift a load of 5 tonnes from a supply vessel at a horizontal distance of 25 m from the outside of the installation, measured at sea level, at significant wave height $H_s = 6$ m.

Formatert: Engelsk (Storbritannia)

Formatert: Engelsk (Storbritannia)

Formatert: Engelsk (Storbritannia)

Formatert: Engelsk (Storbritannia)

The number, location and size of offshore cranes at an installation shall be compatible with B.5, B.6 and B.7.

The number of offshore cranes on each installation shall reflect any need of redundancy or overlap for crane coverage at normal operation and emergency operation of the installation if the cranes are part of the emergency preparedness plan.

The location of offshore cranes at the installation shall be selected to ensure optimal working conditions for the crane, the crane operator and avoid blind zones. The location shall be close to the outer edge of the deck area and such that the sight from the control station is unobstructed towards lay down areas and the sea surface where supply vessels are likely to be positioned. If necessary the height of the crane and crane cabin above the loading areas shall be increased in order to ensure optimal working conditions for the crane and the operator.

It is essential for safe operation of an offshore crane that the selected size provides safe working conditions regarding loads and radius for all operations. In particular, the radius for operation of offshore lifts shall be

sufficient to ensure sufficient horizontal clearance between the loading area at sea level and the structure of the installation.

G.11.2 Design

General purpose offshore cranes shall be in accordance with EN 13852-1, taking into account the additional design criteria given in G.3 and the following subclauses.

Offshore cranes shall be designed for 20 years of service life, minimum.

NOTE Reference is made to 5.8.
Typical service hours for offshore cranes on installations without drilling: 500 h/year to 1000 h/year
Typical service hours for offshore cranes on installations with drilling: 2000 h/year to 4000 h/year
Service hours include idle running.
Typical number of lifts is 10 lifts per hour.

G.11.3 Access

Offshore cranes shall be equipped with a main access route and a separate alternative escape route from the cabin/machinery house and to the deck of the installation. The main access route shall have ~~stairway~~ ladders/stairs between different levels and be designed for the transport of supplies and spares, and in an emergency to facilitate transport of a stretcher, smoke diving and ~~fire-fighting~~ firefighting equipment.

Fixed means of access according to EN 13586 shall be provided to areas of the crane requiring regular prescribed maintenance and inspection. For access between different levels externally on the crane, stairs should be used instead of ladders.

Walkways of type 1 in accordance with EN 13586 shall be provided for access to crane boom.

A service platform shall be provided for safe access when changing the configuration of the crane, replacement of wire ropes and sheaves etc.

G.11.4 View from the control station

The control station shall be arranged with the aim to give unobstructed view for the crane operator of the working area with the boom and the hook in any position. Any equipment, such as rated capacity indicators, camera monitors, window wipers, window protection bars, etc. shall be so located and arranged to reduce this view as little as possible.

NOTE This implies that metal grids in front of windows, ~~is~~ are not accepted.

The window wiper system shall be robust and suitable for a marine environment. Wipers on front window shall be oriented vertically and move horizontally and be able to keep at least 80 % of the window area clean from water and spray.

G.11.5 Control station outfitting

The control station shall be equipped with an ergonomic chair for the operator with easy adjustments for optimal view and individual comfort. The main controls shall follow the movements of the chair.

Other controls and switches shall be located within the recommended reach for hands and feet. A second seat shall be provided for an instructor or a trainee.

G.11.6 Video camera (CCTV)

~~In order to allow overview of the suspended load and its surroundings from the crane operator's cabin, one or more cameras shall be mounted in the boom head in order to display a live picture in the crane operator's cabin. The live picture in the cabin shall be displayed on a different screen than the rated capacity indicator, without obstructing the view significantly. It shall be possible to zoom in and out on the load at all lifting heights.~~

NOTE Clause removed, requirement covered in EN 13852-1.

G.11.7 Data recorder

A data recorder shall be installed for continuous logging of main operational data for the purpose of

- a) tracking of events, e.g.:
 - 1) overload,
 - 2) changes in operational parameters,
 - 3) alarm and acknowledge history.
- b) condition monitoring,
- c) fatigue assessment.

For tracking of events essential parameters (e.g. load, motion, speeds, position, limits, brake status, pressures, operator commands and alarm status) shall be continuously recorded. The recording system shall contain data for at least 30 calendar days.

For condition monitoring and fatigue assessment, the recorded data shall be continuously accumulated from day one and during the complete lifetime of the crane. It should be possible at any time for user to display status for condition monitoring and fatigue assessment of the crane. The data may be compressed for the purpose of limiting the necessary storage capacity.

A back-up copy of the data should frequently be stored independently.

G.11.8 Data remote access

A remote access system should be installed for access to

- a) condition monitoring,
- b) recorder files,
- c) monitoring of control system,
- d) update and backup of control system software.

Data should be continuously collected, processed and stored. A back-up copy of the data should be stored independently.

It should be possible at any time for user to download status and report for condition monitoring of the crane.

G.11.9 Wind speed indicator

~~The wind speed indicator in the control cabin shall include facility for displaying the 3 sec. gust wind and 10 min mean wind speed.~~

~~The wind speed sensor should be located in the boom head or on top of crane superstructure~~

NOTE Clause removed, requirement covered in EN 13852-1.

G.11.10 Warning horn

~~A warning horn shall be provided outside the crane at the control station for manual activation by the crane operator in emergencies etc. The warning horn shall have a sound level sufficient to attract the attention of people located at the loading areas of the crane during normal noise levels from the surroundings.~~

NOTE Clause removed, requirement covered in EN 13557 which is referred to in EN 13852-1.

G.11.11 Hook and block ~~protection device~~

Where there is a hazard of hooks or hook blocks to come into contact with the crane boom due to wind oscillations etc., the boom shall be provided with buffers or similar protection device to prevent damage to the boom structure.

Hooks, hook blocks and ball weight/swivel weight shall be coloured with an easily visible colour.

G.11.12 Rigging detection system

Cranes with the option for various rigging of the load hoist (i.e. single and multiple fall), shall be provided with an automatic detection system which give feedback to the control and safety system of the rigging configuration. The automatic detection system shall ensure that the setting of the control and safety system comply with the actual crane configuration.

G.11.13 Location of emergency stop

Emergency stop control device shall be arranged for rapid and unobstructed activation and shall be located at the right hand side of the operator.

G.11.14 Location of MOPs manual control

MOPs manual control device shall be arranged for rapid and unobstructed activation and shall be located at the left hand side of the crane operator.

G.11.15 AOPS simulation and testing

The characteristics of the AOPS system shall be analysed and documented by a simulation programme. The programme shall provide realistic representation of main elements that influence the AOPS response time and forces in an overload situation, e.g. crane stiffness, wire rope elasticity, hydraulic and electric components, moments of inertia from winches and gears, damping of hydraulic systems, load excitation etc.

The response time of the AOPS shall be verified by testing.

The AOPS system shall have a built-in test facility which enables the system to be tested automatically by the system at start up or by the crane operator at suitable intervals, without physical changes of the crane. The status of the test shall be displayed to the crane operator. During testing it shall not be possible to operate the crane. The test shall include time measurement of measurement of system activation, from overload signal is initiated to the AOPS power control (load control) element is fully activated.

G.11.16 Hook velocities

The minimum required hook velocities are defined in three independent directions, related to the cranes global coordinato system:

- Vertikal hook speed, V_H
- Lateral hook speed, V_L
- Radial hook speed, V_R

Formatert: Skrift: 11 pkt

Formatert: Skrift: 11 pkt

Vertical hook speed:

The minimum required vertical hook speed shall be:

$$V_H = K_H * \sqrt{V_D^2 + V_C^2} \text{ m/s}$$

(G. in

accordance with the requirements of EN 13852-1)

Formatert: Skrift: 11 pkt

Formatert: Skrift: 11 pkt

where K_H is a velocity factor according to Table G.3.

The minimum vertical hook speed (V_H) shall be achieved when operating the following mechanisms:

- hoisting mechanism only, and
- hoisting mechanism and luffing mechanism simultaneously.

Formatert: Ikke juster avstand mellom asiatisk og latinsk tekst, Ikke juster avstand mellom asiatisk tekst og tall

Formatert: Skrift: 11 pkt

Formatert: Skrift: 11 pkt

Radial hook speed:

The minimum required radial (V_R) hook speed shall be:

$$V_R = K_R * \sqrt{V_D^2 + V_C^2} \text{ m/s} \tag{G.2}$$

Formatert: Ikke juster avstand mellom asiatick og latinsk tekst, Ikke juster avstand mellom asiatick tekst og tall

where K_R is a velocity factor according to Table G.4 specified for heavy duty shall be applied.

Formatert: Skrift: 11 pkt

Radial hook speed

Formatert: Mellomrom Før: 6 pkt, Etter: 6 pkt, Tabulatorstopp: 1,5 cm, Left

The minimum required radial hook speed shall be achieved under the following conditions:

Formatert: Skrift: 11 pkt

- at a radius of 3/4 of the maximum radius or 30 m radius, whichever is the longest radius, and
- as an average speed through a range of maximum to minimum shall be measured in both directions, with and without load at rated capacity, at running start, measured between 5 meters before and 5 meters after that radius.

Formatert: Ingen punktmerking eller nummerering

The minimum

NOTE The rated capacity is to be taken as R_n according to EN 13852-1.

The minimum required radial hook speed may be obtained from operating a single mechanism, or a combination of any mechanisms with a speed component in the radial direction.

Lateral hook speed:

The minimum required lateral hook speed (V_L) shall be:

$$V_L = K_L * \sqrt{V_D^2 + V_C^2} \text{ m/s} \tag{G.3}$$

where K_L is a velocity factor according to Table G.4.

The minimum lateral hook speed shall be achieved when slewing at a radius of 3/4 of the maximum radius or 30m, whichever is the longest radius.

Speed parameters

V_D and V_C are to be taken from EN 13852-1.

Table G.3 — Velocity factor K_H

	Single fall reeving	Multiple fall reeving
No hook load	0,78	0,40
At rated capacity	0,50	0,28

Table G.4 — Velocity factor K_R and K_L

	K_R	K_L
Any hook load	0,20	1,0

It shall be possible to operate vertical, radial and lateral crane movements simultaneously. When operating simultaneous movements, any change in speed shall not result in sudden changes in other movements.

For the purpose of calculating the minimum required lateral and radial hook speeds, the maximum wave height for which the crane is designed shall be used. The actual radial and lateral hook speeds shall depend on the chosen reeving configuration or significant wave height.

Formatert: Mellomrom Før: 6 pkt, Etter: 6 pkt, Tabulatorstopp: 1,5 cm, Left

G.11.17 Anti collision protection

Where there is a risk of collision between movable parts of offshore cranes and stationary equipment or fixed structures, system for detection/adjustable motion limiters, proximity warning and automatic ramp down and stop of relevant motions shall be installed.

Where there is a risk of collision between movable parts of offshore cranes and other cranes, system for detection/adjustable motion limiters, proximity warning and automatic ramp down and stop of relevant motions should be installed.

G.11.18 Subsea operations

Offshore cranes intended for handling of loads sub-sea shall be specially designed for such operations and shall fulfil the requirements of G.12.4.

G.11.19 Rescue boat lifting operations

Offshore cranes intended for rescue boat lifting operations shall have hoisting speed not less than required in G.11.16 for rated capacity when lifting goods with single fall reeving. The hoisting speed shall be available for the actual weight of the rescue boat intended to be lifted.

For offshore cranes intended for rescue boat lifting operations, the requirements of 5.8-610.2 in EN 13852-1 are to be replaced by the requirements of 5.15 and G.4

The dynamic load chart shall include rescue boat operations from $H_s = 0$ m to $H_s = 6$ m.

The dynamic load chart for training and maintenance operations shall be calculated for sea states from $H_s = 0$ m to $H_s = 3$ m using load effects in accordance with EN 13001-2. Such operations are considered as load combinations A and B, ref. Table 10 of EN 13001-2, taking into account partial safety factors $\gamma_p = 1,34$ and $1,22$, respectively, a dynamic coefficient $\Phi_2 = 2,5$ and a risk coefficient $\gamma_n = 1,5$.

The dynamic load chart for emergency (real rescue) operations shall be calculated for sea states from $H_s = 3$ m to $H_s = 6$ m using load effects in accordance with EN 13001-2. Such operations are considered as load combination C, see Table 10 of EN 13001-2, taking into account partial safety factor $\gamma_p = 1,1$, a dynamic coefficient $\Phi_2 = 3,0$ and a risk coefficient $\gamma_n = 1,5$.

NOTE The dynamic coefficients of 2,5 and 3,0 are related to lifting in $H_s=3$ m and $H_s = 6$ m, respectively, and take into account the use of an elastic pendant in accordance with Annex A. The dynamic factors given for such elastic pendants do not take into account any favourable effect of the cranes own elasticity or damping. The favourable effects resulting from the combination of crane and pendant properties may be taken into account provided the total elasticity of crane and pendant is documented by calculations. Alternatively an elastic pendant with better elastic properties may be specified as a condition for the resulting load chart.

G.11.20 Instructions for lifting rescue boat with offshore cranes

The crane shall be equipped with a detailed instruction for rescue boat operations.

The dynamic load chart shall clearly state the conditions upon which it is based and, if relevant, the type and specification of the elastic pendant sling that is to be used.

The dynamic load chart shall differentiate between training operations and emergency operations.

NOTE In an emergency where the offshore crane is to be used for handling the rescue boat, it is to be noted that this operation has to be authorised by the installation management in each case. In an emergency situation the operational risks as well as the technical risks for the rescue team have to be balanced against the actual conditions and the probability of a successful rescue operation.

G.11.21 Emergency operation system (EOS)

All offshore cranes shall have an emergency operation system in accordance with G.4, regardless of installation or duty. The EOS shall be activated and operated from the crane cabin. The EOS system shall be available for operation at all times unless confirmed gas has been detected at the crane.

G.11.22 Interface to installation emergency systems

The crane shall be connected to the PA system, emergency alarm system, and the fire and gas detection system on the installation.

A PA loudspeaker shall be located in the crane cabin. An indicator panel for the fire and gas status on the crane and its surrounding shall be installed in the crane cabin. A single fire or gas detection shall give an alarm at the indicator panel in the crane cabin.

Installation emergency alarms shall be installed in the machinery house.

Fire and gas

~~Gas detectors shall be installed in or at the air inlets to the crane cabin and combustion engines, and to enclosed areas of the crane, e.g. the machinery house and pedestal combustion engines. Fire detectors be installed in machinery house and cabin.~~

Formatert: Engelsk (USA)

Formatert: Engelsk (USA)

Formatert: Engelsk (USA)

Formatert: Engelsk (USA)

Combustion engines shall be equipped with inlet air shut down valve to prevent engine over speeding. ~~Air inlet systems~~ Air vents on tanks containing diesel shall be equipped with flame arresters. Exhaust systems shall be equipped with flame arresters and spark arresters.

~~Confirmed gas detection shall activate an immediate isolation of all potential ignition sources of the crane, unless the crane is in operation.~~

~~If a crane designed for operation in Zone 2 is in operation, confirmed gas detection shall initiate a shut down alarm in the crane cabin and a delayed shut down and ignition source isolation of the crane after a period of maximum 10 s. It shall be possible for the crane operator to postpone the shut down and the ignition source isolation, if this is considered necessary to terminate a critical lifting operation or use the crane for rescue operations.~~

G.11.23 Shutdown system

~~When the offshore crane is out of service the following requirements shall be complied with:~~

- ~~• Upon single low gas alarm, at any location on the installation, an automatic isolation of the offshore crane (within response time as specified in NORSOK S-001) shall be initiated.~~
- ~~• Inhibit start of offshore crane shall be initiated; start of offshore crane shall not be possible before the area is cleared.~~
- ~~• The offshore crane is in this condition considered to be naturally ventilated.~~

~~When the offshore crane is in service the following requirements shall be complied with:~~

- ~~• Upon single low gas alarm, at any location on the installation, the offshore crane operator shall immediately take the crane into a safe position, secure the load and make a manual shut down.~~
- ~~• Inhibit start of crane shall be initiated. Start of offshore crane shall not be possible before the area is cleared.~~
- ~~• Upon confirmed gas detection at any location on the installation, an automatic shutdown of the offshore crane (within response time as specified in NORSOK S-001) shall be initiated.~~

~~The offshore crane is considered to be mechanically ventilated in this condition.~~

Reference is made to NORSOK S-001, Table 2, Crane (engine and cabin), Comment D.

Formatert: Mellomrom Før: 6 pkt, Etter: 6 pkt, Tabulatorstopp: 1,5 cm, Left

Formatert: Engelsk (USA)

Formatert: Skrift: 12 pkt, Fet

G.12 Floating cranes (Group G6)

G.12.1 Size and capacity

Reference is made to the relevant parts of the requirements given for offshore cranes in G.12.1.

G.12.2 Design

Floating cranes shall be in accordance with EN 13852-2.

For non-slewing cranes (e.g. A-frames etc.), applicable parts of EN 13852-2 apply.

In addition, floating cranes shall fulfil the requirements in G.11.2.1 including G.5.2.8 and the following.

G.12.3 Location of emergency load release system (ELRS) manual control

ELRS control device shall be arranged for rapid and unobstructed activation and shall be located at the left hand side of the crane operator. Reference is made to EN 13852-2, 5.7.1.

G.12.4 Lifting appliances for subsea operations

G.12.4.1 General

Lifting appliances intended for ~~sub-sea~~subsea operations shall be specially designed for such operations and shall fulfil the requirements in G.12.4.2 to G.12.4.11.

G.12.4.2 Sea water penetration and corrosion

The design shall minimise the sea water penetration and corrosion effects on hooks, swivels, lifting accessories, hoisting ropes, winches, etc. that are exposed to sea water.

G.12.4.3 Load hoist drum

The hoisting drum shall be designed according to DNV Standard No. 2.22 Certification of Lifting Appliances, Ch.2 Sec.5 B200 to withstand the additional forces on flanges and drum due to long lengths of hoisting rope used for subsea lifting for the load effects due to weight of hoisting rope, rope tension and the maximum number of windings of the rope onto the drum.

G.12.4.4 Rated capacity indicator

The rated capacity indicator shall continuously compensate for the net (submerged) weight of the rope and lifting accessories suspended by the crane.

G.12.4.5 Tensioning and compensation systems

A rope tensioning and/or heave compensation system shall be installed. The chosen system (s) shall be designed for the specific subsea operations the crane is designed for.

Tensioning and compensation systems shall include wire rope heat and low cycle fatigue monitoring system due to kinetic energy.

G.12.4.6 Rope tensioning system

A rope tensioning system shall reduce the dynamic loads occurring during subsea operations, enable smooth landing and lift off from the seabed and avoid the hoisting ropes becoming slack.

G.12.4.7 Heave compensation system

A heave compensation system shall compensate relative motions between the crane and the seabed by automatically controlling the hook position relative to the seabed and enable smooth landing and lift off from the seabed and avoid the hoisting ropes becoming slack.

G.12.4.8 Performance level

Safety related parts of control systems for any active or passive rope tensioning or heave compensation systems shall where fitted, as a minimum comply with ISO 13849-1 required performance level d.

G.12.4.9 Subsea operation mode

The control station shall include a manually operated mode selection switch for ~~sub-sea~~subsea operations.

While ~~sub-sea~~subsea operation mode is selected, the ELRS/MOPS, AOPS and the rope tensioning/heave compensation systems shall be operative.

While the subsea operation mode is deactivated, AOPS and the rope tensioning/heave compensation system shall be deactivated.

Subsea operation mode shall be inhibited whenever the hooks are positioned over the installation deck area.

G.12.4.10 Automatic overload protection system (AOPS)

The crane shall be equipped with an automatic overload protection system (AOPS) that automatically protects the crane from overload during subsea operations.

AOPS may be combined with heave compensation system/rope tensioning system.

NOTE Overload may occur due to relative motions between the crane and the load, entanglement of hooks to adjacent equipment or hook fixed to the seabed, etc.

G.12.4.11 Instruction for use for subsea operations

The instruction for use shall include detailed instructions for subsea operations. In particular the following shall be addressed:

- a) each subsea lifting operation shall be separately risk assessed and planned. As a minimum the following shall be taken into consideration: weather conditions, lift off and landing areas, lifting routes, motion characteristics, splash zones, waves, tides and current, etc.;
- b) a dynamic load chart for ~~sub-sea~~subsea lifting shall be calculated for each separate lifting operation reflecting the weight, volume and shape of the lifted object, wave height and period, depth, current, vessel motions etc., and specific operational limitations;
- c) any operational limitations of rope tensioning or heave compensation systems (e.g. maximum or minimum stroke, pressures or velocities) shall be stated in the instruction for use in such a way to for the crane operator to limit or terminate the operation at specified limits. These limits shall reflect adequate safety margin for each lifting operation;
- d) the instruction for use shall include any general operational limitations and precautions concerning subsea lifting, and corresponding maintenance instructions for such service, including requirements for fresh water washing and cleaning of hook, blocks, ropes and drums etc. exposed to seawater after each operation;
- e) the instructions for use shall include detailed procedures and acceptance criteria for initial and periodic testing of any heave compensation, rope tensioning or ~~ASOPS~~AOPS system that are installed on the crane.

G.13 Power driven winches and hoists (Group G7)

G.13.1 Design of power driven winches

Power driven winches shall be in accordance with EN 14492-1, using the design criteria given in G.3.

Power driven winches shall be equipped with a visual indication of the actual load during lifting operation.

NOTE An analogue pressure gauge may satisfy this requirement. The accuracy of the indicating device may be within +/- 10 % of the rated capacity for winches with rated capacity less than 20 tonnes. For winches with rated capacity of 20 tonnes and more the tolerance may be within +/- 15 %.

If the winch operator is unable to see the winch from the operator position a drum motion indicator shall be arranged at the operator position.

Power driven winches where there is a hazard of incorrect wire rope spooling onto the drum, shall be equipped with a spooling device with a tensioning system to avoid rope wire on the drum ensure correct spooling.

Formatert: Engelsk (USA)

Formatert: Engelsk (USA)

Formatert: Engelsk (USA)

Formatert: Engelsk (USA)

Winches intended for ~~sub sea~~subsea operations shall comply with G.12.4.

NOTE Power driven winches in crane assemblies are covered by the applicable crane standards.

G.13.2 Design of power driven hoists

Power driven hoists shall be in accordance with EN 14492-2, using the design criteria given in G.3- and with the additional requirement that rated capacity limiters and indicators described in clause 5.2.2 in EN 14492-2 shall be provided regardless of rated capacity of the hoist.

G.13.3 Design of man rider winches

Man rider winches shall be designed in accordance with DNV Offshore standard DNV-OS-E101 Ch.2 Sec. 5 I using the design criteria given in G.3 (except for risk coefficient $\gamma_n=1,5$)

The following requirements apply in addition:

- a) the wire rope shall have a diameter of minimum 10 mm. The wire rope shall be of rotation resistance construction;
- b) the guidance note in Ch.2 Sec. 5 I 404.1 is not acceptable;
- c) the guidance note in Ch. 2 Sec. 5 I 207 is not acceptable;
- d) man riding winches shall have independent backup motion limiters in addition to those required by Ch. 2 Sec. 5 I 310 for both lowering and hoisting;
- e) a shackle shall be used for connection of wire rope to the man riding harness. The shackle shall have means of double locking;
- f) an emergency operation system (EOS) shall be provided in accordance with 5.15.3 and G.4 for immediate operation at power failure or failure in control system. A system operated only by hand power (e.g. crank system) may be acceptable if the requirements are fulfilled;
- g) emergency stop devices shall be provided at the operator positions. For remote operated winches, an additional emergency stop device shall be located at the winch;
- h) the hoisting and lowering speed shall be stepless variable not exceeding 1 m/s;
- i) manrider winches for operation in areas where there may be relative motions between the surroundings and the person being lifted shall have an automatic overload protection device to protect the person lifted from being exposed to pull forces exceeding 2.25 kN;
- j) an overspeed protection device shall be implemented to prevent free fall or excessive lowering speed without exposing persons or equipment to unacceptable accelerations.

Reference is also made to relevant parts of Annex C and Annex D for lifting accessories, man riding harness etc.

G.14 Loader cranes (Group G8)

Loader cranes shall be in accordance with EN 12999, using the design criteria given in G.3.

Motion limiters in accordance with EN 12077-2 shall ensure that overload of winch and/or wire rope is avoided.

Winches on loader cranes shall be in accordance with EN 14492-1.

G.15 Cable cranes (Group G9)

Cable cranes shall be in accordance with this NORSOK standard.

G.16 Hand powered hoists and trolleys (Group G10)

Hand powered hoists and trolleys shall be in accordance with EN 13157, using the design criteria given in G.3.

The safe functioning of hand powered hoists shall not be dependent upon the hoist being subjected to a minimum load.

Hand powered hoists shall have an overload protection device.

~~Brake pads~~The brake shall be applied by two independent mechanisms (pawls) to ensure brake function is activated. Each mechanism shall be able to transfer the forces necessary to stop and hold the load. The mechanism shall be protected against corrosion.

The chain end connection shall withstand the minimum breaking load of the chain.

Trolleys intended for floating installations shall have braking system to prevent unintended longitudinal travel. The braking system should be of the rack and pinion principle to match runway beams required in Annex H.

G.17 Other cranes (Group G20)

The design criteria stated in G.3 apply.

Mobile elevating work platforms shall be in accordance with EN 280.

Mast climbing platforms shall be in accordance with EN 1495.

Suspended access equipment shall be in accordance with EN 1808.

Lifting tables shall be in accordance with EN 1570-1.

Forklift trucks shall be in accordance with NS-EN ISO 3691-1, ISO 22915-1, and NS-EN 1755 as applicable.

For cranes used in drilling operations, reference is also made to the requirements in Annex D.

NOTE Powered slewing cranes mounted in a fixed installation (often referred to as "G20 cranes" in the industry) are covered by Group G3.

Annex H (Normative) Foundations and suspensions

H.1 General (Group H)

The requirements of this annex apply in addition to the requirements stated in Clause 1 to Clause 5. Foundations and suspensions are not regarded as lifting appliances. They are structural components/elements used for supporting or suspending the lifting appliance and is considered as the interface between a lifting appliance and general structure.

For verification requirements of the lifting equipment as a whole, reference is made to Clause 4.14.

Proof of competence for foundations and suspensions shall be in accordance with NORSOK N-004, taking into account loads, load factors and resistance factors described in this annex. EN 1993-6 may be used as a supplement for more detailed design of runway beams.

Fabrication of welded steel structures shall be performed in accordance with NORSOK M-101. Non-welded structures shall be fabricated in accordance with requirements in Clause 5.22.

H.2 Group overview

Group no.	Group	Definitions
H1	Runway beams	Monorails and beams including their fastening to structure for suspension of permanent or temporary lifting
H2	Lifting lugs	Lugs including their fastening to structure for suspension of permanent or temporary lifting equipment.
H3	Sheave brackets	Sheave brackets including their fastening to structure for suspension of permanent or temporary sheaves.
H4	Foundations	Structural or mechanical parts used as foundation for permanent or temporary mounted lifting equipment to structure.

H.3 Design factors

The factors relevant for lifting design are summarized in Table H.1.

Table H.1 - Factors relevant for lifting design

APPLICATION	TO FIND	Load factors			Resistance factor
		DAF	Design factor (DF)		γ_{Rm}
			γ_p	γ_c	
Suspension and foundation design	Design capacity	X	X	X	X

The design load is defined as: $P_p = SWL \cdot DAF \cdot DF$ (H.1)

The design factor DF is defined as: $DF = \gamma_p \cdot \gamma_c$ (H.2)

where

γ_p = partial load factor

γ_c = consequence factor

Table H.2 - Design factors (DFs)

ELEMENT CATEGORY	γ_p	γ_c	DF ($\gamma_p \cdot \gamma_c$)
Single critical elements of the suspension or foundation	1,34	1,25	1,68
Main elements of the suspension or foundation	1,34	1,10	1,48
Other structural elements of the suspension or foundation	1,34	1,0	1,34

Material resistance factor for check against yield strength for structural steel shall be, see NORSOK N-004:

- For lifting lugs including structural parts and full penetration welds: $\gamma_{Rm} = 1,15$
- For fillet welds, partial penetration welds and bolted connections: $\gamma_{Rm} = 1,3$

← **Formatert:** Punktmerket + Nivå: 1 +
Justert ved: 0,25 cm + Innrykk ved:
0,75 cm

H.4 Design criteria

H.4.1 Design loads

Design loads for foundations and suspensions shall be applied in accordance with 5.7 or standards referred to within this annex, whichever gives the most stringent requirement.

H.4.2 Inclination angles

Foundations and suspensions used onshore shall be designed for a minimum inclination from the horizontal of 1° in all directions.

Foundations and suspensions used offshore shall be designed for a minimum inclination from the horizontal according Table H.3:

Table H.3 – Inclination angle

Location	Inclination angle	
	Heel	Trim
Bottom fixed installations, tension leg platforms, jack-ups and submersibles (fixed)	1°	1°
Semi submersible/ jack-up (floating)	3°	3°
Barges of length less than 4 times breadth	3°	2°
Ships and vessels having shipshape hull properties	5°	2°

The resulting maximum inclination from heel and trim of the installation for which the foundations or suspensions are designed, shall be taken into account in the design loads and stated in the material handling plan, see B.7 b).

H.5 Runway beams (Group H 1)

H.5.1 General

The design shall be based on the loads and loads effects which are described by the manufacturer of the specific lifting equipment that are to be suspended by the runway beams.

The design shall be compatible with the design of the trolleys and wheels with regards to wheel-rail contact etc. Reference is made to EN/TS 13001-3-3.

Runway beams should preferably be of HEB-profile steel beam.

H.5.2 Design loads

Unless otherwise agreed or stated by the manufacturer of the lifting equipment, the following design criteria shall be used:

- the runway beam SWL shall be designed equal to or larger than the selected hoist SWL and preferably according to table in section H.5.8;
- dynamic amplification factor (DAF) shall be taken as 1,5 for SWL up to and including 3 tonnes, and 1,3 for SWL above 5 tonnes. For SWL between 3 tonnes and 5 tonnes, DAF is to be found by linear interpolation;
- runway beams should not be designed with a SWL of less than 0,5 tonn;
- the horizontal load in any direction shall be taken as minimum 10 % of P_p acting in the lowest suspension point. Any bending moments due to the low suspension point shall be included.

Formater: Punktmerket + Nivå: 1 +
Justert ved: 0,25 cm + Innrykk ved:
0,75 cm

H.5.3 Deflection

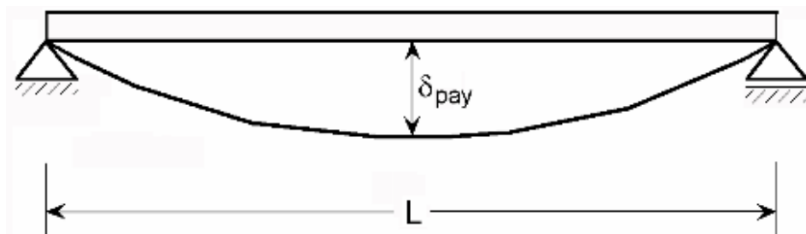

Vertical deformation, δ_{pay} , of a runway beam relative to its supports (excluding load factors):

$$\delta_{pay} \leq L/500$$

H.5.4 End stoppers

Runway beams shall be provided with robust end stoppers on both sides on all open ends where the lifting equipment may become detached from the runway beams. Ensure that the width of the end stopper is as wide as the runway beam flange to prevent the trolley from falling off. The gap under the end stopper shall not exceed 30 mm to prevent the trolley wheels to pass under. The contact area of the end stoppers shall align with the part of the lifting equipment which is designed for such contact.

Runway beams shall be provided with special designed buffers and end stoppers to absorb the kinetic energy from the fully loaded trolley travelling at the corresponding maximum speed.

H.5.5 Rack and pinion

Runway beams on ships and floating units shall be equipped with racks compatible with pinion drives of the lifting equipment, see Annex G.

H.5.6 Fabrication

Fabrication tolerances of the flange width and thickness shall be in accordance to the specifications given by the trolley manufacturer.

Misalignment and welded joints shall be grinded flush and within the specifications given by the trolley manufacturer.

H.5.7 Painting and marking

Runway beams shall be painted yellow (RAL 1003) and permanently marked with a unique identification and SWL visible from floor level (recommended size of letters are minimum 50 mm).

H.5.8 Standardised dimensions (informative)

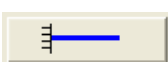
SWL (Tonnes)	Beam size	Maximum recommended span [m]	
			
1	HEB 100	4	1
2	HEB 160	6	1,5
3	HEB 200	8	2
6	HEB 300	10	3
8	HEB 360	10	3
10	HEB 400	10	3
12	HEB 450	10	3
16	HEB 500	10	2,5
20	HEB 650	10	2,5

Formatert: Venstre

The standard dimensions are intended for fixed installation and horizontal loads of 10 %. Special considerations should be given to runway beams on floating installations or for applications with horizontal loads above 10 %.

Runway beams of SWL 3 tonnes and above shall be designed with arrangements for installation and removal of trolleys and hoists. A typical design of installation arrangement on runway beams is given in Figure H.1.

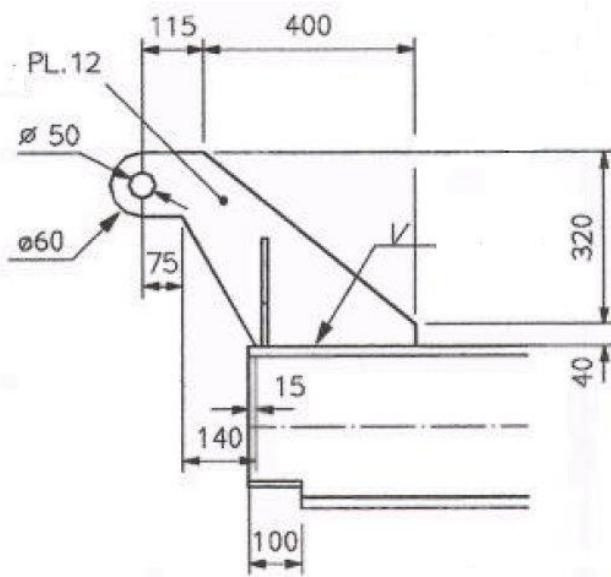
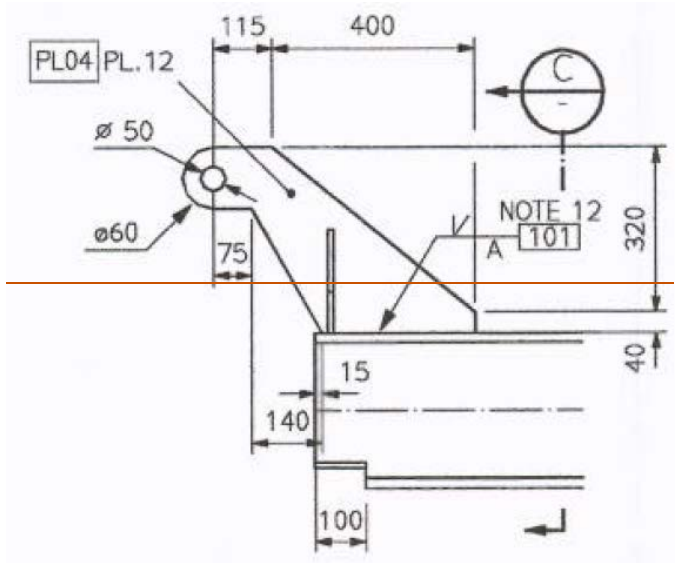

Figure H.1—Typical installation: Example of arrangement for installation of hoists and trolley with self weight up to 500 kg. ~~Special consideration of installation~~ Installation arrangement capacity shall be given to power driven hoists for trolley and beam hoist is to be marked with large SWL and tested accordingly, ref. H.6.

Formatert: Venstre, Innrykk: Venstre: 0 cm, Hengende: 2 cm

H.5.9 Documentation and testing

H.5.9.1 Load test requirements

Each runway beam shall be subjected to a proof load test according to Table H.4. The test load shall be applied in the following positions of the runway beam:

- mid span;
- support points;
- cantilever outer end;
- centre of turns.

Formatert: Punktmerket + Nivå: 1 +
Justert ved: 0,25 cm + Innrykk ved:
0,75 cm

Runway beams with turns or rack/pinion drive shall be functional tested throughout its full length with a trolley loaded with at least 50 % of the beam SWL.

Table H.4 - Proof test loads

Safe working load (SWL)	Static proof test load
Up to and including 20 tonnes	1,5 x SWL
>20 tonnes	1,25 x SWL

When testing a series of identical runway beams or lifting lugs, samples for testing may be selected according to Table H.5.

Table H.5 - Sample selection for proof load testing

Formatert: Skrift: Fet

Formatert: Innrykk: Venstre: 2 cm,
Første linje: 1 cm

Total number in series:	Number to be tested
1 to 3	All
4 to 6	3
7 to 10	4
11 to 15	5
16 to 25	6
26 to 40	8
>40	To be agreed with enterprise of competence

H.5.9.2 Documentation

In addition to the technical file required by 5.25, each runway beam shall be accompanied by a certificate, based on ILO form 2, issued by an enterprise of competence in accordance with NORSOK R-003, Annex E, or NORSOK R-005, as applicable. The certificate shall state the applied test load in accordance with Runway beams selected for testing in accordance with H.5.9.1 shall be decided by the Enterprise of Competence.

H.6 Lifting lugs (Group H 2)

H.6.1 General

Lifting lugs ~~shall~~should be designed in accordance with Annex J.

The design shall be based on the loads and loads effects which are described by the manufacturer of the specified lifting equipment that are to be suspended by the lifting lug.

The design shall be compatible with the shackle dimensions corresponding to the SWL of the lifting equipment.

H.6.2 Design loads

Unless otherwise agreed or stated by the manufacturer of the lifting equipment, the following design criteria shall be used:

- dynamic amplification factor (DAF) shall be taken as 1,5 for SWL up to and including 3 tonnes, and 1,3 for SWL above 5 tonnes. For SWL between 3 tonnes and 5 tonnes, DAF is to be found by linear interpolation;
- lifting lugs should not normally be designed with a SWL of less than 1 tonn;
- the horizontal load in any direction shall be taken as minimum 10 % of P_p acting in the center of the suspension point (e.g. the center of the shackle bow).

Formatert: Punktmerket + Nivå: 1 +
Justert ved: 0,25 cm + Innrykk ved:
0,75 cm

H.6.3 Painting and marking

Lifting lugs shall be painted yellow (RAL 1003) and permanently marked with a unique identification and SWL visible from floor level (recommended size of letters are minimum 50 mm).

H.6.4 Documentation and testing

H.6.4.1 Load test requirements

Each lifting lug shall be subjected to a proof load test according to Table H.4.

When testing a series of identical lifting lugs, samples for testing may be selected according to Table H.5.

H.6.4.2 Documentation

In addition to the technical file required by 5.25, each lifting lug shall be accompanied by a certificate, based on ILO form 2, issued by an enterprise of competence in accordance with NORSOK R-003, Annex E, or NORSOK R-005, as applicable. The certificate shall state the applied test load in accordance with H.6.4.1.

Lifting lugs selected for testing in accordance with H.6.4.1 shall be decided by the Enterprise of Competence.

H.7 Sheave brackets (Group H 3)

H.7.1 General

The sheave bracket will normally comprise a base plate for fixed attachment to the structure, side plates, axle, bearings, wire sheave (pulley wheel), and sometimes a pivot arrangement for sideways movement.

H.7.2 Design loads

Unless otherwise agreed or stated by the manufacturer of the lifting equipment, the following design criteria shall be used:

- dynamic amplification factor (DAF) shall be taken as 1,5 for line pull up to and including 3 tonnes, and 1,3 for line pull above 5 tonnes. For line pull between 3 tonnes and 5 tonnes, DAF is to be found by linear interpolation.
- The line pull is normally the SWL of the lifting appliance in which the sheave is integrated and the load on the bracket is the vector sum of the two line pull loads;
- all conditions shall be checked with 4° misalignment out of plane (fleet angle).

Formatert: Punktmerket + Nivå: 1 +
Justert ved: 0,25 cm + Innrykk ved:
0,75 cm

The load shall be calculated for the following conditions:

NORSOK standard

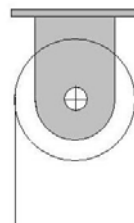

482199

- 180 degrees wrap around angle, acting perpendicular to the foundation plate;

← **Formatert:** Punktmerket + Nivå: 1 +
Justert ved: 0,25 cm + Innrykk ved:
0,75 cm

- 90 degrees wrap around angle acting perpendicular and parallel to the base plate;

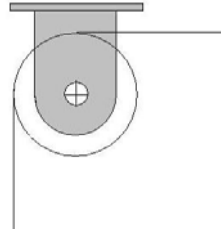

← **Formatert:** Punktmerket + Nivå: 1 +
Justert ved: 0,25 cm + Innrykk ved:
0,75 cm

- 180 degrees wrap around angle parallel with the foundation reduced
A reduced rating is permitted for this load case, provided the limitation is clearly documented.

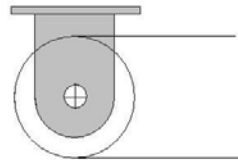

← **Formatert:** Punktmerket + Nivå: 1 +
Justert ved: 0,25 cm + Innrykk ved:
0,75 cm

Flag blocks shall be designed for symmetric angular load as shown. Supplier shall clearly state the angular limitations, and range of sideways movement. The limits of operation shall be clearly stated in the documentation.

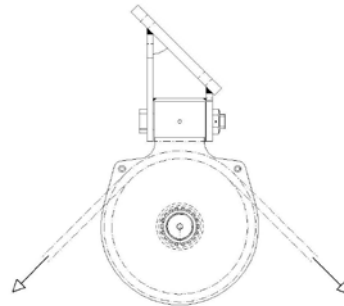

Typical sheave bracket design load for a lifting appliance with a given line pull (SWL):

$$P_p = (\text{Vector sum of line pull forces, i.e. max } 2 \times \text{SWL}) \times \text{DAF} \times \text{DF}$$

and DF = 1,68 as defined in H.3.

H.7.3 Painting and marking

Sheave brackets shall be painted yellow (RAL 1003) and permanently marked with a unique identification.

H.7.4 Documentation and testing

The following documentation shall be available:

- drawings;
- calculations;
- manufacturing records.

← **Formatert:** Punktmerket + Nivå: 1 +
Justert ved: 0,25 cm + Innrykk ved:
0,75 cm

Sheave brackets shall be tested together with the complete lifting appliance before taken into operation. The test load requirements for the lifting appliance shall be applied.

H.8 Foundations (Group H 4)

H.8.1 General

Actions from lifting appliances shall be determined with due account of dynamic effects and, if applicable, the motions of the installation. The design shall be based on the loads and load effects which are described by the manufacturer of the specific lifting appliance that is to be installed (ref. 5.25.3).

Care should be taken to ensure correct application of partial safety factors on loads transferred from the lifting appliance to the foundation. If the foundation reaction forces given by the manufacturer includes partial safety factors, the partial safety factor (γ_p) given in Table H.2 need not be applied. The consequence factor (γ_c) is intended to account for the strength proportion as required by clause 4.8 and should always be applied. However, it must also be checked that the foundation is not the first element to fail.

~~For Additionally, for offshore cranes the above mentioned consequence factor is normally not sufficient to ensure that the ratio between crane foundations, the failure loads is in accordance with Annex D of mode analysis required by EN 13852-1 (ref. Annex G of this standard). Offshore crane pedestals must) shall be performed and documented for the pedestal and its supporting structures... Elastic deflections and oscillations during use should be calculated and documented.~~

Formatert: Skrift: Helvetica

Formatert: Skrift: Helvetica

Formatert: Skrift: Helvetica

~~**NOTE** If some parts of the pedestal and attachments play a part also in the structural integrity of the installation/hull these parts may also have to be checked for correct sequence of failure according to standard used for the installation structure. If not agreed otherwise the parts of the pedestal which play a part of the structural integrity of the installation/hull structure should be fabricated according to NORSOK M-101 or Class requirements, and parts of the pedestal that do not constitute a part of the structural integrity of the installation/hull structure should be fabricated according to DNV 2.22.~~

Formatert: Skrift: 8 pkt, Engelsk (USA)

Formatert: Skrift: 8 pkt, Engelsk (USA)

Formatert: Skrift: 8 pkt, Engelsk (USA)

~~Interface between pedestal and pedestal adapter should be located such that installation welds can be made without damaging machined flanges for slewing ring.~~

Table H.36 is an informative summary of different factors to be used on reactions in the foundation interface and may be used as a comparison between the different lifting appliances standards and the NORSOK N-001 standard for including the lifting appliance foundation actions in to the global and local structural analysis.

|

Table H.36 – Informative. Foundation interface comparison table

INFORMATIVE FOUNDATION INTERFACE COMPARISON TABLE									
LIFTING APPLIANCES STANDARDS EN 13001-2, EN13852-1, EN 15011 etc.				NORSOK N-001 STRUCTURAL DESIGN STANDARD FOR ACTIONS (ON FOUNDATION AND SUPPORTING STRUCTURE)					
Load Cases from Crane standards	Description of some load cases	Partial safety factor γ_p	Conseq. Factor γ_c	NORSOK N-001	Permanent actions (G)	Variable Actions (Q)	Environmental actions (E)	Conseq. Factor γ_c	Comments If relevant.
LC A LC I	Regular: working without environmental actions	1.34	1.25*	ULS a)	1.3	1.3	-	1.25*	For local foundation interface check; Environmental actions may be ignored if crane working at maximum capacity.
LC B LC II	Occasional: Working with wind	1.22	1.25*	ULS a)	1.3	1.3	0.7	1.25*	E.g. Operational wind limits for offshore cranes. (Typ. 25 m/s (3 sec)) Operational Sign. wave height limits (Typ. 6 m)
LC C LC III	Exceptional: Extreme wind during out of service and stowed position.	1.16 or 1.1	1.0	ULS b)	1.0	-	1.3	1.0	E.g. Environmental actions during stowing and out of service. (Annual probability of exceedance 10^{-2})
LC C LC III	Exceptional: Extreme wind during out of service and stowed position. (10^{-4})	1.1	1.0	ALS	1.0	-	1.0	1.0	E.g. Extreme environmental actions during stowing out of service (10^{-4})
Displacement	Check of displacement	1.0	1.0	SLS	1.0	1.0	1.0	1.0	If special requirements set in this NORSOK R-002, else set by the manufacturer
Fatigue check	Check of the fatigue capacity	1.0	1.0	FLS	1.0	1.0	1.0	1.0	Fatigue calculations shall be carried out based on expected frequency of crane usage, the magnitude of actions, dynamic effects from wind, loading and discharging of ships and if applicable from motions of the installation.
Proportion of strength (Failure mode analysis)	Check of the structural failure mode (Collapse load)	1.0	1.25*	ALS	1.0	1.0	-	1.25*	Failure mode analysis due to gross overload.

* Consequence factor to be multiplied to all partial action/safety/load factors selected in accordance with Table H.2. If intended for personnel lifting, the consequence factor shall be multiplied by the risk coefficient of 1.5 as described in this NORSOK standard.

For offshore crane foundations, the consequence factor may be reduced to the level necessary to satisfy the failure mode analysis required by EN 13852-1.

H.8.2 Painting and marking

Foundations shall be painted yellow (RAL 1003) and permanently marked with a unique identification.

H.8.3 Documentation and testing

The following documentation shall be available:

- drawings;
- calculations;
- manufacturing records.

Foundations shall be tested together with the complete lifting appliance before taking into operation.

← **Formatert:** Punktmerket + Nivå: 1 +
Justert ved: 0,25 cm + Innrykk ved:
0,75 cm

|

Annex I
(Informative)
Selection of elastic pennant – calculation example

I.1 General

This annex serves as an example of how to select appropriate dimensions for an elastic pennant in accordance with A.7.4.

I.2 Input parameters

Required capacity:

Gross mass of rescue boat: _____ $W = 4$ tonnes (fully equipped with full complement of persons)

Required service:

Crane hoisting speed with load 4 tonnes: $V_H = 2,0$ m/s

Host installation type: _____ Semisub

Where:

V_H is the maximum steady state hoisting speed at which the offshore crane at the host installation is able to lift the gross mass of the rescue boat

I.3 Rope selection

I.3.1 Data for fibre rope, given by rope manufacturer

Rope construction: _____ 8-strand plaited polyamide rope

Table I.1 shows MBL (minimum braking load) for different nominal rope diameters (information taken from rope manufacturer's data sheets or catalogues):

Table I.1 - Rope minimum breaking load

<u>Diameter</u> <u>(mm)</u>	<u>MBL</u> <u>(kN)</u>
44	350
48	410
52	480
56	550
60	630
64	710
68	790

Curve for dimensionless static stiffness (K') taken from rope manufacturer's data sheet or catalogue, is shown in Figure I.1.

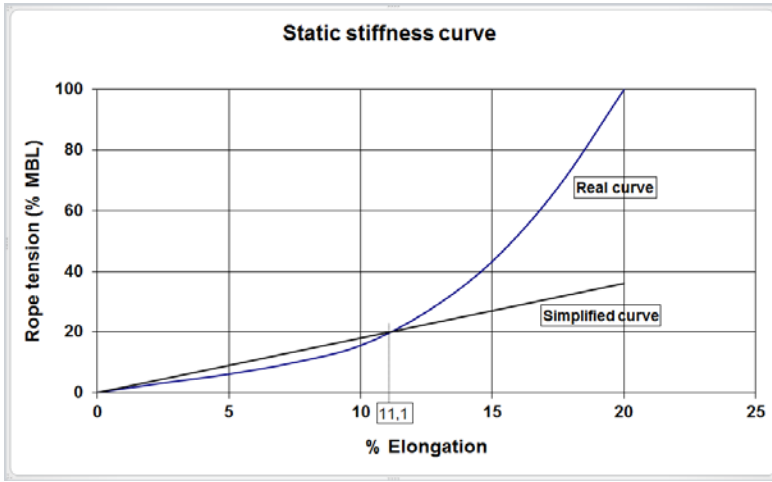

Figure I.1 – Rope static stiffness curve

For simplified calculations, a linear force-elongation curve crossing the real force-elongation curve at 0% of MBL and 20% of MBL is drawn.

Elongation at crossing point is **read off to be 11.1%.**

The static stiffness is taken as the gradient of the simplified linear curve.

$$K' = \frac{20}{11,1} = 1,80 \quad (I.1)$$

Feltkode endret

I.3.2 Selection of rope diameter:

The rope diameter is selected based on the required minimum breaking load with a minimum static safety factor of 10, taking into account a reduction factor of 10 % for splices, ref. clause A.7.4.3:

Required minimum breaking load (from formula A.18):

$$SF_{Stat} = \frac{90\% MBL}{WLL_{R002A} \cdot g} \geq 10$$

Feltkode endret

For $WLL_{R002A} = W = 4 \text{ tonnes}$, the required minimum breaking load, MBL_{req} is found to be:

$$MBL_{req} \geq SF_{Stat} \cdot \frac{W \cdot g}{0,9} = 10 \cdot \frac{4 \cdot 9,81}{0,9} = 436kN \quad (I.2)$$

Feltkode endret

Minimum rope diameter selected, **read off from Table I.1:** 52mm

Feltkode endret

Actual minimum breaking load selected from rope manufacturers catalogue, for rope diameter 52 mm:

$$MBL_{Act} = 480kN \quad (\text{see table I.1})$$

Feltkode endret

Actual static safety factor, from expression (A.18):

$$SF_{Stat} = \frac{90\% MBL}{WLL_{R002A} \cdot g} = \frac{0,9 \cdot 480}{4 \cdot 9,81} = 11,01$$

Feltkode endret

Actual static stiffness, from expression (A.22), as function of length (L):

$$K = \frac{K' \cdot MBL_{Act}}{L} = \frac{1,80 \cdot 480}{L} kN/m = \frac{864}{L} kN/m \quad (I.3)$$

Feltkode endret

(Note that L is the unknown variable to be calculated through this process, not yet known at this moment).

I.3.3 Calculation of minimum rope length:

In the following a graphical approach is used to illustrate the pennant length influence of the dynamic factor (Φ) and the dynamic safety factor (SF_{dyn}). Those factors serve as acceptance criteria for the pennant length. The pennant length may also be calculated by rearranging the formulas for the criteria to be checked.

The velocities applicable for calculation of the dynamic factor, Φ , can be calculated from the input parameters as shown in Table I.2:

Table I.2 – Velocities used for calculating dynamic factor

Load combination:	LCA	LCC
Sign. wave height, Hs:	3 m	6 m
V_H (m/s)	2,00	2,00
V_D (m/s), ref. expression (A.6)	1,87	2,77
V_C (m/s), ref. expression (A.7)	0,75	1,50
V_R (m/s), ref. expression (A.21)	3,02	4,15

The dynamic factor, Φ , is calculated using expression (A.20) for both LCA and LCC.

The dynamic safety factor, SF_{dyn} , is calculated using expression (A.19) for both LCA and LCC.

These parameters will be depending on the pennant length (L).

Results are shown in Table I.3:

Table I.3 – Dynamic factor and dynamic safety factor as function of pendant length

<u>Length of elastic pennant</u>	<u>LCA</u>		<u>LCC</u>	
	<u>L (m)</u>	<u>Φ</u>	<u>Φ</u>	<u>SFdyn</u>
8	(2,60)	(12,01)	(3,20)	(12,13)
9	(2,51)	(11,58)	(3,07)	(11,65)
10	2,43	(11,23)	2,96	(11,25)
11	2,36	10,92	2,87	10,90
12	2,30	10,65	2,79	10,60
13	2,25	10,42	2,72	10,33
14	2,21	10,20	2,66	10,09
15	2,17	10,02	2,60	9,88

Numbers in (brackets) exceed the acceptance criteria.

The dynamic factor, Φ , and the dynamic safety factor, SFdyn, are plotted against corresponding length of the elastic pennant in Figure I.2:

Applying the acceptance criteria in A.7.4.3 for dynamic factor and dynamic safety factor, there are 4 criteria to be checked:

- 1: $\Phi_{LCA} \leq 2,5$: Returns a length of $L \geq 9,1m$
- 2: $\Phi_{LCC} \leq 3,0$: Returns a length of $L \geq 9,6m$
- 3: $SF_{dyn_{LCA}} \leq SF_{stat}$: Returns a length of $L \geq 10,7m$
- 4: $SF_{dyn_{LCC}} \leq SF_{stat}$: Returns a length of $L \geq 10,7m$

The plot shows that the minimum required length is:

$L_{min} = 10,7 m$ (length between splices)

In this example, criteria 3 and 4 return approximately the same length (10,7m read off from criteria #3 and #4).

NB!

It is always the criterion that returns highest value for length that that gives the minimum required pennant length, as a shorter pennant will fail on another criterion.

Summary of parameters for the selected elastic pennant:

- Rope construction: 8-strand plaited
- Rope material: Polyamide
- Rope diameter: 52 mm
- Pennant length (between splices), L: 10,7 m
- Minimum breaking load, MBL: 480 kN
- Service:
 - Host installation: Semisubmersible unit
 - Max crane hook velocity: 2 m/s
- Working load limit, WLL_{R002A} : 4 Tonnes

The above mentioned parameters shall be listed in the manufacturer's certificate for the elastic pennant (ref. A.7.4.7).

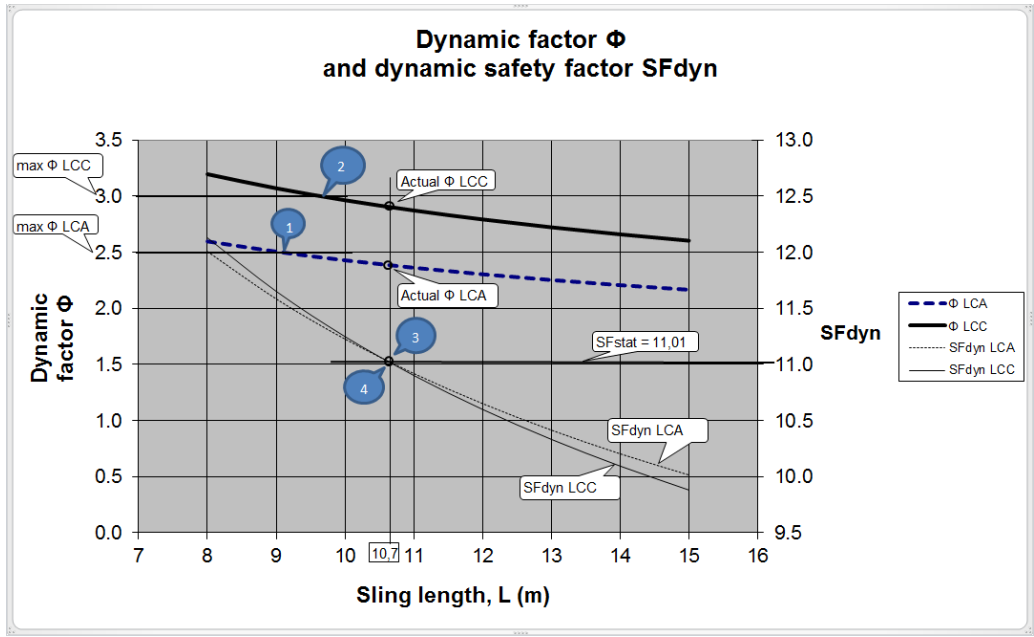

Figure I.2 – Dynamic factor, Φ , and dynamic safety factor, SF_{dyn} , plotted against sling length

1.3.4 Other host installations

Applying the same method for other host installations will give the following results for pennant length:

- Bottom fixed installation: $L = 9,7$ m
- Monohull installation / FPSO: $L = 16,0$ m

(calculations are not shown).

1.4 WLL variations for a specified elastic pennant

An elastic pennant selected for a specific service, may also be used for other services, e.g. using an offshore crane located on another host installation with a different maximum steady state hoisting velocity.

By applying the acceptance criteria and rearranging the formulas in A.7.4.3, the maximum and minimum WLL for a specified elastic pennant can be calculated.

The curves in figure I. 3 show the variations in WLL for the elastic pennant selected in the previous example, specified by the parameters listed in I.3.3.

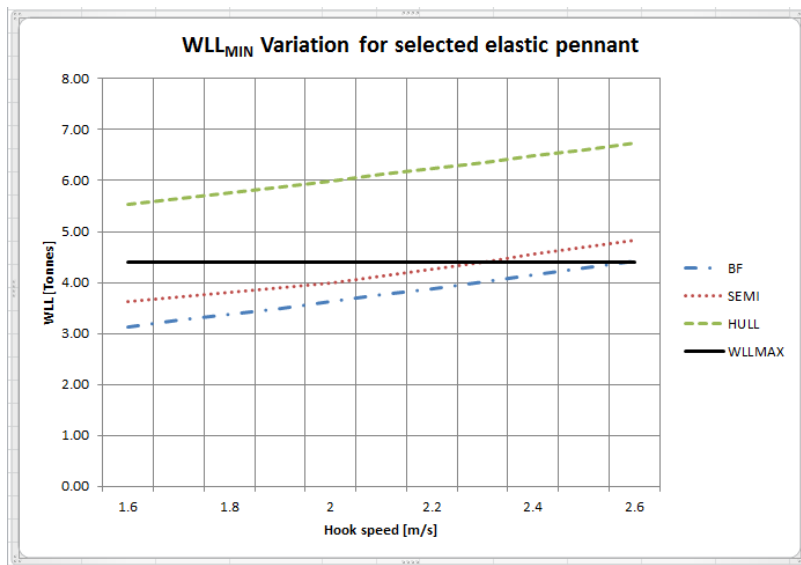

Figure I.3 WLL variation

Codes used:

- BF: Bottom fixed installation
- SEMI: Semisubmersible installation
- HULL: Monohull shaped installation / FPSO

Explanation:

The area between WLL_{MIN} and WLL_{MAX} to the left of the crossing points, where $WLL_{MIN} < WLL_{MAX}$, represents the allowable loads that can be lifted when the specific elastic pennant is used for different services.

In this case, the elastic pennant cannot be used on a monohull installation/FPSO.

Loads less than WLL_{MIN} exceeds the acceptance criteria due to one or more of the following reasons:

- Dynamic factor is too high for the lifted rescue boat (exceeds 2.5 for LCA or 3.0 for LCC).
- Dynamic safety factor (SF_{dyn}) exceeds the static safety factor (SF_{stat}) for either LCA or LCC.

Loads exceeding WLL_{MAX} do not give sufficient static safety factor (i.e. $SF_{stat} < 10$).

The results may also be presented as shown in table I.4.

Table I.4 – WLL variation

V[m/s]	BF	SEMI	HULL	WLLMAX
1.6	3.14	3.62	(5.53)	4.40

<u>1.7</u>	<u>3.26</u>	<u>3.71</u>	<u>(5.65)</u>	<u>4.40</u>
<u>1.8</u>	<u>3.38</u>	<u>3.80</u>	<u>(5.76)</u>	<u>4.40</u>
<u>1.9</u>	<u>3.50</u>	<u>3.90</u>	<u>(5.88)</u>	<u>4.40</u>
<u>2.0</u>	<u>3.63</u>	<u>4.00</u>	<u>(6.00)</u>	<u>4.40</u>
<u>2.1</u>	<u>3.75</u>	<u>4.14</u>	<u>(6.12)</u>	<u>4.40</u>
<u>2.2</u>	<u>3.88</u>	<u>4.27</u>	<u>(6.24)</u>	<u>4.40</u>
<u>2.3</u>	<u>4.02</u>	<u>(4.41)</u>	<u>(6.36)</u>	<u>4.40</u>
<u>2.4</u>	<u>4.15</u>	<u>(4.55)</u>	<u>(6.48)</u>	<u>4.40</u>
<u>2.5</u>	<u>4.29</u>	<u>(4.69)</u>	<u>(6.60)</u>	<u>4.40</u>
<u>2.6</u>	<u>(4.42)</u>	<u>(4.84)</u>	<u>(6.73)</u>	<u>4.40</u>

Numbers in (brackets) exceed the acceptance criterion.

1.5 WLL variations for a selected fibre rope

When a rope with specified characteristics is selected, the minimum and maximum WLL can be presented in curves or tables. Using the example in I.3, a rope with the following specified characteristics has been selected:

- Rope construction: 8-strand plaited
- Rope material: Polyamide
- Rope diameter: 52 mm
- Minimum breaking load, MBL: 480 kN
- Static stiffness, K': 1,8

NB! Static stiffness (K') and minimum breaking load (MBL) have to be documented by type testing as described in A.7.5.

The maximum WLL is given by the required static safety factor ($SF_{stat} > 10$): **WLL_{MAX} = 4,4 tonnes**

The minimum WLL is depending on the applicable service, and will vary according to the curves shown in figures I.4, I.5 and I.6.

Example:

If a rescue boat with gross mass of 3.6 tonnes is to be lifted by an offshore crane located on a bottom fixed unit with a maximum steady state hoisting speed of 2,2 m/s, using the curves in figure 4 will return a minimum length between splices of 11,5m.

Calculations are not shown here, only results.

It is recommended that manufacturers create their own curves based on the specifications for the applicable ropes to be used, in order to enable easy selection of pennant length for the requested service.

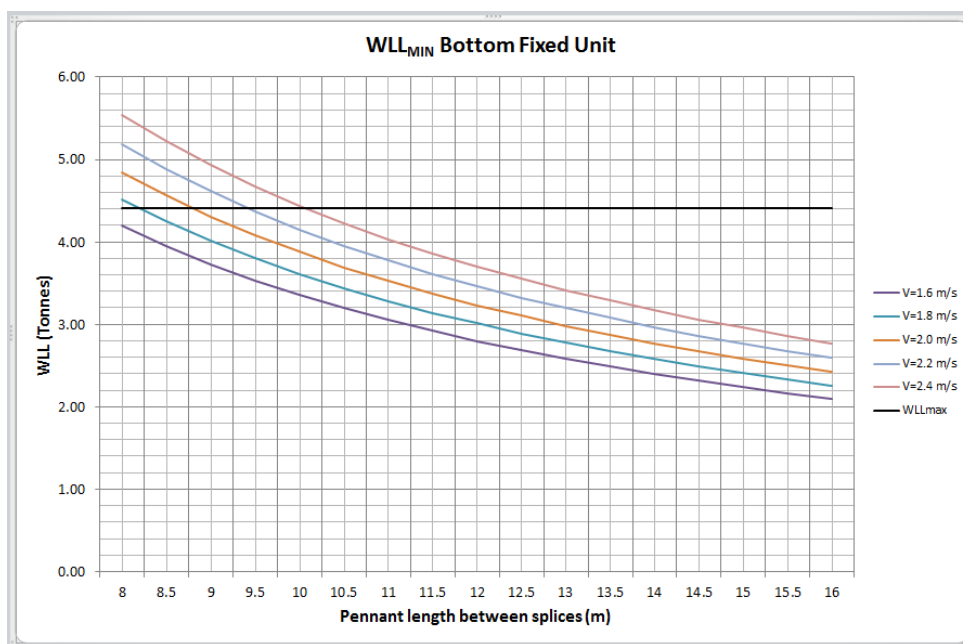

Figure I.4 WLL variation for a specific rope to be used on a bottom fixed unit

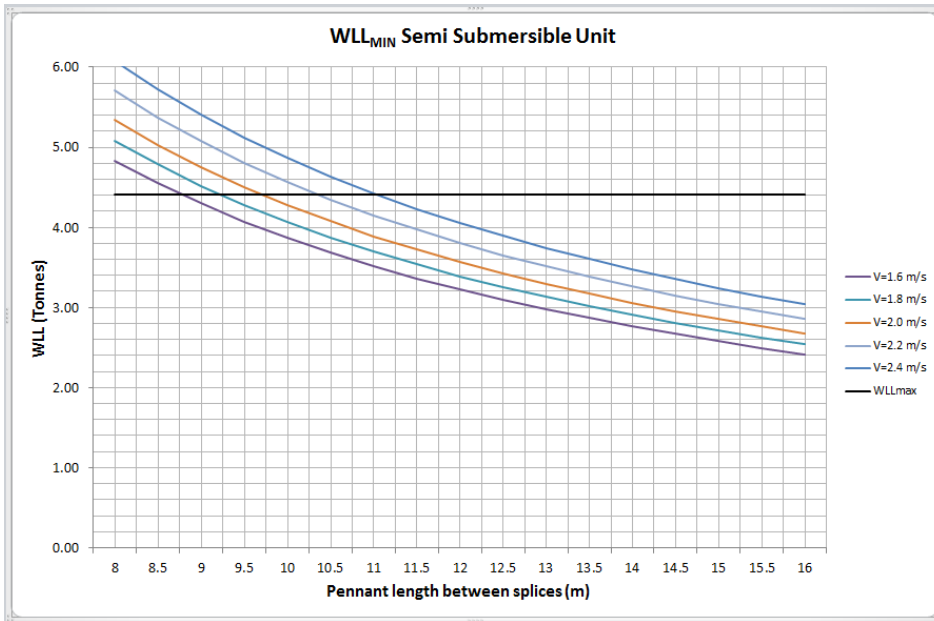

Figure I.5 WLL variation for a specific rope to be used on a semisubmersible unit

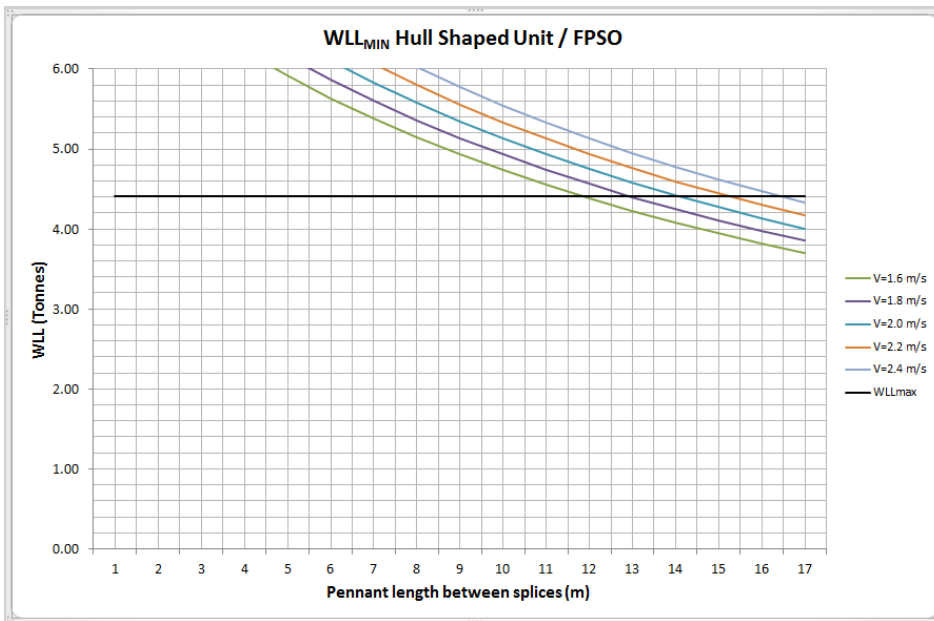

Figure I.6 WLL variation for a specific rope to be used on a monohull shaped unit / FPSO

Formatert: Engelsk (Storbritannia)

Annex J (Informative) Lifting lugs and mating shackles

J.1 General

Design of lifting lugs and mating shackles is highlighted in this annex.

This annex applies together with one or more of the annexes listed below:

- Annex F for lifting lugs on equipment or units to be used for transportation, installation and decommissioning;
- Annex H for lifting lugs for suspension of permanent or temporary lifting equipment;
- Annex C for lifting lugs integrated in lifting accessories.

← **Formater:** Punktmerket + Nivå: 1 +
Justert ved: 0,25 cm + Innrykk ved:
0,75 cm

All dimensions (e.g. thickness, hole diameter, bolt diameter etc.) in this annex are given as nominal values (in mm). Fabrication tolerances are not covered in this annex.

J.2 Design of lifting lugs

J.2.1 Types of lifting lugs

Three different types of lifting lugs are considered:

- Type 1 is the basic type manufactured from one single plate;
- Type 2 has one cheek plate fillet welded on each side of the plate;
- Type 3 has a boss partly welded to the plate with full penetration weld.

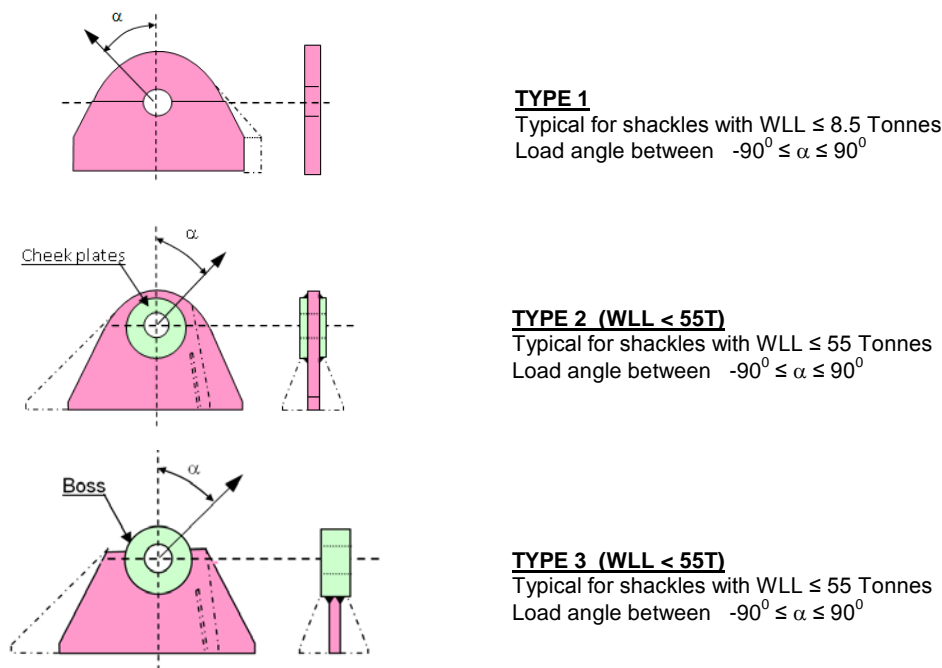

Figure J.1 - Lifting lugs Type 1, 2 and 3 (Dotted lines indicate alternative designs)

J.2.2 Lifting lug connection to structures

A general recommendation is to design the connection between lifting lug and supporting structure as a shear connection. Out-of-plane loading should be minimized.

For welded lifting lugs, through thickness properties must be documented in cases where it is impractical to avoid stresses in thickness direction, e.g. by use of z-quality material or by additional ultrasonic testing for lamination.

An alternative, to avoid lamination problems, is to slot the plate through the horizontal flange and weld directly onto the underlying vertical web plates. This applies specially to heavy loaded lifting lugs.

The stress level locally at the base of the lifting lug may be reduced by adding a fillet weld onto a part pen (or full pen) weld.

Bolted connections shall be minimum M12 size and should be designed to transfer the load

- by shear, without considering the friction mobilized in the connection,
- or alternatively by vertically orientated bolts in tension.

Formatert: Punktmerket + Nivå: 1 +
Justert ved: 0,25 cm + Innrykk ved:
0,75 cm

Examples shown in Figure J.2 and Figure J.3:

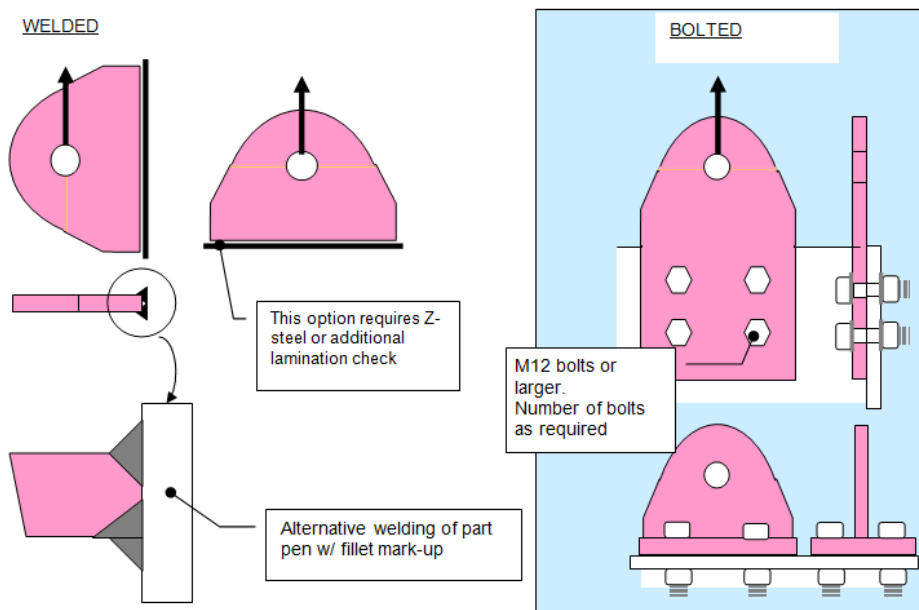

Figure J.2 - Welded/bolted connections

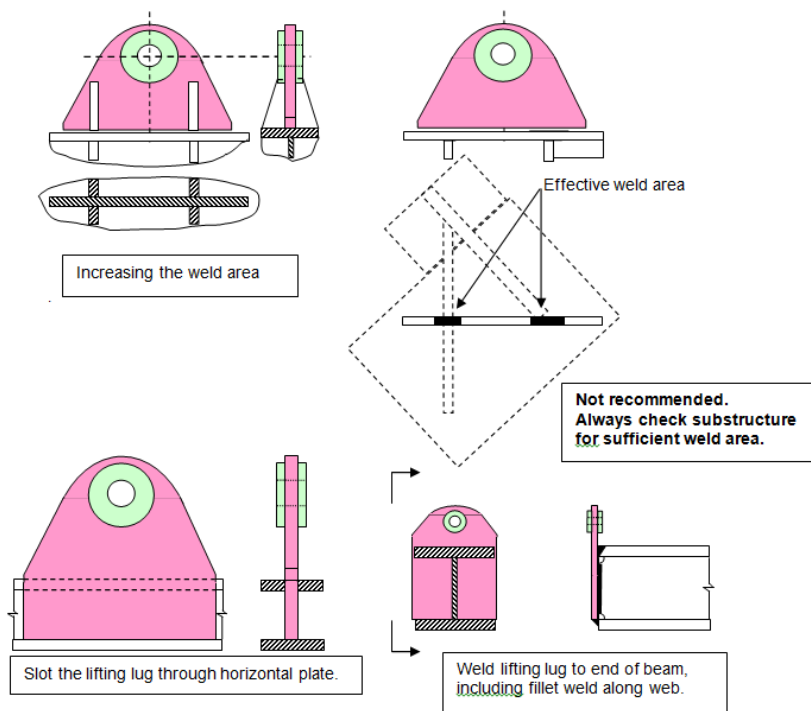

Figure J.3 - Welded connections

J.2.3 Lifting lug/shackle accommodation

Lifting lugs should be design to match the relevant standard shackle dimensions, and to account for tolerance deviation between the different shackle types. The selected shackle shall house both lifting lug and selected sling or hook, see Figure J.4.

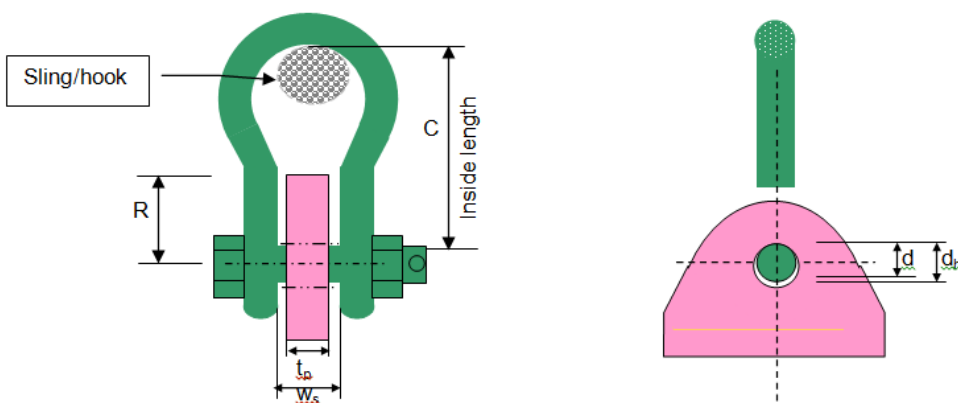
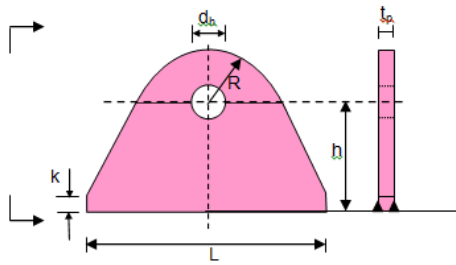

Figure J.4 - Lifting lug vs. shackle interface - Type 1 Lifting lug shown

J.2.4 Lifting lug geometry

Lifting lug geometry should be decided on the basis of a load distribution perspective and an operational judgement (based on shackle geometry). The following examples of complete lifting lug geometry may form such basis. The dimensions given in tables below are based on a minimum yield stress (f_y) of 355 N/mm².

Type 1 – Load Angle - $90^0 \leq \alpha \leq 90^0$



Dimensions in mm

$d_h = 1,03 \cdot d + 2$ (Minimum hole diameter)

$1,3 \cdot d_h < R < 1,8 \cdot d_h$

$0,75 \cdot w_s \leq t_p \leq 0,9 \cdot (w_s - 3)$

$2,2 \cdot d_h \leq h \leq 2,4 \cdot d_h$
 $2,4 \cdot h \leq L \leq 2,7 \cdot h$
 d = shackle bolt diameter
 w_s = inside width of shackle at bolt section
 α = load angle relative to vertical

Maximum hole diameter shall not exceed $d_h + 5\%$

Shackle geometry and tolerances are based on Dee shackles and Bow shackles according to EN 13889 and US Federal Spec. RR-C-271.

Figure J.5 - Lifting lug Type 1 geometry – Single plate

Shackle WLL tonnes	t_p mm	d_h mm	R mm	h mm	L mm	k mm
1,0	14	14	20	30	80	14
1,5	15	15	20	35	85	15
2,0	18	19	26	45	110	18
3,25	22	22	30	50	125	22
4,75	25	25	35	60	140	25
6,5	30	28	38	65	160	30
8,5	35	32	42	70	180	35
9,5	35	36	47	80	200	35

Table J.1 - Type 1 – Single plate

Type 2 – Load angle - $90^0 \leq \alpha \leq 90^0$

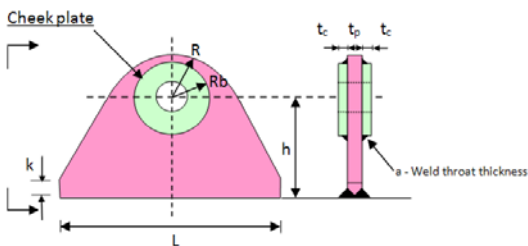

Figure J.6 - Lifting lug Type 2 geometry – Cheek plates each side

Dimensions in mm

$d_h = (1,03 \cdot d) + 2$ (Minimum hole diameter)

$1,0 \cdot d_h < R_b < 1,5 \cdot d_h$

$R = R_b + t_c$

$0,4 \cdot w_s < t_p < 0,6 \cdot w_s$

$0,75 \cdot w_s \leq t_p + 2 \cdot t_c \leq 0,9 \cdot (w_s - 3)$

$2,2 \cdot d_h \leq h \leq 2,4 \cdot d_h$
 $2,4 \cdot h \leq L \leq 2,7 \cdot h$
 d = shackle bolt diameter
 w_s = inside width of shackle at bolt section
 α = load angle relative to vertical

Maximum hole diameter shall not exceed $d_h + 5\%$

Shackle WLL tonnes	t_p mm	d_h mm	R mm	h mm	L mm	k mm	R_b mm	t_c mm	a mm
8,5	20	32	50	70	175	20	42	8	5
9,5	25	36	55	80	200	20	47	8	5
12	25	39	60	88	220	25	52	8	5
13,5	25	43	66	95	236	25	56	10	7
17	30	47	71	103	258	30	61	10	7
25	35	55	84	121	302	35	72	12	7
35	40	62	96	136	341	40	81	15	7
42	50	70	106	154	385	50	91	15	10
55	50	75	118	165	410	50	98	20	10

Table J.2 - Type 2 – Cheek plates each side

Type 3 – Load angle - $90^\circ \leq \alpha \leq 90^\circ$

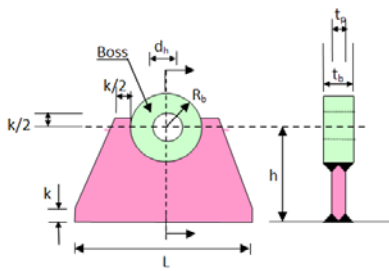

Figure J.7 - Lifting lug Type 3 geometry
– Boss welded partly to plate

Dimensions in mm

$$d_h = (1,03 \cdot d) + 2 \quad (\text{Minimum hole diameter})$$

$$1,3 \cdot d_h < R_b < 1,5 \cdot d_h$$

$$0,4 \cdot w_s < t_p < 0,6 \cdot w_s$$

$$0,75 \cdot w_s < t_b < 0,9 \cdot (w_s - 3)$$

$$2,2 \cdot d_h \leq h \leq 2,4 \cdot d_h$$

$$2,4 \cdot h \leq L \leq 2,7 \cdot h$$

t_b = boss thickness

d = shackle bolt diameter

w_s = inside width of shackle at bolt section

α = load angle relative to vertical

Maximum hole diameter shall not exceed $d_h + 5\%$

Shackle WLL tonnes	t_p mm	d_h mm	R mm	h mm	L mm	k mm	R_b mm	t_b mm
12	25	39	60	88	220	25	52	41
13,5	25	43	66	95	236	25	56	45
17	30	47	71	103	258	30	61	50
25	35	55	84	121	302	35	72	60
35	40	62	96	136	341	40	81	70
42	50	70	106	154	385	50	91	80
55	50	75	118	165	410	50	98	90

Table J.3 - Type 3– Boss types

J.2.5 Lifting lug strength calculations

J.2.5.1 Load components

The lifting lug design force P_p is defined in Annex F or Annex H as applicable.

Vertical and horizontal component of P_p

$$P_{pv} = P_p * \cos \alpha \quad (J.1)$$

$$P_{ph} = P_p * \sin \alpha \quad (J.2)$$

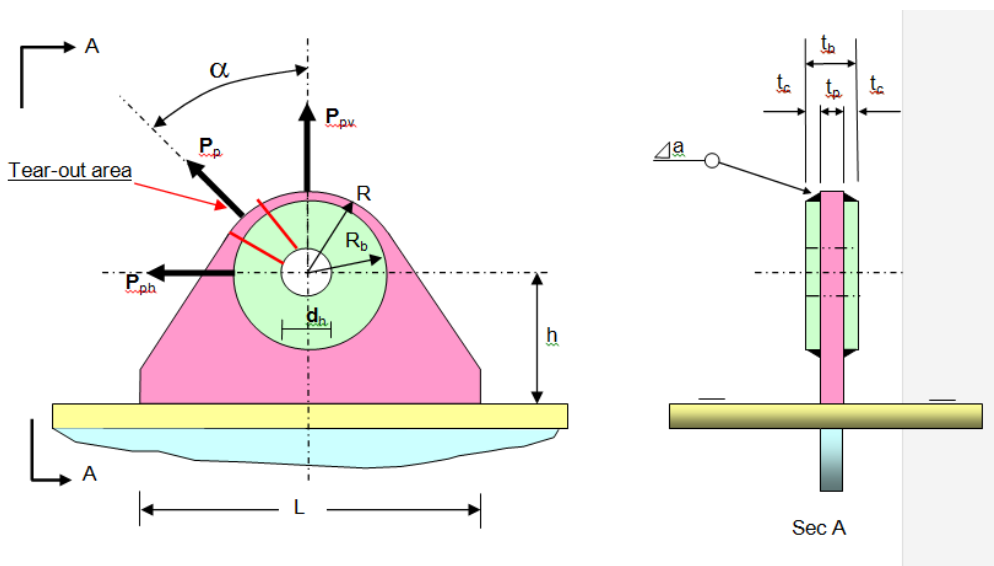
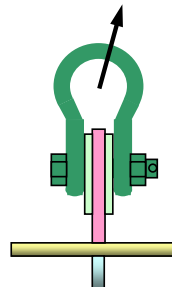

Figure J.8 - Design load components

The above tables are guidelines only. The actual lifting lug has to be checked using the partial factors and the design load applicable for the installation according to Annex F or Annex H.

The lateral load specified in Annex F or Annex H shall be applied acting in the centre of the shackle bow as indicated in Figure J.9. The lateral load is not accounted for in the following text and shall be considered additionally.

Figure J.9 Lateral load acting in the centre of the shackle bow



J.2.5.2 Limit design stress

The limit design stress is:

$$f_d = \frac{f_y}{\gamma_{Rm}} \quad (J.3)$$

where

f_y = yield stress

γ_{Rm} = material resistance factor

Material resistance factors shall be as follows:

- for lifting lugs including structural parts and full penetration welds: $\gamma_{Rm} = 1,15$
- for fillet welds, partial penetration welds and bolted connections: $\gamma_{Rm} = 1,3$

J.2.5.3 Tear-out limit design stress

Limit design shear stress should be assessed to satisfy the following condition:

$$f_{rd} = \frac{f_y}{\sqrt{3} * \gamma_{Rm}} \geq \tau_{Ed} \quad (J.4)$$

where τ_{Ed} is the tear out stress.

$$\tau_{Ed} = \frac{P_p}{2 * A_{sh}} \quad (J.5)$$

where

$$A_{sh} = \begin{cases} \left(R - \frac{d_h}{2} \right) * t_p & \text{For Type 1} \\ \left(R - \frac{d_h}{2} \right) * t_p + 2 * \left(R_b - \frac{d_h}{2} \right) * t_c & \text{For Type 2} \\ \left(R_b - \frac{d_h}{2} \right) * t_b & \text{For Type 3} \end{cases}$$

$$A_{sh} = \begin{cases} \left(R - \frac{d_h}{2} \right) * t_p & \text{For Type 1} \\ \left(R - \frac{d_h}{2} \right) * t_p + 2 * \left(R_b - \frac{d_h}{2} \right) * t_c & \text{For Type 2} \\ \left(R_b - \frac{d_h}{2} \right) * t_b & \text{For Type 3} \end{cases}$$

J.2.5.4 Load bearing limit design stress at pinhole edge

Design bearing limit design stress should be assessed to satisfy the following condition:

$$f_d = 1.5 * \frac{f_y}{\gamma_{Rm}} \geq \sigma_b \quad (J.6)$$

where σ_b = pin hole bearing stress.

$$\sigma_b = \frac{P_p}{t_{eff} * d} \quad (J.7)$$

where

$$t_{eff} = \begin{cases} t_p & \text{For Type 1} \\ t_p + 2 * t_c & \text{For Type 2} \\ t_b & \text{For Type 3} \end{cases}$$

J.2.5.5 Fillet weld limit design stress for Type 2

Fillet weld limit design stress should be assessed to satisfy the following condition:

$$f_d = \frac{f_y}{\sqrt{3} * \gamma_{Rm}} \geq \tau_{Ed} \quad (J.8)$$

where τ_{Ed} is the fillet weld shear stress.

Force distribution is assumed to be according to thickness of lifting lug plate and cheek plates.

For each cheek plate, the following should be assumed:

Effective weld length is $\frac{2}{3}$ of total circumference:

$$L_{eff} = \frac{2}{3} * 2 * \pi * R_b \quad (J.9)$$

Load through weld of each cheek plate:

$$P_{cp} = \frac{P_p * t_c}{t_p + 2 * t_c} \quad (J.10)$$

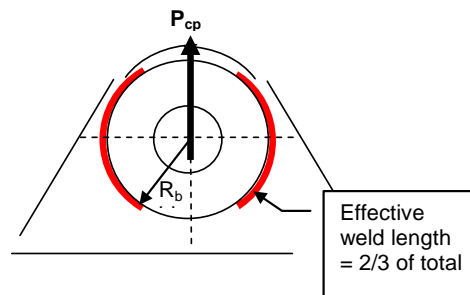

Figure J.10 – Effective weld length

Fillet weld shear stress :

$$\tau_{Ed} = \frac{P_{cp}}{L_{eff} * a} = \frac{P_p * t_c}{(t_p + 2 * t_c) * \frac{4}{3} * \pi * R_b * a} \quad (J.11)$$

where

a = nominal throat size of the fillet weld.

R_b = cheek plate radius in mm

P_p = lifting lug design force

t_p = lifting lug plate thickness

t_c = cheek plate thickness

J.2.5.6 Weld strength for Type 3

Weld limit design stress should be assessed to satisfy the following condition:

$$f_d = \frac{f_y}{\gamma_{Rm}} \geq \sigma \quad (J.12)$$

Weld between boss and plate shall have full penetration.

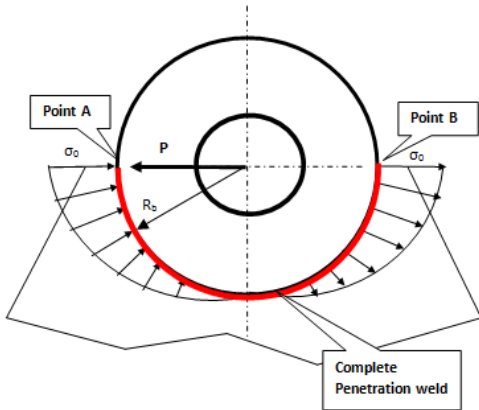

Figure J.11 – Horizontal loaded boss

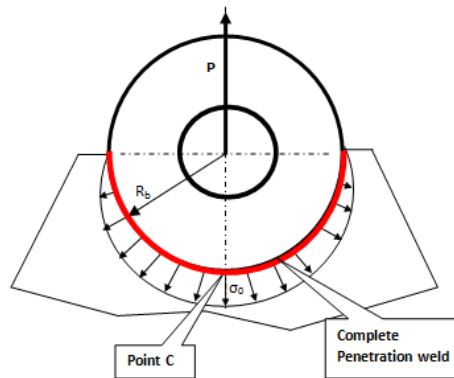

Figure J.12 – Vertical loaded boss

Maximum stress σ_0 at point A and point B for horizontal load :

$$\sigma_0 = \frac{2 * P}{\pi * R_b * t_p} \quad (J.13)$$

Maximum stress σ_0 for vertical load at point C :

$$\sigma_0 = \frac{2 * P}{\pi * R_b * t_p} \quad (J.14)$$

These formulas may be used to check stress magnitudes from the horizontal and vertical forces of the lifting lug design force P_p .

Annex K (Informative) High risk application

K.1 General

Lifting appliances for high risk applications shall be designed and have means to reduce the probabilities and consequences of possible harm. A possible method and applicable means are described in this annex.

The extent of high risk applications can be divided into classes of high risk, ref. Table K.1.

Table K.1 - Classes of high risk

Risk class	Description	Exposure
High risk class I	Consequences of failure are limited to the vicinity of the lifting equipment with considerable economic, social and environmental consequences or potential for loss of human lives within the work space of the lifting appliance.	<ul style="list-style-type: none">- Personnel- Dangerous materials, e.g. explosives, flammables and dangerous chemicals- Work space
High risk class II	Consequences of failure extending beyond the vicinity of the lifting equipment with very serious economic, social and environmental consequences or potential for loss of human lives at the work space and at the whole site/installation/vessel.	<ul style="list-style-type: none">- Personnel- Dangerous materials, e.g. explosives, flammables and dangerous chemicals- Live plant/ wellheads/risers/pipelines- Site/installation/vessel

K.2 Principle of high risk reduction

The prioritized sequence of reducing high risks shall be as follows:

1. Inherent safe design, see K.3
2. Protective measures, see K.4
3. Information for use, see K.5

K.3 Inherent safe design

Inherent safe design shall ensure that a component or element which are needed to suspend or move the load or main parts e.g. the boom, of the lifting appliance, does not cause the load or the part of the lifting appliance to fall or move unexpectedly in case of a single failure.

All load bearing structure, mechanisms and suspensions for high risk applications shall either be redundant (duplicated) or be designed with an increased risk coefficient, γ_n .

Redundancy by duplicating components shall be the preferred measure, except for structure such as foundations, pedestals, superstructure, booms and mechanisms where duplication is normally not feasible or will create other significant hazards of high risks.

Movable lifting equipment which depends on stability for safe operation, such as lorry cranes, mobile cranes and crawler cranes, shall be calculated for rigid body stability in accordance ISO 4305. The risk coefficient, γ_n shall be multiplied with the P and F values to be taken into consideration in the stability calculations in clause 3.2 of ISO 4305.

K.3.1 Duplicating components

Duplicated components shall be loaded during normal use and shall withstand the load impacts if there is a single failure in one of the components.

Duplicated components shall have proof of competence for two loading conditions as follows:

- Regular loading condition, where all the components operate as a whole sharing the load.
- Exceptional loading condition, taking into account a failure of any single component of the mechanism and the resulting dynamic impact on the remaining parts.

The increased risk coefficient ref. K.3.2, need not to be applied for duplicated components.

Mechanisms, including their drive systems and energy converters shall be fully or partly duplicated dependent on the high risk class, see Table K.2.

Systems of duplicated components shall have means for load equalization between the components during normal operation.

Load equalization of duplicated components shall be monitored and controlled, e.g. by synchronization, hydraulic/electric control system or by a compensating device. Safe transfer of loadings to the remaining component, damping of dynamic impacts and limitation of movements of the load and parts of the lifting appliance shall be ensured, if one of the components fails.

Table K.2 - Examples of duplication related to high risk class

Example of duplication	High risk class I	High risk class II
Backup brake with independent load path on single winch	X	
Single hydraulic cylinders with mechanical lock	X	
Single winch with dual load suspension system (wire ropes or chains)	X	
Dual winch with dual suspension (Single failure proof)	X	X
Dual hydraulic cylinders with independent load holding valves (Single failure proof)	X	X

K.3.2 Application of a risk coefficient

All parts of the load bearing chain which are not duplicated (non-redundant) in accordance with K.3.1, shall be designed with a risk coefficient , γ_n , according to EN 13001-2:2004 /A2:2009, clause 4.3.2.

Lifting equipment which ~~are~~ used for non-high risk operations as well as in high risk applications, may have differentiated rated capacities for those operations, where the risk coefficient, γ_n is taken as 1.0 for the non-high risk operation.

The risk coefficient shall be in accordance with Table K.3.

Table K.3 - Risk coefficient for high risk classes

	γ_n
High risk class I	Min. 1,5
High risk class II	2

K.4 Protective measures

K.4.1 Required performance level

Safety related parts of control systems for all main motions, i.e. hoisting, lowering, luffing, slewing, knuckling and telescoping, shall conform to ISO 13849-1 with the specified performance levels in accordance with Table K.4.

Table K.4 - Required performance level

	Performance level PLr
High risk class I	d or e
High risk class II	e

K.4.2 Other protective measures

As a general rule, independent back-up motion limiters of diverted technology shall be used for each motion of the main function of the crane, i.e. travelling, hoisting, lowering, luffing, telescoping, knuckling and if applicable and where the motions are limited.

Movable lifting equipment for which their stability and leveling depend on ground conditions, shall be equipped with a crane level limiter connected to the crane level indicator, which gives an immediate warning at the control station and an automatic stop of the main crane motion if the level indication exceeds the limit for safe operation. Reversal of the motions to a safe position shall not be inhibited.

Cranes with various options for rigging of the hoist load, the boom lift or the configuration of counterweights, outriggers, etc. shall be equipped with an automatic detection system which gives feedback to the control and safety system of the rigging configuration. The automatic detection system shall ensure that the setting of the control and safety system comply with the actual crane rigging configuration.

An EOS system shall be provided in accordance with clause G.4. in Annex G

K.5 Information for use

The information for use shall specify in detail the following operational precautions for high risk applications:

- Requirements for skills and training of personnel involved in high risk operations
- Requirements for operation, inspection and maintenance of non-redundant and duplicated components and their control and safety systems, including checks and tests to be performed prior to high risk operations

- Requirement to perform a specific operational risk analysis whenever the crane is going to be used in high risk applications
- Requirement to minimize exposure of hazardous situations by detailed planning of lifting routes including:
 - Minimize kinetic energy of the load and the crane by using low speed and limited speed changes during all operations
 - Minimize potential energy by keeping the potential falling height of the load, crane components and the overturning moment at a minimum at all operations
- Operational limitations due to the environment, such as sight, wind, wave heights etc.
- Provisions to mechanically protect critical equipment in the working area or vicinity of the lifting equipment against collision with load or parts of lifting equipment, as far as practically possible, before lifting operations are carried out,
- Requirements for any lifting accessories to be used in high risk applications

The above mentioned operational precautions shall be given in the instruction for use, ref. clause 5.25.3.

