

7500 User Manual



LIFE IONIZER





Table of Contents

Safety Guide	4-8
Installation of Parts Guide	10
Production of Ionized Water	11
Operation Warnings	12-13
Operation Method	14
Indicator Functions	15
Installation Guide	16
Installation Instructions	17
Internal Filter Replacement	18
Filters	19
Explanation of Ionized Water	20
Alkaline and Acidic Water Usage Guide	21
Uses for Alkaline Ionized Water	22-23
Uses for Acidic Water	24
Performance Features	25
Common Problems and Solutions	26-27
Installation of the Pre-Filter	28
Acidic Cleaning Instructions & Routine Maintenance	29
Frequently Asked Questions	30-41





Safety Guide - Read Completely

Before installation or operation of the LIFE Ionizer™, read this instruction manual completely.





Note- Some parts may have been altered to improve product quality, function or ease of use.

Symbols

Refer to the following key symbols and indicators throughout the manual.

	Improper use may cause bodily injury
	Improper use may cause structural damage to the unit or physical injury
	Improper use may cause serious injury or death

Indications

	Caution, warning, danger symbol
	Information on prohibited functions and uses
	Make note of important information
	Do not open as it may cause electric shock or other injury
	Disconnect power plug in case of malfunction



Improper use may cause bodily injury



When drinking Ionized Alkaline Water - Do not take prescription or other medications for approximately one hour before and after drinking water.



Improper use may cause serious injury or death







This machine should not be repaired or otherwise disassembled by any unauthorized person as it may cause electrical fire or shock, and will void the manufacturer's warranty.



Do not place the machine in humid areas such as bathrooms. Do not clean this machine by spraying the ionizer with water as it may cause electrical shock.



Improper use may cause serious injury or death

	Power cord should not be touched with wet hands.
	If the ionizer machine falls into water- 1. Unplug power cord from electrical outlet 2. Wipe the machine down and place in shaded area 3. Contact your LIFE Ionizer™ dealer
	Use only (110v) in the U.S.A. and Mexico. Use (100v) in Japan. Most other countries require (220v). The power cord cannot be altered from manufacturer's specs. Do not crimp or staple the power cord as it could cause electrical shock.
	Power cord should be plugged directly into an electrical outlet.
	Do not connect multiple appliances into a single power receptacle.
	Dusty or dirty electrical outlets may cause safety issues.
	Bending, twisting, pulling or putting heavy objects onto the power cord may cause electrical problems including fire.
	If power cord, plug, or electrical outlet are damaged, discontinue use immediately.



Improper use may cause bodily injury

	Place machine in an upright position only.
	Do not install this unit in direct sunlight or near a heater, fireplace or other heat source.
	Do not use water with a temperature of over 104 degrees Fahrenheit or 40 degrees Celcius.
	If wall mounted, secure firmly and correctly.



Improper use may cause structural damage to the unit or physical injury

	If not used for several days, run water through the unit for 1 to 3 minutes before starting.
	If inexperienced with drinking Ionized Alkaline Water, users are encouraged to start with lever 1.
	Store Ionized Alkaline Water in an air-tight glass container and refrigerate for up to 2 days.
	DO NOT DRINK ACIDIC WATER. Do not store Alkaline or Acidic water in metal containers.



Improper use may cause structural damage to the unit or physical injury

	Aluminum and brass containers will be tarnished by Alkaline and acidic water.
	<p>When handling the pH test (reagent drops)</p> <ol style="list-style-type: none">1. Keep away from eye area. If eyes become irritated, flush thoroughly and consult a doctor.2. If accidentally swallowed, drink water and consult a doctor.3. Store in an airtight container away from the reach of children.4. Drops are flammable. Keep away from children.
	<p>Do not block the unit vent as it can cause overheating and/or electrical problems.</p> <p>Do not block the water passage or tubing.</p> <p>Do not use benzene, thinner, or chemicals to clean the unit as it can damage the housing.</p>
	<p>If the machine will not be used for several days...</p> <ol style="list-style-type: none">1. Unplug the power cord from the electrical outlet2. Turn off the water valve to avoid leaking3. Remove filters, drain and place in refrigerator in plastic bags.





Installation of Parts Guide

Parts

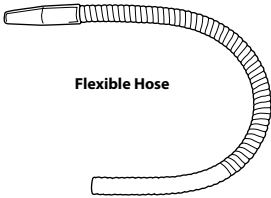

Flexible Hose



EXTRA
FUSE



Reagent Drops
(pH Test Drops)
BTB Chemical



Wall - Mount Nail

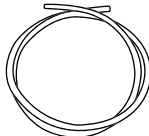

Tubing Hose



Diverter





User Manual

Installation guide

1. Refer to the diagrams on the following page before beginning installation.
2. Be aware that a 110v outlet (USA) or 220v outlet is required. If the outlet is located under the sink, make sure it is not near the water source.
3. If after installation the water has an odor, you may need to install a pre-filter. Please consult your LIFE Ionizer™ dealer.
4. How to use reagent drops. (BTB Chemical). Put 2-3 drops in approximately 1 ounce of water to be tested. Compare color to color chart provided in kit to determine pH level.

Production of Ionized Water

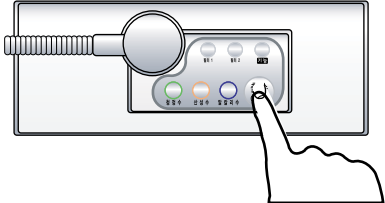
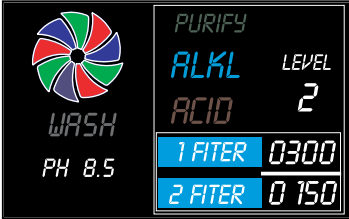
“ERR 1” will appear as shown in Fig. 1 if water pressure is low. Please check...

	<ol style="list-style-type: none">1. Press the main water flow button on top of the product.2. Select the water type – Alkaline, Acidic, or Purified setting.
	<ol style="list-style-type: none">3. When the “Alkaline” is selected, the LCD indicates the Alkaline setting and level.
	<ol style="list-style-type: none">4. According to the selected step, the LED indicates the pH of the water.



Notice

(Fig. 1)



When you select the main water flow button while the water pressure is low or valve is closed, the LCD will appear as “Fig. 1” Please check the water pressure or valve opening before proceeding.

! Operation Warnings

Operation Warnings

DO NOT run the following types of water through the LIFE Ionizer™ as it can cause damage to the unit.

1. Dirty or Salty Water
2. Water containing high amounts of rust or iron
3. Water above 40 degrees C or 104 degrees F



Read these instructions thoroughly before attempting installation.

Parts for the Ionizer (Front)

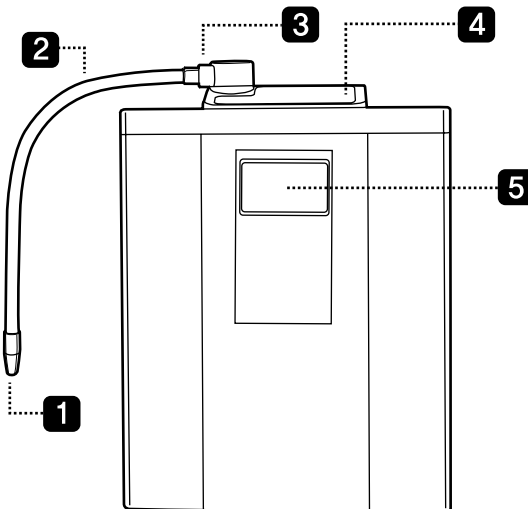

1. Water Spout
2. Water Hose
3. Flexible Hose Connector
4. Control Panel
5. LCD panel

Parts for the Ionizer (Back)

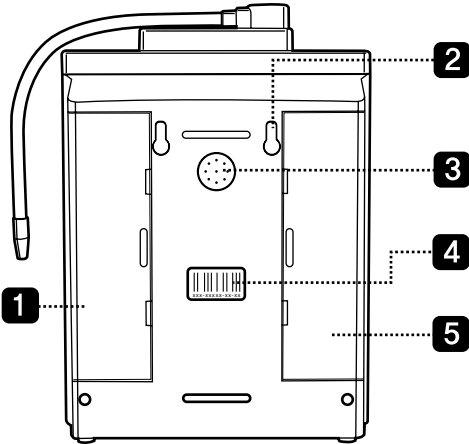





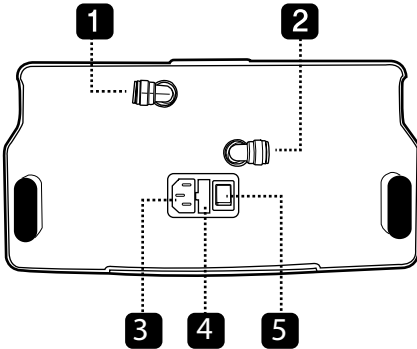



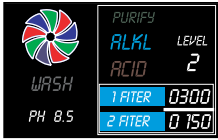
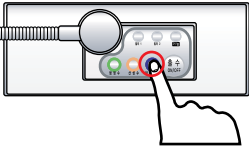

1. First Filter Cover
2. Wall Mount Screw Holes
3. Speaker
4. Bar Code and Serial Number
5. Second Filter

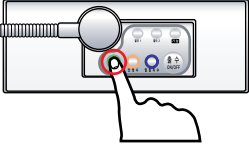
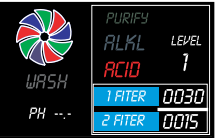
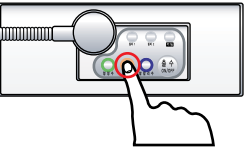
Parts for the Ionizer (Bottom)

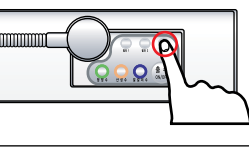

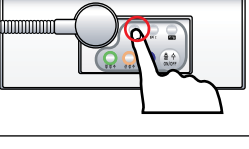
1. Outlet valve
2. Inlet valve
3. Power Plug
4. Fuse Box
5. On/Off Power Switch

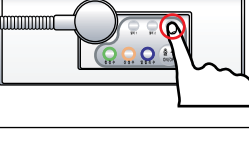
! Operation Method

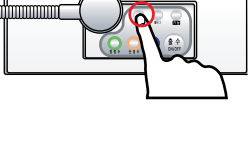
Display Window	Operation Method	Description
		When "Alkaline" water is chosen, Levels 1 to 4 can be selected by pressing the "Alkaline" button again.
		When "CLEAN WATER" is selected, pH is not indicated. The "ALKL" and "ACID" LEDs go off.
		When "ACID WATER" is selected, Level 1 or 2 can be selected by pressing the "ACID WATER" button again.
		When "FUNCTION" is selected, The menu changes from the main menu to FN1 and FN2 and then back to the main menu.
		When replacing the filter while on the main menu, press the "1ST FILTER" or "2ND FILTER" button and hold for 5 sec. This resets the filter counter to 0000. The filter count goes to 9999.
		When FN2 is selected with the "FUNCTION" button, the amperage setting can be adjusted from 0 to 4 by pressing the "2ND FILTER" (increase) and "1ST FILTER" (decrease) buttons.
		FN1 is the volume menu. Levels 0 to 4 can be selected by pressing the "2ND FILTER" (up) and "1ST FILTER" (down) buttons to increase or decrease the volume.

! Indicator Functions

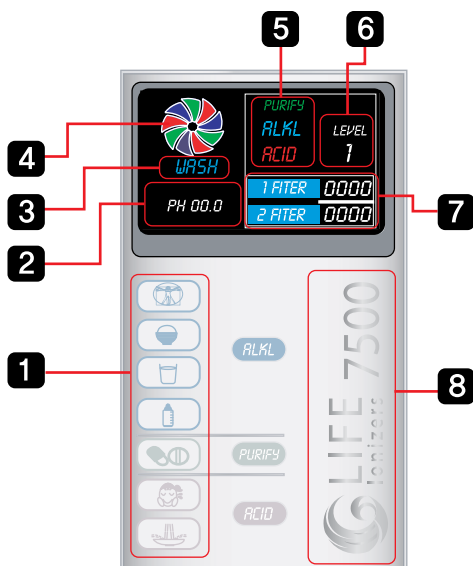

1. Drinking method indicator
2. pH indicator
3. Indicates "Being Washed"
4. Rotates while cleaning
5. Indicates ion water type (Alkaline, acidic, purified)
6. Indicates selected ionization water setting
7. Filter life - indicator
8. LIFE Ionizer™ Logo

Voice Functions

Voice: Please wait a few seconds as the machine is cleaning itself.

Water Cleaning

*Please wait a few seconds... as the machine is cleaning itself.

Ionized Alkaline Water

*4th grade of Ionized Alkaline Water is being extracted now.

*3rd grade of Ionized Alkaline Water is being extracted now.

*2nd grade of Ionized Alkaline Water is being extracted now.

*1st grade of Ionized Alkaline Water is being extracted now.

Acid Water Button

*2nd grade of acid water is being extracted now.

*1st grade of acid water is being extracted now.

Purified Water Button

*1st grade of clean water is being extracted now.



Installation Guide

Assembly method of valve for Deck sink water taps

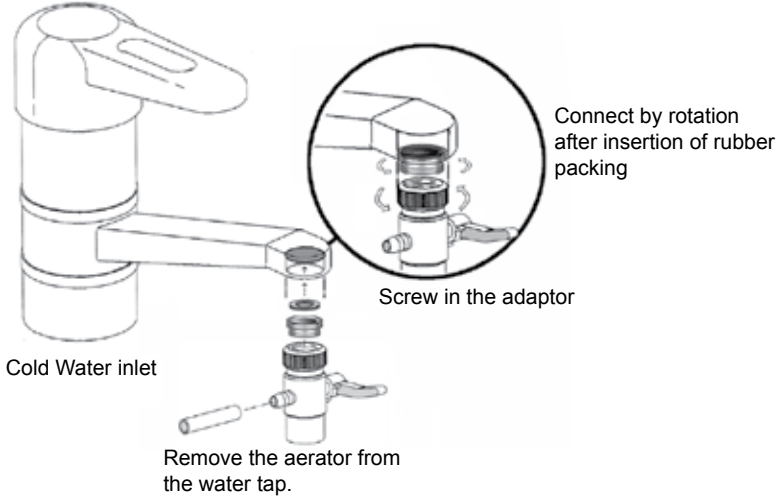

Assembly method of valve for wall-mounted water taps

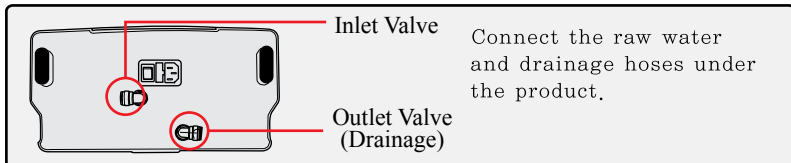
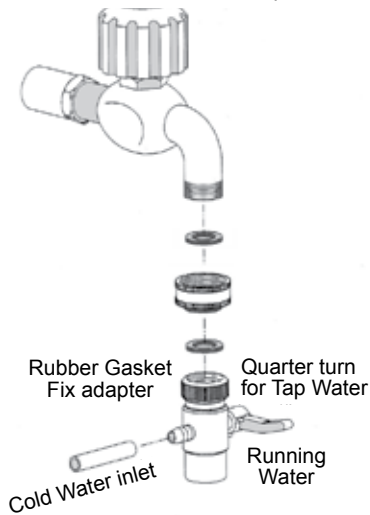



Installation Instructions for LIFE Ionizer™ 7500

* For installation video, go to <http://www.lifeionizers.com/support/LIFE Ionizer 7500>

Use Cold Water Only With Your Ionizer

STEP 1: Unscrew the existing aerator from your faucet.

STEP 2: Use teflon plumbers tape on the threads. Screw the LIFE Ionizer™ diverter valve onto your faucet. Three different sized adaptors are included for non-standard sized faucets.

STEP 3: Unscrew the round nut from the side of the diverter valve. Slide the nut over the end of the 1/4" tubing and then screw the nut back onto the diverter valve. Tubing should now fit snugly onto the diverter valve.

STEP 4: Lay the ionizer down on its back and you will see two white elbows extruding from the bottom of the machine. There will be an off-white collar around the base of the elbow. Depress the collar towards the machine while simultaneously extracting the elbow from the machine. Now, holding the elbow in your hands, you'll see a similar collar near the end of the elbow. In the same way as you extracted the elbow, you can depress the collar towards the elbow and extract the plug from the end of the elbow. It is sometimes helpful to use the back of a butter knife or screw driver to remove the plug. If you ever need to remove the tubing from the quick release, you will use the same process.

STEP 5: Run tubing from the diverter valve to the inlet valve on the bottom of the ionizer. Be sure to push the tubing into the quick connect valve 3/4" until it is firmly seated.

STEP 6: Insert one end of tubing into outlet valve on bottom of unit and run the other end into the sink securing it with the suction cup provided. Some units may contain water. Don't be alarmed; we test units for quality before shipment!

! Internal Filter Replacement

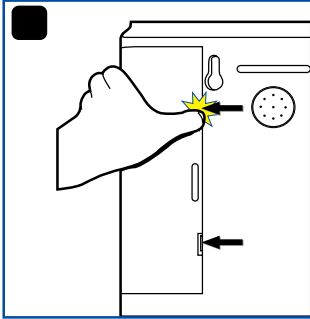

1. Press the top and bottom of the filter cover.

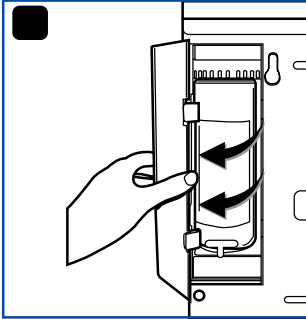

2. Open the filter cover following the direction of the arrow.

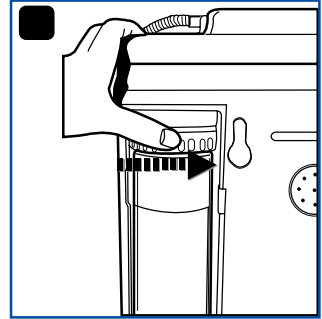

3. Turn the filter top in the arrow direction.

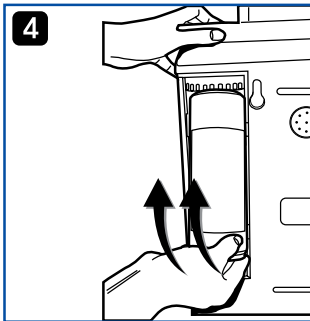

4. Lift the filter up and out following the direction of the arrow.

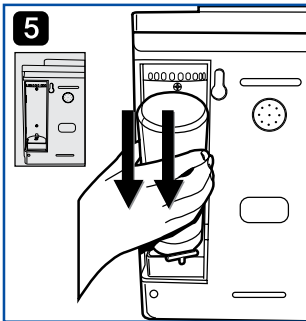

5. Insert the new filter following the direction of the installation arrow and turn the filter bases appropriately.

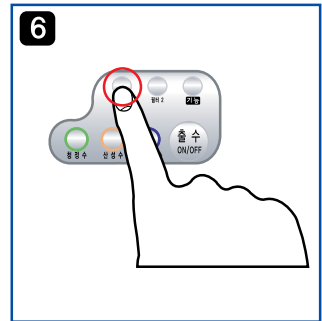

6. After replacing filter #1, press **1st filter** button for 8 seconds to reset filter counter. To reset filter #2, press down **2nd filter** button for 8 seconds.

Tips After Filter Replacement:

- 1) Select the "Purified Water" setting and let the water run for 3-5 minutes after any filter replacement.
- 2) If the machine has not been used for a few days, let the water run for 3-5 minutes at the "Purified Water" setting before making Ionized Alkaline water for consumption.
- 3) Consult with the installer or retailer on the purchase of filters if in question about usage or installation.



Filters

First Filter: Filter A

1. Sediment

Eliminates sediments (mud, rust, sand, etc) 10 microns or larger.

2. Pre-Carbon

Absorbs and eliminates various compounds, remaining chlorine, taste and odor, THM, etc.

3. Activated Carbon Filters

Ultra-fine coconut shell carbon and silver impregnated carbon.

4. Final Stage Sediment Filter

Reduces filter remnants and remaining sediments.

Second Filter: Filter B

1. Granule type Carbon Filter

Reduces chlorine taste and odors, fast absorbing, generates low dust.

2. Pi-Ceramic Negative Ion Filter

Generates negative ions, making water clusters smaller.

3. BioMass ball-Ceramic Filter - High quality ceramic filter designed for bacteria control.

4. Vitamin C Ceramic Technology™

For the reduction of Chlorine and Chloramines.

5. Special Quality Sediment Filter

Prevents sediment discharge.



Explanation of Ionized Water

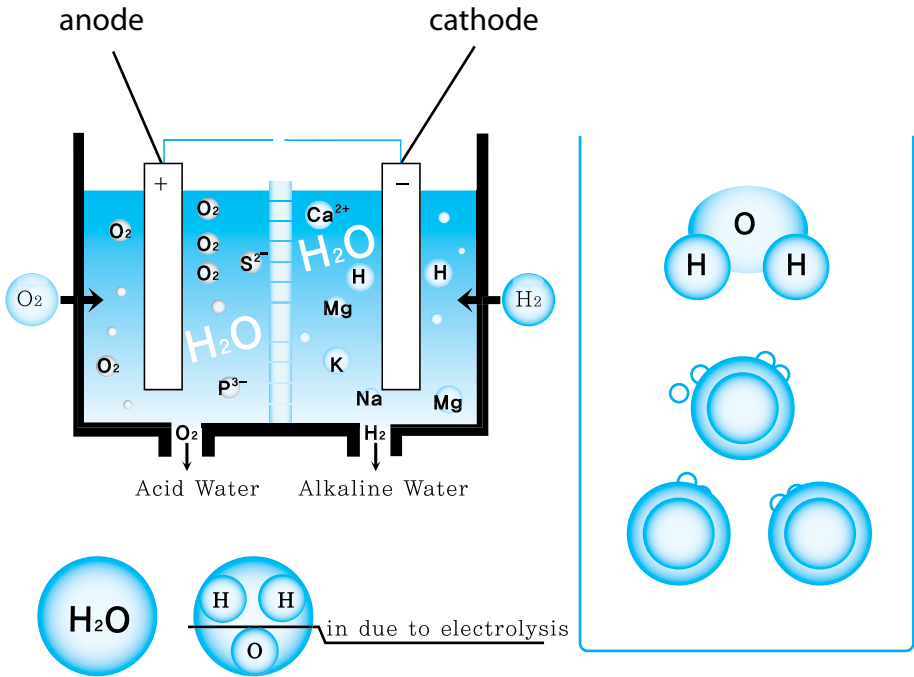

With electrolyzed water, the cathode (-) produces Alkaline Ionized Water with minerals (pH scope 7.5~10) - such as Ca, K, Mg, Na, etc. because of the hydroxyl ion (OH⁻) generating reaction.

The anode (+) has lots of hydrogen (H⁺) (pH scope 3.5~6.5) because the oxygen gas (O₂) generates a reaction and acid ion water has many ions such as Cl, S, P.

The Ionized Alkaline Water and acid ion water made by an electrolytic reduction water generator, has characteristics like those below.

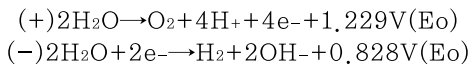



Alkaline and Acidic Water Usage Guide

Alkaline Water Usage Guide

1. If the machine has not been used for several days, let the water run on the "Purified Water" setting for at least 3-5 minutes before any operation.
2. First time users who are not familiar with this water are recommended to start with Ionized Alkaline Water level 1 and adjust the quantity or level of water which might fit you the best. Increase slowly over time as your body adjusts. (Level 1 is recommended for first time Alkaline Ionized water drinkers).
3. Store Ionized Alkaline Water in an airtight glass container and put it in a refrigerator for no longer than 2 days for maximum benefit. The first 12 hours after ionization the water is most effective.

Acidic Water Usage Guide

Acidic water is not drinkable – DO NOT DRINK

1. Use acid water only for disinfecting, cleaning, plants and as a face/skin toner.
2. Acidic water properties are the best 1-7 days after ionization if it is put in an airtight glass container and kept refridgerator.

Purified Water Usage Guide

1. Clean water is chlorine free due to the internal ionizer filters and ionizer pre-filters.
2. It is best to drink purified water when taking medication.
3. Can a person drink Ionized Alkaline Water when on medication?
-Yes, as a precaution DO NOT DRINK Ionized Alkaline Water 45 minutes to one hour before and after taking medication or supplements.

Please note that water will come out of both spouts when dispensing water.

- A) When the Alkaline button is pressed, Alkaline water will be dispensed from the top spout and acid water will be dispensed from the bottom spout.
- B) When the Acid button is pressed, Acid water will be dispensed from the top spout and Alkaline water will be dispensed from the bottom spout.
- C) When the purify button is pressed, purified water will be dispensed from the bottom and top spouts.



Uses for Ionized Alkaline Water

Highly Ionized Alkaline Water: pH 11.0+

Highly Ionized Alkaline Water preserves hygiene in our daily life due to its strong cleaning effect.

Food Preparation: Wash Vegetables and fruit.

Cleaning: Clean cutting boards with. Good for cleaning oil and tough grime from vents, as well as for general cleaning in the kitchen.

Stain Removal: The extra strength, absorption power will remove coffee, soy sauce and oil stains with ease. Also great for getting out stubborn toilet bowl stains.

Dishes: Use less detergent when hand washing dishes. Save on water bills, as only one-third to one-fourth of the usual amount of water is adequate cleaning and for rinsing with detergent.

pH Water: 8.0-10.0

Absorbing, dissolving and heat conducting benefits.

Drinking: Drink 2- cups of Ionized Alkaline Water first thing in the morning. It is important to include vegetables in your diet. Eating substantial amounts of acidic food such as egg yolk, white rice, chicken, pork and beef may be part of your diet. Drinking Ionized Alkaline Water is equally important because it balances the acidic and Alkaline effects of these foods.

Food Preparation: Clean vegetables and fish. Enhance the flavor of broccoli, onions, etc. by pre-boiling them in Ionized Alkaline Water. Use less condiments and salt in your diet.

Rice: Use Ionized Alkaline Water for washing and cooking rice. The result is delicious and fluffy rice.

Tea: Taste and aroma are everything to many people. You will be surprised at the improved color, taste, and aroma. You can use less tea and still achieve a full rich taste.

Soups and Stews: Ionized Alkaline Water draws out the flavor of ingredients so they get tender and juicy. Therefore, less seasoning such as salt and soy sauce are needed. This water is good for people who want to reduce their salt intake.

Plants: Watering plants and flowers. Ionized Alkaline Water extends the freshness and life of plants. Ionized Alkaline Water with a pH level of 9.0 can also restore the health of sick plants. Ionized Alkaline Water stimulates germination and improves seeding development.

Animals: Your animal's health will improve dramatically. Unpleasant body odor will decrease, as well as the odor of feces and urine.

Crafts: Excellent for dyeing cloths, as well as other craft projects. You will love the vibrant colors obtained when using this water.

Health: Through continuous use, the acidic tendency of your body can be gradually corrected to an Alkaline levels. Drink at least half your body weight in ounces in order to gradually change an acidic level to a slightly Alkaline one.

Colon cleansing: Warm the water to body temperature and use the colon cleansing unit to remove accumulated debris and waste.

Other Uses: One theory is that this water reduces free radicals. Recently, this water has been acclaimed as "Free Radical Water". It slows down aging and stabilizes body temperature.

pH Water: 7.0

Free of chlorine, rust and cloudiness. Clean water is delicious drinking water.

Children: Use purified water with a pH of 7.0 when preparing baby food.



Uses for Acidic Water

pH Water: 4.0-6.0

Face wash: The astringent properties of acidic water are effective in toning and firming your skin. Pat the skin and leave to dry. This water is also excellent as a toner after shaving.

Hair Care: Use this water to rinse your hair after shampooing. Reduces annoying tangles and brings out a radiant shine. Keep in a spray bottle and spray your hair and face when you're out and about.

Bath Water: Add acidic water to your bath water to keep your tub free of bathtub rings. Bathing in this water gives your body a warm and comfortable feeling.

Pet Care: Spray your pet with this water and brush afterwards to obtain soft and shiny fur. Great for grooming your pet!

Rinse Cycle: Soaking with acidic water before the spin cycle will soften your clothes.

Cooking beans: Various types of beans, such as kidney beans and green peas, will cook to perfection. Just be careful not to overcook your beans. Acidic water will speed up the cooking time! This is energy saving water!

Fried Food: Fried food comes out nice and crispy.

Frozen food: Spray foods with acidic water when freezing so that the food, including fish and shrimp, does not lose its flavor when thawed.

Stains: To remove stains, grime and grease, leave to soak in water for 24 hours.

Dishes: Dishes and glasses come out sparkling clean.

Polishing: Polish mirrors, eyeglasses, glass objects and windows to a high sheen.

House Cleaning: Remove dirt from hardwood floors, ceramic tiles, etc. without leaving a sticky residue.



Performance Features

LIFE MESH Technology™ – Our MESH technology is designed so the water moves in and out of the plates thus creating more contact time and better electrolysis. This translates into a higher pH and better ORP (Oxidation Reduction Potential = Antioxidant).

Better machine = Better results.

Power System- Combine MESH Technology with our new advanced SMPS Power System (the same system used in High Definition Televisions) and your LIFE Ionizer™ will outperform any other model. Some systems attempt to convince you that bigger plates are better. The best results (high pH & ORP) are from a combination of the plates and the power provided. The LIFE Ionizer™ has a Power 5 Amperage System™ that delivers up to 208 watts of power. More Power = Better Results. Your system will also run more efficiently providing more consistent power and will last much longer.

UV Light System- We have recently introduced LIFE UV Light Technology™ as an optional feature on our Life Ionizers. UV light dissipates bacteria as the water passes around the secure light inside the unit. This helps to further the filtration effects on public water supplies. Major municipal water sources such as New York City and Orange County, CA currently use UV light technology as added treatment to disinfect their water.



Common Problems and Solutions

Condition	Possible Problem	Solutions
<ul style="list-style-type: none">• The power light is not on or the power switch doesn't seem to work.	<ul style="list-style-type: none">• Unit may not be plugged in correctly.• Unit may be plugged into an outlet controlled by a switch.• Fuse at the bottom of the machine may be blown.	<ul style="list-style-type: none">• Make sure power plug is plugged into outlet correctly.• Plug unit into an outlet that is constantly 'hot'.• Replace the fuse at the bottom of the unit.
<ul style="list-style-type: none">• Water volume is low or doesn't come out of the unit.	<ul style="list-style-type: none">• Angle Valve Adapter and/or cold water supply are turned off.• One or more of the water supply tubes is crimped.• House water pressure is too low.	<ul style="list-style-type: none">• Make sure all water supply valves are open.• Check all hoses and tubes.• Water pressure may be low for many reasons (RO system, sprinkler system, etc) Call LIFE Ionizer™ Tech Support for assistance.• If unit has been used for 6 months or more, replace filters as needed.
<ul style="list-style-type: none">• Tubing is leaking.	<ul style="list-style-type: none">• Tube is not seated properly or there is a hole in the tubing.	<ul style="list-style-type: none">• Disconnect and reconnect tubing making sure it is seated 3/4 inch deep or replace tubing.
<ul style="list-style-type: none">• Pre-filter is leaking.	<ul style="list-style-type: none">• Tubing to pre-filter is not seated deeply enough.• O-Rings inside the pre-filter are not seated correctly or are being crimped due to housing cover being on too tight.	<ul style="list-style-type: none">• Disconnect and reseal tubing at least 3/4 inches into filter.• Disconnect tubing and unscrew housing cover. Make sure O-Rings are seated properly.



Common Problems and Solutions

Condition	Possible Problem	Solutions
<ul style="list-style-type: none">Water has an unpleasant odor or taste.	<ul style="list-style-type: none">The internal filters may need to be replaced.Water source requires a pre-filter or RO* filter.	<ul style="list-style-type: none">Call your dealer to place an order for new filters.Call LIFE Ionizers™ for a water quality report for your area.
<ul style="list-style-type: none">Filter warning lamp is on after replacement of filter.	<ul style="list-style-type: none">Filter button on faucet may need to be reset.	<ul style="list-style-type: none">Reset filter button by following instructions on page 14.
<ul style="list-style-type: none">Unit is making an unusual noise.	<ul style="list-style-type: none">The problem is internal and requires a qualified technician.	<ul style="list-style-type: none">Unplug the unit from the power source and call Technical Support.
<ul style="list-style-type: none">Ionizer is leaking.	<ul style="list-style-type: none">The problem is internal and requires a qualified technician.	<ul style="list-style-type: none">Unplug the unit from the power supply and call Technical Support.

* Reverse Osmosis: Check all external hoses and fittings



Installation of the Pre-Filter

1. Cut the tubing leading to the ionizer at the desired location and length.
2. The cap on top of the filter housing is marked "OUT" and "IN".



3. The tubing coming from the cold water connector needs to be inserted into the side of the housing marked "IN". Firmly press the tubing into the filter-housing cap. You will feel the tubing stop when it is fully inserted. Pull on the tubing gently to ensure that it does not come out and a good connection was made. If possible, flush the filter by turning on the flow of water slowly and point the "OUT" towards the sink; let it run for 2-3 minutes and turn the water flow off.



4. Insert the tube going to the ionizer into the side of the housing marked "OUT" by firmly pressing the tube into the filter housing cap.
5. To remove the tubing from the filter cap, press in on the O-ring and tubing simultaneously, then gently pull out on the tubing.





Acidic Cleaning Instructions & Routine Maintenance

Many locations have excessive mineral content in the source water that can build up inside the ionizer over time and cause blockage. A routine acidic cleaning of the ionizer chamber can help maximize the life and performance of your ionizer by reducing the build up of these harmful minerals.

In areas with heavy mineral content, this is recommended once a week. It is also recommended to do this procedure in the evening as it takes several hours to be effective.

- Run the ionizer on acid level 2 for one minute.
- Turn off the source water to the ionizer.
- Let the water “soak” in the chamber overnight (several hours).
- Run the unit again on acid level 2 to rinse the minerals from the machine.
- Return the unit to normal operation.

Frequently Asked Questions

Q: What should I expect from drinking Ionized Alkaline Water?

A: This will initially depend on what level of strength you begin drinking Ionized Alkaline Water. Ionized Water provides your body with lots of oxygen, which is why it gives us energy. Ionized Water is much smoother tasting than conventional water. It makes better coffee, tea, juice, etc. Ionized Alkaline Water is wonderful to cook with because it helps hydrate the food and bring out its flavor. However, other changes in your body will be much more subtle. If you have accumulated acid waste in your system, it probably took years for you to get into that condition and it will take some time to reverse it. As the body is slowly brought into pH balance by drinking Ionized Water, it will naturally begin to function more efficiently and problems will begin to correct themselves.

Q: Who should drink Ionized Alkaline Water?

A: People, pets and animals will all notice benefits from drinking Ionized Alkaline Water.

Q: Is there anyone who should not drink Ionized Alkaline Water?

A: Some people must start by drinking very small amounts of Ionized Alkaline Water, such as 8 oz. of strength level 1 (one) per day. This is especially true of the elderly who often have unfortunately allowed heavy metals and other toxins to accumulate in their bodies. Sometimes years of medication has accumulated in them as well. Children 3 years and younger should not drink Ionized Alkaline Water. They may only drink the purified water from the Ionizer. Children between the ages of 4 years and 12 years should only drink Ionized Alkaline Water at strength level 1 (one)

and strength level 2 (two). Children between the ages of 4 and 12 years of age should never drink Ionized Alkaline Water at strength level 3 (three) or strength level 4 (four).

Q: Should I take medication or supplements with Ionize Ionized Alkaline Water?

A: You should not drink Ionize Ionized Alkaline Water 45 minutes to 1 hour before or after taking medication or supplements. Use purified water or another liquid or water source.

Q: Can a person become too Alkaline from drinking Ionized Alkaline Water?

A: People have been known to drink as much as 1 to 2 gallons of Ionized Water every day with great benefit. Conversely, one of the most common imbalances people have today is that they are too acidic. Our body's pH should be approximately 7.2 (measured through saliva or urine). It is rare for a person to acquire Alkalosis, the condition of being too Alkaline. We should always drink Ionized Alkaline Water and eat Alkaline Foods such as fruits and vegetables.

Q: How much water should I drink and at what level?

A: At a minimum, you should drink half your body weight in ounces per day. For example, a person weighing 100 pounds should drink 50 ounces. You should start slow at strength Level 1 (one), drinking 1-3 glasses per day for the first week. You may increase the number of glasses per day during the first week if you do not notice any side effects. If you do not feel any flu like symptoms at the end of the first week, move up to strength Level 2 (two). On strength Level 2 (two), drink 1-3 glasses per day for the first week. You may increase the number of glasses per day during the first week if you're feeling good. On average, two to three weeks per level; work your way up to a 10.5 pH (strength Level 4 (four)). The higher the strength level of Ionized Water you can drink, the

better it is for you because the water is more Alkaline, more Detoxifying, and a stronger Antioxidant that provides your body with more Oxygen.

Q: When will I begin noticing the health benefits?

A: It varies from person to person. You might start noticing a positive response in as little as one day or within a few weeks.

Q: Why do some people have flu like symptoms when first drinking Ionized Alkaline Water?

A: If you start drinking Ionized Alkaline Water at to high strength level (high pH level) then you might notice flu like symptoms. The Ionization process creates water molecule clusters that are half the size of regular water molecule clusters. This is why Ionized Alkaline Water is sometimes referred to as “reduced water” because it has become reduced in size from a 12 water molecule cluster to 6 water molecule cluster. This makes the water much more hydrating because it flows through our body tissue more easily, thus pushing toxins out of our system. It is this detoxifying effect that sometimes gives people headaches and diarrhea and why there are 4 levels of strength.

Q: How does Ionized Alkaline Water affect athletes?

A: In an extremely positive way, as you might expect. Blood oxygen levels will rise at varying amounts with regular use of strong Ionized Water. This increases stamina, endurance and provides the muscles tissue and organs with high amounts of oxygen, which the human body often lacks, even in athletes because inadequate diets. Proper hydration sustains the body’s physiological responses in all activities, but the physical and mental stresses of athletic training and competition magnify the importance of hydration. Numerous studies conducted on athletes since the 1940s have demonstrated that even mild dehydration impairs performance. Current

thought is that athletes consuming a traditional Western diet have consumed an abundance of salt, so there is no need to replace salt when exercise last less than two hours. Water that has been alkalized may help neutralize the exercise induced acidosis (lactic acid build up), since the pH of Ionized Alkaline Water is high. Ionized water may help act as a free-radical scavenger to address the issue of accelerated oxygen consumption. Ionized water is micro-clustered, so it may be absorbed at a faster rate, helping with rehydration. Dr. Peter L. Kopko, D.C., recommends drinking 13 to 20 ounces (2-3 cups) of water 2 hours before exercise and 5 to 10 ounces (about 1-2 cups) every 15 to 20 minutes of exercise, depending on your total body weight.

Q: How long does Ionized Alkaline Water stay Ionized?

A: The Antioxidant (hydroxyl ions) will last approximately 18-24 hours. The Higher pH (Alkaline properties) will last approximately 1-2 weeks. The smaller molecule cluster size will last approximately 1-3 months. Does Ionized Alkaline Water have any negative effects? Absolutely none, as long as it is used properly. Only the Ionized Alkaline Water should be consumed. NEVER DRINK THE ACIDIC WATER.

Q: Should Pregnant Women Drink Alkaline Water?

A: We at Life Ionizers are often asked the question as to whether alkaline, ionized water should be consumed by a pregnant or lactating woman. We believe the prudent approach is to exclude alkaline, ionized water throughout pregnancy and breast feeding. It is our understanding that due to the increased absorption of water-hydrated cations, like potassium and calcium, coupled with the increased concentration of the same cations created on the alkaline side of electrolysis, creates a too highly concentrated electrolyte solution for a developing fetus and breast-feeding infant. Switch to the purified mode during pregnancy and until breast-feeding is concluded.

Q: How does a water ionizer work?

A: Our countertop Alkaline LIFE Ionizer™ 7500 can be directly connected to a diverter valve at the end of your faucet. Connecting directly to your faucet takes about 10-15 minutes and enables your water ionizer to use a two step process. The first task is to help filter out harmful components of the water with our built-in dual filter system, which removes chlorine, trihalomethanes, phenols, sediment, odor, taste, and organic waste. The LIFE Ionizer™ achieves this by using multi-stage filters. Then the filtered water passes into a patented chamber equipped with platinum-coated titanium plates. Next, an electrical charge is introduced into this water. This is where the electrolysis takes place. The water is separated into two streams (acid and Alkaline) of Ionized water. The acid water (oxidized) makes up about 30% of the water and the Ionized Alkaline Water 70%. The reduced ionized Alkaline Water comes out of the faucet, which you use for drinking or cooking. The acid (oxidized) water comes out of a separate hose leading into the sink. The oxidation potential of the acid water makes it a good sterilizing agent, ideal for washing your hands, cleaning food or kitchen utensils, and treating minor wounds and eczema. Cations, positively charged ions gather at the negative electrode to create Ionized Alkaline Water, which concentrates available Alkaline minerals, such as calcium, magnesium and potassium from the source water. Anions, negatively charged ions gather at the positive electrode to make acid or oxidized water, which concentrates acid minerals such as nitrates, sulfides, chlorides, and fluorides from the source water. Remember in chemistry class, opposites attract. A range of pH settings from neutral to very Alkaline or very acid is available at the touch of a button. The electrodes are cleaned in an automatic cleaning cycle or you can also

run a manual cleaning cycle. The electrolysis process breaks the molecular bonding of water molecules and restructures the water clusters from usual groups of 12 or so down to about 5 or 6 molecules per water cluster. "Clustered" water is typically characterized by smaller groups of molecules, lower surface tensions and thus can more easily penetrate the cellular membrane. This clean, healthy, Alkaline Ionized Water is drawn for drinking and cooking through the main stainless steel spout.

Q: How do I know when the filter needs replacing?

A: An LED or counter indicator on the front panel gives an indication of remaining filter life. Generally the 1st filter will last for about 8 months, the 2nd filter for about 12 months (when 2.5 gallons of water is produced per day), but this depends on the source of water and the amount of use. For example, if your tap water contains between 0.4 and 1.0 ppm (parts per million) of chlorine, a filter can last 12 months for one person's use. If greater than 1.0 ppm, the filter may last 8 months. A family of four on a typical North American water supply will replace the 1st filter about every 8 months. By changing your filters at regular intervals, you are assured of the inner hygiene of the filter.

Q: Where is the serial number located?

A: On the back of the ionizer, you will see a bar code sticker. The serial number is located below the bar code.

Q: What should be done if the machine is not to be used for 7 days or more?

A: Remove the filter from the main body, wrap in plastic wrapping, and store in a refrigerator. Remove the power plug. When ready to use again, install the filter and run in the Ionizer in the 'PURIFIED' mode for approx. 3 minutes before using the water.

Q: What does it mean when water flows through the main body and it becomes warm?

A: At the start of water flow, warm water may flow out due to room temperature or heat from the main body during stoppage. This is not a malfunction. Use the machine after starting water flow.

Q: There are white substances on the bottom of my Alkaline Ionized water storage container. What are these?

A: This phenomenon is caused by the calcium mineral substances in Alkaline Ionized water. Particularly, if the carboxyl group (CO_3) is present, it will bind to the calcium carbonate (CaCO_3), creating such substances. This is apparent evidence of electrolysis. Although it is safe to drink, wash the container - add one spoon of edible vinegar and water to the container, leave the container for approximately 1 hour, and wash the container.

Q: How do I reset the filter counter?

A: When replacing the filter while on the main menu, press the "1ST FILTER" or "2ND FILTER" button and hold for 5 sec. This resets the filter counter to 0000. The filter count goes to 9999.

Q: What is hard water?

A: According to the U.S. Geological Survey, more than 85 percent of the United States geography has hard water. Hard water forms when naturally occurring minerals enter water sources. Over time these minerals are absorbed by groundwater. The two most common types of minerals found in hard water are calcium and magnesium compounds. The Water Quality Association of the United States defines hard water as water containing dissolved hardness minerals above 1 GPG (grains per gallon). The most common hardness causing minerals are Calcium and Magnesium. Levels of hardness are classified as follows:

Soft Water - less than 1 GPG,

Slightly hard - 1 to 3.5 GPG

Moderately hard - 3.5 to 7 GPG

Hard - 7 to 10.5 GPG

Very Hard - 10.5 and higher GPG

Q: How do I adjust the voice volume on my water ionizer?

A: Model 7500, The "Function" button on the top of the unit changes the choices from the main menu. Press the "Function" button on the top of the unit *one* time to get into the volume menu; you will see on the display panel in 'white' letters "Fn1". Press the "1st Filter" button located on the top of the unit to lower the volume. Press the "2nd Filter" button located on the top of the unit to increase the volume. Pressing either of the "Filter" buttons multiple times will increase or decrease the volume.

Q: Why do I want to adjust the amperage on my Water Ionizer?

A: As you know, all water sources are not created equal. Your water source plays an important role on how your water ionizer creates Ionized Alkaline Water. Being able to adjust the amperage will allow you to find the optimum pH for the best production of Alkaline Ionized water based on your water source.

Q: How do I adjust the amperage on my water ionizer?

A: Model 7500, The “Function” button on the top of the unit changes the choices from the main menu. Press the “Function” button on to the top of the unit *two* times to get into the amperage menu; you will see on the display panel in ‘white’ letters “Fn2”. Press the “1st Filter” button located on the top of the unit to lower the amperage. Press the “2nd Filter” button located on the top of the unit to increase the volume. Pressing either of the “Filter” buttons multiple times will increase or decrease the amperage.

Q: Do I need to hire a plumber to install the units?

A: Most people find it is not necessary to call a plumber for most standard installations. For custom installations, a plumber may be needed depending on the individual circumstances.

Q: What do I do if the filters are leaking?

A: It is important to note where on the filter it is leaking. Most leaking comes from fittings that are not seated properly. Reseat the tubing into the filter by pushing in firmly and then pulling back. It may be necessary to re-trim the end of the tubing to get a fresh surface. Make sure to shut off the water before working with the water supply lines.

Q: How do I set up the pre-filter unit?

A: The pre-filter is installed in the supply line on the ionizer. Quick connects are provided for your convenience. Simply push the tubing in the connector and it seals automatically. When installing the filter for the first time, it is suggested to let the filter fill with water for a few minutes before turning on the ionizer.

Q: How do I know what pre-filter I need?

A: A water report is necessary to determine what type of filter is needed. Most municipal water districts have water reports free of charge on the internet. Well water may need to be tested by an independent water testing company. If you can not find a water report for the area the necessary information, please contact your sales representative.

Q: How do I clean the internal plates?

A: You do not clean the plates. Please call our customer service department.

Q: What is the product warranty?

A: Warranty does not cover repairs caused by customer neglect or by failure to stop the build-up of calcium in hard water areas. We supply 5 stage reverse osmosis units for our customers in hard water areas - these are provided at less than wholesale costs. Neglect includes using the unit in a matter inconsistent with the directions in the owner's manual, as well as breakage resulting from dropping the unit or other carelessness. The warranty that is in effect at the time the machine is purchased is the one that is honored. Our warranty center is in the USA for your convenience. We are the oldest and largest distributors of Alkaline home, commercial

and industrial water ionizers in North America with the finest quality service second to none. We value our customers and are very grateful for referrals. This is why we promote such a generous return policy and why we can do with confidence based on 12 years of growth and happy testimonials. The international customer pays all international customs, government fees, levies and/or any other fees that are incurred.

Q: What is your return policy?

A: We invite you to try out our new range of LIFE Ionizer™ and enjoy the benefits for 60 days. We are so sure that you will be satisfied with your ionizer that we offer you a 60 day money back guarantee. If at any time in the first 60 days you wish to return your unit, we will give you a full refund, less 15% restocking fee, as long as your ionizer is returned in as new condition and in its original packing. “As new condition” means the ionizer is not scratched, damaged or broken in any way and is returned with all the hoses, connectors, parts, manuals and DVDs etc. The original shipping charges will be deducted and return shipping charges must be prepaid by the purchaser. No return can be accepted without our prior authorization. We will refuse unauthorized returns.

To validate your warranty, you must complete the warranty card and return it within 30 days of purchase. Full warranty is in effect; All Sales are final and there are no returns on merchandise purchased wholesale or through finance plans.

The LIFE Ionizer™ 3000 has a 1 year warranty and the LIFE Ionizer™ 4000 has a 3 year warranty. The following LIFE Ionizers™ 5000, 7000, and 8000 are 5 years full parts and labor. This warranty covers failures due to defects in materials and workmanship which occur during normal use. This warranty does not cover damage which occurs in return shipment, or

failures which result from accident, misuse, abuse, neglect, mishandling, faulty installation, misapplication, improper insertion of consumables, set-up adjustments, maladjustment of consumer controls, improper operation or maintenance, alteration, modification, power line surge, improper voltage supply, commercial use, or service by anyone other than a LIFE Ionizer™ authorized repair facility. LIFE Ionizers™ will repair or replace any malfunctioning ionizer for the specified time frame disclosed below.

Limits and Exclusions:

There are no express warranties except as listed above. From the date of purchase the warrantor is not responsible for incidental or consequential damage; for damages arising out of the use of any unauthorized attachment; for damages resulting from the use of the product with a defective water faucet and/or water that is judged by local authorities as “hard” (TDS above 7 grains). To keep your warranty active in “hard water” areas- please use a Reverse Osmosis unit (call one of our sales representatives for details). All expressed and implied warranties, including warranties of merchantability and fitness for particular purpose, are limited to the applicable warranty period. All machines that are used for high volume applications such as weight loss/Fitness Centers etc. will void the above warranty. The warranty is voided if parts used are not provided by LIFE Ionizers™. Company products are sold subject only to the applicable company standard printed warranty in effect at the time of sale and such warranty shall be in lieu of all other warranties expressed or implied. In addition, this equipment, technology and products have not been evaluated by the FDA, nor are they intended to treat, cure, mitigate, diagnose or prevent any illness or disease. The following technology is not intended to replace the advice of your family physician.

Contact Us

2335 Camino Vida Roble, Bldg B
Carlsbad, CA 92009

866.321.3116 (Technical Support)
760.585.1692

*When calling technical support please be prepared to give your ionizer serial number located on the back of the unit.

To view an Installation Video
for your LIFE™ 7500 visit:

www.Lifelonizers.com/Support



Don't live a little...

LIVE A LIFE