

# use & care guide

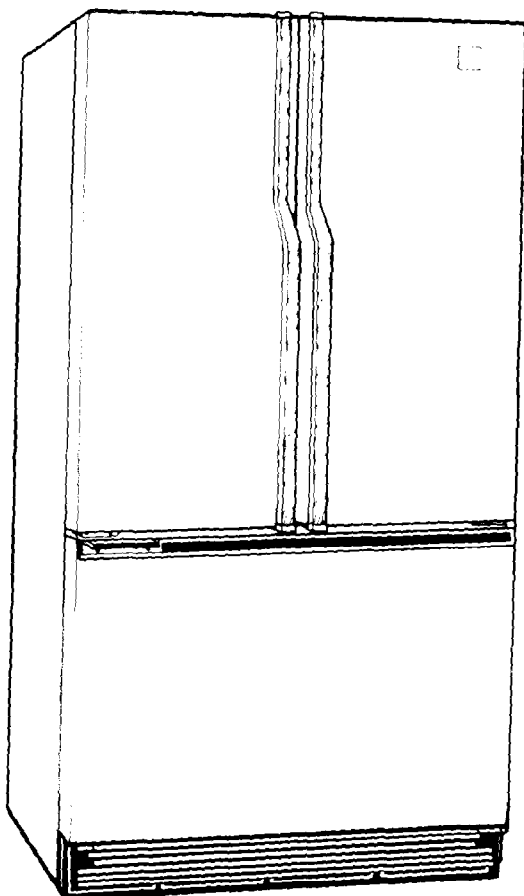

## NO-FROST REFRIGERATOR- FREEZER

Model EF19MK

Freezers, Ice Makers, Dishwashers, Built-In Ovens and Surface Units, Ranges, Microwave Ovens, Trash Compactors, Room Air Conditioners, Dehumidifiers, Automatic Washers, Clothes Dryers, Freezers

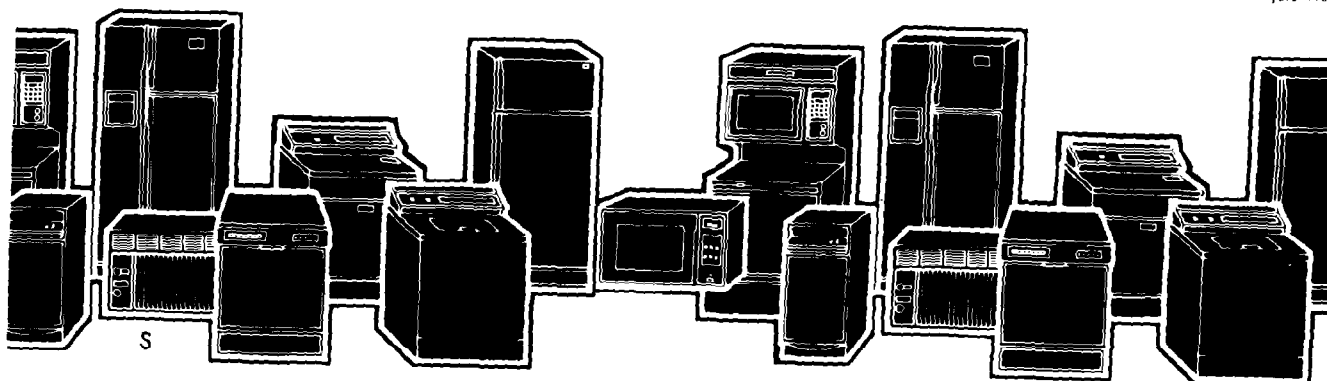

# Please read this Use and Care Guide before you do anything else...

This booklet tells you how to start your refrigerator, clean it, move shelves and adjust controls. It even tells you what new sounds to expect from your refrigerator.

Treat your new refrigerator with care. Use it only to do what home refrigerators are designed to do.

## Parts and features

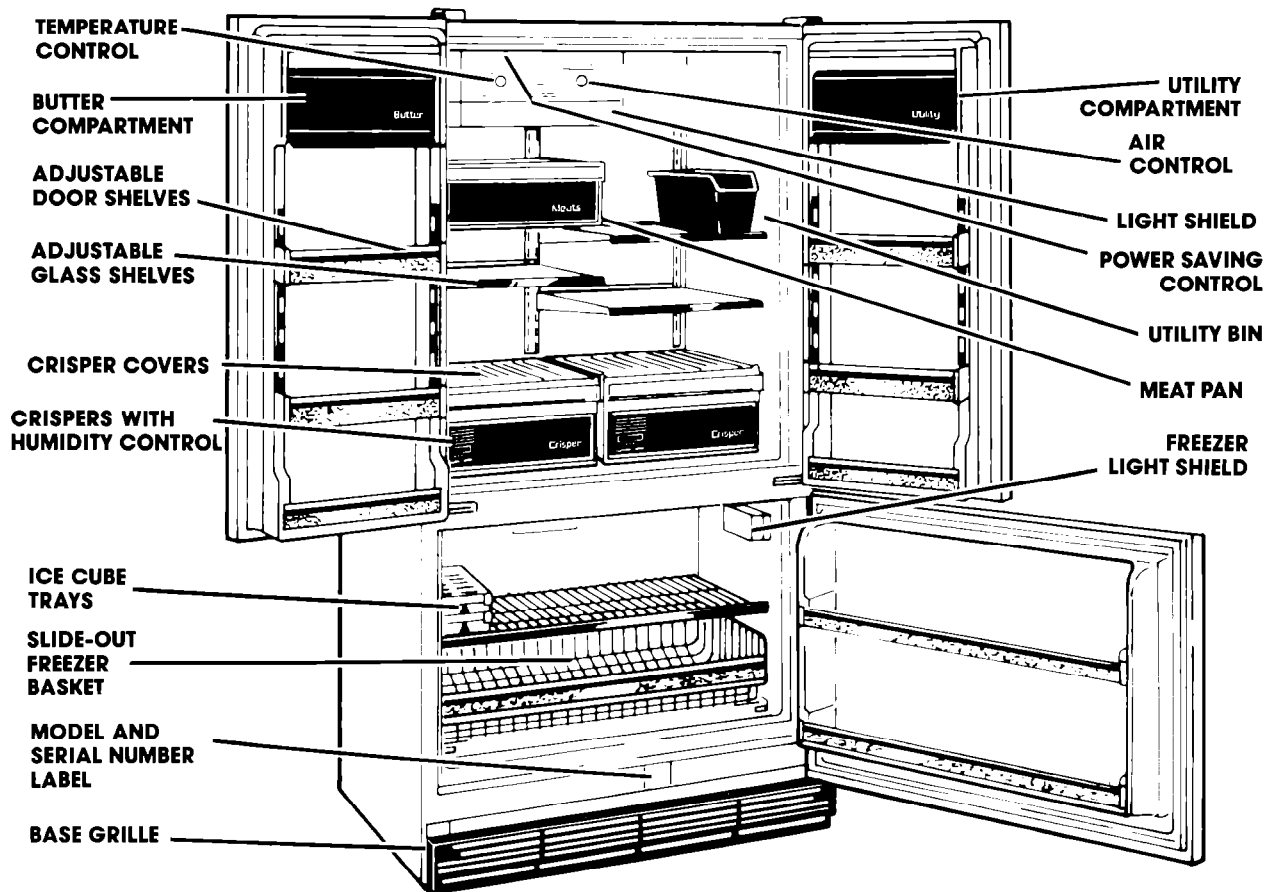

### Copy your Model and Serial Numbers here...

When you need service or call with a question, have this information ready:

1. **Complete** Model and Serial Numbers (from the label located as shown).
2. Purchase date from sales slip.

Copy this information in these spaces. Keep this book, your warranty and sales slip together in a handy place.

**Please complete and mail the Owner Registration card furnished with this product.**

Model Number

Serial Number

Purchase Date

Service Company and Telephone Number

# Contents

	Page		Page
<b>SAFETY FIRST</b> .....	3	Moving the Meat Pan .....	7
<b>BEFORE YOU PLUG IT IN</b> .....	3	Changing the Light Bulb .....	7
Install Properly .....	4	Removing the Base Grille .....	7
Level Refrigerator-Freezer .....	4	Ice Cube Trays .....	7
Remove Sales Labels .....	4	Optional Automatic Ice Maker .....	8
Clean It .....	4	Sounds You May Hear .....	8
Plug It In .....	4	Energy Saving Tips .....	8
<b>USING YOUR REFRIGERATOR</b> .....	5	<b>CLEANING YOUR REFRIGERATOR</b> .....	9
Setting the Controls .....	5	Cleaning Chart .....	9
Changing the Control Settings .....	5	<b>FOOD STORAGE GUIDE</b> .....	10
Power Saving Control .....	5	Storing Fresh Food .....	10
Adjusting Crisper Humidity Control ..	6	Freezing and Storing Frozen Foods ..	11
Adjusting the Shelves .....	6	<b>VACATION AND MOVING CARE</b> .....	14
Removing the Freezer Shelf .....	6	<b>IF YOU NEED SERVICE OR ASSISTANCE</b> ..	15
Removing the Crispers and Covers ..	6	<b>REFRIGERATOR WARRANTY</b> .....	16
Removing the Freezer Basket .....	7		

©1987 Whirlpool Corporation

## Safety first

Child entrapment and suffocation are not problems of the past. Junked or abandoned refrigerators are still dangerous...even if they will "just sit in the garage for a few days."

If you are getting rid of your old refrigerator, do it safely. Please read the enclosed safety booklet from the Association of Home Appliance Manufacturers. Help prevent accidents.

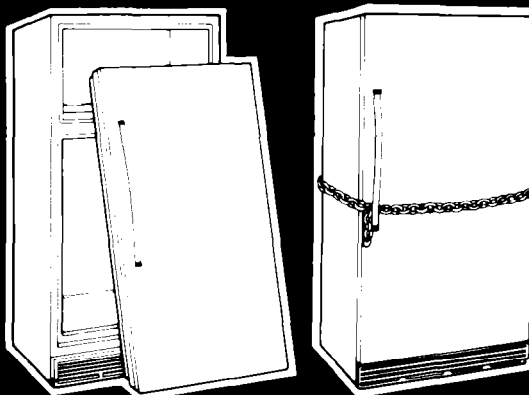

## Before you plug it in

### Important

Before using your refrigerator, you are personally responsible for making sure that it...

- is installed and leveled on a floor that will hold the weight, and in an area suitable for its size and use.
- is connected only to the right kind of outlet, with the right electrical supply and grounding. (Refer to your "Electrical Requirements and Grounding Instructions.")
- is used only for jobs expected of home refrigerators.
- is not near an oven, radiator or other heat source.
- is properly maintained.
- is out of the weather.
- is used in an area where the room temperature will not fall below 55°F (13°C).
- is not used by those who may not understand how it should be used.
- is not loaded with food before it has time to get properly cold.

## Install properly...



1. Allow ½ inch (1.25 cm) space on each side and at the top of the refrigerator for ease of installation.
2. If the refrigerator is to be against a wall, you might want to leave extra space so the door can be opened wider.
3. The refrigerator back can be flush against the wall.

## Level refrigerator-freezer...

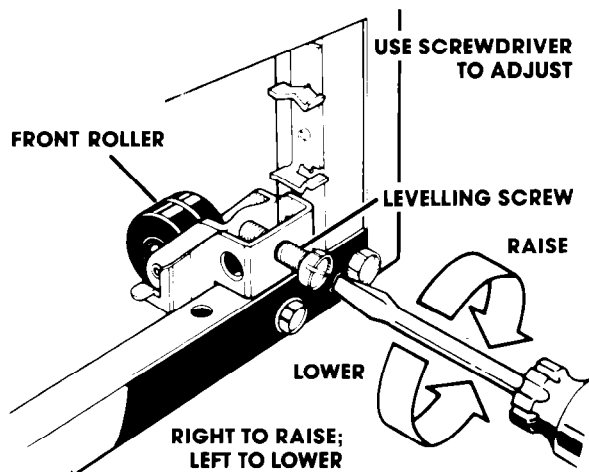

1. Remove base grille (see page 7).
2. To raise front, turn screw in direction shown.
3. To lower front, turn screw in the direction shown.
4. Check with level.

## Remove sales labels...

Remove the Consumer Buy Guide label, tape and any **inside** labels before using the refrigerator. **To remove any remaining glue:**

1. Rub briskly with thumb to make a ball then remove.

### OR

2. Soak area with liquid hand dishwashing detergent before removing glue as described in step 1.

**DO NOT USE rubbing alcohol or flammable or toxic solvents, such as acetone, gasoline, carbon tetrachloride, etc. These can damage the material.**

**NOTE: DO NOT REMOVE ANY PERMANENT INSTRUCTIONS LABELS INSIDE YOUR REFRIGERATOR.**

**Do not remove the Tech sheet fastened under the refrigerator at the front.**

## Clean it...

Clean your refrigerator before using it. See cleaning instructions on page 9.

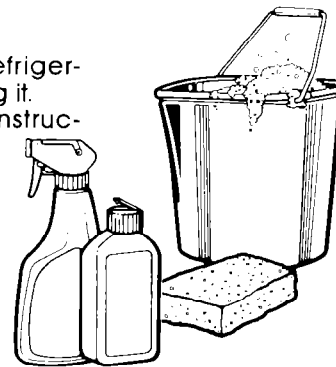

## Plug it in...

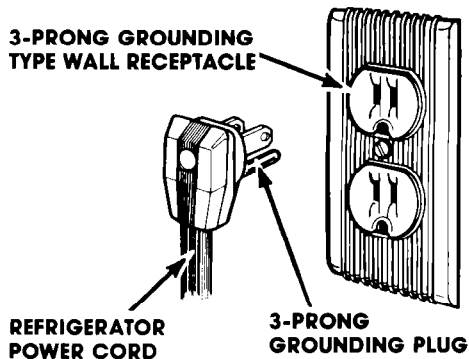

### RECOMMENDED GROUNDING METHOD

A 115 Volt, 60 Hz., AC only 15 or 20 ampere fused and properly grounded electrical supply is required. It is recommended that a separate circuit serving only this appliance be provided.

**Do not use an extension cord. Use a receptacle which cannot be turned off with a switch or pull chain.** See individual electrical requirements and grounding instruction sheet in your literature package.

# Using your refrigerator

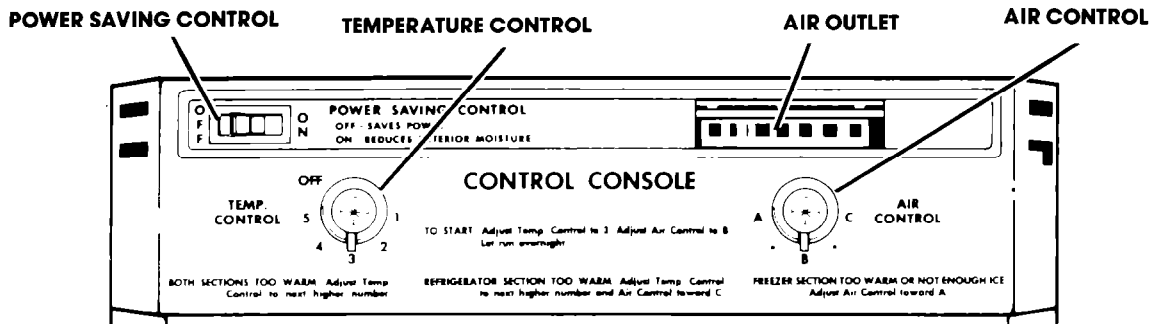

## Setting the controls...

Controls for the refrigerator and freezer are in the refrigerator. When the refrigerator is plugged in for the first time...

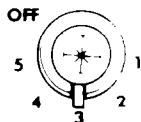

1. Set the TEMPERATURE CONTROL to 3.

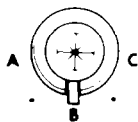

2. Set the Air CONTROL to B.

**Give the refrigerator time to cool down completely before adding food.** (This may take several hours.)

**These settings should be about right for normal household refrigerator usage.**

The controls will be set about right when milk or juice is as cold as you like and when ice cream is firm.

**Do not block the air outlet** on the control panel. Blocking it can slow the air movement needed to keep temperatures at the level you set.

## Changing the control settings...

If you need to adjust temperatures in the refrigerator or freezer, use the settings listed in the chart below.

- Adjust the Temperature Control first.
- Wait at least 24 hours between adjustments.
- Then adjust the Air Control, if needed.



**QUESTIONS?**  
...call your COOL-LINE® service assistance telephone number (page 15).

### CONDITIONS

If Refrigerator Section is TOO WARM

If Freezer Section is TOO WARM

If Refrigerator Section is TOO COLD

If ICE isn't MADE FAST ENOUGH

If BOTH SECTIONS are TOO WARM

### REASONS

Door opened often  
Large amount of food added  
Room temperature too warm

Door opened often  
Large amount of food added  
Very cold room temperature (can't cycle often enough)

Controls not set correctly for your conditions

Heavy ice usage  
Very cold room temperature (can't cycle often enough)

Door opened often  
Large amount of food added  
Very warm or very cold room temperatures

### RECOMMENDED SETTINGS:

Temperature Control 4  
Air Control C

Temperature Control 4  
Air Control A

Temperature Control 2  
Air Control B

Temperature Control 3  
Air Control A

Temperature Control 4  
Air Control B

## Power Saving Control...

The Power Saving Control on the Control Console operates electric heaters around the door openings. These heaters help keep moisture from forming on the outside of the refrigerator.



1. Use the "OFF" setting when humidity is low.



2. Use the "ON" setting if moisture forms on the outside of the refrigerator.

## Adjusting Crisper Humidity Control...

You can control the amount of humidity in the moisture-sealed crisper.

1. The control can be adjusted to any setting between LO and HI.
2. **LO** (open) lets moist air out of crisper for best storage of fruits and vegetables with skins.
3. **HI** (closed) keeps moist air in the crisper for best storage of fresh leafy vegetables.

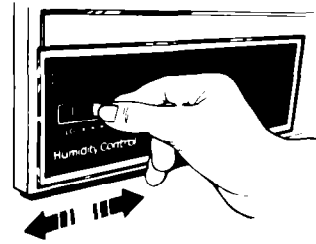

## Adjusting the refrigerator shelves...

Shelves can be adjusted to match the way you use your refrigerator. Glass shelves are strong enough to hold bottles, milk and other heavy food items.

**GLASS SHELVES ARE HEAVY. BE CAREFUL.**

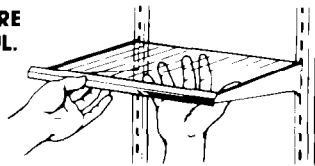

### To remove glass shelves:

1. Tilt up at front.
2. Lift up at back.
3. Pull shelf straight out.

### To replace glass shelves:

1. Guide the rear hooks into the slots in the shelf supports.
2. Tilt up front of shelf until hooks drop into slot. Lower front of shelf to level position.

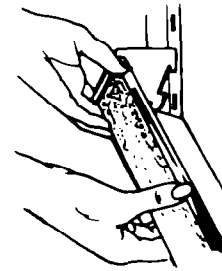

## Removing freezer shelf...

1. Lift front slightly.
2. Lift back off supports.
3. Replace in reverse order.

Lift the Front  
Then the Back

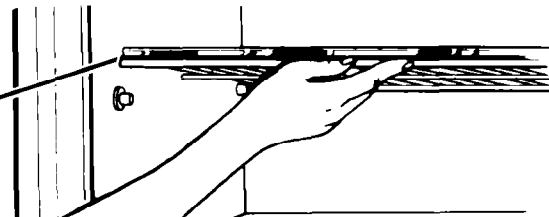

## Removing the crispers and crisper covers...

### To remove the crispers:

1. Slide crisper straight out to stop.
2. Lift the front.
3. Slide the rest of the way out.
4. Replace in reverse order.

**PUSH THE TAB TO CLEAR THE COVER.**

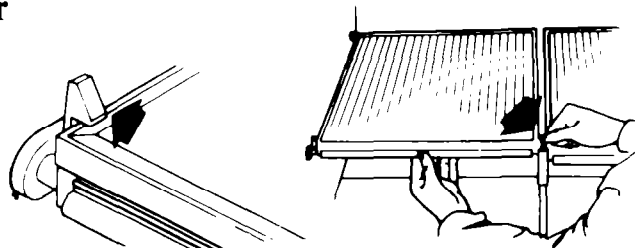

**SNAP BACK INTO PLACE.**

### To remove the cover:

Covers are held in by two pegs at the back and two notched tabs in front.

1. Press front out of way.
2. Lift cover front.
3. Lift back out of pegs.
4. Replace in reverse order.

If necessary, the center leg can be made shorter or longer to help level the crisper covers. Turn the leg clockwise to make it longer. Turn the leg counter-clockwise to shorten it.

## Removing the freezer basket...

For proper air movement, keep the freezer basket in place when the refrigerator is operating.

### To remove the basket:

1. Slide out to the stop.
2. Lift the front to clear the stop.
3. Slide out the rest of the way.

### To replace the basket:

1. Place basket on the slides.
2. Make sure the wire stops clear the front of the slides.
3. Slide basket in.

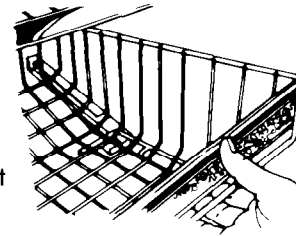

## Moving the meat pan...

The meat pan can be taken out and moved the same way as the shelves. Remove the meat pan first.

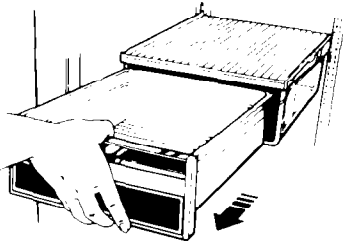

### To remove the meat pan and cover:

1. Slide the meat pan out to stop.
2. Lift the front of meat pan.
3. Slide pan the rest of the way out.
4. Tilt cover up at front.
5. Lift up at back.
6. Pull straight out.

### To replace the meat pan and cover:

1. Guide the rear hooks of cover into the slots in the shelf supports.
2. Tilt up front of cover until rear hooks drop into slots. Lower front of cover to level position.
3. Replace meat pan in reverse order of removal.

## Changing the light bulbs...



**WARNING:** Before removing a light shield for cleaning or for replacing a bulb, either unplug refrigerator or disconnect electricity leading to refrigerator at the main power supply. Shock and injury can occur if electricity remains connected.

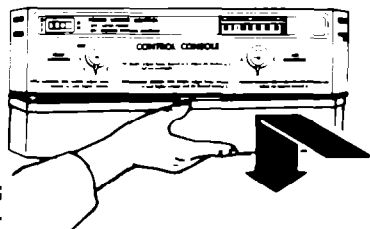

**PUSH IN THE CENTER;  
PULL DOWN.**

1. Push lightly on the top center of the light shield until the notched tab unhooks from the control panel.
  2. Pull down on the shield until the tab clears the control panel.
  3. Lift the back hooks out of their slots.
  4. Replace with a 40-watt appliance bulb.
  5. Replace light shield in reverse order.
- **Freezer light shield** pulls straight out from liner wall.

## Removing the base grille...

### To remove the grille:

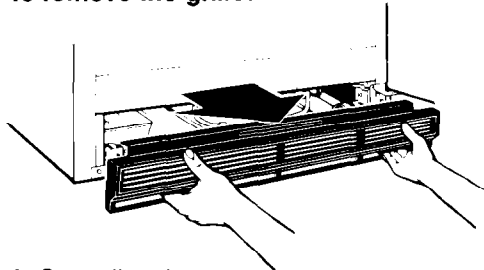

1. Open the doors.
2. Pull grille outwards as shown.
3. **Do not remove Tech sheet** fastened behind grille.

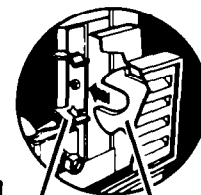
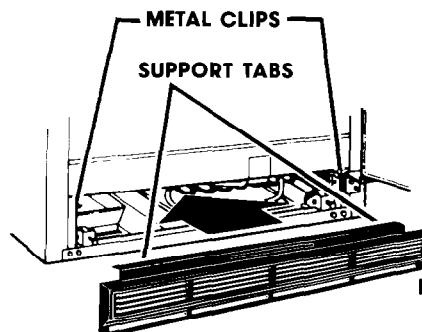

**METAL CLIPS  
SUPPORT TABS**

### To replace the grille:

1. Line up grille support tabs with metal clips.
2. Push firmly to snap into place.
3. Close the doors.

## Ice cube trays...

If cubes are not used, they may shrink. The moving cold air starts a slow evaporation. The longer cubes are stored, the smaller they get.

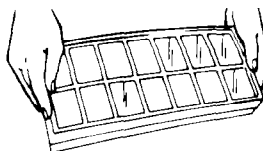

### To remove ice:

1. Hold tray at both ends.
2. Slightly twist.

## Optional automatic ice maker...

If you have the automatic ice maker accessory or plan to add one later (Part No. ECMF-61), there are a few things you will want to know.

- The ON/OFF lever is a wire signal arm.  
Down...for making ice automatically.  
Up...to shut off the ice maker.
- Shake the bin occasionally to keep cubes separated, and to obtain increased storage capacity.
- It is normal for ice crescents to be attached by a corner. They will break apart easily.

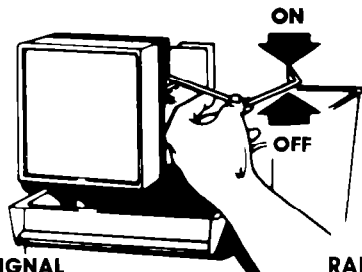

**LOWER SIGNAL ARM TO START IT**

**RAISE SIGNAL ARM TO STOP ICE**

- You will hear water running when ice maker is working. You'll hear ice fall into the bin. Don't let these sounds bother you.

- The ice maker will not operate until the freezer is cold enough to make ice. This can take overnight.
- Because of new plumbing connections, the first ice may be discolored or off-flavored. Discard the first few batches of ice.
- If ice is not being made fast enough and more ice is needed, turn the Temperature Control toward a higher number. Wait a day and, if necessary, turn the Air Control toward A.
- If you remove the ice bin, raise the signal arm to shut off the ice maker. When you return the bin, push it all the way in and lower the arm to the ON position.
- If cubes are stored too long, they may develop an off-flavor...like stale water. Throw them away. They will be replaced. Cubes in the ice bin can also become smaller by evaporation.
- Good water quality is important for good ice quality. It is not recommended that the ice maker be connected to a softened water supply. Water softener chemicals such as salt from a malfunctioning softener can damage the ice maker mold and lead to poor quality ice. If a softened water supply cannot be avoided, then it is important that the water softener be well maintained and operating properly.

## Sounds you may hear...

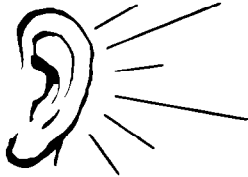

Your new refrigerator may make sounds that your old one didn't. Because the sounds are new to you, you might be concerned about them. Don't be. Most of the new sounds are normal. Hard surfaces like the floor, walls and cabinets can make the sounds seem louder.

The following chart describes the kinds of sounds that might be new to you, and what may be making them.

### Possible Sounds:

- **Slight Hum, Soft Hiss:**
- **Clicking or Snapping Sounds:**
- **Water Sounds:**
- **Ice Maker Sounds:**
  - trickling water
  - thud (clatter of ice)
- **Running Sounds:**

### Probable Causes:

You may hear the refrigerator's fan motor and moving air.

The thermostat makes a definite click when the refrigerator stops running. It also makes a sound when the refrigerator starts. The defrost timer will click when the defrost cycle starts and stops.

When the refrigerator stops running, you may hear gurgling in the tubing for a few minutes after it stops. You may also hear defrost water running into the defrost water pan.

If your refrigerator has an ice maker, you may hear buzzing (from the water valve), trickling water and the clatter of ice dumped into the bin.

Your refrigerator has a high-efficiency compressor and motor. It will run longer than older designs. It may even seem to run most of the time.

## Energy saving tips...

You can help your refrigerator use less electricity.

- Check door gaskets for a tight seal. Level the cabinet to be sure of a good seal.
- Clean the condenser coil regularly.
- Open the door as few times as possible. Think about what you need before you open the door. Get everything out at one time. Keep foods organized so you won't have to search for what you want. Close door as soon as food is removed.
- Go ahead and fill up the refrigerator, but don't over crowd it so air movement is blocked.

- It is a waste of electricity to set the refrigerator and freezer to temperatures colder than they need to be. If ice cream is firm in the freezer and drinks are as cold as your family likes them, that's cold enough.
- Keep the Power Saving Control on OFF unless moisture forms on the refrigerator exterior.
- Make sure your refrigerator is not next to a heat source such as a range, water heater, furnace, radiator or in direct sunlight.



# Cleaning your refrigerator

Both the refrigerator and freezer sections defrost automatically. But both should be cleaned about once a month to help prevent odors from building up. Of course, spills should be wiped up right away.

To clean your refrigerator, turn the Temperature Control to OFF, unplug it, take out all removable parts, and clean it according to the following directions.

## Cleaning chart...

Part	What to use	How to clean
Removable parts (shelves, crisper, meat pan, etc.)	Sponge or cloth; mild detergent and warm water.	<ul style="list-style-type: none"> <li>• Wash removable parts with warm water and a mild detergent.</li> <li>• Rinse and dry.</li> </ul>
Outside	Sponge, cloth or paper towel; mild detergent; appliance wax (or good auto paste wax).	<ul style="list-style-type: none"> <li>• Wash with warm water and a mild detergent. <b>Do not use abrasive or harsh cleansers.</b></li> <li>• Rinse and dry.</li> <li>• Wax painted metal surfaces at least twice a year with appliance wax or a good auto paste wax. Apply wax with a clean, soft cloth. <b>Do not use wax on plastic parts.</b></li> </ul>
<b>Waxing painted metal surfaces provides rust protection.</b>		
Inside walls (Freezer should be allowed to warm up so cloth won't stick.)	Sponge, soft cloth or paper towel, baking soda, warm water, mild detergent.	<ul style="list-style-type: none"> <li>• Wash with warm water and               <ul style="list-style-type: none"> <li>– mild detergent or</li> <li>– baking soda (2 tablespoons [26 g] to 1 quart [.95 L.] warm water).</li> </ul> </li> <li>• Rinse and dry.</li> </ul>
Door liners and gaskets	Sponge, soft cloth or paper towel; mild detergent, warm water.	<ul style="list-style-type: none"> <li>• Wash with mild detergent and warm water.</li> <li>• Rinse and dry.</li> </ul>
<b>DO NOT USE Cleaning waxes, concentrated detergents, bleaches or cleansers containing petroleum on plastic parts.</b>		
Dark plastics (covers and panels)	Mild detergent and warm water; soft clean sponge and soft, clean cloth.	<ul style="list-style-type: none"> <li>• Wash with a soft cloth or sponge.</li> <li>• Rinse and dry.</li> </ul>
<b>DO NOT USE paper towels, window sprays, scouring cleansers, or flammable or toxic solvents like acetone, gasoline, carbon tetrachloride, etc. These can scratch or damage the material.</b>		
Defrost pan	Sponge or cloth; mild detergent and warm water.	<ul style="list-style-type: none"> <li>• Remove base grille. (See page 7.)</li> <li>• To remove defrost pan, lift pan over wire brace (remove tape; if any).</li> <li>• Wash defrost pan with warm water and mild detergent.</li> <li>• Rinse and dry.</li> <li>• Replace with notched corner to the rear. Push it all the way in.</li> <li>• Make sure defrost drain tube is pointing into pan.</li> <li>• Replace base grille.</li> </ul>
Condenser Coil	Vacuum cleaner; using the extended narrow attachment.	<ul style="list-style-type: none"> <li>• Remove base grille.</li> <li>• Clean dust and lint from condenser at least every other month.</li> <li>• Replace base grille.</li> </ul>
Floor under refrigerator	Usual floor cleaners.	<ul style="list-style-type: none"> <li>• Roll refrigerator out only as far as water supply line allows.</li> <li>• Clean the floor.</li> <li>• Roll refrigerator back.</li> <li>• Check to see if the refrigerator is level.</li> </ul>

# Food storage guide

## STORING FRESH FOOD



There is a right way to package and store refrigerated or frozen foods. To keep foods fresher, longer, take the time to study these recommended steps.

**Leafy Vegetables...**Remove store wrapping and trim or tear off bruised and discolored areas. Wash in cold water and drain. Place in plastic bag or plastic container and store in crisper. Cold, moist air helps keep leafy vegetables fresh and crisp.

**Vegetables with Skins** (carrots, peppers)...Store in crisper, plastic bags or plastic container.

**Fruit...**Wash, let dry and store in refrigerator in plastic bags or crisper. Do not wash or hull berries until they are ready to use. Sort and keep berries in their store container in a crisper, or store in a loosely closed paper bag on a refrigerator shelf.



**Meat\***...Meat is perishable and expensive...you won't want to waste an ounce of it through careless handling. The following list and chart give you packaging hints and time limits. Store meat in the meat pan.

**Fresh, prepackaged Meat.** Store fresh meat in the store wrapping. Vacuum packaged meat can be frozen for as long as one month if the seal is not broken. If you want to keep it frozen longer, you should wrap it with special freezer wrapping material.

**Fresh Meat, Not Prepackaged.** Remove the market wrapping paper and re-wrap in aluminum foil for storing it unfrozen.

**Cooked Meat.** Wrap or cover cooked meat with plastic wrap or aluminum foil. Store immediately.

**Cured or Smoked Meat and Cold Cuts.** Ham, bacon, sausage, cold cuts, etc., keep best in original wrappings. Once opened, tightly re-wrap in plastic wrap or aluminum foil.

**Canned Ham.** Store in refrigerator unless the label says it's okay to store on the shelf. Do not freeze.

**Fresh Poultry...**Wrap in plastic wrap. The plastic on poultry, as purchased, may be used for storage.

### STORAGE CHART FOR FRESH AND CURED MEAT\*

Type	Approximate Time (days)
<b>Variety Meats</b> .....	<b>1 to 2</b>
<b>Chicken</b> .....	<b>1 to 2</b>
<b>Ground Beef</b> .....	<b>1 to 2</b>
<b>Steaks and Roasts</b> .....	<b>3 to 5</b>
<b>Cured Meats</b> .....	<b>7 to 10</b>
<b>Bacon</b> .....	<b>5 to 7</b>
<b>Cold Cuts</b> .....	<b>3 to 5</b>

\*If meat is to be stored longer than the times given, follow the directions for freezing.

**NOTE: Fresh fish and shellfish should be used the same day as purchased.**

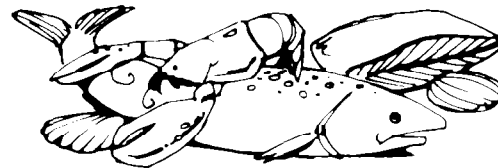

**Eggs...**Store without washing in the original carton or use the Utility Bin that came with your refrigerator.

**Milk...**Wipe milk cartons. For best storage, place milk on interior shelf.

**Beverages...**Wipe bottles and cans. Store on a door shelf or inside the refrigerator.

**Butter...**Keep opened butter in covered dish or in the Butter Compartment. When storing an extra supply, wrap in freezer packaging and freeze.

**Cheese...**Store in the original wrapping until you are ready to use it. Once opened, re-wrap tightly in plastic wrap or aluminum foil.

**Condiments...**Store small jars and bottles (catsup, mustard, jelly, olives) on the door shelves where they are in easy reach.

**Leftovers...**Cover leftovers with plastic wrap or aluminum foil to keep food from drying out and transferring food odors. Plastic containers with tight lids are fine, too.

## FREEZING & STORING FROZEN FOODS

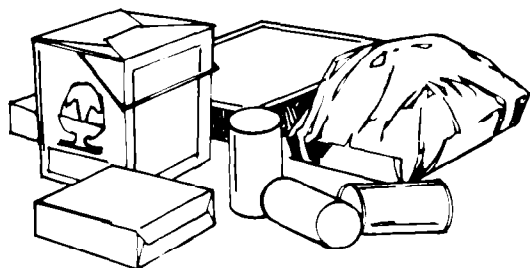

The freezer section is designed for storage of commercially frozen foods and for freezing foods at home.

**Packaging** – The secret of successful freezing is in the packaging. The wrap you use must be air, moisture and vapor proof. The way you close and seal the package must not allow air, moisture or vapor in or out. Packaging done in any other way could cause food odor and taste transfer throughout the refrigerator and drying of frozen food.

Rigid polyethylene (plastic) containers with tightfitting lids, straight-sided canning/freezing jars, heavy-duty aluminum foil, plastic-coated paper and nonpermeable plastic wraps (made from a saran film) are recommended. **NOTE: Heat-sealed boiling bags are easy to use and can be used by themselves or as carton liners.**

**Sealing** – When sealing foods in bags **squeeze out the air** (liquids need headspace to allow for expansion). Twist the top and turn it back. Fasten tie securely around the doubled-over tail. Put the label inside transparent bags; use self-adhesive label on outside of opaque ones.

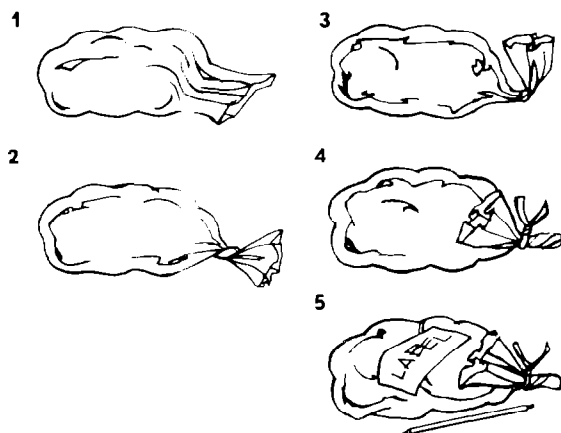

Air-tight wrapping calls for "drugstore" wrap. Cut the sheet about one-third longer than the distance around the food. Bring the ends together and fold in (toward the food) at least twice to seal out air. Crease ends close to food, press air from package. Fold tips over twice. Finish package and tape closed. **NOTE: With unboned meats, pad sharp edges with extra wrap or use stockinette to protect the wrap from punctures.**

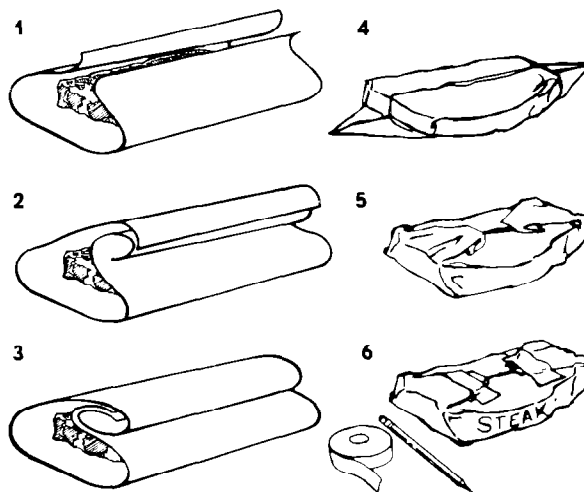

### DO NOT USE:

- Bread wrappers
- Non-polyethylene plastic containers
- Containers without tight lids
- Waxed paper
- Waxed-coated freezer wrap
- Thin, semi-permeable wrap

None of these are totally moisture, air or vapor proof. **The use of these wrappings could cause food odor and taste transfer and drying of frozen food.**

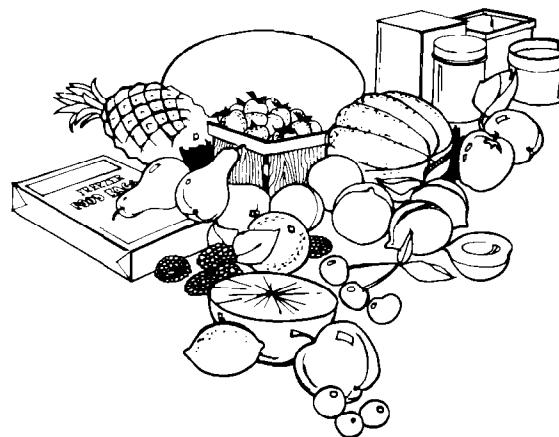

**Freezing Fruits** – Select ripe, blemish-free fruits. Be sure they taste as good as they look. Wash 2 to 3 quarts (liters) at a time and drain. Fruit that stands in water may lose food value and become soggy. Sort, peel, trim, pit and slice as needed.

Pack in rigid wide-mouthed containers or other recommended material. Leave head space to allow liquids to expand during freezing.

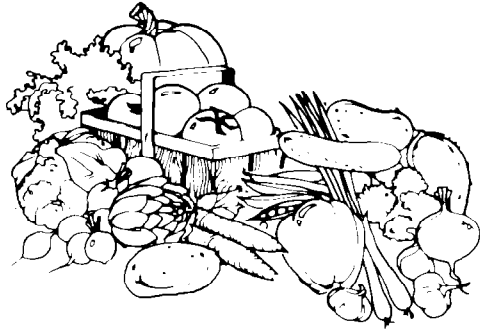

**Freezing Vegetables** – Freeze only fresh high-quality vegetables picked when barely mature. For best results, freeze no more than 2 to 3 hours after picking. Wash in cold water, sort and cut into appropriate sizes. Blanch or scald. Pack in recommended container and freeze.

Do not freeze lettuce, celery, carrot sticks, potatoes or fresh tomatoes. All will become limp or mushy. Tomatoes will collapse when thawed.

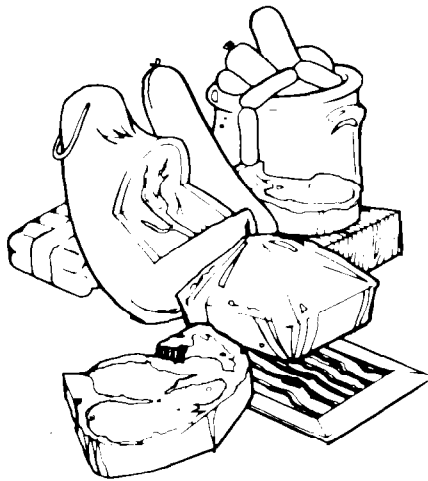

**Freezing Meats** – The meat you thaw can only be as good as the meat you freeze. “Drugstore” wrap in meal-size packages. Flat cuts or patties should be wrapped individually or in layers separated by a double thickness of freezer wrap.

Make sure store wrappings are moisture and vapor proof. If not, re-wrap meats with one of the wraps recommended under “Packaging.”

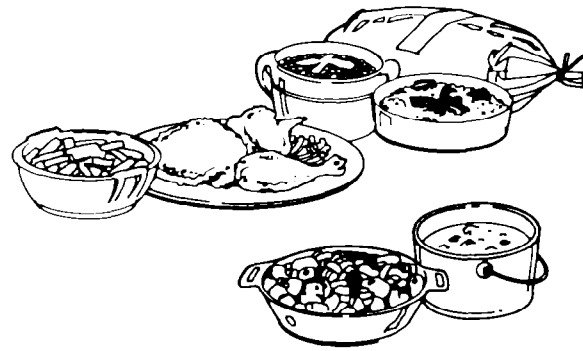

**Freezing Cooked Food** – Prepare cooked foods as you would for the table; shorten cooking time 10 to 15 minutes to allow for additional cooking during reheating. Omit seasonings and part of the liquid. Plan to add them at reheating time. Potatoes should also be added to soup and stew at heating time. Add crumb and cheese toppings at heating time.

Cool as rapidly as possible and freeze at once. Liquid or semi-liquid dishes may be frozen in recommended containers with *head-space*. Casseroles and other more solid foods may be frozen in the baking container. If you don't want to leave your casserole dish in the freezer, line it with foil. Bake, cool, freeze, lift out the foil package, bag it and return to freezer.

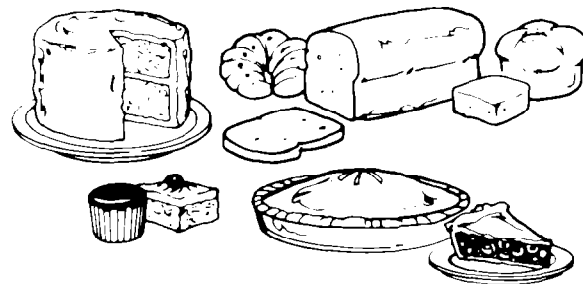

**Freezing Baked Goods** – Wrap baked breads in recommended material. Thaw in wrapping. Unbaked yeast breads can be frozen after the first rising. Punch down, wrap and freeze.

Bake cookies as usual. Cool and freeze on trays, then pack in recommended freezer bags or cartons. Unbaked cookies may be dropped, molded or rolled and frozen on cookie trays. Store in bag or carton; bake without thawing. Refrigerator-type cookies can be wrapped and frozen in roll form. Thaw only enough to slice when ready to bake.

Fruit pies are best frozen unbaked. Bake without thawing. Bake pecan and similar pies before freezing...rich fillings do not freeze solid. Cut steam vents in top crusts when ready to bake.

**IMPORTANT:** Do not expect your freezer to quick-freeze any large quantity of food. Put no more unfrozen food into the freezer than will freeze within 24 hours. (No more than 2 to 3 pounds of food per cubic foot of freezer space.) Leave enough space for air to circulate around packages. Be careful to leave enough room at the front so the door can close tightly.

**FOOD STORAGE CHART**

Storage times\* will vary according to the quality of the food, the type of packaging or wrap used (moisture and vapor-proof), and the storage temperature which should be 0°F (-17.8°C).

Food	Storage Time
<b>FRUITS</b>	
Fruit juice concentrate	12 months
Commercially frozen fruit	12 months
Citrus fruit and juices	4 to 6 months
Others	8 to 12 months
<b>VEGETABLES</b>	
Commercially frozen	8 months
Home frozen	8 to 12 months
<b>MEAT</b>	
Bacon	4 weeks or less
Corned beef	4 weeks or less
(Salting meat shortens freezer life)	
Frankfurters	1 month
Ground beef, lamb, veal	2 to 3 months
<b>Roasts:</b>	
Beef	6 to 12 months
Lamb and veal	6 to 9 months
Pork	4 to 8 months
Sausage, fresh	1 to 2 months
<b>Steaks and chops:</b>	
Beef	8 to 12 months
Lamb, veal, pork	3 to 4 months
<b>FISH</b>	
<b>Cod, flounder, haddock</b>	
sole	6 months
Blue fish, salmon	2 to 3 months
Mackerel, perch	2 to 3 months
Breaded fish (purchased)	3 months
<b>Clams, oysters, cooked</b>	
fish, crab, scallops	3 to 4 months
Alaskan king crab	10 months
Shrimp, uncooked	12 months
<b>POULTRY</b>	
Whole chicken or turkey	12 months
Duck	6 months
Giblets	2 to 3 months
Cooked poultry w/gravy	6 months
Slices (no gravy)	1 month
<b>MAIN DISHES</b>	
<b>Stews; meat, poultry and fish casserole</b>	
	2 to 3 months
TV dinners	3 to 6 months

Food	Storage Time
<b>DAIRY PRODUCTS</b>	
Butter	6 to 9 months
Margarine	12 months
<b>Cheese:</b>	
Camembert, Mozzarella, farmer's	3 months
Creamed cottage	<b>DO NOT FREEZE</b>
Cheddar, Edam, Gouda, Swiss, brick, etc.	6 to 8 weeks
Freezing can change texture of cheese.	
Ice cream, ice milk, sherbet	2 months
<b>EGGS</b>	
Whole (mixed)	12 months
Whites	12 months
Yolks	12 months
(Add sugar or salt to yolks or whole mixed eggs)	
<b>BAKED GOODS</b>	
Yeast breads and rolls	3 months
Baked Brown 'N Serve rolls	3 months
Unbaked breads	1 month
Quick breads	2 to 3 months
Cakes, unfrosted	2 to 4 months
Cakes, frosted	8 to 12 months
Fruit cakes	12 months
Cookie dough	3 months
Baked cookies	8 to 12 months
Baked pies	1 to 2 months
Pie dough only	4 to 6 months
*Based on U.S.D.A. and Michigan Cooperative Extension Service suggested storage times.	

**If electricity goes off**

Call the power company. Ask how long power will be off.

- If service is to be interrupted 24 hours or less, **keep both doors closed**. This will help frozen foods to stay frozen.
- If service is to be interrupted longer than 24 hours:
  - Remove all frozen food and store in a frozen food locker. Or...
  - Place 2 lbs (0.9 kg) of dry ice in freezer for every cu. ft. of freezer space. This will keep frozen foods for 2 to 4 days. Wear gloves to protect your hands from dry ice burns.
  - If neither food locker storage nor dry ice is available, use or can perishable food at once.
- A full freezer will stay cold longer than a partly filled one. A freezer full of meat will stay cold longer than a freezer full of baked goods. If food contains ice crystals, it may be safely refrozen, although the quality and flavor may be affected. Use refrozen foods quickly. If the condition of the food is poor or you have any suspicions, it is wise to dispose of it.

# Vacation and Moving Care

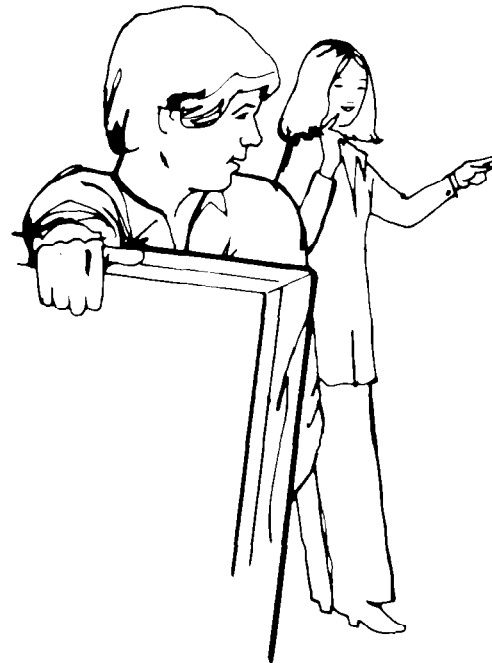

## Short vacations...

No need to shut off the refrigerator if you will be away for less than four weeks. Use up perishables; freeze other items. If your refrigerator is equipped with an automatic ice maker:

1. Turn it off.
2. Shut off the water supply to the ice maker.
3. Empty the ice bin.

## Long vacations...

Remove all the food if you are going for a month or more. If your refrigerator is equipped with an automatic ice maker, turn off the water supply to the ice maker at least a day ahead. When the last load of ice drops, turn off the ice maker.

Unplug the refrigerator and clean it...rinse well and dry. Tape rubber or wood blocks to both doors...keeping them open far enough for air to get in. This will keep odor and mold from building up.



**WARNING: Tape blocks out of a child's reach...do not allow children near the refrigerator when the doors are blocked open. They may become injured or trapped.**

## Moving...

If your refrigerator is equipped with an automatic ice maker, shut off the ice maker water supply a day ahead of time. Disconnect the water line. After the last supply of ice drops, lift the signal arm to turn off the ice maker.

Remove all food. Pack frozen foods in dry ice. Unplug the refrigerator and clean it thoroughly.

Remove everything that comes out. Wrap all parts well and tape them together so they don't shift and rattle.

Screw in the levelling rollers; tape the doors shut; tape the electric cord to the cabinet. When you get to your new home, put everything back, and refer to page 4. Don't forget to reconnect the water supply line if you have an ice maker.

## Questions?

...call your **COOL-LINE**<sup>®</sup> service assistance telephone number (page 15).



To restart refrigerator, see "Using Your Refrigerator."

# If you need service or assistance, we suggest you follow these five steps:

## 1. Before calling for assistance...

Performance problems often result from little things you can find and fix yourself without tools of any kind.

### If your refrigerator will not operate:

- Is the electric cord plugged into a live circuit with proper voltage? (See page 4.)
- Have you checked your home's main fuses or circuit breaker box?
- Is the Temperature Control turned ON?

### If there is a rattling or jingling noise or unfamiliar sounds:

- Is something on top or behind the refrigerator making noise when the refrigerator is running?
- New features on your new refrigerator make new sounds. You may be hearing air flowing from the fans, timer clicks for the defrosting cycle, or defrost water draining in the defrost pan.

### If your ice maker will not operate:

- Has the freezer had enough time to get cold? With a new refrigerator, this might take overnight.
- Is the signal arm ON...in the down position?
- Is the water valve turned on? Is water getting to the ice maker?

### If there is water in the defrost pan:

- This is normal in hot, muggy weather. The pan can even be half full. Make sure the refrigerator is level so the pan does not overflow.

### If the light does not work:

- Have you checked your home's main fuses or circuit breaker box?
- Is the power supply cord plugged into a live circuit with the proper voltage? (See page 4.)

### If a bulb is burned out:

- See instructions for changing light bulbs on page 6. Only use appliance bulbs.

### If the motor seems to run too much:

- Is the condenser behind the refrigerator, free of dust and lint?
- On hot days, or if the room is warm, the motor naturally runs longer.
- If the door has been opened a lot, or if a large amount of food has been put in, the motor will run longer to cool down the interior.

**Remember:** Motor running time depends on different things; number of door openings, amount of food stored, temperature of the room, setting of the controls.

And, your new refrigerator may be larger than your old one so it has more space to be cooled. It also has a regular freezer instead of a frozen food compartment. All this means better refrigeration and may require more running time than your old one.

## 2. If you need assistance\*...

Call Whirlpool COOL-LINE® service assistance telephone number. Dial free from anywhere in the U.S.:  
**1-800-253-1304**

and talk with one of our trained Consultants. The Consultants can instruct you in how to obtain satisfactory operation from your appliance or, if service is necessary, recommend a qualified service company in your area.

## 3. If you need service\*...

Whirlpool has a nationwide network of franchised TECH-CARE® service companies. TECH-CARE service technicians are trained to fulfill the product warranty and provide after-warranty service, anywhere in the United States. To locate TECH-CARE service in your area, call our COOL-LINE service assistance telephone number (see Step 2) or look in your telephone directory Yellow Pages under:

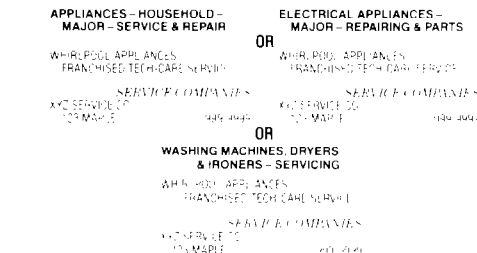

## 4. If you have a problem\*...

Call our COOL-LINE service assistance telephone number (see Step 2) and talk with one of our Consultants, or if you prefer, write to:

Mr. Robert Stanley  
Division Vice President  
Whirlpool Corporation  
2000 US-33, North  
Benton Harbor, MI 49022

## 5. If you need FSP® replacement parts\*...

FSP® is a registered trademark of Whirlpool Corporation for quality parts. Look for this symbol of quality whenever you need a replacement part for your Whirlpool appliance. FSP replacement parts will fit right and work right, because they are made to the same exacting specifications used to build every new Whirlpool appliance.

To locate FSP replacement parts in your area, refer to Step 3 above or call the Whirlpool COOL-LINE service assistance number in Step 2.

\*If you must call or write, please provide: model number, serial number, date of purchase, and a complete description of the problem. This information is needed in order to better respond to your request for assistance.

# WHIRLPOOL REFRIGERATOR WARRANTY

LENGTH OF WARRANTY	WHIRLPOOL WILL PAY FOR
<b>FULL ONE-YEAR WARRANTY</b> From Date of Purchase	FSP replacement parts and repair labor to correct defects in materials or workmanship.
<b>FULL FIVE-YEAR WARRANTY</b> From Date of Purchase	FSP replacement parts and repair labor to correct defects in materials or workmanship in the sealed refrigeration system. These parts are: <ol style="list-style-type: none"> <li>1. Compressor</li> <li>2. Evaporator</li> <li>3. Condenser</li> <li>4. Drier</li> <li>5. Connecting tubing</li> </ol>
<b>WHIRLPOOL WILL NOT PAY FOR</b>	
<p><b>A.</b> Service calls to:</p> <ol style="list-style-type: none"> <li>1. Correct the installation of the refrigerator.</li> <li>2. Instruct you how to use the refrigerator.</li> <li>3. Replace house fuses or correct house wiring or plumbing.</li> <li>4. Replace light bulbs.</li> </ol> <p><b>B.</b> Repairs when refrigerator is used in other than normal, single-family household use.</p> <p><b>C.</b> Pick up and deliver. This product is designed to be repaired in the home.</p> <p><b>D.</b> Damage to refrigerator caused by accident, misuse, fire, flood, acts of God or use of products not approved by Whirlpool.</p> <p><b>E.</b> Any food loss due to product failure.</p>	

Service under the full warranties must be provided by a franchised TECH-CARE® service company.

WHIRLPOOL CORPORATION SHALL NOT BE LIABLE FOR INCIDENTAL OR CONSEQUENTIAL DAMAGES. Some states do not allow the exclusion or limitation of incidental or consequential damages so this limitation or exclusion may not apply to you. This warranty gives you specific legal rights, and you may also have other rights which vary from state to state.

Outside the United States, a different warranty may apply. For details, please contact your franchised Whirlpool distributor or military exchange.



Part No. 1114069  
©1987 Whirlpool Corporation

Printed in U.S.A.

Ice Makers. Dishwashers. Built-In Ovens and Surface Units. Ranges. Microwave Ovens. Trash Compactors. Room Air Conditioners. Dehumidifiers. Automatic Washers. Clothes Dryers. Freezers. Refrigerators.

