

Whirlpool

Side-by-Side Refrigerator

1/4" Trim Kits

4378876, 4378877,
and 4378878

Installation Instructions

KitchenAid

1/4" Trim Kits -

4378879, 4378880,
4378881

Important

Do not discard dispenser trim or instructions.

Decorator Door Panel Installation Instructions

1/4" (6 mm) Panel Dimensions

Listed below are required height x width dimensions for decorator panels. Panels are not supplied with this kit and can be purchased locally. Refrigerator panels should not weigh more than 30 pounds and freezer panels should not weigh more than 15 pounds.

~~Build-in~~ Panel Dimensions

Refrigerator Door Panel	63 3/32" x 19 3/8"
Upper Freezer Door Panel	18 3/8" x 13 3/4"
Lower Freezer Door Panel	31 9/16" x 13 3/4"

General

	WARNING
Electrical Shock Hazard Disconnect electrical power before installing panels. Failure to do so can result in death or electrical shock.	
Personal Injury Hazard Wear gloves and protect arms when handling trim pieces. Failure to do so could result in cuts or other serious injury.	

Caution To avoid property damage, protect soft vinyl or other flooring with cardboard, rugs, or other protective material.
--

Procedure

Important

Save all screws and reuse in original location.

1. Remove top handle end caps by removing screws.

2. Dispenser Models

Remove crushed/cubed ice switch cover on dispenser by placing taped edge of putty knife underneath cover and pulling out. Release bottom clips on dispenser cover by placing taped edge of putty knife underneath cover and pulling out. Release top clips by holding bottom of dispenser cover out and sliding up.

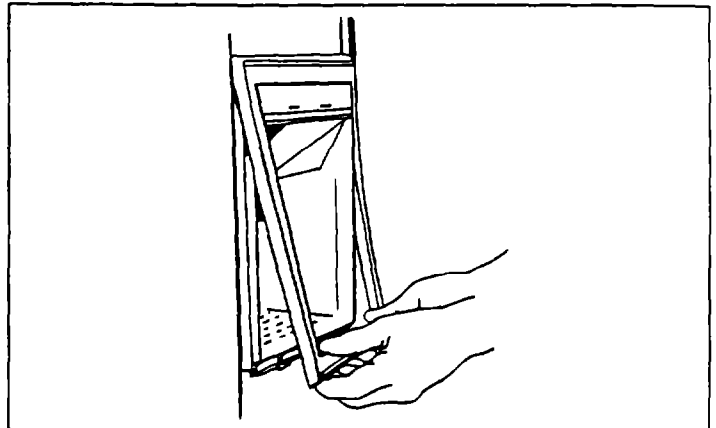

3. Remove door handle inserts by placing screwdriver at top of door handles in area between handle and insert and pulling forward. Pull edge of inserts forward along length of handles.

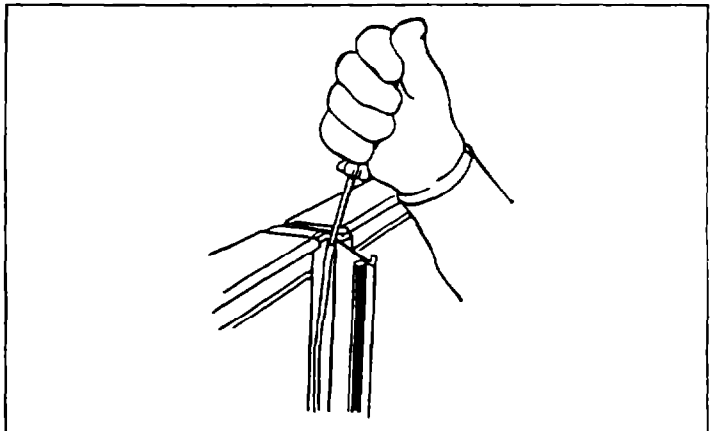

WARNING
Personal Injury Hazard Hold door handles when removing doors. Failure to do so could result in personal injury.

4. Remove door handles by removing screws.

Important

Decorator panels should be cut to "1/4" panel dimensions. Refer to "1/4" Decorator Panel Dimensions" section.

Contents

Introduction 2
 Decorator Panel Dimensions 2
 Parts List 2
 Procedure 3

Decorator Panel Dimensions

Listed below are required height x width dimensions for decorator panels. Panels are not supplied with this kit and can be purchased locally.

Introduction



WARNING

Electrical Shock Hazard

Disconnect electrical power before installing kit.
 Failure to do so can result in death or electrical shock.

Personal Injury Hazard

Wear gloves and protect arms when handling trim pieces.
 Failure to do so could result in cuts or other serious injury.

Caution

To avoid property damage, protect soft vinyl or other flooring with cardboard, rugs, or other protective material.

Read entire manual before installing kit. Confirm all parts listed are included in kit. If parts are missing, contact source from whom kit was purchased.

Important

- Mechanical experience is required to install trim kit.
- Depending on installer's knowledge and skill, installation can take from one to three hours.
- Transfer food to an alternate cooling source. Check refrigerator warranty certificate for specific coverage. **Warranty does not cover food loss.**
- Ensure trim pieces adhere properly by confirming surfaces are clean, dry and free of adhesive residue.
- If unable to solve a problem during installation, contact source from whom kit was purchased.

Caution

To avoid personal injury or property damage, refrigerator panels should not weigh more than 30 lbs (14 kgs) and freezer panels should not weigh more than 15 lbs (7 kgs).

Free Standing Panels

Refrigerator Door	61 15/16" x 19 3/8" (1573 mm x 492 mm)
Upper Freezer Door	17 1/4" x 13 3/4" (438 mm x 349 mm)
Lower Freezer Door	31 9/16" x 13 3/4" (802 mm x 349 mm)

Parts List

Item	Description	Qty
1	Side Trim with 1/8" Tape, Refrigerator and Freezer Door	2
2	Bottom Trim, Refrigerator Door	1
3	Bottom Trim, Freezer Door	1
4	Top Trim with 1/16" Tape, Refrigerator Door	1
5	Top Trim with 1/16" Tape, Freezer Door	1
6	Trim, Dispenser Retainer	2
7	Handle Insert, Refrigerator Door	1
8	Freezer Insert, Freezer Door	1
9	Screw, Bottom Trim	5
10	Bottom Trim Spacer, Refrigerator Door	1
11	Bottom Trim Spacer, Freezer Door	1
12	Top Handle Cap, Refrigerator Door	1
13	Top Handle Cap, Freezer Door	1
14	Bottom Handle Cap, Refrigerator Door	1
15	Bottom Handle Cap, Freezer Door	1
16	Installation Instructions	1

Procedure

Important

Save all screws and reuse in original location.

1. Remove top handle end caps by removing screws.
2. Remove crushed/cubed ice switch cover on dispenser by pulling forward. Release bottom clips on dispenser cover by placing taped edge of putty knife underneath cover and pulling out. Release top clips by holding bottom of dispenser cover out and sliding up.

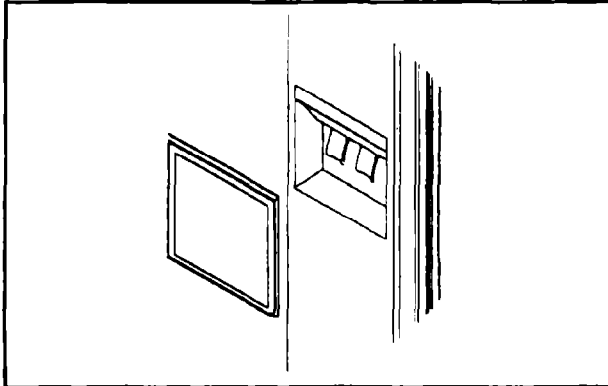

3. Remove door handle inserts by placing screwdriver at top of door handles in area between handle and insert and pulling out. Pull inserts out along length of handles.
4. Remove end caps from bottom of handles by pulling down. Install new bottom handle end caps by placing end caps in bottom of handles and snapping in place.
5. Install new handle inserts by placing insert on handles and snapping in place.

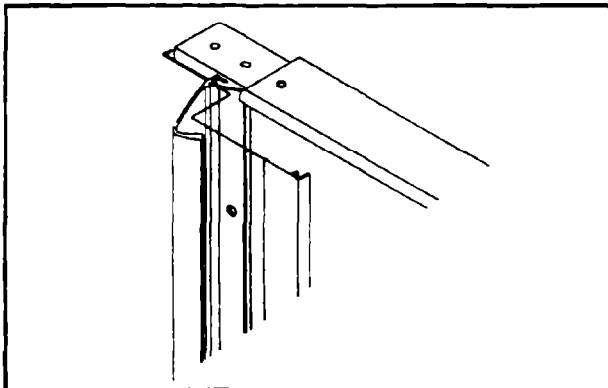

6. Install new top handle end caps by placing on handles. Insert and tighten screws.
7. Replace dispenser cover by snapping in place. Replace switch cover by snapping in place.
8. Remove toe grille by pulling forward.

Caution

To avoid personal injury or property damage, temporarily tape doors shut.

9. Tape doors shut using masking tape.



WARNING

Electrical Shock Hazard

Green ground wire must remain attached to hinge. Failure to do so can result in death or electrical shock.

10. Remove top hinge covers by removing screws. Trace around top hinges with a pencil. This helps alignment when reassembling. Unplug top hinge wire connectors. Do not remove green ground wire from hinge. Remove top hinge screws.

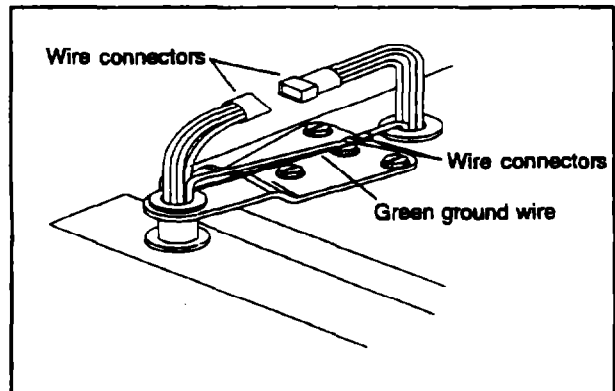

11. Remove tape from refrigerator door. Grasp refrigerator door securely and lift up while opening. This will free door from bottom hinge pin. Top hinge may come off door.

Caution

To avoid property damage, drain water from water tube into small bucket.

12. Loosen water tube clamp screw. Loosen plastic water tube union nut. Gently pull water tube away from union nut and through tube clamp.

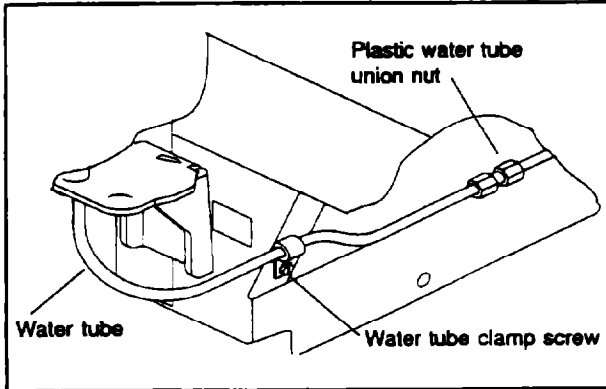

13. Remove tape from freezer door. Grasp freezer door securely and lift up while opening. This will free door from bottom hinge pin. Plastic water tube must slide through slot in bottom door hinge as door is raised.
14. Remove door stops by removing screws. Install spacer and bottom trim by placing spacer and trim on bottom of doors. Insert and tighten bottom trim screws. Replace door stops by placing door stops on bottom of doors. Insert and tighten screws.

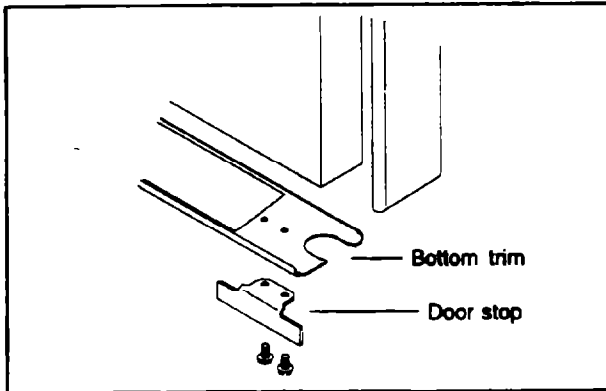

15. Rehang doors by positioning bottom sockets onto bottom door hinge pins. Position so doors are flush with side of refrigerator cabinet. Handle side of doors should be approximately 1/8" (3.2 mm) higher than hinge side of doors. Doors will settle when loaded with food. Thread water tube through bottom hinge pin and water tube clamp.

Caution

To avoid personal injury or property damage, temporarily tape doors shut.

16. Tape doors shut using masking tape.

**WARNING****Electrical Shock Hazard**

Green ground wire must remain attached to hinge. Failure to do so can result in death or electrical shock.

17. Replace top hinges by placing top hinges on refrigerator. Insert and tighten screws. Reconnect top hinge wire connectors by snapping together. Replace top hinge covers by placing hinge covers over hinges. Insert and tighten screws.
18. Remove tape from doors.
19. Install top door trim by peeling off 1 1/2" (38 mm) of backing. Permanent, double-sided tape is used to attach trim to refrigerator. Trim pieces may be damaged if adjustment or removal is attempted after installation. Place cut end of trim against handle cap and firmly against back of door. After checking placement, peel off backing and press into place.
20. Install dispenser trim on freezer panels by sliding trim on bottom edge of upper freezer door panel and top edge of lower freezer door panel.
21. Slide decorator door panels into place until panels are secure under handle inserts.
22. Install side door trim by peeling off 1 1/2" (38 mm) of backing. Permanent, double-sided tape is used to attach trim to refrigerator. Trim pieces may be damaged if adjustment or removal is attempted after installation. Place trim against top corner of refrigerator cabinet over edge of top trim. After checking placement, peel off backing and press into place. Place side door trim over edge of bottom trim.

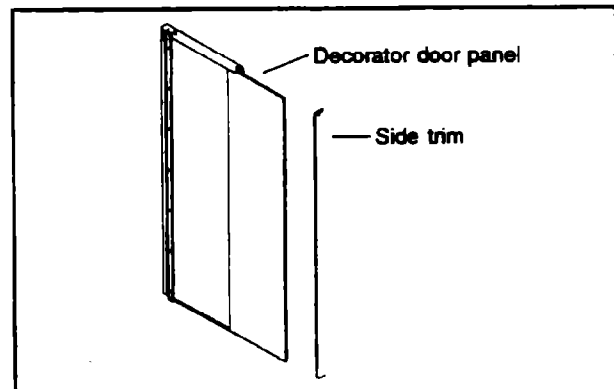

-
24. Push water tube into plastic union nut and tighten union nut by hand. Gently pull on tube to confirm nut is tight. Tighten water tube clamp screw.

Caution

To avoid property damage, confirm water tube union nut is secure before replacing toe grille.

25. Replace toe grille by inserting clips in holes and snapping in.

**Side-by-Side
Refrigerator
Perimeter Trim
Kits 4378870,
4378871, and
4378872**

**Installation
Instructions**

WHIRPOOL

Perimeter Kits

KitchenAid

4378873, 4378874
4378875

INSTALLATION INSTRUCTIONS

INTRODUCTION

The Perimeter Trim Kit attaches as a "frame" to free-standing refrigerators and is designed to give a built-in look when cabinets are located above and on both sides.

Read and thoroughly understand this entire instruction manual before starting to install the Perimeter Trim Kit. Make sure all necessary tools and material are available to complete the job. Study illustrations to become familiar with the appliance and with important details of the installation procedure.

NOTE:

1. Mechanical experience is required in order to install perimeter trim kit.
2. Depending on the installer's knowledge and skill, installation can take from one-half (1/2) to one (1) hour.
3. When moving the refrigerator, protect soft vinyl and other flooring.
4. Permanent-type, double-sided adhesive tape on velcro patches is used to attach trim pieces for easy removal. Before removing paper backing from the double sided adhesive tape, check the location of velcro patches on trim pieces and on refrigerator surfaces. Be sure you understand how to install each one. To insure adhesive-backed trim pieces adhere properly, all surfaces must be clean, dry, and free of adhesive residue before installing trim kit. Damage to refrigerator and trim pieces could result if adjustment or removal of adhesives is attempted after installation.
5. To correctly install refrigerator with perimeter kit attached, opening between and below cabinets must be at least 69 inches high, 36 inches wide (maximum 36-3/8 inches for custom locations), and 24 inches deep. Front corners or counter tops may also need to be trimmed so refrigerator and freezer doors will open completely. See page 117 for more information.
6. Before installing perimeter trim kit, refrigerator must be rolled into place between cabinets and properly leveled. See refrigerator Installation Instructions for instructions on leveling.

PARTS LIST

DESCRIPTION	BI10 P/N	BI11 P/N	QT
L-Shaped Bezel Gusset	A3049001	A3049001	2
5/32" Bezel Gusset Machine Screw	M020251	M0202514	4
Right Cabinet Frame	10112407	10112404	1
Left Cabinet Frame	10112408	10112405	1
Top Cabinet Frame	10112409	10112406	1

RECOMMENDED TOOLS



TO AVOID POSSIBLE INJURY, PROTECT HANDS AND ARMS. KIT PIECES AND REFRIGERATOR PARTS MAY HAVE SHARP EDGES.

To install the perimeter trim kit use the following basic tools:

1. #2 point Phillips screwdriver
2. Tightly fitting gloves and arm protection.

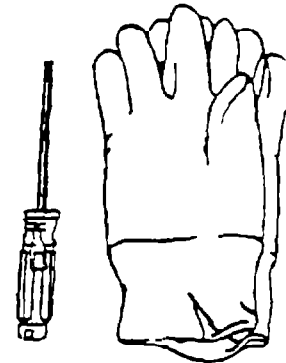

PERIMETER KIT PART NO.

ED20DBXEW	4378872
ED20DBXEN	4378871
ED20DBXEB	4378870
ED20DFXEW	4378872
ED20DFXEN	4378871
ED20DFXEB	4378870

INSTALLATION INSTRUCTIONS

INTRODUCTION

The Perimeter Trim Kit attaches as a "frame" to free-standing refrigerators and is designed to give a built-in look when cabinets are located above and on both sides.

Read and thoroughly understand this entire instruction manual before starting to install the Perimeter Trim Kit. Make sure all necessary tools and material are available to complete the job. Study illustrations to become familiar with the appliance and with important details of the installation procedure.

NOTE:

1. Mechanical experience is required in order to install perimeter trim kit.
2. Depending on the installer's knowledge and skill, installation can take from one-half (1/2) to one (1) hour.
3. When moving the refrigerator, protect soft vinyl and other flooring.
4. Permanent-type, double-sided adhesive tape or velcro patches is used to attach trim pieces for easy removal. Before removing paper backing from the double sided adhesive tape, check the location of velcro patches on trim pieces and on refrigerator surfaces. Be sure you understand how to install each one. To insure adhesive-backed trim pieces adhere properly, all surfaces must be clean, dry, and free of adhesive residue before installing trim kit. Damage to refrigerator and trim pieces could result if adjustment or removal of adhesives is attempted after installation.
5. To correctly install refrigerator with perimeter kit attached, opening between and below cabinets must be at least 69 inches high, 36 inches wide (maximum 36-3/8 inches for custom locations), and 24 inches deep. Front corners or counter tops may also need to be trimmed so refrigerator and freezer doors will open completely. See page 117 for more information.
6. Before installing perimeter trim kit, refrigerator must be rolled into place between cabinets and properly leveled. See refrigerator Installation Instructions for instructions on leveling.

PARTS LIST

DESCRIPTION	BI10 P/N	BI11 P/N	QT
L-Shaped Bezel Gusset	A3049001	A3049001	2
5/32" Bezel Gusset Machine Screw	M020251	M0202514	4
Right Cabinet Frame	10112407	10112404	1
Left Cabinet Frame	10112408	10112405	1
Top Cabinet Frame	10112409	10112406	1

RECOMMENDED TOOLS



TO AVOID POSSIBLE INJURY, PROTECT HANDS AND ARMS. KIT PIECES AND REFRIGERATOR PARTS MAY HAVE SHARP EDGES.

To install the perimeter trim kit use the following basic tools:

1. #2 point Phillips screwdriver
2. Tightly fitting gloves and arm protection.

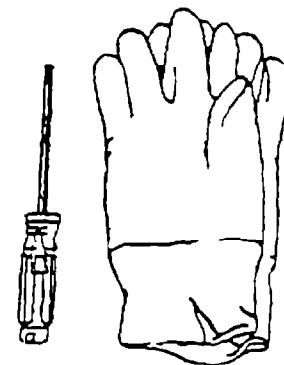

PERIMETER KIT PART NO.

KSBS20QEBL	4378873
KSBS20QEAL	4378874
KSBS20QEWB	4378875
KSFS20QEBL	4378873
KSFS20QEAL	4378874
KSFS20QEWB	4378875

INSTALLATION INSTRUCTIONS

7. Check position of top frame and install on refrigerator top.
- A. Before removing paper backing from velcro patches of top frame, be sure to center frame between hinge covers at top of refrigerator cabinet. Front flange of frame must fit snugly against front face of refrigerator cabinet.

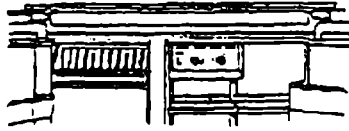

- B. Install top frame on refrigerator cabinet by removing paper backing from velcro patches and pressing frame securely into place on top of refrigerator cabinet.

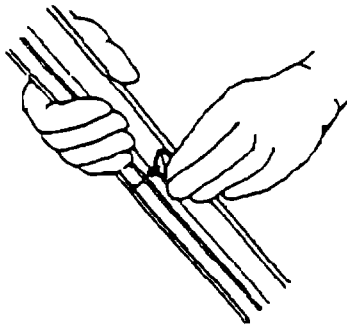

NOTE: Position of top frame on refrigerator cabinet may be changed or frame may be removed for adjustments to hinges and removal of doors. To reposition or remove, gently pull on top frame to separate velcro patches. To secure frame again, press velcro patches together. Left and right frames cannot be repositioned.

8. Check position of left and right frames and install frames on sides of refrigerator cabinet.
- A. Before removing paper backing from double-sided adhesive on left frame, snugly align front flange of left frame along entire length of left front face of refrigerator cabinet.
- B. Before removing paper backing from double-sided adhesive on right frame, snugly align front flange of right frame along entire length of right front face of refrigerator cabinet.

- C. Slide gusset on left frame into channel on top frame.

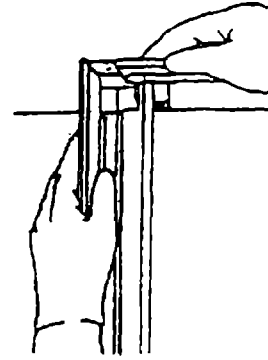

- D. Slide gusset on right frame into channel on top frame.
- E. Be sure mitered top corners at left and right fit together tightly.

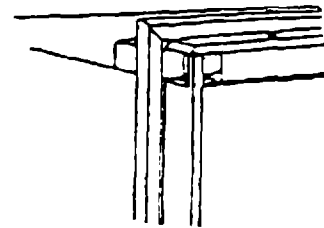

- F. Install left and right frames on refrigerator by removing paper backing from adhesive patches aligning side trim frames, and pressing frames securely into place on left and right sides of cabinet.

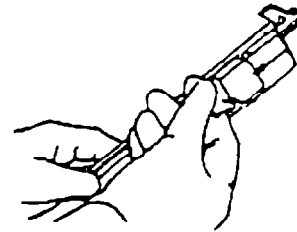

- G. Use a 5/32 inch bezel gusset machine screw on left frame to secure bezel gusset to top frame.

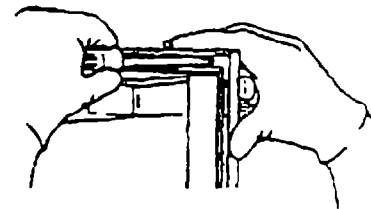

- H. Use a 5/32 inch bezel gusset machine screw on right frame to secure bezel gusset to top frame.

DOOR AND BOTTOM PERIMETER TRIM KIT INSTALLATION INSTRUCTIONS

9. Check top frame for correct center position.
 - A. If top frame needs centering, or to gain access to top hinges for door removal/hinge adjustment, loosen 5/32 inch bezel gusset machine screws in left and right frames.

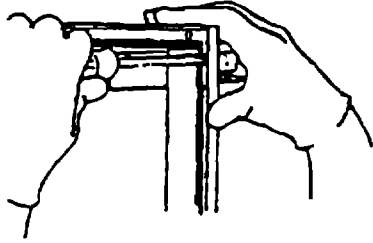

- B. Gently pull on top frame to separate velcro patches and slide top frame up and away from refrigerator.

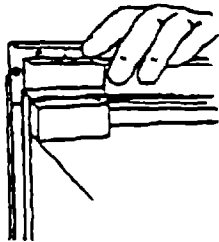

10. Roll refrigerator into place to check leveling and proper fit with surrounding cabinets.
11. Once proper fit is achieved, roll refrigerator out, plug in electrical power cord, and return refrigerator to final position.
12. Replace toe grille at bottom front of refrigerator.