

Important Safety Instructions

When using your telephone equipment, basic safety precautions should always be followed to reduce the risk of fire, electric shock and injury to persons, including the following:

1. Read and understand all instructions.
2. Follow all warnings and instructions marked on the product.
3. Unplug this product from the wall outlet before cleaning. Do not use liquid or aerosol cleaners. Use a damp cloth for cleaning.
4. Do not use this product near water (for example, near a bath tub, kitchen sink, or swimming pool).
5. Do not place this product on an unstable cart, stand, or table. The product may fall, causing serious damage.
6. Slots and openings in the Handset and Base Unit are provided for ventilation. To protect it from overheating, these openings must not be blocked by placing the product on a bed, sofa, rug, or other similar surface. This product should never be placed near or over a radiator or heat register. This product should not be placed in a built-in installation where proper ventilation is not provided.
7. This product should be operated only from the type of power source indicated on the marking label. If you are not sure of the type of power supply to your home, consult your dealer or local power company.
8. Do not allow anything to rest on the power cord. Do not install this product where the cord might be damaged by anyone walking on it.
9. Never push objects of any kind into this product through holes and slots in the Handset and Base Unit as they may touch dangerous voltage points or short out parts that could result in a risk of fire or electric shock. Never spill liquid of any kind on the product.
10. To reduce the risk of electric shock, do not disassemble this product, but take it to an authorized service facility. Opening or removing cabinet parts other than specified access doors may expose you to dangerous voltages or other risks. Incorrect reassembling can cause electric shock when the appliance is subsequently used.
11. Do not overload wall outlets and extension cords as this can result in the risk of fire or electric shock.

Important Safety Instructions

12. Unplug this product from the wall outlet and refer servicing to an authorized service facility under the following conditions:
 - A. When the power supply cord or plug is damaged or frayed.
 - B. If liquid has been spilled into the product.
 - C. If the product has been exposed to rain or water.
 - D. If the product does not operate normally by following the operating instructions. Adjust only those controls that are covered by the operating instructions, because improper adjustment of other controls may result in damage and will often require extensive work by an authorized technician to restore the product to normal operation.
 - E. If the product has been dropped and the cabinet has been damaged.
 - F. If the product exhibits a distinct change in performance.
13. Avoid using a telephone (other than a cordless type) during an electrical storm. There may be a remote risk of electric shock from lightning.
14. Do not use the telephone to report a gas leak in the vicinity of the leak.

SAVE THESE INSTRUCTIONS

Introduction

The **2652** is an advanced cordless telephone that operates in the 2.4 GHz frequency range. Your **2652** is capable of supporting up to a maximum of 4 Handsets. Using additional Handsets, up to three people can be conferenced on a call (2 Handsets and the Base Speakerphone), or two extensions can be conferenced on a call, while two other extensions can be talking internally, using the Intercom feature.

This manual is designed to familiarize you with the **2652** cordless telephone.

IMPORTANT

Please record the Base ID code (BS ID) printed on the underside of the 2652 Base in the space below. Please be certain to include all 15 digits/characters.

Base ID# _____

Parts Check List

1. Base Unit
2. Handset
3. AC Power Adapter
4. Telephone Cord
5. Battery Pack
6. Belt Clip
7. User's Manual



Handset

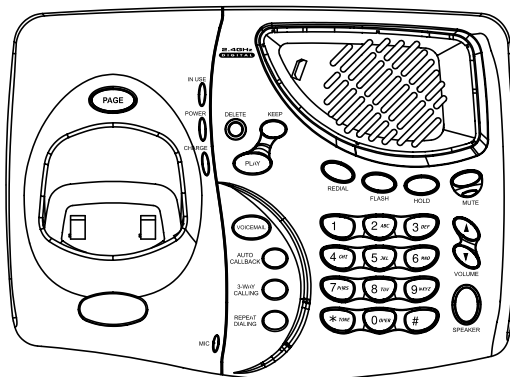

Base Unit

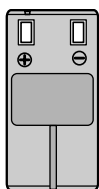

Battery Pack x 2



Telephone Cord

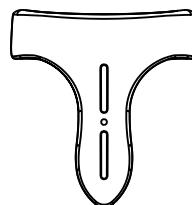

Belt Clip

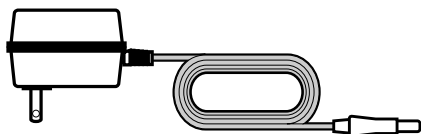

AC Power Adapter



User's Manual

The Handset Layout

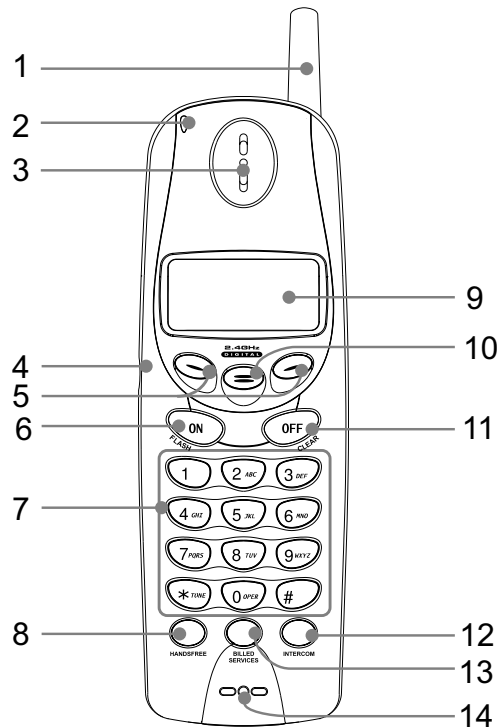

- | | |
|------------------------------|---------------------------|
| 1. Antenna | 8. Handsfree Speakerphone |
| 2. Message Waiting Indicator | 9. LCD Display |
| 3. Earpiece | 10. Select |
| 4. Headset Jack (2.5mm) | 11. Off/Clear |
| 5. Scroll Keys | 12. Intercom |
| 6. On/Flash | 13. Billed Services |
| 7. Dialing Key (0 - 9, *, #) | 14. Microphone |

The Base Unit Layout

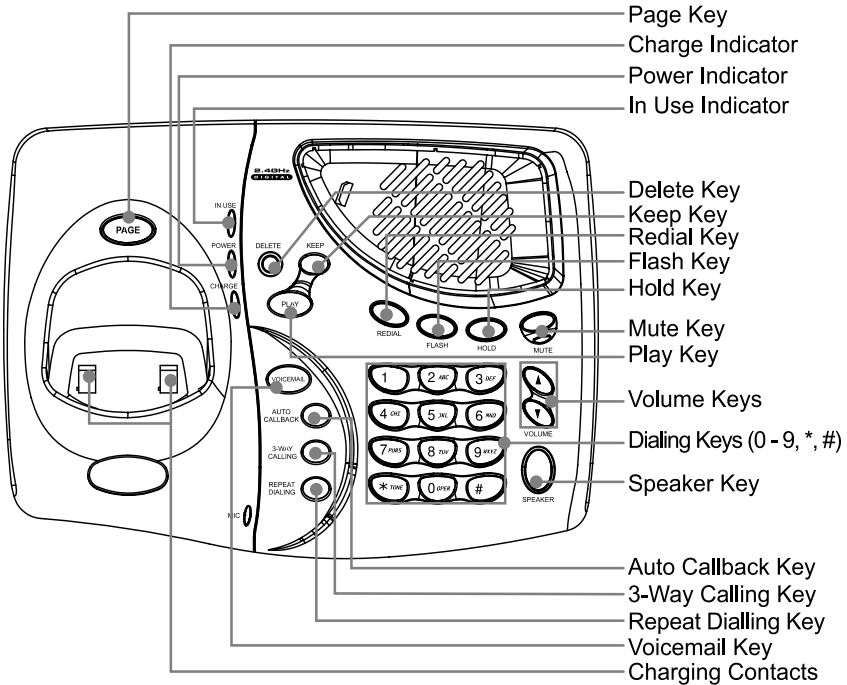
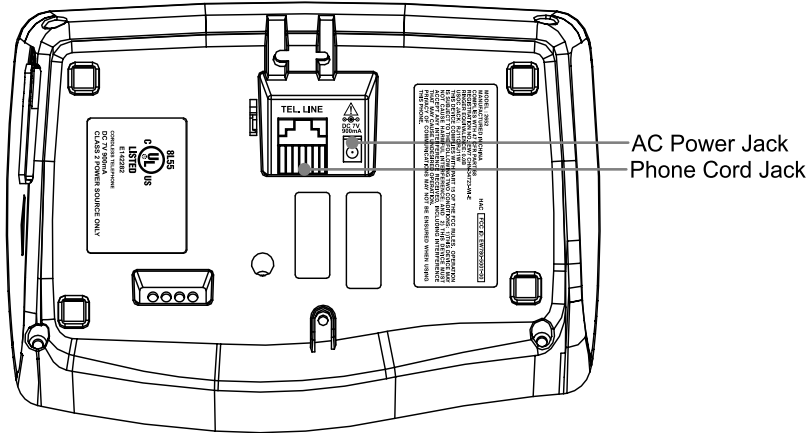

Setup

Plug the AC power adapter into an electrical outlet, and the DC connector into the back of the Base Unit.

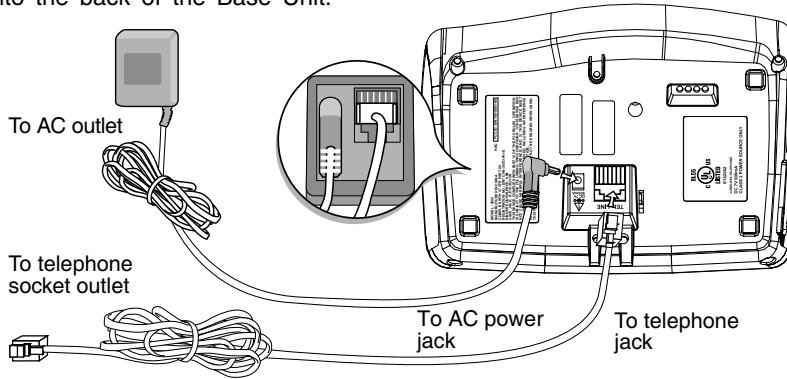

Connecting to phone line

Plug one end of the telephone line cord into the jack on the back of the Base Unit. Plug the other end of this cord into the wall jack.

Checking for dial tone

After the battery is charged press **ON** on the Handset. The Phone icon  will appear on the Handset display, and you will hear dial tone. If not, see **In Case of Difficulty**.

Tone/Pulse selection

See **BASE SETTINGS** for details.



CAUTION: Use only the power supply provided with your **2652** Unit.

IMPORTANT:

For best performance the 2652 should be installed as follows:

In an elevated location, in the center of the room, with no obstructions nearby.

In a location that is away from other electrical appliances such as microwave ovens, personal computers, or televisions.

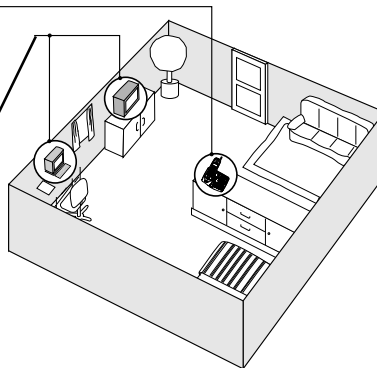

Installation of Battery Pack in Handset

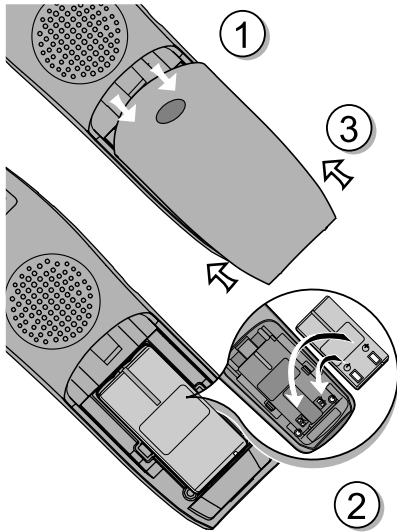

Follow the steps below:

1. Remove battery compartment cover by pressing on the indent and sliding downward.
2. Place the new battery pack in the Handset aligned with the metal contacts aligned with the charge contacts in the battery compartment.
3. Replace the battery compartment cover by sliding it upwards.
4. If the new battery pack is not already charged, place the Handset in the Base Unit, or a charging stand, and allow it to charge for 10-12 hours. After initial charge, a maintenance charge of 8 hours should be sufficient.

The original Handset that is shipped with your **2652** system will be automatically registered to the Base. This Handset is **HANDSET 1**.

As you register additional Handsets to the system, they will be assigned extension numbers in the following order: **HANDSET 2**, **HANDSET 3** and **HANDSET 4**.

Whenever a Handset battery pack is installed, the Handset will automatically begin **SEARCHING FOR BASE** (if previously registered), or it will prompt you to **ENTER BASE ID** to register the new Handset.

Spare Battery Charger/Power Backup Function

The **2652** can use the spare battery in the Base Unit to provide operational backup in the event of a power failure. With a fully charged battery pack in the spare battery charger, you will still be able to place and receive calls from the Handset for up to 3 hours.

The spare battery pack can also be used to replace a drained Handset battery, ensuring uninterrupted use.

NOTE:

When using the **2652** during Power Backup mode, audio quality may be compromised due to reduced Power availability. The Base Unit can't be used when in power backup mode.

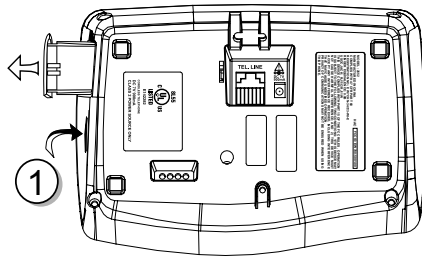

1. Open the spare battery charger by pressing the release button, located on the right-hand side of the Base Unit. A drawer will open to reveal the spare battery compartment.
2. Place a battery pack in the drawer with the charge contacts facing up and to the left.
3. Push the drawer closed.

The spare battery takes 24 hours to fully charge a drained battery.

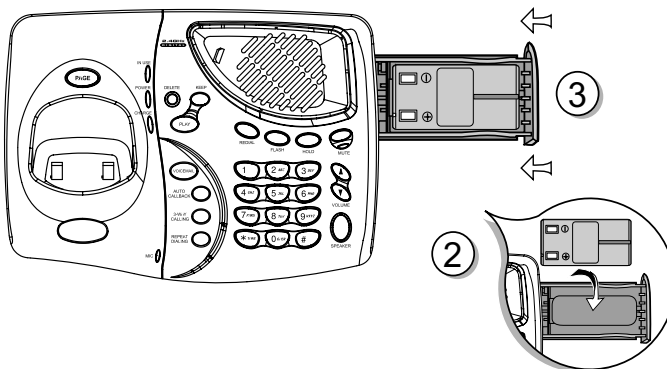

Charging Of Handset Battery Pack

The Handset of your **2652** cordless telephone is powered by a rechargeable battery pack. It charges automatically whenever the Handset is in the Base Unit.

You should charge the battery pack for 12 hours when you first receive your phone. You'll know the battery pack needs charging when:

- The low battery message is displayed:
- The Handset seems completely dead, the LCD is completely clear and does not activate when you press the keys.



CAUTION: to reduce the risk of fire or injury to persons by battery, read and follow these instructions.

1. Use only the appropriate type and size battery pack specified in the instruction manual provided for this product.
2. Do not dispose of the battery pack in a fire. The cell may explode. Check with State and local codes for possible special disposal instructions.
3. Do not open or mutilate the battery pack. Released electrolyte is corrosive and may cause damage to the eyes or skin. It may be toxic if swallowed.
4. Exercise care in handling battery in order not to short the battery with conducting materials such as rings, bracelets, and keys. The battery or conductor may overheat and cause burns.
5. Charge the battery pack provided with or identified for use with this product only in accordance with the instructions and limitations specified in the instruction manual.
6. Observe proper polarity orientation between the battery pack and battery charger.

Registration and Operation

Registration and Operation of the 2603 Accessory Handset

Your 2652 system can operate up to 4 Handsets.

The accessory Handset consists of the following:

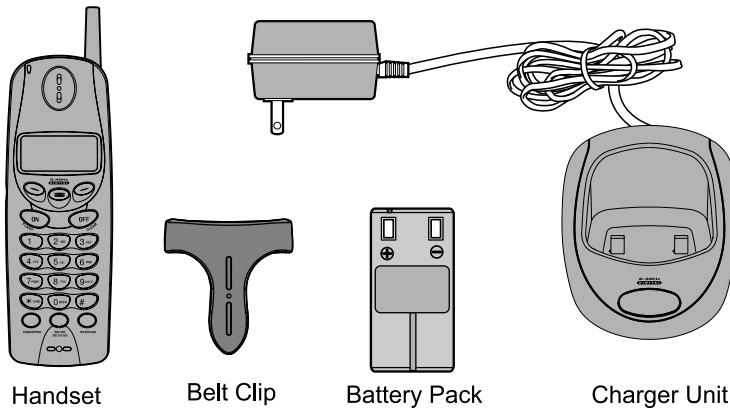

Setup of the 2603 Accessory Handset

1. Plug the AC power adapter into an electrical outlet, then the DC connector into the bottom of the Charger Unit.
2. Remove the Handset battery compartment cover by pressing on the indent and sliding downward.
3. Place the new battery pack in the Handset, with the metal contacts aligned with the charge contacts in the battery compartment.
4. Replace the battery compartment cover by sliding it upward.
5. Place the Handset in the Charge Cradle, and allow it to charge for 10-12 hours. After the initial charge, a maintenance charge of 8 hours should be sufficient.

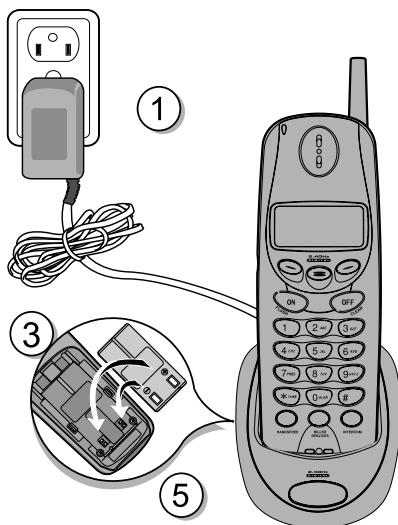

Registration and Operation

Enter Base ID Code

1. After charging the Handset, remove it from its Charge Cradle, the screen will display:



2. Press **NEW**, then enter the 15 digit Base Unit ID code, located on the underside of the Base Unit.

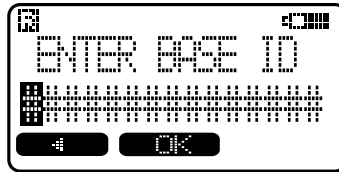

3. Press **OK**. The Handset will display: **PLEASE WAIT!!**



4. Wait approximately 15 seconds. The Handset will display: **FOUND BASE**

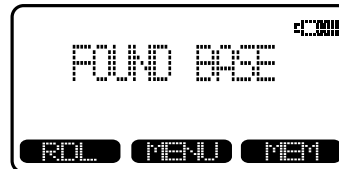







If the Handset displays: **SYSTEM IS BUSY PLEASE TRY LATER**, this indicates that the system is in use. Wait until the Base Unit is in the idle (on hook) mode, and repeat steps 2 through 4.

Congratulations! You can now enjoy the benefits of your multi-Handset system.



Handset and Base Indicators

Handset Icons

Icon	Description
	Line In Use indicator On steady with no number next to it when a parallel set is in use. On steady with one or more numbers next to it, indicating which extensions are using the line. For example,  12 indicates that Handset 1 and Handset 2 are on an outside call.
	Intercom indicator On steady with the extension numbers currently on an intercom call. For example,  02 indicates that the Base and Handset 2 are on an intercom call.
	Battery indicator Cycles (Low, Medium, and High) when Handset battery is charging. Flashes when a low battery condition is detected.
M	Mute indicator On steady when the Handset microphone is muted.
H	Hold indicator On steady when the line is on hold.
E	Range Extender indicator On steady when the Range Extender is on.
	Handset Registration indicator  is displayed when a Handset is either not registered, or is searching for a Base Unit.

Handset and Base Indicators

Handset LEDs

LED	Description
Message Waiting	<ul style="list-style-type: none"> Flashes to indicate that you have new messages in your voicemail. Service must be subscribed to through your local telephone company.

Base LEDs

LED	Description
VOICEMAIL	<ul style="list-style-type: none"> Flashes to indicate that you have new messages in your voicemail. Service must be subscribed to through your local telephone company.
Power	<ul style="list-style-type: none"> Lights when Base unit is receiving power from wall outlet. Flashes when unit is in Power Backup mode.
In Use	<ul style="list-style-type: none"> Lights when line is being used by any Handset of the 2652 system. Flashes when another telephone on the same line (parallel extension) is in use. Flashes following ringing cadence while the phone is ringing.
Charge	<ul style="list-style-type: none"> Lights whenever the Handset is placed in the Base Unit charging cradle. Flashes briefly when put a spare battery in the spare battery compartment.
Mute	<ul style="list-style-type: none"> Lights when Base microphone is muted.
Speaker	<ul style="list-style-type: none"> Flashes when HOLD function is activated. Lights when Base speaker is in use.

Soft Menu Functions

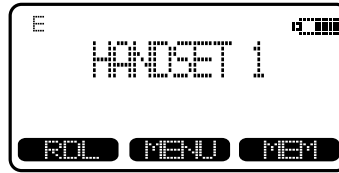

The **2652** has an advanced design that uses a menu structure and soft keys to access all of the built-in features.

Example of the idle mode display:



RDL (Redial)

Press **RDL** to display the last 5 telephone numbers dialed. The number on top line is the most recent number dialed.

- Use the  /  scroll keys to select the desired number.
- To dial the number, you can simply press the **ON** or **HANDSFREE** key.

To Save Redial to Memory:

Use the scroll keys to select the desired number. Then press **SELECT**. Press **SAVE**. Use the steps from 3 to 5 of **To Store a Number/Name**.



To Erase Redial:

Use the scroll keys to select the desired number. Then press **SELECT**. Press **ERASE**.



MENU

With the Handset in the idle (OFF) mode, press the **MENU** key to access the following options:



- **CALLS LOG (CALLER ID)**
- **ANNOUNCE CID**
- **HANDSET SETTINGS**
- **RANGE EXTENDER**
- **TONE/PULSE**
- **REGISTER**
- **VOICEMAIL SETUP**

Use the  /  scroll keys to select the desired option, then press **OK**.

Calls Log (Caller ID)

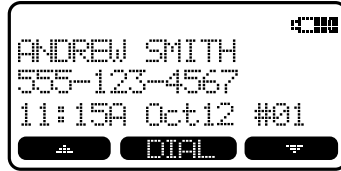
From the idle (OFF) mode, press **MENU**, use the  /  scroll keys to select **CALLS LOG**, then press **OK**. The Caller ID information of the most recently received call will be displayed.



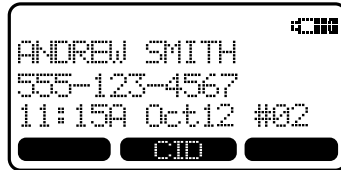

To scroll to other records, use the  /  scroll keys.

To dial the number displayed, you can simply press the **ON** or **HANDSFREE** key.



You can also press the **CID** key to access the following options (DEL, OPT#, SAVE):

- DEL:** Select this option to delete THIS or ALL records in Caller ID memory.
- OPT#:** Select this option to display up to four possible dialing strings of the number stored in Caller ID memory. If a number is provided in the Caller ID data, the possible options to choose from will be either 7, 8, 10, or 11 digits. For example, if the original number in Caller ID memory was 808-880-8808, then the display options will be:

Use the  /  keys to make selection, and then press **DIAL**, **ON** or **HANDSFREE** to dial the number.

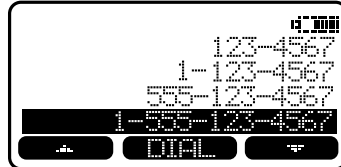

- SAVE:** Select this option to save the displayed Caller ID record into Phonebook Memory. Only Caller ID records with telephone numbers can be saved into Phonebook Memory. If you need to modify the number after saving, see To Edit a Name or a Number.

Caller ID - Call Waiting ID

Your **2652** is capable of displaying the name and/or number of the party calling before you answer the phone (**Caller ID**). It is also capable of displaying Caller ID information in conjunction with a Call Waiting alert signal (**Call Waiting Caller ID**). With Call Waiting Caller ID, the Caller ID data is displayed so you can decide whether to answer the incoming call, or continue with your current conversation.

NOTES ABOUT CALLER ID & CALL WAITING CALLER ID

These are subscription services, provided by most regional telephone service providers. You must subscribe to these services to get the benefits of these features. If you do not subscribe to Caller ID services, you can still use your **2652** and the other features it offers.

Due to regional incompatibilities, Caller ID information may not be available for every call you receive. In addition, the calling party may intentionally block their name and phone number from being sent.

Handset Settings

From the Handset Settings menu you can select the following options to modify:

- **RINGER VOLUME**

Select this option to adjust the ringer volume. Use the  scroll keys to adjust the volume up or down. The Handset will display a graphic indicator of the selected volume setting. Press **OK** to confirm your selection and return to the Handset Settings menu.
- **RINGER MELODY**

Select this option to adjust the ringer melody or tone. Use the  scroll keys to select from the six available tones. Press **SAVE** to confirm your selection and return to the Handset Settings menu.
- **LOW BATT TONE**

Select this option to turn the Low Battery warning tone ON or OFF. Press the **OFF** or **ON** soft keys, to make your selection. Press **OK** to confirm your selection and return to the Handset Settings menu. When set to ON, the Handset will emit a warning tone when a Low Battery condition is detected.
- **RANGE TONE**

Select this option to turn the Out of Range warning tone ON or OFF. Press the **OFF** or **ON** soft keys, to make your selection. Press **OK** to confirm your selection and return to the Handset Settings menu. When set to ON, the Handset will emit a warning tone whenever the Handset is taken out of range of the Base.
- **KEYPAD TONE**

Select this option to turn the Keypad tones ON or OFF. Press the **OFF** or **ON** soft keys to make your selection. Press **OK** to confirm your selection and return to the Handset Settings menu. When set to ON, the Handset will emit a beep whenever a key is pressed.
- **CONTRAST**

Select this option to adjust the contrast level of the Handset display. Use the  scroll keys to make your selection. The Handset display will automatically adjust as you make your selection. Press **OK** to confirm your selection and return to the Handset Settings menu.
- **LANGUAGE**

Select this option to change the display to appear in English, Spanish or French. Use the  scroll keys to select language, then press **OK** to confirm your choice.

Range Extender

Your **2652** has an enhanced feature that is designed to improve performance. This feature is useful if you are using your **2652** in an area with excessive interference or you require a moderate increase in operating range. The Range Extender feature can help to improve both the sound quality and range. Actual range will depend on your environment.

To select the Range Extender setting, follow these steps:

- In the idle (**OFF**) mode, press **MENU** and use the scroll keys to select **RANGE EXTENDER**, then press **OK**.
- There are 3 option settings in the **RANGE EXTENDER** menu:
 1. Select **OFF** to disable **RANGE EXTENDER**.
 2. Select **ON** to enable **RANGE EXTENDER**. An "E" icon will appear in the upper left corner of Handset display, indicating that **RANGE EXTENDER** is **ON**.
 3. Select **AUTO** to allow your **2652** to automatically monitor the signal strength between the Handset and Base Unit, and activate whenever necessary. With this option selected, your **2652** may occasionally enable or disable the **RANGE EXTENDER** feature.
- Use the scroll keys to select the desired setting, and then press **OK** to confirm the selection.

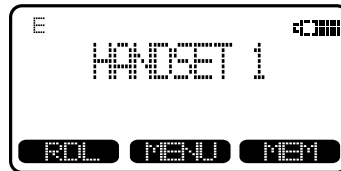

Note: When Range Extender mode is enabled, your **2652** will consume more battery power. That means the standby and talk time of your Handset will be shorter.

Register

Use this option to register a Handset to the **2652** Base. You can register a total of four Handsets to the **2652** Base. This process is activated automatically whenever a new Handset is powered up in range of the **2652** Base.

You will be prompted to enter the 15-digit Base ID code printed on the underside of the Base unit. After entering this code, press **OK**. The Handset will display **SEARCHING FOR BASE**, and then **FOUND BASE** when the process is complete.

Note: Base ID codes are 15 digits long and can include the following characters: 0, 1, 2, 3, 4, 5, 6, 7, 8, 9, or #.

MEM (Memory)

The **2652** can store up to 50 numbers with names in memory. Each memory location can hold up to 32 digits for the number for the number and up to 16 characters for the name.

When prompted to **ENTER NAME**, use the digit keys to 'spell' the name. Each press of a particular key causes characters to be displayed in the following order:

Number Key	Characters (in order)
1	& ' , . 1
2	A B C a b c 2
3	D E F d e f 3
4	G H I g h i 4
5	J K L j k l 5
6	M N O m n o 6
7	P Q R S p q r s 7
8	T U V t u v 8
9	W X Y Z w x y z 9
0	0
*	*
#	#

MEM (Memory)

To Store a Number/Name:

- Starting from the idle screen, enter the number you want to store in memory.
- Be sure to include long distance codes and pauses (using the **Pause** softkey) if necessary. Press OFF to correct if you make mistake. Press the **MEM** softkey.

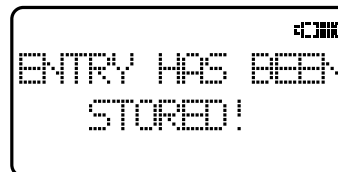
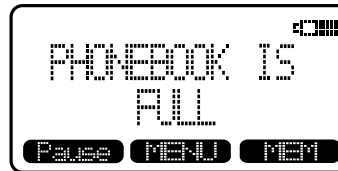
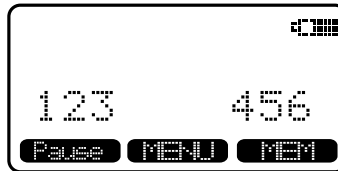
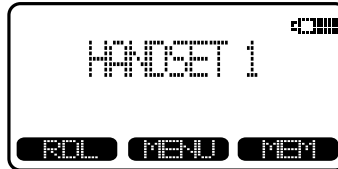

NOTE: If the memory is full the Handset will display **PHONEBOOK IS FULL** and exit to the pre-dial mode without saving the entry.

- You will then be prompted to **ENTER NAME**. Use the digit keys to 'spell' the name. If you make a mistake, press the **CLR** softkey. To enter a space press **[Space]**. When finished, press **SAVE**.
- If there is space available in memory, the entry will be saved and the Handset will display **RECORD ANNOUNCE CID?**
- If you want to record Name and Number Announce, please follow the steps in **Record a New Name and Number Announce - Form New Phonebook Entry** on page 34. If not, press and hold **OFF**.



MEM (Memory)

To Search For and Dial a Number/ Name:

- Starting from the idle screen, press the **MEM** softkey to review memory contents.
- Using the  /  softkeys scroll through the memory contents in alphabetical order.



Or, you can press the **FIND** softkey, enter the first few characters of the name. If you make a mistake, press the **CLR** softkey. Press **FIND** to search. The closest match, in alphabetical order, will be displayed.

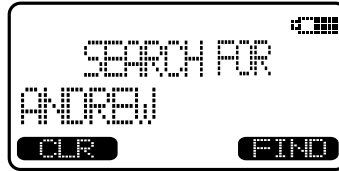

- Once you find the entry you want, simply press **ON** or **HANDSFREE** to dial the number.



To Delete a Number/Name:

- Using steps 1 and 2 in **To Search For and Dial a Number/ Name**, locate the entry you want to delete.
- Press the **EDIT** softkey. The Handset will display:



MEM (Memory)

- Press the **DEL** softkey. The Handset will display:
- To delete the displayed records, press **THIS**. To delete all records, press **ALL**.
- If you press **ALL**, The screen will display: **ARE YOU SURE?**
- To confirm the deletion of all records, press **YES**. To exit without deleting press **NO**.



To Edit a Name or a Number

- Using steps 1 and 2 in **To Search For and Dial a Number/Name**, locate the entry you want to edit.
- Press the **EDIT** softkey twice. Then choose **NAME** or **NUM**.
- Using the **←** softkey move the cursor to the character you want to edit and then enter the corrections as needed. Press **MORE** access **DEL**, **BACK** and **Pause** (when edit a name, **SPACE**) function. When finished press the **SAVE** softkey. To exit without saving press **OFF**.
- When finished the Handset will display the edited entry.



Base Settings

The **2652** Base Unit has several settings that can be adjusted according to your preference and system requirements.

Select Base Ringer Melody:

- The phone must be off.
- Press the star key three times (***). The Base will emit a happy tone and the Power and In Use LEDs will flash rapidly.
- Press the **1, 2, 3, 4, 5, or 6** keys to select the Ringer Melody. After each key press, the Base will emit a 1-second preview of the selected ringer.
- To save the selected ringer (and exit) press **#**.
- To exit without saving press *****.

Select Tone/Pulse:

For Base:

- The phone must be off.
- Press the star key three times (***). The Base will emit a happy tone and the Power and In Use LEDs will flash rapidly.
- Press the **7** key to toggle between TONE and PULSE dialing mode. The In Use LED will toggle ON when TONE is selected and OFF when PULSE is selected.
- To save the TONE/PULSE selection (and exit) press **#**.
- To exit without saving press *****.

For Handset:

- Press **MENU**.
- Use the scroll keys to select **TONE/PULSE**, then press **OK**.
- Use the scroll keys to select **TONE** or **PULSE**, then press **OK**.



Base Settings

Select Base Ringer Volume and OFF:

- The phone must be off.
- Press the star key three times (***). The Base will emit a happy tone and the Power and In Use LEDs will flash rapidly.
- Press the volume up and down keys (▲/▼) to adjust the Base Ringer volume. After each press of the volume keys, the Base will emit the selected Ringer and volume setting for one second.
- To turn the Base ringer OFF, press the volume down key until no ringer preview is played.
- To save the Ringer Volume selection (and exit) press #.
- To exit without saving press *.

Handset and Base Operation

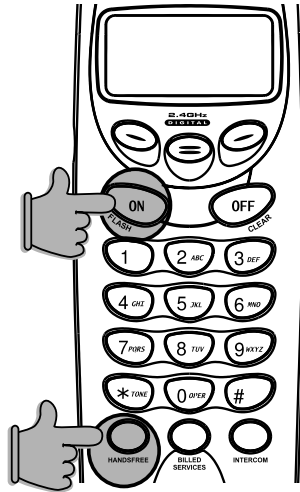

Making Calls

From the Handset:



- Press **ON** (or **HANDSFREE** to use the Handset Speakerphone feature). Dial the phone number.

-OR-

- Dial the phone number first, then press **ON** (or **HANDSFREE**).
- Press **OFF** to end your call.

From the Base Unit:



- Press **SPEAKER**. Dial the phone number.
- Press **SPEAKER** to end your call.

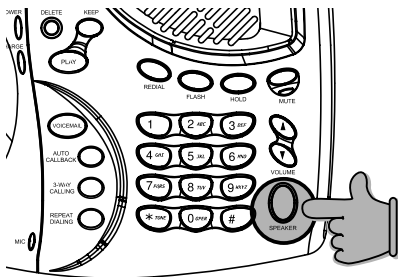

Answering Calls

From the Handset:

- Press any key except **OFF** and the softkeys.
- Press **OFF** to end your call.

From the Base Unit:



- Press **SPEAKER**.
- Press **SPEAKER** to end your call.

Redial from Base Unit



- Pressing **REDIAL** will immediately dial the last number in the Base Unit redial memory. Hold down the **REDIAL** key for more than 2 seconds to erase the contents in redial memory. This is to prevent the accidental dialing of the number stored in redial memory.

Handset and Base Operation

Mute Function

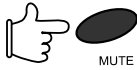

During an active call pressing either the **MUTE** soft key on the Handset or the **MUTE** key on the Base (when in speakerphone mode), will disable the microphone. Press the **MUTE** key again to return to normal 2-way conversation.

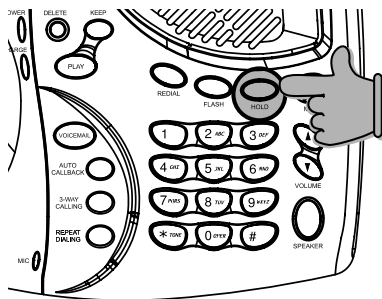

Hold Function

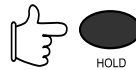

From the Handset:

- Press the **HOLD** soft key to place a call on hold. To return to the call press the **ON** or **HANDSFREE** key.

From the Base:

- During an active call, press the **HOLD** key to place a call on hold. The **SPEAKER** LED will flash to indicate a call is on hold.
- To return to the call press either **HOLD** or **SPEAKER**.

Flash Function

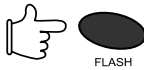

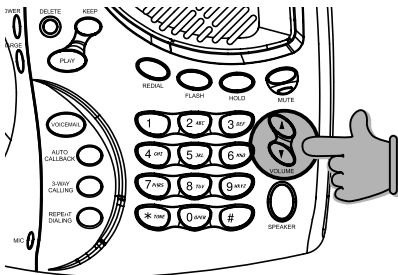

You can use your 2652 with services such as Call Waiting. When you receive a call waiting signal, simply press the **ON/FLASH** key on the Handset or the **FLASH** key on the Base (when in speakerphone mode) to Flash the line.





Volume Control



From the Handset:

During an active call press the **VOL** soft key, then use the  and  soft keys to adjust the earpiece volume.

From the Base:

During an active call simply press the Volume  /  keys to adjust the speakerphone volume. You will hear a special tone when you reach the highest or lowest setting.

Handset and Base Operation

Page/Intercom

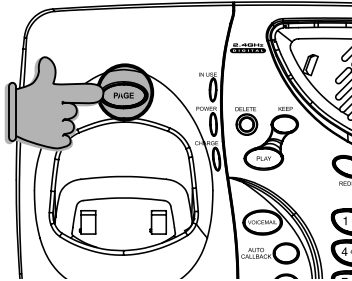
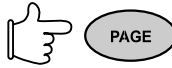

From Base to ALL Handsets:

- To page all Handsets from the Base press the **PAGE** key. This will cause all Handsets linked with this Base to ring.
- Each Handset will display **GLOBAL CALL FROM BASE**.
- Any Handset can answer the page and enter intercom mode with the Base by pressing any key (except **OFF** and soft keys).
- To end an intercom call, press **OFF** on the Handset or **PAGE** on the Base.

From Base to a particular Handset:

- Press the Base **PAGE** key, then press the number of the Handset you want to call (e.g. **Handset 2**).
- Handset 2 can then answer the intercom call by pressing any key (except **OFF** and Softkeys).
- To end an intercom call press **OFF** on the Handset or **PAGE** (or **SPEAKER**) on the Base.

From Handset to Base:

- Press the **INTERCOM** key followed by **0**.
- The Base will ring once and then automatically enter intercom mode.
- To end an intercom call press **OFF** on the Handset or **PAGE** (or **SPEAKER**) on the Base.

From Handset to Handset:

- Press the **INTERCOM** key followed by the number of the other Handset you wish to call (e.g. **Handset 3**).
- Handset 3 can then answer the intercom call by pressing any key (except **OFF** and Softkey).
- To end the intercom call press **OFF** on either Handset.

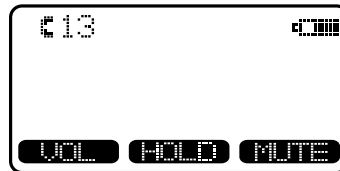

Handset and Base Operation

Call ALL from Handset:

- Press the **INTERCOM** key followed by the *. All registered Handsets and the Base will ring.
- Any Handset can answer by pressing **INTERCOM**, or the Base can answer by pressing **SPEAKER**.
- To end the intercom call press **OFF** on Handset, or press **SPEAKER** on Base.

Handsfree Speaker Operation

Your **2652** Handset has a built-in handsfree speaker. This feature allows you to stand the Handset upright on a table or desktop and have handsfree conversations. For more information, refer to **MAKING CALLS** in **HANDSET AND BASE OPERATION**.

To Switch Between Earpiece and Speaker

While on a call you can press **HANDSFREE** to switch to speaker. While on a speaker call, press **HANDSFREE** again to the Handset earpiece.

Handset and Base Operation

Base Speaker Operation

The Base of your **2652** is equipped with a full duplex speaker. This is a very useful feature for handsfree conversations or conference calls at the Base Unit. For more information, refer to **MAKING CALLS** in the **HANDSET AND BASE OPERATION** section.

Line in Use Indication

On the Handset:

When the telephone line is currently being used by a system Handset or the **2652** Base, a status message similar to this will display on idle Handset(s):

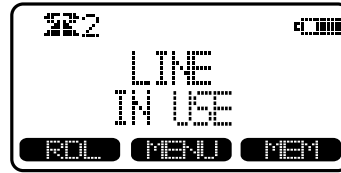

When the telephone line is currently being used by a parallel set (a telephone device other than the **2652** on the same line) the phone icon will remain on steadily, and **EXTENSION IN USE** will be displayed on the Base:

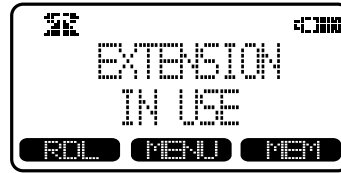

When a system Handset or a **2652** Base is currently being used, the **IN USE** LED on the Base will illuminate steadily. When a parallel set is currently being used, the **IN USE** LED on the Base will flash.

Low Battery Indication

When a low battery is detected, the Battery icon will flash and a warning beep is played. The status message **LOW BATTERY** will also be displayed when the Handset is in idle mode. To prevent an unexpected call drop, a drained Handset battery should be replaced by a fully charged spare battery.

Handset and Base Operation

Conference Calling

The **2652** is capable of supporting conference calls with up to two registered Handsets and the Base Unit.

To enter a conference call, simply access the line with two or three extensions by pressing **ON** (or **HANDSFREE**) on the Handset or **SPEAKER** on the Base. The phone icon  and two or three extension numbers will be displayed in the upper left corner of the Handset.

Transferring Calls

You can transfer calls on the **2652** system from the Base to Handset, Handset to Handset, or Handset to Base.

Blind Transfer

You can directly transfer any active call to another system extension without notification by doing the following steps:

- Handset or Base must be on an active call.
- Press the **INTERCOM** key on the handset or **PAGE** key on the base followed by the number of the Handset (**1, 2, 3, 4**) or Base (**0**) that you wish to transfer the call to.
- When the other extension answers, the call will automatically be connected to the other extension.
- An unanswered call will ring back to the originating Handset/Base if not answered within 30 seconds. And if it is still not answered within another 30 seconds, the call will automatically be terminated.

Announced Transfer

You can perform an announced transfer (call and advise another extension) of an active call by following these steps:

- Handset or Base must be on an active call.
- Place the active call on **HOLD**.
- Press the **INTERCOM** key on the handset or **PAGE** key on the base followed by the number of the Handset (**1, 2, 3, 4**) or Base (**0**) that you wish to transfer the call to.
- When the other extension answers the intercom call, explain they have an active call waiting.
- Either extension can press the **OFF** key on the handset or **PAGE** key on the base to end the intercom call.
- The other extension presses **ON** (or **HANDSFREE**) on the Handset, or **SPEAKER** on the Base to pick up the call on hold.

Handset and Base Operation

Message Waiting

When a voicemail is detected the **VOICEMAIL** key will be illuminated with a flashing yellow LED. The LED in the handset will also flash.



Programming Voicemail Access

Once your voicemail access number and password are programmed into the **2652**, you can quickly retrieve voicemail messages by pressing the **VOICEMAIL** key on the base.

NOTE: In order to use these features, you must subscribe to and activate voicemail service through your local telephone company.



VOICEMAIL Access Key

From the idle (OFF) mode, press **MENU**, use the  /  scroll keys to select **VOICEMAIL SETUP**, then press **OK**. The following screen is displayed:



Use the  /  scroll keys to select **ACCESS NUMBER**, then press **OK**. You will see the following display:

The default voicemail access number is **#99**. If this does not match the number provided by your local telephone company, you will need to edit the number. Press **EDIT**.





Enter the voicemail access number provided by your local telephone company. To enter pauses, or delete characters, use the **MORE** key. When finished press **SAVE**.



You will then need to program your voicemail **PASSWORD**. First, you must activate and define your voicemail password with the voicemail service provided by your local telephone company.

Once you have defined your password, you can then program it into the **2652**.

Handset and Base Operation

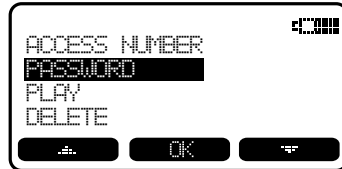
From the idle (OFF) mode, press **MENU**, use the  /  scroll keys to select **VOICEMAIL SETUP**, then press **OK**. The following screen is displayed:



Use the  /  scroll keys to select **PASSWORD**, then press **OK**. You will see the following display:



Press **EDIT**. Enter your password. To enter pauses or delete characters, use the **MORE** key. When done press **SAVE**.



Using the dedicated PLAY, KEEP and DELETE keys

The **2652** is factory programmed with the appropriate key sequences for **PLAY**, **KEEP**, and **DELETE**.

When retrieving voicemail messages, you can use the dedicated keys on the Base Unit to access these functions.

If the default programming for the **PLAY**, **KEEP** and **DELETE** keys do not work with your voicemail system, you can reprogram the keys using the following steps:

PLAY Access Key

From the idle (OFF) mode, press **MENU**, use the  /  scroll keys to select **VOICEMAIL SETUP**, then press **OK**. The following screen will be displayed:

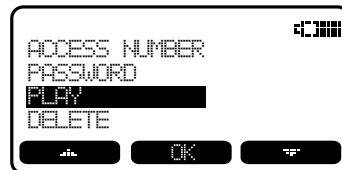

Use the  /  scroll keys to select **PLAY**, then press **OK**. You will see the following display:





Reprogramming PLAY

The default **PLAY** access number is 1. If this does not match the number provided by your local telephone company, you will need to edit the number.

Press **EDIT**. Enter the **PLAY** access number provided by your local telephone company. To enter pauses, or delete characters, use the **MORE** key. When finished press **SAVE**.

Handset and Base Operation

KEEP Access Key

From the idle (OFF) mode, press **MENU**, use the  /  scroll keys to select **VOICEMAIL SETUP**, then press **OK**. The following screen will be displayed:



Use the  /  scroll keys to select **KEEP**, then press **OK**. You will see the following display:





Reprogramming KEEP



The default **KEEP** access number is **2**. If this does not match the number provided by your local telephone company, you will need to edit the number.

Press **EDIT**. Enter the **KEEP** access number provided by your local telephone company. To enter pauses, or delete characters, use the **MORE** key. When finished press **SAVE**.

DELETE Access Key

From the idle (OFF) mode, press **MENU**, use the  /  scroll keys to select **VOICEMAIL SETUP**, then press **OK**. The following screen will be displayed:



Use the  /  scroll keys to select **DELETE**, then press **OK**. You will see the following display:



Reprogramming DELETE

The default **DELETE** access number is **3**. If this does not match the number provided by your local telephone company, you will need to edit the number.

Press **EDIT**. Enter the **DELETE** access number provided by your local telephone company. To enter pauses, or delete characters, use the **MORE** key. When finished press **SAVE**.

Name and Number Announce Caller ID

Name and Number Announce Caller ID is an advanced feature that enables your telephone to announce the name or telephone number of callers before you answer the call. Announcements are made from the Base Unit speaker. You must subscribe to Caller ID service in order to use this feature.

Name and Number announcements are recorded in your own voice. You can record up to 50 Name and Number announcements (one for each entry in your Phonebook directory). Each Name and Number announcement can be up to 3 seconds long. Please refer to the steps below to setup Name and Number Announcement.

NOTE: If an inbound call has the Caller ID information blocked, and Name and Number Announcement is enabled, the Base Unit will announce "PRIVATE CALLER". If an inbound call has the Caller ID information out of area, and Name and Number Announcement is enabled, the Base Unit will announce "UNKNOWN CALLER".

Setup Name and Number Announcement

- In the idle (OFF) mode, press **MENU** and use the scroll keys to select **ANNOUNCE CID**, then press **OK**.
- Use the scroll keys to select **SELECT TYPE**, then press **OK**.
- Use the scroll keys to select one of the four options: **OFF**, **NUMBER**, **NAME**, **NUMBER AND NAME**, then press **OK**.
 - **OFF**: Select this option to disable Name and Number announcement.
 - **NUMBER**: Select this option to enable Name and Number announcement of received telephone numbers only.
 - **NAME**: Select this option to enable Name and Number announcement of recorded Name and Number announcements only.
 - **NAME AND NUMBER**: Select this option to enable Name and Number announcement of telephone numbers (for calls received that don't match an entry in your phonebook), or Name and Number announcement of recorded Name and Number announcements.

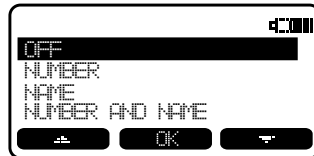

Record a New Name and Number Announcement

From New Phonebook Entry:

- Follow the steps in **To Store a Number/Name** (Page 20).
- After the **ENTRY HAS BEEN STORED** message is displayed, you will then be prompted to **RECORD ANNOUNCE CID?**
- If you choose **NO**, the entry will be stored without a Name and Number announcement.
- Choose **YES** to record a Name and Number announcement.



Name and Number Announce Caller ID

- Press the **RECORD** key. You will be prompted to **RECORD AFTER TONE**. Speak directly into the handset microphone to record up to 3 seconds of audio.
- You can press the **STOP** key when you are done, or simply wait for recording to automatically stop after 3 seconds.
- Press **PLAY** to review the Name and Number announcement. The audio will playback from the Base Unit speaker.
- You can also choose to **ERASE** the announcement or **RECORD** a new announcement.

From RECORD NEW function:

- In the idle (**OFF**) mode, press **MENU** and use the scroll keys to select **ANNOUNCE CID**, then press **OK**.
- Use the scroll keys to select **RECORD NEW**, and then press **OK**.
- Use **FIND** or scroll key to locate the phonebook record that you want to record your announcement.
- After you have located the desired entry, press the **EDIT** softkey. The Handset will display:
- Press **RECORD**. If there is already an announcement. The display will prompt **ANNOUNCE CID ALREADY RECORDED**. However, you can record over the old audio by pressing the **RECORD** softkey twice, then re-record.
- If there is no announcement recorded, press **RECORD** softkey to make the recording.

Review, Play, Erase or Re-Record a Name and Number Announcement

- In the idle (**OFF**) mode, press **MENU** and use the scroll keys to select **ANNOUNCE CID**, then press **OK**.
- Use the scroll keys to select **REVIEW**, and then press **OK**.
- Use **FIND** or scroll key to locate the record that you want to playback.
- Press **SELECT** to review the record. You can use:
 - **ERASE**: Delete current Name and Number announcement.
 - **PLAY**: Playback the current Name and Number announcement.
 - **RECORD**: You can re-record your current Name and Number announcement .



Custom Pay-Per-Use (PPU) Features

AUTO CALL BACK dials the last party who called you, whether or not you answered the call. A charge is added to your phone bill each time you use this feature.



3-WAY CALLING allows you to talk with 2 separate parties from a single line.

To use this feature, follow these steps:

- 1) Call your first party, after the party answers,
- 2) Press **3-WAY CALLING**. Wait for dial tone.
- 3) Call your second party, after the call is answered,
- 4) Press **3-WAY CALLING** again.

A charge is added to your phone bill each time this service is used.

REPEAT DIALING repeatedly dials the last number you called, over a time interval determined by your local phone company. This is useful in reaching a party whose line is busy. A charge is added to your phone bill each time this service is used.

NOTE: For handset Pay-Per-Use, press handset **BILLED SERVICES** key. Then use  /  to scroll to your desired option. Press **OK** to confirm. It is likely that your local telephone company will assess charges to use custom features. You should check with your local service provider regarding which custom services are available in your area, and the associated costs for the intentional or unintentional use of Pay Per Use services.

Your local telephone company may provide a monthly subscription to an individual service or a package of services which gives you unlimited usage for a small monthly fee.

Headset Operation

Your **2652** cordless telephone is equipped with a 2.5mm Headset Jack for use with an optional accessory Headset for hands-free operation.

Once you have a compatible 2.5mm Headset, locate the Headset Jack on the Handset. Connect the plug on the Headset cord to the jack (covered with a small rubber flap) on the cordless Handset. The plug should fit securely. Do not force the connection.

Operation

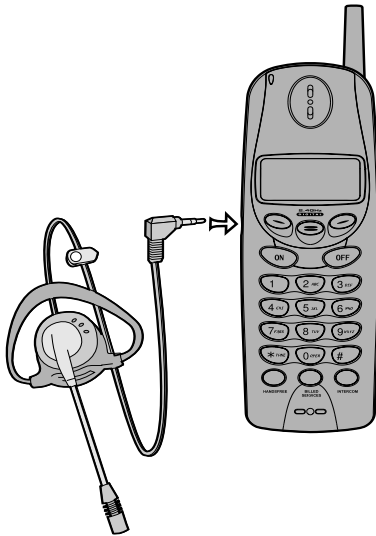

NOTE:

Whenever a compatible Headset is connected to the cordless Handset, the microphone on the Handset will be muted. This is done to limit the effect of background noise.

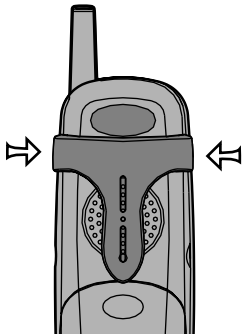

Belt Clip

The Handset is also equipped with a detachable belt clip. Align the pins on the inside edge of the clip with the notches on the sides of the Handset. The belt clip should snap securely into place. Do not force the connection.

In Case Of Difficulty

If you have difficulty operating your phone, the suggestions below should solve the problem.

The Phone Doesn't Work At All

- Make sure the Power Cord is plugged in.
- Make sure the telephone line cord is plugged firmly into the Base Unit and the telephone wall jack.
- Make sure the batteries are properly charged. If the LOW BATTERY message is shown, the battery pack needs charging.

No Dial Tone

- First check all the suggestions above.
- If you still don't hear a dial tone, disconnect the Base Unit from the telephone jack and connect a different phone. If there is no dial tone on that phone either, the problem is in your wiring or local service. Contact your local telephone company.

You Get Noise, Static, Or A Weak Signal Even When You're Near The Base Unit

- Household appliances plugged into the same circuit as the Base Unit can sometimes cause interference. Try moving the appliance or the Base Unit to another outlet.

You Get Noise, Static, Or A Weak Signal When You're Away From The Base Unit

- You may be out of range. Either move closer to the Base, or relocate the Base Unit.
- The layout of your home may be limiting the range. Try moving the Base Unit to another position.

The Handset Does Not Ring When You Receive A Call

- Make sure you have the Handset ringer activated. To set the ringer, see **HANDSET SETTINGS** and **BASE SETTINGS**.
- Make sure the telephone line cord is plugged firmly into the Base Unit and the telephone jack. Make sure the power cord is plugged in.
- You may be too far from the Base Unit.
- You may have too many extension phones on your telephone line to allow all of them to ring. Try unplugging some of the other phones.

You Hear Other Calls While Using Your Phone

- Disconnect your Base Unit from the telephone jack, and plug in a regular telephone. If you still hear other calls, the problem is probably in your wiring or local service. Call your local telephone company.

You Hear Noise In The Handset, And None Of The Keys Or Buttons Work

- Make sure the power cord is plugged in.

In Case Of Difficulty

Common Cure For Electronic Equipment

If the unit does not seem to be responding normally, then try putting the Handset in the cradle. If it does not seem to respond, do the following (in the order listed):

1. Disconnect the power to the Base.
2. Disconnect the Handset battery, and spare battery pack, if applicable.
3. Wait a few minutes.
4. Connect power to the Base.
5. Re-install the battery pack(s)
6. Watch for Handset to display:



then

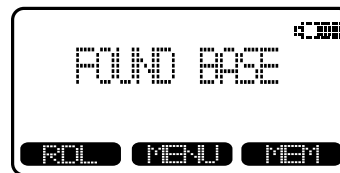

Maintenance

Taking Care Of Your Telephone

Your **2652** cordless telephone contains sophisticated electronic parts, so it must be treated with care.

Avoid Rough Treatment

Place the Handset down gently. Save the original packing materials to protect your telephone if you ever need to ship it.

Avoid Water

Your telephone can be damaged if it gets wet. Do not use the Handset outdoors in the rain, or handle it with wet hands. Do not install your Base Unit near a sink, bathtub or shower.

Electrical Storms

Electrical storms can sometimes cause power surges harmful to electronic equipment. For your own safety, use caution when using electric appliances during storms.

Cleaning Your Telephone

Your telephone has a durable plastic casing that should retain its luster for many years. Clean it only with a soft cloth slightly dampened with water or a mild soap. Do not use excess water or cleaning solvents of any kind.

Remember that electrical appliances can cause serious injury if used when you are wet or standing in water. If your Base Unit should fall into water, **DO NOT RETRIEVE IT UNTIL YOU UNPLUG THE POWER CORD AND TELEPHONE LINE CORDS FROM THE WALL.** Then pull the unit out by the unplugged cords.

Limited Warranty

The Supplier warrants, to the original purchaser only, the material and workmanship of this product for ONE YEAR from the date of purchase. We will repair or replace, at our option, this product without charge should it fail due to a defect in material or workmanship within that time period.

This warranty does not apply to loss or damage that is the result of accident, misuse or negligence. All other warranties, expressed, implied or statutory, including warranties of fitness for a particular purpose, are limited to the time period listed and are otherwise excluded from this warranty if unauthorized repairs are attempted. Additionally, the Supplier shall not be liable for any incidental or consequential damage or commercial loss, nor for any other loss or damages.

The Supplier assumes no responsibility for products sent without prior return authorization.

For Warranty service **ONLY**, call 1-800-595-9511.

FCC and ACTA Regulations

This equipment complies with Parts 15 of the Federal Communications Commission (FCC) rules for the United States. It also complies with regulations RSS210 and CS-03 of Industry and Science Canada. Operation is subject to the following two conditions: (1) this device may not cause interference, and (2) this device must accept any interference, including interference that may cause undesired operation of the device.

A label is located on the underside of the Base Unit containing either the FCC registration number and Ringer Equivalence Number (REN). You must, upon request, provide this information to your local telephone company.

This equipment is compatible with inductively coupled hearing aids. Should you experience trouble with this telephone equipment, please contact:

For repair/warranty information. The telephone company may ask you to disconnect this equipment from the line network until the problem has been corrected.

FCC Part 15

Warning: Changes or modifications to this unit not expressly approved by the party responsible for compliance could void the user's authority to operate the equipment. The equipment has been tested and found to comply with part 15 of the FCC rules. These limits are designed to provide reasonable protection against harmful interference in a residential installation. This equipment generates, uses and can radiate radio frequency energy and, if not installed and used in accordance with the instructions, may cause harmful interference to radio communications. However, there is no guarantee that interference will not occur in a particular installation. If this equipment does cause harmful interference to radio or television reception, which can be determined by turning the equipment off and on, the user is encouraged to try and correct the interference by one or more of the following measures:

- Reorient or relocate the receiving antenna.
- Increase the separation between the equipment and receiver.
- Connect the equipment into an outlet or on a circuit different from that to which the receiver is connected.
- Consult the dealer or an experienced radio/TV technician for help.

FCC and ACTA Information

If this equipment was approved for connection to the telephone network prior to July 23, 2001, it complies with Part 68 of the Federal Communications Commission (FCC) rules. If the equipment was approved after that date, it complies with the Part 68 rules and with Technical Requirements for Connection of Equipment to the Telephone Network adopted by the Administrative Council for Terminal Attachments (ACTA). We are required to provide you with the following information.

1. Product identifier and REN information

The label on the back or bottom of this equipment contains, among other things, an identifier indicating product approval and the Ringer Equivalence Number (REN). This information must be provided to your local telephone company upon request. For equipment approved prior to July 23, 2001, the product identifier is preceded by the

FCC and ACTA Regulations

phrase “FCC Reg No.” and the REN is listed separately. For equipment approved after that date, the product identifier is preceded by “US” and a colon (:), and the REN is encoded in the product identifier without a decimal point as the sixth and seventh characters following the colon. For example, the product identifier US:AAAEQ03T123XYZ would indicate an REN of 0.3.

The REN is used to determine how many devices you may connect to your telephone line and still have them ring when you are called. In most, but not all areas, the sum of all RENs should be five (5.0) or less. You may want to contact your local telephone company for more information.

2. Connection and use with the nationwide telephone network

The plug and jack used to connect this equipment to the premises wiring and the telephone network must comply with the applicable Part 68 rules and technical requirements adopted by ACTA. A compliant telephone cord and modular plug is provided with this product. It is designed to be connected to a compatible modular jack that is also compliant. An RJ11 jack should normally be used for connecting to a single line and an RJ14 jack for two lines. See Installation Instructions in the user’s manual. This equipment may not be used with Coin Telephone Lines or with Party Lines. If you have specially wired alarm dialing equipment connected to your telephone line, ensure the connection of this equipment does not disable your alarm equipment. If you have questions about what will disable alarm equipment, consult your telephone company or a qualified installer.

3. Repair instructions

If this equipment is malfunctioning, it must be unplugged from the modular jack until the problem has been corrected. Repairs to this telephone equipment can only be made by the manufacturer or its authorized agents. For repair procedures, follow the instructions outlined under the Limited Warranty.

4. Rights of the telephone company

If this equipment is causing harm to the telephone network, the telephone company may temporarily discontinue your telephone service. The telephone company is required to notify you before interrupting service. If advance notice is not practical, you will be notified as soon as possible. You will be given the opportunity to correct the problem and the telephone company is required to inform you of your right to file a complaint with the FCC. Your telephone company may make changes in its facilities, equipment, operation, or procedures that could affect the proper functioning of this product. The telephone company is required to notify you if such changes are planned.

5. Hearing aid compatibility

If this product is equipped with a corded or cordless handset, it is hearing aid compatible.

6. Programming/testing of emergency numbers

If this product has memory dialing locations, you may choose to store police, fire department and emergency medical service telephone numbers in these locations. If you do, please keep three things in mind:

- a. We recommend that you also write the telephone number on the directory card, so that you can still dial the emergency number manually if the memory dialing feature doesn’t work.
- b. This feature is provided only as a convenience, and the manufacturer assumes no responsibility for customer reliance upon the memory feature.
- c. Testing the emergency telephone numbers you have stored is not recommended.

FCC and ACTA Regulations

However, if you do make a call to an emergency number:

- You must remain on the line and briefly explain the reason for the call before hanging up.
- Programming/testing of emergency numbers should be performed during off-peak hours, such as in the early morning or late evening, when the emergency services tend to be less busy.

Technical Specifications

FREQUENCY CONTROL

Crystal controlled
PLL synthesizer

TRANSMIT FREQUENCY

2401.056-2482.272 MHz

RECEIVE FREQUENCY

2401.056-2482.272 MHz

CHANNELS

95 Channels

NOMINAL EFFECTIVE RANGE

Maximum power allowed by FCC.
Actual operating range may vary
according to environmental conditions
at the time of use.

SIZE

Handset: 176mm x 51mm x 41mm

Base: 178mm x 128mm x 68mm

WEIGHT

Handset: 187 grams

Base: 385 grams

POWER REQUIREMENTS

Handset: 800 mAh Ni-Cd Battery
Pack or 1500 mAh
NiMH Battery Pack

Base: 7 VDC @ 900mA

MEMORY

Phonebook: 50 Memory locations,
upto 32 digits per
location.

CID: 50 Memory locations

**SPECIFICATIONS ARE TYPICAL AND
MAY CHANGE WITHOUT NOTICE.**

Table Of Contents

- 1. Important Safety Instructions**
- 3. Introduction**
 - 4. Parts Check List
 - 5. The Handset Layout
 - 6. The Base Unit Layout
- 7. Getting Started**
 - 7. Setup
 - 8. Installation of Battery Pack in Handset
 - 9. Spare Battery Charger/Power Backup Function
 - 10. Charging Of Handset Battery Pack
 - 11. Registration and Operation
- 13. Basic Operation**
 - 13. Handset and Base Indicators
 - 15. Soft Menu Functions
 - 15. RDL (Redial)
 - 15. MENU
 - 16. Calls Log (Caller ID)
 - 17. Handset Settings
 - 17. Ringer Volume
 - 17. Ringer Melody
 - 17. Low Batt Tone
 - 17. Range Tone
 - 17. Keypad Tone
 - 17. Contrast
 - 17. Language
 - 18. Range Extender
 - 18. Register
 - 19. MEM (Memory)
 - 20. To Store a Number/Name
 - 21. To Search For and Dial a Number/Name
 - 21. To Delete a Number/Name
 - 22. To Edit a Name or a Number
 - 23. Base Settings
 - 23. Select Base Ringer Melody
 - 23. Select Tone/Pulse
 - 24. Select Base Ringer Volume and OFF
- 25. Advanced Operations**
 - 25. Handset and Base Operation
 - 25. Making Calls
 - 25. Answering Calls
 - 25. Redial from Base Unit
 - 26. Mute Function
 - 26. Hold Function
 - 26. Flash Function
 - 27. Volume Control
 - 27. Page/Intercom
 - 28. Handsfree Speaker Operation
 - 29. Base Speaker Operation
 - 29. Line in Use Indication
 - 29. Low Battery Indication
 - 30. Conference Calling
 - 30. Transferring Calls
 - 31. Message Waiting
 - 31. Programming Voicemail Access
 - 31. VOICEMAIL Access Key
 - 32. Using the dedicated PLAY, KEEP and DELETE keys
 - 32. PLAY Access Key
 - 32. Reprogramming PLAY
 - 33. KEEP Access Key
 - 33. Reprogramming KEEP
 - 33. DELETE Access Key
 - 33. Reprogramming DELETE
 - 34. Name and Number Announce Caller ID
 - 34. Setup Name and Number Announce
 - 34. Record a New Name and Number Announcement
 - 35. Review, Play, Erase or Re-Record a Name and Number Announcement
 - 36. Custom Pay-Per-Use (PPU) Features
 - 37. Headset Operation
- 38. Additional Information**
 - 38. In Case Of Difficulty
 - 40. Maintenance
 - 41. Limited Warranty
 - 42. FCC and ACTA Regulations
 - 45. Technical Specifications



91-005574-040-000
ISSUE 0





OWNER'S MANUAL

**2.4GHz DIGITAL SPREAD SPECTRUM
CORDLESS TELEPHONE SYSTEM**

Model 2652