

d.2

2-Channel DJ Mixer with FireWire Option

OWNER'S MANUAL

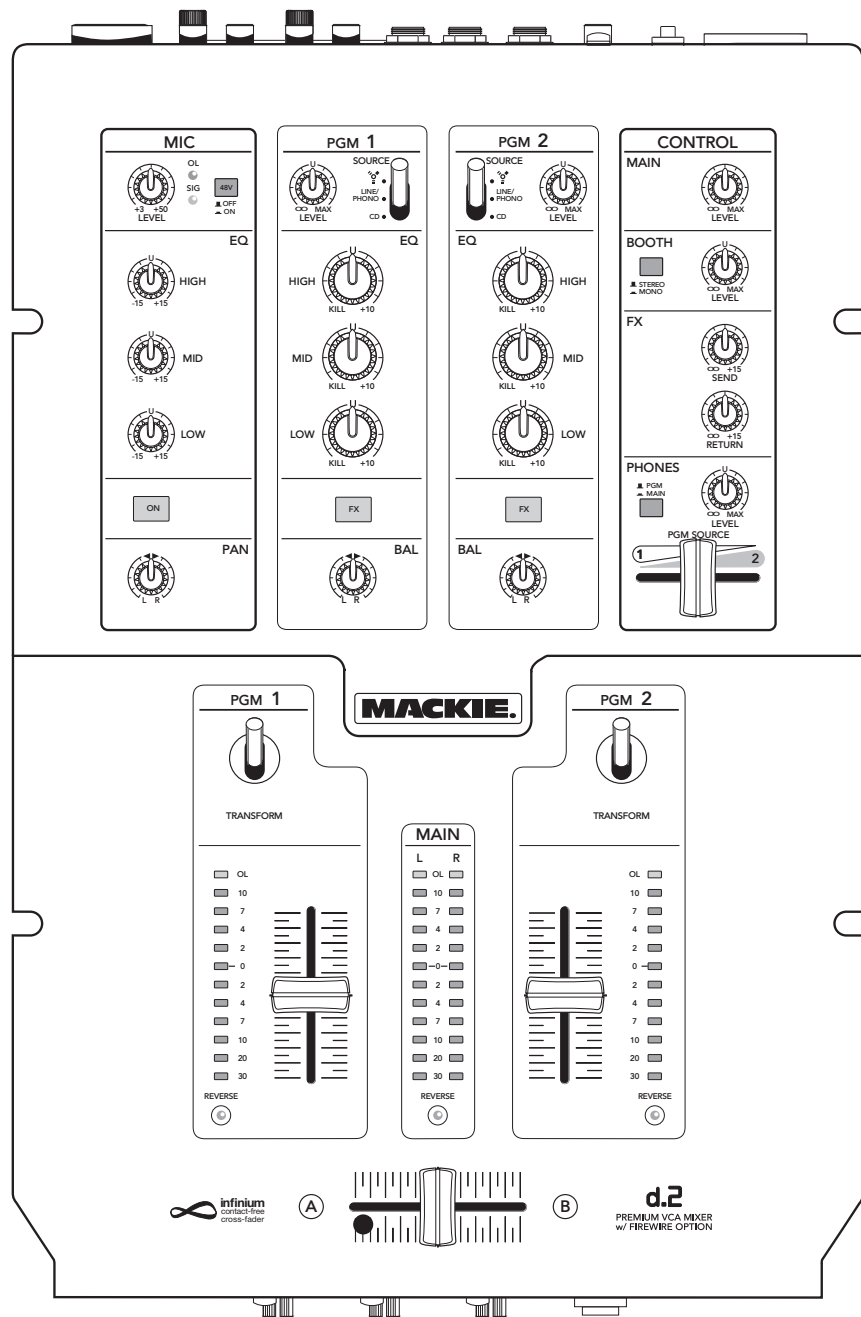

Important Safety Instructions

1. Read these instructions.
2. Keep these instructions.
3. Heed all warnings.
4. Follow all instructions.
5. Do not use this apparatus near water.
6. Clean only with dry cloth.
7. Do not block any ventilation openings. Install in accordance with the manufacturer's instructions.
8. Do not install near any heat sources such as radiators, heat registers, stoves, or other apparatus (including amplifiers) that produce heat.
9. Do not defeat the safety purpose of the polarized or grounding-type plug. A polarized plug has two blades with one wider than the other. A grounding-type plug has two blades and a third grounding prong. The wide blade or the third prong are provided for your safety. If the provided plug does not fit into your outlet, consult an electrician for replacement of the obsolete outlet.
10. Protect the power cord from being walked on or pinched particularly at plugs, convenience receptacles, and the point where they exit from the apparatus.
11. Only use attachments/accessories specified by the manufacturer.
12. Use only with a cart, stand, tripod, bracket, or table specified by the manufacturer, or sold with the apparatus. When a cart is used, use caution when moving the cart/apparatus combination to avoid injury from tip-over.
13. Unplug this apparatus during lightning storms or when unused for long periods of time.
14. Refer all servicing to qualified service personnel. Servicing is required when the apparatus has been damaged in any way, such as power-supply cord or plug is damaged, liquid has been spilled or objects have fallen into the apparatus, the apparatus has been exposed to rain or moisture, does not operate normally, or has been dropped.
15. This apparatus shall not be exposed to dripping or splashing, and no object filled with liquids, such as vases or beer glasses, shall be placed on the apparatus.
16. This apparatus has been designed with Class-I construction and must be connected to a mains socket outlet with a protective earthing connection (the third grounding prong).
17. This apparatus has been equipped with an all-pole, rocker-style AC mains power switch. This switch is located on the rear panel and should remain readily accessible to the user.
18. This apparatus does not exceed the Class A/Class B (whichever is applicable) limits for radio noise emissions from digital apparatus as set out in the radio interference regulations of the Canadian Department of Communications.

ATTENTION — *Le présent appareil numérique n'émet pas de bruits radioélectriques dépassant les limites applicables aux appareils numériques de class A/de class B (selon le cas) prescrites dans le règlement sur le brouillage radioélectrique édicté par les ministere des communications du Canada.*

19. Exposure to extremely high noise levels may cause permanent hearing loss. Individuals vary considerably in susceptibility to noise-induced hearing loss, but nearly everyone will lose some hearing if exposed to sufficiently intense noise for a period of time. The U.S. Government's Occupational Safety and Health Administration (OSHA) has specified the permissible noise level exposures shown in the following chart.

According to OSHA, any exposure in excess of these permissible limits could result in some hearing loss. To ensure against potentially dangerous exposure to high sound pressure levels, it is recommended that all persons exposed to equipment capable of producing high sound pressure levels use hearing protectors while the equipment is in operation. Ear plugs or protectors in the ear canals or over the ears must be worn when operating the equipment in order to prevent permanent hearing loss if exposure is in excess of the limits set forth here.

Duration Per Day In Hours	Sound Level dBA, Slow Response	Typical Example
8	90	Duo in small club
6	92	
4	95	Subway Train
3	97	
2	100	Very loud classical music
1.5	102	
1	105	Dave screaming at Steve about deadlines
0.5	110	
0.25 or less	115	Loudest parts at a rock concert

WARNING — To reduce the risk of fire or electric shock, do not expose this apparatus to rain or moisture.

PORTABLE CART WARNING



Carts and stands - The Component should be used only with a cart or stand that is recommended by the manufacturer. A Component and cart combination should be moved with care. Quick stops, excessive force, and uneven surfaces may cause the Component and cart combination to overturn.

CAUTION AVIS

RISK OF ELECTRIC SHOCK
DO NOT OPEN
RISQUE DE CHOC ELECTRIQUE
NE PAS OUVRIR

CAUTION: TO REDUCE THE RISK OF ELECTRIC SHOCK
DO NOT REMOVE COVER (OR BACK)
NO USER-SERVICEABLE PARTS INSIDE
REFER SERVICING TO QUALIFIED PERSONNEL
ATTENTION: POUR EVITER LES RISQUES DE CHOC
ELECTRIQUE, NE PAS ENLEVER LE COUVERCLE. AUCUN
ENTRETIEN DE PIECES INTERIEURES PAR L'USAGER. CONFIER
L'ENTRETIEN AU PERSONNEL QUALIFIE.
AVIS: POUR EVITER LES RISQUES D'INCENDIE OU
D'ELECTROCUTION, N'EXPOSEZ PAS CET ARTICLE
A LA PLUIE OU A L'HUMIDITE



The lightning flash with arrowhead symbol within an equilateral triangle is intended to alert the user to the presence of uninsulated "dangerous voltage" within the product's enclosure, that may be of sufficient magnitude to constitute a risk of electric shock to persons.
Le symbole éclair avec point de flèche à l'intérieur d'un triangle équilatéral est utilisé pour alerter l'utilisateur de la présence à l'intérieur du coffret de "voltage dangereux" non isolé d'ampleur suffisante pour constituer un risque d'électrocution.



The exclamation point within an equilateral triangle is intended to alert the user of the presence of important operating and maintenance (servicing) instructions in the literature accompanying the appliance.
Le point d'exclamation à l'intérieur d'un triangle équilatéral est employé pour alerter les utilisateurs de la présence d'instructions importantes pour le fonctionnement et l'entretien (service) dans le livret d'instruction accompagnant l'appareil.



Table of Contents

- Safety Instructions..... 2**
- Introduction..... 4**
- Getting Started 5**
 - READ THIS PAGE!!5**
- Hookup Diagrams 6**
- Rear Panel Features 10**
- Top Panel Features.....12**
 - Microphone Input Section 12**
 - Program Input Section..... 13**
 - Control Section.....14**
 - Program Output Section..... 15**
- Front Panel Features17**
- Appendix A: Service Information..... 18**
 - Warranty Service.....18**
 - Troubleshooting18**
 - Repair19**
- Appendix B: Connections20**
- Appendix C: Technical Info21**
 - Specifications 21**
 - Block Diagram23**
 - Gain Structure Diagram..... 24**
- Appendix D: Transform Switch
Rotation and Fader Replacement..... 25**
- Limited Warranty27**

Don't forget to visit our website at www.mackie.com for more information about this and other Mackie products.

Introduction

Thank you for choosing a Mackie d.2 Premium VCA Mixer for scratch and club DJs. It contains all your favorite features in a scratch mixer, along with significant extras that you will come to appreciate.

The d.2 is the first DJ mixer made by Mackie. We were able to apply our extensive knowledge of mixer design to the d.2, making it a truly professional product with the high-end performance you've come to expect from Mackie. Features like our "built like a tank" construction, premium analog circuitry, infinium™ contact-free crossfader, optional FireWire™ connectivity, and "Planet Earth" power supply add value to the d.2 not found in any other scratch mixer in its class.

FEATURES

- Mighty strong construction to withstand the rigors of DJ work.
- Integrated rack ears (Odyssey Battle Bridge™ compatible).
- Removable top panel provides access to the rotatable transform switches and to the user-replaceable faders.
- Premium VCA-based design offers extremely smooth fades and cross fades with very low distortion characteristics for warm, hearty sounding mixes.
- Mackie mic preamp with 3-band EQ for pro-quality vocals through the d.2.
- XLR main outputs with Mic/Line switch (mic position allows stage connections with no D.I. boxes required).
- RCA main outs with Live/Record switch (Record position delivers a pre-main out).
- Endless-life optical crossfader from the UK-based Infinium, with adjustable mechanical tension accessible from the top panel.
- Optional user-installable FireWire card receives four program channels from PC/Mac and sends a stereo L-R recording stream to PC/Mac.
- Program faders and Crossfader have variable contour curves and reverse switches.
- Ultra bright blue/white main meters plus individual program meters for cueing and beat matching.
- Separate mono/stereo switchable booth output on balanced TRS connectors.
- Stereo FX loop for outboard effects.
- "Planet Earth" power-supply operates on voltages between 100 and 240 VAC.
- Standard IEC power receptacle and power cord.

HOW TO USE THIS MANUAL

We know that many of you can't wait to get your new mixer hooked up, and you're probably not going to read the manual first (sigh!). So the first section after this Introduction is a Getting Started guide to help you get the mixer set up fast so you can start using it right away. Right after that are the ever popular hook-up diagrams that show you some typical setups.

Then, when you have time, read the Features Description section. This describes every knob, button, and connection point on the d.2, roughly following the signal flow through the mixer from top to bottom.

Throughout this section you'll find illustrations with each feature numbered. If you want to know more about a feature, simply locate it on the appropriate illustration, notice the number attached to it, and find that number in the nearby paragraphs.



This icon marks information that is critically important or unique to the d.2. For your own good, read them and remember them. They will be on the final test.



This icon leads you to in-depth explanations of features and practical tips. While not mandatory, they usually have some valuable nuggets of information.

Appendix B is a section on connectors: XLR connectors, TRS balanced connectors, TS unbalanced connectors, and RCA unbalanced connectors.

Appendix C shows the d.2 specifications, a block diagram, and a gain structure diagram.

Appendix D shows how to adjust the position of the transform switches, and how to replace the faders if you ever have to.

Please write your serial number here for future reference (i.e., insurance claims, tech support, return authorization, etc.)

Purchased at:

Date of purchase:

Getting Started

READ THIS PAGE!!

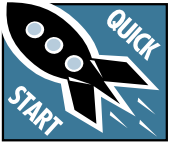

Even if you never reads manuals, please read and digest the safety instructions on page 2, and this page before you begin using the d.2 mixer.

Zero the Controls

1. Turn the rear panel POWER switch off.
2. Turn down the LEVEL controls for MIC, PGM 1 and PGM 2, and center all EQ, PAN, and BAL controls.
3. Set all push button switches to their “out” positions.
4. In the CONTROL section (right hand side), turn all the rotary knobs down, and the switches out.
5. Set the PROGRAM Faders fully down.
6. On the front panel, set the REVERSE switches out.
7. Center the CROSSFADER.

Connections

If you already know how you want to connect the d.2, go ahead and connect the inputs and outputs the way you want them. If you just want to get sound through the d.2 mixer, follow these steps:

1. Plug a signal source to the d.2. This could be a:
 - Microphone into the MIC input
 - Turntable into a PHONO input (push in the rear panel LINE/PHONO switch)
 - Line-level source such as a CD player into the PHONO input (push out the LINE/PHONO switch)
 - Line-level source such as a CD player into a CD input.
2. If you are using the PHONO input, make sure you set the LINE/PHONO switch correctly.
3. Connect cords from the d.2's MAIN OUTs (XLR or RCA connectors on the rear panel) to your powered speakers or amplifier.
4. Plug in the detachable linecord, connect it to a live AC outlet, and turn on the d.2's POWER switch.
5. If you have powered speakers, turn them on. Otherwise, hook up your speakers to the amp and turn it on. Adjust your powered speaker or amplifier level controls to however the manufacturer recommends. (This is usually all the way up.)

Set the Levels

To set the LEVEL controls, it's not even necessary to hear what you're doing at the outputs of the mixer. If you want to listen while you work, plug headphones into the PHONES jack on the front panel, then set the PHONES knob up a little.

1. Select the input using the SOURCE switch.
2. Play something into the selected input. Be sure that the volume of the input source is the same as it would be during normal use. If it isn't, you might have to readjust these levels during the middle of a set.
3. Center the TRANSFORM switch. There will be no output, but the PROGRAM METER will still work.
4. Adjust the channel's rotary LEVEL control so that the LEDs on the PROGRAM meter stay around “0” and +4, and never go higher than “+7.”
5. Apply some EQ if needed, (return to step 4 if you do, just to check the levels are still OK).
6. Repeat for the other channel (if you want to).

Set the MIC Levels

1. To level the microphone input, keep the ON button off, and talk or sing at your highest expected level.
2. Adjust the MIC LEVEL until the OL LED next to it only comes on occasionally.

Instant Mixing

1. To get sound out of the speakers, press the TRANSFORM switch up (the latched position), turn up the PROGRAM fader, and slowly rotate the MAIN control to a comfortable listening level.
2. Sing and play. You're a star! Bring in the other channel, play with the CROSSFADER, and generally have fun.

Other Nuggets of Wisdom

- Always turn down the MAIN, BOOTH, and PHONE knobs before making any connections.
- When you shut down your equipment, turn off the amplifiers first. When powering up, turn on the amplifiers last.
- Never listen to loud music for prolonged periods. Please see the Safety Instructions on page 2 for information on hearing protection.

Hookup Diagrams

(The following hookup diagrams show the d.2 with the optional FireWire card installed.)

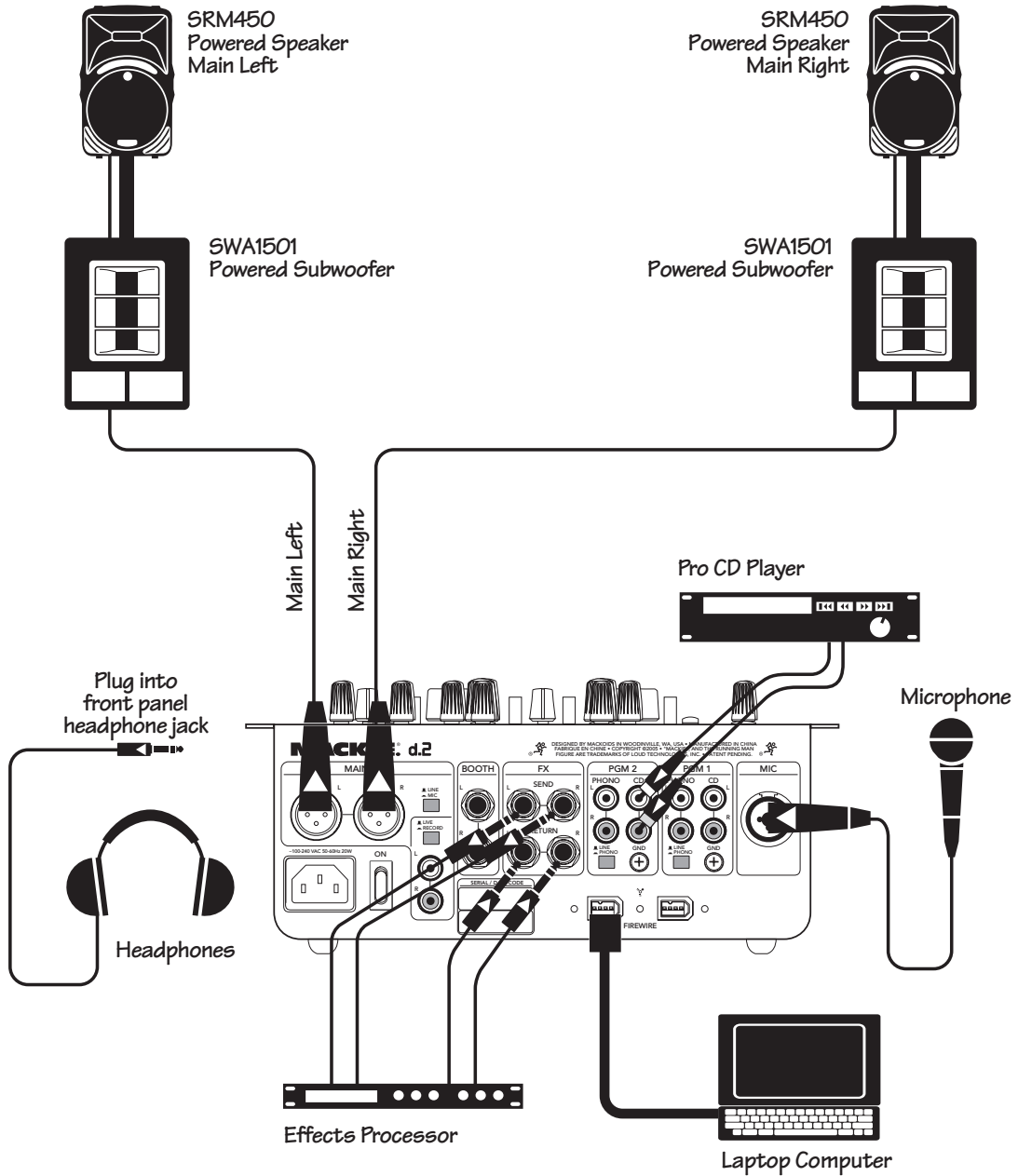

Mobile DJ System: Rental, Wedding, or Funeral

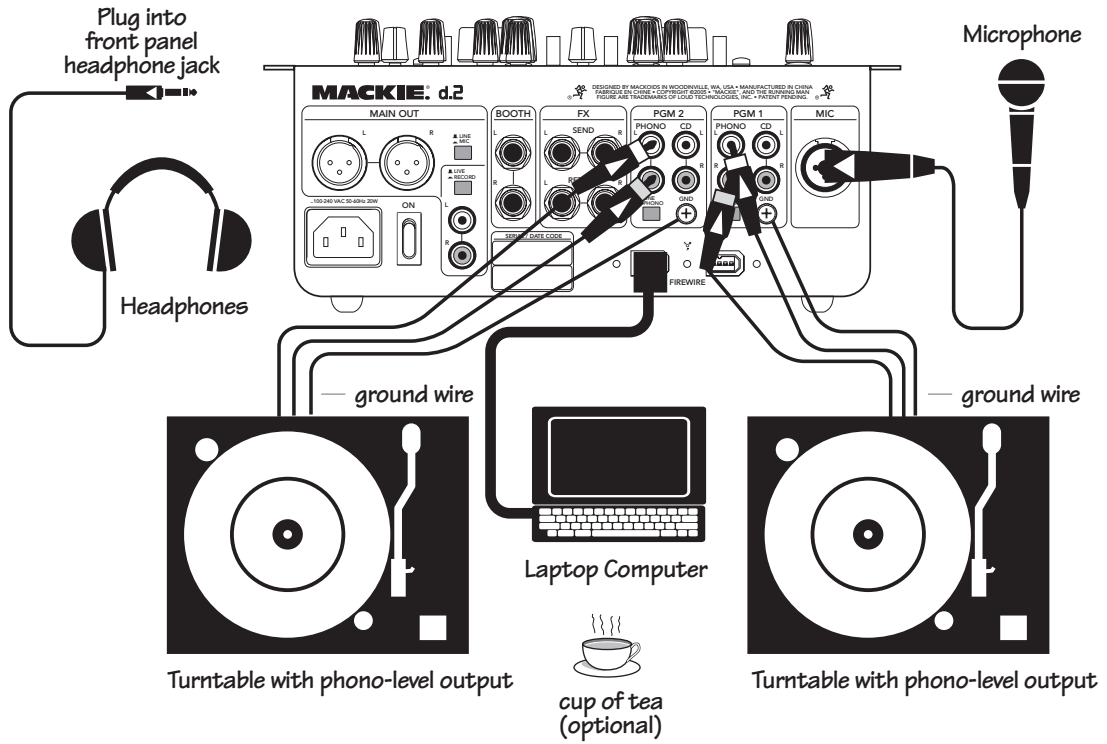

Radio Show Recording/Podcasting/having a good old time

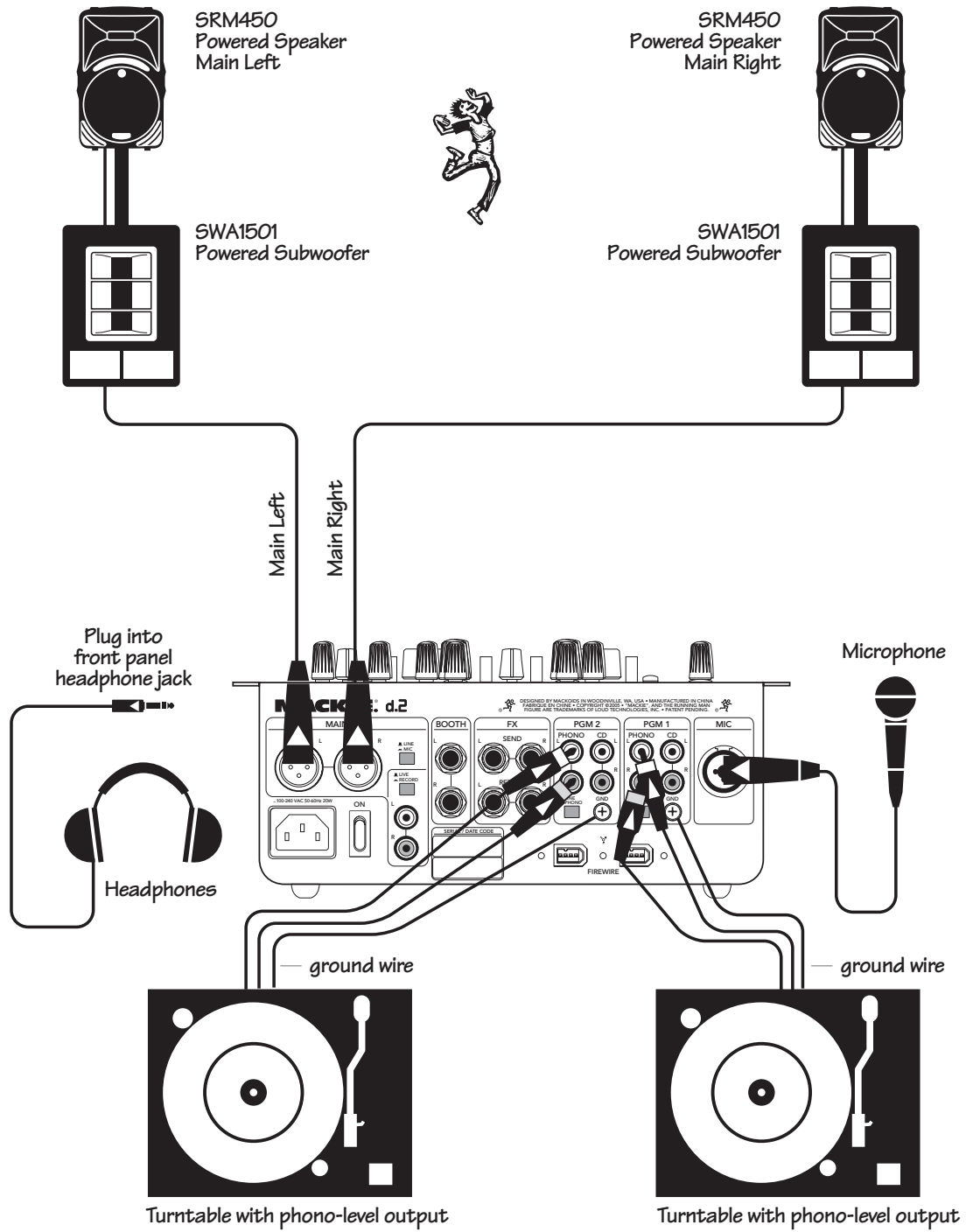

Two-Turntable Portable System

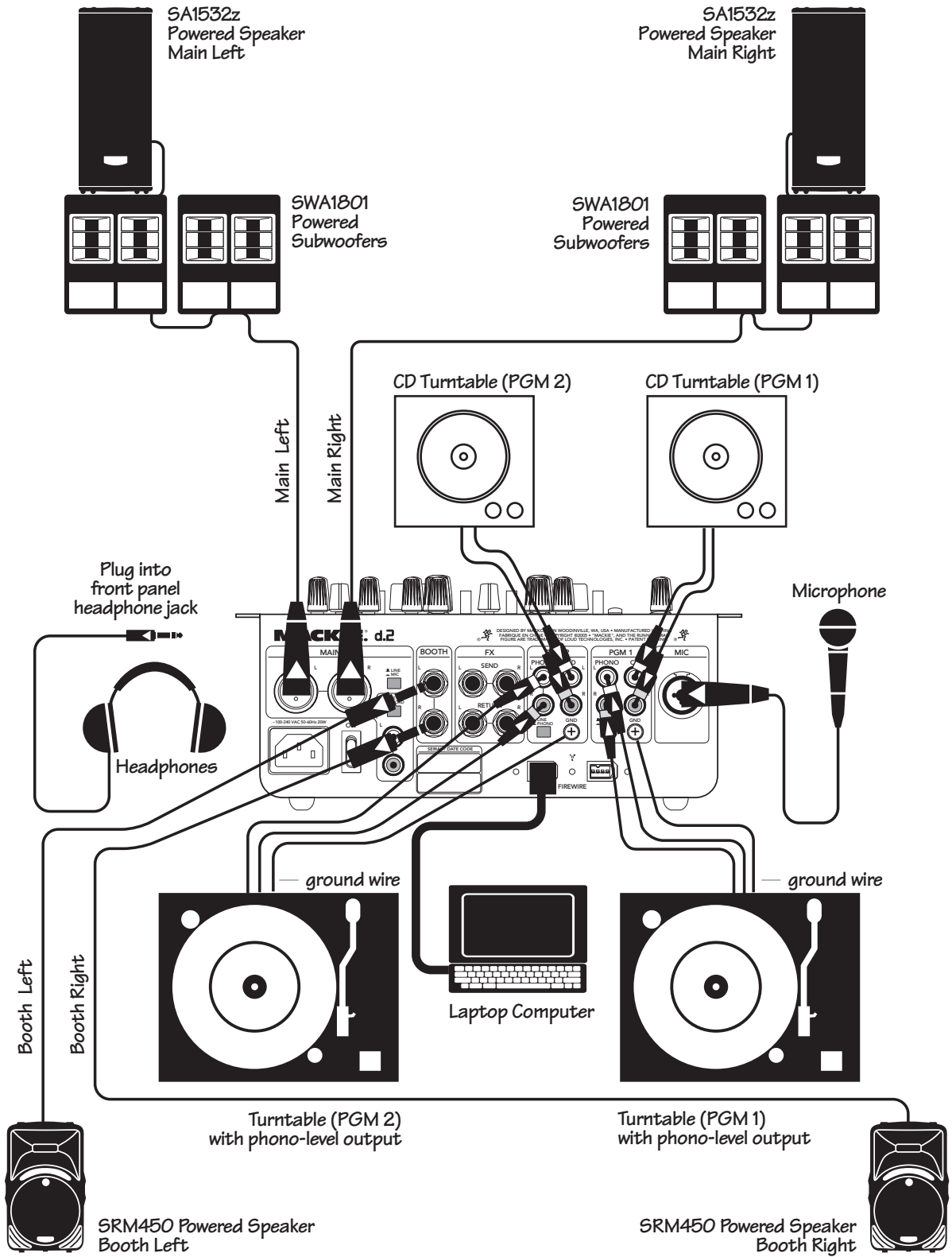

Club System

Rear Panel Features

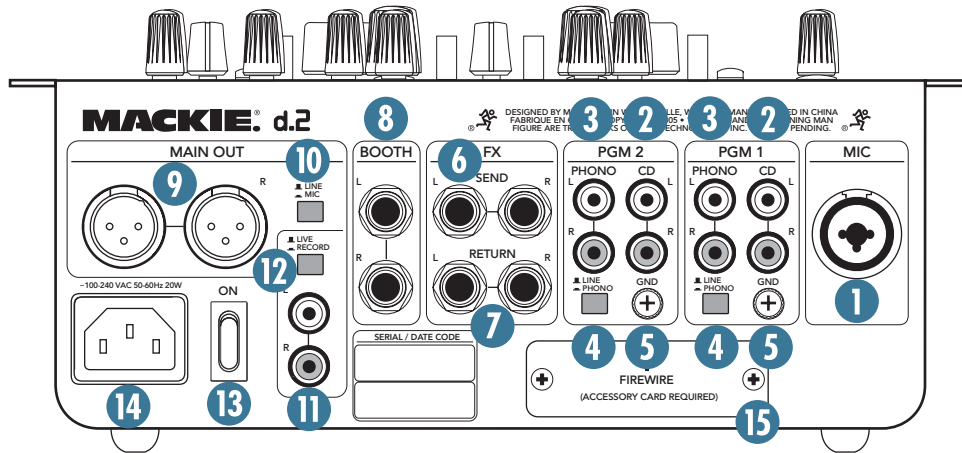

1. MIC Input

This is a Neutrik “combo” input connector that accepts either a balanced male XLR connector or a 1/4" balanced or unbalanced connector. Use an XLR connector for low-impedance microphones and a 1/4" connector for high-impedance microphones.

The MIC Input signal is routed through the MIC Input Section, MIC EQ, and then to the Main Mix bus.

2. CD Inputs

These RCA jacks accept a stereo line-level signal from a CD player or other line-level playback device (such as an MP3 player or DVD audio).

3. LINE/PHONO Inputs

These RCA jacks accept a stereo phono-level signal from a turntable (when the LINE/PHONO [4] switch is pushed in), or from a line-level playback device such as a CD player or MP3 player (when the LINE/PHONO switch is out). Check that your turntable has a phono-level output and a Moving Magnet cartridge.

4. LINE/PHONO Switch

If you connect a turntable with phono-level outputs to the LINE/PHONO inputs [3], push this switch in to select the phono-level input stage, which includes an RIAA preamp for proper re-equalization of the incoming phono signal.

If you are connecting a line-level playback device like a CD or MP3 player, leave this switch out to select the line-level preamp.



Do not press it in if you have a line-level signal connected.

5. GND Terminal

These terminals are provided to connect a ground wire from your turntable(s) to the d.2. Most turntables provide a ground wire to connect to the preamp for the purpose of eliminating “hum” in the audio signal. Simply turn the ground terminal on the d.2 counter-clockwise to loosen it, wrap the end of the ground wire clockwise around the terminal, and hand-tighten the ground terminal for a secure ground connection.

6. Stereo FX SEND

These 1/4" TRS jacks provide a balanced line-level output signal from the stereo FX Send bus. Use these to connect to the inputs of an external effects processor. You can also use an unbalanced 1/4" TS cable to make this connection.

7. Stereo FX RETURN

These 1/4" TRS jacks accept a balanced line-level signal from an external effects processor. They will also accept an unbalanced 1/4" TS connector.

If you are using a stereo effects processor, connect its left and right outputs to the corresponding left and right FX RETURN jacks. If it is a mono effects processor, connect its output signal to the left FX RETURN jack, and it will appear on both the left and right Main Mix bus.

8. BOOTH Outputs

These 1/4" TRS jacks provide a balanced line-level signal from the Main Mix bus, prior to the rotary MAIN LEVEL control [32]. Use these to connect to a pair of powered monitor speakers (or to the inputs of an amplifier powering the monitor speakers in the booth).

If you only have one monitor speaker, just use one of the BOOTH Outputs and push in the BOOTH STEREO/MONO switch [34] in the CONTROL section on the top panel.

9. XLR MAIN OUTS

These male XLR connectors provide a balanced mic- or line-level signal from the MAIN LEVEL control [32]. The LINE/MIC Switch [10] determines if it is a mic-level or line-level output. Connect these to the balanced inputs of the active speakers, or power amplifier(s) powering your main speakers.

If you are connecting the MAIN OUT of the d.2 to an unbalanced input, use the RCA Main Outs [11] instead.

Note: Balanced connections offer better immunity to external noise (specifically, hum and buzz) than unbalanced connections. Because of this, it is the preferred interconnect method, especially in cases where very long lengths of cable are being used. A long unbalanced cable carries with it more opportunity for noise to get into the system — having balanced cables means very little noise will enter the system. If you must use an unbalanced connection, keep the cable length to 10 feet or less (3 meters).

10. LINE/MIC Switch

If you are connecting the XLR MAIN OUTS [9] to line-level inputs like a power amplifier's inputs, leave this switch out, in the LINE position.

If you are using the d.2 as a submixer and connecting the XLR MAIN OUTS to the mic inputs of another mixer, push this switch in to the MIC position. This inserts a 30 dB pad to reduce the output signal to a mic level. This great feature allows you to connect the d.2 output directly to a snake without using direct boxes.

11. RCA Main Outs

These RCA connectors provide an unbalanced line-level signal from the MAIN OUT, either pre- or post-MAIN LEVEL control [32], depending on the setting of the LIVE/RECORD switch [12].

12. LIVE/RECORD Switch

When this switch is out (LIVE position), the RCA Main Outs provide the signal just after the MAIN LEVEL control [32], so it essentially provides the same signal as the XLR MAIN OUTS [9], except it is an unbalanced signal rather than a balanced one.

When this switch is pushed in (RECORD position), the RCA Main Outs provide the signal just prior to the

MAIN LEVEL control. This allows you to make a stereo recording that is not affected by Main Out level changes during a performance.

13. POWER Switch

When the POWER switch is turned ON, power is supplied to the d.2 and the cool blue EQ knobs light up.

14. Power Receptacle

This is a standard 3-prong IEC power connector. Connect the detachable linecord (included in the box with your d.2) to the power receptacle, and plug the other end of the linecord into an AC outlet.

The d.2 has a universal power supply that can accept any AC voltage from 100 VAC to 240 VAC. No need for voltage select switches. It will work virtually anywhere in the world. That's why we call it a "Planet-Earth" power supply! This also means that it is less susceptible to voltage sags or spikes, providing greater electromagnetic isolation and better protection against AC line noise.

15. FIREWIRE I/O Option

FireWire (a.k.a. IEEE 1394) is a high-speed serial I/O interface for connecting digital devices, with more than 30 times the bandwidth of USB 1.1. You can install the optional FireWire card here, to provide two FireWire connectors for transferring digital audio to and from your laptop computer or digital audio workstation (DAW) with absolute zero latency.



The FireWire interface provides a stereo main output to your computer. The signals are pre-MAIN LEVEL control [32], so they are independent of any adjustments made to the MAIN LEVEL control. This allows you to record your live performance directly to your laptop.

The FireWire interface also lets you use your computer to playback music for mixing on the d.2. It provides a return for four signals, which can be selected as the program source for PGM 1 and PGM 2. Assign two channels (or a stereo pair) to ASIO or CoreAudio outputs 1 and 2 for PGM 1, and two channels (or a stereo pair) to outputs 3 and 4 for PGM 2.

The FireWire card can easily be installed with the help of a small screwdriver. Ask your Mackie dealer about it. (The FireWire card, not the screwdriver.) Each card comes with installation instructions that I have to write before the boss gets back from his vacation in Gary, Indiana.

Top Panel Features

MIC Input Section

16. MIC LEVEL Control

This knob adjusts the gain of the mic preamp for any microphone plugged into the MIC input jack [1]. It ranges from +13 dB to +63 dB of gain. Adjust this knob so that the loudest speaking or shouting that you do into the microphone just barely lights the OL LED [18]. This gives you the best signal-to-noise ratio for the mic preamp.

17. MIC SIGNAL LED

This green LED is a signal present indicator. It lights when the microphone signal reaches -20 dBu, to give you a clue that the microphone is working.

18. MIC OL LED

This red LED lights when the microphone signal reaches 6 dB below clipping. It's okay if this LED blinks occasionally, but if it is blinking frequently or lit continuously, turn down the MIC LEVEL control [16] until it just blinks occasionally.

19. 48V Phantom Power Switch

If your microphone is a condenser design, it probably requires phantom power to operate. Push in this switch to supply 48 VDC to pins 2 and 3 of the XLR microphone connector.

Dynamic microphones, like Shure's SM57 and SM58, do not require phantom power. However, phantom power will not harm most dynamic microphones should you accidentally plug one in while the phantom power is turned on. Check your microphone's user's manual if you are not sure whether your microphone needs phantom power or not.

20. HIGH EQ

This knob gives your mic signal up to 15 dB of boost and cut at 12 kHz and above. At the center position the HIGH EQ has no effect on the signal.

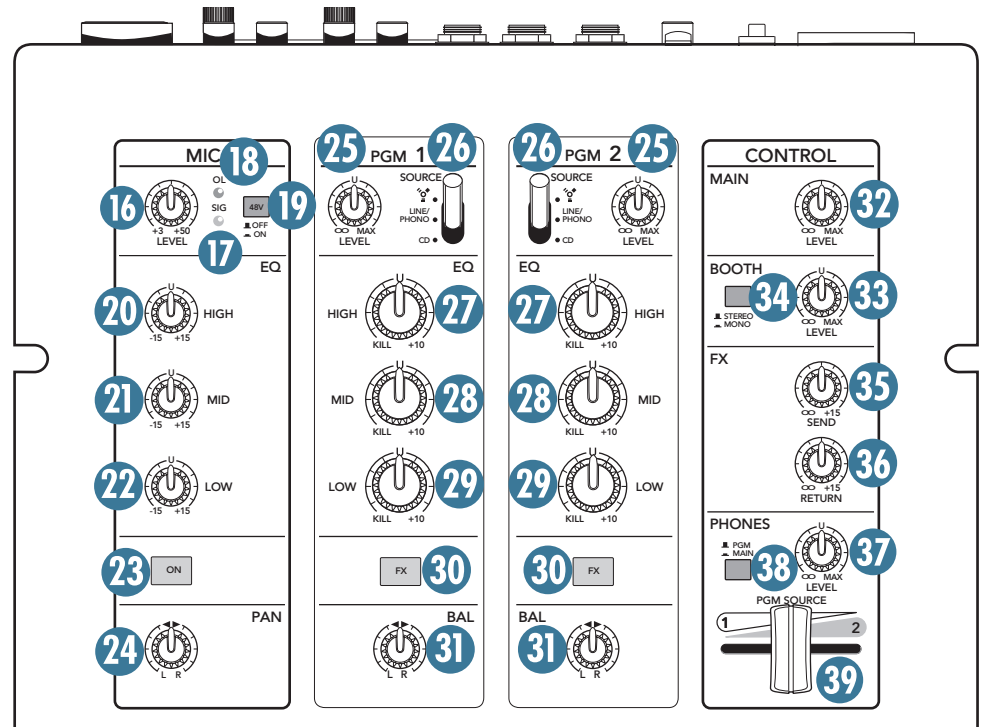

21. MID EQ

This knob gives you up to 15 dB of boost and cut at 2.5 kHz. At the center position the MID EQ has no effect on the signal.

22. LOW EQ

This knob gives you up to 15 dB of boost and cut at 80 Hz and below. At the center position the LOW EQ has no effect on the signal.

23. ON Switch

Press this switch in to send the microphone signal to the MAIN outputs, otherwise, your dulcet tones will not be heard, and people will say “huh?”

24. PAN

This knob adjusts the amount of microphone signal that is sent to the left versus the right main outputs. When the knob is turned hard left, the signal feeds only the left main out, and when the knob is turned hard right, it only feeds the right main out. When the knob is in the center, the microphone signal is sent equally to the left and right main mix. The fiendish design of the pan circuit allows “constant pan power,” where the average audio output level remains constant for all positions of the PAN control.

Program Input Section

25. LEVEL Control

This knob adjusts the gain of the PGM input signals selected by the position of the SOURCE Select switch [26]. This knob ranges from off to +13 dB of gain at maximum. Adjust this with your good eye on the PROGRAM METERS [42], so the level is typically bouncing between the 0 and +4 LEDs.

26. SOURCE Select Switch

This switch selects one of three possible input sources for the PGM channel:

FireWire: The signal coming in from the optional FireWire interface is selected as the source.

LINE/PHONO: The signal connected to the PHONO connectors on the rear panel is selected. This could be from a turntable or from a line-level playback device, depending on the setting of the LINE/PHONO switch [4].

CD: The signal connected to the CD connectors on the rear panel is selected.

You could have a signal coming in on all three inputs, and quickly change from one input source to another using this heavy duty switch.

27. HIGH EQ

This knob gives you up to 10 dB of boost at 4 kHz and above, and turns off the signal at 4 kHz and above when the knob is turned to the KILL position. At the center position, the HIGH EQ has no effect on the signal.

28. MID EQ

This knob gives you up to 10 dB of boost at 1 kHz, and turns off the signal at 1 kHz when the knob is turned to the KILL position. At the center position, the MID EQ has no effect on the signal.

29. LOW EQ

This knob gives you up to 10 dB of boost at 300 Hz and below, and turns off the signal at 300 Hz and below when the knob is turned to the KILL position. At the center position, the LOW EQ has no effect on the signal.

Note: When all three EQ knobs are turned to the KILL position, the signal is effectively muted and no signal passes through to the output.

30. FX Switch

Press this switch *in* to tap the PGM signal to the FX SEND outputs. This allows you to send the signal to an external effects processor, or even provide a direct feed for the PGM signal to another mixer. This switch will route the PGM signal to the FX send output connectors, interrupting the signal to the Main Outputs. If there is no effects processor connected to the FX send and returns, then the PGM signal is muted.

31. BAL

This knob works like the balance control on a home stereo. Turning the knob to the left turns down the right side, and turning the knob to the right turns down the left side. When the BAL control is in the center, the left and right sides are equally as loud (assuming the left and right inputs are equal loudness).

Control Section

32. MAIN LEVEL Control

This knob adjusts the main output level at the MAIN OUT XLRs [9] (and to the RCA Main Outs [11] when the LIVE/RECORD switch [12] is out). (Remember, when the LIVE RECORD switch is pushed in, the RCA Main Outs are not affected by the MAIN LEVEL control.)

33. BOOTH LEVEL Control

This knob adjusts the output level at the BOOTH outputs [8].

34. STEREO/MONO Switch

With this switch up, the BOOTH outputs [8] provide a stereo left and right output of the main mix. Push the switch in to combine the left and right signals to mono if you only have one booth monitor speaker.

35. FX SEND LEVEL Control

This knob controls the amount of signal being sent to FX SEND outputs [6]. Adjust this knob to provide an appropriate input signal level to your external effects processor (or whatever you have connected to the FX SENDs). It ranges from off to +13 dB at maximum.

Note: The FX SENDs are affected by the TRANSFORM switches [40], so if you mute a PGM channel with the TRANSFORM switch, the FX SEND for that PGM channel is muted as well.

36. FX RETURN LEVEL Control

This adjusts the signal level coming from your external effects processor via the FX RETURN jacks [7]. Use it to adjust the processed signal going to the main mix bus. It ranges from off to +13 dB at maximum.

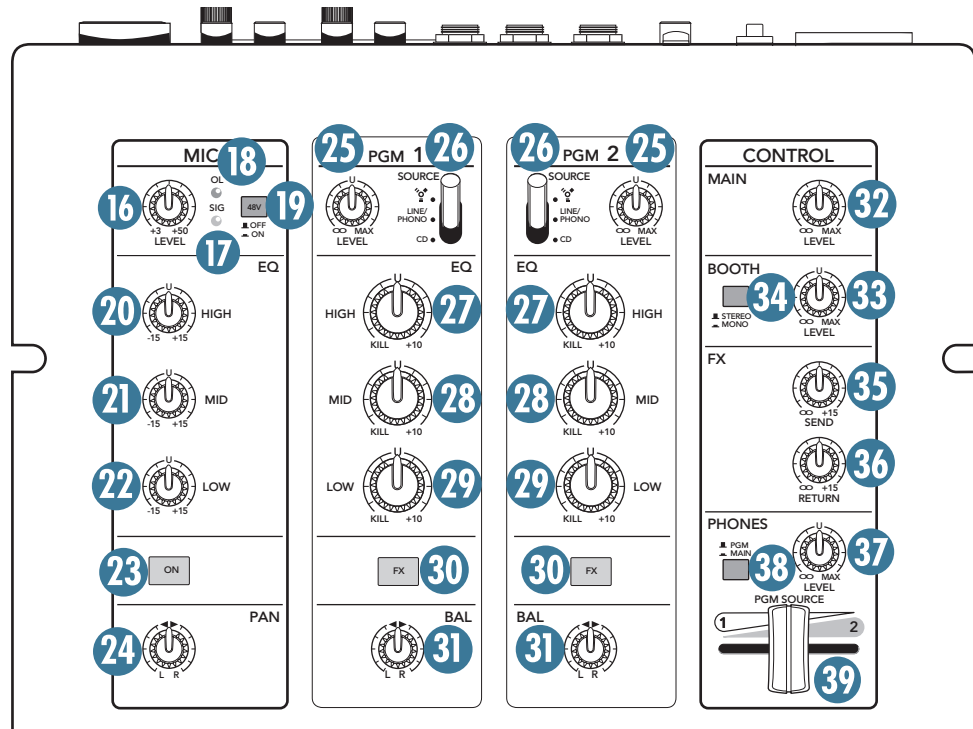

37. PHONES LEVEL Control

This controls the volume of the PHONES output from off to maximum gain.



Turn it to minimum before connecting and putting on headphones. Increase it slowly to a safe listening level. See page 17.

38. PGM/MAIN Switch

Use this switch to select the source for the headphones signal. When the switch is up (PGM position), the signal is tapped just after the BAL control [30] on the PGM channels. You can use the PGM SOURCE crossfader [39] to fade between PGM 1 and PGM 2.

When the switch is down (MAIN position), the signal is tapped from the Main Mix bus, just before the MAIN LEVEL control [32].

39. PGM SOURCE Cue Crossfader

When the PGM/MAIN switch [38] is up (in the PGM position), you can use this crossfader to listen to PGM 1 and PGM 2 in the headphones. When the crossfader is all the way to the left, PGM 1 is heard in the headphones. When the crossfader is all the way to the right, PGM 2 is heard in the headphones. When the knob is in the center, the headphones get an even mix of PGM 1 and 2.

Note: When the PGM/MAIN switch is down (MAIN position), this control has no effect on the PHONES output.

Program Output Section

40. TRANSFORM Switch

The transform switch has three positions: Latching, Center, and Momentary.

When the switch is Latched, this program's signal is on, and passes through to the outputs.

When the switch is in the center position, this program's signal is muted at the outputs and FX Sends.

The other position is a momentary version of the Latched position (in other words, it won't stay there when you let go of it), and allows the signal to pass as long as the switch is held down. Let go of the switch, and the signal is muted again. This lets you quickly use the transform switch for "stutter" effects.

If you prefer, you can rotate the Transform switch 45° or 90° so the switch moves diagonally or horizontally instead of vertically. See Appendix D on page 25 for more information.

Note: If this switch is in the center position, the program can still be heard and cued in the headphones if the PGM/MAIN switch [38] is up.

41. PROGRAM FADER

This controls the volume for the PGM signal being sent to the Main Mix bus. The characteristics of how the fader affects the audio signal are determined by the corresponding CONTOUR control [47] and the REVERSE switch [48].



These faders have a very light touch and are designed to last the lifetime of the d.2. No audio passes through these faders. Rather, they send a control voltage to a pair of VCAs (Voltage-Controlled Amplifiers) that determine the gain of the signal. This is a very good thing, by the way, as the audio will not be affected by any scratchy electrical contacts, and the design allows for customizing the fader action using the CONTOUR and REVERSE controls.

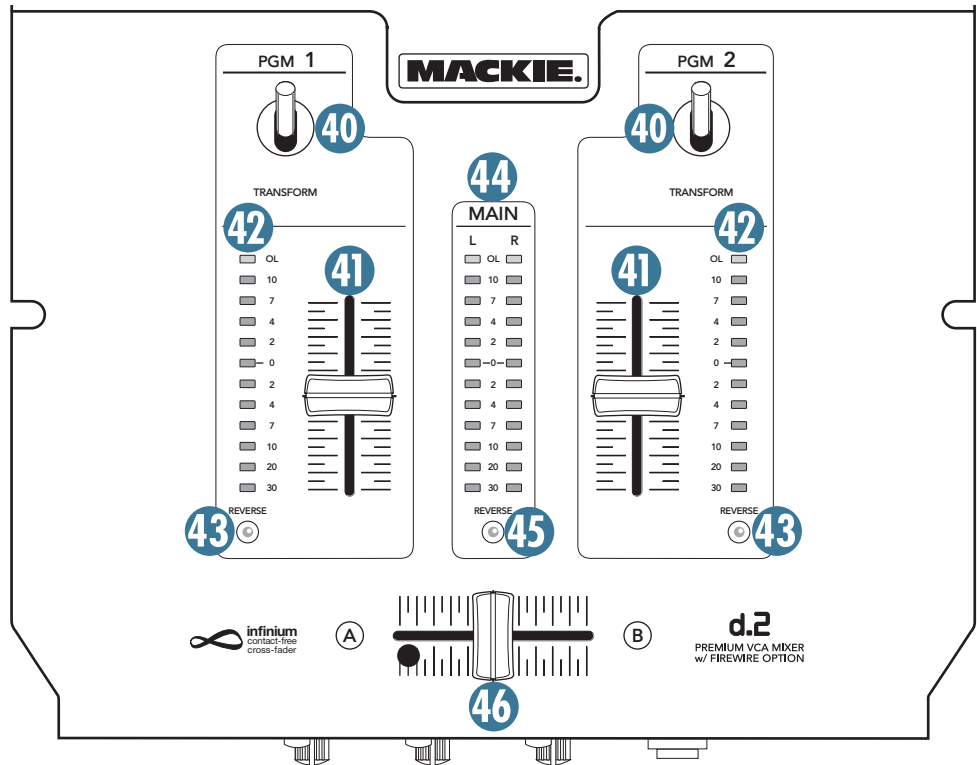

42. PGM LEVEL METERS

These meters have 12 LEDs, ranging from -30 to +20 (OL). They indicate the summed-mono signal strength of the PGM signals just before the BAL controls [31]. The meters are not affected by the PROGRAM faders [41].

Typically, you want to see these meters bouncing between the "0" and the "+4" LEDs. It is okay if the OL LED lights occasionally, but if it lights frequently or continuously, turn down the PGM LEVEL control [25] until the OL LED blinks occasionally or not at all.

43. REVERSE LED

These light when the front-panel REVERSE switches [48] have been activated for PGM 1 or PGM 2 faders. They show that the fader direction-of-action is reversed. (The meters are not reversed, just the faders.)

44. MAIN LEVEL METERS

These meters are similar to the PGM LEVEL METERS [42], but indicate the signal strength of the Main outputs before the MAIN LEVEL control. As with the other meters, you want to see the signals bouncing between the "0" and the "+4" LEDs. It is okay if the OL LEDs light occasionally, but if they light frequently or continuously, turn down the PROGRAM FADERS [41] until the OL LEDs blink occasionally, or not at all.

45. REVERSE LED

This LED lights when the REVERSE switch [48] has been activated for the Crossfader. For more details, see the discussion of the REVERSE switches [48] on the next page.

46. CROSSFADER

The crossfader is used to fade between the two PGM signals in the MAIN outputs. When the crossfader is all the way to the left, PGM 1 is heard in the MAIN outs. When the crossfader is all the way to the right, PGM 2 is heard. When the crossfader knob is in the center, the MAIN outs get an even mix of PGM 1 and 2.

The characteristics of how the crossfader affects the audio signal are determined by its corresponding CONTOUR control [47] and the REVERSE switch [48].



The crossfader is a high-quality infinium™ contact-free optical digital fader, designed to last the lifetime of the d.2 with no degradation in quality.

You can adjust the tension of the fader movement to your specific taste.

To adjust the crossfader tension:

1. Move the crossfader all the way to the left.
2. Remove the fader cap (knob) by grasping it firmly and pulling straight up.
3. Use a small slot-head screwdriver to turn the screw located through the hole on the left side of the crossfader slot.

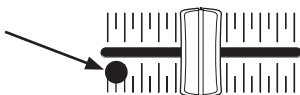

Rotate the screw clockwise to tighten the tension, and rotate the screw counter-clockwise to loosen the tension. You might need a flashlight to make sure you are lined up on the screw.

4. Replace the fader cap, and you're all done.

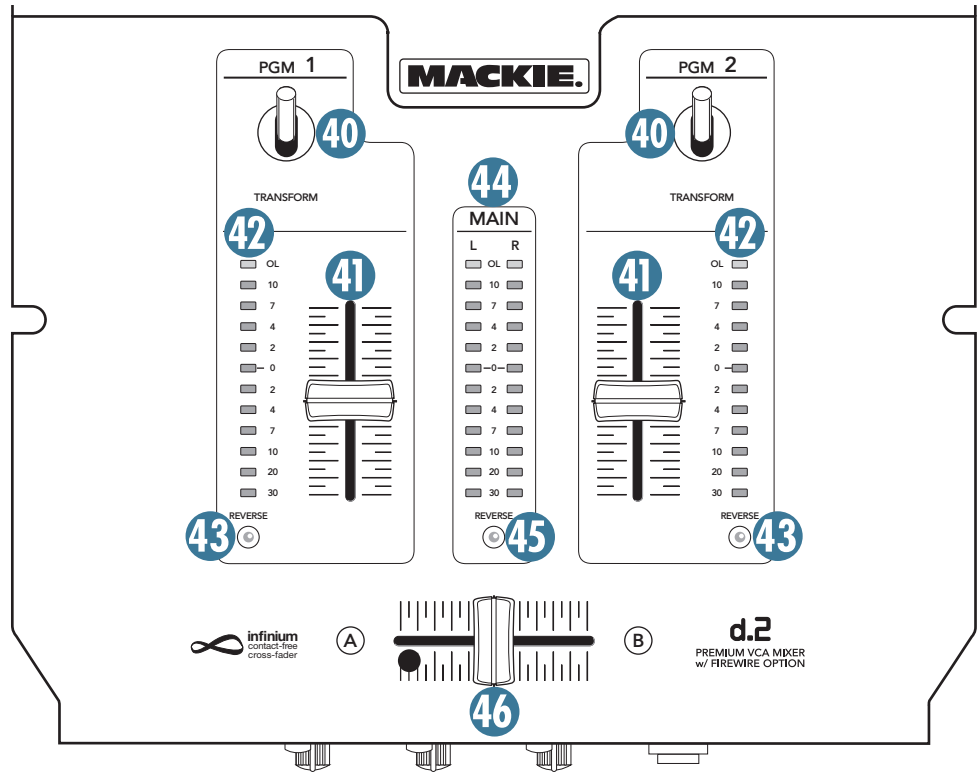

Front Panel Features

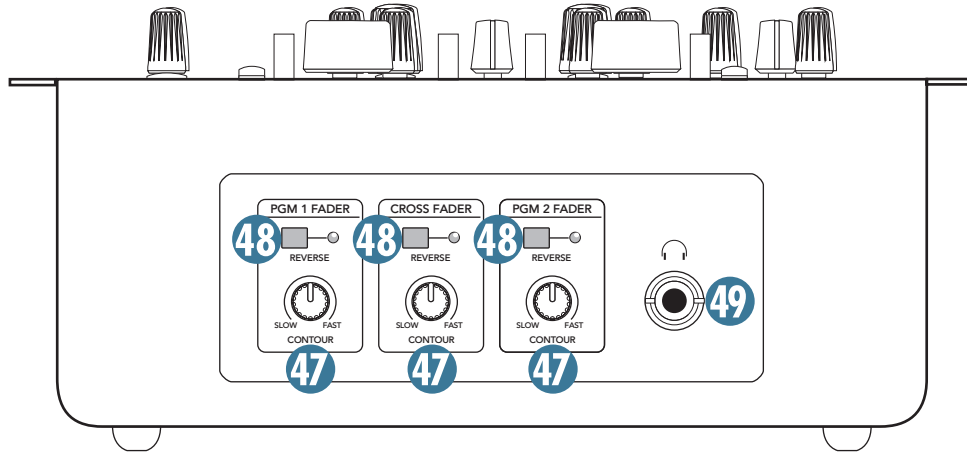

47. CONTOUR Controls

Use the CONTOUR controls to adjust how fast or slow each fader responds to movement. In the SLOW position, the faders respond in a linear fashion, increasing from minimum to maximum at the same rate. In the FAST position, the faders respond logarithmically, increasing from minimum to maximum very quickly, and then changing very little for the remainder of the fader travel. Adjust the CONTOUR controls between the two extremes to get the fader response that works best for your application.

The CONTOUR control for the crossfader works in a similar fashion, crossfading linearly with the CONTOUR control in the SLOW position, and crossfading very quickly with the CONTOUR control in the FAST position. In fact, in the FAST position, the crossfading occurs within the first 2 mm of fader travel. This is great for “crabbing” techniques.

48. REVERSE Switches

Normally (with these switches out) when you move the PGM 1 or PGM 2 faders up, the volume will increase. When you move the crossfader left to right, PGM 1 will fade into PGM 2.

These switches let you reverse the direction of the action of the program faders and the crossfader:

With the PGM 1 or PGM 2 REVERSE switches on, when you move the PGM 1 or PGM 2 faders up, the volume will now decrease.

With the Crossfader REVERSE switch on, when you move the crossfader left to right, PGM 2 will fade into PGM 1. (This is sometimes called a hamster switch.)

Note: These switches and the CONTOUR controls do not affect the meters, just the faders.

49. Headphones Jack

This is where you plug in your stereo headphones. It is a 1/4" TRS stereo jack.

If you have the PGM/MAIN switch [38] up, you can listen to the PGM 1 or PGM 2 signals, or a mix of both, determined by setting the PGM SOURCE Slider [39]. The signals are taken just after the BAL controls [31], but before the PROGRAM Faders [41].

If you have the PGM/MAIN switch [38] down, you can listen to the MAIN MIX signals, taken just before the MAIN LEVEL control [32].

The headphone volume is controlled by the PHONES LEVEL control [37], and the position of the PGM SOURCE Crossfader [39] if you are listening to PGM 1 or PGM 2.



WARNING: The headphone amp is designed to drive any standard headphones to a very loud level. We're not kidding! It can cause permanent hearing damage. Even intermediate levels may be painfully loud with some headphones. BE CAREFUL!



Always start with the PHONES LEVEL control [37] turned all the way down before connecting headphones to the PHONES jack, or making any connections. Keep it down until you've put on the headphones. Set the PGM SOURCE Slider [39] if you are listening to PGM 1 or PGM 2, then turn up the PHONES LEVEL control [37] slowly. Why? Always remember: “Engineers who fry their ears, find themselves with short careers.”

Appendix A: Service Information

Warranty Service

Details concerning Warranty Service are spelled out in the Warranty section on page 27.

If you think your d.2 has a problem, please do everything you can to confirm it before calling for service. Doing so might save you from the deprivation of your mixer and the associated suffering.

These may sound obvious to you, but here are some things you can check. Read on:

Troubleshooting

No Power

- Our favorite question: Is it plugged in?
- Make sure the power cord is securely seated in the IEC socket [14] and plugged all the way into the AC outlet.
- Make sure the AC outlet is live (check with a tester or lamp).
- Make sure the rear panel POWER switch [13] is in the ON position (up).
- Are the EQ controls on the front panel illuminated? If not, make sure the AC outlet is live.
- Are all the lights out in your town? If so, contact your local power company to get power restored.
- If no LEDs are illuminated, and you are certain that the AC outlet is live, it will be necessary to have your d.2 serviced. *There are no user serviceable parts inside.* Refer to “Repair” on the next page to find out how to proceed.

Bad Channel

- Check the TRANSFORM switch [40] is not in the center position.
- Is a fader or crossfader REVERSE LED [48] on?
- Check the channel’s PROGRAM fader [41] is not fully down.
- Are that channel’s EQ controls all turned down?
- Is the signal source turned up? Make sure the signal level from the selected input source is high enough to light up some of the PROGRAM METER LEDs [42].
- Is the correct input chosen with the SOURCE SELECT switch [26], and its PGM LEVEL [25] turned up far enough?

- If the FX button [30] is pressed on that channel, make sure your effects processor is connected correctly and is working.
- Try the same source signal in the other channel, set up exactly like the suspect channel.

Bad Output

- Is the associated level control (if any) turned up?
- If it’s one of the MAIN OUTPUTS, try unplugging the others. For example, if it’s the XLR LEFT MAIN OUT, unplug the RCA LEFT OUT. If the problem goes away, it’s not the mixer.
- If a left output is presumed dead, switch the left and right cords at the mixer end. If the problem stays on the left side, it’s not the mixer.

Bad Sound

- Is the input connector plugged completely into the jack?
- Is it loud and distorted? Make sure the input LEVEL control [25] is set correctly. Reduce the signal level on the input source if possible.
- If possible, listen to the signal with headphones plugged into the input source device. If it sounds bad there, it’s not the d.2 causing the problem.
- If you are using a turntable with a phono-level output, and the sound is low and distorted, check that the LINE/PHONO switch [4] is set to PHONO. Note that the phono section requires your cartridge to be a Moving Magnet type. It may be too low to amplify the low levels of a Moving Coil type.

Noise/Hum

- Turn down the FX RETURN knob [36]. If the noise disappears, it’s coming from whatever is plugged into the FX RETURNS [7].
- Check that your turntable’s audio ground wire is connected to the GND terminals [5].
- Turn down each channel, one by one. If the noise disappears, it’s coming from whatever is plugged into that channel. Check your whatever.
- Check the signal cables between the input sources and the d.2. Disconnect them one by one. When the noise goes away, you’ll know which input source is causing the problem.
- Sometimes it helps to plug all the audio equipment into the same AC circuit so they share a common ground.

Repair

Service for Mackie products is available at a factory-authorized service center. Service for Mackie products living outside the United States can be obtained through local dealers or distributors.

If your d.2 needs service, follow these instructions:

1. Review the preceding troubleshooting suggestions. Please.
2. Call Tech Support at 1-800-898-3211, 7 am to 5 pm PST, to explain the problem and request a Service Request Number. Have your d.2's serial number ready. ***You must have an Service Request Number before you can obtain warranty service.***
3. Keep this owner's manual and the detachable line-cord. We don't need them to repair the mixer.
4. Pack the mixer in its original package, including endcaps and box. This is ***VERY IMPORTANT***. *Mackie is not responsible for any damage that occurs due to non-factory packaging.*
5. Include a legible note stating your name, shipping address (no P.O. boxes), daytime phone number, Service Request Number, and a detailed description of the problem, including how we can duplicate it.
6. Write the Service Request Number in **BIG PRINT** on top of the box. Units sent without the SR number will be refused.
7. Tech Support will tell you where to ship the d.2 for repair. We suggest insurance for all forms of cartage.
8. You will need to contact the authorized service center for their latest turn-around times. The d.2 must be packaged in its original packing box, and must have the Service Request Number on the box. Once it's repaired, the authorized service center will ship it back by ground shipping, pre-paid (if it was a warranty repair).

Note: Under the terms of the warranty, you must ship or drop-off the unit to an authorized service center. The return ground shipment is covered for those units deemed by us to be under warranty.

Note: You must have a sales receipt from an authorized Mackie dealer for your unit to be considered for warranty repair.

Appendix B: Connections

XLR Connectors

The d.2 MIC combo input accepts 3-pin male XLR connectors; the MAIN OUTs accept 3-pin female XLR connectors. These are wired as follows, according to standards specified by the AES (Audio Engineering Society).

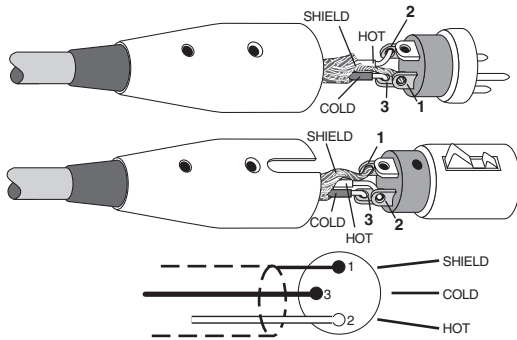

XLR Balanced Wiring:

- Pin 1 = Shield
- Pin 2 = Hot (+)
- Pin 3 = Cold (-)

1/4" TRS Phone Plugs and Jacks

“TRS” stands for Tip-Ring-Sleeve, the three connection points available on a stereo 1/4" or balanced phone jack or plug. TRS jacks and plugs are used for balanced signals and stereo headphones:

Balanced Mono

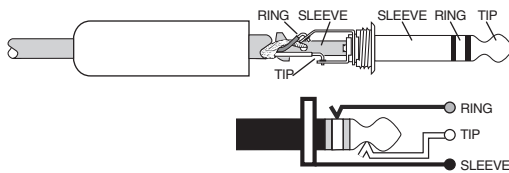

1/4" TRS Balanced Mono Wiring:

- Sleeve = Shield
- Tip = Hot (+)
- Ring = Cold (-)

Stereo Headphones

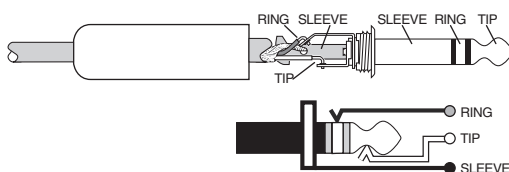

1/4" TRS Stereo Unbalanced Wiring:

- Sleeve = Shield
- Tip = Left
- Ring = Right

1/4" TS Phone Plugs and Jacks

“TS” stands for Tip-Sleeve, the two connection points available on a mono 1/4" phone jack or plug. They are used for unbalanced signals.

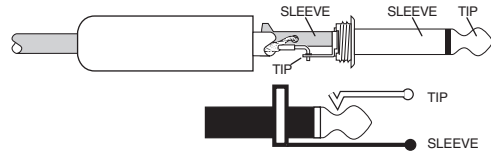

1/4" TS Unbalanced Wiring:

- Sleeve = Shield
- Tip = Hot (+)

RCA Plugs and Jacks

RCA-type plugs (also known as phono plugs) and jacks are often used in home stereo and video equipment and in many other applications. They are unbalanced and electrically equivalent to a 1/4" TS phone plug.

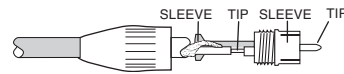

RCA Unbalanced Wiring:

- Sleeve = Shield
- Tip = Hot (+)

Appendix C: Technical Info

Specifications

Frequency Response :

Mic Input to any Output: (Trim at 0 dB):	+0, -1 dB 20 Hz to 20 kHz
Line/CD Input to any Output:	±0.5 dB 20 Hz to 20 kHz
Phono input to any Output:	±1 dB of RIAA EQ curve

Distortion (THD and IMD):

THD @ Main Output, 20 Hz to 20 kHz	
Mic Input @ 30 dB Gain:	Less than 0.0075%
Line/CD Input @ 0 dB Gain:	Less than 0.0075%
Phono Input:	Less than 0.01%
THD @ Phones Output, 20 Hz to 20 kHz	
Line Input @ 0 dB Gain:	Less than 0.03%
SMPTE IMD @ +4 dBu Output:	
Mic Input @ 30 dB Gain:	Less than 0.008%
Line/CD Input @ 0 dB Gain:	Less than 0.008%

Common Mode Rejection Ratio (CMRR):

Mic Input (Gain = maximum)	Greater than 60 dB @ 1 kHz
----------------------------	-------------------------------

Crosstalk:

Adjacent Inputs or Input to Main Output:	Less than -85 dB @ 1 kHz
--	-----------------------------

Noise Characteristics:

Equivalent Input Noise (E.I.N.) (20 Hz to 20 kHz):	
Mic Input (150 Ω source impedance):	Less than -123 dBu
Phono Input (500 Ω/500 mH source impedance):	Less than 0.3 μV
CD/Line Input (150 Ω source impedance):	Less than -110 dBu
Dynamic Range (Main Out):	Greater than 100 dB

Maximum Input Levels (rated at 1% THD):

Mic Input (Gain @ minimum):	+9 dBu
CD and Line Inputs (PGM Gain = 0 dB):	+22 dBu
FX Input:	+22 dBu
Phono Input:	78 mV @ 1kHz

Input/Output Characteristics:

Input Gain Control Range:	
Mic Input:	+13 dB to +63 dB
PGM Input:	OFF to +13 dB
FX Return:	OFF to +13 dB

Input Impedance:

Mic Input:	2.4 kΩ balanced
CD/ Line Input:	20 kΩ balanced
FX Return:	20 kΩ balanced
Phono Input:	47.5 kΩ shunted with 200 pF

Maximum Output Levels:

XLR Main Output:	+22 dBu
RCA Main Output:	+22 dBu
Booth Output:	+22 dBu
FX Send:	+22 dBu
Phones:	15 volts rms into 8Ω (28 watts)

Output Impedance:

Main XLR/RCA Output:	150 Ω
Booth Output:	150 Ω
FX Send:	150 Ω
Phones:	25 Ω

Equalization

Mic Channel	
Low:	±15 dB @ 80 Hz
Mid:	±15 dB @ 2.5 kHz
High:	±15 dB @ 12 kHz
PGM Channel	
Low:	+10/-inf dB @ 300 Hz
Mid:	+10/-inf dB @ 1 kHz
High:	+10/-inf dB @ 4 kHz

VU Meters

12-segment pre-fader PGM meters	
12-segment pre-fader Main Mix meters	
OL (+20), +10, +7, +4, +2, 0, -2, -4, -7, -10, -20, -30	
0 LED = +4 dBu	
Mic Input Signal Present LED (Sensitivity):	-20 dBu

continued

AC Power Requirements:

Power Consumption:	20 watts
Universal AC Power Supply:	100 VAC – 240 VAC, 50-60 Hz

Physical Dimensions and Weight:

Height:	15.49"/393.4 mm (including knobs and connectors)
Width:	10"/254 mm
Depth:	4.62"/117.3 mm (including knobs and connectors)
Weight:	11 lb/5 kg (with FireWire card)

The d.2 mounting slots are compatible with the Odyssey Battle Bridge. This consists of two L brackets which bolt to the d.2 and allow you to fit it securely between two turntable cases. See www.odysseygear.com for more details.

Options

d.2 FireWire Interface Card

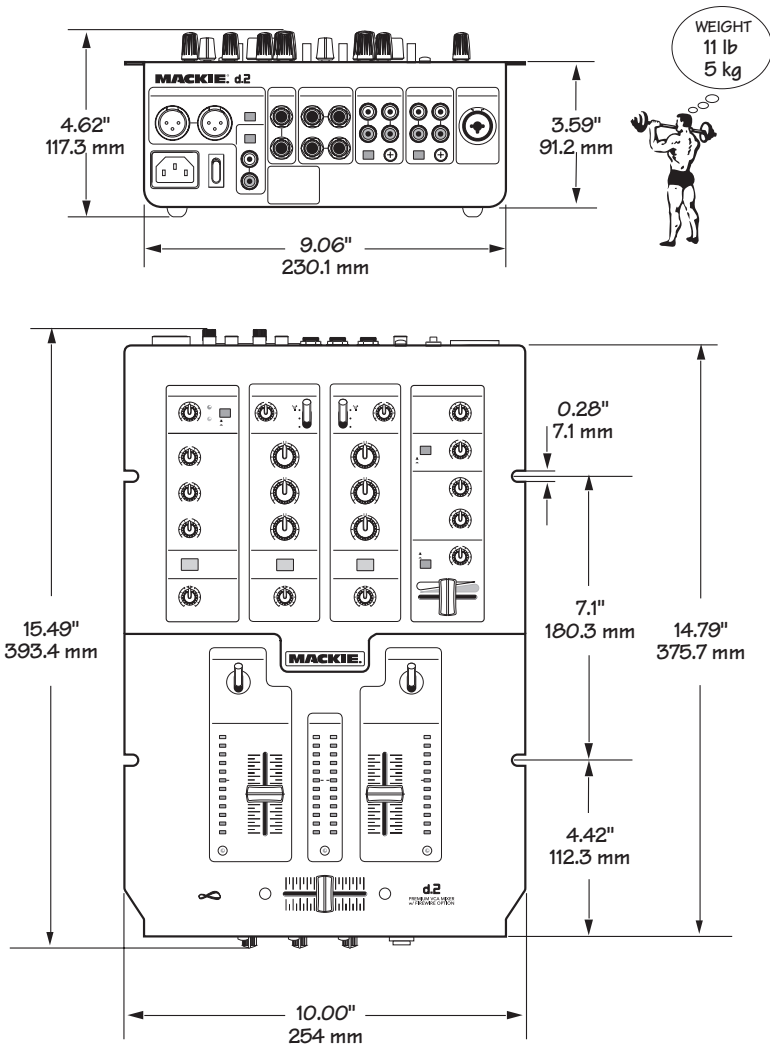

LOUD Technologies Inc. is always striving to improve our products by incorporating new and improved materials, components, and manufacturing methods. Therefore, we reserve the right to change these specifications at any time without notice.

"Mackie," and the "Running Man" are registered trademarks of LOUD Technologies Inc. All other brand names mentioned are trademarks or registered trademarks of their respective holders, and are hereby acknowledged.

©2005 LOUD Technologies Inc. All Rights Reserved.

Block Diagram

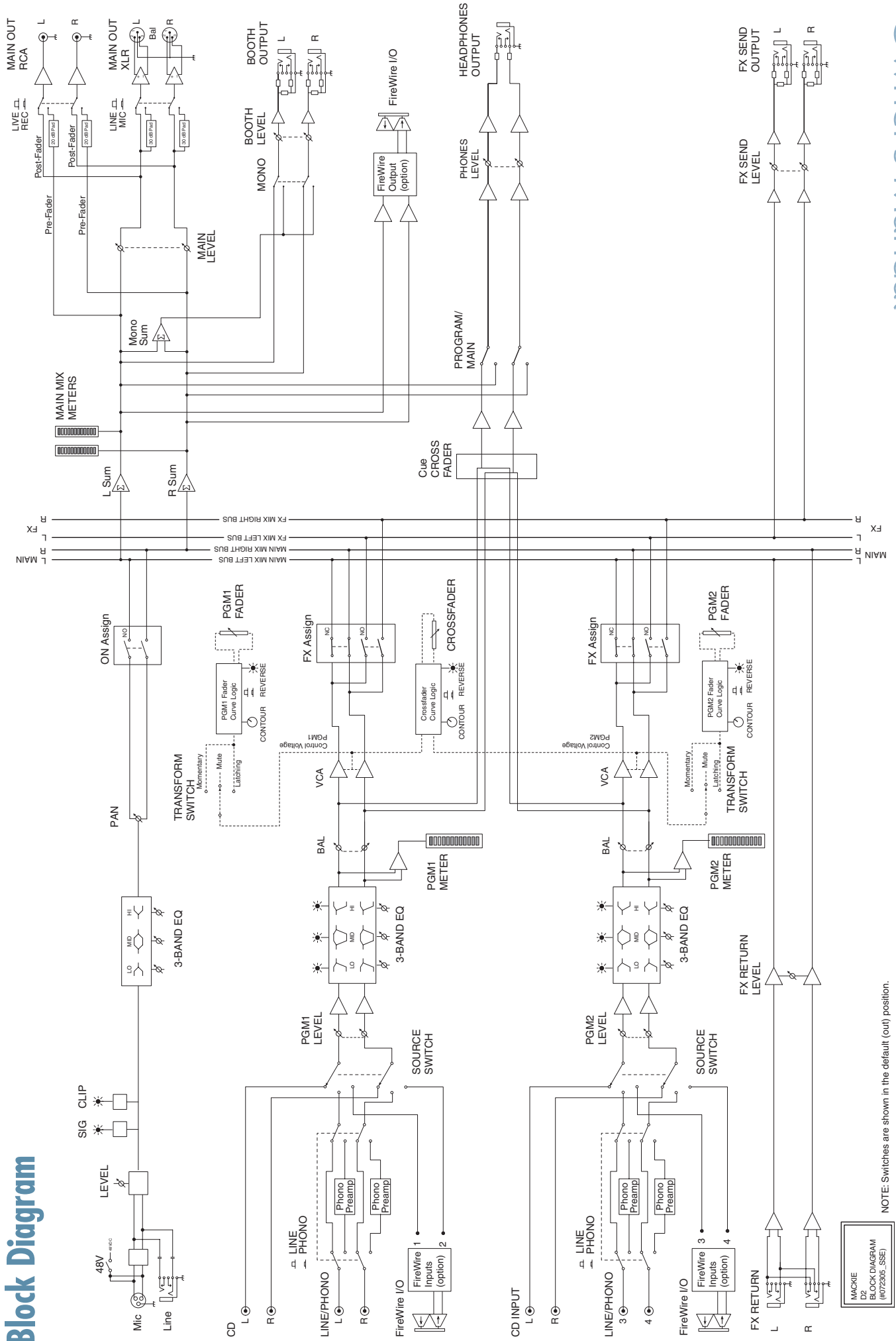

MACKIE
D2
BLOCK DIAGRAM
(#072905_SSE)

NOTE: Switches are shown in the default (out) position.

Gain Structure Diagram

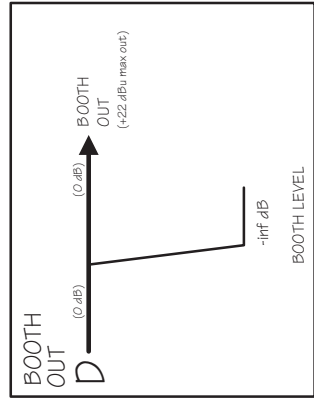
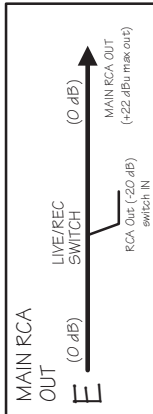
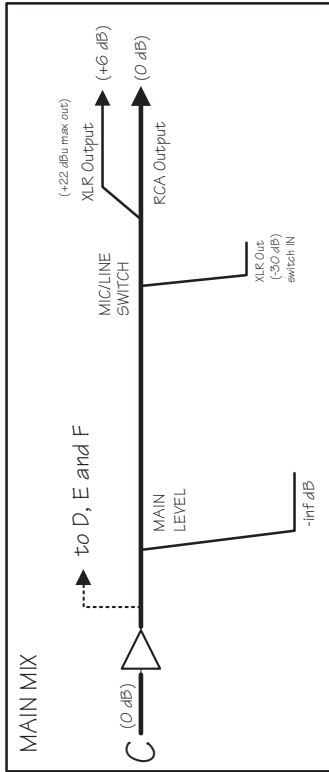
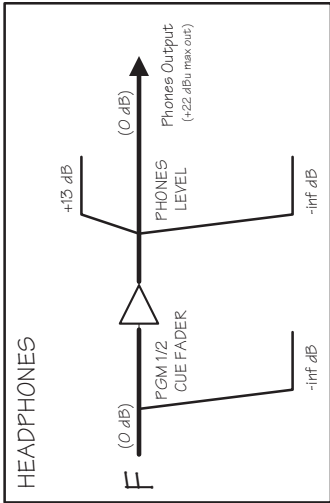
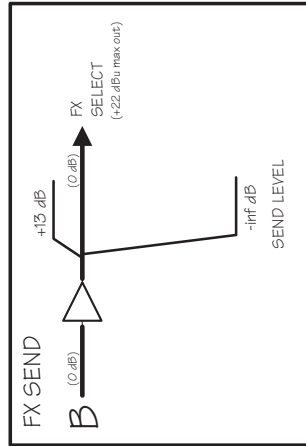
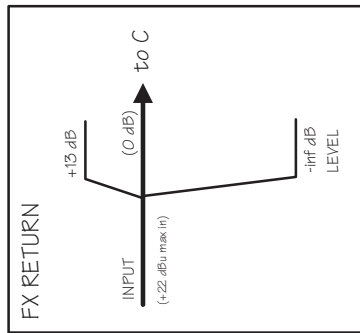
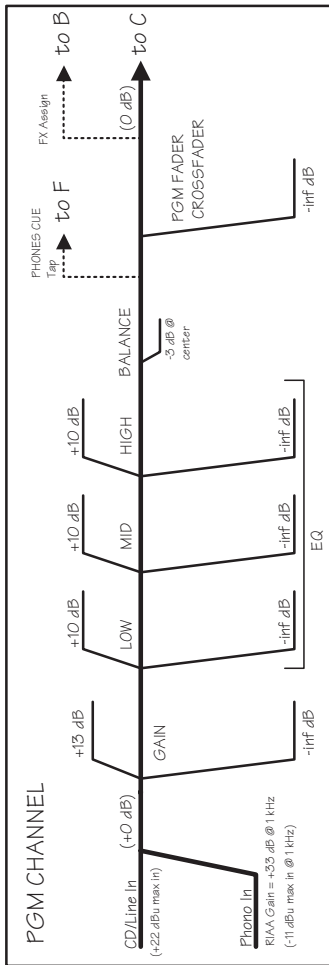
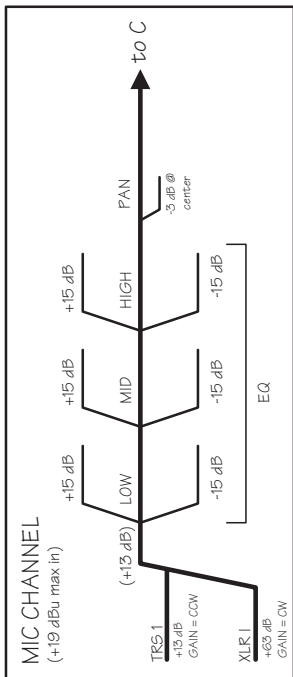

Appendix D: Transform Switch Rotation and Fader Replacement

Transform Switch Rotation

From the factory, the transform switches operate vertically, that is (to get all technical for a moment) fore and aft.

You can perform a simple modification to make these switches operate sideways, or even diagonally, to suit your carefully cultivated set of operational preferences.

Tools

To do this procedure, you will need a small phillips screwdriver, nerves of steel, grit, determination, and a steady hand. People should find you ruggedly charming, yet approachable.

Procedure

1. Remove the power cord, and any other cords or cables connected to the d.2.
2. Gently place the d.2 face upwards on a flat, clean and dry surface, such as the kitchen table.
3. Remove the three slider knobs, by gently pulling them upwards. Keep them safe.
4. Undo the five screws from the top panel and two screws from the front, as shown. Keep the screws in a safe place, away from Llamas.

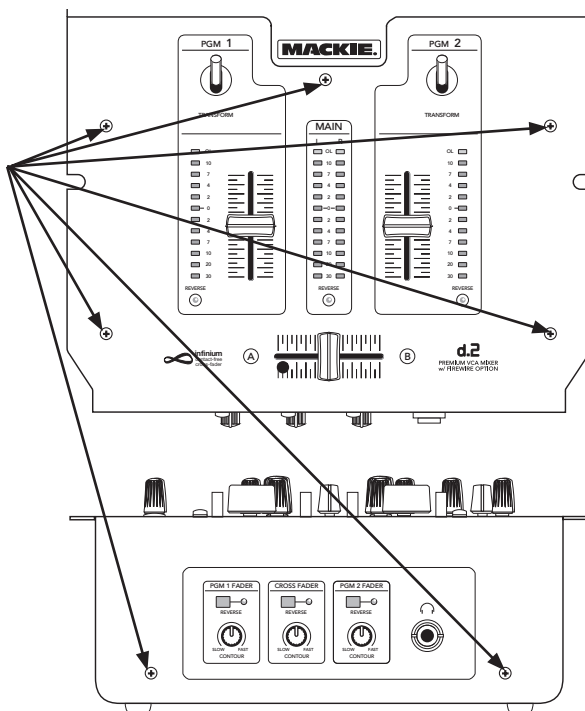

5. Gently lift off the panel, taking care not to damage the front panel contour knobs. Keep it in a safe place were it won't get scratched, or fall off the table and hit the cat.

6. Each transform switch has four screws, but remove only the outer two. These are black, whereas the inner screws are bright and shiny.

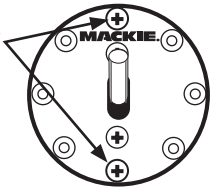

7. Rotate the switch assembly to suit your preference, and replace the two screws.



Diagonally

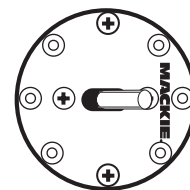

Sideways

8. If you need to replace a transform switch, gently pull it out just enough so you can reach and undo its connector. Connect the new switch securely, and screw it in the desired position. You might want to replace both switches, if they are both aged and/or had a rough life.

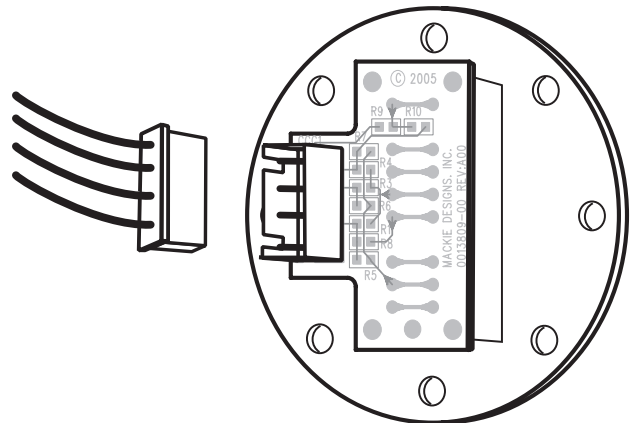

9. Replace the top cover, and make sure that all the meter LEDs and the Reverse LEDs are poking through before you tighten down the screws securely.

Replacing Faders

If the faders ever need to be replaced, this can be done with the help of your trusty screwdriver.

10. Follow steps 1 to 5 and remove the top panel.
11. Take care to only remove the two outer screws of each fader you are replacing, as shown below.

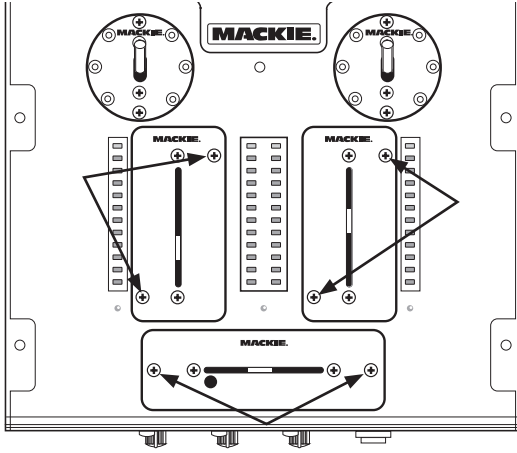

12. Gently lift up the fader assembly, just enough to be able to pull the connector out of the receptacle on the bottom of the fader assembly.

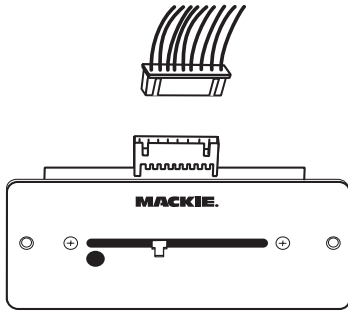

Removing the Cross Fader Connector

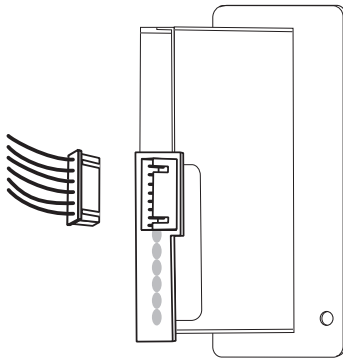

Removing a Program Fader Connector

13. Insert the connector into the receptacle on the new fader assembly. (It will only fit in one way.)

14. Secure the fader assembly to the chassis with the two screws you lost in step 11.
15. Replace the top cover, and make sure that all the meter LEDs and the Reverse LEDs are poking through before you tighten down the screws securely.
16. Check that all the faders and switches are working normally. (You might have to reset the tension if you changed the cross fader.)

Limited Warranty

Please keep your sales receipt in a safe place.

A. LOUD Technologies Inc. warrants all materials, workmanship and proper operation of this product for a period of **three years** from the original date of purchase. If any defects are found in the materials or workmanship or if the product fails to function properly during the applicable warranty period, LOUD Technologies, at its option, will repair or replace the product. **This warranty applies only to equipment sold and delivered within the U.S. by LOUD Technologies Inc. or its authorized dealers.**

B. Failure to register online or return the product registration card will not void the three-year warranty.

C. Service and repairs of Mackie products are to be performed **only** at a factory-authorized facility (see D below). Unauthorized service, repairs, or modification will void this warranty. To obtain repairs under warranty, you must have a copy of your sales receipt from the authorized Mackie dealer where you purchased the product. It is necessary to establish the purchase date and determine whether your Mackie product is within the warranty period.

D. To obtain factory-authorized service:

1. Call Mackie Technical Support at 800/898-3211, 7 AM to 5 PM Monday through Friday (Pacific Time) to get a Service Request Number. Products returned without a Service Request Number will be refused.
2. Pack the product in its original shipping carton. Also include a note explaining exactly how to duplicate the problem, a copy of the sales receipt with price and date showing, and your return street address (no P.O. boxes or route numbers, please!). If we cannot duplicate the problem or establish the starting date of your Limited Warranty, we may, at our option, charge for service time.
4. Ship the product in its original shipping carton, **freight prepaid** to the authorized service center. The address of your closest authorized service center will be given to you by Technical Support.

IMPORTANT: Make sure that the Service Request Number is plainly written on the shipping carton.

E. LOUD Technologies reserves the right to inspect any products that may be the subject of any warranty claims before repair or replacement is carried out. LOUD Technologies may, at our option, require proof of the original date of purchase in the form of a dated copy of the original dealer's invoice or sales receipt. Final determination of warranty coverage lies solely with LOUD Technologies.

F. Any products returned to one of the LOUD Technologies factory-authorized service centers, and deemed eligible for repair or replacement under the terms of this warranty will be repaired or replaced within thirty days of receipt. LOUD Technologies and its authorized service centers may use refurbished parts for repair or replacement of any product. Products returned to LOUD Technologies that do not meet the terms of this Warranty will not be repaired unless payment is received for labor, materials, return freight, and insurance. Products repaired under warranty will be returned freight prepaid by LOUD Technologies to any location within the boundaries of the USA.

G. LOUD Technologies warrants all repairs performed for 90 days or for the remainder of the warranty period. This warranty does not extend to damage resulting from improper installation, misuse, neglect or abuse, or to exterior appearance. This warranty is recognized only if the inspection seals and serial number on the unit have not been defaced or removed.

H. LOUD Technologies assumes no responsibility for the quality or timeliness of repairs performed by an authorized service center.

I. This warranty is extended to the original purchaser and to anyone who may subsequently purchase this product within the applicable warranty period. A copy of the original sales receipt is required to obtain warranty repairs.

J. This is your sole warranty. LOUD Technologies does not authorize any third party, including any dealer or sales representative, to assume any liability on behalf of LOUD Technologies or to make any warranty for LOUD Technologies Inc.

K. THE WARRANTY GIVEN ON THIS PAGE IS THE SOLE WARRANTY GIVEN BY LOUD TECHNOLOGIES INC. AND IS IN LIEU OF ALL OTHER WARRANTIES, EXPRESS AND IMPLIED, INCLUDING THE WARRANTIES OF MERCHANTABILITY AND FITNESS FOR A PARTICULAR PURPOSE. THE WARRANTY GIVEN ON THIS PAGE SHALL BE STRICTLY LIMITED IN DURATION TO THREE YEARS FROM THE DATE OF ORIGINAL PURCHASE FROM AN AUTHORIZED MACKIE DEALER. UPON EXPIRATION OF THE APPLICABLE WARRANTY PERIOD, LOUD TECHNOLOGIES INC. SHALL HAVE NO FURTHER WARRANTY OBLIGATION OF ANY KIND. LOUD TECHNOLOGIES INC. SHALL NOT BE LIABLE FOR ANY INCIDENTAL, SPECIAL, OR CONSEQUENTIAL DAMAGES THAT MAY RESULT FROM ANY DEFECT IN THE MACKIE PRODUCT OR ANY WARRANTY CLAIM. Some states do not allow exclusion or limitation of incidental, special, or consequential damages or a limitation on how long warranties last, so some of the above limitations and exclusions may not apply to you. This warranty provides specific legal rights and you may have other rights which vary from state to state.

MACKIE®

16220 Wood-Red Road NE • Woodinville, WA 98072 • USA

United States and Canada: 800.898.3211

Europe, Asia, Central and South America: 425.487.4333

Middle East and Africa: 31.20.654.4000

Fax: 425.487.4337 • www.mackie.com

E-mail: sales@mackie.com