

COMMScope®
Andrew Solutions

SAHARA SERIES DryLine® DEHYDRATOR

USER MANUAL

Bulletin AE01B-A0587-001
© 2011 - 2012 CommScope, Inc. All rights reserved

Rev: C
(1/12)



Table of Contents

Section 1	General Information	4
1.1	Introduction	4
1.2	Description	4
1.3	Theory of operation	4
1.4	Alarms	5
	Figure 1 — Discrete Alarm Terminal Strip with Summary Alarm.	5
	Figure 2 — Summary Alarm Terminal Strip	5
	Figure 3 — Pin and Jumpers Location	6
1.5	Specifications SAHARA Series Dehydrator	6
Section 2	Installation	7
2.1	Unpacking and Inspection	7
2.2	Controls and Displays	7
2.2.1	Event Log Codes	7
2.3	Installing the Dehydrator	7
2.3.1	Set on bench or the floor	7
2.4	Power Connections	7
2.4.2	Test the Dehydrator	8
2.5	Connecting the Alarm Outputs	8
2.4.1	AC Power.	8
2.6	Connecting Dehydrator to the Transmission Line.	8
	Figure 4 — SAHARA Series System configuration diagram Basic.	9
2.6.2	SAHARA Series System configuration diagram Multi-Line.	9
	Figure 5 — SAHARA Series System configuration diagram Multi-Line.	9
2.6.3	Pressure Monitoring and Control	9
2.6.4	Dehydrator Duty Cycles	9
2.7	Purging the Transmission Line	9
2.6.1	SAHARA Series System configuration diagram Basic	9
2.8	PC Interface to B-Version Dehydrator Control Board	10
Section 3	Maintenance	12
3.0	Maintenance	12
3.1	Preventive Maintenance	12
3.2	Dehydrator Filter Element Replacement	12
3.2.1	Replace the coalescing filters.	12
3.3	Annual Inspection	12
3.3.1	Check the electrical connections.	13
3.3.2	Check the ground wire	13
3.3.3	Check the hour meter.	13
3.4	Parts Replacement and Dehydrator Overhaul.	13
3.4.1	In Case Of Difficulty:	13
3.4.2	Tools	13
3.4.3	Overhaul Procedure	13
3.4.4	Unit Shutdown and Removal	14
3.4.5	Unplug the unit from the power supply.	14
3.5	Service Restoration RECOMMENDATION:	14
Section 4	Troubleshooting.	15
	Figure 6 — Electrical Diagram SAHARA2 and SAHARA2A.	17
	Figure 7 — Pneumatic Diagram	18

Section 5	Replacement Parts	19
	Overhaul Kit SAHARA-KIT-OVRHL	19
	Filter Element Replacement Kit SAHARA-KIT-ELMNT	19
	Filter Bowl Assemble Replacement Kit SAHARA-KIT-FLTRS	19
	Dryer Tube Replacement Kit SAHARA-KIT-DRYER	19
	Solenoid Replacement Kit SAHARA-KIT-SOLND	19
Section 6	Customer Service	19
6.0	Introduction	19
6.1	In Case of Trouble	19
6.2	Initial Steps by CommScope	20
6.3	Repair Center Process	20
6.4	RoHS Inquiries	20

Section 1 General Information

1.1 Introduction

This manual contains the information you need to install, operate and maintain your SAHARA Series DryLine® Dehydrator. Please take the time to read this manual before attempting to operate or service the unit.

CAUTION:
This appliance is not intended for access by the general public.

This appliance is not intended for use by persons (including children) with reduced physical, sensory or mental capabilities, or lack of experience and knowledge, unless they have been given supervision or instruction concerning use of the appliance by a person responsible for their safety.



1.2 Description

SAHARA Series dehydrators provide dry air for pressurizing large (2830 to 31,150 liters (100 and 1100 ft³), antenna and transmission line systems. The dehydrators produce -45°C (-50°F) dew point dry air at a nominal volumetric flow rate of 56.3 SLPM (2.0 SCFM).

Each dehydrator consists of an electrically driven air compressor, a membrane dryer assembly, an automatic transmission line pressure sensing system, and alarm outputs housed in a rigid metal chassis. It is designed as a free-standing unit. The front panel features a control interface with display for alarms and pressure. For easy serviceability, power connections, alarm output connections, and all filter elements are accessible from the outside.

The SAHARA Series maintains transmission line pressures from 14-34 kPa (2.0 to 5.0 psig). It is intended for standard microwave antenna/Broadcast applications and any other transmission line pressurization requirement that supports a medium pressure limit.

1.3 Theory of operation

The SAHARA series of DryLine® Dehydrators, while similar in moisture removal technology, operates differently than some of the DryLine® series of dehydrators. In order to maintain a positive constant level of pressure to medium air volume systems, and to maintain an acceptable dryness level in the product air stream, a downstream pressure sensor is utilized for controlling the operation of the unit. This feedback controlled sensor prompts the unit to engage at 14 kPa (2.0 psig) and shut down at 34 kPa (5.0 psig). In addition to monitoring the downstream flow, the system is also set up to utilize the downstream air volume to provide the dry air for the feedback loop. The feedback loop is necessary to maintain the dryness of the membrane cartridge and will consume a small percentage of the air supplied by the dehydrator.

During normal operation, the bleed air in the feedback loop will cause the pressure to slowly drop in the downstream air volume, and the SAHARA compressor will cycle automatically. The dehydrator will only cycle off when it sees a down stream pressure of 34 kPa (5.0 psig). The rate of these cycles, however, will vary based on system volume and overall system leak rate.

When connected to a normal system, the dehydrator's duty cycle should not exceed 10% and will maintain the system pressure between 14 kPa (2.0 psig) and 34 kPa (5.0 psig). If the duty cycle significantly exceeds 10%, check the system for leaks. When open to atmosphere, the dehydrator will run continuously and provide approximately 56.3 SLPM (2.0 SCFM).

The display will also reflect a pressure between 0 and 34 kPa (5.0 psig) while the output flow is between 0 and 56.3 SLPM (2.0 SCFM). The pressure sensor measures pressure at the Remote Sense port and will show the actual pressure in the transmission lines (or to the distribution manifold).

1.4 Alarms

The SAHARA Series offers Low Pressure and Excess Run alarms as a standard feature. In addition, a summary alarm connection is provided on all units. Additional alarms are available in the discrete alarm version. These include High Humidity and Power Fail alarms. All four alarms, plus the summary alarm, have discrete connection contacts. Alarm conditions are indicated on the display. The alarms are Form C dry contacts and have connection options for Normally Open (NO) or Normally Closed (NC) configurations.

The external alarm monitoring system (supplied by others) is connected to the terminal strip located on the rear of the cabinet. A small slotted screwdriver is necessary to make the connections.

The connections to the alarm strip are as follows; refer to Figure 1 for correct locations and colors of the wires on the terminal strip.

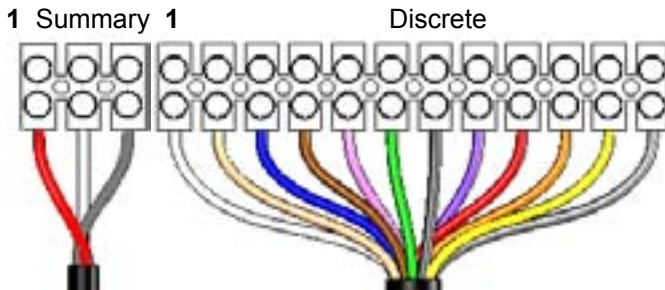
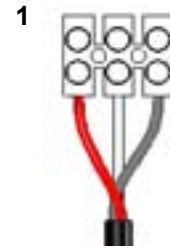

Figure 1 — Discrete Alarm Terminal Strip with Summary Alarm

DISCRETE WIRE FUNCTION REFERENCE		
WIRE TERMINAL	COLOR	ALARM FUNCTION
1	WHITE	EXCESS RUN NO
2	TAN	EXCESS RUN COM
3	BLUE	EXCESS RUN NC
4	BROWN	HIGH HUMIDITY NO
5	PINK	HIGH HUMIDITY COM
6	GREEN	HIGH HUMIDITY NC
7	BLACK	POWER FAIL NO
8	VIOLET	POWER FAIL COM
9	RED	POWER FAIL NC
10	ORANGE	LOW PRESSURE NO
11	YELLOW	LOW PRESSURE COM
12	GRAY	LOW PRESSURE NC



WIRE FUNCTION REFERENCE		
WIRE TERMINAL	COLOR	ALARM FUNCTION
3	BLACK	SUMMARY NC
2	WHITE	SUMMARY COM
1	RED	SUMMARY NO

Figure 2 — Summary Alarm Terminal Strip

Alarm Definitions:

Summary: Activates when Excess Run, and/or Low Pressure alarms are triggered. It will also report High Humidity if unit is equipped with full alarms. The summary alarm does not report Power Fail.

Power Fail: Activates when power is removed from the dehydrator. This includes turning the power off at the switch.

High Humidity: Activates when system or dehydrator output humidity rise above 7.5% relative humidity. At initial installation, this alarm will continue to alarm until the system has been properly purged.

Excess Run: Factory strapped run time set in accordance with the normal run time for the dehydrator application. Selectable times are 1, 10, 30, 120 and 240 minutes, with the 10 minute selection used on the SAHARA Series as the default setting.

Low Pressure: If system pressure falls below the low-pressure trigger point (7 kPa (1.0 psig) on the SAHARA Series), the low-pressure alarm sensor will activate an alarm contact. This alarm is an indication of a significant system leak or a dehydrator failure.

Note:

All of the alarms clear and reset automatically, but can be manually reset in the display menus. However, if the alarm condition still exists, the alarm will return immediately after being reset.

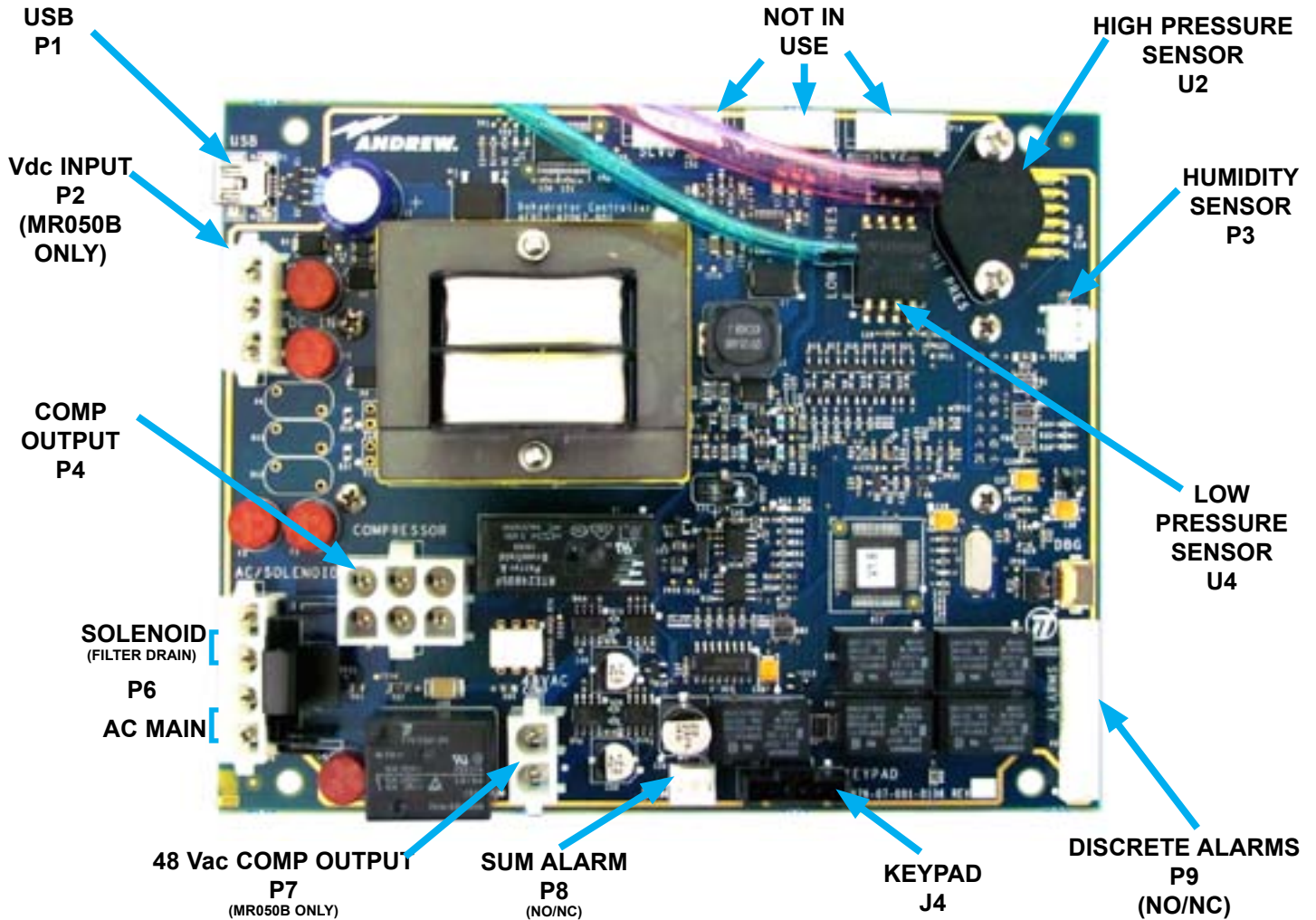

Figure 3 — Pin and Jumpers Location

1.5 Specifications SAHARA Series Dehydrator

Output Pressure, kPa (psig)	14-35 (2.0-5.0)	Dimensions	Height, mm (in) w/feet without feet	292 (11.5) 267 (10.5)
Output capacity	56.6 SLPM (2.0 SCFM) (total, approx.)		Width, mm (in) Depth, mm (in)	432 (17.0) 381 (15.0)
Output Dew Point,	-45° C (-50° F) or better	Net weight, kg (lb)		24.95 (55.0)
Operating Temperature Range	-10° to 40° C (14° to +104° F)	Alarms		
Electrical Input SAHARA2 & SAHARA2a SAHARA2 & SAHARA2a	220 Vac, 60 Hz 240 Vac, 50 Hz	Power Fail Alarm (optional)	loss of input power	
Output Connector	3/8" polytube, compression	High Humidity Alarm Set Point (optional)	7.5% RH, factory set	
		Excess Run Alarm	10 minutes, factory set	
		Low Pressure Alarm, kPa (psig)	6.9 (1.0)	

Section 2 Installation

2.1 Unpacking and Inspection

Open carton.



Remove the top piece of foam packaging. Carefully remove the installation accessories and manual and dehydrator. Check the dehydrator for shipping damage such as dents or loose parts.

2.2 Controls and Displays

Default password is 1111

Familiarize yourself with the controls and displays prior to installing or testing the dehydrator.



Keypad Controls:



Advances display (scrolls ahead) to the next display or program mode with out changing the values in the microprocessor memory.



Enters into the microprocessor memory the values displayed in the window and advances display (scrolls ahead) to the next program or display mode.



Numerically increase displayed settings in display window. When depressed longer than 1/2 second scrolling will occur at a faster rate.



Numerically decrease displayed settings in display window. When depressed longer than 1/2 second scrolling will occur at a faster rate.



Used to allow the user quick access to the system event log.

2.2.1 Event Log Codes

EV= 0 Event = Power Up

EV= 1 Event = High Humidity Alarm

EV= 2 Event = Excessive Run Time Alarm

EV= 3 Event = Low Pressure Alarm

EV= 4 Event = High Pressure Alarm

EV= 5 Event = Compressor Fault

EV= 6 Event = Log Cleared

EV= 7 Event = Powering Down

EV= 8 Event = Compressor Lifetime Eeprom Fail

2.3 Installing the Dehydrator

2.3.1 Set on bench or the floor

2.4 Power Connections

Confirm your dehydrator electrical input matches the available power.

Ensure an electrical safety ground is installed on the ground stud located adjacent to the power input connector. (It is intended to be customer installed in the field to your halo grounding system.)

SAHARA2 & SAHARA2A
 220 Vac, +/- 10% 60 Hz
 240 Vac, +/- 10% 50 Hz

2.4.1 AC Power

AC units should be connected into a standard 30 amp power receptacle of the proper voltage. Make sure the power circuit is properly grounded.



CAUTION:
Proper electrical connection is required. It is suggested a licensed electrician be contracted to connect the AC wiring to the unit, if it is connected directly to the mains. Failure to properly connect the power wires could result in a dangerous electrical shock hazard.

CAUTION:
This unit is designed for connection to a single phase power source. Connection to a 3 phase power source will cause significant damage to internal components.

2.4.2 Test the Dehydrator

Turn the dehydrator ON and check the output port on the rear of the unit after five seconds of operation to make sure air is flowing.

2.5 Connecting the Alarm Outputs

To connect the alarms, locate the terminal block (TB-1) on the rear of the unit.

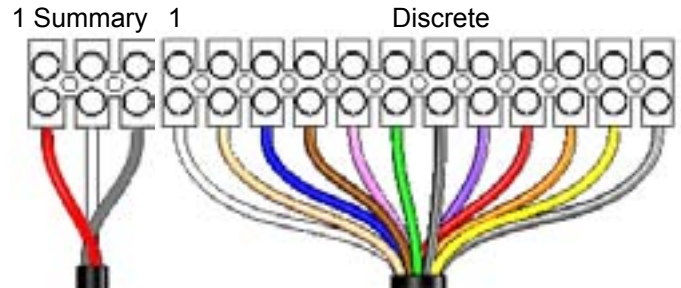

Place alarm connection wires in proper terminals and tighten the screw on the terminal block.

(See section 4)

The relay contacts are rated at 2 A (non-inductive), 30 Vdc.

2.6 Connecting Dehydrator to the Transmission Line

CAUTION:
Check the antenna and transmission line system pressure rating before connecting the dehydrator to the system.

Insert one end of the 3/8" poly tube feed line tubing into the fitting on the dehydrator output port. Connect the other end of the poly tube to the transmission line.

Connect the Remote Sense Line Tubing. Insert a single tubing run from the transmission line into the fitting on the rear of the unit marked "Remote Sense".

Install the isolation shutoff valves. The valves when used on output lines, allow the system to retain pressure while the system is removed for servicing. Place each valve in line between each output and transmission line.

Install the Output line and the Remote Sense line in separate ports on the gas inlet. If a second port is not available, install a tee in the gas inlet at the transmission line and connect both the outlet and Remote Sense to the tee. However, this type of connection could cause excessive back pressure in the dehydrator, causing it to short - cycle.

*** CAUTION:**
Do not operate the unit with the Remote Sense line disconnected, this may result in an over pressure condition. Also be sure that any isolation valves are open before operating the unit.

2.6.1 SAHARA Series System configuration diagram Basic

This configuration shows proper hook up for systems when only a single waveguide is required in the system.

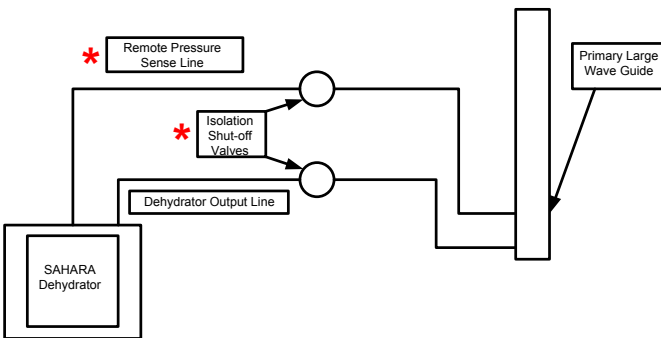

Figure 4 — SAHARA Series System configuration diagram Basic

2.6.2 SAHARA Series System configuration diagram Multi-Line

This configuration shows proper hook up for systems when more than a single waveguide is required in the system. For larger systems, a 6- output manifold can be added. This diagram can also be used for hooking a DP-4A-001 or 6600D Series or LM400 Series Manifold to the system.

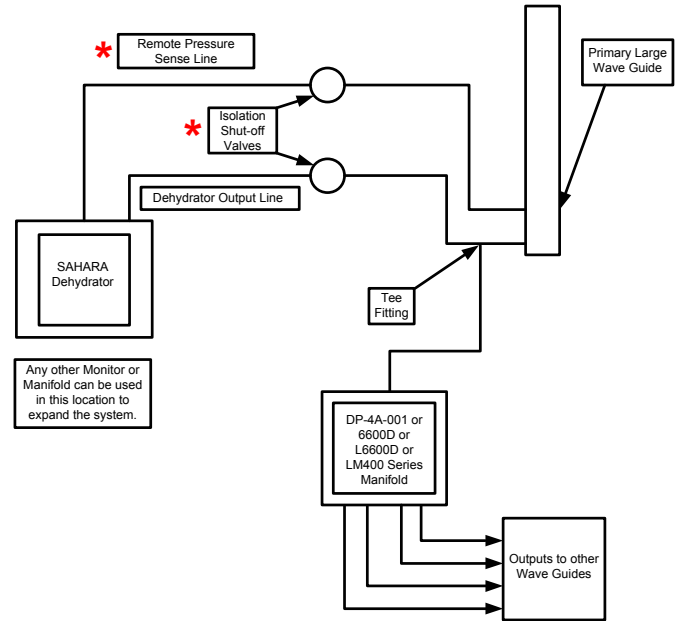

Figure 5 — SAHARA Series System configuration diagram Multi-Line

2.6.3 Pressure Monitoring and Control Pressure Monitoring Points

Dehydrator output pressure is monitored at the transmission line on all models by the “Remote Sense” port on the rear of the unit.

2.6.4 Dehydrator Duty Cycles

The dehydrator is programmed at the factory to start when the output pressure of the dehydrator drops to 13.8 kPa (2 psig) and stops when the pressure reaches 34.5 kPa (5 psig).

Some system components, however, have lower pressure ratings. If this is the case please contact CommScope Customer service.

Note: If the transmission lines have not been purged, continue with section 2.7. Otherwise proceed to section 3.

2.7 Purging the Transmission Line

Air in the transmission line system must be replaced with dry air to ensure satisfactory operation of the transmitted signal.

1. Determine the total system volume.
2. Divide the system volume by the flow rate of the dehydrator 3398 SLPH (120 SCFH) to determine the number of hours needed for one purge cycle.

3. Open the far end of the transmission line.
4. Operate the dehydrator for no less than three purge cycles.

If it is not possible to open the far end of the transmission line, follow these steps:

1. Connect the dehydrator to the transmission line and pressurize the system. The system pressure should reach 34 kPa (5.0 psig).
2. Wait 15 minutes while the air absorbs moisture in the system, then disconnect the dehydrator from the transmission line and allow the air to vent.
3. Repeat steps 1 and 2 twelve times to purge the system.

2.8 PC Interface to B-Version Dehydrator Control Board

1. Turn off dehydrator remove top cover; connect a USB 2.0 and mini-USB cord between the computer and the dehydrator control board. The mini-USB connector is found on the upper left corner of the controller board and is marked "USB". (See image below).



2. Once the unit is powered up and connected to the computer, a Found New Hardware Wizard may open. Select "No, not this time" and click "Cancel".
3. Go to the Start menu > select Programs > Accessories > Communications > HyperTerminal.
4. The HyperTerminal will ask for a Connection Description Name. This is not relevant for this device, so type anything into this field; it will not be useful once the board is disconnected from the computer. A new connection will need to be established every

new time that the unit is connected.

5. Choose the virtual com port from the drop-down list. It should be Com3 or Com4 for the first time that you load firmware; click "Next".
6. In the Port Settings screen, change the "Bits per Second" setting to 19200 and change the "Flow Control" setting to None.
7. Turn Caps Lock on. Type "ID" into the blank field and hit enter. The program should respond with a list of data including serial number, hardware and firmware version, etc.

If it does not respond with this, your connection did not work. The virtual com port selection is generally the issue here. Start a new connection and try again.

8. Once successfully connected, you can enter "HELP" to view a list of commands.
9. In order to access your unit's entire event log, click on Transfer on the command bar at the top of the page. Click on "Capture Text" in the drop-down menu and then choose a location on your computer to store the text file. Type in "GLOG" and hit enter. Click on Transfer again and click on Transfer Text and select Stop from the side-scroll menu.
10. Open the text file from the storage location. Copy the entire text to MS Word to view the event log correctly.
11. When viewing events on the display of the unit, the following codes will be shown.

<u>LCD</u>		<u>Reference in code</u>		<u>Log download string</u>
"EV= 0"	-	LOGEV_POWERUP	-	"Event = powering up"
"EV= 1"	-	LOGEV_HH_ALM	-	"Event = humidity alarm trip"
"EV= 2"	-	LOGEV_XR_ALM	-	"Event = excessive run time alarm trip"
"EV= 3"	-	LOGEV_LP_ALM	-	"Event = low-pressure alarm trip"
"EV= 4"	-	LOGEV_HP_ALM	-	"Event = high-pressure alarm trip"
"EV= 5"	-	LOGEV_CP_ALM	-	"Event = compressor fault trip"
"EV= 6"	-	LOGEV_CLR	-	"Event = log cleared"
"EV= 7"	-	LOGEV_PWRDWN	-	"Event = powering down"
"EV= 8"	-	LOGEV_CL_FAIL	-	"Event = Comp lifetime eeprom fail"

12. For each additional unit that is re-flashed, the virtual Com port will increment by one. If the first unit is Com3, the next will be Com4 and so on

Section 3 Maintenance

3.0 Maintenance

The SAHARA Series Dehydrator requires relatively little maintenance to ensure satisfactory operation over long periods of time. This section outlines the recommended annual preventive maintenance for the unit and the suggested overhaul for every 6000 hours of compressor operation.

3.1 Preventive Maintenance

The annual maintenance of a SAHARA Series consists of a preventative maintenance inspection of the dehydrator and replacement of the felt air intake filter if necessary. These tasks can easily be performed in the field with the unit connected to the transmission line system and with only the front and top corner opened for maintenance. In addition to the annual inspection, a complete overhaul is recommended every 6000 hours or sooner if local conditions warrant.



3.2 Dehydrator Filter Element Replacement

3.2.1 Replace the coalescing filters

Remove front cover, turn filter bowl housing CCW, to remove coalescing filters element. No need to remove any hoses. From the front of the dehydrator, the left coalescing filter is 5.0 micron and the right coalescing filter is 0.01microns. The coalescing elements should be replaced every 6000 hours of operation. To replace filter coalescing elements due things in reverse orders.



CAUTION:
Do not apply oil or other chemicals to the filter element.

Make sure the element is seated completely in the housing and then replace the cover. Discard old elements.

3.3 Annual Inspection

Warning:
Electrical Hazard! Unplug power cord before servicing unit.

Inspection includes checking for loose or damaged hoses, fittings and electrical connections. Open the top cover and front door and verify that there is no significant water build-up in the two filter bowls located inside the front cover of the dehydrator. There may be some droplets of water in the filter bowls (the lower portion of each bowl), but there should be only a small amount of liquid in either bowl.



If there is excessive water, refer to the troubleshooting section 4. Replacement of the elements in the coalescing filters is covered in the maintenance section of this manual.

3.3.1 Check the electrical connections.

Check the screw at the power input connector to ensure that the AC power cord is securely terminated. Check the screw-in alarm terminals to ensure that all wire connections are tight.

A loose or damaged connection may result in erratic operation and unnecessary downtime. Refer to the troubleshooting section 4 if an electrical problem is encountered.

3.3.2 Check the ground wire

Check that an electrical safety ground is installed on the stud on the rear of the dehydrator. This connection point is adjacent to the power input connector. (It is intended to be customer installed to the halo grounding system.)

3.3.3 Check the hour meter

Check the hour meter on the display to determine the duty cycle of the dehydrator.

If the dehydrator has been running for more than 10% of its installed time, check the systems for leaks. Also check the time on the meter to determine if it is time to perform the 6000-hour overhaul.



3.4 Parts Replacement and Dehydrator Overhaul

CommScope SAHARA Series DryLine® Dehydrator are designed to give many years of trouble-free service and require very minimal maintenance. The dehydrator contains, as a standard feature, an hour meter that records compressor run hours. To ensure continuous and reliable operation, the dehydrator must be overhauled every 6000 hours of compressor operation. The kits, shown in Section 5, contain all of the necessary parts to perform this overhaul. The dehydrator overhaul kit includes parts to overhaul the compressor and critical components in the dehydrator that often become worn over time.

3.4.1 In Case Of Difficulty:

If the dehydrator is not operating, refer to Section 2 on Installation and Section 4 on troubleshooting the unit.

3.4.2 Tools

The following tools are used in the maintenance and overhaul procedures.

- Adjustable open-end wrench
- #2 Phillips screwdrivers
- Small flat-blade screw-driver

3.4.3 Overhaul Procedure

When the SAHARA compressor run time reaches 6000 hours (or a multiple of 6000 hours) it is time to replace certain items in the compressor and the air path of the dehydrator. These include the piston cups, piston seals and head gaskets of the compressor, the filter elements in the water and coalescing filters, and the tube section connecting the compressor output to the heat exchanger.

In addition, if the unit gives the dryer pressure alarm, the compressor may be in need of an overhaul. This does not always coincide with the 6000 hour time frame. If the dryer pressure alarm is triggered, check the system for leaks. If no leaks are detected, the compressor will need to be overhauled.

3.4.4 Unit Shutdown and Removal

In order to perform an overhaul on the SAHARA Series, the unit must be turned off and removed from service. As this is being done, the low pressure alarm may activate through a reporting alarm system. Personnel monitoring such an alarm should be notified in advance so that they are aware of the fact that service is being performed. It is also necessary to disconnect the dehydrator dry air output from the waveguide system during the overhaul. If isolation valves have been installed between dehydrator/remote pressure sense line and transmission line, close valve before removing unit service to prevent pressure loss.

room, to purge the membrane dryer of any acquired moisture, before reconnecting to the transmission line system.

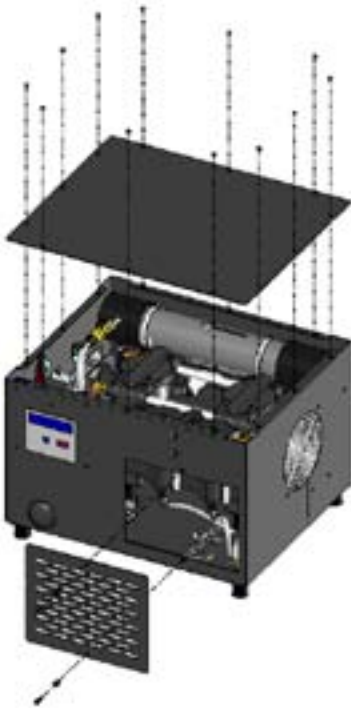

3.4.5 Unplug the unit from the power supply.

Follow the instructions included in the compressor overhaul kit. When the overhaul is complete, reinstall. Complete overhaul can be done without removing the compressor from the chassis. The compressor head, air filter, output port and relief valve can all be removed through top panel. When the overhaul is complete, reinstall.

3.5 Service Restoration RECOMMENDATION:

If the dehydrator overhaul process has taken more than a few hours, it is recommended that the unit be run for one hour into the

**Section 4
Troubleshooting**

If you experience difficulty with your dehydrator, use the troubleshooting procedures described below.

Caution:Electrical troubleshooting requires access to potentially dangerous voltages and should only be performed by a licensed electrician

Problem/Condition	Solution
Dehydrator display does not light, unit does not run.	If the display light falls to light, make sure the unit is plugged in and power outlet is operating.
	If you still have no light, unplug the unit, remove the unit cover and check for loose connections. Refer to the wiring diagram for proper connections.
	Check to ensure that proper AC voltage is being supplied to the input. (See figure 6)
Low-pressure alarm activated.	Turn shut-off valve to the off position and observe pressure gauge. The pressure gauge line should read approximately 34 kPa (5.0 psig) and the alarm should clear. If alarm does not clear, remove cover and verify tubing and wiring connections are secure. (See figure 6)
	With dehydrator isolated from transmission line, observe pressure in transmission line. If pressure drops, use a leak detector solution to locate leaks in the transmission line. Repair leaks if possible.
	If the problem persists contact CommScope Customer Service. (See Section 6)
Compressor does not turn.	Check the display on the controller. Toggle the ON/OFF switch (attached to power connection).
	Check input voltage per wiring diagram
	If the problem persists contact CommScope Customer Service. (See Section 6)
Filter bowls show excessive water.	Ensure that the drain line tubing (exiting the bottom of the drain solenoid) is not clogged. When the compressor cycles ON , air and moisture should flow out of the drain line (into drain pan) for a few seconds while the valve is open.
	If solenoid does not vent, verify proper voltage is present for the first few seconds after the compressor starts and drops to 0 volts.
	If proper voltage is present and solenoid does not shift, replace

Left blank for notes.

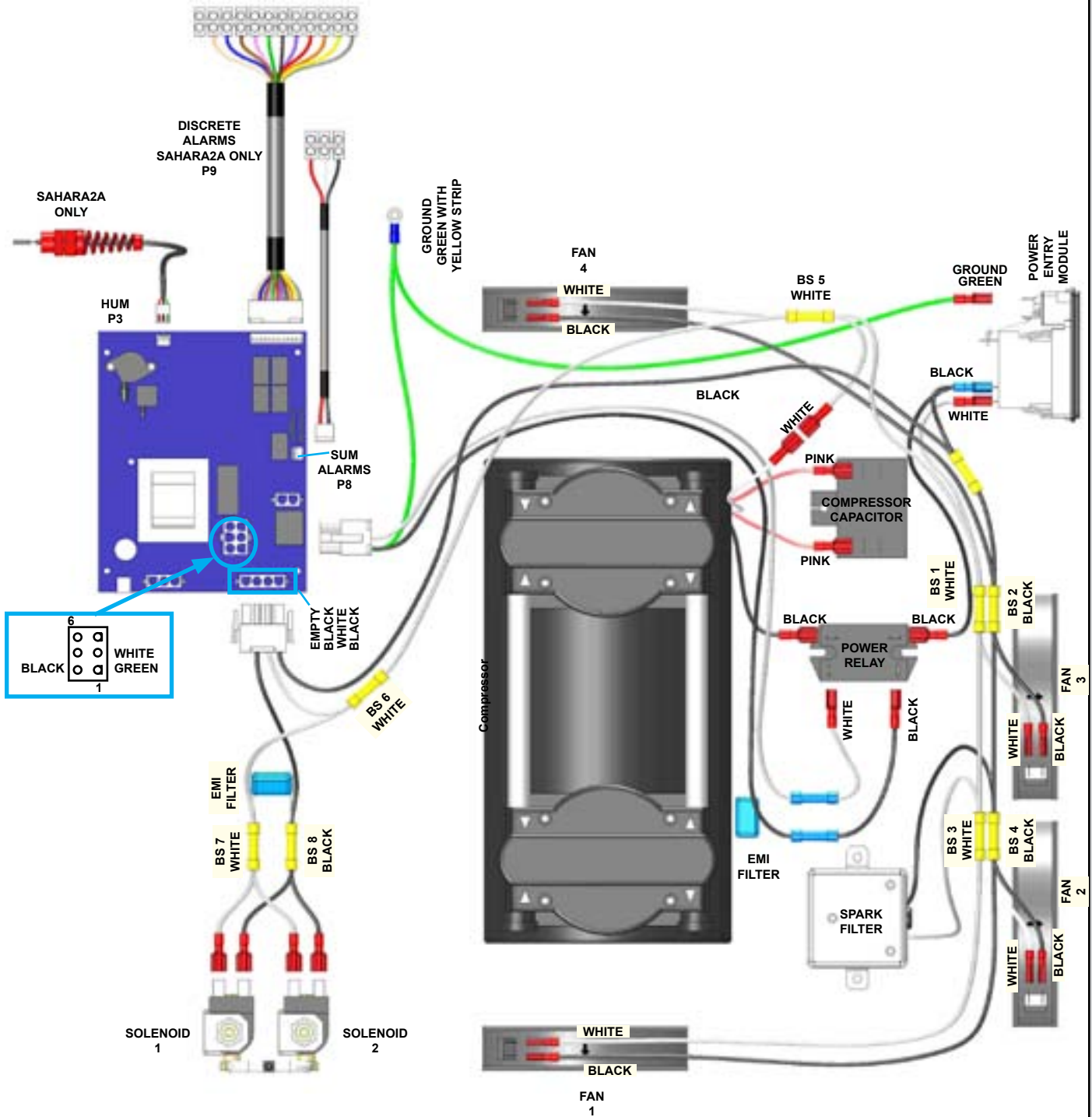

Figure 6 — Electrical Diagram SAHARA2 and SAHARA2A

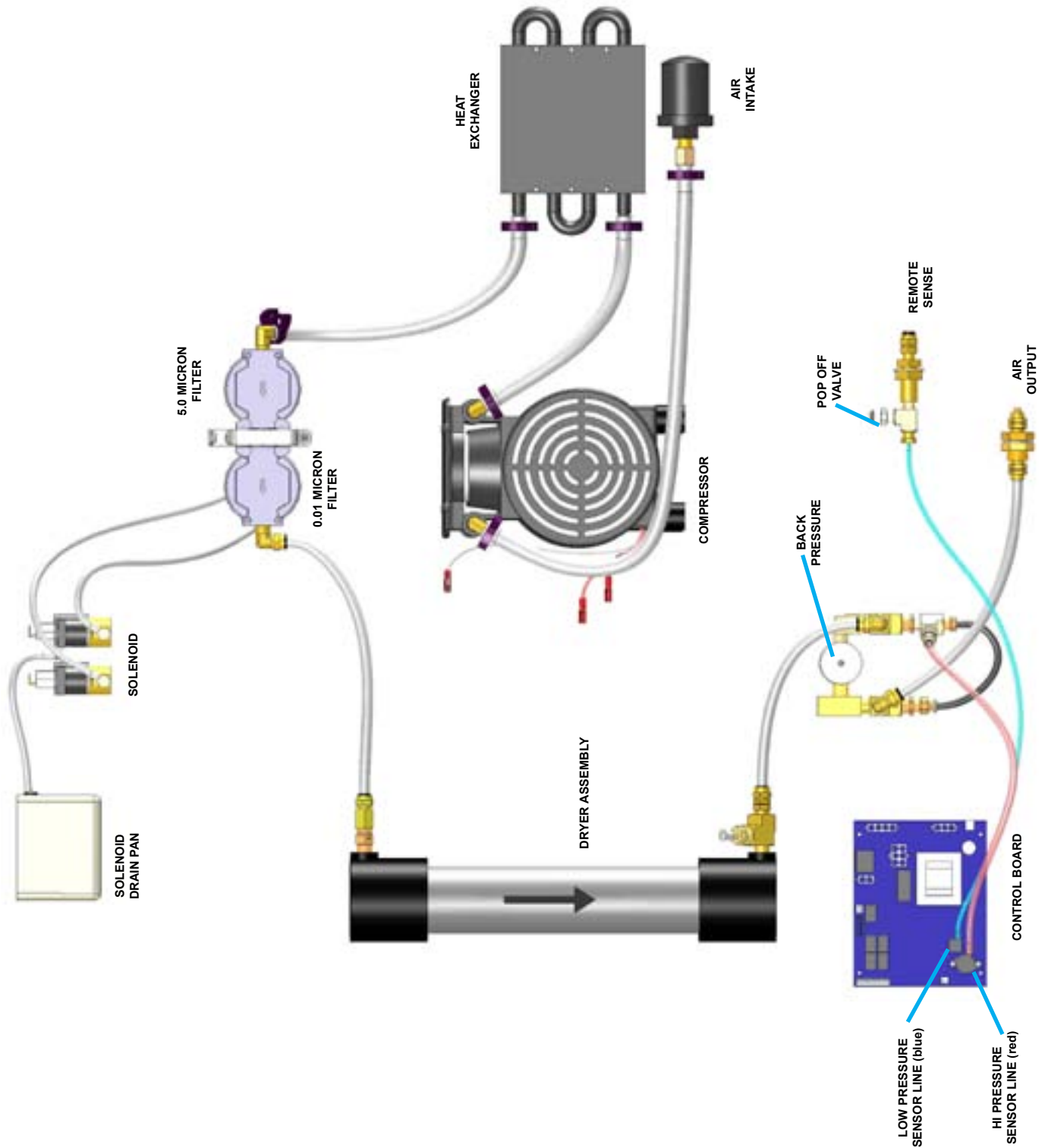

Figure 7 — Pneumatic Diagram

Section 5 Replacement Parts

The following is a list of the replacement kits for the SAHARA Series dehydrators:



Overhaul Kit SAHARA-KIT-OVRHL



Filter Element Replacement Kit SAHARA-KIT-ELMNT



Filter Bowl Assemble Replacement Kit SAHARA-KIT-FLTRS



Dryer Tube Replacement Kit SAHARA-KIT-DRYER



Solenoid Replacement Kit SAHARA-KIT-SOLND

Section 6 Customer Service

6.0 Introduction

CommScope provides in-warranty and out-of-warranty repairs as well as dehydrator and compressor overhauls from several Repair Centers. Coordination of these services is provided through the nearest Sales Office or Customer Service Center. The Center is also prepared to help you with the following:

- Technical Assistance
- Troubleshooting
- Repairs
- Loaner Units
- Spare Parts
- Installation Materials
- System Accessories

6.1 In Case of Trouble

The first step you should take if trouble develops using a dehydrator is to read the operators manual and follow the trouble isolating procedures given in it.

If the steps in the manual do not identify and remedy the problem, then contact an CommScope Customer Service Center for 24-hour telephone assistance.

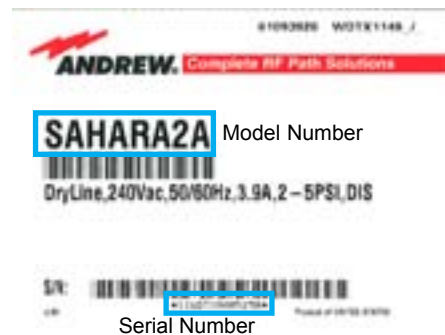

Record the Model Number (e.g. SAHARA) and Serial Number from the product label, as you will be asked for these when you call. Two main locations are currently available to help:

From North America
Telephone: 1-800-255-1479
Fax (U.S.A.): 1-800-349-5444

International

Telephone: +1-779-435-6500
Fax Number: +1-779-435-8579

Web Access

Internet: www.commscope.com
email: #prc@commscope.com

6.2 Initial Steps by CommScope

When your call or fax communication is received, the CommScope staff will work with you to pinpoint the possible cause of trouble. If the pressurization equipment is suspect, they will:

- ask for your unit Model Number and Serial Number
- check the warranty status of the unit
- advise the availability of a loaner unit
- provide an estimate of the cost for inspection and repairs, if the unit is out-of-warranty
- fax a Return Material Authorization Sheet to you.

6.3 Repair Center Process

A method of Payment must be provided prior to issuing of RMA regardless of warranty status.

In-Warranty Repair: Most CommScope pressurization products carry a warranty of one to three years, depending upon model number. Warranty details are available on our web page. If your unit falls within its warranty period, inspection and repairs will be performed at no charge and the unit will be promptly returned to you. If a warranty unit is deemed no problem found an inspection fee and freight will be charged to the customer.

Out-Of-Warranty Repair: We will inform you with the cost of repair and obtain your approval to proceed with repairs or, if you elect not to have the unit repaired, your instructions on disposition of your unit. When repairs are complete, we will return your unit and invoice you for the inspection charge, materials used for the repair and labor applied to complete the repair. If you elected not to repair the unit, we will invoice you for the inspection and freight charge if unit is to be returned.

Loaner Units: Loaner units are available from the repair center to maintain your system while repairs are being performed. If you feel you need a loaner, please contact us at one of the numbers listed under contact numbers. A P.O. for the full value of the unit must be issued prior to shipment. Also contact us when the loaner is ready to be returned so that we can issue a NEW RMA number to identify your return and create the appropriate credit to your account. Damages to loaner will be deducted from the P.O.

Packing Instructions: Pack your unit securely for shipment to the Repair Center. If you received a loaner unit, we suggest you use the box and packing materials to return your unit. Otherwise we have factory packing materials available for a nominal fee. Enclose a completed copy of this form inside the box and clearly mark your Company Name and RMA: XXXXXXXX on outside of the box. Address the box to the following Ship-To Address:

COMMSCOPE PRESSURIZATION SERVICE CENTER
RMA# XXXXXXXX
11312 S. PIPELINE RD.
EULESS, TX. 76040-6629

Please note, Units received with Biological/animal contamination will be returned unrepaired or scrapped after notification and you will be invoiced for inspection and freight.

Contact Numbers: If you have any questions about the repair process or status of your unit, please contact us directly through one of the following methods – Telephone (below)

TEL: 817-864-4150
817-864-4155

FAX: 817-864-4179

6.4 RoHS Inquiries

For inquiries on RoHS please contact the following:

CommScope Inc.
Corke Abbey, Bray Co.,
Dublin, Ireland
Attn: Legal Department