

# Applied Biosystems StepOne™ and StepOnePlus™ Real-Time PCR Systems





# **Applied Biosystems StepOne™ and StepOnePlus™ Real-Time PCR Systems**

Reagent Guide

© Copyright 2008, Applied Biosystems. All rights reserved.

Information in this document is subject to change without notice. Applied Biosystems assumes no responsibility for any errors that may appear in this document.

APPLIED BIOSYSTEMS DISCLAIMS ALL WARRANTIES WITH RESPECT TO THIS DOCUMENT, EXPRESSED OR IMPLIED, INCLUDING BUT NOT LIMITED TO THOSE OF MERCHANTABILITY OR FITNESS FOR A PARTICULAR PURPOSE. IN NO EVENT SHALL APPLIED BIOSYSTEMS BE LIABLE, WHETHER IN CONTRACT, TORT, WARRANTY, OR UNDER ANY STATUTE OR ON ANY OTHER BASIS FOR SPECIAL, INCIDENTAL, INDIRECT, PUNITIVE, MULTIPLE OR CONSEQUENTIAL DAMAGES IN CONNECTION WITH OR ARISING FROM THIS DOCUMENT, INCLUDING BUT NOT LIMITED TO THE USE THEREOF.

**For Research Use Only. Not for use in diagnostic procedures.**

**NOTICE TO PURCHASER: Label License**

The StepOne™ and StepOnePlus™ Real-Time PCR Systems are covered by one or more of US Patents Nos. 5,475,610, 5,602,756, 6,703,236, 6,814,934, 7,238,517, 7,423,750 and corresponding claims in their non-US counterparts, owned by Applied Biosystems Inc. No right is conveyed expressly, by implication, or by estoppel under any other patent claim, such as claims to apparatus, reagents, kits, or methods such as 5' nuclease methods. Further information on purchasing licenses may be obtained by contacting the Director of Licensing, Applied Biosystems, 850 Lincoln Centre Drive, Foster City, California 94404, USA.

**NOTICE TO PURCHASER:**

PLEASE REFER TO THE USER'S GUIDE OR PRODUCT INSERT OF THE REAGENTS NAMED HEREIN FOR LIMITED LABEL LICENSE OR DISCLAIMER INFORMATION.

**TRADEMARKS:**

Applied Biosystems, AB (Design), MicroAmp, Primer Express, and VIC are registered trademarks, and FAM, JOE, MicroAmp, MultiScribe, NED, ROX, StepOne, StepOnePlus, TAMRA, TET, and VeriFlex are trademarks of Applied Biosystems or its subsidiaries in the U.S. and/or certain other countries.

AmpErase, AmpliTaq Gold, and TaqMan are registered trademarks of Roche Molecular Systems, Inc.

SYBR is a registered trademark of Molecular Probes, Inc.

All other trademarks are the sole property of their respective owners.

Part Number 4379704 Rev. D  
12/2008

# Contents

## Preface

How to Use This Guide .....	vii
How to Obtain More Information .....	ix
How to Obtain Support .....	xii

## Chapter 1 Introduction

About the StepOne™ and StepOnePlus™ Systems .....	1-2
Supported Consumables .....	1-4
Preparing for Experiments .....	1-6
Select the Experiment Type .....	1-7
Select the Reagent Type .....	1-8
Select the Assay Type .....	1-9

## Chapter 2 Reagent Overview

Overview .....	2-2
TaqMan® Reagents .....	2-2
SYBR® Green Reagents .....	2-4
Selecting the Appropriate Reagent Type .....	2-6
Minimizing DNA Contaminants .....	2-7

## Chapter 3 Quantitation Experiments

<b>Section 3.1: About Quantitation Experiments .....</b>	<b>3-3</b>
Overview .....	3-4
Select a Quantitation Method .....	3-5
Select 1-Step or 2-Step RT-PCR .....	3-8
Select Singleplex or Multiplex PCR .....	3-10
Select the Reagent Type .....	3-12
Select the Assay Type .....	3-12
<b>Section 3.2: Design Guidelines .....</b>	<b>3-15</b>
Inventoried/Made to Order Assays .....	3-16
TaqMan® Gene Expression Assays .....	3-16

Custom TaqMan® Gene Expression Assays .....	3-18
Select the Master Mix .....	3-19
Design the Experiment .....	3-20
Custom Assays .....	3-21
Design Primers and Probes Using Primer Express® Software .....	3-21
Select the Reagents .....	3-24
Use the Recommended Thermal Cycling Conditions .....	3-27
Optimize Primer Concentrations .....	3-30
Optimize the Probe Concentration .....	3-33
For More Information .....	3-35

## Chapter 4 Genotyping Experiments

<b>Section 4.1: About Genotyping Experiments .....</b>	<b>4-3</b>
Overview .....	4-4
Select the Assay Type .....	4-6
<b>Section 4.2: Design Guidelines .....</b>	<b>4-9</b>
Pre-Designed/Validated Assays .....	4-10
TaqMan® SNP Genotyping Assays .....	4-10
TaqMan® Drug Metabolism Genotyping Assays .....	4-11
Pre-Developed TaqMan® Assay Reagents for Allelic Discrimination .....	4-12
Select the Master Mix .....	4-13
Design the Experiment .....	4-14
Custom Assays .....	4-14
Custom TaqMan® SNP Genotyping Assays .....	4-14
Select the Master Mix .....	4-16
Design the Experiment .....	4-16

## Chapter 5 Presence/Absence Experiments

<b>Section 5.1: About Presence/Absence Experiments .....</b>	<b>5-3</b>
Overview .....	5-4
Select the Assay Type .....	5-6
<b>Section 5.2: Design Guidelines .....</b>	<b>5-9</b>
Inventoried/Made to Order Assays .....	5-10
TaqMan® Gene Expression Assays .....	5-10
Custom TaqMan® Gene Expression Assays .....	5-12
TaqMan® Exogenous Internal Positive Control Reagents .....	5-13
Select the Master Mix .....	5-15
Design the Experiment .....	5-16
Custom Assays .....	5-16

---

## Appendix A Formulas

Standard Deviation Calculation Using the Standard Curve Method . . . . .	A-2
Standard Deviation Calculation Using the Comparative Method . . . . .	A-5
Formula for Comparative $C_T$ ( $\Delta\Delta C_T$ ) Experiments . . . . .	A-7

## Appendix B Primer Limiting in Multiplex PCR

## Appendix C Assay Design Guidelines

## Appendix D Reagent Part Numbers

Quantitation Experiments . . . . .	D-2
Inventoried/Made to Order Assays . . . . .	D-2
Custom Assays . . . . .	D-2
Genotyping Experiments . . . . .	D-5
Pre-Designed/Validated Assays . . . . .	D-5
Custom Assays . . . . .	D-5
Presence/Absence Experiments . . . . .	D-7
Inventoried/Made to Order Assays . . . . .	D-7
Custom Assays . . . . .	D-8

## Bibliography

## Glossary

## Index





# Preface

## How to Use This Guide

**About the System Documentation** The guides listed below are shipped with the Applied Biosystems StepOne™ and StepOnePlus™ Real-Time PCR Systems (StepOne™ and StepOnePlus™ systems).

Guide	Purpose and Audience	PN
<i>Applied Biosystems StepOne™ and StepOnePlus™ Real-Time PCR Systems Getting Started Guide for Genotyping Experiments</i>	Explains how to perform experiments on the StepOne and StepOnePlus systems. Each Getting Started Guide functions as both: <ul style="list-style-type: none"> <li>• A tutorial, using example experiment data provided with the Applied Biosystems StepOne™ Real-Time PCR Software (StepOne™ software).</li> <li>• A guide for your own experiments.</li> </ul>	4376786
<i>Applied Biosystems StepOne™ and StepOnePlus™ Real-Time PCR Systems Getting Started Guide for Presence/Absence Experiments</i>	Intended for laboratory staff and principal investigators who perform experiments using the StepOne or StepOnePlus system.	4376787
<i>Applied Biosystems StepOne™ and StepOnePlus™ Real-Time PCR Systems Getting Started Guide for Relative Standard Curve and Comparative C<sub>T</sub> Experiments</i>		4376785
<i>Applied Biosystems StepOne™ and StepOnePlus™ Real-Time PCR Systems Getting Started Guide for Standard Curve Experiments</i>		4376784
<i>Applied Biosystems StepOne™ and StepOnePlus™ Real-Time PCR Systems Installation, Networking, and Maintenance Guide</i>		4376782
<i>Applied Biosystems StepOne™ and StepOnePlus™ Real-Time PCR Systems Installation Quick Reference Card</i>	Intended for laboratory staff responsible for the installation and maintenance of the StepOne or StepOnePlus system	4376783
<i>Applied Biosystems StepOne™ and StepOnePlus™ Real-Time PCR Systems Reagent Guide</i>	Provides information about the reagents you can use on the StepOne and StepOnePlus systems, including: <ul style="list-style-type: none"> <li>• An introduction to TaqMan® and SYBR® Green reagents</li> <li>• Descriptions and design guidelines for the following experiment types:               <ul style="list-style-type: none"> <li>– Quantitation experiments</li> <li>– Genotyping experiments</li> <li>– Presence/absence experiments</li> </ul> </li> </ul> Intended for laboratory staff and principal investigators who perform experiments using the StepOne or StepOnePlus system.	4379704

Guide	Purpose and Audience	PN
<i>Applied Biosystems StepOne™ and StepOnePlus™ Real-Time PCR Systems Site Preparation Guide</i>	Explains how to prepare your site to receive and install the StepOne and StepOnePlus systems.  Intended for personnel who schedule, manage, and perform the tasks required to prepare your site for installation of the StepOne or StepOnePlus system.	4376768
<i>Applied Biosystems StepOne™ Real-Time PCR Software Help</i>	Explains how to use the StepOne software to: <ul style="list-style-type: none"> <li>• Set up, run, and analyze experiments using the StepOne and StepOnePlus systems.</li> <li>• Monitor networked StepOne and StepOnePlus instruments.</li> <li>• Calibrate StepOne and StepOnePlus instruments.</li> <li>• Verify the performance of StepOne and StepOnePlus instruments with an RNase P run.</li> </ul> Intended for: <ul style="list-style-type: none"> <li>• Laboratory staff and principal investigators who perform experiments using the StepOne or StepOnePlus system.</li> <li>• Laboratory staff responsible for the installation and maintenance of the StepOne or StepOnePlus system.</li> </ul>	NA

**Assumptions** This guide assumes that you:

- Are familiar with the Microsoft Windows® XP operating system.
- Are familiar with the Internet and Internet browsers.
- Know how to handle DNA and/or RNA samples and prepare them for PCR.
- Understand data storage, file transfer, and copying and pasting.
- Have networking experience, if you plan to integrate the StepOne or StepOnePlus system into your existing laboratory data flow.

**Text Conventions** This guide uses the following conventions:

- **Bold** text indicates user action. For example:  
Type **0**, then press **Enter** for each of the remaining fields.
- *Italic* text indicates new or important words and is also used for emphasis.  
For example:  
Before analyzing, *always* prepare fresh matrix.
- A right arrow symbol ( ▶ ) separates successive commands you select from a drop-down or shortcut menu. For example:  
Select **File ▶ Open**.

**User Attention Words** Two user attention words appear in Applied Biosystems user documentation. Each word implies a particular level of observation or action as described below:

**Note:** – Provides information that may be of interest or help but is not critical to the use of the product.

**IMPORTANT!** – Provides information that is necessary for proper instrument operation, accurate reagent kit use, or safe use of a chemical.

Examples of the user attention words appear below:

**Note:** The Calibrate function is also available in the Control Console.

**IMPORTANT!** To verify your client connection, you need a valid user ID.

## How to Obtain More Information

### Related Documentation

#### Other StepOne and StepOnePlus System Documents

The documents listed in the table below are not shipped with the StepOne or StepOnePlus instrument.

Document	PN
<i>Applied Biosystems StepOne™ and StepOnePlus™ Real-Time PCR Systems Installation Performance Verification Protocol</i>	4376791
<i>Applied Biosystems StepOne™ and StepOnePlus™ Real-Time PCR Systems Installation Qualification-Operation Qualification Protocol</i>	4376790
<i>Applied Biosystems StepOne™ and StepOnePlus™ Real-Time PCR Systems Planned Maintenance Protocol</i>	4376788

#### Documents Related to Genotyping Experiments

Document	PN
<i>Allelic Discrimination Pre-Developed TaqMan® Assay Reagents Quick Reference Card</i>	4312212
<i>Custom TaqMan® Genomic Assays Protocol</i>	4367671
<i>Custom TaqMan® SNP Genotyping Assays Protocol</i>	4334431
<i>Ordering TaqMan® SNP Genotyping Assays Quick Reference Card</i>	4374204
<i>Performing a Custom TaqMan® SNP Genotyping Assay for 96-Well Plates Quick Reference Card</i>	4371394
<i>Performing a TaqMan® Drug Metabolism Genotyping Assay for 96-Well Plates Quick Reference Card</i>	4367636
<i>Pre-Developed TaqMan® Assay Reagents Allelic Discrimination Protocol</i>	4312214
<i>TaqMan® Drug Metabolism Genotyping Assays Protocol</i>	4362038
<i>TaqMan® SNP Genotyping Assays Protocol</i>	4332856

### Documents Related to Presence/Absence Experiments

Document	PN
<i>DNA Isolation from Fresh and Frozen Blood, Tissue Culture Cells, and Buccal Swabs Protocol</i>	4343586
<i>NucPrep® Chemistry: Isolation of Genomic DNA from Animal and Plant Tissue Protocol</i>	4333959
<i>PrepMan® Ultra Sample Preparation Reagent Protocol</i>	4318925

### Documents Related to Relative Standard Curve and Comparative C<sub>T</sub> Experiments

Document	PN
<i>Amplification Efficiency of TaqMan® Gene Expression Assays Application Note</i>	127AP05
<i>Applied Biosystems High-Capacity cDNA Reverse Transcription Kits Protocol</i>	4375575
<i>Custom TaqMan® Gene Expression Assays Protocol</i>	4334429
<i>Primer Express® Software Version 3.0 Getting Started Guide</i>	4362460
<i>TaqMan® Gene Expression Assays Protocol</i>	4333458
<i>User Bulletin #2: Relative Quantitation of Gene Expression</i>	4303859

### Documents Related to Standard Curve Experiments

Document	PN
<i>Amplification Efficiency of TaqMan® Gene Expression Assays Application Note</i>	127AP05
<i>Custom TaqMan® Gene Expression Assays Protocol</i>	4334429
<i>Primer Express® Software Version 3.0 Getting Started Guide</i>	4362460
<i>TaqMan® Gene Expression Assays Protocol</i>	4333458
<i>User Bulletin #2: Relative Quantitation of Gene Expression</i>	4303859

## Documents Related to the Reagent Guide

Document	PN
<i>Applied Biosystems High-Capacity cDNA Reverse Transcription Kits Protocol</i>	4375575
<i>Custom TaqMan® Gene Expression Assays Protocol</i>	4334429
<i>Custom TaqMan® Genomic Assays Protocol: Submission Guidelines</i>	4367671
<i>Custom TaqMan® SNP Genotyping Assays Protocol</i>	4334431
<i>Power SYBR® Green PCR Master Mix and RT-PCR Protocol</i>	4367218
<i>Pre-Developed TaqMan® Assay Reagents Allelic Discrimination Protocol</i>	4312214
<i>Primer Express® Software Version 3.0 Getting Started Guide</i>	4362460
<i>SYBR® Green PCR and RT-PCR Reagents Protocol</i>	4304965
<i>SYBR® Green PCR Master Mix and RT-PCR Reagents Protocol</i>	4310251
<i>TaqMan® Drug Metabolism Genotyping Assays Protocol</i>	4362038
<i>TaqMan® Exogenous Internal Positive Control Reagents Protocol</i>	4308335
<i>TaqMan® Fast Universal PCR Master Mix (2X) Protocol</i>	4351891
<i>TaqMan® Gene Expression Assays Protocol</i>	4333458
<i>TaqMan® Gene Expression Master Mix Protocol</i>	4371135
<i>TaqMan® Genotyping Master Mix Protocol</i>	4371131
<i>TaqMan® SNP Genotyping Assays Protocol</i>	4332856
<i>TaqMan® Universal PCR Master Mix Protocol</i>	4304449
<i>User Bulletin #2: Relative Quantitation of Gene Expression</i>	4303859
<i>Using TaqMan® Endogenous Control Assays to Select an Endogenous Control for Experimental Studies Application Note</i>	127AP08

**Note:** For more documentation, see [“How to Obtain Support”](#) on page xii.

### Obtaining Information from the Software Help

The StepOne Software Help describes how to use each feature of the user interface. Access the Help from within the software by doing one of the following:

- Press **F1**.
- Click  in the toolbar.
- Select **Help ▶ StepOne Software Help**.

To find topics of interest in the Help:

- Review the table of contents.
- Search for a specific topic.
- Search an alphabetized index.

## Send Us Your Comments

Applied Biosystems welcomes your comments and suggestions for improving its user documents. You can e-mail your comments to:

[techpubs@appliedbiosystems.com](mailto:techpubs@appliedbiosystems.com)

**IMPORTANT!** The e-mail address above is only for submitting comments and suggestions relating to documentation. To order documents, download PDF files, or for help with a technical question, go to <http://www.appliedbiosystems.com>, then click the link for **Support**. (See “How to Obtain Support” on page Front Matter-xii).

## How to Obtain Support

For the latest services and support information for all locations, go to <http://www.appliedbiosystems.com>, then click the link for **Support**.

At the Support page, you can:

- Search through frequently asked questions (FAQs)
- Submit a question directly to Technical Support
- Order Applied Biosystems user documents, MSDSs, certificates of analysis, and other related documents
- Download PDF documents
- Obtain information about customer training
- Download software updates and patches

In addition, the Support page provides access to worldwide telephone and fax numbers to contact Applied Biosystems Technical Support and Sales facilities.

**IMPORTANT!** When directed to do so by this guide, or when you need to schedule maintenance for your StepOne™ or StepOnePlus™ instrument (such as annual planned maintenance or temperature verification/calibration), contact the Applied Biosystems Care Center. To obtain a phone number for or to send an email to the center, go to <http://www.appliedbiosystems.com/support/contact>.

This chapter covers:

About the StepOne™ and StepOnePlus™ Systems .....	1-2
Supported Consumables .....	1-4
Preparing for Experiments.....	1-6
Select the Experiment Type.....	1-7
Select the Reagent Type .....	1-8
Select the Assay Type .....	1-9

## About the StepOne™ and StepOnePlus™ Systems

There are two models available for this Real-Time PCR System:

System	Features
Applied Biosystems StepOne™ Real-Time PCR System (StepOne™ system)	<ul style="list-style-type: none"> <li>• 48-well platform</li> <li>• Three-color system</li> </ul>
Applied Biosystems StepOnePlus™ Real-Time PCR System (StepOnePlus™ system)	<ul style="list-style-type: none"> <li>• 96-well platform</li> <li>• Four-color system</li> <li>• VeriFlex™ sample blocks</li> </ul>

The StepOne and StepOnePlus systems use fluorescent-based polymerase chain reaction (PCR) reagents to provide:

- Quantitative detection of target nucleic acid sequences (targets) using real-time analysis.
- Qualitative detection of targets using post-PCR (endpoint) analysis.
- Qualitative analysis of the PCR product (achieved by melt curve analysis that occurs post-PCR).

### About Data Collection

The StepOne and StepOnePlus systems collect raw fluorescence data at different points during a PCR, depending on the type of run that the instruments perform:

Run Type		Data Collection Point
Real-time runs	Standard curve	The instrument collects data following each extension step of the PCR.
	Relative standard curve	
	Comparative C <sub>T</sub> ( $\Delta\Delta C_T$ )	
Post-PCR (endpoint) runs	Genotyping	The instrument collects data: <ul style="list-style-type: none"> <li>• Before the PCR (For presence/absence experiments, data collection before the PCR is optional, but recommended.)</li> <li>• (Optional) During the PCR. The instrument can collect data during the run (real-time); collecting data during the run can be helpful for troubleshooting.</li> <li>• After the PCR</li> </ul>
	Presence/absence	

Regardless of the run type, a data collection point or *read* on the StepOne™ or StepOnePlus™ instrument consists of three phases:

1. **Excitation** – The instrument illuminates all wells of the reaction plate within the instrument, exciting the fluorophores in each reaction.



2. **Emission** – The instrument optics collect the residual fluorescence emitted from the wells of the reaction plate. The resulting image collected by the device consists only of light that corresponds to the range of emission wavelengths.
3. **Collection** – The instrument assembles a digital representation of the residual fluorescence collected over a fixed time interval. The StepOne™ software stores the raw fluorescent image for analysis.

After a run, the StepOne software uses calibration data (spatial, dye, and background) to determine the location and intensity of the fluorescent signals in each read, the dye associated with each fluorescent signal, and the significance of the signal.

**About the Filters** The StepOne and StepOnePlus systems use the following filters:

StepOne system		StepOnePlus system	
Filter	Dye	Filter	Dye
1	FAM™ dye	1	FAM™ dye
	SYBR® Green dye		SYBR® Green dye
2	JOE™ dye	2	JOE™ dye
	VIC® dye		VIC® dye
3	ROX™ dye	3	TAMRA™ dye
			NED™ dye
		4	ROX™ dye

### About the VeriFlex™ Technology

The StepOnePlus instrument contains six independently thermally regulated VeriFlex™ blocks to help you optimize your thermal cycling conditions. You can set a different temperature for one or more of the VeriFlex blocks, creating up to six different zones for samples, or you can set the same temperature for each of the VeriFlex blocks.

### For More Information

For more information about any of the topics discussed in this guide, access the Help from within Applied Biosystems StepOne™ Real-Time PCR Software v2.0 by pressing **F1**, clicking  in the toolbar, or selecting **Help ▶ StepOne Software Help**.

# Supported Consumables

**StepOne System** The StepOne system supports the consumables listed below. These consumables are for use with both standard and Fast reagents/protocols.

**IMPORTANT!** Use only Fast consumables (reaction plates, tube strips, and tubes) with the StepOne and StepOnePlus systems, even when performing an experiment with standard reagents.

Consumable	Part Number
<ul style="list-style-type: none"> <li>• MicroAmp™ Fast Optical 48-Well Reaction Plate</li> <li>• MicroAmp™ 48-Well Optical Adhesive Film</li> </ul>	<ul style="list-style-type: none"> <li>• 4375816</li> <li>• 4375323 and 4375928</li> </ul>
<ul style="list-style-type: none"> <li>• MicroAmp™ Fast 8-Tube Strip</li> <li>• MicroAmp™ Optical 8-Cap Strip</li> </ul>	<ul style="list-style-type: none"> <li>• 4358293</li> <li>• 4323032</li> </ul>
<ul style="list-style-type: none"> <li>• MicroAmp® Fast Reaction Tube with Cap</li> </ul>	<ul style="list-style-type: none"> <li>• 4358297</li> </ul>
<ul style="list-style-type: none"> <li>• MicroAmp™ Fast 48-Well Tray</li> <li>• MicroAmp™ 48-Well Base Adaptor</li> <li>• MicroAmp™ 96-Well Support Base</li> </ul>	<ul style="list-style-type: none"> <li>• 4375282</li> <li>• 4375284</li> <li>• 4379590</li> </ul>

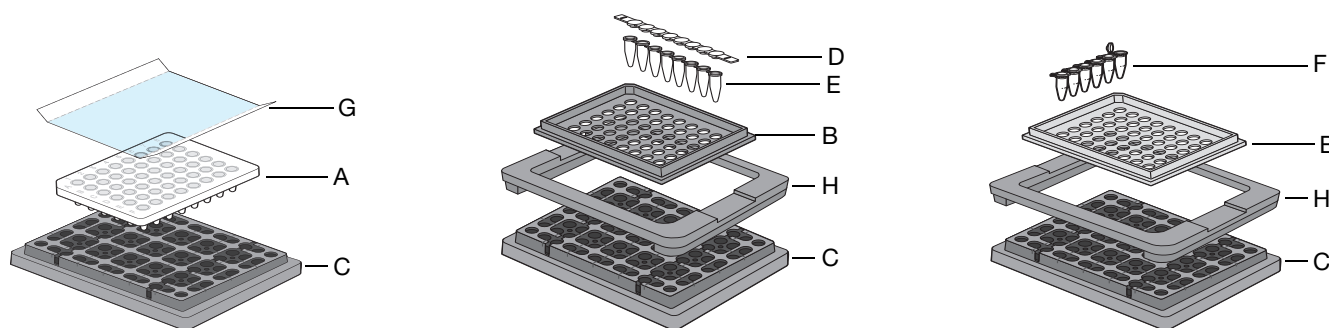

#	Consumable
A	MicroAmp™ Fast Optical 48-Well Reaction Plate
B	MicroAmp™ Fast 48-Well Tray
C	MicroAmp™ 96-Well Support Base
D	MicroAmp™ Optical 8-Cap Strip
E	MicroAmp™ Fast 8-Tube Strip
F	MicroAmp® Fast Reaction Tube with Cap
G	MicroAmp™ 48-Well Optical Adhesive Film
H	MicroAmp™ 48-Well Base Adaptor

## StepOnePlus System

The StepOnePlus system supports the consumables listed below. These consumables are for use with both standard and Fast reagents/protocols.

**IMPORTANT!** Use only Fast consumables (reaction plates, tube strips, and tubes) with the StepOne and StepOnePlus systems, even when performing an experiment with standard reagents.

Consumable	Part Number
<ul style="list-style-type: none"> <li>• MicroAmp™ Fast Optical 96-Well Reaction Plate with Barcode</li> <li>• MicroAmp™ Optical Adhesive Film</li> </ul>	<ul style="list-style-type: none"> <li>• 4346906 and 4366932</li> <li>• 4360954 and 4311971</li> </ul>
<ul style="list-style-type: none"> <li>• MicroAmp™ Fast 8-Tube Strip</li> <li>• MicroAmp™ Optical 8-Cap Strip</li> </ul>	<ul style="list-style-type: none"> <li>• 4358293</li> <li>• 4323032</li> </ul>
<ul style="list-style-type: none"> <li>• MicroAmp® Fast Reaction Tube with Cap</li> </ul>	<ul style="list-style-type: none"> <li>• 4358297</li> </ul>
<ul style="list-style-type: none"> <li>• MicroAmp™ 96-Well Tray for VeriFlex™ Blocks</li> <li>• MicroAmp™ 96-Well Support Base</li> </ul>	<ul style="list-style-type: none"> <li>• 4379983</li> <li>• 4379590</li> </ul>
<ul style="list-style-type: none"> <li>• MicroAmp™ Adhesive Film Applicator</li> <li>• MicroAmp™ Cap Installing Tool (Handle)</li> </ul>	<ul style="list-style-type: none"> <li>• 4333183</li> <li>• 4330015</li> </ul>

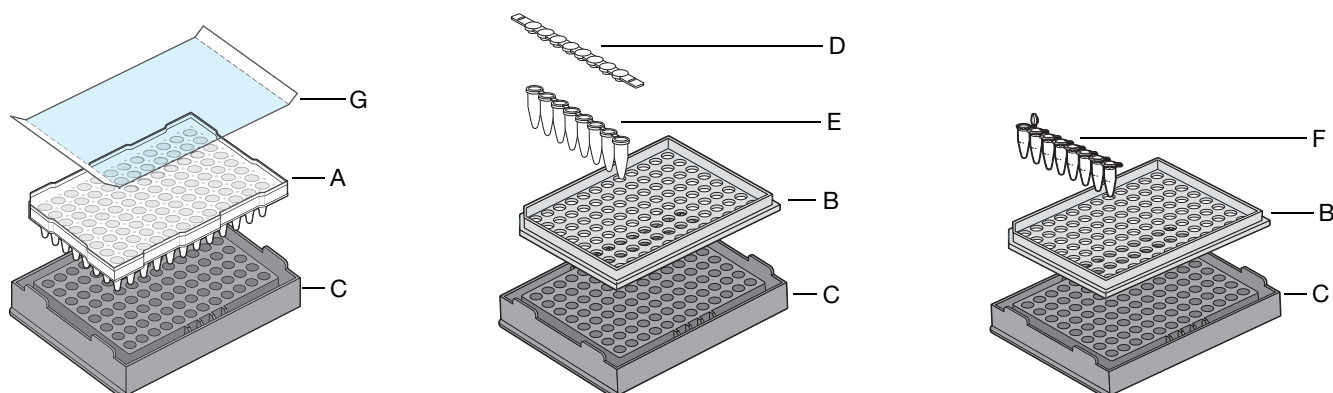

#	Consumable
A	MicroAmp™ Fast Optical 96-Well Reaction Plate
B	MicroAmp™ 96-Well Tray for VeriFlex™ Blocks
C	MicroAmp™ 96-Well Support Base
D	MicroAmp™ Optical 8-Cap Strip
E	MicroAmp™ Fast 8-Tube Strip
F	MicroAmp® Fast Reaction Tube with Cap
G	MicroAmp™ Optical Adhesive Film

# Preparing for Experiments

**General Workflow** Before performing experiments on the StepOne and StepOnePlus systems, prepare for the experiment as follows:

1. Select an experiment type ([page 1-7](#)).
2. Select the reagent type ([page 1-8](#)).
3. Select the assay type ([page 1-9](#)).

**Information in This Guide** This chapter provides general information on the experiment types, reagent types, and assay types you can use with the StepOne and StepOnePlus systems.

Subsequent chapters provide specific information:

Chapter	Description
<a href="#">Chapter 2, Reagent Overview</a>	<ul style="list-style-type: none"> <li>• Describes and compares the TaqMan® and SYBR® Green reagents.</li> <li>• Provides information on minimizing DNA contamination.</li> </ul>
<a href="#">Chapter 3, Quantitation Experiments</a>	<ul style="list-style-type: none"> <li>• Explains how the experiment type works.</li> <li>• Provides a specific workflow for the experiment type.</li> <li>• Provides design guidelines for each assay type.</li> </ul>
<a href="#">Chapter 4, Genotyping Experiments</a>	
<a href="#">Chapter 5, Presence/Absence Experiments</a>	

## Select the Experiment Type

In this guide, the term *experiment* refers to the entire process of performing a run using the StepOne or StepOnePlus system, including setup, run and analysis. You can perform the following types of experiments on the StepOne and StepOnePlus systems:

- Quantitation, including:
  - Standard curve
  - Relative standard curve
  - Comparative  $C_T$  ( $\Delta\Delta C_T$ )
- Genotyping
- Presence/absence

**Note:** You can also perform melt curve analysis on the StepOne and StepOnePlus systems. For more information, access the Help from within the StepOne software by clicking  in the toolbar or pressing **F1**.

### Endpoint vs. Real-Time Experiments

The three experiment types can be categorized as real-time or endpoint experiments, as described below.

Category	Properties	Experiment Type
Real-time	<ul style="list-style-type: none"> <li>• The instrument monitors the progress of the PCR as it occurs.‡</li> <li>• Data are collected throughout the PCR process.</li> <li>• Reactions are characterized by the point in time during cycling when amplification of a target is first detected.§</li> </ul>	Quantitation
Endpoint	<ul style="list-style-type: none"> <li>• Data are collected at the end of the PCR process.</li> <li>• Reactions are characterized by the quantity of the target accumulated at the end of PCR.§</li> <li>• The datapoint is the normalized intensity of the reporter dye, or <math>R_n</math>.</li> </ul> <p><b>Note:</b> Some endpoint experiments also include pre-PCR datapoints. If so, the system calculates the delta <math>R_n</math> (<math>\Delta R_n</math>) value per the following formula:  <math display="block">\Delta R_n = R_n \text{ (post-PCR read)} - R_n \text{ (pre-PCR read)}</math>           where <math>R_n</math> = normalized reporter</p>	Genotyping
		Presence/absence

‡ Kwok and Higuchi, 1989.

§ Saiki *et al.*, 1985.

## Select the Reagent Type

You can use the following reagent types (chemistries) on the StepOne and StepOnePlus systems:

- TaqMan<sup>®</sup> reagents
- SYBR<sup>®</sup> Green reagents
- Other fluorescent-based reagents

### TaqMan Reagents

TaqMan reagents include Applied Biosystems TaqMan<sup>®</sup> assays (preformulated mixes that contain probe and primer sets) and Applied Biosystems TaqMan<sup>®</sup> master mixes. You can use TaqMan reagents for the following experiment types:

- Quantitation, including:
  - Standard curve
  - Relative standard curve
  - Comparative C<sub>T</sub> ( $\Delta\Delta C_T$ )
- Genotyping
- Presence/absence

**IMPORTANT!** Applied Biosystems does not recommend the use of TAMRA<sup>™</sup> dye as a reporter or quencher with the StepOne system. TAMRA dye may be used as a reporter or quencher with the StepOnePlus system.

### SYBR Green Reagents

SYBR Green reagents include primers and master mixes that contain SYBR<sup>®</sup> Green dye. You can use SYBR Green reagents for quantitation experiments:

- Standard curve
- Relative standard curve
- Comparative C<sub>T</sub> ( $\Delta\Delta C_T$ )

**Note:** You cannot perform multiplex PCR using SYBR Green reagents. For more information, see [“Select Singleplex or Multiplex PCR” on page 3-10](#).

### Other Reagents

You can use other fluorescent-based reagents on the StepOne and StepOnePlus systems, but note the following when using the StepOne software:

- You must design your experiment using Advanced Setup instead of the Design Wizard.
- For Applied Biosystems TaqMan and SYBR Green reagents, the StepOne software automatically calculates reaction volumes in the Reaction Setup screen.

## Select the Assay Type

In the StepOne software, you can select the following assay types for quantitation, presence/absence, and genotyping experiments:

Experiment Type	Assay Type	See...
Quantitation‡	<ul style="list-style-type: none"> <li>Inventoried/Made to Order</li> <li>Custom</li> </ul>	below
Presence/absence		
Genotyping	<ul style="list-style-type: none"> <li>Pre-Designed/Validated</li> <li>Custom</li> <li>User-Designed</li> </ul>	<a href="#">page 1-10</a>

‡ Quantitation experiments include standard curve, relative standard curve, and comparative C<sub>T</sub> experiments.

### Quantitation and Presence/Absence Experiments

#### Inventoried/Made to Order Assays

For quantitation or presence/absence experiments, select the Inventoried/Made to Order assay type in the StepOne software if you are using:

- **TaqMan® Gene Expression Assays, Inventoried** – Predesigned FAM™ dye-labeled TaqMan® MGB (minor groove binder) probe and primer sets that can be purchased off-the-shelf. The assay mix is available in a single, preformulated 20X tube.
- **TaqMan® Gene Expression Assays, Made to Order** – Predesigned FAM dye-labeled TaqMan MGB probe and primer sets that are manufactured at the time of order. The assay mix is available in a single, preformulated 20X tube.
- **Custom TaqMan® Gene Expression Assays** – FAM dye-labeled TaqMan MGB probe and primer sets that are designed, synthesized, and formulated by the Custom TaqMan® Genomic Assays service based on sequence information that you submit. The assay mix is available in a single, preformulated 20X or 60X tube.

**Note:** To select the assay type in the StepOne software, go to the Reaction Setup screen in either the Design Wizard or Advanced Setup, then select **Inventoried/Made to Order** from the Assay Type dropdown menu.

#### Custom Assays

For quantitation and presence/absence experiments, select the Custom assay type in the StepOne software if you are designing your own assays (primers and probes) with Primer Express® Software and TaqMan or SYBR Green reagents. When designing your own assays, follow the Applied Biosystems Assay Design Guidelines to optimize results.

**IMPORTANT!** Applied Biosystems does not recommend the use of TAMRA™ dye as a reporter or quencher with the StepOne system. TAMRA dye may be used as a reporter or quencher with the StepOnePlus system.

**Note:** To select the assay type in the StepOne software, go to the Reaction Setup screen in either the Design Wizard or Advanced Setup, then select **Custom** from the Assay Type dropdown menu.

## Genotyping Experiments

### Pre-Designed/Validated Assays

For genotyping experiments, the Pre-Designed/Validated assay type includes:

- **TaqMan<sup>®</sup> SNP Genotyping Assays** – Predesigned FAM<sup>™</sup> dye- and VIC<sup>®</sup> dye-labeled TaqMan<sup>®</sup> MGB (minor groove binder) probes and primer sets that are available as TaqMan<sup>®</sup> Pre-Designed SNP Genotyping Assays. The TaqMan Pre-Designed SNP Genotyping Assays are manufactured at the time of order (Made to Order). The assay mix is available in a single, preformulated 20X tube.
- **TaqMan<sup>®</sup> Drug Metabolism Genotyping Assays** – Predesigned FAM dye- and VIC dye-labeled TaqMan MGB probes and primer sets that can be purchased off-the-shelf (Inventoried). The assay mix is available in a single, preformulated 20X tube.
- **Pre-Developed TaqMan<sup>®</sup> Assay Reagents for Allelic Discrimination (TaqMan<sup>®</sup> PDARs for AD)** – Predesigned FAM dye- and VIC dye-labeled TaqMan MGB probes and primer sets that can be purchased off-the-shelf (Inventoried). The assay mix is available in a single, preformulated 10X tube.

**Note:** To select a SNP assay in the StepOne software, go to the SNP Assays screen in the Design Wizard or to the Plate Setup screen in Advanced Setup. In the SNP Assays screen or Plate Setup screen, select an assay from the library or create a new assay.

### Custom Assays

For genotyping experiments, the Custom assay type includes the Custom TaqMan<sup>®</sup> SNP Genotyping Assays. The Custom TaqMan SNP Genotyping Assays are FAM dye- and VIC dye-labeled TaqMan MGB probes and primer sets that are designed, synthesized, and formulated by the Custom TaqMan<sup>®</sup> Genomic Assays service based on sequence information that you submit. The assay mix is available in a single, preformulated 40X or 80X tube.

**Note:** To select a SNP assay in the StepOne software, go to the SNP Assays screen in the Design Wizard or to the Plate Setup screen in Advanced Setup. In the SNP Assays screen or Plate Setup screen, you can select an assay from the library or create a new assay.

### User-Designed Assays

If you want to design your own primers and probes for SNP assays, refer to the *Primer Express<sup>®</sup> Software Version 3.0 Getting Started Guide*.

**IMPORTANT!** Applied Biosystems does not recommend the use of TAMRA<sup>™</sup> dye as a reporter or quencher with the StepOne system. TAMRA dye may be used as a reporter or quencher with the StepOnePlus system.



This chapter covers:

Overview .....	2-2
TaqMan® Reagents .....	2-2
SYBR® Green Reagents .....	2-4
Selecting the Appropriate Reagent Type .....	2-6
Minimizing DNA Contaminants .....	2-7

## Overview

Applied Biosystems has developed two reagent types (chemistries) that can be used to detect PCR products on the Applied Biosystems StepOne™ and StepOnePlus™ Real-Time PCR Systems:

- TaqMan® reagents (below)
- SYBR® Green reagents ([page 2-4](#))

## TaqMan® Reagents

### Experiment Types

TaqMan® reagents include Applied Biosystems TaqMan® assays (preformulated mixes that contain probe and primer sets) and Applied Biosystems TaqMan® master mixes. The assays are specific to the target of interest. The master mixes contain the remaining components needed for the PCR reaction. You can use TaqMan reagents for the following experiment types:

- Quantitation, including:
  - Standard curve
  - Relative standard curve
  - Comparative C<sub>T</sub> ( $\Delta\Delta C_T$ )
- Genotyping
- Presence/absence

**IMPORTANT!** Applied Biosystems does not recommend the use of TAMRA™ dye as a reporter or quencher with the StepOne system. TAMRA dye may be used as a reporter or quencher with the StepOnePlus system.

### Development of TaqMan Reagents

Initially, intercalator dyes were used to measure real-time PCR products. The primary disadvantage of this detection method is that it detects accumulation of both specific and nonspecific PCR products.

Real-time systems for PCR were improved by the introduction of fluorogenic-labeled probes that use the 5' nuclease activity of Taq DNA polymerase. The availability of these fluorogenic probes enabled the development of a real-time method for detecting only specific amplification products.

### How the TaqMan Reagents Work

TaqMan reagents use a fluorogenic probe to detect a specific PCR product as it accumulates during the PCR. Here is how it works:

**Step 1** – An oligonucleotide probe is constructed with a fluorescent reporter dye bound to the 5' end and a quencher on the 3' end.

**Step 2** – While the probe is intact, the proximity of the quencher greatly reduces the fluorescence emitted by the reporter dye by fluorescence resonance energy transfer (FRET; Förster resonance) (Förster, V. T. 1948) through space.

**Step 3** – If the target is present, the probe anneals between primer sites and is cleaved by the 5' nuclease activity of Taq DNA polymerase during extension. Cleavage of the probe:

- Separates the reporter dye from the quencher, increasing the reporter dye signal.
- Removes the probe from the target strand, allowing primer extension to continue to the end of the template strand. Thus, inclusion of the probe does not inhibit the overall PCR process.

**Step 4** – More reporter dye molecules are cleaved from their respective probes with each cycle, resulting in an increase in fluorescence intensity proportional to the quantity of amplicon produced. The higher the starting copy number of the nucleic acid target, the earlier a significant increase in fluorescence is observed.

Figure 2-1 illustrates this process.

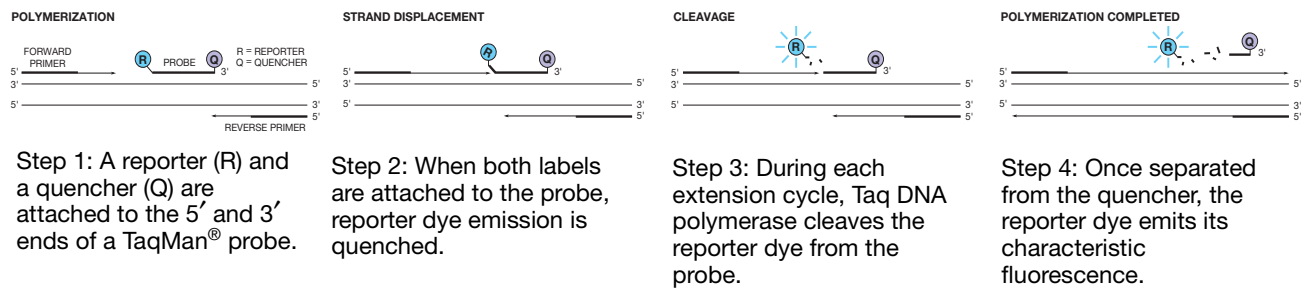

Figure 2-1 How the TaqMan reagents work

### TaqMan<sup>®</sup> Probes

Applied Biosystems offers two types of TaqMan<sup>®</sup> probes:

- TaqMan<sup>®</sup> MGB (minor groove-binder) probes with non fluorescent quencher (NFQ)
- TaqMan<sup>®</sup> probes with TAMRA<sup>™</sup> dye as quencher

**IMPORTANT!** Applied Biosystems does not recommend the use of TAMRA dye as a reporter or quencher with the StepOne system. TAMRA dye may be used as a reporter or quencher with the StepOnePlus system.

Applied Biosystems offers the following TaqMan probes for use on the StepOne system or the StepOnePlus system:

Probe	Assays	5' Label Dye	3' Label Dye	MGB?	System	
TaqMan <sup>®</sup> MGB probe	TaqMan <sup>®</sup> Gene Expression Assays	FAM <sup>™</sup> dye	NFQ	Yes	StepOne and StepOne Plus systems	
	TaqMan <sup>®</sup> SNP Genotyping Assays	FAM <sup>™</sup> and VIC <sup>®</sup> dyes				
TaqMan <sup>®</sup> MGB probe	Custom TaqMan <sup>®</sup> Gene Expression Assays	FAM <sup>™</sup> dye	NFQ	Yes		StepOne and StepOne Plus systems
	Custom TaqMan <sup>®</sup> SNP Genotyping Assays	FAM <sup>™</sup> and VIC <sup>®</sup> dyes				
Custom TaqMan <sup>®</sup> MGB Probe	Custom assays	FAM <sup>™</sup> , TET <sup>™</sup> , NED <sup>™</sup> , or VIC <sup>®</sup> dye	NFQ	Yes	StepOne and StepOne Plus systems	
Custom TaqMan <sup>®</sup> Probe	Custom assays	FAM <sup>™</sup> , TET <sup>™</sup> or VIC <sup>®</sup> dye				

### TaqMan MGB Probes Recommended

Applied Biosystems recommends the general use of TaqMan MGB probes, especially when conventional TaqMan probes exceed 30 nucleotides. The TaqMan MGB probes contain:

- **A fluorescent reporter dye at the 5' end** – Generates a signal when cleaved by the 5' nuclease activity of Taq DNA polymerase.
- **A nonfluorescent quencher (NFQ) at the 3' end** – Allows Real-Time PCR Systems to measure the reporter dye contributions more precisely than probes with TAMRA dye because the quencher does not fluoresce.
- **A minor groove binder (MGB) at the 3' end** – Increases the melting temperature ( $T_m$ ) of probes without increasing probe length (Afonina *et al.*, 1997; Kutuyavin *et al.*, 1997), thereby allowing the design of shorter probes. Consequently, the TaqMan MGB probes exhibit greater differences in  $T_m$  values between matched and mismatched probes; greater differences in  $T_m$  values provide accurate genotyping.

## SYBR<sup>®</sup> Green Reagents

**Experiment Types** SYBR<sup>®</sup> Green reagents include primers and master mixes that contain SYBR<sup>®</sup> Green dye. You can use SYBR Green reagents for quantitation experiments:

- Standard curve
- Relative standard curve
- Comparative  $C_T$  ( $\Delta\Delta C_T$ )

**Note:** You cannot perform multiplex PCR using SYBR Green reagents. For more information, see [“Select Singleplex or Multiplex PCR” on page 3-10.](#)

## Development of SYBR Green Reagents

Small molecules that bind to double-stranded DNA can be divided into two classes: those that intercalate DNA and those that bind the minor groove of DNA. Higuchi (Higuchi *et al.*, 1992) used the intercalator ethidium bromide for real-time detection of PCR. Hoechst 33258 is an example of a minor groove-binding dye whose fluorescence increases when bound to double-stranded DNA (Higuchi *et al.*, 1993).

Regardless of the binding method, there are at least two requirements for a DNA binding dye for real-time detection of PCR products:

- Increased fluorescence when bound to double-stranded DNA
- No inhibition of PCR

Applied Biosystems has developed conditions that permit the use of the SYBR<sup>®</sup> Green I dye in PCR without PCR inhibition and with increased sensitivity of detection compared with ethidium bromide.

## How the SYBR Green Reagents Work

The SYBR Green reagents use the SYBR Green I dye to detect PCR products by binding to double-stranded DNA formed during the PCR. Here is how it works:

**Step 1** – When added to a sample, SYBR Green I dye immediately binds to all double-stranded DNA.

**Step 2** – During the PCR, AmpliTaq Gold<sup>®</sup> DNA Polymerase amplifies the target, which creates the PCR product, or “amplicon.” The double-stranded DNA is denatured to single-stranded molecules and the SYBR Green I dye is released.

**Step 3** – The primers anneal to the single-stranded DNA and the AmpliTaq Gold DNA Polymerase amplifies the target, creating more double stranded DNA. As the PCR progresses, more amplicon is created.

**Step 4** – The SYBR Green I dye then binds to each new copy of double-stranded DNA that is generated during each PCR cycle. Since the SYBR Green I dye binds to all double-stranded DNA, the result is an increase in fluorescence intensity proportional to the quantity of double-stranded PCR product produced.

Figures 2-2 below illustrates this process.

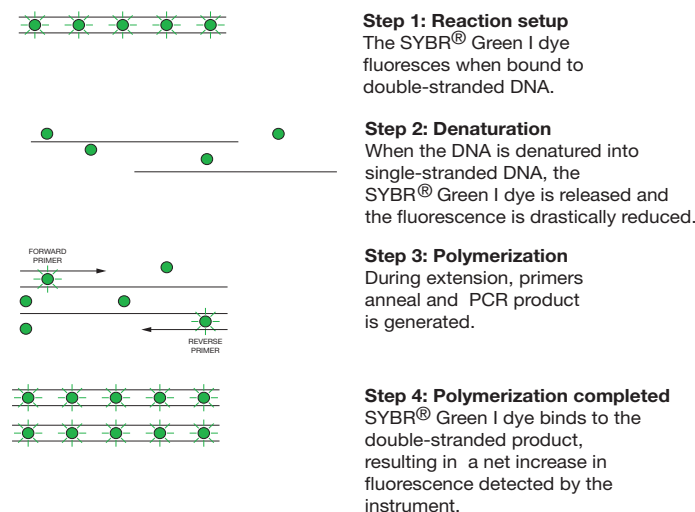

Figure 2-2 How the SYBR Green reagents work

## Selecting the Appropriate Reagent Type

The TaqMan and SYBR Green reagents can be used for the experiment types listed below.

Reagent Type	Experiment Type		
	Quantitation <sup>‡</sup> (Chapter 3)	Genotyping (Chapter 4)	Presence/ Absence (Chapter 5)
SYBR <sup>®</sup> Green reagents	Yes	Not recommended	Not recommended
TaqMan <sup>®</sup> reagents	Yes	Yes	Yes

<sup>‡</sup> Includes standard curve, relative standard curve, and comparative C<sub>T</sub> experiments.

**IMPORTANT!** Applied Biosystems does not recommend the use of TAMRA<sup>™</sup> dye as a reporter or quencher with the StepOne system. TAMRA dye may be used as a reporter or quencher with the StepOnePlus system.

### Considerations for Quantitation Experiments

Quantitation experiments can be performed with either TaqMan or SYBR Green reagents. Consider the following when choosing between the two reagent types:

Reagent Type	Description	Advantage	Limitation
TaqMan <sup>®</sup> reagents	TaqMan reagents use a fluorogenic probe to enable detection of a specific PCR product as it accumulates during PCR cycles.	<ul style="list-style-type: none"> <li>Provides increased specificity with the addition of a fluorogenic probe.</li> <li>Provides multiplex capability.</li> <li>Includes preformulated assays, optimized to run under universal thermal cycling conditions.</li> <li>Can be used for either 1- or 2-step RT-PCR.</li> </ul>	Requires synthesis of a unique fluorogenic probe.
SYBR <sup>®</sup> Green reagents	SYBR Green reagents use SYBR <sup>®</sup> Green I dye, a double-stranded DNA binding dye, to detect PCR products as they accumulate during PCR cycles.	<ul style="list-style-type: none"> <li>Is economical (no probe needed).</li> <li>Allows for melt curve analysis to measure the T<sub>m</sub> of all PCR products.</li> <li>Can be used for either 1- or 2-step RT-PCR.</li> </ul>	Binds nonspecifically to all double-stranded DNA sequences. To avoid false positive signals, check for nonspecific product formation using melt curve or gel analysis.

## Minimizing DNA Contaminants

The DNA amplification capability of the PCR process makes special laboratory practices necessary when you perform experiments using TaqMan or SYBR Green reagents. Potential contamination can be introduced by samples with high DNA concentrations, either from the DNA template controls or from PCR carryover.

In addition, due to the nonspecific nature of the SYBR Green I dye, any double-stranded DNA will be detected. When using SYBR Green reagents, check for nonspecific product formation by using melt curve or gel analysis. Take care to avoid contamination with target DNA. Gene expression assays that span exon-exon junctions minimize the effect of gDNA (genomic DNA) contaminants.

### Using UNG to Minimize Reamplification of Carryover Products

AmpErase<sup>®</sup> uracil-N-glycosylase (UNG) is a 26-kDa recombinant enzyme encoded by the *Escherichia coli* uracil-N-glycosylase gene. This gene has been inserted into an *E. coli* host to direct expression of the native form of the enzyme (Kwok and Higuchi, 1989).

UNG acts on single- and double-stranded dU-containing DNA. It acts by hydrolyzing uracil-glycosidic bonds at dU-containing DNA sites. The enzyme causes the release of uracil, thereby creating an alkali-sensitive apyrimidic site in the DNA. The enzyme has no activity on RNA or dT-containing DNA (Longo *et al.*, 1990).

#### TaqMan Assays

For TaqMan<sup>®</sup> assays, AmpErase<sup>®</sup> UNG treatment can prevent the reamplification of carryover PCR products from previous PCR reactions. When dUTP replaces dTTP in PCR amplification, AmpErase UNG treatment can remove up to 200,000 copies of amplicon per 50- $\mu$ L reaction.

**Note:** AmpErase UNG (also abbreviated as UDG for uracil-DNA-glycosylase) is included in some Applied Biosystems TaqMan master mix formulations and can also be purchased individually. When purchasing TaqMan master mixes, check the product information to see if the master mix contains AmpErase UNG.

#### SYBR Green I Dye Assays

For SYBR Green I dye assays, AmpErase UNG treatment can prevent the reamplification of carryover PCR products from previous PCR reactions. Although Power SYBR<sup>®</sup> Green PCR Master Mix and SYBR<sup>®</sup> Green PCR Master Mix do not contain AmpErase UNG, they contain dUTP and are thus compatible with AmpErase UNG. If contamination from PCR carryover is suspected, use AmpErase UNG to troubleshoot the problem.

**Note:** AmpErase UNG can be purchased individually or as part of the SYBR<sup>®</sup> Green PCR Core Reagents kit.

### **General PCR Practices**

Use the following precautions to minimize sample contamination and PCR product carryover:

- Wear a clean lab coat (not previously worn while handling amplified PCR products or used during sample preparation) and clean gloves when preparing samples for PCR amplification. Change gloves whenever you suspect that they are contaminated.
- Maintain separate areas, dedicated equipment, and supplies for:
  - Sample preparation.
  - PCR setup. Never bring amplified PCR products into the PCR setup area.
  - PCR amplification.
  - Analysis of PCR products.
- Open and close all sample tubes carefully. Avoid splashing or spraying PCR samples.
- Use positive-displacement or air-displacement pipettors with filter-plugged tips. Change tips after each use.
- Keep reactions and components capped as much as possible.
- Clean lab benches and equipment periodically with 10% bleach solution or 70% ethanol.



# Quantitation Experiments

---

# 3

This chapter covers:

Section 3.1 About Quantitation Experiments .....	3-3
Section 3.2 Design Guidelines .....	3-15



## Section 3.1 About Quantitation Experiments

---

This section covers:

Overview .....	3-4
Select a Quantitation Method .....	3-5
Select 1-Step or 2-Step RT-PCR .....	3-8
Select Singleplex or Multiplex PCR .....	3-10
Select the Reagent Type .....	3-12
Select the Assay Type .....	3-12

## Overview

### What Is a Quantitation Experiment?

A quantitation experiment is a real-time experiment that measures the quantity of a target nucleic acid sequence (target) during each amplification cycle of the polymerase chain reaction (PCR). The target can be DNA, cDNA, or RNA.

Three types of quantitation experiments are discussed in this guide:

- Standard curve ([page 3-5](#))
- Relative standard curve ([page 3-5](#))
- Comparative  $C_T$  ( $\Delta\Delta C_T$ ) ([page 3-6](#))

### How Quantitation Experiments Work

In real-time quantitation experiments, the reactions are characterized by the point in time during cycling when amplification of a PCR product achieves a fixed level of fluorescence, rather than the final quantity of PCR product accumulated after a fixed number of cycles. An amplification plot graphically displays the fluorescence detected over the number of cycles that were performed.

In the initial cycles of PCR, there is no significant change in fluorescence signal. This predefined range of PCR cycles is called the *baseline*. First, the software generates a baseline-subtracted amplification plot by calculating a mathematical trend of the normalized fluorescent reporter signal ( $R_n$  values corresponding to the baseline cycles). Then, an algorithm searches for the point on the amplification plot at which the baseline-corrected normalized fluorescent reporter signal ( $\Delta R_n$  value) crosses a set threshold. The cycle at which the  $\Delta R_n$  value crosses the threshold is defined as the  $C_T$ .

### Workflow

Before performing quantitation experiments on the Applied Biosystems StepOne and StepOnePlus™ Real-Time PCR Systems, prepare for the experiment as follows:

1. Select a quantitation method ([page 3-5](#)).
2. Select 1- or 2-step RT-PCR ([page 3-8](#)).
3. Select singleplex or multiplex PCR reactions ([page 3-10](#)).
4. Select the reagent type ([page 3-12](#)).
5. Select the assay type ([page 3-12](#)).
6. Review the design guidelines for the assay type you selected ([Section 3.2 on page 3-15](#)).

## Select a Quantitation Method

### About Standard Curve Experiments

The standard curve method is used to determine the absolute target quantity in samples. With the standard curve method, the StepOne software measures amplification of the target in samples and in a standard dilution series. Data from the standard dilution series are used to generate the standard curve. Using the standard curve, the software interpolates the absolute quantity of target in the samples.

#### Components

The following components are required when setting up PCR reactions for standard curve experiments:

- **Sample** – The sample in which the quantity of the target is unknown.
- **Standard** – A sample that contains known standard quantities; used in quantitation experiments to generate standard curves.
- **Standard dilution series** – A set of standards containing a range of known quantities. The standard dilution series is prepared by serially diluting standards.
- **Replicates** – The total number of identical reactions containing identical samples, components, and volumes.
- **Negative Controls** – Wells that contain water or buffer instead of sample template. No amplification of the target should occur in negative control wells.

### About Relative Standard Curve Experiments

The relative standard curve method is used to determine relative target quantity in samples. With the relative standard curve method, the StepOne software measures amplification of the target and of the endogenous control in samples, in a reference sample, and in a standard dilution series. Measurements are normalized using the endogenous control. Data from the standard dilution series are used to generate the standard curve. Using the standard curve, the software interpolates target quantity in the samples and in the reference sample. The software determines the relative quantity of target in each sample by comparing target quantity in each sample to target quantity in the reference sample.

Relative standard curve experiments are commonly used to:

- Compare expression levels of a gene in different tissues.
- Compare expression levels of a gene in a treated sample vs. an untreated sample.
- Compare expression levels of wild-type alleles vs. mutated alleles.

#### Components

The following components are required when setting up PCR reactions for relative standard curve experiments:

- **Sample** – The sample in which the quantity of the target is unknown.
- **Reference sample** – The sample used as the basis for relative quantitation results. For example, in a study of drug effects on gene expression, an untreated control would be an appropriate reference sample. Also called *calibrator*.

- **Standard** – A sample that contains known standard quantities; used in quantitation experiments to generate standard curves.
- **Standard dilution series** – A set of standards containing a range of known quantities. The standard dilution series is prepared by serially diluting standards.
- **Endogenous control** – A target or gene that should be expressed at similar levels in all samples you are testing. The endogenous control is used to normalize fluorescence signals for the target you are quantifying. Housekeeping genes can be used as endogenous controls.
- **Replicates** – The total number of identical reactions containing identical samples, components, and volumes.
- **Negative Controls** – Wells that contain water or buffer instead of sample template. No amplification of the target should occur in negative control wells.

### About Comparative $C_T$ Experiments

The comparative  $C_T$  ( $\Delta\Delta C_T$ ) method is used to determine the relative target quantity in samples. With the comparative  $C_T$  method, the StepOne software measures amplification of the target and of the endogenous control in samples and in a reference sample. Measurements are normalized using the endogenous control. The software determines the relative quantity of target in each sample by comparing normalized target quantity in each sample to normalized target quantity in the reference sample.

Comparative  $C_T$  experiments are commonly used to:

- Compare expression levels of a gene in different tissues.
- Compare expression levels of a gene in a treated sample vs. an untreated sample.
- Compare expression levels of wild-type alleles vs. mutated alleles.

### Components

The following components are required when setting up PCR reactions for comparative  $C_T$  experiments:

- **Sample** – The sample in which the quantity of the target is unknown.
- **Reference sample** – The sample used as the basis for relative quantitation results. For example, in a study of drug effects on gene expression, an untreated control would be an appropriate reference sample. Also called *calibrator*.
- **Endogenous control** – A target or gene that should be expressed at similar levels in all samples you are testing. The endogenous control is used to normalize fluorescence signals for the target you are quantifying. Housekeeping genes can be used as endogenous controls.
- **Replicates** – The total number of identical reactions containing identical samples, components, and volumes.
- **Negative Controls** – Wells that contain water or buffer instead of sample template. No amplification of the target should occur in negative control wells.

## Comparison of Quantitation Methods

Consider the following when choosing between standard curve, relative standard curve, and comparative  $C_T$  experiments:

Experiment Type	Description	Advantage	Limitation
Standard curve	Uses a standard curve to determine the absolute quantity of a target in a sample. Typically used for quantifying viral load.	Allows comparisons against known standard quantities.	Because a standard curve must be constructed for each target, standard curve experiments require more reagents and more space in the reaction plate.
Relative standard curve	Uses a standard curve to determine the change in expression of a target in a sample relative to the same target in a reference sample. Best for assays that have suboptimal PCR efficiency.	Requires the least amount of validation because the PCR efficiencies of the target and endogenous control do not need to be equivalent.	Because a standard curve must be constructed for each target, relative standard curve experiments require more reagents and more space in the reaction plate.
Comparative $C_T$ ( $\Delta\Delta C_T$ )	Uses arithmetic formulas to determine the change in expression of a target in a sample relative to the same target in a reference sample. Best for high-throughput measurements of relative gene expression of many genes in many samples.	<ul style="list-style-type: none"> <li>Relative levels of target in samples can be determined without the use of a standard curve, provided that the PCR efficiencies of the target and endogenous control are relatively equivalent.</li> <li>Reduced reagent usage.</li> <li>More space is available in the reaction plate.</li> </ul>	<ul style="list-style-type: none"> <li>Suboptimal (low PCR efficiency) assays may produce inaccurate results.</li> <li>Before you use the comparative <math>C_T</math> method, Applied Biosystems recommends that you determine that the PCR efficiencies for the target assay and the endogenous control assay are approximately equal.</li> </ul>

### For More Information

For more information on quantitation methods, refer to *User Bulletin #2: Relative Quantitation of Gene Expression*.

## Select 1-Step or 2-Step RT-PCR

Reverse transcription-polymerase chain reaction (RT-PCR) is used to quantify RNA. RT-PCR can be performed as a 1-step or 2-step procedure.

### About 1-Step RT-PCR

In 1-step RT-PCR, you perform reverse transcription and the PCR in a single buffer system (Figure 3-1). The reaction proceeds without the addition of reagents between the RT and PCR steps. 1-step RT-PCR offers the convenience of a single-tube preparation for RT and PCR amplification. However, the carryover prevention enzyme, AmpErase<sup>®</sup> uracil-N-glycosylase (UNG), cannot be used with 1-step RT-PCR. In 1-step RT-PCR, the presence of UNG would destroy the cDNA as it is being made. For information about UNG, see [“Using UNG to Minimize Reamplification of Carryover Products”](#) on page 2-7.

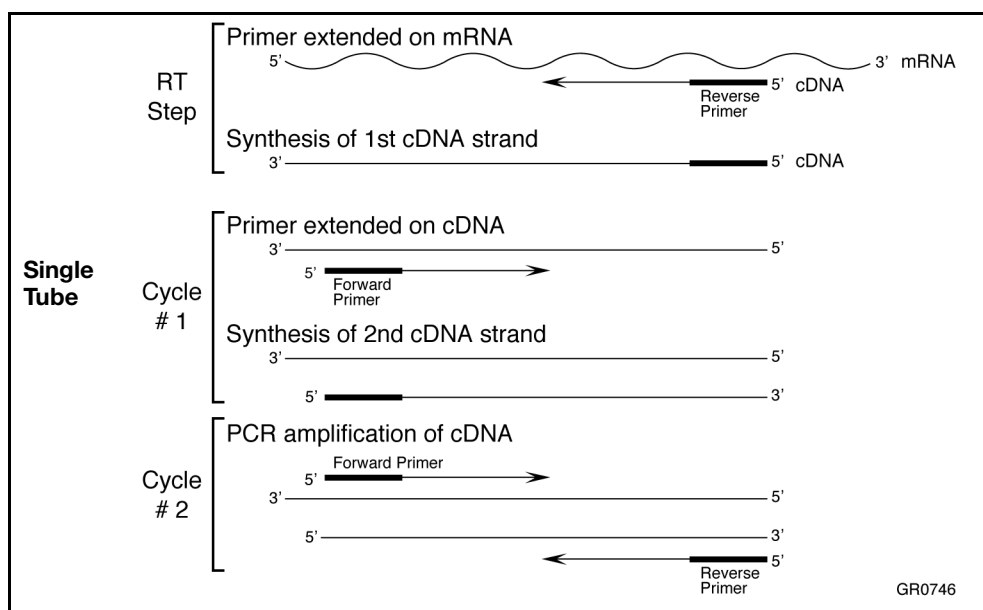

Figure 3-1 Schematic representation of 1-step RT-PCR

### About 2-Step RT-PCR

In 2-step RT-PCR, you perform two separate reactions: one for RT and one for PCR (Figure 3-2). 2-step RT-PCR is useful when detecting multiple transcripts from a single cDNA reaction, or when storing a portion of the cDNA for later use. When you perform PCR using dUTP as one of the bases, you can use AmpErase<sup>®</sup> UNG enzyme to prevent carryover contamination. For information about UNG, see [“Using UNG to Minimize Reamplification of Carryover Products”](#) on page 2-7.



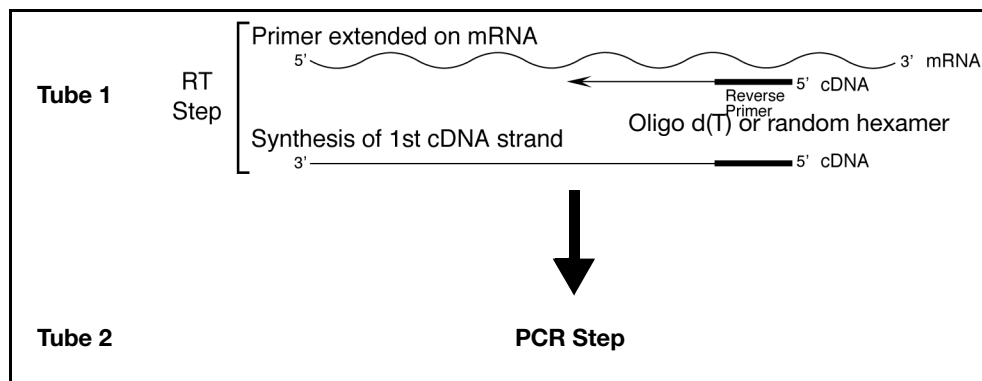

Figure 3-2 Schematic representation of 2-step RT-PCR

### Primers Used for cDNA Synthesis

For 1-step RT-PCR, sequence-specific reverse primers can be used for cDNA synthesis.

For 2-step RT-PCR, the following primers can be used for cDNA synthesis:

- Oligo d(T)<sub>16</sub>
- Random primers
- Sequence-specific reverse primers

The choice of primers for reverse transcription is best made after experimentally evaluating all three priming systems. For short RNA sequences containing no hairpin loops, any of the three priming systems works equally well. For longer RNA transcripts or sequences containing hairpin loops, consider the following guidelines:

Primers	Selection Guidelines
Oligo d(T) <sub>16</sub>	<ul style="list-style-type: none"> <li>• Use to reverse transcribe only eukaryotic mRNAs and retroviruses with poly-A tails</li> <li>• Avoid long mRNA transcripts or amplicons greater than 2 kilobases upstream from the poly-A site</li> </ul>
Random primers	<ul style="list-style-type: none"> <li>• Try first for use with long reverse transcripts or reverse transcripts containing hairpin loops</li> <li>• Use to transcribe all RNA (rRNA, mRNA, and tRNA)</li> </ul>
Sequence-specific reverse primers	<ul style="list-style-type: none"> <li>• Use to reverse transcribe RNA-containing complementary sequences only</li> <li>• Use in 1-step RT-PCR</li> </ul>

### Comparison of RT-PCR Methods

Method	Primers for cDNA Synthesis	Comments
1-step RT-PCR	Sequence-specific reverse primer	Requires single reaction mix AmpErase® UNG cannot be used
2-step RT-PCR	Random hexamers	cDNA can be stored for later use AmpErase® UNG can be used Requires two reaction mixes
	Oligo d(T) <sub>16</sub>	
	Sequence-specific reverse primers	

## Select Singleplex or Multiplex PCR

You can perform a PCR reaction using either:

- **Singleplex PCR** – In singleplex PCR a single primer set is present in the reaction tube or well. Only one target or endogenous control can be amplified per reaction.

or

- **Multiplex PCR** – In multiplex PCR, two or more primer sets are present in the reaction tube or well. Each set amplifies a specific target or endogenous control. Typically, a probe labeled with FAM™ dye detects the target and a probe labeled with VIC® dye detects the endogenous control.

**IMPORTANT!** SYBR® Green reagents cannot be used for multiplex PCR.

**IMPORTANT!** Applied Biosystems does not recommend the use of TAMRA™ dye as a reporter or quencher with the StepOne system. TAMRA dye may be used as a reporter or quencher with the StepOnePlus system.

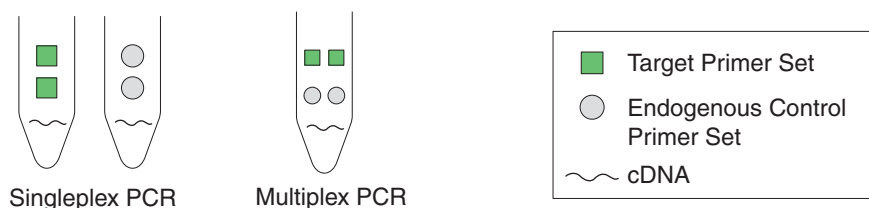

Figure 3-3 Singleplex vs. multiplex PCR

### About Multiplex PCR

In order to perform multiplex PCR you must:

- Ensure that the endogenous control you have selected is more abundant (lower  $C_T$  value) than all of the targets that you are trying to quantify under all conditions.
- Run the endogenous control assay as a primer-limited assay. The endogenous control assay (for the more abundant template) in each reaction must be primer-limited to avoid competitive PCR that may alter the  $C_T$  of the less abundant template.

#### Primer Limiting in Multiplex PCR

To generate an accurate multiplex assay, it is important that the amplification of one species does not dominate amplification of the other species. Otherwise, the amplification of a highly abundant species can prevent the less-abundant species from amplifying efficiently.

If the less-abundant species does not amplify efficiently, your experiment may produce inaccurate results or, in severe cases, detection of the less-abundant species may be inhibited completely. You can avoid this situation by limiting the concentrations of the primers used to amplify the more abundant species, thereby “turning off” the amplification soon after the  $C_T$  has been established. However, a primer-limited assay may be more susceptible to fluctuations in reaction conditions than the primer non-limited target assay that it is normalizing. For more information, see [Appendix B, “Primer Limiting in Multiplex PCR.”](#)

## Singleplex vs. Multiplex PCR

Primer limiting in multiplex PCR becomes increasingly more complex as the number of targets you quantify increases. When you analyze multiple numbers of targets, it may be more effective to use singleplex PCR for the following reasons:

- In multiplex PCR, it may be difficult to find a suitable endogenous control, one that:
  - Is more abundant than all of the targets you are quantifying.
  - Does not change expression levels with experimental conditions or across different samples.

You would first have to run all of your target assays and endogenous control assays in both the multiplex and singleplex formats, then compare  $C_T$  values from both formats to determine if there are any effects of the multiplexing on your  $C_T$  values.

- In singleplex PCR, any target that does not change expression levels with experimental conditions or across samples may serve as an endogenous control. Therefore, the more targets you have in a singleplex format, the higher the probability that you will have one or more suitable endogenous controls against which to normalize your remaining targets.

Consider the following when choosing between multiplex and singleplex PCR:

PCR	Description	Advantage	Limitation
Singleplex	A reaction in which a single target or endogenous control is amplified in the reaction tube or well.	<ul style="list-style-type: none"> <li>• No optimization is required for TaqMan<sup>®</sup> assays.</li> <li>• Any target that does not change expression levels with experimental conditions or across samples may serve as an endogenous control.</li> <li>• Flexibility to use TaqMan<sup>®</sup> or SYBR<sup>®</sup> Green reagents.</li> </ul>	<ul style="list-style-type: none"> <li>• Requires sample for both the target and the endogenous control.</li> </ul>
Multiplex	A reaction in which more than one target or endogenous control is amplified in the reaction tube or well.	<ul style="list-style-type: none"> <li>• Reduces both the running costs and the dependence on accurate pipetting when splitting a sample into two separate tubes.</li> </ul>	<ul style="list-style-type: none"> <li>• The endogenous control assay must be run as a primer-limited assay.</li> <li>• Requires validation and optimization.</li> <li>• May not be as effective as singleplex PCR when analyzing multiple numbers of targets.</li> <li>• You cannot use SYBR<sup>®</sup> Green reagents.</li> </ul>

## Select the Reagent Type

### TaqMan vs. SYBR Green Reagents

You can perform quantitation experiments on the StepOne and StepOnePlus systems with:

- TaqMan® reagents
- SYBR® Green reagents

For information on choosing between TaqMan and SYBR Green reagents, see [“Considerations for Quantitation Experiments” on page 2-6](#).

## Select the Assay Type

When you design your experiments with the StepOne software, you can select the following assay types for quantitation experiments:

- Inventoried/Made to Order ([page 3-13](#))
- Custom ([page 3-14](#))

This section lists the products available for each assay type.

**Note:** The assays are specific to the target of interest. The master mixes contain the remaining components needed for the PCR reaction.

## Inventoried/Made to Order Assays

Product	Attributes
TaqMan <sup>®</sup> Gene Expression Assays	<ul style="list-style-type: none"> <li>• Predesigned, gene-specific primer and probe sets for human, mouse, rat, <i>Arabidopsis</i>, <i>Drosophila</i>, <i>C. elegans</i>, <i>C. familiares</i> (dog), and <i>M. mulatta</i> (Rhesus) genes.</li> <li>• Probe is a FAM<sup>™</sup> dye-labeled MGB probe.</li> <li>• Provided in a convenient, single, 20X tube.</li> <li>• Available as Inventoried or Made to Order assays.</li> </ul>
TaqMan <sup>®</sup> Endogenous Control Assays <b>Note:</b> FAM <sup>™</sup> dye-labeled TaqMan <sup>®</sup> Endogenous Control Assays are included as Inventoried TaqMan Gene Expression Assays.	<ul style="list-style-type: none"> <li>• Optimized, preformulated, ready-to-use endogenous control assays.</li> <li>• Cost-effective gene expression quantitation for human, mouse, rat, <i>Arabidopsis</i>, <i>Drosophila</i>, and any eukaryotic species.</li> <li>• Choice of FAM<sup>™</sup> dye or VIC<sup>®</sup> dye labels (primer-limited).</li> </ul>
Custom TaqMan <sup>®</sup> Gene Expression Assays	<ul style="list-style-type: none"> <li>• Any species or organism.</li> <li>• Target of your choice.</li> <li>• Probe is a FAM<sup>™</sup> dye-labeled MGB probe.</li> <li>• Provided in a convenient, single, 205 tube.</li> </ul>
TaqMan <sup>®</sup> Gene Expression Master Mix	<p>Tailored for precise quantitation by real-time PCR for routine and challenging experiments:</p> <ul style="list-style-type: none"> <li>• Sensitive detection down to 1 copy of target.</li> <li>• Multiplex PCR for co-amplifying two targets in a single reaction.</li> <li>• Specificity for differentiation between gene family members.</li> <li>• Validated with TaqMan<sup>®</sup> Gene Expression Assays.</li> <li>• Simplifies assay implementation by using one reagent for all assays.</li> </ul>
TaqMan <sup>®</sup> 2X Universal PCR Master Mix (with or without AmpErase <sup>®</sup> UNG)	<ul style="list-style-type: none"> <li>• Provides optimal performance for TaqMan<sup>®</sup> assays that use cDNA or DNA as a template.</li> <li>• Contains components that ensure excellent assay performance.</li> <li>• The use of one reagent for all assays simplifies the process of assay implementation.</li> </ul>
TaqMan <sup>®</sup> Fast Universal PCR Master Mix (2X), No AmpErase <sup>®</sup> UNG	<ul style="list-style-type: none"> <li>• Provides the same attributes listed above for TaqMan<sup>®</sup> 2X Universal PCR Master Mix.</li> <li>• Allows you to run quantitation experiments on the StepOne<sup>™</sup> and StepOnePlus<sup>™</sup> systems in about 35 min.</li> </ul>

**IMPORTANT!** Applied Biosystems does not recommend the use of TAMRA<sup>™</sup> dye as a reporter or quencher with the StepOne system. TAMRA dye may be used as a reporter or quencher with the StepOnePlus system.

For guidelines on designing your experiments with Inventoried/Made to Order assays, see [page 3-16](#).

## Custom Assays

Product	Attributes
Custom TaqMan® Probes and Primers	<ul style="list-style-type: none"> <li>Any species or organism.</li> <li>Choice of dye labels, quenchers, and synthesis scales.</li> <li>For use with the Primer Express® Software and Applied Biosystems Assay Design Guidelines.</li> </ul>
Primer Express® Software	Software that designs primers and probes for real-time PCR.
TaqMan® Gene Expression Master Mix	<p>Tailored for precise quantitation by real-time PCR for routine and challenging experiments:</p> <ul style="list-style-type: none"> <li>Sensitive detection down to 1 copy of target.</li> <li>Multiplex PCR for co-amplifying two targets in a single reaction.</li> <li>Specificity for differentiation between gene family members.</li> <li>Validated with TaqMan® Gene Expression Assays.</li> <li>Simplifies assay implementation by using one reagent for all assays.</li> </ul>
TaqMan® 2X Universal PCR Master Mix (with or without AmpErase® UNG)	<ul style="list-style-type: none"> <li>Provides optimal performance for TaqMan® assays that use cDNA or DNA as a template.</li> <li>Contains components that ensure excellent assay performance.</li> <li>The use of one reagent for all assays simplifies the process of assay implementation.</li> </ul>
TaqMan® Fast Universal PCR Master Mix (2X), No AmpErase® UNG	<ul style="list-style-type: none"> <li>Provides the same attributes listed above for TaqMan® 2X Universal PCR Master Mix.</li> <li>Allows you to run quantitation experiments on the StepOne™ and StepOnePlus™ systems in about 35 min.</li> </ul>
Power SYBR® Green PCR Master Mix	<ul style="list-style-type: none"> <li>Highly sensitive quantitation enables low-copy-number detection (as few as two copies of a target gene).</li> <li>Detects double-stranded DNA, so specific probes are not required.</li> <li>Contains highly purified AmpliTaq Gold® DNA polymerase LD to minimize nonspecific product formation (including primer-dimer).</li> <li>For use with the Primer Express® Software and Applied Biosystems Assay Design Guidelines.</li> </ul>
SYBR® Green PCR Master Mix	<ul style="list-style-type: none"> <li>Detects double-stranded DNA, so specific probes are not required.</li> <li>For standard applications when high sensitivity is not required.</li> <li>Contains AmpliTaq Gold® DNA polymerase to minimize nonspecific product formation (including primer-dimer).</li> <li>For use with the Primer Express® Software and Applied Biosystems Assay Design Guidelines.</li> </ul>

**IMPORTANT!** Applied Biosystems does not recommend the use of TAMRA™ dye as a reporter or quencher with the StepOne system. TAMRA dye may be used as a reporter or quencher with the StepOnePlus system.

For guidelines on designing your experiments with Custom assays, see [page 3-21](#).

---

## Section 3.2 Design Guidelines

---

This section covers:

Inventoried/Made to Order Assays .....	3-16
TaqMan® Gene Expression Assays .....	3-16
Custom TaqMan® Gene Expression Assays .....	3-18
Select the Master Mix .....	3-19
Design the Experiment .....	3-20
Custom Assays .....	3-21
Design Primers and Probes Using Primer Express® Software .....	3-21
Select the Reagents .....	3-24
Use the Recommended Thermal Cycling Conditions .....	3-27
Optimize Primer Concentrations .....	3-30
Optimize the Probe Concentration .....	3-33
For More Information .....	3-35

## Inventoried/Made to Order Assays

**Workflow** If you select the Inventoried/Made to Order assay type in the StepOne™ software, Applied Biosystems recommends that you follow the workflow below:

1. Select the assay:
  - TaqMan® Gene Expression Assays (below).
  - Custom TaqMan® Gene Expression Assays (page 3-18).
2. Select the master mix (page 3-19).
3. Design the experiment using the StepOne software (page 3-20).

## TaqMan® Gene Expression Assays

**Product Description** TaqMan® Gene Expression Assays are a comprehensive collection of Inventoried and Made to Order probe and primer sets for performing quantitation experiments on human, mouse, rat, *Arabidopsis*, *Drosophila*, *C. elegans*, *C. familiaris* (dog), and *M. mulatta* (Rhesus) genes.

The assays:

- Use TaqMan® reagents to amplify and detect the target in cDNA samples.
- Are designed using an automated design and quality-controlled pipeline. Inventoried assays are manufactured and placed in inventory; Made to Order assays are predesigned and manufactured when ordered.
- Are designed and optimized to work with an Applied Biosystems TaqMan® master mix, using universal thermal cycling conditions.
- When possible, amplify target cDNA without amplifying genomic DNA (*m* suffix in assay ID) by designing probes that cross exon-exon junctions.

**Product Requirements** All TaqMan Gene Expression Assays require:

- Three components:
  - 1 to 100 ng of cDNA sample (converted from RNA) per well, with all wells in a study having the same amount of cDNA.
  - 20X Gene Expression Assay Mix (specific for each target). Each assay mix consists of two unlabeled PCR primers and a FAM™ dye-labeled TaqMan® MGB (minor groove binder) probe in a preformulated 20X mix. 1X final concentrations are 250 nM for the probe and 900 nM for each primer.
  - TaqMan® Gene Expression Master Mix, TaqMan® Universal PCR Master Mix (with or without AmpErase® UNG), or TaqMan® Fast Universal PCR Master Mix, No AmpErase® UNG.
- Only one PCR amplification step during each PCR cycle and a simultaneous real-time reading to obtain results.



**Available Assays** TaqMan Gene Expression Assays are available for human, mouse, rat, *Arabidopsis*, *Drosophila*, *C. elegans*, *C. familiares* (dog), and *M. mulatta* (Rhesus) genes. The part numbers are:

- PN 4331182 for Inventoried assays
- PN 4351372 for Made to Order assays

The prefix of the assay name indicates the species for which the assay was designed: *Hs* for *Homo sapiens* (human), *Mm* for *Mus musculus* (mouse), *Rn* for *Rattus norvegicus* (rat), *At* for *Arabidopsis thaliana*, *Dm* for *Drosophila melanogaster*, *Ce* for *C. elegans*, *Cf* for *C. familiares* (dog), and *Rh* for *M. mulatta* (Rhesus).

The suffix of the assay name indicates the assay placement, as described in the table below.

Suffix	Description
<i>_m</i>	The assay's probe spans an exon junction; the assay does not detect genomic DNA.
<i>_s</i>	The assay's primers and probes are designed within a single exon; the assay does detect genomic DNA.
<i>_g</i>	The assay may detect genomic DNA; the assay's primers and probes may be within a single exon.
<i>_mH</i>	The assay was designed to a transcript belonging to a gene family with high sequence homology. The assay provides between 10 C <sub>T</sub> and 15 C <sub>T</sub> difference between the target gene and the gene with the closest sequence homology. Therefore, the assay detects the target transcript with 1000- to 30,000-fold greater discrimination (sensitivity) than the closest homologous transcript, if they are present at the same copy number in a sample.
<i>_sH</i>	
<i>_gH</i>	
<i>_u</i>	The assay's amplicon spans an exon junction and the probe sits completely in one of the spanned exons.

### TaqMan<sup>®</sup> Endogenous Control Assays

TaqMan<sup>®</sup> Endogenous Control Assays are available as:

- Inventoried TaqMan Gene Expression Assays (PN 4331182) – Each assay contains a FAM<sup>™</sup> dye-labeled TaqMan<sup>®</sup> MGB probe in a single, preformulated 20X tube.
- Individual control assays for all human, mouse, and rat species (various part numbers) – Each assay contains either a FAM<sup>™</sup> dye-labeled TaqMan<sup>®</sup> MGB probe, a VIC<sup>®</sup> dye-labeled TaqMan<sup>®</sup> MGB probe, or a TAMRA<sup>™</sup> dye-labeled probe. TaqMan Endogenous Controls with VIC dye labels are primer-limited.

**IMPORTANT!** Applied Biosystems does not recommend the use of TAMRA<sup>™</sup> dye as a reporter or quencher with the StepOne system. TAMRA dye may be used as a reporter or quencher with the StepOnePlus system.

**For More Information**

- For information on the latest available products and specific product uses, refer to the Applied Biosystems Web site:

<http://www.appliedbiosystems.com/>

- a. On the Home page, under TaqMan<sup>®</sup> Products, select **TaqMan<sup>®</sup> Gene Expression Assays**.
  - b. On the Gene Expression Assays & Arrays page:
    - Under Individual Assays, select **TaqMan<sup>®</sup> Gene Expression Assays**. This option links to all TaqMan Gene Expression Assays, including TaqMan Endogenous Control Assays that contain FAM dye-labeled probes.
- or
- Under Individual Control Assays, select **TaqMan<sup>®</sup> Endogenous Control Assays**. This option links to the individual TaqMan Endogenous Control Assays (that contain FAM dye-labeled TaqMan MGB probes, VIC dye-labeled TaqMan MGB probes, or TAMRA dye-labeled probes).
  - For information on Custom TaqMan Endogenous Control Assays, refer to the *Using TaqMan<sup>®</sup> Endogenous Control Assays to Select an Endogenous Control for Experimental Studies Application Note*.
  - For information on preparing PCR reactions using the TaqMan Gene Expression Assays, refer to the *TaqMan<sup>®</sup> Gene Expression Assays Protocol*.

**Custom TaqMan<sup>®</sup> Gene Expression Assays****Product Description**

Custom TaqMan<sup>®</sup> Gene Expression Assays are TaqMan probe and primer sets that are designed, synthesized, and formulated by the Custom TaqMan<sup>®</sup> Genomic Assays service based on sequence information that you submit. Custom TaqMan Gene Expression Assays allow you to perform quantitation experiments on any gene or splice variant in any organism.

The assays:

- Use TaqMan<sup>®</sup> reagents to amplify and detect the target in cDNA samples.
- Are developed using proprietary assay-design software.
- Are designed and optimized to work with an Applied Biosystems TaqMan<sup>®</sup> master mix, using universal thermal cycling conditions.

**Product Requirements**

All Custom TaqMan Gene Expression Assays require:

- A submission file that includes your target sequence. You create the submission file using free File Builder software, then submit the file to the Custom TaqMan<sup>®</sup> Genomic Assays service.
- Three components:
  - 1 to 100 ng of cDNA sample (converted from RNA) per well, with all wells in a study having the same amount of cDNA.
  - 20X Gene Expression Assay or 60X Gene Expression Assay (specific for each target). Each assay consists of two target-specific primers and a FAM<sup>™</sup> dye-labeled TaqMan MGB probe in a preformulated 20X or 60X mix. 1X final concentrations are 250 nM for the probe and 900 nM for each primer.

- TaqMan<sup>®</sup> Gene Expression Master Mix, TaqMan<sup>®</sup> Universal PCR Master Mix (with or without AmpErase<sup>®</sup> UNG), or TaqMan<sup>®</sup> Fast Universal PCR Master Mix, No AmpErase<sup>®</sup> UNG.
- Only one PCR amplification step during each PCR cycle and a simultaneous real-time reading to obtain results.

### For More Information

- For information on the latest available products and specific product uses, refer to the Applied Biosystems Web site:  
<http://www.appliedbiosystems.com/>
  - a. On the Home page, under TaqMan<sup>®</sup> Products, select **TaqMan<sup>®</sup> Gene Expression Assays**.
  - b. On the Gene Expression Assays & Arrays page, under Individual Assays, select **Custom TaqMan<sup>®</sup> Gene Expression Assays**.
- For information on ordering Custom TaqMan Gene Expression Assays, refer to the *Custom TaqMan<sup>®</sup> Genomic Assays Protocol: Submission Guidelines*.
- For information on preparing PCR reactions using the Custom TaqMan Gene Expression Assays, refer to the *Custom TaqMan<sup>®</sup> Gene Expression Assays Protocol*.

## Select the Master Mix

### Available Master Mixes

Applied Biosystems Inventoried/Made to Order assays for quantitation experiments are designed to work with the following TaqMan<sup>®</sup> master mixes:

Master Mix	Part Number
TaqMan <sup>®</sup> Gene Expression Master Mix, 1-Pack (1 × 5 mL), 200 reactions	4369016
TaqMan <sup>®</sup> Gene Expression Master Mix, 10-Pack (10 × 5 mL), 2000 reactions	4369542
TaqMan <sup>®</sup> Fast Universal PCR Master Mix (2X), No AmpErase <sup>®</sup> UNG, 250 Reactions	4352042
TaqMan <sup>®</sup> 2X Universal PCR Master Mix, 200 Reactions	4304437
TaqMan <sup>®</sup> 2X Universal PCR Master Mix, 2000 Reactions	4326708
10-Pack, TaqMan <sup>®</sup> 2X Universal PCR Master Mix	4305719
TaqMan <sup>®</sup> 2X Universal PCR Master Mix, No AmpErase <sup>®</sup> UNG, 200 Reactions	4324018
TaqMan <sup>®</sup> 2X Universal PCR Master Mix, No AmpErase <sup>®</sup> UNG, 2000 Reactions	4326614
10-Pack, TaqMan <sup>®</sup> 2X Universal PCR Master Mix, No AmpErase <sup>®</sup> UNG	4324020

**For More Information**

For information on using the TaqMan reagents, refer to:

- *TaqMan<sup>®</sup> Fast Universal PCR Master Mix (2X) Protocol*
- *TaqMan<sup>®</sup> Gene Expression Master Mix Protocol*
- *TaqMan<sup>®</sup> Universal PCR Master Mix Protocol*

## Design the Experiment

**Use the StepOne Software**

For Applied Biosystems Inventoried/Made to Order assays, use the StepOne software to design your quantitation experiments. The StepOne software automatically calculates volumes for the:

- Reaction mix components
- Sample dilutions
- *(Standard curve and relative standard curve experiments only)* Standard dilution series

**Note:** To select the Inventoried/Made to Order assay type in the StepOne software, go to the Reaction Setup screen in either the Design Wizard or Advanced Setup, then select **Inventoried/Made to Order** from the Assay Type dropdown menu.

**For More Information**

For information on designing and performing quantitation experiments on the StepOne and StepOnePlus systems, refer to:

- *Applied Biosystems StepOne<sup>™</sup> and StepOnePlus<sup>™</sup> Real-Time PCR Systems Getting Started Guide for Standard Curve Experiments*
- *Applied Biosystems StepOne<sup>™</sup> and StepOnePlus<sup>™</sup> Real-Time PCR Systems Getting Started Guide for Relative Standard Curve and Comparative C<sub>T</sub> Experiments*

## Custom Assays

**Workflow** If you select the Custom assay type in the StepOne™ software for a quantitation experiment (that is, you are designing your own primers and probes), Applied Biosystems recommends that you follow the workflow for the Applied Biosystems Assay Design Guidelines:

1. Design primers and probes using Primer Express® Software (below).
2. Select the appropriate reagents ([page 3-24](#)).

**IMPORTANT!** Applied Biosystems does not recommend the use of TAMRA™ dye as a reporter or quencher with the StepOne system. TAMRA dye may be used as a reporter or quencher with the StepOnePlus system.

3. Use the recommended thermal cycling conditions ([page 3-27](#)).
4. Begin with default primer and probe concentrations. If needed, optimize the primer concentrations ([page 3-30](#)) and probe concentrations ([page 3-33](#)).

**IMPORTANT!** These steps provide a rapid and reliable system for assay design and optimization only when used in their entirety. Adopt the system as a whole to achieve the highest level of success. For a more detailed description of Applied Biosystems Assay Design Guidelines, see [Appendix C](#).

**Note:** To select the Custom assay type in the StepOne software, go to the Reaction Setup screen in either the Design Wizard or Advanced Setup, then select **Custom** from the Assay Type dropdown menu.

## Design Primers and Probes Using Primer Express® Software

The Primer Express® Software uses recommended parameters to select primers and probes based on the DNA sequence that you provide.

If you are designing your own assay, follow the summary of the primer and probe design guidelines for quantitation experiments on [page 3-23](#). For a detailed discussion of these guidelines see “[About the Primer and Probe Design Guidelines](#)” on [page 3-22](#).

**IMPORTANT!** Applied Biosystems does not recommend the use of TAMRA™ dye as a reporter or quencher with the StepOne system. TAMRA dye may be used as a reporter or quencher with the StepOnePlus system.

**Note:** Even though a probe is not required for SYBR® Green I dye detection, it is still a good idea to use Primer Express software to select a primer and probe set when you design an assay for SYBR® Green reagents. Although no probe will be used, the primers will meet all required criteria; if you need to convert the assay to TaqMan reagents to obtain higher specificity, you can find the probe immediately in the original Primer Express software document.

### Selecting an Amplicon Site for Quantitation Assays

Selecting a good amplicon site ensures amplification of the target mRNA/cDNA without co-amplifying the genomic sequence, pseudogenes, and other related genes. SYBR Green reagents can be useful for screening amplicon sites for gene expression.

### Guidelines

- The amplicon should span one or more introns to avoid amplification of the target gene in genomic DNA.
- The primer pair should be specific to the target gene to avoid amplification of pseudogenes or other related genes.
- When designing primers, use Primer Express software guidelines.
- If no good sequence is found, it may be necessary to examine the sequence and redesign the amplicon or simply screen for more sites.

If the gene you are studying does not have introns, it is not possible to design an amplicon that will amplify the mRNA sequence without amplifying the genomic sequence. In this case, run a control of your RNA sample that has not been reverse-transcribed (RT minus controls).

### About the Primer and Probe Design Guidelines

#### Selection of Small Amplicons

An important default parameter in Primer Express software is the selection of amplicons in the 50- to 150-basepair range. Small amplicons are favored because they promote high-efficiency amplification.

In addition, high-efficiency assays enable relative quantitation to be performed using the comparative  $C_T$  ( $\Delta\Delta C_T$ ) method (Livak and Schmittgen, 2001). This method increases sample throughput by eliminating the need for standard curves.

#### G/C Content

Whenever possible, select primers and probes in a region with a G/C content of 30 to 80%. Regions with a G/C content >80% may not denature well during thermal cycling, leading to a less efficient reaction. G/C-rich sequences are susceptible to nonspecific interactions that may reduce reaction efficiency and produce nonspecific signal in assays using SYBR Green reagents. Avoid primer and probe sequences containing runs of four or more G bases.

#### Melting Temperature

When you select primers and probes with the recommended melting temperature ( $T_m$ ), you can use universal thermal cycling conditions. Applied Biosystems recommends that the probe  $T_m$  be 10 °C higher than that of the primers.

#### 5' End of Probes

Primer Express software does not select probes with a G on the 5' end. The quenching effect of a G base in this position will be present even after probe cleavage. The presence of a G base can result in reduced fluorescence values ( $\Delta R_n$ ) that can negatively affect assay performance. G bases in positions close to the 5' end, but not on it, have not been shown to compromise assay performance.

**3' End of Primers**

To reduce the possibility of nonspecific product formation, ensure that the last five bases on the 3' end of the primers do not contain more than two C and/or G bases. Under certain circumstances, such as a G/C-rich template sequence, you may have to relax this recommendation to keep the amplicon under 150 basepairs in length. In general, avoid primer 3' ends extremely rich in G and/or C bases.

**Summary of  
Primer and MGB  
Probe Design  
Guidelines**

<b>Probe Guidelines</b>	<b>Primer Guidelines</b>
Select the probe first, then design the primers as close as possible to the probe without overlapping the probe (amplicons of 50 to 150 basepairs are strongly recommended).	
Keep the G/C content in the 30 to 80% range.	
Avoid runs of an identical nucleotide, especially guanine, where runs of four or more Gs should be avoided.	
When using Primer Express® Software, the T <sub>m</sub> should be 68 to 70 °C.	When using Primer Express® Software, the T <sub>m</sub> should be 58 to 60 °C.
No G on the 5' end.	The five nucleotides at the 3' end should have no more than two G and/or C bases.
Make TaqMan® MGB probes as short as possible without being shorter than 13 nucleotides.	

## Select the Reagents

Several TaqMan and SYBR Green reagents are available for quantitation experiments. The reagents you use depend on your target:

- DNA or cDNA (below).
- RNA using 1-step RT-PCR ([page 3-25](#)).
- RNA using 2-step RT-PCR ([page 3-26](#)).

**Note:** If you are using SYBR Green reagents, Applied Biosystems highly recommends the *Power* SYBR Green reagents.

### DNA or cDNA Quantitation

Reagent	Kit	Part Number
TaqMan® reagents	TaqMan® Gene Expression Master Mix, 1-Pack (1 × 5 mL), 200 reactions	4369016
	TaqMan® Gene Expression Master Mix, 10-Pack (10 × 5 mL), 2000 reactions	4369542
	TaqMan® Fast Universal PCR Master Mix (2X), No AmpErase® UNG, 250 Reactions	4352042
	TaqMan® 2X Universal PCR Master Mix, 200 Reactions	4304437
	TaqMan® 2X Universal PCR Master Mix, 2000 Reactions	4326708
	10-Pack, TaqMan® 2X Universal PCR Master Mix	4305719
	TaqMan® 2X Universal PCR Master Mix, No AmpErase® UNG, 200 Reactions	4324018
	TaqMan® 2X Universal PCR Master Mix, No AmpErase® UNG, 2000 Reactions	4326614
	10-Pack, TaqMan® 2X Universal PCR Master Mix, No AmpErase® UNG	4324020
	TaqMan® PCR Core Reagents Kit, 200 Reactions	N808-0228



Reagent	Kit	Part Number
SYBR® Green reagents	Power SYBR® Green PCR Master Mix (1 mL), 40 reactions	4368577
	Power SYBR® Green PCR Master Mix (5-mL), 200 reactions	4367659
	Power SYBR® Green PCR Master Mix (10 × 5-mL), 2000 reactions	4368708
	Power SYBR® Green PCR Master Mix (50 mL), 2000 reactions	4367660
	SYBR® Green PCR Master Mix (1-mL), 40 reactions	4344463
	SYBR® Green PCR Master Mix (5-mL), 200 reactions	4309155
	SYBR® Green PCR Master Mix (50-mL), 2000 reactions	4334973
	SYBR® Green PCR Core Reagents, 200 Reactions	4304886

### RNA Quantitation Using 1-Step RT-PCR

Reagent	Kit	Part Number
TaqMan® reagents	TaqMan® One-Step RT-PCR Master Mix Reagents Kit	4309169
	TaqMan® EZ RT-PCR Core Reagents <b>Note:</b> Use the TaqMan® EZ RT-PCR Core Reagents when a high-temperature RT step is required.	N808-0236
SYBR® Green reagents	Power SYBR® Green RT-PCR Reagents Kit	4368711
	SYBR® Green RT-PCR Reagents	4310179

### RNA Quantitation Using 2-Step RT-PCR

Reagent	Step	Kit	Part Number
TaqMan® reagents	PCR step only	TaqMan® Gene Expression Master Mix, 1-Pack (1 × 5 mL), 200 reactions	4369016
		TaqMan® Gene Expression Master Mix, 10-Pack (10 × 5 mL), 2000 reactions	4369542
		TaqMan® 2X Universal PCR Master Mix	4304437
		TaqMan® Fast Universal PCR Master Mix (2X), No AmpErase® UNG	4352042
	RT step only	High-Capacity cDNA Reverse Transcription Kit	4374966
		TaqMan® Reverse Transcription Reagents	N808-234
	Both RT and PCR steps	TaqMan® Gold RT PCR kit	N808-232
SYBR® Green reagents	PCR step only	Power SYBR® Green PCR Master Mix	4367659
		SYBR® Green PCR Master Mix	4309155
	RT step only	High-Capacity cDNA Reverse Transcription Kit	4374966
		TaqMan® Reverse Transcription Reagents	N808-234
	Both RT and PCR steps	Power SYBR® Green RT-PCR Reagents Kit	4368711
		SYBR® Green RT-PCR Reagents	4310179

### About AmpliTaq Gold DNA Polymerase

The use of the hot-start enzyme AmpliTaq Gold® DNA Polymerase is an integral part of Applied Biosystems Assay Design Guidelines for both TaqMan and SYBR Green reagents. AmpliTaq Gold DNA Polymerase ensures a robust reaction and it can dramatically reduce the amount of nonspecific product formation. A further benefit is the simplification of assay setup, which can be performed at room temperature.

**Note:** The DNA polymerase included in the TaqMan Fast Universal PCR Master Mix (2X), No AmpErase UNG, is capable of very fast hot-start PCR. The performance is similar to that of the AmpliTaq Gold DNA Polymerase.

### About MultiScribe Reverse Transcriptase

MultiScribe™ Reverse Transcriptase is a recombinant Moloney Murine Leukemia Virus (MuLV) Reverse Transcriptase that reverse transcribes RNA into complimentary DNA (cDNA).

## Use the Recommended Thermal Cycling Conditions

Use the thermal cycling conditions recommended for your sample:

- DNA or cDNA ([page 3-28](#)).
- RNA using 1-step RT-PCR ([page 3-28](#)).
- RNA using 2-step RT-PCR ([page 3-29](#)).

**Note:** Thermal cycling conditions for Fast reagents differ from thermal cycling conditions for standard reagents.

### About the VeriFlex™ Technology

The StepOnePlus instrument contains six independently thermally regulated VeriFlex™ blocks to help you optimize your thermal cycling conditions.

If you are running your experiment on a StepOnePlus instrument, you can set a different temperature for one or more of the VeriFlex blocks, creating up to six different zones for samples, or you can set the same temperature for each of the VeriFlex blocks.

For more information on using the VeriFlex sample blocks, access the Help from within the StepOne software by clicking  in the toolbar or pressing **F1**.

**DNA or cDNA  
Quantitation**

For TaqMan Fast Universal PCR Master Mix (2×), No AmpErase UNG, follow these conditions:

Times and Temperatures			
Initial Steps		PCR (40 Cycles)	
AmpErase® UNG Activation‡	Activation	Melt	Anneal/Extend
HOLD	HOLD	CYCLE	
2 min @ 50 °C	20 sec @ 95 °C	1 sec @ 95 °C	20 sec @ 60 °C

‡ Required only if AmpErase® UNG is added to the reactions.

For TaqMan Gene Expression Master Mix, TaqMan 2× Universal PCR Master Mix, and Power SYBR Green PCR Master Mix, follow these conditions:

Times and Temperatures			
Initial Steps		PCR (40 Cycles)	
AmpErase® UNG Activation‡	AmpliTaq Gold® DNA Polymerase Activation	Melt	Anneal/Extend
HOLD	HOLD	CYCLE	
2 min @ 50 °C	10 min @ 95 °C	15 sec @ 95 °C	1 min @ 60 °C

‡ Required only if AmpErase® UNG is added to the reactions or is included in the master mix.

**RNA Quantitation  
Using 1-Step  
RT-PCR**

For the TaqMan One-Step RT-PCR Master Mix Reagents Kit and Power SYBR Green RT-PCR Reagents Kit, follow these conditions:

Times and Temperatures			
Initial Steps		PCR (40 Cycles)	
Reverse Transcription	AmpliTaq Gold® DNA Polymerase Activation	Melt	Anneal/Extend
HOLD	HOLD	40 CYCLES	
30 min @ 48 °C	10 min @ 95 °C	15 sec @ 95 °C	1 min @ 60 °C

**Note:** These conditions do not apply to the TaqMan EZ RT-PCR Kit. See the *TaqMan® EZ RT-PCR Kit Protocol* for the appropriate conditions.

## RNA Quantitation Using 2-Step RT-PCR

For the High-Capacity cDNA Reverse Transcription Kit, follow these conditions:

Step	Times and Temperatures	
1. RT Step	Step 1	Step 2
	HOLD	HOLD
	10 min @ 25 °C	120 min @ 37 °C
After reverse-transcribing the RNA into cDNA (RT step), samples can be stored or used for the subsequent PCR step described below.		

**IMPORTANT!** For most applications and when large amounts of cDNA are required, Applied Biosystems recommends 120 minutes at 37 °C for reverse transcription to achieve optimal conversion.

For TaqMan Fast Universal PCR Master Mix (2X), No AmpErase UNG, follow these conditions:

Step	Times and Temperatures			
2. PCR Step	Initial Steps		PCR (40 Cycles)	
	AmpErase® UNG Activation‡	AmpliTaq Gold® DNA Polymerase Activation	Melt	Anneal/ Extend
	HOLD	HOLD	CYCLE	
	2 min @ 50 °C	20 sec @ 95 °C	1 sec @ 95 °C	20 sec @ 60 °C

‡ Required only if AmpErase® UNG is added to the reactions.

For TaqMan Gene Expression Master Mix, TaqMan 2X Universal PCR Master Mix (with AmpErase UNG), and Power SYBR Green PCR Master Mix, follow these conditions:

Step	Times and Temperatures			
2. PCR Step	Initial Steps		PCR (40 Cycles)	
	AmpErase® UNG Activation	AmpliTaq Gold® DNA Polymerase Activation	Melt	Anneal/ Extend
	HOLD	HOLD	CYCLE	
	2 min @ 50 °C	10 min @ 95 °C	15 sec @ 95 °C	1 min @ 60 °C

## Optimize Primer Concentrations

By independently varying forward and reverse primer concentrations, you can identify the concentrations that provide optimal assay performance. Primers are always in large molar excess during the exponential phase of PCR amplification.

When you use TaqMan Gene Expression Master Mix or TaqMan 2X Universal PCR Master Mix, Applied Biosystems recommends the primer concentrations listed in “Default Primer Concentrations” below. Detailed discussions follow for the:

- Primer optimization matrix (below)
- TaqMan reagents (below)
- SYBR Green reagents ([page 3-31](#))

### Default Primer Concentrations

The recommended starting primer concentrations listed in the table below are for DNA and cDNA quantitation assays.

Reagent	Concentrations (nM)	
	Forward Primer	Reverse Primer
TaqMan <sup>®</sup> reagents	900	900
SYBR <sup>®</sup> Green reagents	50	50

### Primer Optimization Matrix

A primer optimization matrix allows you to determine that the minimum primer concentration yields the minimum  $C_T$  and maximum  $\Delta R_n$ .

A primer optimization matrix can help to compensate for nonspecific primer binding, which can reduce the amount of primer available to bind at its specific site.

### TaqMan Reagents

For quantitation assays using TaqMan reagents, you can achieve optimal performance by selecting the primer concentrations that provide the lowest  $C_T$  and highest  $\Delta R_n$  for a fixed quantity of target template.

**Note:** Although  $C_T$  values are the parameter by which quantitative values are assigned in a real-time quantitation assays,  $\Delta R_n$  values can also be important when you are trying to obtain maximum sensitivity and reproducibility.

The results of a typical TaqMan reagent primer optimization matrix experiment are shown in [Figure 3-4 on page 3-31](#):

- [Figure 3-4a](#) shows the amplification plots for all primer concentration combinations in linear view.
- [Figure 3-4b](#) shows the same data in log view format.

The combination of 50-nM forward and reverse primer (Plot group C) gives both the lowest  $\Delta R_n$  and highest  $C_T$ . All other primer combinations that contain a 150-nM concentration of either the forward or reverse primer (Plot group B) give a reduced  $\Delta R_n$ . All primer combinations that contain at least 300-nM forward and reverse primer (Plot group A) give both the highest  $\Delta R_n$  and the lowest  $C_T$ ; as a result, any of the plot group A or B provides optimal performance.

## a) Linear view

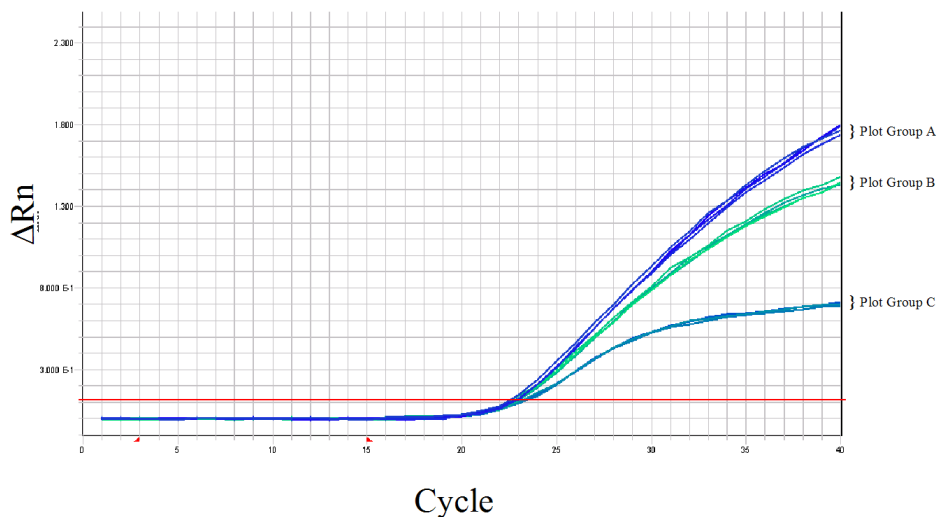

## b) Log view

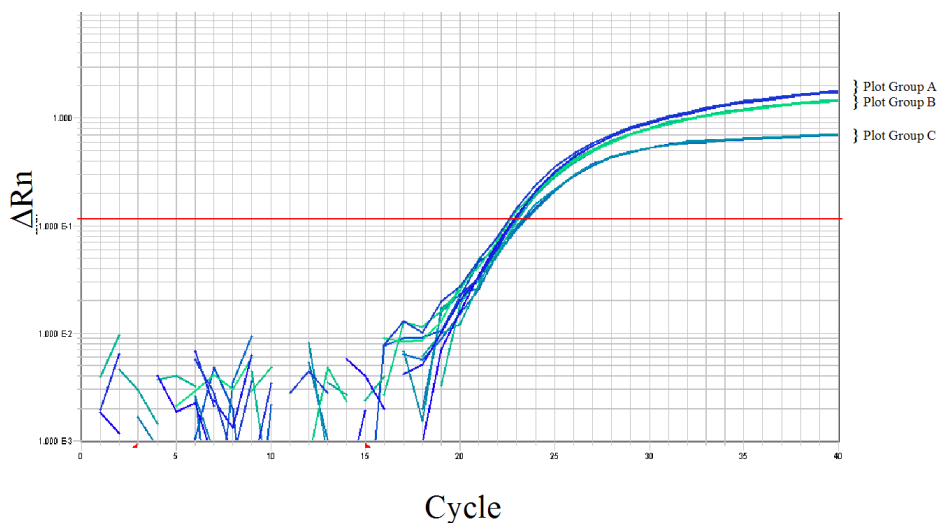

Figure 3-4 Primer optimization experimental results showing amplification plots (linear and log views) of primer combinations

Plot group key:

A: Combinations that contain at least 300 nM of forward and reverse primer

B: Combinations that contain at least 150 nM of forward and reverse primer

C: Combinations that contain at least 50 nM of forward and reverse primer

### SYBR Green Reagents

Optimizing primer concentrations is slightly more complex for quantitation assays using SYBR Green reagents. You should perform the same primer optimization matrix as for TaqMan reagents; however, you must include negative controls for SYBR Green reagents. The primer concentrations you select should provide a low  $C_T$  and high  $\Delta R_n$  when run against the target template, but should not produce nonspecific product formation with negative controls.

Melt curves or gel analysis can be extremely useful when you select optimal primer concentrations for quantitation assays using SYBR Green reagents. [Figure 3-5 on page 3-32](#) shows the results from a primer optimization matrix at primer concentrations of 900-nM forward and reverse primers:

- [Figure 3-5a](#) shows strong amplification of the negative control wells, which indicates that significant nonspecific amplification is occurring.
- [Figure 3-5b](#) shows that the melting temperature of the product generated in the absence of template is lower than the melting temperature of the specific product generated with template, indicating that significant nonspecific amplification is occurring.

The results shown in [Figure 3-5](#) are typical of primer-dimer formation. These results indicate that lower primer concentrations may provide more optimal results. Additionally, you can redesign another set of primers to the target of interest.

#### a) Amplification plot, linear view

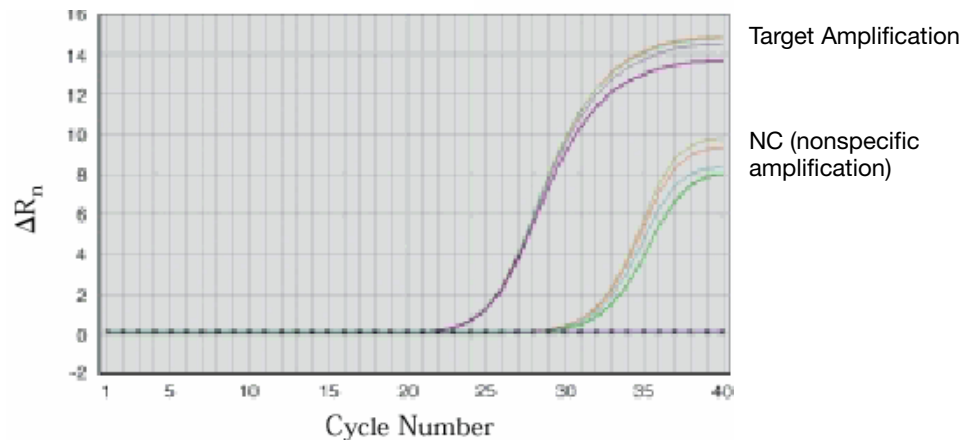

#### b) Melt curve analysis

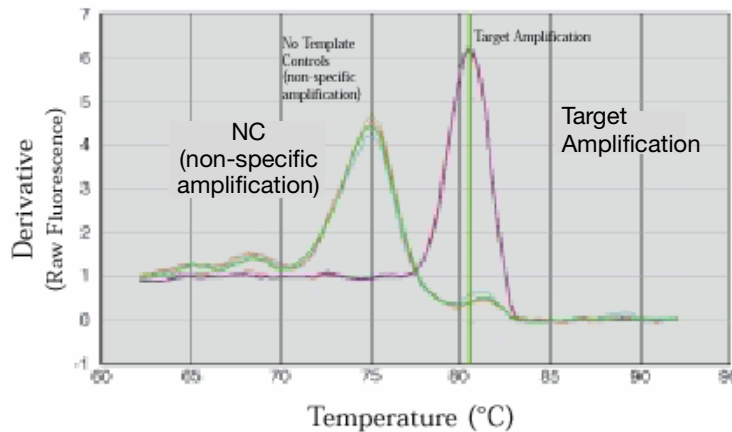

**Figure 3-5** Amplification data using SYBR® Green reagents

(a) Amplification plot (linear view) demonstrating suspected nonspecific amplification in negative control (NC) wells

(b) Melt curve analysis confirming that product in NC wells has a different melting temperature from the specific product



## Optimize the Probe Concentration

For detection by TaqMan<sup>®</sup> probes, the recommended probe concentration of 250 nM ensures excellent assay performance. However, depending on the requirements of the assay, a probe optimization experiment can prove useful.

**Note:** No probe is required for SYBR Green I dye detection.

### Recommended Probe Concentrations

The recommended probe concentrations for DNA and cDNA quantitation assays using TaqMan reagents is 250 nM. [Figure 3-6](#) shows the results of a probe optimization experiment in which the probe concentration is varied from 50 to 250 nM:

- [Figure 3-6a](#) shows an increase in  $\Delta R_n$  as the probe concentration is increased.
- [Figure 3-6b](#) shows that the  $C_T$  value changes with sufficient probe concentrations.

To ensure the best reproducibility, especially when you want to detect low copy numbers of a target, avoid probe limiting concentrations. Run the assay at a probe concentration of 250 nM. Using a 250-nM concentration, you avoid probe limitation and ensure large  $\Delta R_n$  values. Large  $\Delta R_n$  values indicate a robust assay that is performing at high efficiency, giving high product yield and allowing accurate peak measurement.

a) Linear view

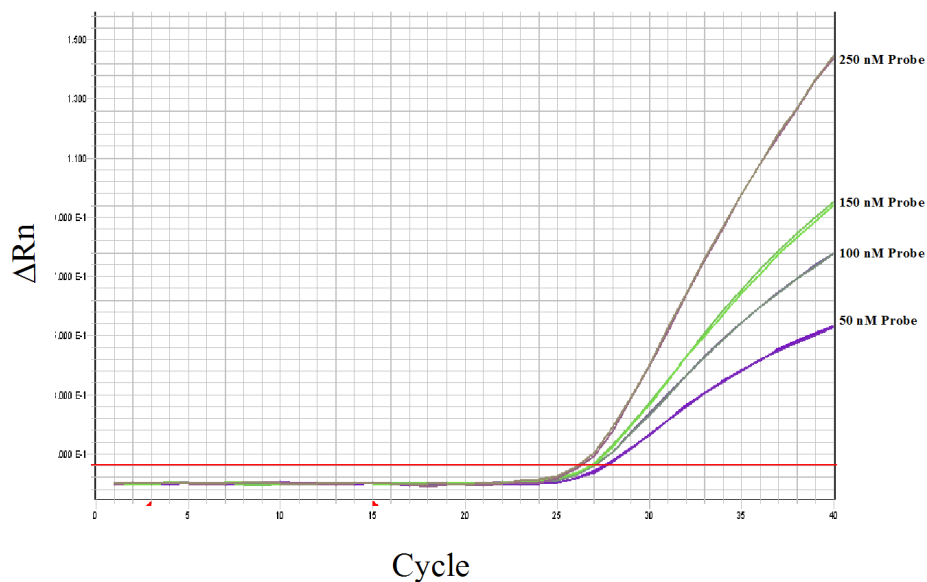

b) Log view

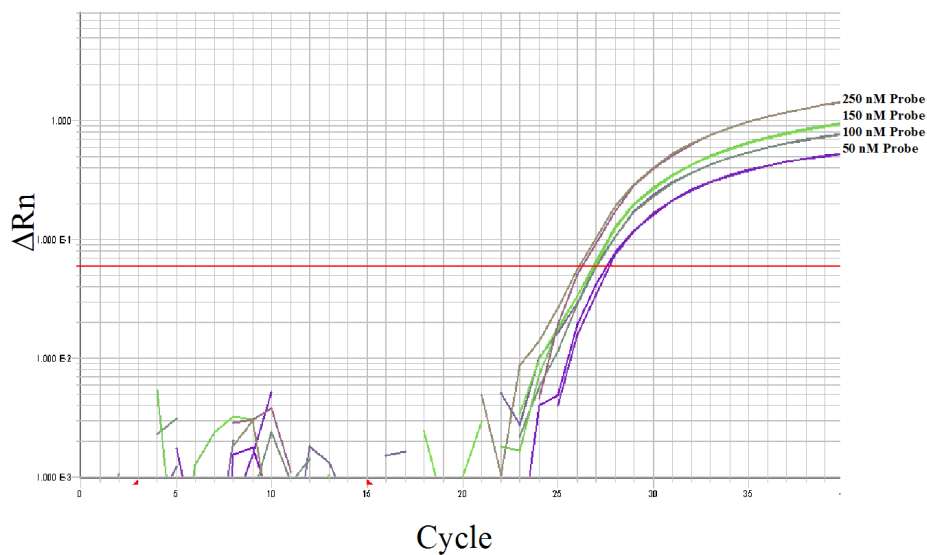

Figure 3-6 Amplification plot (linear and log views) of probe concentration titration from 50 to 250 nM

## For More Information

For information on:

- Using the TaqMan reagents, refer to:
  - *TaqMan<sup>®</sup> Fast Universal PCR Master Mix (2X) Protocol*
  - *TaqMan<sup>®</sup> Gene Expression Master Mix Protocol*
  - *TaqMan<sup>®</sup> Universal PCR Master Mix Protocol*
- Using the SYBR Green reagents, refer to:
  - *Power SYBR<sup>®</sup> Green PCR Master Mix and RT-PCR Protocol*
  - *SYBR<sup>®</sup> Green PCR Master Mix and RT-PCR Reagents Protocol*
  - *SYBR<sup>®</sup> Green PCR and RT-PCR Reagents Protocol*
- Performing quantitation experiments on the StepOne and StepOnePlus systems, refer to:
  - *Applied Biosystems StepOne<sup>™</sup> and StepOnePlus<sup>™</sup> Real-Time PCR Systems Getting Started Guide for Standard Curve Experiments*
  - *Applied Biosystems StepOne<sup>™</sup> and StepOnePlus<sup>™</sup> Real-Time PCR Systems Getting Started Guide for Relative Standard Curve and Comparative C<sub>T</sub> Experiments*
- Performing presence/absence experiments on the StepOne and StepOnePlus systems, refer to the *Applied Biosystems StepOne<sup>™</sup> and StepOnePlus<sup>™</sup> Real-Time PCR Systems Getting Started Guide for Presence/Absence Experiments*.



# Genotyping Experiments

---

# 4

This chapter covers:

<a href="#">Section 4.1 About Genotyping Experiments</a>	<a href="#">4-3</a>
<a href="#">Section 4.2 Design Guidelines</a>	<a href="#">4-9</a>



## Section 4.1 About Genotyping Experiments

---

This section covers:

Overview .....	4-4
Select the Assay Type .....	4-6

## Overview

### What Is a Genotyping Experiment?

A genotyping experiment is an endpoint experiment used to determine the genotype of unknown samples. With this experiment type, you can differentiate a single nucleotide polymorphism (SNP).

A genotyping experiment determines if unknown samples are:

- Homozygotes (samples having only allele 1)
- Homozygotes (samples having only allele 2)
- Heterozygotes (samples having both allele 1 and allele 2)

### Components

PCR reactions for genotyping experiments include the following components:

- **Sample** – The sample in which the genotype of the target is unknown.
- **(Optional) Replicates** – Identical reactions containing identical components and volumes.
- **Negative Controls** – Samples that contain water or buffer instead of template; also known as no template controls (NTCs). Negative controls should not amplify.
- **(Optional) Positive controls** – Samples that contain known genotypes (homozygotes for allele 1, homozygotes for allele 2, and heterozygotes for alleles 1 and 2).

### Instruments

Genotyping experiments require two steps: thermal cycling (PCR amplification) followed by endpoint detection of the resulting fluorescent signals. You can perform the thermal cycling step (PCR amplification) on the Applied Biosystems StepOne™ and StepOnePlus™ Real-Time PCR Systems or on a standalone thermal cycler.

If you use the StepOne™ and StepOnePlus™ systems:

- You can analyze the PCR, which is helpful for troubleshooting.
- Perform the endpoint plate read separately.

### How Genotyping Experiments Work

In genotyping experiments, the PCR includes a specific fluorescent-dye-labeled probe for each allele. The probes contain different fluorescent reporter dyes to differentiate each allele.

You can use TaqMan® minor groove binder (MGB) probes on the StepOne and StepOnePlus systems. Each TaqMan® MGB probe contains:

- A reporter dye at the 5' end of each probe
  - VIC® dye is linked to the 5' end of the Allele 1 probe
  - FAM™ dye is linked to the 5' end of the Allele 2 probe
- A minor groove binder (MGB)

This modification increases the melting temperature (T<sub>m</sub>) of probes without increasing probe length (Afonina *et al.*, 1997; Kutuyavin *et al.*, 1997), thereby allowing the design of shorter probes. Consequently, the TaqMan MGB probes exhibit greater differences in T<sub>m</sub> values between matched and mismatched probes; greater differences in T<sub>m</sub> values provide accurate genotyping.



- A nonfluorescent quencher (NFQ) at the 3' end of the probe

Because the quencher does not fluoresce, real-time PCR systems can measure reporter dye contributions more accurately.

During PCR, each probe anneals specifically to its complementary sequence between the forward and reverse primer sites. AmpliTaq Gold<sup>®</sup> DNA polymerase can cleave only probes that hybridize to the allele sequence (match). Cleavage separates the reporter dye from the quencher dye, increasing fluorescence of the reporter dye. Thus, the fluorescence signals generated during PCR amplification indicate the alleles that are present in the sample.

### Mismatches Between Probe and Allele Sequences

Mismatches between a probe and allele (Figure 4-1) reduce the efficiency of probe hybridization. Furthermore, AmpliTaq Gold DNA polymerase is likely to displace the mismatched probe rather than to cleave it to release reporter dye.

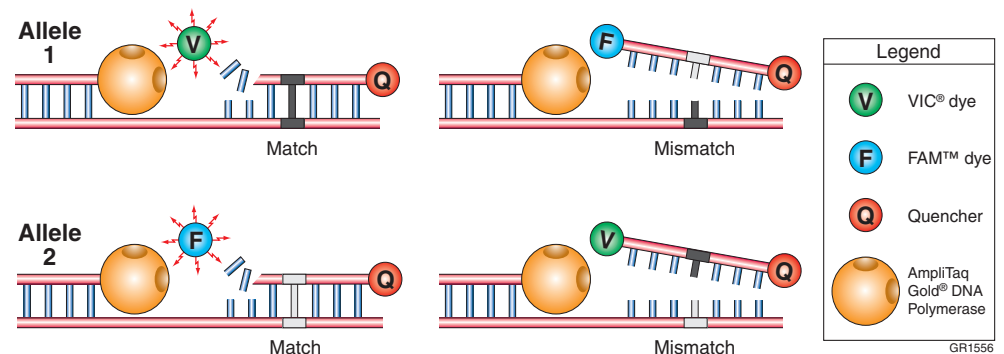

Figure 4-1 Results from matches and mismatches between allele and probe sequences in genotyping experiments

Table 4-1 summarizes the possible results of the genotyping experiment example shown above.

Table 4-1 Genotyping experiment results

A substantial increase in...	Indicates...
VIC <sup>®</sup> dye fluorescence only	homozygosity for Allele 1.
FAM <sup>™</sup> dye fluorescence only	homozygosity for Allele 2.
both fluorescent signals	heterozygosity.

### Workflow

Before performing genotyping experiments on the StepOne and StepOnePlus systems, prepare for the experiment as follows:

1. Select the assay type (below).
2. Review the design guidelines for the assay type you selected ([Section 4.2 on page 4-9](#)).

## Select the Assay Type

When you design your experiments with the StepOne software, you can select the following assay types for genotyping experiments:

- Pre-Designed/Validated (below)
- Custom ([page 4-7](#))

This section lists the products available for each assay type.

**Note:** The assays are specific to the target of interest. The master mixes contain the remaining components needed for the PCR reaction.

### Pre-Designed/ Validated Assays

Product	Attributes
TaqMan <sup>®</sup> SNP Genotyping Assays	<ul style="list-style-type: none"> <li>• Predesigned assays for high-density, genome-wide marker coverage.</li> <li>• For screening, association, candidate region, candidate gene, or fine-mapping studies.</li> <li>• Convenient single-tube format.</li> </ul>
TaqMan <sup>®</sup> Drug Metabolism Genotyping Assays	<ul style="list-style-type: none"> <li>• Detect polymorphisms in 220 genes that code for various drug metabolism enzymes and drug transporters.</li> <li>• For studying single-nucleotide polymorphisms (SNPs), insertions/deletions (in/dels), and multinucleotide polymorphisms (MNPs).</li> </ul>
Pre-Developed TaqMan <sup>®</sup> Assay Reagents for Allelic Discrimination	<ul style="list-style-type: none"> <li>• Genotype purified DNA samples for specific mutations; most assays discriminate between two alleles of single-nucleotide polymorphisms (SNPs).</li> <li>• Minor groove binder (MGB) added for better genotyping.</li> <li>• Allele 1 and 2 control DNA included to allow each homozygote signal to be generated on each run.</li> <li>• Closed-tube system requires no post-PCR manipulation or gels.</li> </ul>
TaqMan <sup>®</sup> Genotyping Master Mix	<p>Optimized for endpoint fluorescence detection in SNP genotyping applications:</p> <ul style="list-style-type: none"> <li>• Distinct clusters and high call rates for unambiguous allelic discrimination.</li> <li>• Excellent pre- and post-PCR stability for high-throughput setup and analysis.</li> <li>• Validated with TaqMan<sup>®</sup> SNP Genotyping Assays.</li> <li>• Simplifies assay implementation by using one reagent for all assays.</li> </ul>
TaqMan <sup>®</sup> 2X Universal PCR Master Mix (with or without AmpErase <sup>®</sup> UNG)	<ul style="list-style-type: none"> <li>• Provides optimal performance for TaqMan<sup>®</sup> assays that use cDNA or DNA as a template.</li> <li>• Contains components that ensure excellent assay performance.</li> <li>• Simplifies assay implementation by using one reagent for all assays.</li> </ul>

**Note:** Genotyping experiments are not supported for Fast or SYBR<sup>®</sup> Green master mixes and protocols.

For guidelines on designing your experiments with Pre-Designed/Validated assays, see [page 4-10](#).

## Custom Assays

Product	Attributes
Custom TaqMan <sup>®</sup> SNP Genotyping Assays	<ul style="list-style-type: none"> <li>Any possible single-nucleotide polymorphism (SNP) in any organism.</li> <li>Detect insertions/deletions (in/dels) of up to six bases.</li> <li>Detect multiple nucleotide polymorphisms (MNPs) of up to six bases.</li> <li>Convenient single-tube format.</li> </ul>
TaqMan <sup>®</sup> Genotyping Master Mix	<p>Optimized for endpoint fluorescence detection in SNP genotyping applications:</p> <ul style="list-style-type: none"> <li>Distinct clusters and high call rates for unambiguous allelic discrimination.</li> <li>Excellent pre- and post-PCR stability for high-throughput setup and analysis.</li> <li>Validated with TaqMan<sup>®</sup> SNP Genotyping Assays.</li> <li>Simplifies assay implementation by using one reagent for all assays.</li> </ul>
TaqMan <sup>®</sup> 2X Universal PCR Master Mix (with or without AmpErase <sup>®</sup> UNG)	<ul style="list-style-type: none"> <li>Provides optimal performance for TaqMan<sup>®</sup> assays that use cDNA or DNA as a template.</li> <li>Contains components that ensure excellent assay performance.</li> <li>Simplifies assay implementation by using one reagent for all assays.</li> </ul>

**Note:** Genotyping experiments are not supported for Fast or SYBR<sup>®</sup> Green master mixes and protocols.

For guidelines on designing your experiments with Custom assays, see [page 4-14](#).



---

## Section 4.2 Design Guidelines

---

This section covers:

Pre-Designed/Validated Assays . . . . .	4-10
TaqMan <sup>®</sup> SNP Genotyping Assays . . . . .	4-10
TaqMan <sup>®</sup> Drug Metabolism Genotyping Assays . . . . .	4-11
Pre-Developed TaqMan <sup>®</sup> Assay Reagents for Allelic Discrimination . . . . .	4-12
Select the Master Mix . . . . .	4-13
Design the Experiment . . . . .	4-14
Custom Assays . . . . .	4-14
Custom TaqMan <sup>®</sup> SNP Genotyping Assays . . . . .	4-14
Select the Master Mix . . . . .	4-16
Design the Experiment . . . . .	4-16

## Pre-Designed/Validated Assays

**Workflow** If you are designing a genotyping experiment using Applied Biosystems Pre-Designed/Validated assays, Applied Biosystems recommends that you follow the workflow below:

1. Select the assay:
  - TaqMan<sup>®</sup> SNP Genotyping Assays (below).
  - TaqMan<sup>®</sup> Drug Metabolism Genotyping Assays ([page 4-11](#)).
  - TaqMan<sup>®</sup> Pre-Developed Assays Reagents for Allelic Discrimination ([page 4-12](#)).
2. Select the master mix ([page 4-13](#)).
3. Design the experiment using the StepOne<sup>™</sup> software ([page 4-14](#)).

## TaqMan<sup>®</sup> SNP Genotyping Assays

**Product Description** TaqMan<sup>®</sup> SNP Genotyping Assays are a comprehensive collection of primer and probe sets for genotyping single nucleotide polymorphisms (SNPs) for human studies.

The assays:

- Use TaqMan<sup>®</sup> reagents to amplify and detect specific SNP alleles in purified genomic DNA samples.
- Are designed using Applied Biosystems bioinformatics pipeline and software, as well as genomic information from Celera Genomics and public databases.
- Are designed and optimized to work with an Applied Biosystems TaqMan<sup>®</sup> master mix, using universal thermal cycling conditions.

**Product Requirements** All TaqMan SNP Genotyping Assays require:

- Three components:
  - 1 to 20 ng of purified genomic DNA sample.
  - 20X, 40X, or 80X SNP Genotyping Assay Mix (specific for each polymorphism). Each assay consists of sequence-specific forward and reverse primers to amplify the SNP of interest and two TaqMan MGB probes: One probe labeled with VIC<sup>®</sup> dye detects the Allele 1 sequence; one probe labeled with FAM<sup>™</sup> dye detects the Allele 2 sequence.
  - TaqMan<sup>®</sup> Genotyping Master Mix or TaqMan<sup>®</sup> 2X Universal PCR Master Mix (with or without AmpErase<sup>®</sup> UNG).
- PCR amplification and an endpoint read to obtain results.

- Available Assays** TaqMan SNP Genotyping Assays are available as TaqMan® Pre-Designed SNP Genotyping Assays:
- Over 4.5 million predesigned genome-wide assays, including 3.5 million human HapMap SNPs, 70,000 human cSNPs, 160,000 human validated, and 10,000 mouse assays.
  - Available in small, medium, and large scale.
  - Made to Order (that is, manufactured at the time of order).
- For More Information**
- For information on the latest available products and specific product uses, refer to the Applied Biosystems Web sites:  
<http://www.allsnps.com/>  
*and/or*  
<http://www.appliedbiosystems.com/>
    - a. On the Home page, under TaqMan® Products, select **TaqMan® SNP Genotyping Assays**.
    - b. On the SNP Genotyping Assays page, under Pre-Designed/Validated Assays, select **TaqMan® SNP Genotyping Assays**.
  - For information on preparing PCR reactions using the TaqMan SNP Genotyping Assays, refer to the *TaqMan® SNP Genotyping Assays Protocol*.

## TaqMan® Drug Metabolism Genotyping Assays

- Product Description** TaqMan® Drug Metabolism Genotyping Assays are a comprehensive collection of Inventoried primer and probe sets for genotyping SNPs, insertions and deletions (indels), and multiple nucleotide polymorphisms (MNPs) in drug metabolism related genes.
- The assays:
- Use TaqMan reagents to amplify and detect specific polymorphisms in purified genomic DNA samples.
  - Are designed using Applied Biosystems bioinformatics pipeline and software, as well as genomic information from public SNP databases and public genome assemblies.
  - Are designed and optimized to work with Applied Biosystems TaqMan® master mixes.
- Product Requirements** All TaqMan Drug Metabolism Genotyping Assays require:
- Three components:
    - 3 to 30 ng of purified genomic DNA sample.
    - 20X Drug Metabolism Genotyping Assay Mix (specific for each polymorphism). Each assay consists of sequence-specific forward and reverse primers to amplify the polymorphic sequence of interest and two TaqMan MGB probes: One probe labeled with VIC dye detects the Allele 1 sequence; one probe labeled with FAM dye detects the Allele 2 sequence.
    - TaqMan® Genotyping Master Mix or TaqMan® 2X Universal PCR Master Mix (with or without AmpErase® UNG).

**For More Information**

- PCR amplification and an endpoint read to obtain results.
- For information on the latest available products and specific product uses, refer to the Applied Biosystems Web sites:  
<http://www.allsnps.com/>  
and/or  
<http://www.appliedbiosystems.com/>
  - a. On the Home page, under TaqMan<sup>®</sup> Products, select **TaqMan<sup>®</sup> SNP Genotyping Assays**.
  - b. On the SNP Genotyping Assays page, under Pre-Designed/Validated Assays, select **TaqMan<sup>®</sup> Drug Metabolism Genotyping Assays**.
- For information on preparing PCR reactions using the TaqMan SNP Genotyping Assays, refer to the *TaqMan<sup>®</sup> Drug Metabolism Genotyping Assays Protocol*.

**Pre-Developed TaqMan<sup>®</sup> Assay Reagents for Allelic Discrimination****Product Description**

Pre-Developed TaqMan<sup>®</sup> Assay Reagents for Allelic Discrimination (TaqMan<sup>®</sup> PDARs for AD) are inventoried assays optimized for the discrimination of specific alleles.

The assays:

- Use TaqMan reagents to amplify and detect specific polymorphisms in purified genomic DNA samples.
- Are designed and optimized to work with an Applied Biosystems TaqMan<sup>®</sup> master mix, using universal thermal cycling conditions.

**Product Requirements**

TaqMan PDARs for AD require three components:

- 2 to 20 ng of purified genomic DNA sample.
- 10X Allelic Discrimination Assay Mix (specific for each polymorphism). Each assay consists of sequence-specific forward and reverse primers to amplify the polymorphic sequence of interest and two TaqMan MGB probes: One probe labeled with VIC dye detects the Allele 1 sequence; one probe labeled with FAM dye detects the Allele 2 sequence.
- TaqMan<sup>®</sup> Genotyping Master Mix or TaqMan<sup>®</sup> 2X Universal PCR Master Mix (with or without AmpErase<sup>®</sup> UNG).

**Note:** Allele 1 and 2 control DNA is included with each assay to allow each homozygote signal to be generated on each run.

**For More Information**

- For information on the latest available products and specific product uses, refer to the Applied Biosystems Web sites:  
<http://www.allsnps.com/>  
and/or  
<http://www.appliedbiosystems.com/>
  - a. On the Home page, under TaqMan<sup>®</sup> Products, select **TaqMan<sup>®</sup> SNP Genotyping Assays**.



- b. On the SNP Genotyping Assays page, under Pre-Designed/Validated Assays, select **TaqMan® Pre-Developed Assay Reagents for Allelic Discrimination (TaqMan® PDARs for AD)**.
- For information on preparing PCR reactions using the TaqMan PDARs for Allelic Discrimination, refer to the *Pre-Developed TaqMan® Assay Reagents Allelic Discrimination Protocol*.

## Select the Master Mix

**Available Master Mixes** Applied Biosystems Pre-Designed/Validated assays for genotyping experiments are designed to work with the following master mixes:

- TaqMan PDARs for AD contain TaqMan® 2X Universal PCR Master Mix (with AmpErase® UNG).
- TaqMan SNP Genotyping Assays and Custom TaqMan SNP Genotyping Assays can be used with:

Master Mix	Part Number
TaqMan® Genotyping Master Mix, 1-Pack (1 × 10 mL), 400 reactions	4371355
TaqMan® Genotyping Master Mix, 1 Bulk Pack (1 × 50 mL), 2000 reactions	4371357
TaqMan® 2X Universal PCR Master Mix, 200 Reactions	4304437
TaqMan® 2X Universal PCR Master Mix, 2000 Reactions	4326708
10-Pack, TaqMan® 2X Universal PCR Master Mix	4305719
TaqMan® 2X Universal PCR Master Mix, No AmpErase® UNG, 200 Reactions	4324018
TaqMan® 2X Universal PCR Master Mix, No AmpErase® UNG, 2000 Reactions	4326614
10-Pack, TaqMan® 2X Universal PCR Master Mix, No AmpErase® UNG	4324020

**Note:** Genotyping experiments are not supported for Fast or SYBR® Green master mixes and protocols.

### For More Information

For information on using the TaqMan master mixes, refer to the:

- TaqMan® Genotyping Master Mix Protocol*
- TaqMan® Universal PCR Master Mix Protocol*

## Design the Experiment

**Use the StepOne Software** For Applied Biosystems Pre-Designed/Validated assays, use the StepOne software to design your genotyping experiments. The StepOne software automatically calculates volumes for the:

- Reaction mix components
- Sample dilutions

**Note:** To select a SNP assay in the StepOne software, go to the SNP Assays screen in the Design Wizard or to the Plate Setup screen in Advanced Setup. In the SNP Assays screen or Plate Setup screen, you can select an assay from the library or create a new assay.

**For More Information** For information on designing and performing genotyping experiments on the StepOne and StepOnePlus systems, refer to *Applied Biosystems StepOne™ and StepOnePlus™ Real-Time PCR Systems Getting Started Guide for Genotyping Experiments*.

## Custom Assays

**Workflow** If you are designing a genotyping experiment using Applied Biosystems Custom assays, Applied Biosystems recommends that you follow the workflow below:

1. Order the assay: Custom TaqMan® SNP Genotyping Assays (below).
2. Select the master mix ([page 4-16](#)).
3. Design the experiment using the StepOne software ([page 4-16](#)).

## Custom TaqMan® SNP Genotyping Assays

**Product Description** Custom TaqMan® SNP Genotyping Assays are TaqMan probe and primer sets that are designed, synthesized, and formulated by the Custom TaqMan® Genomic Assays service based on sequence information that you submit. Custom TaqMan SNP Genotyping Assays allow you to:

Action	Example
Perform genotyping studies with any possible single-nucleotide polymorphism (SNP) in any organism	AGTTCATCCATGGTCA --> AGTTCATACATGGTCA Annotated as: AGTTCAT[C/A]CATGGTCA
Detect insertions/deletions (in/dels) of up to six bases for genotyping studies	AGTTCATCCATGGTCA --> AGTTCATGGTCA Annotated as: AGTTCAT[CCAT/*]GGTCA
Detect multiple nucleotide polymorphisms (MNPs) of up to six bases for genotyping studies	AGTTCATCCGGTCA --> AGTTCATATGGTCA Annotated as: AGTTCAT[CC/AT]GGTCA

The assays:

- Use TaqMan reagents to amplify and detect specific polymorphisms in purified genomic DNA (gDNA).
- Are developed using proprietary assay-design software.
- Are designed and optimized to work with an Applied Biosystems TaqMan<sup>®</sup> master mix, using universal thermal cycling conditions.

## Product Requirements

All Custom TaqMan SNP Genotyping Assays require:

- A submission file that includes your target SNP sequence. You create the submission file using free File Builder software, then submit the file to the Custom TaqMan<sup>®</sup> Genomic Assays service.
- Three components:
  - 1 to 20 ng of purified gDNA sample per well.
  - 40X SNP Genotyping Assay or 80X SNP Genotyping Assay (specific for each polymorphism). Each assay consists of sequence-specific forward and reverse primers to amplify the SNP of interest and two TaqMan MGB probes: One probe labeled with VIC dye detects the Allele 1 sequence; one probe labeled with FAM dye detects the Allele 2 sequence.
  - TaqMan<sup>®</sup> Genotyping Master Mix or TaqMan<sup>®</sup> Universal PCR Master Mix (with or without AmpErase<sup>®</sup> UNG).
- PCR amplification and an endpoint read to obtain results.

## For More Information

- For information on the latest available products and specific product uses, refer to the Applied Biosystems Web sites:

<http://www.allsnps.com/>

and/or

<http://www.appliedbiosystems.com/>

- On the Home page, under TaqMan<sup>®</sup> Products, select **TaqMan<sup>®</sup> SNP Genotyping Assays**.
  - On the SNP Genotyping Assays page, under Custom Assays, select **Custom TaqMan<sup>®</sup> SNP Genotyping Assays**.
- For information on ordering Custom TaqMan SNP Genotyping Assays, refer to the *Custom TaqMan<sup>®</sup> Genomic Assays Protocol: Submission Guidelines*.
  - For information on preparing PCR reactions using the Custom TaqMan SNP Genotyping Assays, refer to the *Custom TaqMan<sup>®</sup> SNP Genotyping Assays Protocol*.

## Select the Master Mix

**Available Master Mixes** Applied Biosystems Made to Order assays for genotyping experiments are designed to work with the following master mixes:

Master Mix	Part Number
TaqMan <sup>®</sup> Genotyping Master Mix, 1-Pack (1 × 10 mL), 400 reactions	4371355
TaqMan <sup>®</sup> Genotyping Master Mix, 1 Bulk Pack (1 × 50 mL), 2000 reactions	4371357
TaqMan <sup>®</sup> 2X Universal PCR Master Mix, 200 Reactions	4304437
TaqMan <sup>®</sup> 2X Universal PCR Master Mix, 2000 Reactions	4326708
10-Pack, TaqMan <sup>®</sup> 2X Universal PCR Master Mix	4305719
TaqMan <sup>®</sup> 2X Universal PCR Master Mix, No AmpErase <sup>®</sup> UNG, 200 Reactions	4324018
TaqMan <sup>®</sup> 2X Universal PCR Master Mix, No AmpErase <sup>®</sup> UNG, 2000 Reactions	4326614
10-Pack, TaqMan <sup>®</sup> 2X Universal PCR Master Mix, No AmpErase <sup>®</sup> UNG	4324020

**Note:** Genotyping experiments are not supported for Fast or SYBR<sup>®</sup> Green master mixes and protocols.

**For More Information** For information on using the TaqMan master mixes, refer to the:

- *TaqMan<sup>®</sup> Genotyping Master Mix Protocol*
- *TaqMan<sup>®</sup> Universal PCR Master Mix Protocol*

## Design the Experiment

**Use the StepOne Software** For Applied Biosystems Custom assays, use the StepOne software to design your genotyping experiments. The StepOne software automatically calculates volumes for the:

- Reaction mix components
- Sample dilutions

**Note:** To select a SNP assay in the StepOne software, go to the SNP Assays screen in the Design Wizard or to the Plate Setup screen in Advanced Setup. In the SNP Assays screen or Plate Setup screen, you can select an assay from the library or create a new assay.

**For More Information** For information on designing and performing genotyping experiments on the StepOne and StepOnePlus systems, refer to *Applied Biosystems StepOne<sup>™</sup> and StepOnePlus<sup>™</sup> Real-Time PCR Systems Getting Started Guide for Genotyping Experiments*.

# Presence/Absence Experiments

---

# 5

This chapter covers:

<a href="#">Section 5.1 About Presence/Absence Experiments</a>	5-3
<a href="#">Section 5.2 Design Guidelines</a>	5-9



## Section 5.1 About Presence/Absence Experiments

---

This section covers:

Overview .....	5-4
Select the Assay Type .....	5-6

## Overview

### What Is a Presence/Absence Experiment?

A presence/absence experiment is an endpoint experiment that indicates the presence or absence of a specific nucleic acid sequence (target) in a sample. The actual quantity of target is not determined.

Presence/absence experiments are commonly used to detect the presence or absence of a pathogen, such as a viral or bacterial pathogen. For example, a presence/absence experiment might be used to determine if *Salmonella* bacteria are present in hamburger meat. The results will show if *Salmonella* bacteria are present or are not present; the quantity of bacteria is not determined.

### Components

PCR reactions for presence/absence experiments include the following components:

- **Sample** – The sample in which the presence of a target is unknown.
- **Replicates** – Identical reactions containing identical components and volumes.
- **Internal positive control (IPC)** – A short synthetic DNA template that is added to PCR reactions. You can use the IPC to distinguish between true negative results and reactions affected by PCR inhibitors, incorrect assay setup, or a reagent or instrument failure.

**Note:** Presence/absence experiments can be performed without an IPC; however, the IPC ensures that a failed PCR is not mistaken for a negative test result.

- **Negative Controls** – Wells that contain water or buffer instead of sample template. No amplification of the target should occur in negative control wells.

In the StepOne software, you can set up the PCR reactions for the presence/absence experiments three different ways:

Setup	Well Types
IPC setup	<p>There are three types of wells:</p> <ul style="list-style-type: none"> <li>• <b>Unknown-IPC wells</b> – Wells contain sample template and IPC template; the presence of the target is not known.</li> <li>• <b>Negative control-IPC wells</b> – Wells contain IPC template and water or buffer instead of sample template in the PCR reaction. Only the IPC template should amplify in negative control-IPC wells because the reaction contains no sample template. Also called <i>IPC+</i>.</li> <li>• <b>Negative control-blocked IPC wells</b> – Wells contain IPC blocking agent instead of sample template in the PCR reaction. No amplification should occur in negative control-blocked IPC wells because the reaction contains no sample template and amplification of the IPC is blocked. Also called <i>no amplification control (NAC)</i>.</li> </ul>
No IPC, singleplex setup	<p>There are two types of wells:</p> <ul style="list-style-type: none"> <li>• <b>Unknown wells</b> – Wells contain sample template; the presence of the target is not known.</li> <li>• <b>Negative controls</b> – Wells contain water or buffer instead of sample template.</li> </ul>



Setup	Well Types
No IPC, multiplex setup	<p>There are two types of wells:</p> <ul style="list-style-type: none"> <li>• <b>Unknown-Unknown wells</b> – Wells contain sample template; the presence of the target is not known.</li> <li>• <b>Negative control-Negative control wells</b> – Wells contain water or buffer instead of sample template.</li> </ul>

### Endpoint Detection and Post-PCR Plate Read

Presence/absence experiments are endpoint experiments in which fluorescence data are collected after the PCR is complete.

To aid in troubleshooting presence/absence experiments, you can use the Applied Biosystems StepOne™ and StepOnePlus™ Real-Time PCR Systems to perform real-time PCR. If you use the StepOne™ and StepOnePlus™ systems for PCR amplification, perform the pre-PCR read and post-PCR read runs separately.

### How Presence/Absence Experiments Work

During the PCR, the fluorogenic probes anneal specifically to the complementary target between the forward and reverse primer sites on the template DNA. Then during extension, AmpliTaq Gold® DNA polymerase cleaves the hybridized probes in each sample containing the target. The cleavage of each matched probe separates the reporter dye from the quencher dye, resulting in increased fluorescence by the reporter.

After PCR cycling, the StepOne™ and StepOnePlus™ instruments read the fluorescence generated during the PCR amplification. The fluorescent signals are used to determine the presence or absence of the target in each sample. Reporter signals are normalized to the emission of a passive reference, as follows:

$$R_{n(TT)} = \frac{\text{Emission Intensity of Target Template Sequence}}{\text{Emission Intensity of Passive Reference}}$$

$$R_{n(IPC)} = \frac{\text{Emission Intensity of Internal Positive Control}}{\text{Emission Intensity of Passive Reference}}$$

### Incorporating an IPC

An IPC is a second TaqMan® probe and primer set added to the reaction plate to detect a low-copy, constitutive nucleic acid. The IPC and the target are amplified simultaneously in the same reaction well. If a well does not exhibit amplification, the StepOne™ software uses the positive signal from the IPC to confirm that the well failed to amplify because of a lack of target template, rather than because of a pipetting error or inhibition.

**Note:** Presence/absence experiments can be performed without an IPC; however, the IPC ensures that a failed PCR is not mistaken for a negative test result.

**Workflow** Before performing presence/absence experiments on the StepOne and StepOnePlus systems, prepare for the experiment as follows:

1. Select the assay type (below).
2. Review the design guidelines for the assay type you selected ([Section 5.2 on page 5-9](#)).

## Select the Assay Type

When you design your experiments with the StepOne software, you can select the following assay types for presence/absence experiments:

- Inventoried/Made to Order ([page 5-7](#))
- Custom ([page 5-8](#))

This section lists the products available for each assay type.

**Note:** The assays are specific to the target of interest. The master mixes contain the remaining components needed for the PCR reaction.

## Inventoried/Made to Order Assays

Product	Attributes
TaqMan® Gene Expression Assays	<ul style="list-style-type: none"> <li>• Predesigned, gene-specific primer and probe sets for human, mouse, rat, <i>Arabidopsis</i>, <i>Drosophila</i>, <i>C. elegans</i>, <i>C. familiares</i> (dog), and <i>M. mulatta</i> (Rhesus) genes.</li> <li>• Probe is a FAM™ dye-labeled MGB probe.</li> <li>• Provided in a convenient, single, 205 tube.</li> <li>• Available as Inventoried or Made to Order assays.</li> </ul>
TaqMan® Endogenous Control Assays <b>Note:</b> FAM™ dye-labeled TaqMan® Endogenous Control Assays are included as Inventoried TaqMan Gene Expression Assays.	<ul style="list-style-type: none"> <li>• Optimized, preformulated, ready-to-use endogenous control assays.</li> <li>• Cost-effective gene expression quantitation for human, mouse, rat, <i>Arabidopsis</i>, <i>Drosophila</i>, and any eukaryotic species.</li> <li>• Choice of FAM™ dye or VIC® dye labels (primer-limited).</li> </ul>
Custom TaqMan® Gene Expression Assays	<ul style="list-style-type: none"> <li>• Any species or organism.</li> <li>• Target of your choice.</li> <li>• Probe is a FAM™ dye-labeled MGB probe.</li> <li>• Provided in a convenient, single, 205 tube.</li> </ul>
TaqMan® Gene Expression Master Mix	<p>Tailored for precise quantitation by real-time PCR for routine and challenging experiments:</p> <ul style="list-style-type: none"> <li>• Sensitive detection down to 1 copy of target.</li> <li>• Multiplex PCR for co-amplifying two targets in a single reaction.</li> <li>• Specificity for differentiation between gene family members.</li> <li>• Validated with TaqMan® Gene Expression Assays.</li> <li>• Simplifies assay implementation by using one reagent for all assays.</li> </ul>
TaqMan® 2X Universal PCR Master Mix (with or without AmpErase® UNG)	<ul style="list-style-type: none"> <li>• Provides optimal performance for TaqMan® assays that use cDNA or DNA as a template.</li> <li>• Contains components that ensure excellent assay performance.</li> <li>• Simplifies assay implementation by using one reagent for all assays.</li> </ul>

**IMPORTANT!** Applied Biosystems does not recommend the use of TAMRA™ dye as a reporter or quencher with the StepOne system. TAMRA dye may be used as a reporter or quencher with the StepOnePlus system.

**Note:** Presence/absence experiments are not supported for Fast or SYBR® Green master mixes and protocols.

For guidelines on designing your experiments with Inventoried/Made to Order assays, see [page 5-10](#).

## Custom Assays

Product	Attributes
Custom TaqMan® Probes and Primers	<ul style="list-style-type: none"> <li>Any species or organism.</li> <li>Choice of dye labels, quenchers, and synthesis scales.</li> <li>For use with the Primer Express® Software and Applied Biosystems Assay Design Guidelines.</li> </ul>
Primer Express® Software	Software that designs primers and probes for real-time PCR.
TaqMan® Gene Expression Master Mix	<p>Tailored for precise quantitation by real-time PCR for routine and challenging experiments:</p> <ul style="list-style-type: none"> <li>Sensitive detection down to 1 copy of target.</li> <li>Multiplex PCR for co-amplifying two targets in a single reaction.</li> <li>Specificity for differentiation between gene family members.</li> <li>Validated with TaqMan® Gene Expression Assays.</li> <li>Simplifies assay implementation by using one reagent for all assays.</li> </ul>
TaqMan® 2X Universal PCR Master Mix (with or without AmpErase® UNG)	<ul style="list-style-type: none"> <li>Provides optimal performance for TaqMan® assays that use cDNA or DNA as a template.</li> <li>Contains components that ensure excellent assay performance.</li> <li>Simplifies assay implementation by using one reagent for all assays.</li> </ul>

**IMPORTANT!** Applied Biosystems does not recommend the use of TAMRA™ dye as a reporter or quencher with the StepOne system. TAMRA dye may be used as a reporter or quencher with the StepOnePlus system.

**Note:** Presence/absence experiments are not supported for Fast or SYBR® Green master mixes and protocols.

For guidelines on designing your experiments with Custom assays, see [page 5-16](#).

## Section 5.2 Design Guidelines

---

This section covers:

Inventoried/Made to Order Assays . . . . .	5-10
TaqMan <sup>®</sup> Gene Expression Assays . . . . .	5-10
Custom TaqMan <sup>®</sup> Gene Expression Assays . . . . .	5-12
TaqMan <sup>®</sup> Exogenous Internal Positive Control Reagents . . . . .	5-13
Select the Master Mix . . . . .	5-15
Design the Experiment . . . . .	5-16
Custom Assays . . . . .	5-16

## Inventoried/Made to Order Assays

**Workflow** If you select the Inventoried/Made to Order assay type in the StepOne™ software, Applied Biosystems recommends that you follow the workflow below:

1. Select the assay:
  - TaqMan® Gene Expression Assays (below).
  - Custom TaqMan® Gene Expression Assays ([page 5-12](#)).
2. Use the TaqMan® Exogenous Internal Positive Control Reagents ([page 5-13](#)).
 

**Note:** Presence/absence experiments can be performed without an IPC; however, the IPC ensures that a failed PCR is not mistaken for a negative test result.
3. Select the master mix ([page 5-15](#)).
4. Design the experiment using the StepOne software ([page 5-16](#)).

## TaqMan® Gene Expression Assays

**Product Description** TaqMan® Gene Expression Assays are a comprehensive collection of Inventoried and Made to Order probe and primer sets that you can use to perform presence/absence experiments on human, mouse, rat, *Arabidopsis*, *Drosophila*, *C. elegans*, *C. familiares* (dog), and *M. mulatta* (Rhesus) genes.

The assays:

- Use TaqMan® reagents to amplify and detect the target in cDNA samples.
- Are designed using an automated design and quality-controlled pipeline. Inventoried assays are manufactured and placed in inventory; Made to Order assays are predesigned and manufactured when ordered.
- Are designed and optimized to work with an Applied Biosystems TaqMan® master mix, using universal thermal cycling conditions.
- When possible, amplify target cDNA without amplifying genomic DNA (*m* suffix in assay ID) by designing probes that cross exon-exon junctions.

**Product Requirements** All TaqMan Gene Expression Assays require:

- Three components:
  - 1 to 100 ng of cDNA sample (converted from RNA) per well, with all wells in a study having the same amount of cDNA.
  - 20× Gene Expression Assay Mix (specific for each target). Each assay mix consists of two unlabeled PCR primers and a FAM™ dye-labeled TaqMan® MGB (minor groove binder) probe in a preformulated 20× mix. 1× final concentrations are 250 nM for the probe and 900 nM for each primer.
  - TaqMan® Gene Expression Master Mix or TaqMan Universal PCR Master Mix (with or without AmpErase UNG).

**Available Assays** TaqMan Gene Expression Assays are available for human, mouse, rat, *Arabidopsis*, *Drosophila*, *C. elegans*, *C. familiares* (dog), and *M. mulatta* (Rhesus) genes. The part numbers are:

- PN 4331182 for Inventoried assays
- PN 4351372 for Made to Order assays

The prefix of the assay name indicates the species for which the assay was designed: *Hs* for *Homo sapiens* (human), *Mm* for *Mus musculus* (mouse), *Rn* for *Rattus norvegicus* (rat), *At* for *Arabidopsis thaliana*, *Dm* for *Drosophila melanogaster*, *Ce* for *C. elegans*, *Cf* for *C. familiares* (dog), and *Rh* for *M. mulatta* (Rhesus).

The suffix of the assay name indicates the assay placement, as described in the table below.

Suffix	Description
<i>_m</i>	The assay's probe spans an exon junction; the assay does not detect genomic DNA.
<i>_s</i>	The assay's primers and probes are designed within a single exon; the assay does detect genomic DNA.
<i>_g</i>	The assay may detect genomic DNA; the assay's primers and probes may be within a single exon.
<i>_mH</i>	The assay was designed to a transcript belonging to a gene family with high sequence homology. The assay provides between 10 C <sub>T</sub> and 15 C <sub>T</sub> difference between the target gene and the gene with the closest sequence homology. Therefore, the assay detects the target transcript with 1000- to 30,000-fold greater discrimination (sensitivity) than the closest homologous transcript, if they are present at the same copy number in a sample.
<i>_sH</i>	
<i>_gH</i>	
<i>_u</i>	The assay's amplicon spans an exon junction and the probe sits completely in one of the spanned exons.

### TaqMan<sup>®</sup> Endogenous Control Assays

TaqMan<sup>®</sup> Endogenous Control Assays are available as:

- Inventoried TaqMan Gene Expression Assays (PN 4331182) – Each assay contains a FAM<sup>™</sup> dye-labeled TaqMan<sup>®</sup> MGB probe in a single, preformulated 20X tube.
- Individual control assays for all human, mouse, and rat species (various part numbers) – Each assay contains either a FAM<sup>™</sup> dye-labeled TaqMan<sup>®</sup> MGB probe, a VIC<sup>®</sup> dye-labeled TaqMan<sup>®</sup> MGB probe, or a TAMRA<sup>™</sup> dye-labeled probe. TaqMan Endogenous Controls with VIC dye labels are primer-limited.

**IMPORTANT!** Applied Biosystems does not recommend the use of TAMRA<sup>™</sup> dye as a reporter or quencher with the StepOne system. TAMRA dye may be used as a reporter or quencher with the StepOnePlus system.

**For More Information**

- For information on the latest available products and specific product uses, refer to the Applied Biosystems Web site:

<http://www.appliedbiosystems.com/>

- a. On the Home page, under TaqMan® Products, select **TaqMan® Gene Expression Assays**.
- b. On the Gene Expression Assays & Arrays page:
  - Under Individual Assays, select **TaqMan® Gene Expression Assays**. This option links to all TaqMan Gene Expression Assays, including TaqMan Endogenous Control Assays that contain FAM dye-labeled probes.

or

- Under Individual Control Assays, select **TaqMan® Endogenous Control Assays**. This option links to the individual TaqMan Endogenous Control Assays (that contain FAM dye-labeled TaqMan MGB probes, VIC dye-labeled TaqMan MGB probes, or TAMRA dye-labeled probes).
- For information on Custom TaqMan Endogenous Control Assays, refer to the *Using TaqMan® Endogenous Control Assays to Select an Endogenous Control for Experimental Studies Application Note*.
- For information on preparing PCR reactions using the TaqMan Gene Expression Assays, refer to the *TaqMan® Gene Expression Assays Protocol*.

**Custom TaqMan® Gene Expression Assays****Product Description**

Custom TaqMan® Gene Expression Assays are TaqMan probe and primer sets that are designed, synthesized, and formulated by the Custom TaqMan® Genomic Assays service based on sequence information that you submit. Custom TaqMan Gene Expression Assays allow you to perform presence/absence experiments on any gene or splice variant in any organism.

The assays:

- Use TaqMan® reagents to amplify and detect the target in cDNA samples.
- Are developed using proprietary assay-design software.
- Are designed and optimized to work with an Applied Biosystems TaqMan® master mix, using universal thermal cycling conditions.

**Product Requirements**

All Custom TaqMan Gene Expression Assays require:

- A submission file that includes your target sequence. You create the submission file using free File Builder software, then submit the file to the Custom TaqMan® Genomic Assays service.
- Three components:
  - 1 to 100 ng of cDNA sample (converted from RNA) per well, with all wells in a study having the same amount of cDNA.
  - 20× Gene Expression Assay or 60× Gene Expression Assay (specific for each target). Each assay consists of two target-specific primers and a FAM™ dye-labeled TaqMan MGB probe in a preformulated 20× or 60× mix. 1× final concentrations are 250 nM for the probe and 900 nM for each primer.



- TaqMan<sup>®</sup> Gene Expression Master Mix or TaqMan Universal PCR Master Mix (with or without AmpErase UNG).
- For More Information**
- For information on the latest available products and specific product uses, refer to the Applied Biosystems Web site:  
<http://www.appliedbiosystems.com/>
    - a. On the Home page, under TaqMan<sup>®</sup> Products, select **TaqMan<sup>®</sup> Gene Expression Assays**.
    - b. On the Gene Expression Assays & Arrays page, under Individual Assays, select **Custom TaqMan<sup>®</sup> Gene Expression Assays**.
  - For information on ordering Custom TaqMan Gene Expression Assays, refer to the *Custom TaqMan<sup>®</sup> Genomic Assays Protocol: Submission Guidelines*.
  - For information on preparing PCR reactions using the Custom TaqMan Gene Expression Assays, refer to the *Custom TaqMan<sup>®</sup> Gene Expression Assays Protocol*.

## TaqMan<sup>®</sup> Exogenous Internal Positive Control Reagents

**Product Description** The Applied Biosystems TaqMan<sup>®</sup> Exogenous Internal Positive Control Reagents contain:

- An internal positive control (IPC) with predesigned primers and probe
- IPC DNA template
- IPC blocking control

The reagents are designed to:

- Distinguish types of negative results:
  - A negative call for the target and positive call for the IPC indicates that no target is present.
  - A negative call for the target and negative call for the IPC suggests PCR inhibition.
- Avoid amplification of endogenous controls.
- Permit co-amplification of the IPC and the target without compromising amplification of the target.
- Detect the IPC using a VIC<sup>®</sup> dye-labeled probe.
- Detect the target using a FAM<sup>™</sup> dye-labeled probe.
- Work with the TaqMan<sup>®</sup> 2× Universal PCR Master Mix (with or without AmpErase<sup>®</sup> UNG), using universal thermal cycling conditions.

**Product Requirements** The TaqMan Exogenous Internal Positive Control Reagents kits require the following components:

- DNA sample
- TaqMan assay for your target of interest
- TaqMan 2× Universal PCR Master Mix (with or without AmpErase UNG)

**Available Kits** The following TaqMan Exogenous Internal Positive Control Reagents kits are available from Applied Biosystems:

Kits	Part Number
TaqMan <sup>®</sup> Exogenous Internal Positive Control Reagents with TaqMan <sup>®</sup> 2X Universal PCR Master Mix (with VIC <sup>®</sup> dye)	4308320
TaqMan <sup>®</sup> Exogenous Internal Positive Control Reagents <b>Note:</b> If you are using this kit, you will need to purchase one of these TaqMan <sup>®</sup> reagents separately: <ul style="list-style-type: none"> <li>• TaqMan<sup>®</sup> 2X Universal PCR Master Mix (PN 4304437)</li> <li>• TaqMan<sup>®</sup> PCR Core Reagents Kit (PN N808-0228)</li> </ul>	4308323

**IMPORTANT!** The kits listed above contain TAMRA<sup>™</sup> dye-labeled probes; Applied Biosystems does not recommend the use of TAMRA dye as a reporter or quencher with the StepOne system. The kits may be used with the StepOnePlus system; TAMRA dye may be used as a reporter or quencher with the StepOnePlus system.

**For More Information** For information on preparing PCR reactions using the TaqMan Exogenous Internal Positive Control Reagents, refer to the *TaqMan<sup>®</sup> Exogenous Internal Positive Control Reagents Protocol*.

## Select the Master Mix

**Available Master Mixes** Applied Biosystems Inventoried/Made to Order assays for presence/absence experiments are designed to work with the following master mixes:

Master Mix	Part Number
TaqMan <sup>®</sup> Gene Expression Master Mix, 1-Pack (1 × 5 mL), 200 reactions	4369016
TaqMan <sup>®</sup> Gene Expression Master Mix, 10-Pack (10 × 5 mL), 2000 reactions	4369542
TaqMan <sup>®</sup> 2X Universal PCR Master Mix, 200 Reactions	4304437
TaqMan <sup>®</sup> 2X Universal PCR Master Mix, 2000 Reactions	4326708
10-Pack, TaqMan <sup>®</sup> 2X Universal PCR Master Mix	4305719
TaqMan <sup>®</sup> 2X Universal PCR Master Mix, No AmpErase <sup>®</sup> UNG, 200 Reactions	4324018
TaqMan <sup>®</sup> 2X Universal PCR Master Mix, No AmpErase <sup>®</sup> UNG, 2000 Reactions	4326614
10-Pack, TaqMan <sup>®</sup> 2X Universal PCR Master Mix, No AmpErase <sup>®</sup> UNG	4324020
TaqMan <sup>®</sup> PCR Core Reagents Kit	N808-0228

**Note:** If you purchase the TaqMan<sup>®</sup> Exogenous Internal Positive Control Reagents with TaqMan<sup>®</sup> 2X Universal PCR Master Mix kit (PN 4308320), you do not need to purchase the master mix separately.

**Note:** Presence/absence experiments are not supported for Fast or SYBR<sup>®</sup> Green master mixes and protocols.

**For More Information** For information on using the TaqMan reagents, refer to the:

- *TaqMan<sup>®</sup> Gene Expression Master Mix Protocol*
- *TaqMan<sup>®</sup> Universal PCR Master Mix Protocol*

## Design the Experiment

**Use the StepOne Software** For Applied Biosystems Inventoried/Made to Order assays, use the StepOne software to design your presence/absence experiments. The StepOne software automatically calculates volumes for the:

- Reaction mix components
- Controls and samples
- Sample dilutions

**Note:** To select the Inventoried/Made to Order assay type in the StepOne software, go to the Reaction Setup screen in either the Design Wizard or Advanced Setup, then select **Inventoried/Made to Order** from the Assay Type dropdown menu.

**For More Information** For information on designing and performing presence/absence experiments on the StepOne and StepOnePlus systems, refer to the *Applied Biosystems StepOne™ and StepOnePlus™ Real-Time PCR Systems Getting Started Guide for Presence/Absence Experiments*.

## Custom Assays

**Workflow** If you select the Custom assay type in the StepOne™ software for a presence/absence experiment (that is, you are designing your own primers and probes), Applied Biosystems recommends that you follow the workflow for the Applied Biosystems Assay Design Guidelines:

1. Design primers and probes using Primer Express® Software ([page 3-21](#)).
2. Select the appropriate reagents ([page 3-24](#)).

**IMPORTANT!** Applied Biosystems does not recommend the use of TAMRA™ dye as a reporter or quencher with the StepOne system. TAMRA dye may be used as a reporter or quencher with the StepOnePlus system.

Presence/absence experiments are not supported for Fast or SYBR® Green master mixes and protocols.

3. Use the recommended thermal cycling conditions ([page 3-27](#)).
4. Begin with default primer and probe concentrations. If needed, optimize the primer concentrations ([page 3-30](#)) and probe concentrations ([page 3-33](#)).

**IMPORTANT!** These steps provide a rapid and reliable system for assay design and optimization only when used in their entirety. Adopt the system as a whole to achieve the highest level of success. For a more detailed description of Applied Biosystems Assay Design Guidelines, see [Appendix C](#).

**Note:** To select the Custom assay type in the StepOne software, go to the Reaction Setup screen in either the Design Wizard or Advanced Setup, then select **Custom** from the Assay Type dropdown menu.

This appendix covers:

Standard Deviation Calculation Using the Standard Curve Method . . . . .	A-2
Standard Deviation Calculation Using the Comparative Method . . . . .	A-5
Formula for Comparative $C_T$ ( $\Delta\Delta C_T$ ) Experiments . . . . .	A-7

## Standard Deviation Calculation Using the Standard Curve Method

### Example Comparing Samples with a Reference Sample

The normalized amount of target (c-myc<sub>N</sub> in the table below) is a unitless number that can be used to compare the relative amount of target in different samples. One way to make this comparison is to designate one of the samples as a reference sample. In the table below, brain is designated as the reference sample; brain is arbitrarily chosen because it has the lowest expression level of the target.

### Relative Standard Curve Results

Each c-myc<sub>N</sub> value in the table below is divided by the brain c-myc<sub>N</sub> value to give the values in the final column. These results indicate the kidney sample contains 5.5× as much c-myc mRNA as the brain sample, liver 34.2× as much, and lung 15.7× as much.

To determine relative values, perform the following steps:

1. Average the c-myc and GAPDH values from the table below.
2. Divide the c-myc average by the GAPDH average.
3. Designate the reference sample.
4. Divide the averaged sample value by the averaged reference sample value.

Tissue	c-myc ng Total Raji RNA	GAPDH ng Total Raji RNA	c-myc <sub>N</sub> Norm. to GAPDH <sup>‡</sup>	c-myc <sub>N</sub> Rel. to Brain <sup>§</sup>
Brain	0.033	0.51		
	0.043	0.56		
	0.036	0.59		
	0.043	0.53		
	0.039	0.51		
	0.040	0.52		
Average	0.039±0.004	0.54±0.034	0.07±0.008	1.0±0.12
Kidney	0.40	0.96		
	0.41	1.06		
	0.41	1.05		
	0.39	1.07		
	0.42	1.06		
	0.43	0.96		
Average	0.41±0.016	1.02±0.052	0.40±0.025	5.5±0.35

Tissue	c-myc ng Total Raji RNA	GAPDH ng Total Raji RNA	c-myc <sub>N</sub> Norm. to GAPDH‡	c-myc <sub>N</sub> Rel. to Brain§
Liver	0.67	0.29		
	0.66	0.28		
	0.70	0.28		
	0.76	0.29		
	0.70	0.26		
	0.68	0.27		
Average	0.70±0.036	0.28±0.013	2.49±0.173	34.2±2.37
Lung	0.97	0.82		
	0.92	0.88		
	0.86	0.78		
	0.89	0.77		
	0.94	0.79		
	0.97	0.80		
Average	0.93±0.044	0.81±0.041	1.15±0.079	15.7±1.09

‡ The c-myc<sub>N</sub> value is determined by dividing the average c-myc value by the average GAPDH value. The standard deviation of the quotient is calculated from the standard deviations of the c-myc and GAPDH values. See ["Formula" on page A-4](#).

§ The calculation of c-myc<sub>N</sub> relative to brain involves division by the reference sample value. This is division by an arbitrary constant, so the cv of this result is the same as the cv for c-myc<sub>N</sub>.

**Formula** The  $c\text{-myc}_{c_N}$  value is determined by dividing the average c-myc value by the average GAPDH value. The standard deviation of the quotient is calculated from the standard deviations of the c-myc and GAPDH values using the following formula:

$$cv = \sqrt{cv_1^2 + cv_2^2}$$

where:

$$cv = \frac{s}{\bar{X}} = \frac{stddev}{meanvalue}$$

Using the brain sample from table on [page A-2](#) as an example:

$$cv_1 = \frac{0.004}{0.039}$$

and

$$cv_2 = \frac{0.034}{0.54}$$

$$cv = \sqrt{\left(\frac{0.004}{0.039}\right)^2 + \left(\frac{0.034}{0.54}\right)^2} = 0.12$$

since

$$cv = \frac{s}{\bar{X}}$$

$$s = (cv)(\bar{X})$$

$$s = (0.12)(0.07)$$

$$s = 0.008$$



## Standard Deviation Calculation Using the Comparative Method

**Example** The  $C_T$  data used to determine the amounts of c-myc and GAPDH mRNA shown in the table on [page A-2](#) are used to illustrate the  $\Delta\Delta C_T$  calculation. The table below shows the average  $C_T$  results for the human brain, kidney, liver, and lung samples and how these  $C_T$ s are manipulated to determine  $\Delta C_T$ ,  $\Delta\Delta C_T$ , and the relative amount of c-myc mRNA. The results are comparable to the relative c-myc levels determined using the standard curve method.

Tissue	c-myc Average $C_T$	GAPDH Average $C_T$	$\Delta C_T$ c-myc–GAPDH <sup>‡</sup>	$\Delta\Delta C_T$ $\Delta C_T - \Delta C_{T, \text{Brain}}^{\S}$	c-myc <sub>N</sub> Rel. to Brain <sup>#</sup>
Brain	30.49±0.15	23.63±0.09	6.86±0.17	0.00±0.17	1.0 (0.9–1.1)
Kidney	27.03±0.06	22.66±0.08	4.37±0.10	-2.50±0.10	5.6 (5.3–6.0)
Liver	26.25±0.07	24.60±0.07	1.65±0.10	-5.21±0.10	37.0 (34.5–39.7)
Lung	25.83±0.07	23.01±0.07	2.81±0.10	-4.05±0.10	16.5 (15.4–17.7)

‡ The  $\Delta C_T$  value is determined by subtracting the average GAPDH  $C_T$  value from the average c-myc  $C_T$  value. The standard deviation of the difference is calculated from the standard deviations of the c-myc and GAPDH values. See [“Formula” on page A-6](#).

§ The calculation of  $\Delta\Delta C_T$  involves subtraction by the  $\Delta C_T$  reference sample value. This is subtraction of an arbitrary constant, so the standard deviation of  $\Delta\Delta C_T$  is the same as the standard deviation of the  $\Delta C_T$  value.

# The range given for c-myc<sub>N</sub> relative to brain is determined by evaluating the expression:  $2^{-\Delta\Delta C_T}$  with  $\Delta\Delta C_T + s$  and  $\Delta\Delta C_T - s$ , where  $s$  = the standard deviation of the  $\Delta\Delta C_T$  value.

**Formula** The  $\Delta C_T$  value is determined by subtracting the average GAPDH  $C_T$  value from the average c-myc  $C_T$  value. The standard deviation of the difference is calculated from the standard deviations of the c-myc and GAPDH values using the following formula:

$$s = \sqrt{s_1^2 + s_2^2}$$

where:

s = std dev

Using the brain sample from the table on [page A-5](#) as an example:

$$s_1 = 0.15$$

and

$$s_2 = 0.09$$

$$s = \sqrt{(0.15)^2 + (0.09)^2} = 0.17$$

## Formula for Comparative $C_T$ ( $\Delta\Delta C_T$ ) Experiments

**Formula** The quantity of target, normalized to an endogenous control and relative to a reference sample, is calculated by:

$$2^{-\Delta\Delta C_T}$$

**Derivation of the Formula** The equation that describes the exponential amplification of PCR is:

$$X_n = X_o \times (1 + E_X)^n$$

where:

- $x_n$  = number of target molecules at cycle n
- $x_o$  = initial number of target molecules
- $E_x$  = efficiency of target amplification
- n = number of cycles
- $X_o$  = initial number of target molecules

The threshold cycle ( $C_T$ ) indicates the fractional cycle number at which the quantity of amplified target reaches a specified threshold. Thus,

$$X_T = X_o \times (1 + E_X)^{C_{T,X}} = K_X$$

where:

- $x_T$  = threshold number of target molecules
- $C_{T,X}$  = threshold cycle for target amplification
- $K_X$  = constant

A similar equation for the endogenous control reaction is:

$$R_T = R_o \times (1 + E_R)^{C_{T,R}} = K_R$$

where:

- $R_T$  = threshold number of reference molecules
- $R_o$  = initial number of reference molecules
- $E_R$  = efficiency of reference amplification
- $C_{T,R}$  = threshold cycle for reference amplification
- $K_R$  = constant

Dividing  $X_T$  by  $R_T$  yields the following expression:

$$\frac{X_T}{R_T} = \frac{X_o \times (1 + E_X)^{C_{T,X}}}{R_o \times (1 + E_R)^{C_{T,R}}} = \frac{K_X}{K_R} = K$$

The exact values of  $X_T$  and  $R_T$  depend on a number of factors, including:

- Reporter dye used in the probe
- Sequence context effects on the fluorescence properties of the probe
- Efficiency of probe cleavage
- Purity of the probe
- Setting of the fluorescence threshold.

Therefore, the constant  $K$  does not have to be equal to 1.

Assuming efficiencies of the target and the reference are the same:

$$E_X = E_R = E$$

$$\frac{X_o}{R_o} \times (1 + E)^{C_{T,X} - C_{T,R}} = K$$

Or

$$X_N \times (1 + E)^{\Delta C_T} = K$$

where:

- $X_N = X_O/R_O$ , the normalized quantity of target
- $\Delta C_T = C_{T,X} - C_{T,R}$ , the difference in threshold cycles for target and reference

Rearranging gives the following expression:

$$X_N = K \times (1 + E)^{-\Delta C_T}$$

The final step is to divide the  $X_N$  for any sample (q) by the  $X_N$  for the reference sample (cb):

$$\frac{X_{N,q}}{X_{N,cb}} = \frac{K \times (1 + E)^{-\Delta C_{T,q}}}{K \times (1 + E)^{-\Delta C_{T,cb}}} = (1 + E)^{-\Delta \Delta C_T}$$

where:

- $\Delta \Delta C_T = \Delta C_{T,q} - \Delta C_{T,cb}$

For amplicons designed and optimized according to Applied Biosystems Assay Design Guidelines (amplicon size <150 bp), the efficiency is close to 1. Therefore, the quantity of target, normalized to an endogenous control and relative to a reference sample, is given by:

$$2^{-\Delta \Delta C_T}$$

# Primer Limiting in Multiplex PCR

To generate an accurate multiplex assay, it is important that the amplification of one species does not dominate amplification of the other. Otherwise, the amplification of a highly abundant species can prevent the less-abundant species from amplifying efficiently. If the less-abundant species does not amplify efficiently, your experiment may produce inaccurate results. Or, in severe cases, detection of the less-abundant species may be inhibited completely. You can avoid this situation by limiting the concentrations of the primers used to amplify the more abundant species, thereby “turning off” the amplification soon after the  $C_T$  has been established.

Primer limitation results in the reaction components common to both assays not being exhausted, allowing the amplification of the less-abundant species to continue at high efficiency. If the more abundant species is not known, you should determine it before performing multiplex PCR by running both targets in separate tubes. Both amplifications should be primer limited if neither species is consistently more abundant.

## Considering Relative Abundance of the Target and Reference

In applying the primer limitation to target and endogenous control amplifications, the relative abundance of the two species must be considered. For quantitation experiments, it is possible to use rRNA as an endogenous control. The concentration of rRNA in total RNA is always greater than the concentration of any target mRNA. Therefore, in multiplex reactions amplifying both target and rRNA, only the concentrations of the rRNA primers need to be limited.

## Limiting Primer Matrix

To define limiting primer concentrations, run a matrix of forward and reverse primer concentrations using the value of the minimum initial template. The goal is to identify primer concentrations that reduce the  $\Delta R_n$  value of the assay without affecting the  $C_T$  value. The table below illustrates a recommended matrix of forward and reverse primers varying in concentration from 20 to 100 nM.

**Note:** Although following all design criteria does facilitate the ability to identify limiting primer concentrations, it may not be possible for all assays. If a limiting primer matrix experiment does not enable the identification of primer limiting concentrations, it will be necessary to redesign at least one primer or run the reactions in separate tubes.

Forward: Reverse:	100 nM 100 nM	100 nM 80 nM	100 nM 60 nM	100 nM 40 nM	100 nM 20 nM
Forward: Reverse:	80 nM 100 nM	80 nM 80 nM	80 nM 60 nM	80 nM 40 nM	80 nM 20 nM
Forward: Reverse:	60 nM 100 nM	60 nM 80 nM	60 nM 60 nM	60 nM 40 nM	60 nM 20 nM

Forward: Reverse:	100 nM 100 nM	100 nM 80 nM	100 nM 60 nM	100 nM 40 nM	100 nM 20 nM
Forward: Reverse:	40 nM 100 nM	40 nM 80 nM	40 nM 60 nM	40 nM 40 nM	40 nM 20 nM
Forward: Reverse:	20 nM 100 nM	20 nM 80 nM	20 nM 60 nM	20 nM 40 nM	20 nM 20 nM

**Example** The results of a limiting primer matrix experiment are shown in [Figure B-1 on page B-3](#):

- [Figure B-1a](#) shows that only when lowering the primer concentrations below approximately 50 nM is the  $C_T$  value significantly affected. The plateau area shows the region in which suitable primer limiting concentrations can be found. In this area, the  $C_T$  (and therefore the corresponding quantitation value) is unchanged, whereas the  $\Delta R_n$  value and corresponding product yield are significantly reduced.
- [Figure B-1b](#) shows the corresponding relationship between primer concentrations and  $\Delta R_n$ . The figure demonstrates that lower product yields can be achieved by decreasing forward and reverse primer concentrations.

For this example, an appropriate selection of primer limiting concentrations would be at least 50 nM forward and reverse primer. Probe concentration should be kept at an optimal level even when an assay is primer limited to ensure that the signal produced is large enough for accurate multicomponenting by the software.

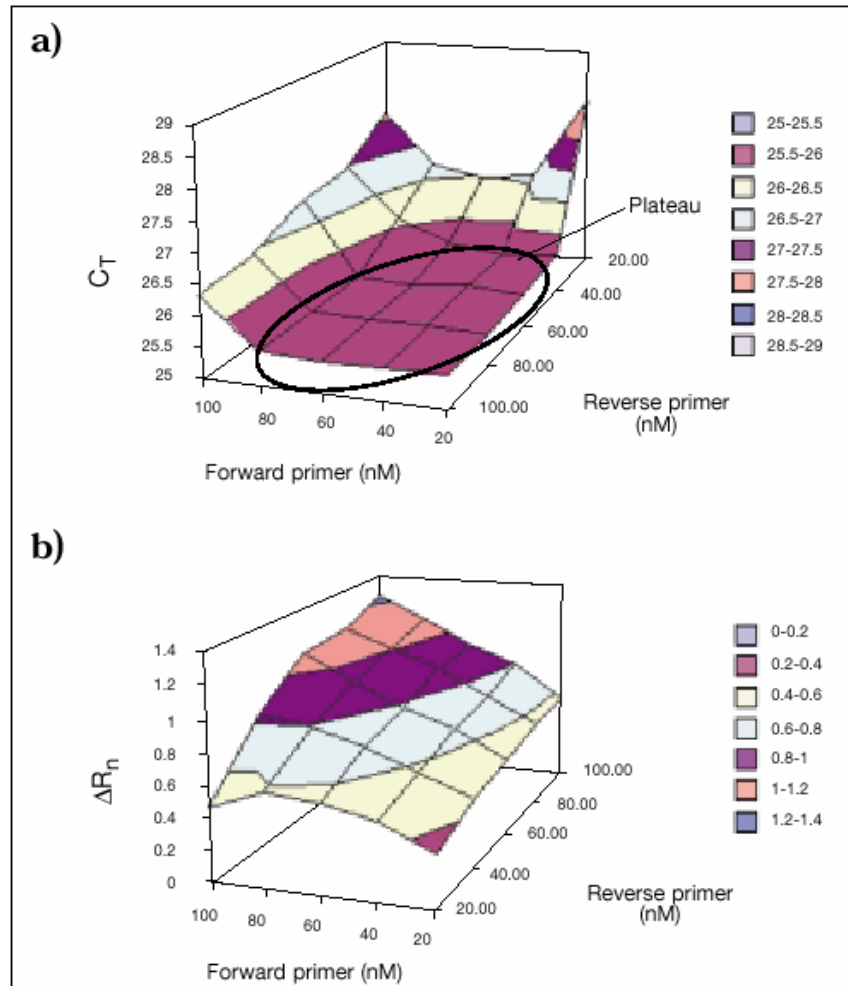

**Figure B-1 Results from Limiting Primer Matrix experiment**  
(a) Shows how  $C_T$  value is affected by variation in forward and reverse primer concentrations. Plateau region indicated shows area where  $C_T$  value remains constant.  
(b) Shows reduction in  $\Delta R_n$  values as primer concentration decreases.





# Assay Design Guidelines

---



## About Assay Design Guidelines

If you are designing your own assays (primers and probes), Applied Biosystems recommends that you follow the Applied Biosystems Assay Design Guidelines. The Assay Design Guidelines specify that you:

1. **Design primers and probes using Primer Express® Software** – The Primer Express software uses a set of default parameters to automatically select primer and probe sets.
2. **Select the appropriate reagents** – There are several TaqMan® and SYBR® Green reagents available. The reagents you use depend on your assay type.
3. **Use the recommended thermal cycling conditions** – Use the thermal cycling conditions recommended for your sample (DNA/cDNA, RNA for 1-step PCR, and RNA for 2-step PCR).

**Note:** Thermal cycling conditions for Fast reagents differ from thermal cycling conditions for standard reagents.

4. **Use default primer and probe concentrations or optimize primer and probe concentrations** – When you use Applied Biosystems Assay Design Guidelines, you can use default primer and probe concentrations for non-multiplex optimized assays, or you can optimize primer and probe concentrations.

**IMPORTANT!** These steps provide a rapid and reliable system for assay design and optimization only when used in their entirety. Adopt the system as a whole to achieve the highest level of success.

**Note:** Applied Biosystems Assay Design Guidelines do not guarantee that all assays will provide the same level of performance and sensitivity. Even the most scrupulous design parameters cannot account for all the possible variations between two different assay systems.

## Conclusions for Quantitation Experiments

In general, the following conclusions can be made when you use the Assay Design Guidelines for quantitation experiments:

- For most TaqMan assays, a concentration of 900-nM primers and 250-nM probe results in a highly reproducible and sensitive assay when using DNA or cDNA as a template.
- Due to the nonspecific nature of its detection, SYBR® Green I dye primer optimization should be bypassed only with caution. However, if all guidelines are followed, concentrations of 50-nM forward and reverse primers generally provide robust amplification with a good level of specificity when using DNA or cDNA as a template. Verify this assumption by checking for nonspecific product formation with either melt curve or gel analysis.
- Most TaqMan assays should enable detection and accurate quantitation to <50 copies of a target, with even greater sensitivity possible.

- SYBR Green assays are capable of similar performance; however, nonspecific product formation can potentially increase the minimum detection limit.

**Conclusions for  
Genotyping  
Experiments**

In general, the following conclusion can be made when you use the Assay Design Guidelines for genotyping experiments:

You can use 900-nM primers, a 200-nM probe, and 1 to 20 ng of genomic DNA to achieve reproducible and sensitive assay results.

# Reagent Part Numbers

---

# D

This appendix covers:

Quantitation Experiments .....	D-2
Genotyping Experiments .....	D-5
Presence/Absence Experiments .....	D-7

## Quantitation Experiments

### Inventoried/Made to Order Assays

#### Assays

Product	Part Number
TaqMan® Gene Expression Assays	For information on the latest available products and specific product uses, refer to the Applied Biosystems Web site: <a href="http://www.appliedbiosystems.com/">http://www.appliedbiosystems.com/</a>
TaqMan® Endogenous Control Assays <b>Note:</b> FAM™-dye labeled TaqMan® Endogenous Control Assays are included as Inventoried TaqMan Gene Expression Assays.	
Custom TaqMan® Gene Expression Assays	

#### Master Mixes

Master Mix	Part Number
TaqMan® Gene Expression Master Mix, 1-Pack (1 × 5 mL), 200 reactions	4369016
TaqMan® Gene Expression Master Mix, 10-Pack (10 × 5 mL), 2000 reactions	4369542
TaqMan® Fast Universal PCR Master Mix (2X), No AmpErase® UNG, 250 Reactions	4352042
TaqMan® 2X Universal PCR Master Mix, 200 Reactions	4304437
TaqMan® 2X Universal PCR Master Mix, 2000 Reactions	4326708
10-Pack, TaqMan® 2X Universal PCR Master Mix	4305719
TaqMan® 2X Universal PCR Master Mix, No AmpErase® UNG, 200 Reactions	4324018
TaqMan® 2X Universal PCR Master Mix, No AmpErase® UNG, 2000 Reactions	4326614
10-Pack, TaqMan® 2X Universal PCR Master Mix, No AmpErase® UNG	4324020

### Custom Assays

#### Assays

Product	Part Number
Custom TaqMan® Probes and Primers	For information on the latest available products and specific product uses, refer to the Applied Biosystems Web site: <a href="http://www.appliedbiosystems.com/">http://www.appliedbiosystems.com/</a>

DNA or cDNA  
Quantitation

Reagent	Kit	Part Number
TaqMan <sup>®</sup> reagents	TaqMan <sup>®</sup> Gene Expression Master Mix, 1-Pack (1 × 5 mL), 200 reactions	4369016
	TaqMan <sup>®</sup> Gene Expression Master Mix, 10-Pack (10 × 5 mL), 2000 reactions	4369542
	TaqMan <sup>®</sup> Fast Universal PCR Master Mix (2X), No AmpErase <sup>®</sup> UNG, 250 Reactions	4352042
	TaqMan <sup>®</sup> 2X Universal PCR Master Mix, 200 Reactions	4304437
	TaqMan <sup>®</sup> 2X Universal PCR Master Mix, 2000 Reactions	4326708
	10-Pack, TaqMan <sup>®</sup> 2X Universal PCR Master Mix	4305719
	TaqMan <sup>®</sup> 2X Universal PCR Master Mix, No AmpErase <sup>®</sup> UNG, 200 Reactions	4324018
	TaqMan <sup>®</sup> 2X Universal PCR Master Mix, No AmpErase <sup>®</sup> UNG, 2000 Reactions	4326614
	10-Pack, TaqMan <sup>®</sup> 2X Universal PCR Master Mix, No AmpErase <sup>®</sup> UNG	4324020
	TaqMan <sup>®</sup> PCR Core Reagents Kit, 200 Reactions	N808-0228
SYBR <sup>®</sup> Green reagents	Power SYBR <sup>®</sup> Green PCR Master Mix (1 mL), 40 reactions	4368577
	Power SYBR <sup>®</sup> Green PCR Master Mix (5-mL), 200 reactions	4367659
	Power SYBR <sup>®</sup> Green PCR Master Mix (10 × 5-mL), 2000 reactions	4368708
	Power SYBR <sup>®</sup> Green PCR Master Mix (50 mL), 2000 reactions	4367660
	SYBR <sup>®</sup> Green PCR Master Mix (1-mL), 40 reactions	4344463
	SYBR <sup>®</sup> Green PCR Master Mix (5-mL), 200 reactions	4309155
	SYBR <sup>®</sup> Green PCR Master Mix (50-mL), 2000 reactions	4334973
	SYBR <sup>®</sup> Green PCR Core Reagents, 200 Reactions	4304886

**RNA Quantitation  
Using 1-Step  
RT-PCR**

Reagent	Kit	Part Number
TaqMan® reagents	TaqMan® One-Step RT-PCR Master Mix Reagents Kit	4309169
	TaqMan® EZ RT-PCR Core Reagents <b>Note:</b> Use the TaqMan® EZ RT-PCR Core Reagents when a high-temperature RT step is required.	N808-0236
SYBR® Green reagents	Power SYBR® Green RT-PCR Reagents Kit	4368711
	SYBR® Green RT-PCR Reagents	4310179

**RNA Quantitation  
Using 2-Step  
RT-PCR**

Reagent	Step	Kit	Part Number
TaqMan® reagents	PCR step only	TaqMan® Gene Expression Master Mix, 1-Pack (1 × 5 mL), 200 reactions	4369016
		TaqMan® Gene Expression Master Mix, 10-Pack (10 × 5 mL), 2000 reactions	4369542
		TaqMan® 2X Universal PCR Master Mix	4304437
		TaqMan® Fast Universal PCR Master Mix (2X), No AmpErase® UNG	4352042
	RT step only	High-Capacity cDNA Reverse Transcription Kit	4374966
		TaqMan® Reverse Transcription Reagents	N808-234
	Both RT and PCR steps	TaqMan® Gold RT PCR kit	N808-232
SYBR® Green reagents	PCR step only	Power SYBR® Green PCR Master Mix	4367659
		SYBR® Green PCR Master Mix	4309155
	RT step only	High-Capacity cDNA Reverse Transcription Kit	4374966
		TaqMan® Reverse Transcription Reagents	N808-234
	Both RT and PCR steps	Power SYBR® Green RT-PCR Reagents Kit	4368711
		SYBR® Green RT-PCR Reagents	4310179

# Genotyping Experiments

## Pre-Designed/Validated Assays

### Assays

Product	Part Number
TaqMan <sup>®</sup> SNP Genotyping Assays	For information on the latest available products and specific product uses, refer to the Applied Biosystems Web site: <a href="http://www.appliedbiosystems.com/">http://www.appliedbiosystems.com/</a>
TaqMan <sup>®</sup> Drug Metabolism Genotyping Assays	
Pre-Developed TaqMan <sup>®</sup> Assay Reagents for Allelic Discrimination	

### Master Mixes

Master Mix	Part Number
TaqMan <sup>®</sup> Genotyping Master Mix, 1-Pack (1 × 10 mL), 400 reactions	4371355
TaqMan <sup>®</sup> Genotyping Master Mix, 1 Bulk Pack (1 × 50 mL), 2000 reactions	4371357
TaqMan <sup>®</sup> 2X Universal PCR Master Mix, 200 Reactions	4304437
TaqMan <sup>®</sup> 2X Universal PCR Master Mix, 2000 Reactions	4326708
10-Pack, TaqMan <sup>®</sup> 2X Universal PCR Master Mix	4305719
TaqMan <sup>®</sup> 2X Universal PCR Master Mix, No AmpErase <sup>®</sup> UNG, 200 Reactions	4324018
TaqMan <sup>®</sup> 2X Universal PCR Master Mix, No AmpErase <sup>®</sup> UNG, 2000 Reactions	4326614
10-Pack, TaqMan <sup>®</sup> 2X Universal PCR Master Mix, No AmpErase <sup>®</sup> UNG	4324020

**Note:** Genotyping experiments are not supported using Fast or SYBR<sup>®</sup> Green master mixes and protocols.

## Custom Assays

### Assays

Product	Part Number
Custom TaqMan <sup>®</sup> SNP Genotyping Assays	For information on the latest available products and specific product uses, refer to the Applied Biosystems Web site: <a href="http://www.appliedbiosystems.com/">http://www.appliedbiosystems.com/</a>

**Master Mixes**

<b>Master Mix</b>	<b>Part Number</b>
TaqMan® Genotyping Master Mix, 1-Pack (1 × 10 mL), 400 reactions	4371355
TaqMan® Genotyping Master Mix, 1 Bulk Pack (1 × 50 mL), 2000 reactions	4371357
TaqMan® 2X Universal PCR Master Mix, 200 Reactions	4304437
TaqMan® 2X Universal PCR Master Mix, 2000 Reactions	4326708
10-Pack, TaqMan® 2X Universal PCR Master Mix	4305719
TaqMan® 2X Universal PCR Master Mix, No AmpErase® UNG, 200 Reactions	4324018
TaqMan® 2X Universal PCR Master Mix, No AmpErase® UNG, 2000 Reactions	4326614
10-Pack, TaqMan® 2X Universal PCR Master Mix, No AmpErase® UNG	4324020

**Note:** Genotyping experiments are not supported using Fast or SYBR® Green master mixes and protocols.



## Presence/Absence Experiments

### Inventoried/Made to Order Assays

#### Assays

Product	Part Number
TaqMan <sup>®</sup> Gene Expression Assays	For information on the latest available products and specific product uses, refer to the Applied Biosystems Web site: <a href="http://www.appliedbiosystems.com/">http://www.appliedbiosystems.com/</a>
TaqMan <sup>®</sup> Endogenous Control Assays <b>Note:</b> FAM <sup>™</sup> -dye labeled TaqMan <sup>®</sup> Endogenous Control Assays are included as Inventoried TaqMan Gene Expression Assays.	
Custom TaqMan <sup>®</sup> Gene Expression Assays	

#### TaqMan Exogenous IPC Reagents

Kits	Part Number
TaqMan <sup>®</sup> Exogenous Internal Positive Control Reagents with TaqMan <sup>®</sup> 2X Universal PCR Master Mix (with VIC <sup>®</sup> dye)	4308320
TaqMan <sup>®</sup> Exogenous Internal Positive Control Reagents <b>Note:</b> If you are using this kit, you will need to purchase one of these TaqMan <sup>®</sup> reagents separately: <ul style="list-style-type: none"> <li>• TaqMan<sup>®</sup> 2X Universal PCR Master Mix (PN 4304437)</li> <li>• TaqMan<sup>®</sup> PCR Core Reagents Kit (PN N808-0228)</li> </ul>	4308323

**IMPORTANT!** The kits listed above contain TAMRA<sup>™</sup> dye-labeled probes; Applied Biosystems does not recommend the use of TAMRA dye as a reporter or quencher with the StepOne system. The kits may be used with the StepOnePlus system; TAMRA dye may be used as a reporter or quencher with the StepOnePlus system.

**Master Mixes**

Master Mix	Part Number
TaqMan® Gene Expression Master Mix, 1-Pack (1 × 5 mL), 200 reactions	4369016
TaqMan® Gene Expression Master Mix, 10-Pack (10 × 5 mL), 2000 reactions	4369542
TaqMan® 2X Universal PCR Master Mix, 200 Reactions	4304437
TaqMan® 2X Universal PCR Master Mix, 2000 Reactions	4326708
10-Pack, TaqMan® 2X Universal PCR Master Mix	4305719
TaqMan® 2X Universal PCR Master Mix, No AmpErase® UNG, 200 Reactions	4324018
TaqMan® 2X Universal PCR Master Mix, No AmpErase® UNG, 2000 Reactions	4326614
10-Pack, TaqMan® 2X Universal PCR Master Mix, No AmpErase® UNG	4324020
TaqMan® PCR Core Reagents Kit	N808-0228

**Note:** If you purchase the TaqMan® Exogenous Internal Positive Control Reagents with TaqMan® 2X Universal PCR Master Mix kit (PN 4308320), you do not need to purchase the master mix separately.

**Note:** Presence/absence experiments are not supported using Fast or SYBR® Green master mixes and protocols.

**Custom Assays****Assays**

Product	Part Number
Custom TaqMan® Probes and Primers	For information on the latest available products and specific product uses, refer to the Applied Biosystems Web site: <a href="http://www.appliedbiosystems.com/">http://www.appliedbiosystems.com/</a>

### DNA or cDNA Quantitation

Kit	Part Number
TaqMan <sup>®</sup> Gene Expression Master Mix, 1-Pack (1 × 5 mL), 200 reactions	4369016
TaqMan <sup>®</sup> Gene Expression Master Mix, 10-Pack (10 × 5 mL), 2000 reactions	4369542
TaqMan <sup>®</sup> 2X Universal PCR Master Mix, 200 Reactions	4304437
TaqMan <sup>®</sup> 2X Universal PCR Master Mix, 2000 Reactions	4326708
10-Pack, TaqMan <sup>®</sup> 2X Universal PCR Master Mix	4305719
TaqMan <sup>®</sup> 2X Universal PCR Master Mix, No AmpErase <sup>®</sup> UNG, 200 Reactions	4324018
TaqMan <sup>®</sup> 2X Universal PCR Master Mix, No AmpErase <sup>®</sup> UNG, 2000 Reactions	4326614
10-Pack, TaqMan <sup>®</sup> 2X Universal PCR Master Mix, No AmpErase <sup>®</sup> UNG	4324020
TaqMan <sup>®</sup> PCR Core Reagents Kit, 200 Reactions	N808-0228

**Note:** Presence/absence experiments are not supported using Fast or SYBR<sup>®</sup> Green master mixes and protocols.

### RNA Quantitation Using 1-Step RT-PCR

Kit	Part Number
TaqMan <sup>®</sup> One-Step RT-PCR Master Mix Reagents Kit	4309169
TaqMan <sup>®</sup> EZ RT-PCR Core Reagents <b>Note:</b> Use the TaqMan <sup>®</sup> EZ RT-PCR Core Reagents when a high-temperature RT step is required.	N808-0236

**Note:** Presence/absence experiments are not supported using Fast or SYBR<sup>®</sup> Green master mixes and protocols.

### RNA Quantitation Using 2-Step RT-PCR

Step	Kit	Part Number
PCR step only	TaqMan <sup>®</sup> Gene Expression Master Mix, 1-Pack (1 × 5 mL), 200 reactions	4369016
	TaqMan <sup>®</sup> Gene Expression Master Mix, 10-Pack (10 × 5 mL), 2000 reactions	4369542
	TaqMan <sup>®</sup> 2X Universal PCR Master Mix	4304437
RT step only	High-Capacity cDNA Reverse Transcription Kit	4374966
	TaqMan <sup>®</sup> Reverse Transcription Reagents	N808-234
Both RT and PCR steps	TaqMan <sup>®</sup> Gold RT PCR kit	N808-232

**Note:** Presence/absence experiments are not supported using Fast or SYBR<sup>®</sup> Green master mixes and protocols.



# Bibliography

- Afonina, I., Zivarts, M., Kutyavin, I., *et al.* 1997. Efficient priming of PCR with short oligonucleotides conjugated to a minor groove binder. *Nucleic Acids Res.* 25:2657–2660.
- Förster, V. T. 1948. Zwischenmolekulare Energiewanderung und Fluoreszenz. *Ann. Physics (Leipzig)* 2:55–75.
- Higuchi, R., Dollinger, G., Walsh, P.S., and Griffith, R. 1992. Simultaneous amplification and detection of specific DNA sequences. *Biotechnology* 10:413–417.
- Higuchi, R., Fockler, C., Dollinger, G., and Watson, R. 1993. Kinetic PCR:Real time monitoring of DNA amplification reactions. *Biotechnology* 11:1026–1030.
- Kutyavin, I.V., Lukhtanov, E.A., Gamper, H.B., and Meyer, R.B. 1997. Oligonucleotides with conjugated dihydropyrroloindole tripeptides: base composition and backbone effects on hybridization. *Nucleic Acids Res.* 25:3718–3723.
- Kwok, S. and Higuchi, R. 1989. Avoiding false positives with PCR. *Nature* 339:237–238.
- Livak, K.J., and Schmittgen, T.D. 2001. Analysis of Relative Gene Expression Data Using Real-Time Quantitative PCR and the  $2^{-\Delta\Delta C_T}$  Method. *Methods* 25:402–408.
- Longo, M.C., Berninger, M.S., and Hartley, J.L. 1990. Use of uracil DNA glycosylase to control carry-over contamination in polymerase chain reactions. *Gene* 93:125–128.
- Saiki, R.K., Scharf, S., Faloona, F., *et al.* 1985. Enzymatic amplification of  $\beta$ -globin genomic sequences and restriction site analysis for diagnosis of sickle cell anemia. *Science* 230:1350–1354.



# Glossary



<b>Advanced Setup</b>	In the StepOne™ software, a feature that allows you to set up your experiment according to your experiment design. Advanced Setup provides you with maximum flexibility in the design and setup of your experiment.
<b>AIF</b>	See <a href="#">assay information file (AIF)</a> .
<b>allele</b>	For a given target, any of the different sequences that occurs in the population.
<b>allelic discrimination plot</b>	Display of data collected during the post-PCR read. The allelic discrimination plot is a graph of the normalized reporter signal from the allele 1 probe plotted against the normalized reporter signal from the allele 2 probe.
<b>amplicon</b>	A segment of DNA amplified during PCR.
<b>amplification</b>	Part of the instrument run in which PCR produces amplification of the target. For quantitation experiments, fluorescence data collected during amplification are displayed in an amplification plot, and the data are used to calculate results. For genotyping or presence/absence experiments, fluorescence data collected during amplification are displayed in an amplification plot, and the data can be used for troubleshooting.
<b>amplification efficiency (EFF%)</b>	<p>Calculation of efficiency of the PCR amplification. The amplification efficiency is calculated using the slope of the regression line in the standard curve. A slope close to <math>-3.32</math> indicates optimal, 100% PCR amplification efficiency. Factors that affect amplification efficiency:</p> <ul style="list-style-type: none"><li>• <b>Range of standard quantities</b> – To increase the accuracy and precision of the efficiency measurement, use a broad range of standard quantities, 5 to 6 logs (<math>10^5</math> to <math>10^6</math> fold).</li><li>• <b>Number of standard replicates</b> – To increase the precision of the standard quantities and decrease the effects of pipetting inaccuracies, include replicates.</li><li>• <b>PCR inhibitors</b> – PCR inhibitors in the reaction can reduce amplification and alter measurements of the efficiency.</li></ul>
<b>amplification plot</b>	<p>Display of data collected during the cycling stage of PCR amplification. Can be viewed as:</p> <ul style="list-style-type: none"><li>• Baseline-corrected normalized reporter (<math>\Delta R_n</math>) vs. cycle</li><li>• Normalized reporter (<math>R_n</math>) vs. cycle</li><li>• Threshold cycle (<math>C_T</math>) vs. well</li></ul>

<b>amplification stage</b>	<p>Part of the instrument run in which PCR produces amplification of the target. The amplification stage is called a cycling stage in the thermal profile and consists of denaturing, primer annealing, and polymerization steps that are repeated.</p> <p>For quantitation experiments, fluorescence data collected during the amplification stage are displayed in an amplification plot, and the data are used to calculate results. For genotyping or presence/absence experiments, fluorescence data collected during the amplification stage are displayed in an amplification plot, and the data can be used for troubleshooting. See also <a href="#">cycling stage</a>.</p>
<b>assay</b>	<p>In the StepOne™ and StepOnePlus™ systems, a PCR reaction mix that contains primers to amplify a target and a reagent to detect the amplified target.</p>
<b>Assay ID</b>	<p>Identifier assigned by Applied Biosystems to TaqMan® Gene Expression Assays and TaqMan® SNP Genotyping Assays.</p>
<b>assay information file (AIF)</b>	<p>Data file on a CD shipped with each assay order. The file name includes the number from the barcode on the plate. The information in the AIF is provided in a tab-delimited format.</p>
<b>assay mix</b>	<p>PCR reaction component in Applied Biosystems TaqMan® Gene Expression Assays and TaqMan® SNP Genotyping Assays. The assay mix contains primers designed to amplify a target and a TaqMan® probe designed to detect amplification of the target.</p>
<b>AutoDelta</b>	<p>In the run method, a setting to increase or decrease the temperature and/or time for a step with each subsequent cycle in a cycling stage. When AutoDelta is enabled for a cycling stage, the settings are indicated by an icon in the thermal profile:</p> <ul style="list-style-type: none"><li>• AutoDelta on: ▲</li><li>• AutoDelta off: ▲</li></ul>
<b>automatic baseline</b>	<p>An analysis setting in which the software calculates the baseline start and end values for the amplification plot. You can apply the automatic baseline setting to specific wells in the reaction plate. See also <a href="#">baseline</a>.</p>
<b>automatic C<sub>T</sub></b>	<p>An analysis setting in which the software calculates the baseline start and end values and the threshold in the amplification plot. The software uses the baseline and threshold to calculate the threshold cycle (C<sub>T</sub>). See also <a href="#">threshold cycle (C<sub>T</sub>)</a>.</p>
<b>baseline</b>	<p>In the amplification plot, a line fit to the fluorescence levels during the initial stages of PCR, when there is little change in fluorescence signal.</p>



---

<b>baseline-corrected normalized reporter (<math>\Delta R_n</math>)</b>	<p>The magnitude of normalized fluorescence signal generated by the reporter:</p> <ol style="list-style-type: none"><li>1. In experiments that contain data from real-time PCR, the magnitude of normalized fluorescence signal generated by the reporter at each cycle during the PCR amplification. In the <math>\Delta R_n</math> vs. Cycle amplification plot, <math>\Delta R_n</math> is calculated at each cycle as: <math display="block">\Delta R_n (\text{cycle}) = R_n (\text{cycle}) - R_n (\text{baseline}), \text{ where } R_n = \text{normalized reporter}</math></li><li>2. In genotyping experiments and presence/absence experiments, the difference in normalized fluorescence signal generated by the reporter between the pre-PCR read and the post-PCR read. In the allelic discrimination plot (genotyping experiments) and the presence/absence plot (presence/absence experiments), <math>\Delta R_n</math> is calculated as: <math display="block">\Delta R_n = R_n (\text{post-PCR read}) - R_n (\text{pre-PCR read}), \text{ where } R_n = \text{normalized reporter}</math></li></ol> <p>See also <a href="#">normalized reporter (<math>R_n</math>)</a>.</p>
<b>blocked IPC</b>	<p>In presence/absence experiments, a reaction that contains IPC blocking agent, which blocks amplification of the internal positive control (IPC). In the StepOne™ software, the task for the IPC target in wells that contain IPC blocking agent. See also <a href="#">negative control-blocked IPC wells</a>.</p>
<b>calibrator</b>	<p>See <a href="#">reference sample</a>.</p>
<b>chemistry</b>	<p>See <a href="#">reagents</a>.</p>
<b>colocated layout</b>	<p>A system layout in which the StepOne™ or StepOnePlus™ instrument is directly connected to a colocated computer by the yellow cable. In this layout, you can control the instrument with the StepOne™ software on the colocated computer or with the instrument touchscreen.</p>
<b>comparative <math>C_T</math> (<math>\Delta\Delta C_T</math>) method</b>	<p>Method for determining relative target quantity in samples. With the comparative <math>C_T</math> (<math>\Delta\Delta C_T</math>) method, the StepOne™ software measures amplification of the target and of the endogenous control in samples and in a reference sample. Measurements are normalized using the endogenous control. The software determines the relative quantity of target in each sample by comparing normalized target quantity in each sample to normalized target quantity in the reference sample.</p>
<b><math>C_T</math></b>	<p>See <a href="#">threshold cycle (<math>C_T</math>)</a>.</p>
<b>custom dye</b>	<p>Dye that is not supplied by Applied Biosystems. Custom dyes may be adapted for use in experiments on the StepOne™ and StepOnePlus™ systems. When using custom dyes, the custom dye should be added to the Dye Library and a custom dye calibration performed.</p> <p><b>IMPORTANT!</b> Applied Biosystems does not recommend the use of TAMRA™ dye as reporter or quencher with the StepOne™ system. TAMRA dye may be used as a reporter or quencher with the StepOnePlus™ system.</p>
<b>cycle threshold</b>	<p>See <a href="#">threshold cycle (<math>C_T</math>)</a>.</p>

<b>cycling stage</b>	In the thermal profile, a stage that is repeated. A cycling stage is also called an amplification stage. For cycling stages, you can enable AutoDelta settings. See also <a href="#">amplification stage</a> .
<b>data collection</b>	A process during the instrument run in which an instrument component detects fluorescence data from each well of the reaction plate. The instrument transforms the signal to electronic data, and the data are saved in the experiment file. In the StepOne™ software, a data collection point is indicated by an icon in the thermal profile: <ul style="list-style-type: none"><li>• Data collection on: </li><li>• Data collection off: </li></ul>
<b>delta Rn (<math>\Delta Rn</math>)</b>	See <a href="#">baseline-corrected normalized reporter (<math>\Delta Rn</math>)</a> .
<b>derivative reporter (<math>-Rn'</math>)</b>	The negative first-derivative of the normalized fluorescence generated by the reporter during PCR amplification. In the derivative reporter ( $-Rn'$ ) vs. temperature melt curve, the derivative reporter signal is displayed in the y-axis.
<b>Design Wizard</b>	A feature in the StepOne™ software that helps you set up your experiment by guiding you through best practices as you enter your experiment design.
<b>diluent</b>	A reagent used to dilute a sample or standard before adding it to the PCR reaction. The diluent can be water or buffer.
<b>Diluted Sample Concentration (10× for Reaction Mix)</b>	In the StepOne™ software, a field displayed on the Sample Dilution Calculations tab of the Reaction Setup screen. For this field, enter the sample concentration you want to use to add to the reaction mix for all samples in the experiment. “10× for Reaction Mix” indicates that the software assumes the sample or standard component of the reaction mix is at a 10× concentration. For example, if the diluted sample concentration is 50.0 ng/μL (10×), the final sample concentration in the reaction is 5 ng/μL (1×).
<b>dilution factor</b>	See <a href="#">serial factor</a> .
<b>dissociation curve</b>	See <a href="#">melt curve</a> .
<b>EFF%</b>	See <a href="#">amplification efficiency (EFF%)</a> .
<b>endogenous control</b>	A target or gene that should be expressed at similar levels in all samples you are testing. Endogenous controls are used in relative standard curve and comparative $C_T$ ( $\Delta\Delta C_T$ ) experiments to normalize fluorescence signals for the target you are quantifying. Housekeeping genes can be used as endogenous controls. See also <a href="#">housekeeping gene</a> .
<b>endpoint read</b>	See <a href="#">post-PCR read</a> .

---

<b>experiment</b>	<p>Refers to the entire process of performing a run using the StepOne™ or StepOnePlus™ systems, including setup, run, and analysis. The types of experiments you can perform using the StepOne and StepOnePlus systems:</p> <ul style="list-style-type: none"><li>• Quantitation - standard curve</li><li>• Quantitation - relative standard curve</li><li>• Quantitation - comparative <math>C_T</math> (<math>\Delta\Delta C_T</math>)</li><li>• Melt curve</li><li>• Genotyping</li><li>• Presence/absence</li></ul>
<b>experiment name</b>	<p>Entered during experiment setup, the name that is used to identify the experiment. Experiment names cannot exceed 100 characters and cannot include any of the following characters: forward slash (/), backslash (\), greater than sign (&gt;), less than sign (&lt;), asterisk (*), question mark (?), quotation mark ("), vertical line ( ), colon (:), or semicolon (;).</p>
<b>experiment type</b>	<p>The type of experiment you are performing using the StepOne™ or StepOnePlus™ system:</p> <ul style="list-style-type: none"><li>• Standard curve</li><li>• Comparative <math>C_T</math> (<math>\Delta\Delta C_T</math>)</li><li>• Relative standard curve</li><li>• Melt curve (not available in the Design Wizard)</li><li>• Genotyping</li><li>• Presence/absence</li></ul> <p>The experiment type you select affects the setup, run, and analysis.</p>
<b>forward primer</b>	<p>Oligonucleotide that flanks the 5' end of the amplicon. The reverse primer and the forward primer are used together in PCR reactions to amplify the target.</p>
<b>holding stage</b>	<p>In the thermal profile, a stage that includes one or more steps. You can add a holding stage to the thermal profile to activate enzymes, to inactivate enzymes, or to incubate a reaction.</p>
<b>housekeeping gene</b>	<p>A gene that is involved in basic cellular functions and is constitutively expressed. Housekeeping genes can be used as endogenous controls. See also <a href="#">endogenous control</a>.</p>
<b>internal positive control (IPC)</b>	<p>In presence/absence experiments, a short synthetic DNA template that is added to PCR reactions. You can use the IPC to distinguish between true negative results (that is, the target is absent in the samples) and negative results caused by PCR inhibitors, incorrect assay setup, or reagent or instrument failure.</p>
<b>inventoried assays</b>	<p>TaqMan® Gene Expression Assays and TaqMan® SNP Genotyping Assays that have been previously manufactured, passed quality control specifications, and stored in inventory.</p>

<b>IPC</b>	In presence/absence experiments, abbreviation for internal positive control (IPC). In the StepOne™ software, the task for the IPC target in wells that contain the IPC and do not contain IPC blocking agent. See also <a href="#">internal positive control (IPC)</a> .
<b>IPC blocking agent</b>	Reagent added to PCR reactions to block amplification of the internal positive control (IPC).
<b>IPC+</b>	See <a href="#">negative control-IPC wells</a> .
<b>made-to-order assays</b>	TaqMan® Gene Expression Assays or TaqMan® SNP Genotyping Assays that are manufactured at the time of order. Only assays that pass manufacturing quality control specifications are shipped.
<b>manual baseline</b>	An analysis setting in which you enter the baseline start and end values for the amplification plot. You can apply the manual baseline setting to specific wells in the reaction plate.
<b>manual C<sub>T</sub></b>	An analysis setting in which you enter the threshold value and select whether to use automatic baseline or manual baseline values. The software uses the baseline and the threshold values to calculate the threshold cycle (C <sub>T</sub> ).
<b>melt curve</b>	A plot of data collected during the melt curve stage. Peaks in the melt curve can indicate the melting temperature (T <sub>m</sub> ) of the target or can identify nonspecific PCR amplification. In the StepOne™ software, you can view the melt curve as normalized reporter (R <sub>n</sub> ) vs. temperature or as derivative reporter (–R <sub>n</sub> ′) vs. temperature. Also called dissociation curve.
<b>melt curve stage</b>	In the thermal profile, a stage with a temperature increment to generate a melt curve.
<b>melting temperature (T<sub>m</sub>)</b>	In melt curve experiments, the temperature at which 50% of the DNA is double-stranded and 50% of the DNA is dissociated into single-stranded DNA. The T <sub>m</sub> is displayed in the melt curve.
<b>multicomponent plot</b>	A plot of the complete spectral contribution of each dye for the selected well(s) over the duration of the PCR run.
<b>negative control (NC)</b>	In the StepOne™ software, the task for targets or SNP assays in wells that contain water or buffer instead of sample. No amplification of the target should occur in negative control wells. Previously called no template control (NTC).
<b>negative control-blocked IPC wells</b>	In presence/absence experiments, wells that contain IPC blocking agent instead of sample in the PCR reaction. No amplification should occur in negative control-blocked IPC wells because the reaction contains no sample and amplification of the IPC is blocked. Previously called no amplification control (NAC).
<b>negative control-IPC wells</b>	In presence/absence experiments, wells that contain IPC template and buffer or water instead of sample. Only the IPC template should amplify in negative control-IPC wells because the reaction contains no sample. Previously called IPC+.
<b>no amplification control (NAC)</b>	See <a href="#">negative control-blocked IPC wells</a> .

---

<b>no template control (NTC)</b>	See <a href="#">negative control (NC)</a> .
<b>nonfluorescent quencher-minor groove binder (NFQ-MGB)</b>	Molecules that are attached to the 3' end of TaqMan <sup>®</sup> probes. When the probe is intact, the nonfluorescent quencher (NFQ) prevents the reporter dye from emitting fluorescence signal. Because the NFQ does not fluoresce, it produces lower background signals, resulting in improved precision in quantitation. The minor groove binder (MGB) increases the melting temperature (T <sub>m</sub> ) without increasing probe length. It also allows the design of shorter probes.
<b>normalized quantity</b>	Quantity of target divided by the quantity of endogenous control.
<b>normalized reporter (R<sub>n</sub>)</b>	Fluorescence signal from the reporter dye normalized to the fluorescence signal of the passive reference.
<b>omit well</b>	An action that you perform before reanalysis to omit one or more wells from analysis. Because no algorithms are applied to omitted wells, omitted wells contain no results.
<b>outlier</b>	For a set of data, a datapoint that is significantly smaller or larger than the others.
<b>passive reference</b>	A dye that produces fluorescence signal. Because the passive reference signal should be consistent across all wells, it is used to normalize the reporter dye signal to account for non-PCR related fluorescence fluctuations caused by minor well-to-well differences in concentrations or volume. Normalization to the passive reference signal allows for high data precision.
<b>plate layout</b>	<p>An illustration of the grid of wells and assigned content in the reaction plate. In StepOne™ systems, the grid contains 6 rows and 8 columns. In StepOnePlus™ systems, the grid contains 8 rows and 12 columns.</p> <p>In the StepOne™ software, you can use the plate layout as a selection tool to assign well contents, to view well assignments, and to view results. The plate layout can be printed, included in a report, exported, and saved as a slide for a presentation.</p>
<b>point</b>	One standard in a standard curve. The standard quantity for each point in the standard curve is calculated based on the starting quantity and serial factor.
<b>positive control</b>	In genotyping experiments, a DNA sample with a known genotype, homozygous or heterozygous. In the StepOne™ software, the task for the SNP assay in wells that contain a sample with a known genotype.
<b>post-PCR read</b>	Used in genotyping and presence/absence experiments, the part of the instrument run that occurs after amplification. In genotyping experiments, fluorescence data collected during the post-PCR read are displayed in the allelic discrimination plot and used to make allele calls. In presence/absence experiments, fluorescence data collected during the post-PCR read are displayed in the presence/absence plot and used to make detection calls. Also called endpoint read.

<b>pre-PCR read</b>	Used in genotyping and presence/absence experiments, the part of the instrument run that occurs before amplification. The pre-PCR read is optional but recommended. Fluorescence data collected during the pre-PCR read can be used to normalize fluorescence data collected during the post-PCR read.
<b>primer mix</b>	PCR reaction component that contains the forward primer and reverse primer designed to amplify the target.
<b>primer/probe mix</b>	PCR reaction component that contains the primers designed to amplify the target and a TaqMan <sup>®</sup> probe designed to detect amplification of the target.
<b>pure dye</b>	See <a href="#">custom dye</a> and <a href="#">system dye</a> .
<b>quantitation method</b>	In quantitation experiments, the method used to determine the quantity of target in the samples. In StepOne <sup>™</sup> and StepOnePlus <sup>™</sup> systems, there are three types of quantitation methods: standard curve, relative standard curve, and comparative C <sub>T</sub> ( $\Delta\Delta C_T$ ).
<b>quantity</b>	In quantitation experiments, the amount of target in the samples. Absolute quantity can refer to copy number, mass, molarity, or viral load. Relative quantity refers to the fold-difference between normalized quantity of target in the sample and normalized quantity of target in the reference sample.
<b>quencher</b>	<p>A molecule attached to the 3' end of TaqMan<sup>®</sup> probes to prevent the reporter from emitting fluorescence signal while the probe is intact. With TaqMan<sup>®</sup> reagents, a nonfluorescent quencher-minor groove binder (NFQ-MGB) can be used as the quencher. With SYBR<sup>®</sup> Green reagents, no quencher is used.</p> <p><b>IMPORTANT!</b> Applied Biosystems does not recommend the use of TAMRA<sup>™</sup> dye as reporter or quencher with the StepOne<sup>™</sup> system. TAMRA dye may be used as a reporter or quencher with the StepOnePlus<sup>™</sup> system.</p>
<b>QuickStart</b>	A feature in StepOne <sup>™</sup> and StepOnePlus <sup>™</sup> systems that allows you to run an experiment without entering plate setup information. QuickStart requires a collocated layout with the instrument powered on and an intact instrument-computer connection.
<b>R<sup>2</sup> value</b>	Regression coefficient calculated from the regression line in the standard curve. The R <sup>2</sup> value indicates the closeness of fit between the standard curve regression line and the individual C <sub>T</sub> data points from the standard reactions. A value of 1.00 indicates a perfect fit between the regression line and the data points.
<b>ramp</b>	The rate at which the temperature changes during the instrument run. Except for the melt curve step, the ramp is defined as a percentage. For the melt curve step, the ramp is defined as a temperature increment. In the graphical view of the thermal profile, the ramp is indicated by a diagonal line.

---

<b>ramp speed</b>	<p>Speed at which the temperature ramp occurs during the instrument run. Available ramp speeds include fast and standard.</p> <ul style="list-style-type: none"><li>• For optimal results using the fast ramp speed, Applied Biosystems recommends using TaqMan<sup>®</sup> Fast reagents in your PCR reactions.</li><li>• For optimal results using the standard ramp speed, Applied Biosystems recommends using standard reagents in your PCR reactions.</li></ul> <p><b>IMPORTANT!</b> TaqMan Fast reagents are not supported for genotyping or presence/absence experiments.</p>
<b>raw data plot</b>	<p>A plot of raw fluorescence signal (not normalized) for each optical filter.</p>
<b>reaction mix</b>	<p>A solution that contains all components to run the PCR reaction, except for the template (sample, standard, or control).</p>
<b>reagents</b>	<p>The PCR reaction components you are using to amplify the target and to detect amplification. Types of reagents used on the StepOne<sup>™</sup> and StepOnePlus<sup>™</sup> systems:</p> <ul style="list-style-type: none"><li>• TaqMan<sup>®</sup> reagents</li><li>• SYBR<sup>®</sup> Green reagents</li><li>• Other reagents</li></ul>
<b>real-time PCR</b>	<p>Process of collecting fluorescence data during PCR. Data from the real-time PCR are used to calculate results for quantitation experiments or to troubleshoot results for genotyping or presence/absence experiments.</p>
<b>reference sample</b>	<p>In relative standard curve and comparative C<sub>T</sub> (ΔΔC<sub>T</sub>) experiments, the sample used as the basis for relative quantitation results. Also called the calibrator.</p>
<b>refSNP ID</b>	<p>Identifies the reference SNP (refSNP) cluster ID. Generated by the Single Nucleotide Polymorphism Database of Nucleotide Sequence Variation (dbSNP) at the National Center for Biotechnology Information (NCBI). The refSNP ID can be used to search the Applied Biosystems Store for an Applied Biosystems SNP Genotyping Assay. Also called an rs number.</p>
<b>regression coefficients</b>	<p>Values calculated from the regression line in standard curves, including the R<sup>2</sup> value, slope, and y-intercept. You can use the regression coefficients to evaluate the quality of results from the standards. See also standard curve.</p>
<b>regression line</b>	<p>In standard curve and relative standard curve experiments, the best-fit line from the standard curve. Regression line formula:</p> $C_T = m [\log (Qty)] + b$ <p>where m is the slope, b is the y-intercept, and Qty is the standard quantity.</p> <p>See also <a href="#">regression coefficients</a>.</p>
<b>reject well</b>	<p>An action that the software performs during analysis to remove one or more wells from further analysis if a specific flag is applied to the well. Rejected wells contain results calculated up to the point of rejection.</p>

<b>relative standard curve method</b>	Method for determining relative target quantity in samples. With the relative standard curve method, the StepOne™ software measures amplification of the target and of the endogenous control in samples, in a reference sample, and in a standard dilution series. Measurements are normalized using the endogenous control. Data from the standard dilution series are used to generate the standard curve. Using the standard curve, the software interpolates target quantity in the samples and in the reference sample. The software determines the relative quantity of target in each sample by comparing target quantity in each sample to target quantity in the reference sample.
<b>Remote Monitor</b>	A feature in the StepOne™ software that allows you to monitor a StepOne™ or StepOnePlus™ instrument over the network. With the Remote Monitor, you can monitor the instrument status, send an experiment to the instrument, monitor amplification plots and temperature plots in real time, and download the results to your computer. You cannot operate the StepOne or StepOnePlus instrument using the Remote Monitor.
<b>replicate group</b>	A set of identical reactions in an experiment.
<b>replicates</b>	Total number of identical reactions containing identical components and identical volumes.
<b>reporter</b>	Fluorescent dye used to detect amplification. If you are using TaqMan® reagents, the reporter dye is attached to the 5' end. If you are using SYBR® Green reagents, the reporter dye is SYBR® Green dye.
<b>reverse primer</b>	An oligonucleotide that flanks the 3' end of the amplicon. The reverse primer and the forward primer are used together in PCR reactions to amplify the target.
<b>reverse transcriptase</b>	An enzyme that converts RNA to cDNA. Reverse transcriptase is added to the PCR reaction to perform 1-step RT-PCR.
<b>Rn</b>	See <a href="#">normalized reporter (Rn)</a> .
<b>ROX™ dye</b>	A dye supplied by Applied Biosystems and precalibrated on the StepOne™ and StepOnePlus™ systems. ROX dye is used as the passive reference.
<b>rs number</b>	See <a href="#">refSNP ID</a> .
<b>run method</b>	Definition of the reaction volume and the thermal profile for the StepOne™ or StepOnePlus™ instrument run.
<b>sample</b>	The template that you are testing.
<b>Sample DNA (10X)</b>	In the StepOne™ software, a reaction component displayed on the Reaction Mix Calculations tab of the Reaction Setup screen. The software assumes the sample DNA is added to the reaction mix at a 10X concentration. For example, if the reaction volume is 20 µL, the calculated volume of sample for 1 reaction is 2 µL.
<b>Sample Library</b>	In the StepOne™ software, a collection of samples. The Sample Library contains the sample name and the sample color.



---

<b>Sample or Standard (10X)</b>	In the StepOne™ software, a reaction component displayed on the Reaction Mix Calculations tab of the Reaction Setup screen. The software assumes the sample or standard is added to the reaction mix at a 10X concentration. For example, if the reaction volume is 20 µL, the calculated volume of sample or standard for 1 reaction is 2 µL.
<b>sample/SNP assay reaction</b>	In genotyping experiments, the combination of which sample to test and which SNP assay to perform in one PCR reaction. Each PCR reaction can contain only one sample and one SNP assay.
<b>sample/target reaction</b>	In quantitation experiments, the combination of which sample to test and which target to detect and quantify in one PCR reaction. In the Design Wizard, you can detect and quantify only one target in one PCR reaction. Use Advanced Setup to detect and quantify more than one target in one PCR reaction.
<b>serial factor</b>	In the StepOne™ software, a numerical value that defines the sequence of quantities in the standard curve. The serial factor and the starting quantity are used to calculate the standard quantity for each point in the standard curve. For example, if the standard curve is defined with a serial factor of 1:10 or 10X, the difference between any 2 adjacent points in the curve is 10-fold.
<b>series</b>	See <a href="#">standard dilution series</a> .
<b>slope</b>	Regression coefficient calculated from the regression line in the standard curve. The slope indicates the PCR amplification efficiency for the assay. A slope of -3.32 indicates 100% amplification efficiency. See also <a href="#">amplification efficiency (EFF%)</a> and <a href="#">regression line</a> .
<b>SNP</b>	Abbreviation for single nucleotide polymorphism. The SNP can consist of a base difference or an insertion or deletion of one base.
<b>SNP assay</b>	Used in genotyping experiments, a PCR reaction that contains primers to amplify the SNP and two probes to detect different alleles.
<b>SNP Assay Library</b>	In the StepOne™ software, a collection of SNP assays to add to genotyping experiments. The SNP assays in the library contain the SNP assay name, SNP assay color, and for each allele, the allele name or base(s), reporter, quencher, and allele colors. The SNP assays in the library may also contain the assay ID and comments about the SNP assay.
<b>spatial calibration</b>	Type of StepOne™ and StepOnePlus™ system calibration in which the system maps the positions of the wells in the sample block(s). Spatial calibration data are used so that the software can associate increases in fluorescence during a run with specific wells in the reaction plate.
<b>stage</b>	In the thermal profile, a group of one or more steps. There are three types of stages: holding stage (including pre-PCR read and post-PCR read), cycling stage (also called amplification stage), and melt curve stage.

<b>standalone layout</b>	A system layout in which the StepOne™ or StepOnePlus™ instrument is <i>not</i> connected to a computer by the yellow cable. In this layout, you control the instrument only with the instrument touchscreen, and you use a USB drive or network connection to transfer data between the instrument and computer.
<b>standard</b>	Sample that contains known standard quantities. Standard reactions are used in quantitation experiments to generate standard curves. See also <a href="#">standard curve</a> and <a href="#">standard dilution series</a> .
<b>standard curve</b>	<p>In standard curve and relative standard curve experiments:</p> <ul style="list-style-type: none"><li>• The best-fit line in a plot of the C<sub>T</sub> values from the standard reactions plotted against standard quantities. See also regression line.</li><li>• A set of standards containing a range of known quantities. Results from the standard curve reactions are used to generate the standard curve. The standard curve is defined by the number of points in the dilution series, the number of standard replicates, the starting quantity, and the serial factor. See also standard dilution series.</li></ul>
<b>standard curve method</b>	Method for determining absolute target quantity in samples. With the standard curve method, the StepOne™ software measures amplification of the target in samples and in a standard dilution series. Data from the standard dilution series are used to generate the standard curve. Using the standard curve, the software interpolates the absolute quantity of target in the samples. See also <a href="#">standard</a> and <a href="#">standard curve</a> .
<b>standard dilution series</b>	In standard curve and relative standard curve experiments, a set of standards containing a range of known quantities. The standard dilution series is prepared by serially diluting standards. For example, the standard stock is used to prepare the first dilution point, the first dilution point is used to prepare the second dilution point, and so on. In the StepOne™ software, the volumes needed to prepare a standard dilution series are calculated by the number of dilution points, the number of standard replicates, the starting quantity, the serial factor, and the standard concentration in the stock. See also <a href="#">standard curve</a> .
<b>standard quantity</b>	<p>A known quantity in the PCR reaction.</p> <ul style="list-style-type: none"><li>• In standard curve experiments, the quantity of target in the standard. In the StepOne™ software, the units for standard quantity can be for mass, copy number, viral load, or other units for measuring the quantity of target.</li><li>• In relative standard curve experiments, a known quantity in the standard. Standard quantity can refer to the quantity of cDNA or the quantity of standard stock in the PCR reaction. The units are not relevant for relative standard curve experiments because they cancel out in the calculations.</li></ul>
<b>starting quantity</b>	When defining a standard curve in the StepOne™ software, corresponds to the highest or lowest quantity.

---

<b>step</b>	A component of the thermal profile. For each step in the thermal profile, you can set the ramp rate (ramp increment for melt curve steps), hold temperature, hold time (duration), and you can turn data collection on or off for the ramp or the hold parts of the step. For cycling stages, a step is also defined by the AutoDelta status. With StepOnePlus™ systems, which contain the VeriFlex™ blocks, each step contains 6 temperatures (1 for each VeriFlex block).
<b>SYBR® Green reagents</b>	PCR reaction components that consist of two primers designed to amplify the target and SYBR® Green dye to detect double-stranded DNA.
<b>system dye</b>	<p>Dye supplied by Applied Biosystems and precalibrated on the StepOne™ or StepOnePlus™ system. Before you use system dyes in your experiments, make sure the system dye calibration is current in the Instrument Maintenance Manager.</p> <p>System dyes on the StepOne system:</p> <ul style="list-style-type: none"><li>• FAM™ dye</li><li>• JOE™ dye</li><li>• ROX™ dye</li><li>• SYBR® Green dye</li><li>• VIC® dye</li></ul> <p>System dyes on the StepOnePlus system:</p> <ul style="list-style-type: none"><li>• FAM™ dye</li><li>• JOE™ dye</li><li>• NED™ dye</li><li>• ROX™ dye</li><li>• SYBR® Green dye</li><li>• TAMRA™ dye</li><li>• VIC® dye</li></ul> <p><b>IMPORTANT!</b> Applied Biosystems does not recommend the use of TAMRA™ dye as reporter or quencher with the StepOne™ system. TAMRA dye may be used as a reporter or quencher with the StepOnePlus™ system.</p>
<b>TaqMan® reagents</b>	PCR reaction components that consist of primers designed to amplify the target and a TaqMan® probe designed to detect amplification of the target.
<b>target</b>	The nucleic acid sequence that you want to amplify and detect.
<b>target color</b>	In the StepOne™ software, a color assigned to a target to identify the target in the plate layout and analysis plots.
<b>Target Library</b>	In the StepOne™ software, a collection of targets to add to experiments. The targets in the library contain the target name, reporter, quencher, and target color. The target in the library may also contain comments about the target.

<b>task</b>	<p>In the StepOne™ software, the type of reaction performed in the well for the target or SNP assay. Available tasks:</p> <ul style="list-style-type: none"><li>• Unknown</li><li>• Negative Control</li><li>• Standard (standard curve and relative standard curve experiments)</li><li>• Positive control (genotyping experiments)</li><li>• IPC (presence/absence experiments)</li><li>• Blocked IPC (presence/absence experiments)</li></ul>
<b>temperature plot</b>	<p>In the StepOne™ software, a display of temperatures for the sample, instrument cover, and instrument block during the StepOne™ or StepOnePlus™ instrument run.</p>
<b>template</b>	<p>In the Design Wizard of the StepOne™ software (and in QuickStart for quantitation experiments), the type of nucleic acid to add to the PCR reaction. The recommended template varies according to experiment type:</p> <ul style="list-style-type: none"><li>• Quantitation experiments (standard curve, relative standard curve, and comparative <math>C_T</math>) – cDNA (complementary cDNA), RNA, or gDNA (genomic DNA) For quantitation experiments, the template type selection affects the run method, reaction setup, and materials list.</li><li>• Genotyping experiments – Wet DNA (gDNA or cDNA) or dry DNA (gDNA or cDNA) For genotyping experiments, the template type selection affects the reaction setup.</li><li>• Presence/absence experiments - DNA For presence/absence experiments, Applied Biosystems recommends adding DNA templates to the PCR reactions.</li></ul>
<b>thermal profile</b>	<p>Part of the run method that specifies the temperature, time, ramp, and data collection points for all steps and stages of the StepOne™ or StepOnePlus™ instrument run.</p>
<b>threshold</b>	<ol style="list-style-type: none"><li>1. In amplification plots, the level of fluorescence above the baseline and within the exponential growth region. The threshold can be determined automatically (see <a href="#">automatic <math>C_T</math></a>) or can be set manually (see <a href="#">manual <math>C_T</math></a>).</li><li>2. In presence/absence experiments, the level of fluorescence above which the StepOne™ software assigns a presence call.</li></ol>
<b>threshold cycle (<math>C_T</math>)</b>	<p>The PCR cycle number at which the fluorescence meets the threshold in the amplification plot.</p>
<b>T<sub>m</sub></b>	<p>See <a href="#">melting temperature (T<sub>m</sub>)</a>.</p>
<b>touchscreen</b>	<p>Instrument display that you touch to control the StepOne™ or StepOnePlus™ instrument.</p>

---

<b>unknown</b>	<p>In the StepOne™ software, the task for the target or SNP assay in wells that contain the sample you are testing:</p> <ul style="list-style-type: none"><li>• In quantitation experiments, the task for the target in wells that contain a sample with unknown target quantities.</li><li>• In genotyping experiments, the task for the SNP assay in wells that contain a sample with an unknown genotype.</li><li>• In presence/absence experiments, the task for the target in wells that contain a sample in which the presence of the target is not known.</li></ul>
<b>unknown-IPC wells</b>	<p>In presence/absence experiments, wells that contain a sample and internal positive control (IPC).</p>
<b>VeriFlex™ Technology</b>	<p>The StepOnePlus™ instrument contains six independently thermally regulated VeriFlex™ blocks, creating up to six different zones for the 96 sample wells. After you enable the VeriFlex blocks in the StepOne™ software, you can set a different temperature for one or more of the VeriFlex blocks.</p>
<b>y-intercept</b>	<p>In the standard curve, the value of y where the regression line crosses the y-axis. The y-intercept indicates the expected threshold cycle (<math>C_T</math>) for a sample with quantity equal to 1.</p>
<b>zone</b>	<p>One of up to six sample temperatures among the 96 wells formed by independently thermally regulated VeriFlex™ blocks during the StepOnePlus™ instrument run. You can set a different temperature for one or more of the VeriFlex blocks, or you can set the same temperature for each of the VeriFlex blocks.</p> <hr/> <p><b>Note:</b> For melt curve steps, you need to set the same temperature for each of the VeriFlex blocks.</p> <hr/>
<b>zone boundary</b>	<p>The edge of a zone for samples formed by the six independently thermally regulated VeriFlex™ blocks. In the StepOne™ software, the zone boundaries are displayed in the plate layout as thick red lines.</p>



# Index

## Numerics

- 1-step RT-PCR
  - about 3-8
  - primers used 3-9
  - RNA quantitation 3-25, D-4, D-9
- 2-step RT-PCR
  - about 3-8
  - primers used 3-9
  - RNA quantitation 3-26, D-4, D-9

## A

- Advanced Setup workflow 1-9, 1-10
- amplicon sites
  - 3' primer end 3-23
  - 5' probe end 3-22
  - G/C content 3-22
  - melting temperature 3-22
  - screening 3-21
  - selection 3-21
- amplicons, selecting small 3-22
- Assay Design Guidelines
  - about C-1
  - genotyping experiments C-2
  - optimize primer concentrations 3-30
  - optimize probe concentration 3-33
  - presence/absence experiments 5-16
  - primer and probe 3-21, 3-23
  - quantitation experiments 3-21, C-1
  - selecting reagents 3-24
  - thermal cycling conditions 3-27
- assay types
  - Custom assays 1-9, 1-10
  - genotyping experiments 4-6
  - Inventoried/Made to Order Assays 1-9
  - Pre-Designed/Validated assays 1-10
  - presence/absence experiments 5-6
  - quantitation experiments 3-12
  - selecting 1-9

## C

- carryover, UNG to minimize 2-7
- comparative CT experiments
  - about 3-6
  - Also see quantitation experiments 3-6
  - components 3-6
- consumables

- Also see materials required 1-4
- supported 1-4
- contamination, minimizing DNA 2-7
- Custom assay type 1-9, 1-10
  - presence/absence experiments 5-16
  - quantitation experiments 3-21
- Custom TaqMan Gene Expression Assays 3-18, 5-12
- Custom TaqMan SNP Genotyping Assays 4-14

## D

- data
  - about data collection 1-2
- Design Wizard workflow 1-9, 1-10
- designing experiments
  - genotyping 4-14, 4-16
  - presence/absence 5-16
  - quantitation 3-20, 3-21
- DNA/cDNA quantitation, thermal cycling
  - conditions 3-28
- dye-binding, methods of 2-5

## E

- endogenous control
  - component of experiment 3-6
- endpoint experiments
  - genotyping 4-4
  - presence/absence 5-5

## G

- G/C content, and amplicon sites 3-22
- genotyping experiments
  - assay types 4-6
  - components 4-4
  - conclusions for Assay Design Guidelines C-2
  - described 4-4
  - designing 4-14, 4-16
  - how they work 4-4
  - instruments 4-4
  - mismatches 4-5
  - selecting master mix 4-13, 4-16
  - TaqMan reagents 2-2

## H

- hairpin loops, and primer choice 3-9

**I**

Inventoried assay type 1-9

IPC 5-4, 5-5

**M**

Made to Order assay type 1-9

master mix

selecting for genotyping experiments 4-13, 4-16

selecting for presence/absence experiments 5-15

selecting for quantitation experiments 3-19

melting temperature, and amplicon sites 3-22

mismatch, in genotyping experiments 4-5

multiplex PCR

described 3-10

primer limiting 3-10

rRNA primers B-1

singleplex comparison 3-10

MultiScribe reverse transcriptase, defined 3-26

**N**

negative control, component of experiment 3-5, 3-6, 5-4

negative controls 4-4

nonspecific product, contamination with SYBR Green dye 2-7

**O**

optimization 3-33

other fluorescent-based reagents 1-8

**P**

PCR, general practices 2-8

positive controls 4-4

Pre-Designed/Validated assay type 1-10

presence/absence experiments

Assay Design Guidelines for Custom assay type 5-16

assay types 5-6

components 5-4

defined 5-4

designing 5-16

how they work 5-5

incorporating an IPC 5-5

performing without an IPC 5-4

selecting master mix 5-15

selecting reagents for Custom assay type 3-24, D-3, D-9

TaqMan reagents 2-2

Primer Express Software

presence/absence experiments 5-16

quantitation experiments 3-21

small amplicons 3-22

SNP assays 1-10

primer limiting, multiplex assays 3-10

primer matrix

defining limits B-1

example of limiting B-2

how used 3-30

primers

1-step RT-PCR 3-9

2-step RT-PCR 3-9

default concentrations 3-30

hairpin loops 3-9

summary of design guidelines 3-23

probes

available TaqMan MGB probes 2-4

optimizing probe concentration 3-33

summary of design guidelines 3-23

**Q**

quantitation experiments

Assay Design Guidelines for Custom assay type 3-21

assay types 3-12

comparative CT 3-6

comparing 3-7

conclusions for Assay Design Guidelines C-1

designing 3-20, 3-21

explained 3-4

real-time PCR 3-4

relative standard curve 3-5

selecting a quantitation method 3-5

selecting master mix 3-19

selecting reagent type 3-12

selecting reagents for Custom assay type 3-24, D-3, D-9

standard curve 3-5

SYBR Green reagents 2-4, 3-31

TaqMan Reagents 2-2

**R**

reagents

considerations 2-6

other fluorescent-based 1-8

selecting 1-8, 2-6

selecting for Custom assay type 3-24, D-3, D-9

SYBR Green reagents 1-8

TaqMan reagents 1-8, 2-2

real-time PCR

quantitation experiments 3-4

TaqMan detection process 2-2

reference sample

component of experiment 3-5, 3-6

relative standard curve experiments

about 3-5

Also see quantitation experiments 3-5

components 3-5

replicate, component of experiment 3-5, 3-6

replicates 4-4, 5-4

RNA quantitation



1-step RT-PCR 3-25, D-4, D-9  
2-step RT-PCR 3-26, D-4, D-9  
thermal cycling conditions 3-28, 3-29

## RT-PCR

1-step 3-8  
2-step 3-8  
method comparison 3-7, 3-9

## S

sample 4-4, 5-4

### samples

component of experiment 3-5, 3-6

small amplicons, selecting 3-22

### standard curve experiments

about 3-5

Also see quantitation experiments 3-5

components 3-5

### standard dilution series

component of experiment 3-5, 3-6

### standards

component of experiment 3-5, 3-6

### StepOne system

assay types 1-9

consumables 1-4

data collection 1-2

experiment types 1-7

filters 1-3

reagent types 1-8

### SYBR Green reagents 1-3

considerations for selecting 2-6

development 2-5

how they work 2-5

optimizing quantitation experiments 3-31

## T

TaqMan Drug Metabolism Genotyping Assays 4-11

TaqMan Endogenous Control Assays 3-17

TaqMan Exogenous Internal Positive Control  
Reagents 5-13

TaqMan Gene Expression Assays 3-16, 5-10

TaqMan MGB probes 2-3

usage 2-4

TaqMan PDARs for AD 4-12

TaqMan reagents 1-3

considerations for selecting 2-6

development 2-2

experiment types 2-2

how they work 2-2

TaqMan SNP Genotyping Assays 4-10

### thermal cycling conditions

1-step RT-PCR 3-28

2-step RT-PCR 3-29

DNA/cDNA quantitation 3-28

RNA quantitation 3-28

## U

UNG, and minimizing carryover 2-7

Universal Master Mix reagents

polymerase benefit 3-26





**Worldwide Sales and Support**

Applied Biosystems vast distribution and service network, composed of highly trained support and applications personnel, reaches 150 countries on six continents. For sales office locations and technical support, please call our local office or refer to our Web site at [www.appliedbiosystems.com](http://www.appliedbiosystems.com).

**Headquarters**

850 Lincoln Centre Drive  
Foster City, CA 94404 USA  
Phone: +1 650.638.5800  
Toll Free (In North America): +1 800.345.5224  
Fax: +1 650.638.5884

12/2008