

**Acer GSM**

**G301**

---

*USER'S MANUAL*

## Copyright

---

Copyright © 1998 by Acer Peripherals, Incorporated. All rights reserved. No part of this publication may be reproduced, transmitted, transcribed, stored in a retrieval system or translated into any language or computer language, in any form or by any means, electronic, mechanical, magnetic, optical, chemical, manual or otherwise, without the prior written permission of Acer Peripherals, Incorporated.

## Disclaimer

---

Acer Peripherals, Incorporated makes no representations or warranties, either expressed or implied, with respect to the contents hereof and specifically disclaims any warranties, merchantability or fitness for any particular purpose. Further, Acer Peripherals, Incorporated reserves the right to revise this publication and to make changes from time to time in the contents hereof without obligation of Acer Peripherals, Incorporated to notify any person of such revision or changes.

## Table of Contents

---

<b>Chapter 1</b>	<b>Safety Information</b>	1
<b>Chapter 2</b>	<b>Presentation</b>	3
	Have the first look	3
	Accessories	5
	More info about the keys	5
	More info about the display	7
<b>Chapter 3</b>	<b>Getting Started</b>	8
	SIM card insertion	8
	Using batteries	10
	Charging batteries	11
<b>Chapter 4</b>	<b>Making Your First Call</b>	14
	Making a call	14
	Answer a call	15
	Adjust the earpiece volume	15
<b>Chapter 5</b>	<b>Making Your Call Easy</b>	16
	One-Touch Dialing	16
	Make an international call	16
	Make an emergency call	16
	Make a voice mail	17
	Missed call	17
	Abbreviated Call	17
	Last 10 number redial	18
	Incoming call waiting	18
	In call option	18
	Mute call	18
	Notepad	18

End call	18
Swap call	19
Hold call	19
Unhold call	19
Join call	19
Private call	19
Messages	19
<b>Chapter 6 Knowing the Menu Better</b>	20
<b>Phone book</b>	21
1-1 Add record	21
1-2 Find Record	21
1-3 Delete record	22
1-4 Memory selection	22
1-5 Last number	22
<b>Message</b>	23
2-1 New message	23
2-2 Write message	23
2-3 Saved message	23
2-4 Listen message	24
2-5 Cell message	24
2-6 Message settings	24
2-7 Delete all	25
<b>Call services</b>	26
3-1 Call diverting	26
3-2 Call barring	27
3-3 call waiting	27
3-4 Call information	28
<b>Handset settings</b>	29
4-1 Back light	29
4-2 Auto redial	29
4-3 Answer by	29
4-4 Keypad lock	29
4-5 Restore	30
4-6 Language	30
4-7 Time alert	30

<b>Audio settings</b>	31
5-1 Ring volume	31
5-2 Ring type	31
5-3 Keypad tone	31
<b>Security settings</b>	32
6-1 Set code status	32
6-2 Change password	32
6-3 Fixed dial	33
<b>Network selection</b>	34
7-1 Automatic selection	34
7-2 Manual selection	34
<b>Tool box</b>	35
8-1 Notepad	35
<b>Chapter 7 Care and Maintenance</b>	36
<b>Index</b>	37



## Chapter 1

### SAFETY INFORMATION

---

#### On the Road...

- Follow regulations in force concerning the use of cellular phone in the place you are driving.
- Use hands-free operation while driving a vehicle.
- Park your car before conversing.

#### In the Air...

Using cellular phones in an aircraft may cause interference to the radar system which is illegal.

- Switch off your cellular phone before you board on an aircraft.

#### Dangerous Areas...

Turn off your phone when you are near the following places:

- Refueling station
- Fuel depots
- Chemical plants
- Blasting operation area

#### And These Electronic Devices...

Your cellular phone may cause interference or malfunction of electronic equipment that is not adequately shielded from radio

frequency energy.

Beware of interference which usage of your phone may cause to the following devices:

- Medical devices, e.g. pacemakers, hearing aids
- Electronic fuel injection systems
- Electronic anti-skid braking systems
- Electronic cruise control systems
- Other electronic systems

 **NOTE!!**

*Consult the dealer of your electronic devices for possible influences.*

**WARNING!!**

Failure to follow these instructions may lead to suspension or denial of cellular phone services to the offender or legal action or both.



## Chapter 2 PRESENTATION

---

Have the first look

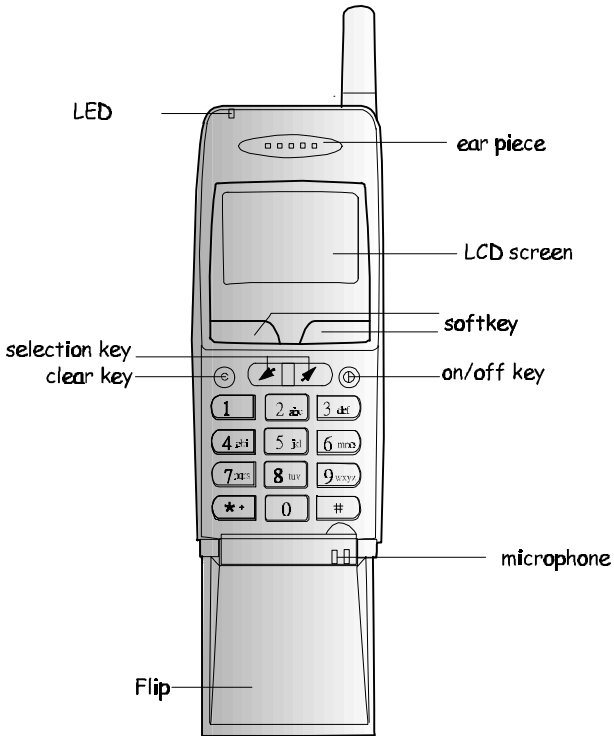

Front View

Fig. 1

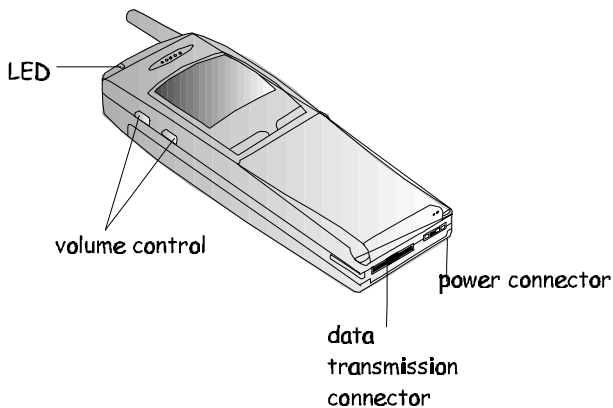

Side & Bottom View  
Fig. 2

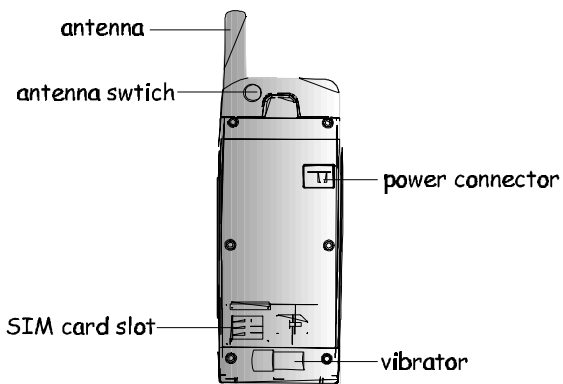

Rear View  
Fig. 3



## 2-2 Accessories



With your purchase of this mobile phone, apart from the phone itself, various accessories such as travel charger, desktop charger, Li-ion batteries, Ni-MH batteries, portable hand-free and hand-free car kit are available, which you can find in the authorized dealers.

## 2-3 More info about the keys

Two types of keys: function keys and alphanumeric keys on the keypad help you communicate with your personal phone. In the following, they will be introduced to you with their names and respective functions.

### **FUNCTION KEYS**

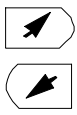

<b>Symbol</b>	<b>Name</b>	<b>Functions</b>
	<b>Clear Key</b>	Short press to clear only one letter. Long press to clear all input text.
	<b>Power On/Off Key</b>	Long press to turn power on/off of your mobile.

	<b>Select ion Keys</b>	<p>They scroll through menus, submenus or settings and allow you to choose the function you want to use on the menu.</p> <p>A quick access to phone book. In standby mode, press these keys to link to phone book directly.</p>
	<b>Soft keys</b>	<p>It locates underneath the display screen and allows you to choose the function of send, quit, save, menu, select and confirm.</p>

## ALPHANUMERIC KEYS:







Numbers and letters can be keyed into the screen by using these keys. For example, if you want to key in "JOHN", please press "5" once, "6" three times, "4" twice and "6" twice. If typing a letter wrong, you can use the selection keys to forward or backward the cursor and clear key to erase letters. Moreover, if capital letter is needed, press the key longer, the capital will show on the screen. Below is the chart for the keys and their correspondent characters of this mobile.

KEY	CHARACTERS
1	, . : 1 % ! ? ; " ' < > ( ) @ &
2 abc	A B C 2 Å Ä å ä à ç æ ß
3 def	D E F 3 è é É £ Æ \$
4 ghi	G H I 4 ï î ï ; ð
5 jkl	J K L 5 Δ _ Φ Γ Λ Ω
6 mno	M N O 6 Ñ ñ ò ö ø Ø ö
7pqrs	P Q R S 7 ¥ §
8 tuv	T U V 8 ü Ü ù
9 wxyz	W X Y Z 9 Π Ψ Σ Θ Ξ 1)
0	_ 0

			$+ - * / =$
			# P

## 2-4 More info about the display

There are several icons often shown on the LCD screen. The following is the essential information about them.

ICON	NAME	MEANING
	<b>Signal Strength</b>	The more the bars displayed, the better the signal strength
	<b>Phone Book Memory</b>	1 refers to SIM card memory.
		2 refers to the phone's internal memory.
	<b>Roaming</b>	When your phone is used in other network rather than your home network, this icon shows.
	<b>Short Message</b>	This symbol will be on when a message is received and will flash when messages storage memory is full.
	<b>Ringer</b>	Indicating audible ringer is on.
	<b>Vibrator</b>	Indicating vibrator ringer is on.



**Battery  
status  
Indicator**

It shows four levels of strength of the battery. The more the bars, the more the strength. When charging, you can see the strength of battery on the screen and the bars flash till the battery is full.



## Chapter 3

### GETTING STARTED

---

#### 3-1 SIM Card Insertion

##### **What is SIM card?**

You need a SIM (Subscriber Identification Memory) card to access your mobile phone and network. Two types of SIM are on the market. For this mobile, you need a small size card. This card contains all the important information of your phone account such as network accesses, PIN number, phone books, messages, and services. Please handle it with special care. If lose it, please contact your dealer or service provider as soon as possible.

##### **Install your SIM card**

Before installing your SIM card, please switch off the phone and take off the battery. As you can see on Figure 4, a SIM card slot is on the lower left corner on the back of your phone. Insert the card as indicated as Figure 4. Put the charged battery back to the slot. The SIM card installation is done.

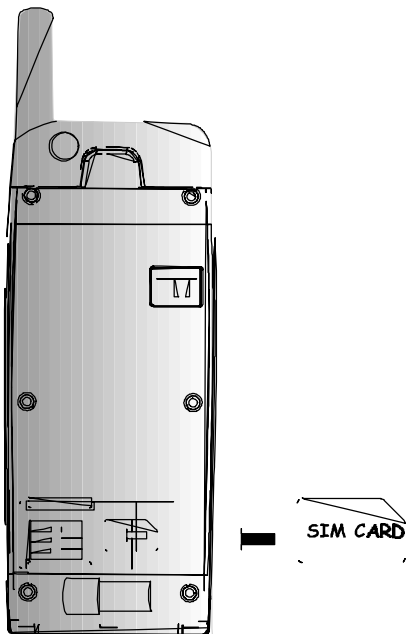

Install your SIM card  
Fig. 4

## 3-2 Using Batteries

### **Fitting batteries**

Fit the battery bottom into the battery slot as showed in Figure 5.

Then push the top end of the battery into the slot.

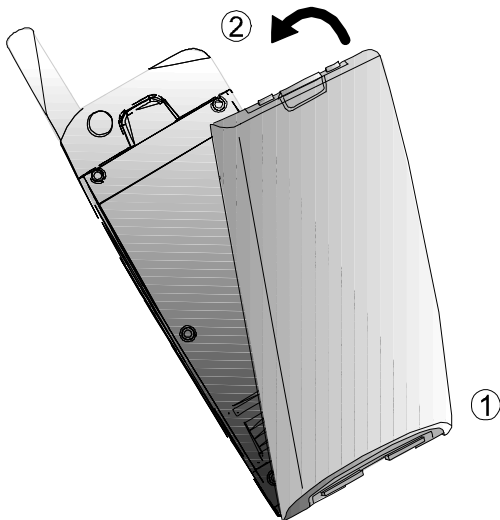

Figure 5

### **Removing batteries**

Press the key on the top end of your battery and pull the battery towards the opposite side of the mobile. The battery

will slip out from the slot.

### 3-3 Charging Batteries

Your mobile phone is powered by a rechargeable, environment-friendly battery. When the power is low, a "BATTERY LOW" message appears warning you to recharge it as soon as possible.

Two typical approaches for you to recharge the battery:

#### **Travel charging**

Using the cable provided to recharge your battery. Plug one end of the cable to the charging socket situated at the bottom of the phone, and the other end to the adapter as showed in Figure 6. On the screen, the battery strength bars will flash on the LCD screen till the battery is full.

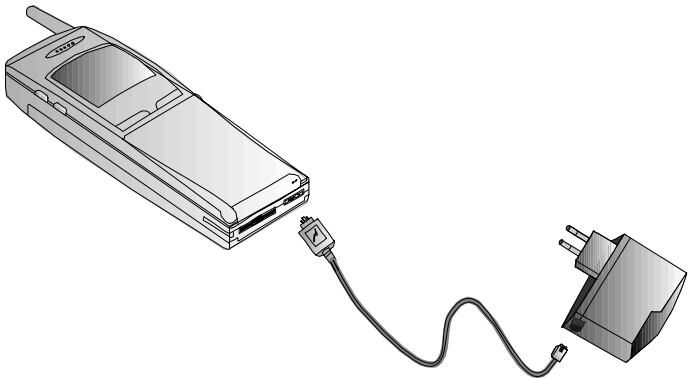

Fig. 6

## Desktop charging

You can also charge your battery with a desktop charger ( See Figure 7 ).

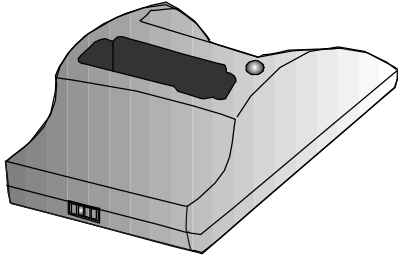

Fig. 7

- ◆ Connect the travel charger cable to the desktop charger and the power outlet.
- ◆ Put your phone on the desktop charger as showed in Figure 8.

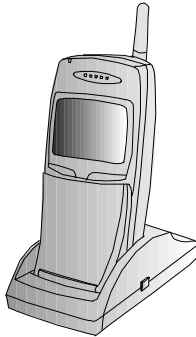

Fig. 8

- ◆ Or you can detach the battery, and locate it on the rear side of the charger as showed in Figure 9 & 10.

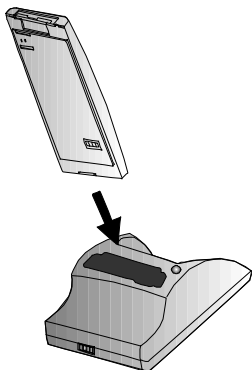

Fig. 9

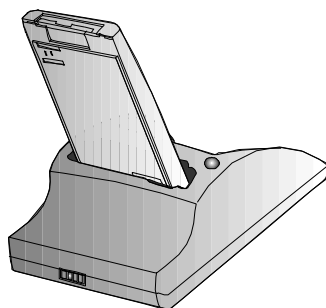

Fig. 10

**👉 NOTE!!**

*When charging, the light of the charger is red. After the completion of this program, it will turn green.*

**👉 NOTE!!**

*It is recommendable that you discharge the battery before recharge it. With this type of charger, you can push the gray bottom on the side of the charger to do so.*



## Chapter 4

### MAKING YOUR FIRST CALL

---

#### MAKE A CALL

**Step 1** Press ① button to switch your phone on. Then a greeting screen appears.

**Step 2** Enter your PIN number and click OK.

 **NOTE!!**

*If this is your first time to enter the PIN, please enter the PIN the network provider gave you with the purchase of your SIM card. The number you type will appear as starts sign on the screen for security reasons. For details, please refer to section 6 in Chapter 6.*

 **NOTE!!**

*When entering wrong PIN over three times, your phone will be locked up. It will not allow any attempt. You shall contact your dealer to solve this problem.*

**Step 3** After the PIN is accepted, your phone starts searching the designated network automatically.

 **NOTE!!**

*However, when the network service is not available, the following signs: “no service” will pop up on the screen.*

**Step 4** After connecting to the network successfully, LCD screen will show which network you connect to. In this "stand-by" mode, dial the phone number including the area code you desire. Then, press the soft key underneath "send" sign on the display to send out your call. Or if wishing to cancel/disconnect the call, press the soft key underneath the "end" sign.

 **NOTE!!**

*If necessary, use the keys on the side of the phone to adjust the volume.*

**ANSWER A CALL**

When the phone rings or vibrates, press "answer" softkey to accept and call and then talk.

Three-mode options for you to answer your calls: "Auto" mode, "Any key" mode and "Send key" mode. Please refer to section 4 at Chapter 6 for details.

**ADJUST THE EARPEICE VOLUME**

Press the buttons on the side of the phone to adjust the volume of the earpiece. Five levels of volume are available for your selection.

## Chapter 5

### MAKING YOUR CALL EASY

---

#### One-Touch Dialing

Two ways for you to do one-touch dialing while on stand-by mode

- ◆ You can use the first 10 record saved in the phone book by press the location of the desired number. For instance, if the location is 5, press 5 key to initiate the call. The name and number will appear on the screen when sending out the call.
- ◆ Or you long press " send" key. The last number you dial will be sent out directly.

#### Make an International Call

- ◆ Press "\*" key for about 1 seconds till "+" shows up on the display.
- ◆ Enter outgoing call's national code, area code and phone number.
- ◆ Send out your key by pressing "send" softkey.



#### **NOTE!!**

*Please omit the first zero of receiver's area code.*

#### Make an Emergency Call

Enter 112(The international emergency

number) and press send key. The call will be sent out.

 **NOTE!!**

*This 112 number can be used in any country despite if a SIM card is available. As long as you are included in a GSM network.*

### **Make a Voice Mail Call**

Long press 0 and you will link to your voice mail center directly if you have subscribed to your network provider and saved the voice mail number in your phone. For details, please refer to section 2-4 & 2-6 at Chapter 6.

### **Missed Call**

If for any reason, incoming calls can not be answered, a missed call message will appear on the screen to remind you the calls you missed.

### **Abbreviated Call**

- ◆ Key in a number ( 1 to 9 ) which locates the desired phone number in the memory
- ◆ Then press <send> key to enter them.
- ◆ Press <send> key to send out the call when the number shown is correct.
- ◆ You can scroll numbers in the memory by pressing selection keys till the desired number shows up.

### **Last 10 number Redial**

- ◆ Press "send" key to access the last

number dialed.

- ◆ Press selection keys to scroll through the last 10 numbers dialed.
- ◆ Press "send" key to send the call if the number shown is correct.

 **NOTE!!**

*You can long press the send key to send out the last number dialed directly.*

## **Incoming Call Waiting**

This function is only available if you have subscribed to your network provider. An incoming call number and call-waiting message will appear on the screen when a new incoming call arrives yet while you on a call. To initiate this function, enter the Call Services menu.

- ◆ Press 0 and send key to reject the waiting call.
- ◆ Press 1 and send key to end the active call and connect the waiting call.
- ◆ Press 2 and send key to hold on the active call and connect to the waiting call.

## **In Call Option**

The in call option functions are prepared for you to handle several situations while you are making a call. Some of these functions can be operated only under their respective circumstances. To access these functions during a call, press the "option" softkey while on a call.

### **1.Mute call**

When no sound wants to be heard by your interlocutor when you are on a call. You

can choose the Mute function to do so.

## **2. Notepad**

Here is an electronic memo for you to note down important issues while on a call.

## **3. End call**

Under a circumstance of multi-call, you can end up one of them by selecting this function.

## **4. Swap call**

This function is available when you have both active and held calls. Swap transfers the active call to hold and vice versa, so that you may converse with the other party.

## **5. Hold call**

This function allows you to put a currently active call on hold, so that you can initiate a new call.

## **6. Unhold call**

Once you end the new call while holding an old call, the old call can be made active again by selecting this function.

## **7. Join call**

This function can let you make a conference call where up to six persons can take part.

## **8.Private call**

During a conference call, you can use this function to talk privately with one participant.

## **9.Messages**

You can read or write messages under this function. Please refer to section 2 in chapter 6 for details.



## Chapter 6

### KNOWING THE MENU BETTER

---

#### MENU TREE: A Quick Look

Phone Book	Add record	1.1
	Find record	1.2
	Delete record	1.3
	Memory selection	1.4
	Last number	1.5
Message	New message	2.1
	Write message	2.2
	Saved message	2.3
	Listen message	2.4
	Cell broadcast	2.5
	Message settings	2.6
	Delete All	2.7
Call Services	Call divert	3.1
	Call barring	3.2
	Call waiting	3.3
	Call information	3.4
Handset Settings	Backlight	4.1
	Auto redial	4.2
	Answer by	4.3
	Keypad lock	4.4
	Restore	4.5
	Language	4.6
	Time alert	4.7
Audio settings	Ring volume	5.1
	Ring type	5.2
	Keypad type	5.3
	Warning tone	5.4
Security Settings	Set code status	
6.1	Change password	6.2
	Fixed dial	6.3
Network Selection	Automatic selection	7.1
	Manual selection	7.2
Toll Box	Notepad	8.1



## 1 PHONE BOOK

Phone book menu allows you to set up your own phone book. You can add or delete the records anytime you want. Further, you are able to choose to save the records either in SIM card memory or phone memory. Moreover, you can search the last number you dial, the last number you receive, and the last number you miss through this phone book function.

The following is the structure and details of this directory.

### 1-1 ADD RECORD

- ◆ After selecting this 'Add Record' function, you see a screen asking you to enter the name of the receiver you desire to add to the phone book.
- ◆ Key in the name and click "OK". Then a screen appears asking you to enter the phone number.
- ◆ Enter the number and click "OK". And the phone will assign a location for this receiver automatically.
- ◆ Click "OK" to confirm the location. A screen message "Record saved" shows.
- ◆ If more records need to be saved, please repeat the steps above to complete your recording.

### 1-2 FIND RECORD

### **1-2-1 By name**

You can search the saved record by entering the name of the receiver. After entering the name, his/her location, phone number and name will appear simultaneously on the screen. Then you can send the call out to him/her by clicking "send" key.

### **1-2-2 By location**

- ◆ If you prefer to search the records by location, when screen shows "Find By Name", you can use selection key to put you to "Find By location" mode.
- ◆ After selecting this mode, the screen asks you to key in the location, a number code, of the receiver.
- ◆ After the number has been accepted, the receiver's phone number, name and location will be demonstrated on the screen.

## **1-3 DELETE RECORD**

You can erase records which are no longer needed here. There are two ways to delete the records: By name or By location. After you key in the name or location of the record you wish to delete, the information of the receiver will demonstrate on the screen again. Then click "OK", this record will be erased.

#### 1-4 MEMORY SELECTION

You can choose which memory base you desire to store your record. This mobile provides two options for you to do so: SIM card memory and phone memory. When SIM card memory mode is selected, it means that you can take your information with you by carrying the card solely. In another word, when phone memory is chosen, all information is saved in the phone system.

#### 1-5 LAST NUMBER

All the data relates to the last number can be traced at this category. Four service items are provided here: Last number Dialed, Last number received, Last number missed, Delete All (clear all the data) .

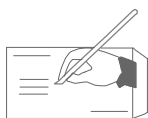

## 2 MESSAGE

#### 2-1 NEW MESSAGE

If a new text message delivered, a short message icon appears on the screen. Please enter this function to read the new message.

- ◆ After reading, you can choose to reply, forward or erase the message.
- ◆ If no new message at all, "No new

message" sign shows on the display.

#### 2-2 WRITE MESSAGE

You can write short text messages by using this fun.

- ◆ Key in your message and click "OK".
  
- ◆ Enter the number you assign to receive the message.
- ◆ This message will be saved and a sign " Message saved. Send?" sign pops on the screen to seek your confirmation.
- ◆ Click "Yes" or "No" to send or cancel the short message.

#### 2-3 SAVED MESSAGE

You are able to read saved messages after entering this function. Select one saved message and press "option" softkey to edit, delete, reply, and send the message. Plus, if a phone number data is included in the message, the number can be saved or dialed by using "Use number" function.

#### 2-4 LISTEN MESSAGE

When entering this submenu, the phone will call your voice mailbox at the phone number stored in menu 2-6-3.

## 2-5 CELL BROADCAST

You can receive cell broadcast offered by your network provider, and choose preferred topics and languages.

## 2-6 MESSAGE SETTINGS

### **2-6-1 Message center**

This function stores the phone number of the message center for sending your text messages. You can obtain this number from your service provider.

### **2-6-2 Valid period 12 hrs**

You can set the time that your text messages are stored at the message center while the message center attempts to deliver the message.

### **2-6-3 Voice mail box**

Within this submenu, you can store the phone number of your voice mailbox. You can obtain this number from your network provider.

### **2-6-4 Reply path**

You can request the network to set the route of replied message via your own message center.

### **2-6-5 Delivering report**

If you initiate this function, your

network will send you a delivering report.

#### **2-6-6 Alert beep**

If receiving a short message, this alert beep function will remind you of this when it is initiated.

#### **2-6-7 Message format**

You can request the network to convert your text message into the following formats: Text, Paging, E-mail, Fax, Voice, ERMES, Telex and 6rp4 Fax, 8 various forms of messages can be chosen from the options.

#### **2-7 DELETE ALL**

Delete all the messages. If you just want to delete certain messages, please refer to 2-1 & 2-3 in this chapter for details.



## 3 CALL SERVICES

### 3-1 CALL DIVERT

Several diverting modes can be selected here. You can divert the calls under different circumstances.

The following are the options.



#### **NOTE!!**

*When this diverting function is no longer needed, you can switch off this diverting function. Also, you can select "status" to check if you are in a diverting mode.*

#### **3-1-1 Divert/ No condition**

You can send your calls to another designated phone number. Key in the number you wish to divert your calls.

#### **3-1-2 Divert if busy**

You send your calls to a designated phone number when your phone is busy.

#### **3-1-3 Divert if no reply**

When the incoming call is not replied, your calls will be sent to another phone you assign. Key in the number you desire to send.

#### **3-1-4 Divert if unreachable**

When the network is unavailable, your



calls will be sent to another designated number. Set the number at this branch.

**3-1-5 Cancel All**

You can cancel all the diverting function here.

3-2 CALL BARRING

If wishing to bar outgoing or incoming calls, you can use the barring function to set up limitations.

**3-2-1 Bar All out**

Bar all outgoing calls.

**3-2-2 Bar Int'l Out**

Bar all outgoing international calls.

**3-2-3 IntExtH Out**

Bar outgoing international calls except calls that connecting to home network.

**3-2-4 Bar All In**

Bar all incoming calls.

**3-2-5 Bar Roaming in**

Bar incoming calls when roaming.

**3-2-6 Cancel All**

Cancel all barring setting.

### 3-3 CALL WAITING

This function is only available when you have subscribed to your network provider. An incoming call number and a call-waiting message will appear when a new incoming call is directed to your phone when you are on another call. You can activate or cancel this function by checking the statue here.

### 3-4 CALL INFORMATION

#### **3-4-1 Last call**

##### 3-4-1-1 Call Duration:

It shows the duration of the last call in hour, minute & second.

##### 3-4-1-2 Call cost:

It shows the cost of the last call.

#### **3-4-2 All calls**

##### 3-4-2-1 Call Duration

It show total duration of calls in hour, minute & second since you reset the timer.

##### 3-4-2-2 Call Cost:

It shows the total fare of the calls since the meter starts.

##### 3-4-2-3 Clear Counters:

Reset the meter of call cost and call duration.

#### **3-4-3 Call rate**

##### 3-4-3-1 Currency:

Enter a preferred currency base to calculate the fare of your calls.

3-4-3-2 Charge Unit:

Enter the unit price to count the fare.

**3-4-4 Cost Limit(On/Off)**

You can set limits to the total call cost.

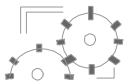

## 4 HANDSET SETTINGS

### 4-1 BACK LIGHT

5 different levels for you to adjust the background lighting of the LCD screen.

### 4-2 AUTO REDIAL

Two ways to redial a call.

- ◆ The auto mode redials continuously the number
- ◆ The prompt mode requires your confirmation before redialing the phone number
- ◆ You are able to cancel these auto redial modes

### 4-3 ANSWER BY

Three options available for you to answer incoming calls.

- ◆ The auto mode enables the phone to be automatically answered after it rings once.
- ◆ The calls can be answered by clicking any key.
- ◆ The calls can be answered by clicking "send" key.

### 4-4 KEYPAD LOCK

You can use keypad-lock function to prevent unwilling key-in actions say

when you put your phone in a bag.  
Also you can long press # to initiate  
the keypad lock function.

4-5 RESTORE

Reset all the settings to the default  
configuration.

4-6 LANGAUGE

Chinese (Both simplified and  
traditional versions), Czechoslovakia,  
Danish, Deutsche, Dutch, English,  
French, Finish, Hungarian, Italian,  
Polish, Portuguese, Norwegian, Spanish,  
Swedish, and Russian, 17 languages  
available for your preference to  
choose.

4-7 TIME ALERT

Your phone will beep once a minute when  
you make a call  
after you initiate this function.



## 5 AUDIO SETTINGS

### 5-1 RING VOLUME

After entering the menu, use selection keys to adjust the ring volume. 5-level adjustment option.

### 5-2 RING TYPE

7 ring types, one vibrator and 9 melodies for you to choose in terms of ring type of your mobile.

### 5-3 KEYPAD TONE

You can control the on/off of your keypad tone by using this function.



## 6 SECURITY SETTINGS

### 6-1 SET CODE STATUS

Two sets of PIN can be set to protect your phone. PIN code is recorded in SIM card memory. Phone code is carried with the phone system.

#### **6-1-1 PIN Code**

Activate/Deactivate the PIN code function. When changing the Activate/Deactivate status, you have to enter your PIN.

#### **6-1-2 Phone Code**

Activate/Deactivate the Phone Code. When changing the Activate/Deactivate status, you have to enter your phone code.

### 6-2 CHANGE PASSWORD

#### **6-2-1 PIN**

You need to activate PIN function as described in 6-1-1 before changing your PIN.

- ◆ In the beginning, you have to enter the original PIN.

- ◆ Then enter a new PIN.
- ◆ Reconfirm the new PIN by entering the new PIN again.

### **6-2-2 PIN 2**

This second set of PIN is mainly used to control limited services such as call cost limitation and fixed dialing numbers. You can change PIN 2 the same way described in 6-2-1.

### **6-2-3 Phone Code**

You can change your phone code the same way described in 6-2-1.

### **6-2-4 Net Password**

You can change net password the same way described in 6-2-1.

.

## **6-3 FIXED DIAL**

You can set limitation of the numbers you call out.



### **NOTE!!**

*You need to have PIN2 to activate this function.*

### **6-3-1 View**

Under this branch, you can see what Fixed Dial numbers you set.



### **6-3-2 Set status (on/Off)**

Switch on/off about this Fixed Dial function.

### **6-3-3 Modify**

You can add or change records of your fixed-dial numbers.



## 7 NETWORK SELECTION

When turning on your mobile phone, the phone automatically selects the home network for you. You can also do network selection by manual modes.

### 7-1 Automatic Selection

This mode automatically searches the available services when the phone is turned on.

### 7-2 Manual Selection

Manual selection shows connectable networks and allows you link to the one you desire.



## 8 TOOL BOX

### 8-1 NOTEPAD

You can jot down important issues here.

## Chapter 7

### CARE & MAINTANANCE

---

Notice the following to ensure the proper usage and the life of your cellular phone:

- Keep your cellular phone and its accessories out of small children's reach.
- Keep your phone set dry.
- Use your phone at a normal temperature. Temperature higher than 55°C or lower than -20°C (higher than 131°F or lower than -4°F) may cause damage to your handset.
- Do not use or store your phone in dusty or dirty areas of possible.
- Do not disassemble the phone.
- Do not use harsh detergents to clean the phone.



#### **NOTE!!**

*If your phone or its accessories are not working properly, consult your cellular phone dealer for services.*

## Index

---

A		F	
Abbreviate	17	Fixed dial	33
d call			25
Answer	15, 29	Format	
Anykey	29	H	19
answer	29	Hold call	
Auto	29	I	16, 27
answer		Internation	27
Auto	27, 30	al call	27
redial	26	IntExtH out	
B	5, 7, 11	Int'l out	19
Barring	10	J	
Busy	24	Join call	29
		K	31
Battery	26	Keypad lock	
Battery	19	Keypad tone	30
Low	18, 27	L	5
Broadcast	7, 11	Language	14
C	28,	Li-ion	24
Call		Limited	
divert	24	services	34
Call hold		Listen	7, 21, 32
Call	12	message	7, 23
waiting	13	M	24
Charging		Manual	18
Cost	16	selection	
D		Memory	
Delivering		Message	
report		Message	
Desk		center	
charger		Mute	
Discharge			
E			

Emergency  
call

N		R	
Network	14, 24	Redial	17, 29
Ni-MH	5	Ring type	31
No reply	26	Ring volume	31
Notepad	18, 35	Roaming	7, 27
No	26	S	
condition	14	Signal	7
No service		strength	8
O	16	SIM card	5
One touch		Softkey	15
dialing		Standby	19
P	14, 32, 33	mode	
PIN	32	Swap call	30
PIN2	7, 21	T	
Phone book	32, 33	Time alert	19
Phone code	22, 32	U	26
Phone	5	Unhold call	
memory		Unreachable	17, 24
Portable	19	V	24
handfree		Voice mail	7, 31
Private		Valid	15, 31
call		period	
		Vibrator	
		Volume	