

USER MANUAL

B/E SERIES

Contents:

1. General description	4
2. Completeness	4
3. Technical data	5
4. Keys and indicators	6
5. Security rules	7
6. Environment protection	7
7. Preparation	8
8. Start-up	9
9. General rules	10
10. Balance checking	11
11. Scale adjustment	11
12. Connecting computer, printer or label printer	11
13. Basic function	15
13.1 Normal weighing	15
13.2 Weighing with tare	16
13.3 Increased readability	16
14. Special functions description	17
14.1 Menu customization function (ACtIV and dEFAUL)	18
14.2 Autozeroing function (AutoZE)	19
14.3 Pieces counting (PCS)	20
14.4 Printer cooperation settings (PrInt)	21
14.5 Serial port parameters setting (Port)	22
14.6 Constant tare (tArE)	23
14.7 Average calculation function (AVErAG)	25
14.8 Recipe weighing function (RECIPE)	26
14.9 Percentage weighing function (PERC)	27
14.10 Anti-disturbance filter function (FILtEr)	28
14.11 Function for maximum value indication (UP)	29
14.12 Force measuring function (nEWto)	30
14.13 Function for weighing large animals (LOC)	31
14.14 Checkweighing function (thr)	32

14.15	<i>Total weight function (totAL)</i>	35
14.16	<i>Function for setting date and time (dAtE)</i>	37
14.17	<i>Function for selecting label number (LAbEL)</i>	38
14.18	<i>External calibration (CALIb)</i>	39
14.19	<i>Setting time of stabilization function (Stb)</i>	40
14.20	<i>Entering reference zero function (Zero)</i>	41
14.21	<i>Automatic switching off the scale function (AutoOF)</i>	42
14.22	<i>Density determining function (dEnSIt)</i>	43
14.23	<i>Calculator for good packaging control (tP)</i>	45
14.24	<i>Statistical calculations function (StAt)</i>	48
14.25	<i>Paperweight calculation (PAP)</i>	50
	<i>Maintenance and repairs of small defects</i>	51
	<i>Declaration of Conformity</i>	52
	<i>Appendix A</i>	53

1. General description

B/E series platform scales are destined for general use.

All scales are metrologically tested - calibration or legal verification on demand.

Standard B/E scales are equipped with the display mounted on the post for easy readout of weighing result. Optional, the scale may be delivered with the display adapted for wall mounting, connected with the platform with a cable.

Balances with legal verification are mark with the following:

- protective seals placed on the casing mounting screw at the back of the balance and on the measuring sensor screw under the pan,
- notified body stamps and green metrological marking placed on the balance name plate.

Legal verification is valid for 3 years unless the seal is broken.

NACE classification: : 29.24.23.

Certificates:



EC Type
Approval Certificate
No. PL 04 022



Health Quality
Certificate
No. HŽ/06458/01



AXIS management
system certificate
DIN EN ISO 9001:2000
No. 78 100 6386

2. Completeness

Standard set consist of:

1. Scale
2. User Manual
3. Guarantee card
4. Feeder 12V/500mA

3. Technical data

Scale type	B30E	B60E	B150E
Capacity	30kg	60kg	150kg
Minimum load	200g	400g	1kg
Readability(d)	10g *5g *1g	20g *10g *5g *2g	50g *10g
Verification unit (e)	10g	20g	50g
Accuracy class	III		
Working temperature	-10 ÷ +40°C		
Tare range	-30kg	-60kg	-150kg
Weighing time	<4s		
Pan size	400x490mm		
Platform size	400x655x130mm		
Scale height	725mm (standard)		
Platform-indicator cable length	3m (optional)		
Power supply	230V, 50Hz, 8VA / 12V 500mA		
Scale weight	15kg	15kg	15kg
EC verification	✓	✓	✓

* increased readability for non-EC verification applications

4. Keys and indicators

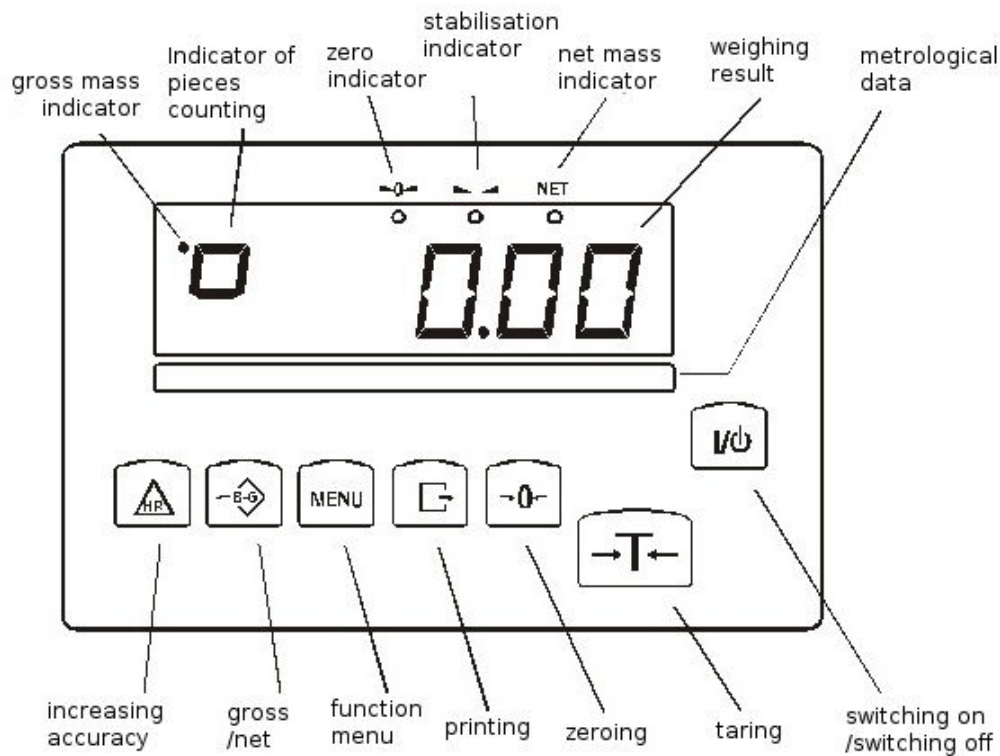

key	I/O	- switch-on / switch-off (standby),
key	$\rightarrow T \leftarrow$	- tare (subtract package weight from weighed mass)
key	B/G	- gross weigh indication switch,
key	$\rightarrow 0 \leftarrow$	- zero,
key	<i>MENU</i>	- special functions menu,
key	$\square \rightarrow$	- print-out,
key	<i>HR</i>	- increased indication resolution,
indicator	$\rightarrow 0 \leftarrow$	- zero indicator
indicator	\sim	- result stabilisation indicator
indicator	<i>NET</i>	- net weight indicator (indication with subtracted tare)
indicator	.	- gross weigh indicator (after pressing B/G key)
indicator	\square	- pieces counting (indications in pieces)

5. Security rules

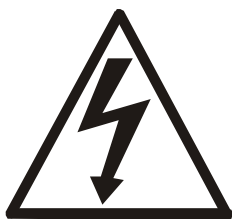

To avoid electrical shock or damage of the scale or connected peripheral devices, it is necessary to follow the security rules below.

- All repairs and necessary regulations can be made by authorised personnel only.
- To avoid fire risk use a feeder of an appropriate type (supplied with the scale). Pay attention that supply voltage is compatible with specified technical data.
- Do not use the scale when its cover is opened.
- Do not use the scale in explosive conditions.
- Do not use the scale in high humidity.
- If the scale seems not to operate properly, unplug it from the mains and do not use until checked by authorised service.

6. Environment protection



According to legal regulations it is forbidden to dispose of wasted electronic equipment in waste containers.

- Please return wasted scale to the point of purchase or other company specialised in recycling of wasted electronic components.

7. Preparation

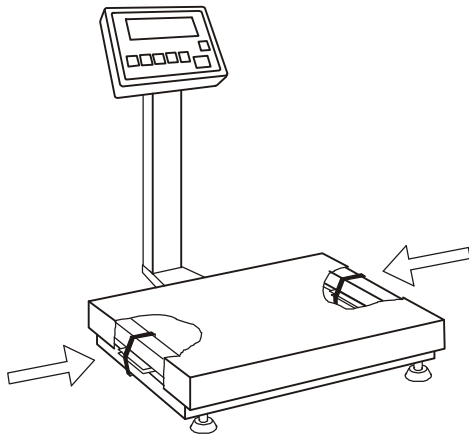

Correct



Wrong

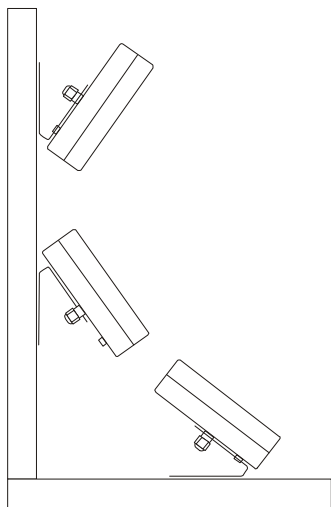

1. Take the scale out of the package removing protective foils.
2. Take a pan off and remove protective elements from below the pan.
3. Place the scale on a stable ground not affected by mechanical vibrations and airflows.
4. Level the scale with the rotating rear legs so that the air bubble in the water-level at the back of the scale is in the middle. Lock the legs with the nut.
5. Put on the pan.
6. In scales with the indicator connected with the platform with the cable (optional), mount the indicator on the wall or a desktop so that weighing results are easily and clearly visible (suggested mounting positions at the picture at the left).
7. Plug the feeder connector to the power socket at the back of the scale and plug the feeder to the mains. After self-tests and result stabilisation, the scale displays zero indication.

8. Start-up

Leave the pan empty, plug the feeder to the mains (~230V/50Hz) and plug the feeder connector to the 12V power socket at the back of the scale.

The scale proceeds with following start-up actions:

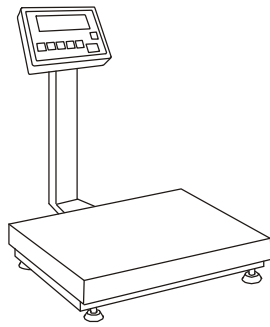

88888

Display test.



C-1

Basic electronic components tests: C1, C-2, ... C-6.

...

C-6



b-...

Program version.



⁻⁰⁻ 0.00

The scale is now ready to work.

9. General rules

1. Before each measurement make sure that zero indicator is displayed. If zero indicator does not displayed or “----“ communicate appears, press →0← key and wait until zero indication and zero indicator appears.
2. The scale is equipped with a tare equal to its range. To tare the scale press →T← key (left or right). Storing a tare value does not extend measuring range, but only subtracts it from a load placed on a pan. To make weight control easier and to avoid range overdrawing, the scale is equipped with a load indicator (graduated in percentages).
3. Weighing result should be read when the indicator "└┘" lights, which signalises stabilisation of a result.
4. When the scale is not used but it is necessary to be ready to work immediately, it can be switched off by pressing I/⊕ key. The scale reading system is then switched off to "standby" mode (signalled by the indicator "OFF" in version with the LCD display). To switch the scale on press I/⊕ key. The scale is immediately ready to operate maximum accuracy (after self tests).
5. Weighed sample should be placed in the centre of the pan.



Place the scale on a platform to avoid dropping weighed objects on the pan.



Do not overload the scale more than 20% of maximum load (Max).

6. Protect the scale against dust, aggressive dusts and liquids. To clean the scale wash it with water with soap and dry it afterwards.

10. Balance checking

It is advised to check scale indication accuracy before and after series of measurement using any load with known weight.

To check the scale with legal verification use a calibration weight with valid calibration certificate. In case permissible error is exceeded it is advised to contact the nearest service to calibrate the scale.

11. Scale adjustment



To adjust a balance it is necessary to break protective marks, therefore to calibrate the scale please contact the nearest service.

12. Connecting computer, printer or label printer

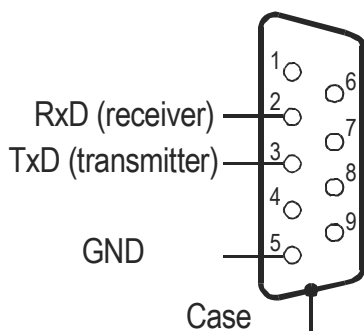

The scale is equipped with RS232C or RS485 (optional), which can be used to connect external devices such as a computer or a printer. Detailed way of communication data is defined by one of protocol:

- *LonG* – protocol to printer and computer
- *ELtron* – protocol to label printer

When cooperating with a printer data is send automatically after result stabilisation, but next transmission is possible after removing previously weighted sample.

RS485 (option)

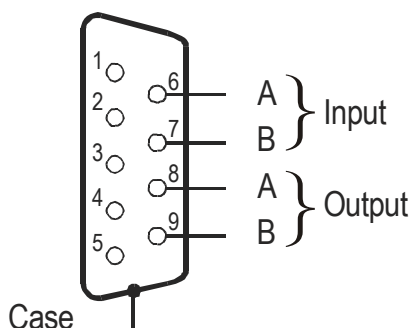

When protocol *Long* is chosen scale sends result of weighting under the influence of initializing signal from computer, or after pressing a key.

When automatic transmission mode is chosen (function *PrInt*), a printer data is send automatically after result stabilisation, but next transmission is possible after removing previously weighted sample. The scale sends following information: successive number of weighing, date and time (if clock module is installed) and weighing result.

During transmission communicate *Print* is displayed. It is also possible by scale to display text message sent from computer confirming received information.

Scale with *Eltron* protocol sending record of data after pressed key.

The scale sends following information: number of label, date and time (if clock module is installed) and weighing result. During transmission communicate Label is displayed.

In special features scale can be equipped in second RS232 interface for additional functions, ex. continuous transmitting of indications to second display.

Computer must have a special program for cooperation with data from a scale. Programs offer is available on www.axis.pl/en internet site.

Detailed protocol description

LonG protocol

Communication parameters: 8 bits, 1 stop bit, no parity, baud rate 4800bps,

- Readout of scale indication (corresponds to pressing  key
 Computer→Scale: **S I** CR LF (53h 49h 0Dh 0Ah),
 Scale→Computer: scale response according to description below (16 bytes):
 - Byte 1 - sign „-” or space
 - Byte 2 - space
 - Byte 3÷4 - digit or space
 - Byte 5÷9 - digit, decimal point or space
 - Byte 10 - digit
 - Byte 11 - space
 - Byte 12 - k, l, c, p or space
 - Byte 13 - g, b, t, c or %
 - Byte 14 - space
 - Byte 15 - CR
 - Byte 16 - LF

Attention:

Network number different than zero (F..rS / nr function) changes scale working mode: communication with a computer is possible after logging the scale in with 02h scale number command. To log the scale out use 03h command.

For example: Using a program to test RS232 interface (program is available on www.axis.pl in computer programs section) for scale number 1 please write: \$0201 to log in, then SI, and write: \$03 to close communication.

- Asking for scale presence in system (testing scale connection with computer):
Computer→Scale: **S J** CR LF (53h 4Ah 0Dh 0Ah),
Scale→Computer: **M J** CR LF (4Dh 4Ah 0Dh 0Ah),
- Displaying a sign on scale display (text message from computer):
Computer→Scale: **S N n n X X X X X X** CR LF (53h 4Eh 0Dh 0Ah),
nn-displaying time in seconds; **XXXXXX**- signs to display
Scale→Computer: **M N** CR LF (4Dh 4Eh 0Dh 0Ah),
- Scale tarring (calling $\rightarrow T \leftarrow$ key press) :
Computer→Scale: **S T** CR LF (53h 54h 0Dh 0Ah),
Scale→Computer: without response,
- Scale zeroing (calling $\rightarrow 0 \leftarrow$ key press):
Computer→ Scale: **S Z** CR LF (53h 5Ah 0Dh 0Ah),
Scale →Computer: without response,
- Scale turning on / off (calling \updownarrow key press):
Computer→ Scale: **S S** CR LF (53h 53h 0Dh 0Ah),
Scale →Computer: without response,
- Entering to special function menu (calling *MENU* key press):
Computer→ Scale: **S F** CR LF (53h 46h 0Dh 0Ah),
Scale →Computer: without response,
- Setting low threshold value (option):
Computer→ Scale: **S L DI...DN** CR LF (53h 4Ch DI...DN 0Dh 0Ah)
DI...DN – threshold value, maximum 8 characters (,,-" – negative value, digits, dot – decimal separator), number of digits after dot should be the same as on scale display,
Scale →Computer: without response,
- Example:
 - in order to set low threshold 1000g in scale B1.5 (d=0.5g) the following order should be sent:
S L 1 0 0 0 . 0 CR LF (53h 4Ch 31h 30h 30h 30h 2Eh 30h 0Dh 0Ah),
 - in order to set low threshold 100kg in scale B150 (d=50g) the following order should be sent:
S L 1 0 0 . 0 0 CR LF (53h 4Ch 31h 30h 30h 2Eh 30h 30h 0Dh 0Ah),),
- Setting high threshold value (option):
Computer→ Scale: **S H DI...DN** CR LF (53h 48h DI...DN 0Dh 0Ah),
DI...DN – threshold value (see)
Scale →Computer: without response.

Connecting cable WK-1 (scale – computer / 9-pin interface):

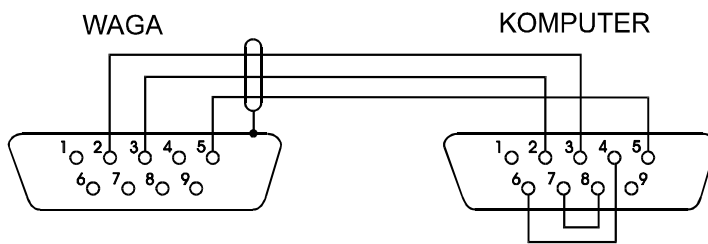

Protocol ELTRON description

Communication parameters: 8bits, 1stop, no parity, 9600bps,

- After use  key scale send:

Scale→Label printer : EPL-2 language instruction to initialize print of label:

US	- control instruction
FR"0001"	- number of labels
?	- starting instruction
hh:mm	- 5 signs: hours:minutes
yyyy.mm.dd	- 10 signs: year.month.day
mass + unit	- 10 signs: scale indicate + mass unit
P1	- ending instruction

Attention:

1. It is possible to place a constant signs (company name, product name).
2. The default number of label's is 0001 (label number 1).Different numbers of label are possible by using a *Label* function.
3. Label formula must be saved in printer – label forma must be designed in computer (by Zebra Designer program) and saved in printer.
4. Parameters and protocol of transmission must be compatible with printer label

13. Basic function

To make clear how to manage with each function, in further part of instruction descriptions are replaced with pictures.



- put a load on the pan



- remove the load from the pan

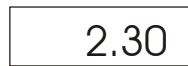

- press the key when indication is displayed



- forced change



- automatic change

13.1 Normal weighing

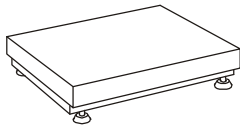

Press $\rightarrow 0 \leftarrow$ key ($\rightarrow T \leftarrow$ key in non-legalized scales), which zeros the scale, operates only when the pan is empty .

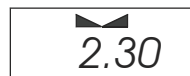
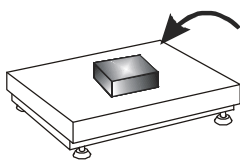

Weighing result should be read when the indicator " \blacktriangledown " lights.

13.2 Weighing with tare

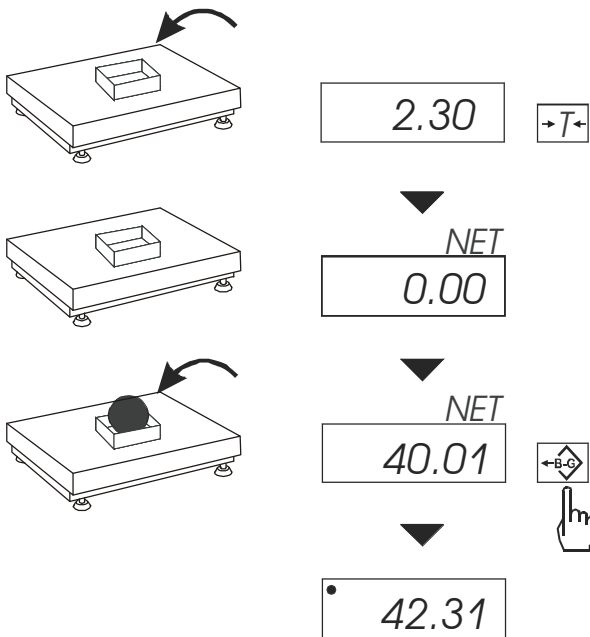

The scale is equipped with tare equal to its range.

Joint value tare and mass net can not cross a maximum of scale.

To display gross weight press *B/G* key.

Note:

Press *B/G* key to return to net weight indication.

13.3 Increased readability

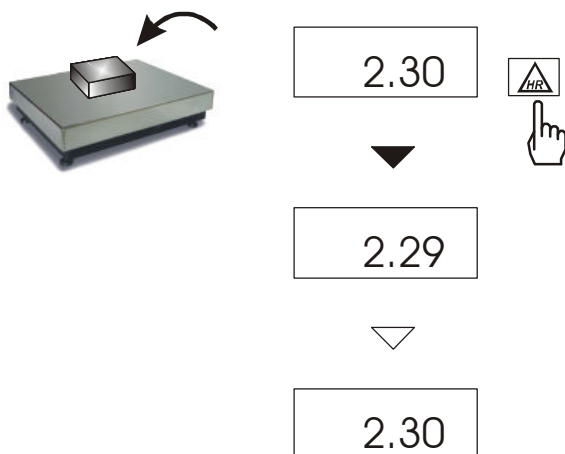

Press *HR* key to display the weighing result (for 5s.) with the highest readability possible. This function is especially helpful in scales with legal verification with $d=e$.

The weighing result with increased readability can be used for informational purposes only and cannot be printed or sent to a computer with  key.

14. Special functions description

List of available functions:

- menu customization function (*ACtIV*),
- removal of all function from menu (*dEFAUL*).
- autozeroing function (*AutoZE*),
- pieces counting function (*PCS*),
- function for setting serial port working (*PrInt*)
- function for setting serial port (*Port*)
- entering tare function (*tArE*)
- recipe weighing function (*rECIPE*),
- weighing large animals function (*LOC*)
- force measuring function (*nEWto*)
- maximum value indication function (*UP*)
- anti-disturbance filter function (*FILtEr*)
- average calculating function (*AVErA*)
- percentage weighing function (*PErC*),
- extended calibration function (*CALib*)
- setting time of stabilisation function (*Stb*)
- selecting label number function (*LabEL*)
- automatic switching off scale function (*AutoOF*)
- entering reference zero (*Zero*)
- determining solids and liquids density function (*dEnSIt*)
- calculator for good packaging control (*tP*) - option*
- statistical calculations (*StAt*)- option*
- paperweight calculation function (*PAP*) - option*

function with additional equipment require:

- options with the clock:
 - setting current date and time function (*dAtE*)
 - total weight function (*totAL*)
- options with the transoptors connectors:
 - checkweighing function (*thr*)

* Functions offered with special version of scale software (with limited possibility of using other special functions).

User create own menu by choosing function in *ACtIV* function (described in chapter 14.1).

14.1 Menu customization function (*ACTIV* and *DEFAULT*)

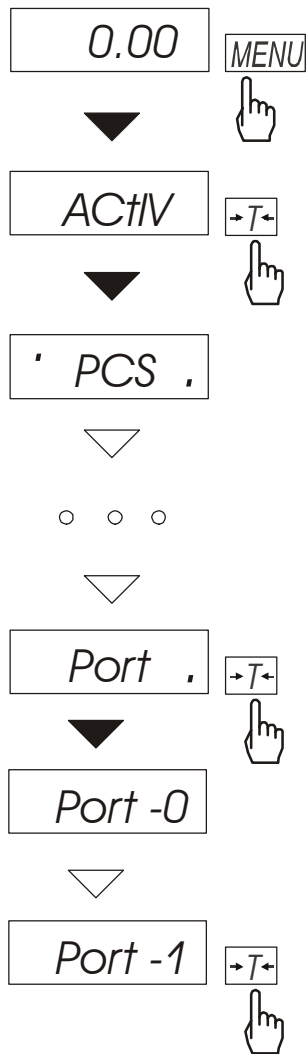

Among available user functions it is possible to select these, which should be displayed after pressing *MENU* key. It allows avoiding displaying whole list of available functions, which makes operation time longer.

Operation sequence shown in the pictures on the left causes adding function for setting serial interface RS232C parameters (*Port*) to function menu.

After switching on *ACTIV* function a dot is displayed on the right side (to distinguish from regular menu). Chosen functions are displayed with a dot on the left side.

In every moment, it is possible to restore primary (manufacture) settings choosing *DEFAULT* special function.

In order to remove function from menu in the last operation in place of selecting *Port -1* choose *Port -0*.

14.2 Autozeroing function (AutoZE)

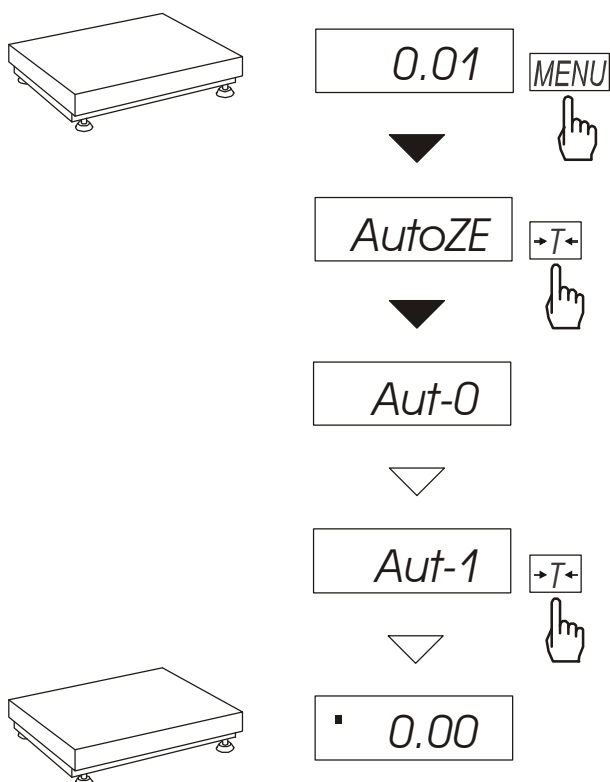

When *F.-Aut* function is activated, the scale automatically ensures stable zero indication if the pan is empty or if zero indication was acquired by pressing $\rightarrow T \leftarrow$ key.

To leave the function press *MENU* key, then with $\rightarrow T \leftarrow$ key chose *AutoZE* and *Aut-0*.

Note:

Autozeroing function is activated automatically for 10 min. after switching-on.

14.3 Pieces counting (PCS)

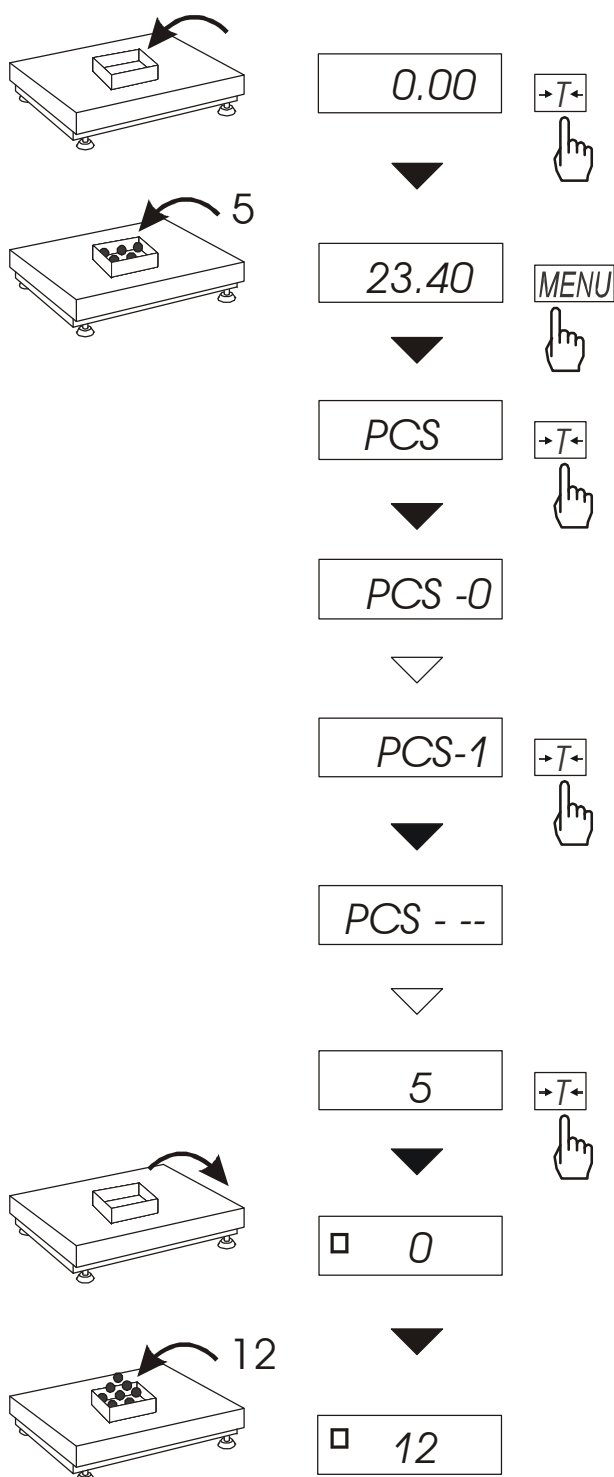

This function enables to count identical pieces, e.g. turnbuckles or buttons.

A measurement is performed in two phases:

- first phase - single piece weight calculation on the basis of defined pieces amount (5, 10, 20, 50, 100, 200 or 500 pieces),
- second phase – pieces counting.

It is advised that single piece weight is not less than one reading unit and sample weight used in first phase is bigger than 100 reading units.

To leave function press `MENU` key and then with `→T←` key chose `PCS` and `PCS-0`.

Note:

1. *Err-3 communicate signalises that a sample was not put on the pan. The same communicate appears if single piece weight is less than one reading unit (it is possible to count pieces but measuring error is bigger).*
2. *To chose previously used pieces amount select " _ _ " in first phase (in case no value was chosen, error communicate appears*
3. *During pieces counting →T← key function does not change.*
4. *In scales equipped with LCD display, weighing unit is visible and "□" sign is replaced with "pcs".*

14.4 Printer cooperation settings (Print)

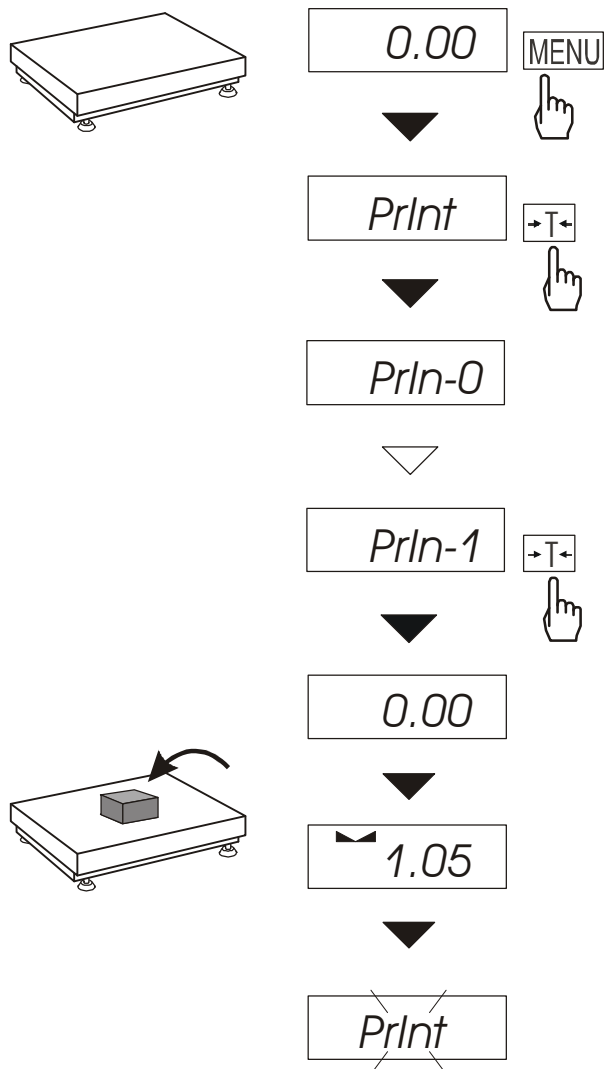

Activate the function for automatic serial port working mode (cooperation with a printer). After activation the scale prints a header. Weighing result with a successive measurement number is printed automatically after result stabilisation (without using **↵** key).

To select computer cooperation mode (**↵** key activated and weighing results without successive numbers) press **MENU** key, then with **→T←** key chose **PrIn-0** and **PrIn-1**.

14.5 Serial port parameters setting (Port)

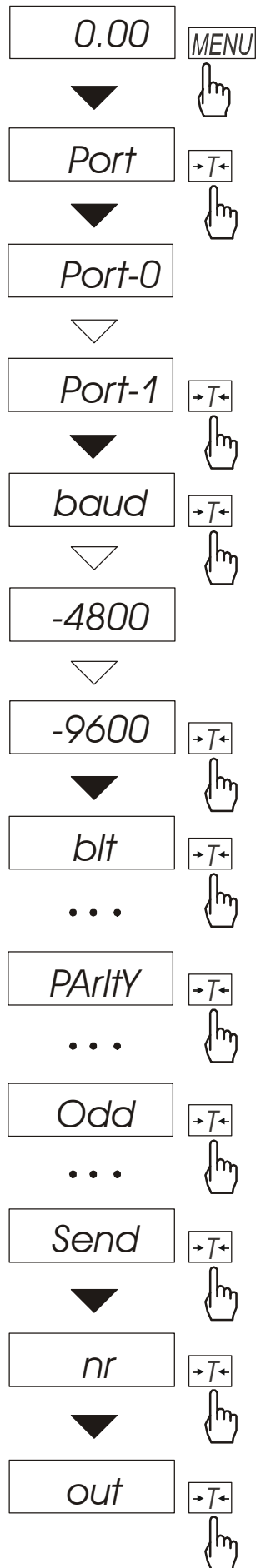

The function enables to set the following transmission parameters (standard parameters underlined:

- transmission protocol (*Prot*):
LonG - printer,
ELtron – label printer,
- transmission speed (*bAud*: 1200, 4800, 9600, ...),
- the number of bits in a byte (*bit*: 7, 8),
- parity control (*PArtY*: 0, 1; *Odd*: 0, 1),
- network number when working in multistand computer system (when working as a single scale the value should be “0”),
- continuous transmission – without using  key, approx. 10 results per second (*SEnd*: 0, 1).

Protocol *Eltron* automatically activated function *LABEL*.

To set desired transmission parameters activate *Port* function, choose appropriate parameter and press $\rightarrow T \leftarrow$ key to accept needed parameter value. The example at the left presents how to set transmission speed value to 9600bps.

To leave the function choose *out* option.

14.6 Constant tare (tArE)

This function enables to measure gross weight of a sample placed in a container of a known weigh value (stored in the memory) and to display calculated net weight of the sample. Tare value is recalled from the memory with $\rightarrow 0 \leftarrow$ key when the pan is empty. Tare value may be entered using the keypad or by sampling container weight from the pan.

Operation sequence:

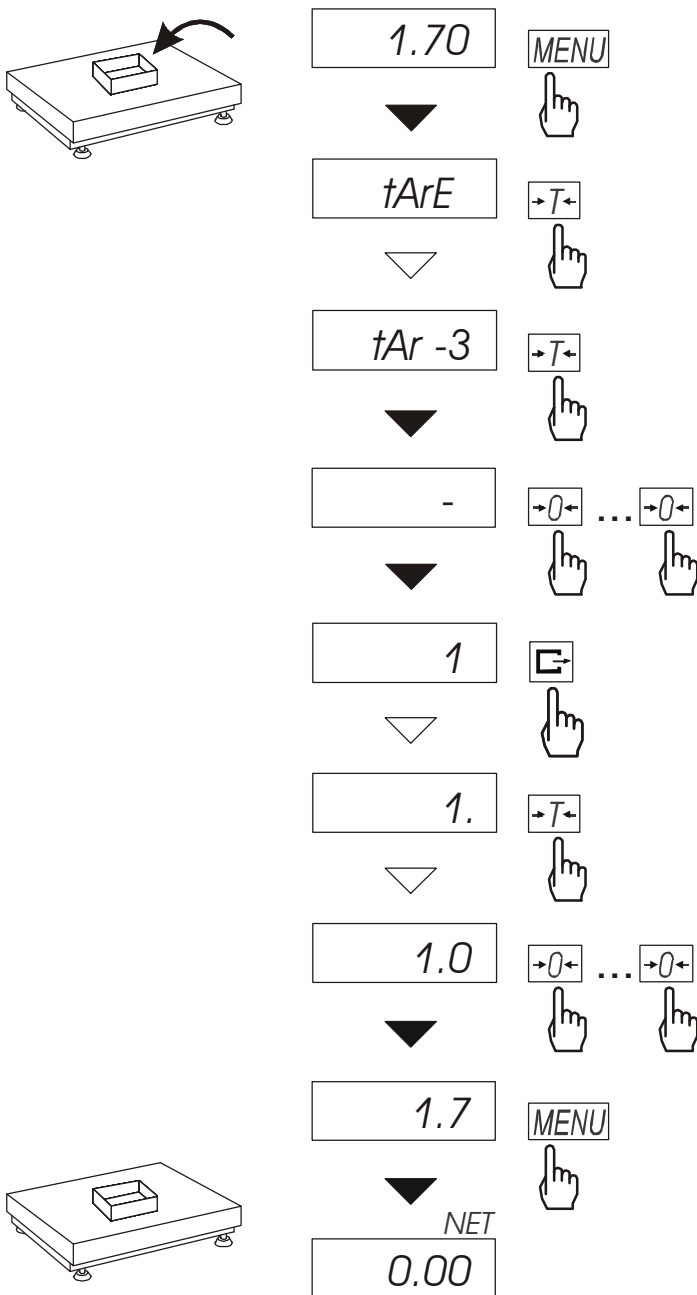

The following options are possible:

- tAr-0 – leave the function,
- tAr-1 – activate the function with the previous tare value,
- tAr-2 – sample tare value from the pan,
- tAr-3 – enter tare value with keys: $\rightarrow 0 \leftarrow$, \square , $\rightarrow T \leftarrow$ and MENU
- tAr-4 – printout a setting value of tare

If the function is active, NET indicator is displayed.

Options tAr-1 enables to activate the function with previous tare value after leaving the function with tAr-0 option.

Note:

Tare value is stored in memory also after unplugging the scale from the mains.

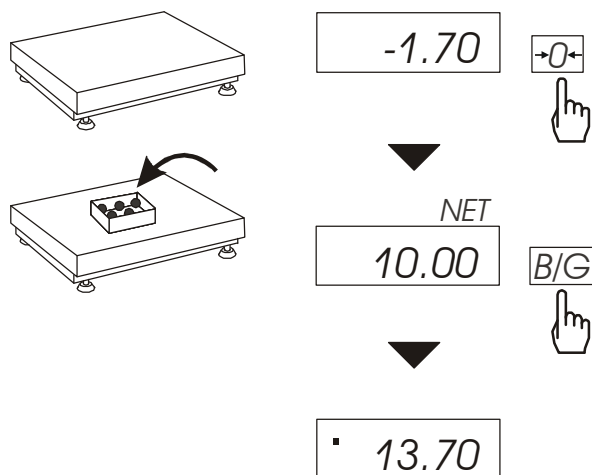
Weighing with constant tare:

When *tAr* function is activated, press $\rightarrow 0 \leftarrow$ key to zero the indication and to recall tare value from the memory. Tare value is displayed with "–" sign.

B/G key enables for instant switching between net and gross weight.

Note:

When the pan is empty $\rightarrow T \leftarrow$ key does not operate – to tare the scale use $\rightarrow 0 \leftarrow$ key.

14.7 Average calculation function (AVERAG)

The function allows for calculating average value of performed measurement series. During series of measurements successive results are registered automatically when scale indication is stabilised.

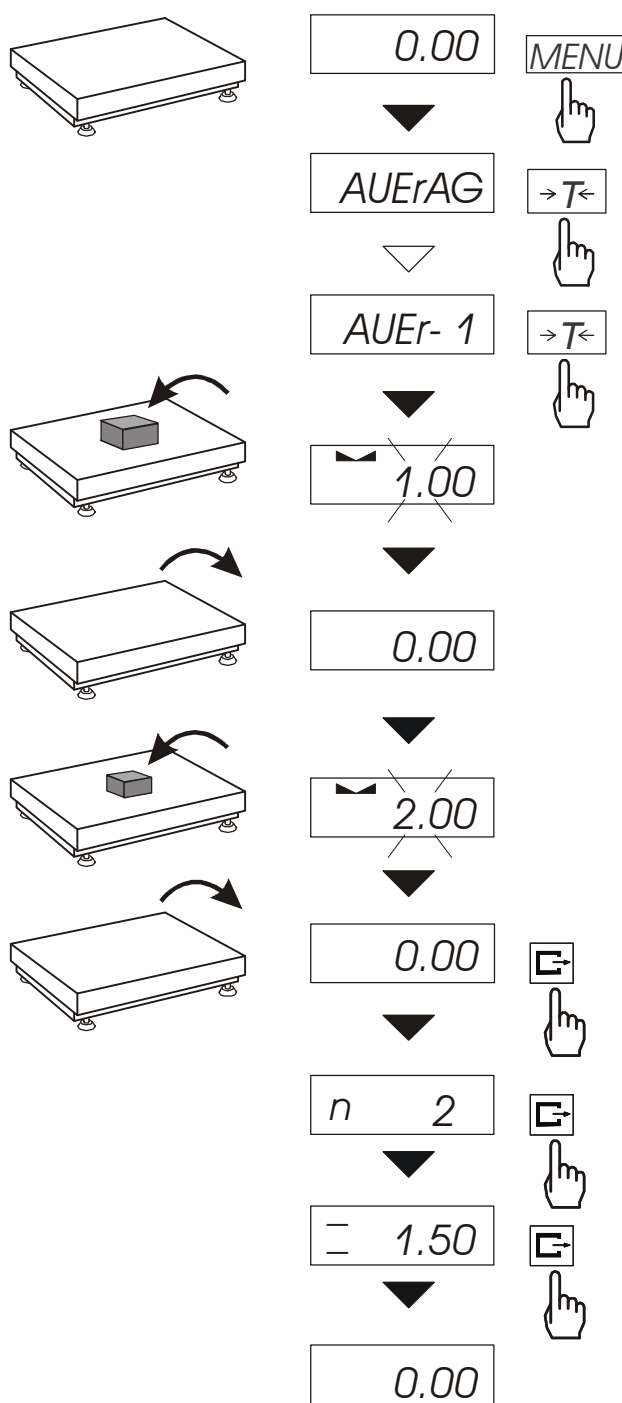

Press *MENU* key and select *AUeRAG* pressing $\rightarrow T \leftarrow$ key.

The following will be shown successively on display:

- *AUeR-0* – leaving function,
- *AUeR-1* – measurement with average calculation..

Select *AUeR-1*. It will allow weighing with simultaneous storing results into summing register for average calculation

Measurement registration is performed automatically in the moment when scale indication becomes stable. Short time displaying of „- - ” denotes that load can be taken off and new one can be put on. Results above scale Min are registered only. Number of measurements is limited to 9999.

In order to read average value **G** key should be used.

- first pressing causes displaying number of measurements (n).
- second displaying causes displaying average value (=).
- third pressing allows continuing average calculation.

If a printer is connected to scale the following report will be printed :

Date: ...	Time. ...
MEASUREMENTS No	= ...
AVERAGE VALUE	= ...

In order to finish calculation press *MENU* key, and then select *AUeR i AUeR-0*.

14.8 Recipe weighing function (RECIPE)

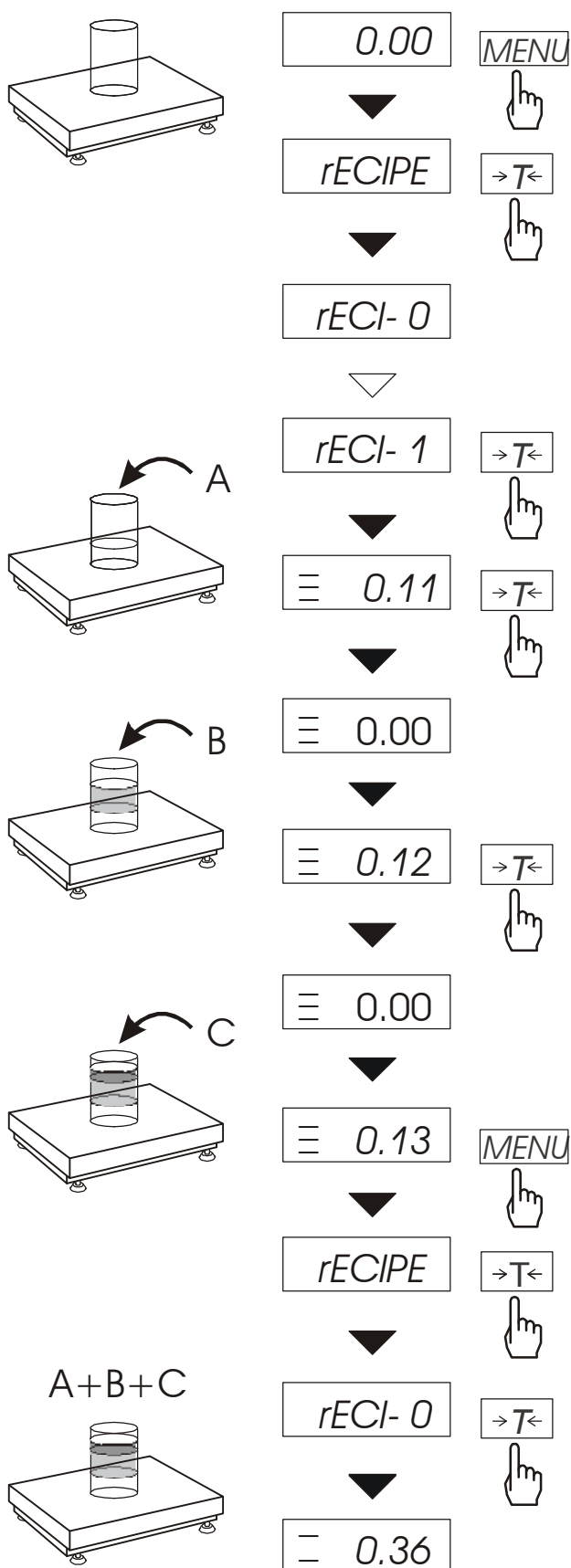

This function allows for separate weighing of several ingredients in one container with a possibility of control total weight of all weighed components.

The function has the following options:

- rECI-0 – leave the function with possibility of reading to read total weight,
- rECI -1 – start recipe weighing
- rECI -2 – continue previous recipe.

When preparing a recipe successive ingredients (A, B, C, etc.) are weighed each time starting from zero indication. In order to allow this after weighing of each ingredient tare the scale.

After weighing of several ingredients reading total weight is possible (despite scale taring). In order to do that press MENU key, select rECIPE function once more and use rECI -0 option.

Sign „ $\bar{-}$ ” signals total weight indication. Recipe is finished when $\rightarrow T \leftarrow$ key is pressed.

When „ $\bar{-}$ ” sign is displayed recipe continuing is possible. rECI -2 option is used for that.

Note:

Sign „ \equiv ” on the left side of display informs about rECIPE function activity.

14.9 Percentage weighing function (PErC)

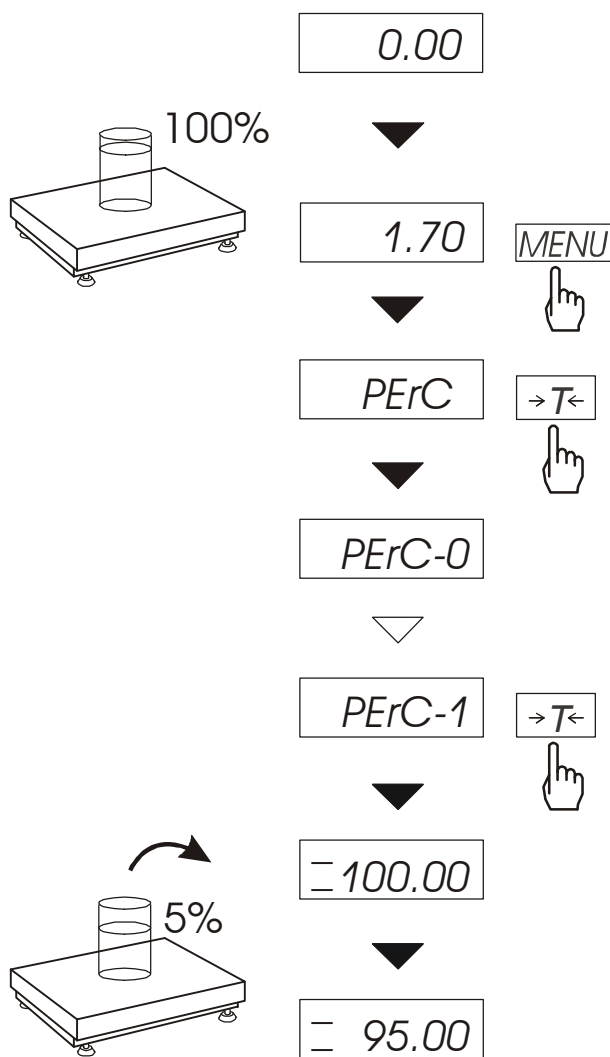

This function allows displaying weighing result in percents.

A measurement is performed in two phases:

- first phase – weighing a reference sample (100%),
- second phase – measuring specific sample as a percentage of the reference sample.

Weighing result is displayed in different format, depending on the weight value of reference sample. For weight values of reference sample 0÷3,5% of weighing range result is displayed in format 100, for range 3,5÷35% - in format 100.0, and above 35% - in format 100.00.

„%” sign is replaced with „—” indicator.

The function has the following options:

- PErC-0 – disable the function,
- PErC-1 – set current scale indication as 100% and activate percentage weighing,
- PErC-2 – continue percentage weighing after exiting to normal weighing.

Note:

During percentage weighing →T← key has its normal function.

14.10 Anti-disturbance filter function (*FILtEr*)

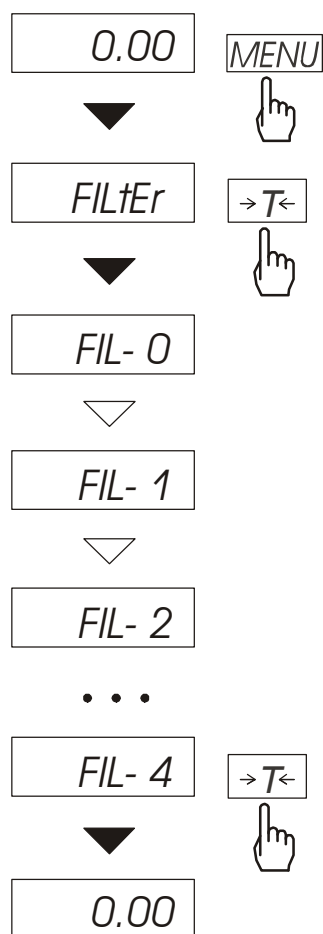

This function allows using digital filter with selected intensity during weighing. Filter reduces the influence of mechanical vibrations (air blasts, base vibrations) on measurement result.

Press *MENU* key and select *FILtEr* pressing `→T←` key.

The following options will be shown successively on display:

- *FIL-0* – work without
- *FIL-1* - filter I (weak)
- *FIL-2* - filter II (medium)
- *FIL-3* - filter III (sharp)
- *FIL-4* - filter IV (very sharp)

Select one of four filters. This will cause starting weighing with selected filter.

In order to go back to normal weighing use *MENU* key once more and choose *FILtEr* and *FIL-0*.

14.11 Function for maximum value indication (UP)

This function allows holding on display maximum value shown by the scale in a while.

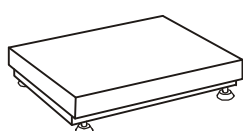

0.00 MENU



Before measurement scale should be tared.

UP →T←



After using MENU key and selecting UP function the highest mass result will be hold on display.

Pressing →T← key will cause result zeroing.

UP- 0



UP- 1 →T←



Note:
Autozeroing function and the stabilisation indicator are deactivated when UP function is running. Weighing result is continuously averaged from 5 measurements.

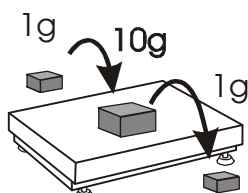

1.00



10.00



10.00

14.12 Force measuring function (nEWto)

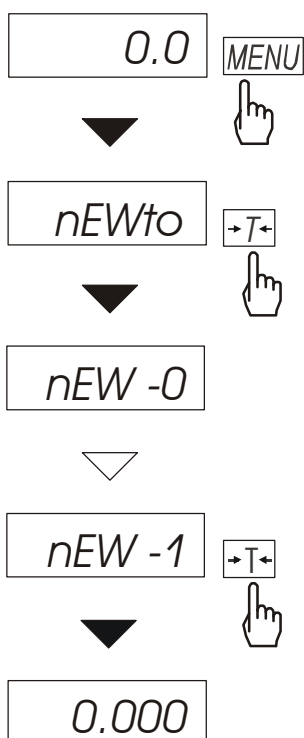

Function activation causes displaying result in force units (N).

Press *MENU* key.

Using `→T←` key choose *NEWto* function, and then *NEW-1*.

Note: 1N≈0,1019kg

14.13 Function for weighing large animals (LOC)

The function allows weighing animal moving on the scale.

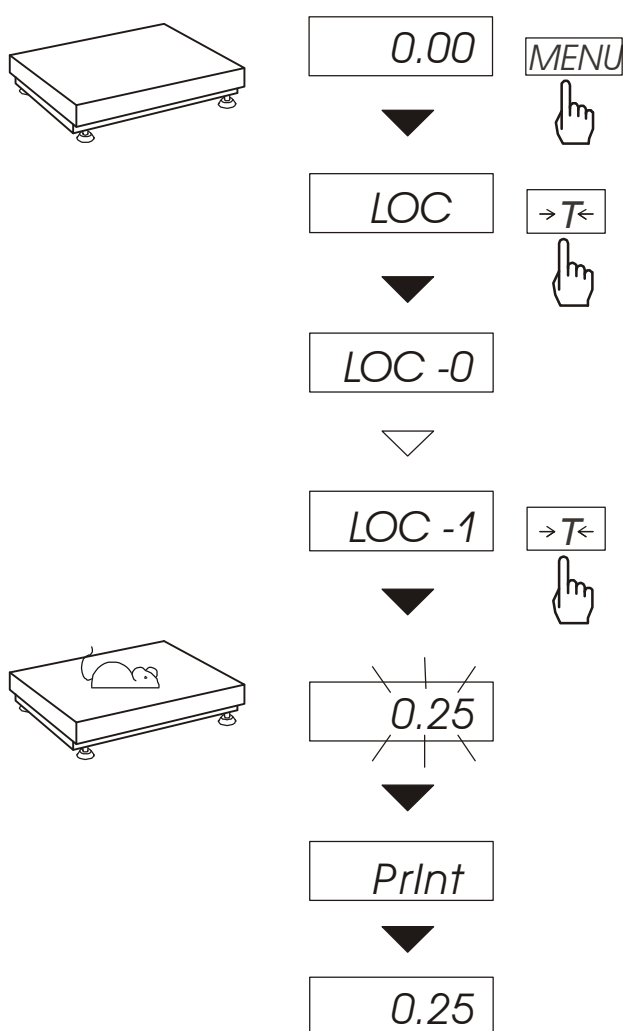

Press *MENU* key.

When *LOC* function is displayed press $\rightarrow T \leftarrow$ key.

The following options appear on display successively:

- *LOC-0* – leave the function,
- *LOC-1* – automatic weighing after loading the scale,
- *LOC-2* – the measurement initiated manually by pressing $\rightarrow T \leftarrow$ key.

When *LOC-1F..-1* is displayed press $\rightarrow T \leftarrow$ key.

Tare the scale using $\rightarrow T \leftarrow$ key if necessary and place the animal on the pan.

Wait until the weighing result is averaged – scale display will be blinking. Then scale will show stable averaged result and will send it through serial port. Final result is displayed on the display and send via serial port to computer or printer.

The result remains on display for about 30 second.

Important notes:

1. The loads less than *Min* are not averaged.
2. In the case when placing the animal takes more than 5s, it is advised to use *LOC-2* option (measurement initiated manually). It will allow performing measurement in right moment pressing $\rightarrow T \leftarrow$ key.

14.14 Checkweighing function (*thr*)

This function allows comparing weighing result with two programmed reference values: lower and upper threshold. Comparison result is signalled with indicators (MIN, OK, MAX) and sound signal generated when threshold values are exceeded. If comparison result is:

- smaller than lower threshold – the scale signals MIN (yellow colour),
- between threshold values - the scale signals OK (green colour, with the short sound signal),
- greater than upper threshold - the scale signals MAX (red colour, long sound signal).

The checkweighing results can be use to control:

- optical indicator (*Indication mode*),
- batching devices (*Batching mode*).
-

Standard scale is set for cooperation with optical indicator.

On outputs P1-P3 (*Relays socket*) short-circuit states appear as result of comparison scale indication with threshold values.

On the chart below output states are shown during increasing load on the scale for both working modes:

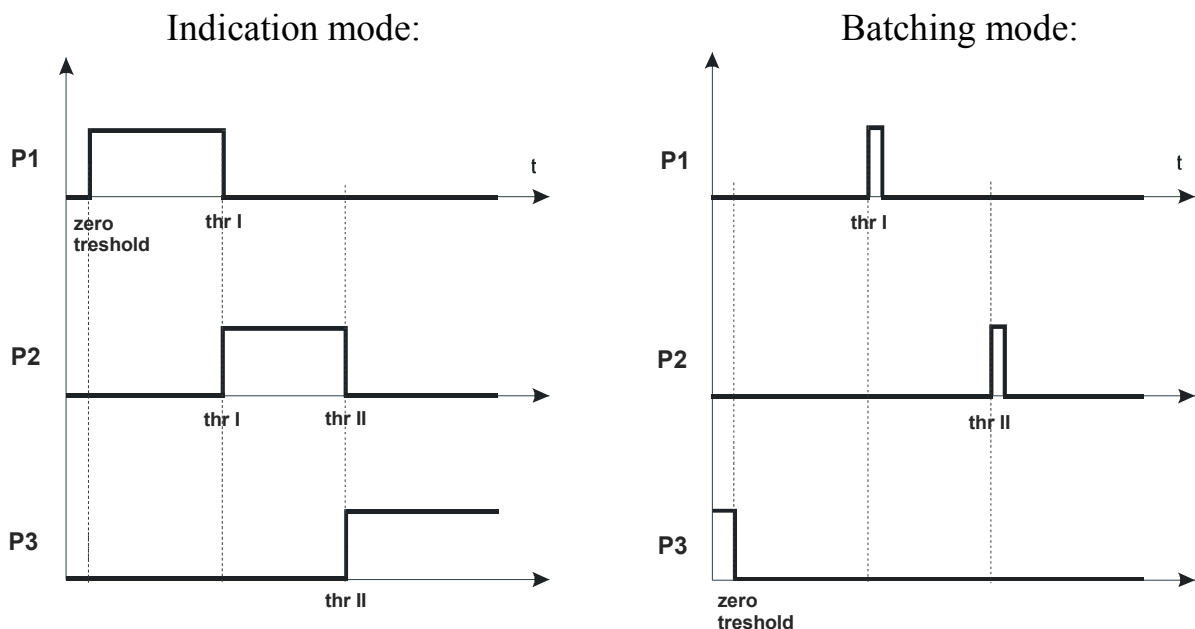

In *Batching* mode on P1 (thr I) and P2 (thr II) outputs short-circuit impulses appears for time of 0,5s. On P3 (zero) output short-circuit state appears when indication does not exceed threshold value signalling zero load.

Relays connection diagram:

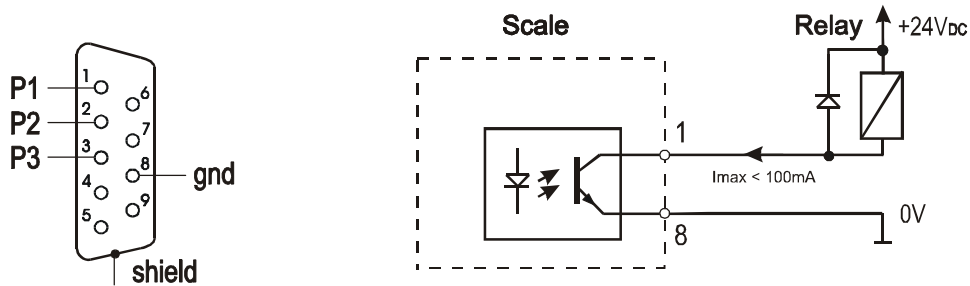

Relays output is the open collector transistor output with load capacity 100mA / 24V. Transmitter inputs must be protected with diodes, e.g. 1N4148.

It is advised to use MS3K/P electronic board (sold separately), consisting of RM96P transmitters, with DC24V input voltage and AC250V, 3A output.

Important notes:

1. After switching the scale on, both thresholds are set to maximum values.
2. When setting upper threshold value, pay attention that its value is not below lower threshold value.
3. Setting lower and upper threshold value is possible after sending appropriate orders from computer, what is described in scale user manual.

Operation sequence:

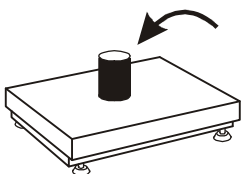
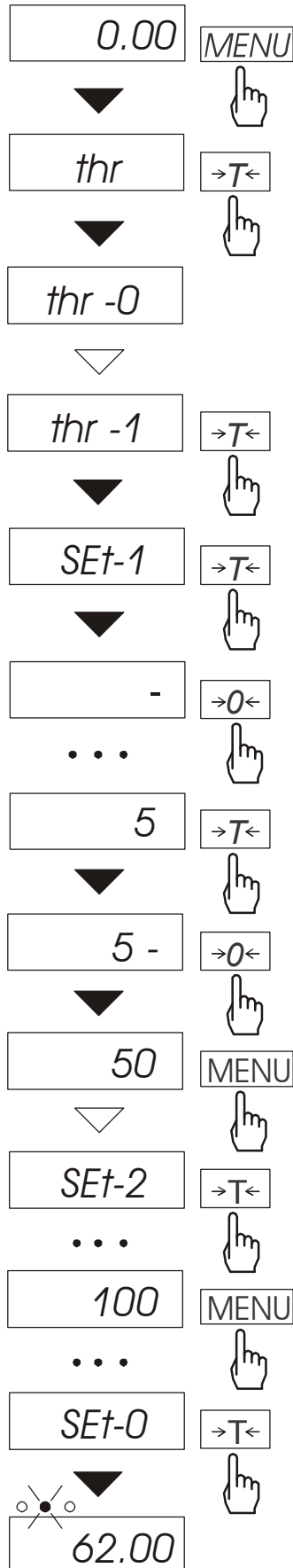
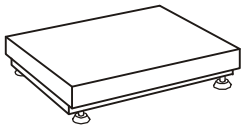

Press *MENU* key and choose *thr* pressing $\rightarrow T \leftarrow$ key.

The following options are displayed successively:

- *thr-0* – deactivate the function,
- *thr-1* – activate the function,
- *thr-P* – check last threshold values (press \square key several times),
- *thr-t* – choose *Relays* socket mode:
 - 0 – exit to weighing
 - 1 – *Batching* mode
 - 2 – *Indication* mode.

Choose *thr-1* option using $\rightarrow T \leftarrow$ key. The following options for entering thresholds are displayed:

- *SEt-0* - go to weighing with signalling threshold excess,
- *SEt-1* - set lower threshold value,
- *SEt-2* - set upper threshold value,
- *SEt-3* - set zero signalisation threshold.

Using $\rightarrow T \leftarrow$ key select *SEt-1* option. Set lower threshold value using the following keys:

- $\rightarrow 0 \leftarrow$ - digit increase,
- \square - decimal point,
- $\rightarrow T \leftarrow$ - move to next digit,
- MENU* - finish.

Then select *SEt-2* option and enter upper threshold value.

Choosing *Set-0* option will cause starting work with signalisation of exceeding thresholds and zero.

To change *Relays* socket mode use *thr-t* option. Default option is *Indication*.

To leave the function, press *MENU* key and then choose *thr* and *thr-0* options.

14.15 Total weight function (totAL)

The function allows calculating total weight for series of measurements, which can be greater than scale capacity. It allows calculating total weight as well as average value.

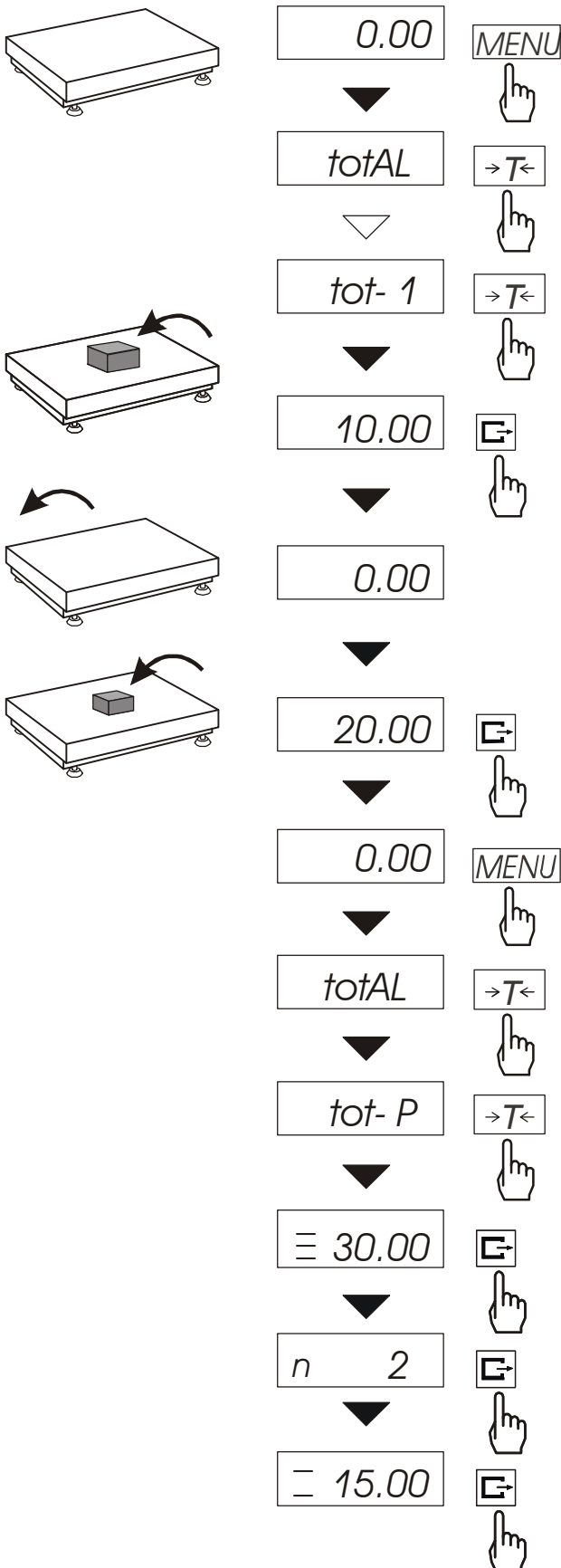

Press *MENU* key.

When *totAL* is displayed press **→T←** key.

The following options appear successively:

- *tot-P* - report printout without clearing total register,
- *tot-0* - clearing total register, report printout and leaving the function,
- *tot-1* - working with receipt printout after each measurement,
- *tot-2* - working without receipt printout.

Press **→T←** key when *tot-1* is displayed.

Perform measurement series pressing **☞** key for storing results into total register.

In order to print and display results enter to function choosing *total* and *tot-P* option from menu

The results are display in the following sequence:

- total weight (≡)
 - number of registered measurements (n),
 - average value (≡),
- regarding that moving to display successive result is performed after pressing **☞** key.

In order to go back to total weighing without zeroing total register press **☞** key third time.

To leave the function with clearing total register, select *total* function from menu and choose *tot-0* option. When It will cause the scale prints the communicate informing about clearing registers.

The form of receipt after each measurement:

Date: ...	Time. ...
measurement no	weight
measurement no	weight

Report form:

Date: ...	Time. ...
TOTAL WEIGHT	=
NUMBER OF SAMPLES	=
AVERAGE VALUE	=

Note:

When the scale has not an internal clock, Date and Time do not appear on printout.

Maximum number of measurements 99 999.

Maximum total load 99 999 000d.

The weighing unit of the total value from the register (Total) is the same as the weighing unit stated on the keypad or is 1000 times greater, what is signalled by “o” indicator at the left of the display.

If the registered value is too big to be displayed, “E” communicate appears on the display.

If the number of series is too high and cannot be displayed, “Err1” communicate appears on the display.

14.16 Function for setting date and time (dAtE)

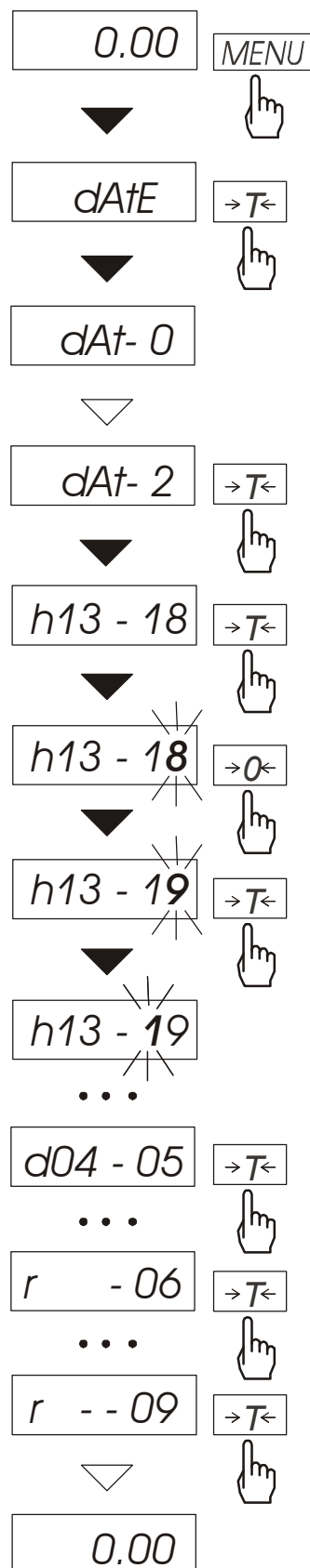

The function allows setting current date and time of scale internal clock and mode of its use.

The function has the following options:

- *dAt-0* – deactivate date and time during printout of current weighing result,
- *dAt-1* – activate date and time during printout of current indication (☐ key),
- *dAt-2* - change current date and time.

The example at the left presents how to set current date and time using *dAt-2* option.

On successive positions digits are changing automatically or manually using →0← key several times.

In order to choose appropriate digit and move to the next position use →T← key.

After setting proper date and time it should be activated with *dAt-1* option.

Time format: *h gg – mm*
(*gg* - hour, *m* - minute).

Date format: *d mm – dd*
(*m* - month, *d* - day).

Year format: *r - rr*
(*r* - two last year digits).

14.17 Function for selecting label number (LAbEL)

The function appears in scales with *ELTRON* data transmission protocol. This protocol allows printing scale indication and optionally date and time on label printer, as variable texts. Other data, e.g. company address, product name, its bar code can appear on label as constant fields. Label forms used by user, named as a numeric value (max. 4 digits) should be previously stored in printer memory according to printer user manual. Choosing label form is performed by entering label number using *LAbEL* function.

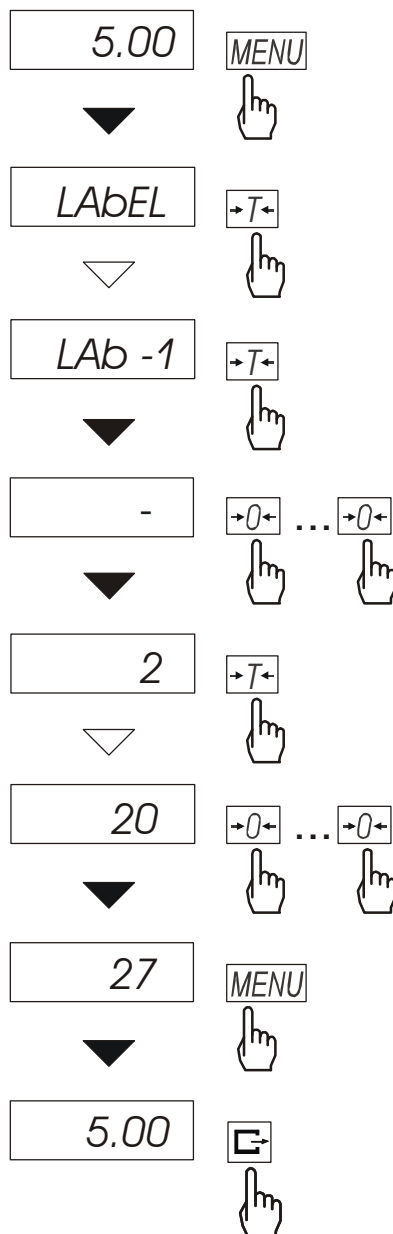
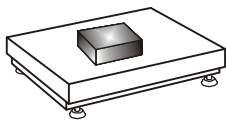

Press *MENU* key.

When *LAbEL* is displayed press $\rightarrow T \leftarrow$ key.

The following options appear successively on display:

- *LAB-0* – leave without changes,
- *LAB-1* – enter label number,

Using $\rightarrow T \leftarrow$ key select *LAB- 1*.

For entering label number the following keys should be used:

- $\rightarrow 0 \leftarrow$ - increase digit,
- $\rightarrow T \leftarrow$ - move to next digit,
- MENU* – finish entering.

After putting load on and pressing  key data is sent to a printer.

Format of data sent to label printer:

US	(55 53 0D 0A)
FR"0001"	(46 52 22 30 30 30 31 22 0D 0A)
?	(3F 0D 0A)
00:00	(30 30 3A 30 30 0D 0A)
2000.00.00	(32 30 30 30 2E 30 30 2E 30 30 0D 0A)
10 g	(20 20 20 20 20 31 30 20 20 67 0D 0A)
P1	(50 31 0D 0A)

14.18 External calibration (CALib)

Note: This function is enabled in non legalized scales only.

Calibration of sensitivity should be make when aaccuracy of scale is not satisfactory. Could use standard mass equal of maximum range of scale (*Max*).

Operation sequence:

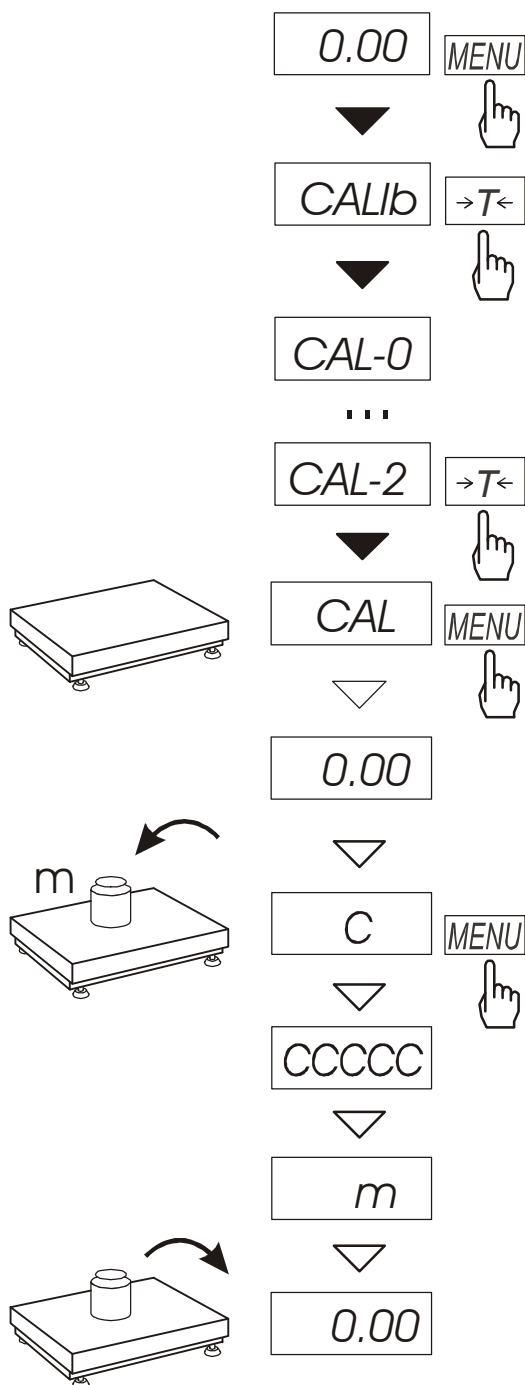

Press *MENU* key to call functions menu and to choose *CALibr* with $\rightarrow T \leftarrow$ key.

The following options appear successively on display:

- *CAL-0* – leave without calibration,
- *CAL-1* – quick calibration – without confirms by *MENU* key,
- *CAL-2* – calibration with confirms
- *out* – leave without changes

Press *MENU* when communicate *CAL-2* is display.

Confirm readiness to calibration by press *MENU* key – pan must be empty.

When communicate *C* is display put a standard mass (equal of maximum) to a pan and press *MENU* key.

Wait to end of calibration process.

14.19 Setting time of stabilization function (*Stb*)

The function allows changing stabilisation time of scale indication and connected with it the time of waiting for starting result printout on a printer connected to the scale.

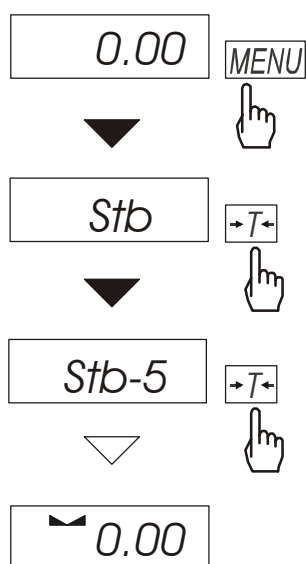

Press *MENU* key.

When *Stb* is displayed press $\rightarrow T \leftarrow$ key.

The following options appear successively on display:

- *Stb-0* – deactivate the function,
- *Stb-1* – the longest stabilisation time,
- *Stb-2* – long stabilisation time,
- *Stb-3* – medium stabilisation time,
- *Stb-4* – shorter stabilisation time,
- *Stb-5* – the shortest stabilisation time.

After choosing one of the options weighing with activated filter is started..

In order to go back to normal work of the scale choose *Stb-0* option.

14.20 Entering reference zero function (Zero)

Note: This function is enabled in non legalized scales only.

ZER function allows entering new value of reference zero (value referred to empty pan) without need of contacting with authorised service centre.

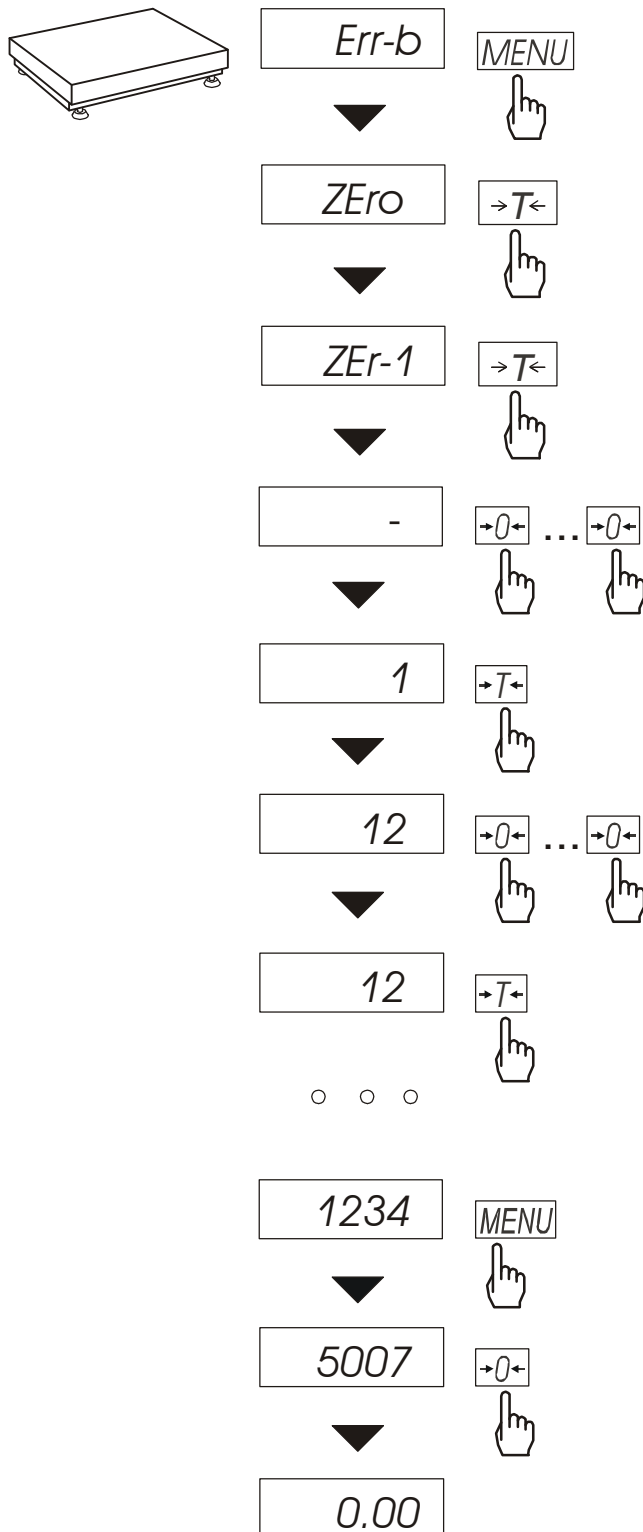

Press *MENU* key.

When *Zero* is displayed press $\rightarrow T \leftarrow$ key.

The following options appear successively on display:

ZEr-0 – activate function,

ZEr-1 – enter new zero value,

ZEr-2 – enter new protecting code.

Using $\rightarrow T \leftarrow$ key, choose *ZEr-1* and enter access code for function (in new scale it is 1234). Direct result from A/C converter will appear on scale display.

When the pan is empty press $\rightarrow 0 \leftarrow$ key.

Wait for finishing zeroing process.

In order to change access code use *ZEr-2* option. Entering value is performed similarly as with *ZEr-1* option.

14.21 Automatic switching off the scale function (*AutoOF*)

The function is helpful in scales supplied from accumulator. The function causes scale to switch off automatically after c.a. 10 minutes of not using it. Switching function on causes last entered zero and tare values are remembered in scale memory. After next start-up of the scale these values are restored.

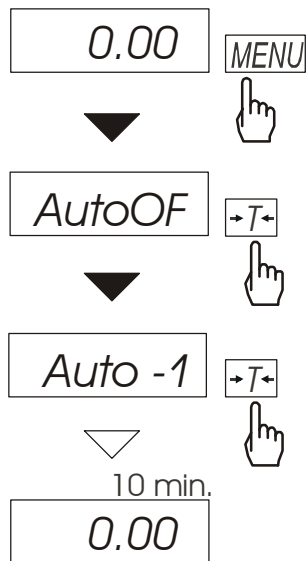

Press *MENU* key.

When *AutoOF* is displayed press **→T←** key.

The following options appear successively on display:

Auto-0 – activate function,

Auto-1 – deactivate function.

After function activation scale will control changes of its indications. If the scale will not be used and scale indications will not be changing, after time of c.a. 10 minutes the scale will switch off remembering its settings (zero and tare).

Switching on the scale is performed after pressing **I/⊕** key.

14.22 Density determining function (dEnSlT)

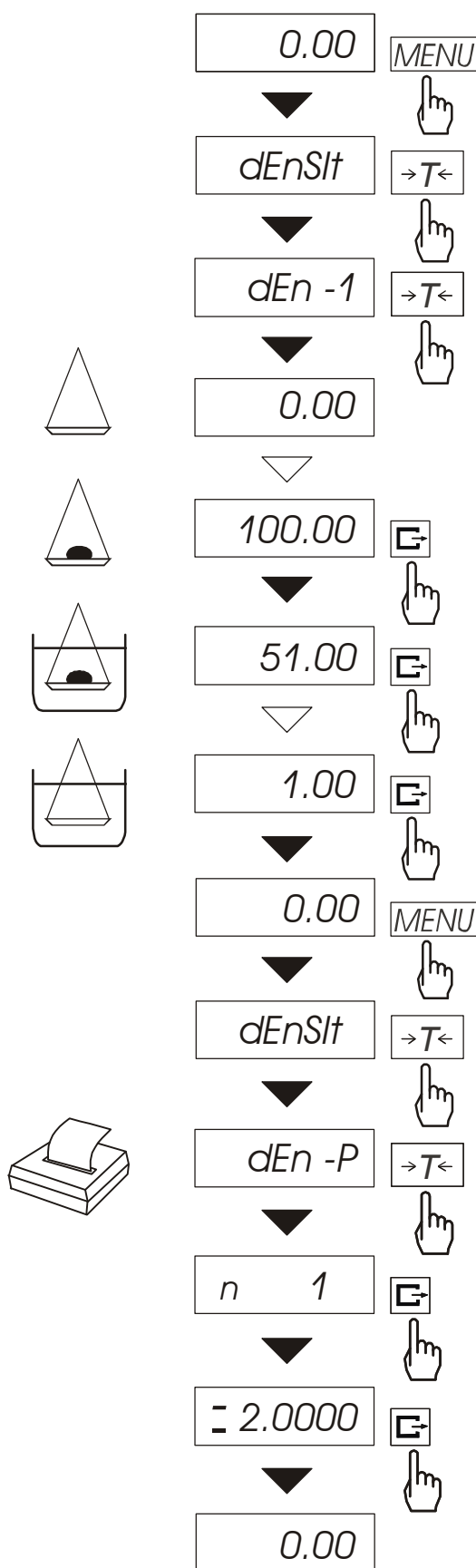

The function allows determining solid density basing on its weight in the air and in liquid of known density using the formula below:

$$g = \frac{m_1}{m_1 - m_2 + m_3} * g_{\text{liquid}}$$

where: m_1 -weight in the air
 m_2 - weight in liquid
 m_3 - hanger weight
 g_{liquid} – liquid density

By default:

$$g_{\text{liquid}} = 1\text{g/cm}^3$$

(for distilled water).

When using liquid other than distilled water, choose *dEnSlT* from menu and use *dEn-2* option to enter liquid density taking into consideration its temperature.

To enter value use the following keys:

- 0← - digit increase,
- ↵ - decimal point,
- T← - move to next digit,
- MENU* - finish.

The measurement is performed in three phases:

- measurement in the air,
- measurement in liquid,
- hanger weighing

To read density determination result, enter *dEnSlT* function menu and use *dEn-P* option. First pressing ↵ key causes displaying successive measurement number. Second pressing ↵ key causes displaying and printing result, and then going to the next density measurement.

If a printer is connected to the scale, printout of solid density measurement results will be performed in the following form:

Date: ...	Time: ...
MEASUREMENT No.	=
WEIGHT in air	= g
WEIGHT in liquid	= g
HANGER WEIGHT	= g
LOAD DENSITY	= g/cm^3
LIQUID DENSITY	= g/cm^3

It is recommended to use pan hanging below balance, weighing in the air and in liquid is performed then in the following way.

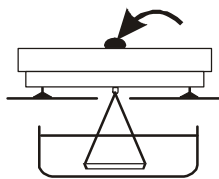

Phase I: measurement in the air.

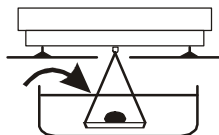

Phase II: measurement in liquid.

14.23 Calculator for good packaging control (tP)

Note: This function is enable for special orders substitutable with other functions.

The function allows performing not destroying control of 60, 100 or 160 samples of packed goods. Calculation formula complies with the description of reference method described in act of law from 26.07.2001 (with later changes).

Scale operator enters nominal net mass (Qn) and sample quantity taken for control (quantity refers to total quantity of samples 1 and 2 in description of reference method).

Accepting successive measured packages (storing in register) is performed automatically after load is put on and scale indication is stable.

Each time after load is put on printout is performed: measurement number, result, date and hour. Accepting next measurement is possible after taking last load off.

For obtained measurement series scale calculates:

- \bar{x} -average mass as (sum x)/n

- Min -minimal mass in n samples

- Max -maximal mass in n samples

- R = Max-Min -the difference between max and min

- S -standard deviation
$$S = \sqrt{\frac{1}{(n-1)} \sum_n (x_n - \bar{x})^2}$$

- defective samples count -count of samples with mass $Q_n - 2T1 < x < Q_n - T1$

-disqualifying samples count -count of samples with mass $< Q_n - 2T1$

Results of statistical calculations and histogram are printed on a printer.

Operation sequence:

1. Press *MENU* key.
2. When "F..tP" is displayed press $\rightarrow T \leftarrow$ key.
The following options appear successively on display:

- "F..-0"- leave function,
- "F..-1"- measurements,
- "F..-2"- enter product data: product code and batch size,
- "F..-3"- enter control parameters: nominal mass Qn and measurement number,
- "F..-4"- select mode for data transmission (automatic or manual).

[Entering product data]

3. Press $\rightarrow T \leftarrow$ key when "F..-2" is displayed.
The following options appear successively on display:
 - "Cod"- product code [6 digits],
 - "n" - batch size,
 - "out" - exit,
4. Press $\rightarrow T \leftarrow$ key when "Cod" is displayed.
Previously entered product code will be displayed one by one with "out" option.
In order to enter new product key press $\rightarrow T \leftarrow$ key when previous code is displayed, and after "-" appears use keys:
 - $\rightarrow 0 \leftarrow$ - change digit,
 - $\rightarrow T \leftarrow$ - move to next digit,
 - MENU* - finish.
 If previous code is valid, choose "out" pressing $\rightarrow T \leftarrow$ key.
5. Press $\rightarrow T \leftarrow$ key when "n" is displayed.
Previously entered batch size will be displayed one by one with "out" option.
In order to enter new batch size press $\rightarrow T \leftarrow$ key when previous value is displayed using keys:
 - $\rightarrow 0 \leftarrow$, *T* and *MENU* as above.
6. Press $\rightarrow T \leftarrow$ key when "out" is displayed.

[Entering control parameters]

7. Press $\rightarrow T \leftarrow$ key when "F..-3" is displayed.
The following options appear successively on display:
 - "O_n"- nominal mass (Qn),
 - "-20", "-60", "-100", "-160", "n" – select available measurement quantity (total quantity of samples),
 - "out" - exit,
8. Press $\rightarrow T \leftarrow$ key when "O_n" is displayed.
Previously entered nominal mass will be displayed one by one with "out" option.
In order to enter new nominal mass press $\rightarrow T \leftarrow$ key when previous value is displayed using keys: $\rightarrow 0 \leftarrow$, *T* and *MENU* as above.
9. Select measurement quantity pressing $\rightarrow T \leftarrow$ key. Selected quantity should comply with requirements of good packaging act of law (it depends on control kind and batch size). Letter n denotes full control.
10. Press $\rightarrow T \leftarrow$ key when "out" is displayed.

[Selecting mode for data transmission]

11. Press $\rightarrow T \leftarrow$ key when "F..-4" is displayed.
The following options appear successively on display:
 - „Auto” – automatic data transmission after scale indication is stable,
 - „Recz” – manual data transmission by operator using  key,
 - „out” – exit.
12. Choose appropriate option pressing $\rightarrow T \leftarrow$ key.
13. Press $\rightarrow T \leftarrow$ key when F..-0 is displayed to exit function.
14. Press *MENU* key.
15. When "F..-tP" is displayed press $\rightarrow T \leftarrow$ key. Select "F..-1".
16. Printout is performed.
17. Put successive good packages.

Successive results will be printed in table
with indication of their values using "*" character referred to limit values.

18. After performing last measurement "END" text will appear and summarising report of control results will be printed:

```

PLACE OF CONTROL: .....
Date:      ...   Time:  ...

CONTROL NO.: .....
SCALE TYPE      :      ...
FACTORY NO.     :      ...
BATCH SIZE      :      ...
VALUE Qn        :      ...
VALUE Qn-T1     :      ...
VALUE Qn-2T1    :      ...

                Qn-2T1  Qn   Qn+2T1
... g           *
... g                               *
.....
    
```

19. In order to finish working with the function and reset results register, press *MENU* key, and when "F..tP" and "F..0" is displayed press →T← key.

Note: Activating TP function causes that indicators signal exceeding limit values Qn-2T1 and Qn+2T1.

```

Date:      ...   Time:  ...
MEASUREMENT COUNT =  ...
QUALIFYING AVERAGE =  ...
STANDARD DEVIAT. S =  ...

*HISTOGRAM*
<Qn-2T1  -n2T1
Qn-2T1
A      nA  █
B      nB  █
C      nC  █
D      nD  █
E      nE  █
F      nF  █
G      nG  █
H      nH  █
I      nI  █
J      nJ  █
Qn-2T1
>Qn-2T1  +n2T1
                █

RESULT :      ...
CONTROLLER :  _____
    
```

14.24 Statistical calculations function (StAt)

Attention: Function is available on demand and it replaces other special functions.

This function evaluates from series of measurements (max 500) statistical parameters of weighting process. Adding successively measurements to register is automatic and it occur after the scale is loaded and its indications stabilize.

After each loading printout is made with: number of measurements, result, date and time.

Next measurement is made after taking off earlier load.

For the obtained measurements series the scale evaluates:

- n - number of samples
- sum x - sum of all samples $sum _ x = \sum x_n$
- \bar{x} -average value (sum x)/n
- min -minimal value from n samples
- max -maximal value from n samples
- max-min -maximal value minus minima value
- S -standard deviation $S = \sqrt{\frac{1}{(n-1)} \sum_n (x_n - \bar{x})^2}$
- srel -variance factor $srel = \frac{S}{x}$

Statistical calculations results can be printed.

Order of operations:

1. Press *MENU* key.
2. When *F..-StA* is displayed press $\rightarrow T \leftarrow$ key.
The following options are displayed:
 - *F..-P* – statistical data printout,
 - *F..-0* - out of function, register zeroing, statistic data printout,
 - *F..-I* - enter or continue function,
3. Press $\rightarrow T \leftarrow$ key when *F..-I* is displayed.
4. Put on successively objects on pan, (remove after indication stabilization) in order to add them to measurement register.
5. In order to obtain printed statistical results from measurements series press *MENU* key.
When sign *F..-StA* is displayed, press $\rightarrow T \leftarrow$ key.
When *F..-P* is displayed press again $\rightarrow T \leftarrow$ key.

This will cause printout of calculated statistics and histogram :

- LSL - allowable lower value,
- USL - allowable upper value,
- A, B, C, .. – measurement intervals,
- n_A ... – amount of measurements in A interval; measurement is in A interval if it is bigger or equal to A interval threshold and smaller than B interval threshold.
- n_B ... - amount of measurements in B interval; measurement is in B interval if it is bigger or equal to B interval threshold and smaller than C interval threshold.

Thresholds are printed under histogram.

- NG - amount of measurements under allowable lower value
- +NG - amount of measurements above allowable upper value

To finish work with this function and zeroing result register press *F* key, then during "*F..-StA*" and "*F..-0*" is displayed, press $\rightarrow T \leftarrow$ key. This will cause printing message about register zeroing.

Data:	...	Hour:	...
SAMPLES	=		...
TOTAL MASS	=		...
AVER MASS	=		...
MIN MASS	=		...
MAX MASS	=		...
MAX - MIN	=		...
S	=		...
SREL	=		...
HISTOGRAM			
LSL	...		
USL	...		
DIV	...		
-NG	...		
LSL			
A	n _A		
B	n _B	█	
C	n _C	█	-----
D	n _D		
E	n _E	██	
F	n _F	███	
G	n _G	████	
H	n _H	█████	
I	n _I	██████	
J	n _J	███████	
USL		█████	
+NG	...	███	
A	~	█	
B	~		
C	~		-----
D	~	█	
E	~		
F	~		
G	~		
H	~		
I	~		
J	~		
Measurement made by : _____			

Cooperation between statistics function with computer and printer.

The scale can be equipped with two RS232C connections marked as RS232C-I (computer) and RS232C-II (printer). After each printer data printout, identical set of data is send to computer. After S A CR LF (53h 49h 0Dh 0Ah) initialization signal is sent by computer, the scale sends to computer statistical data contained in histogram.

14.25 Paperweight calculation (PAP)

Note: This function is enable for special orders substitutable with other functions.

This function enables to calculate paperweight of 1m^2 of paper basing on samples of known area. For quick access, the function is accessible directly by pressing *MENU* key.

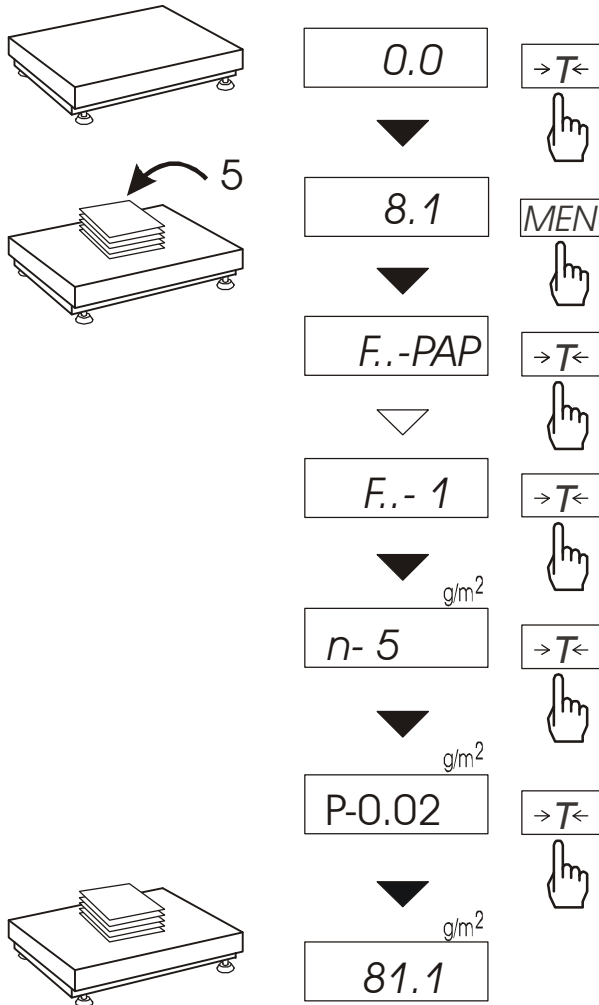

The balance must be tared just before the measurement.

Place the specific sample quantity of the same area (possible values: 1, 2, 5, 10, 20, 50, 100).

Press *MENU* key to access Function Menu. To enter the function press →T← key when *F..-PAP* is displayed.

n is the number of samples placed on the pan. To choose previously used value, select ... option.

"P" is the area of a single sample. It is possible to choose standard values (0,02 or 0,1g/m²) or enter specific value ("A" option).

To enter the value use the following keys:

- ▼ - digit increase,
- ↩ - decimal point,
- T← - next digit,
- MENU* - end.

The result of paperweight measurement is finished with "=" mark pointing g/m² unit.

The balance is ready for the next measurements

Note:

1. *Err-3* communicate signalises that a sample was not put on the pan.

The same communicate appears if single piece weight is less than one reading unit.

Maintenance and repairs of small defects

1. The scale should be kept clean.
2. Take care that no dirt gets between the platform and the scale base. If found any, remove the pan (lift it up), remove dirt and then replace the pan.
3. In case of improper operation caused by short-lasting power supply decay, unplug the scale from the mains and then plug it again after few seconds.
4. If the scale is switched on with empty pan and “Err-b” communicate appears, the load cell has been mechanically damaged.
5. It is forbidden to make any repairs by unauthorised persons.
6. To repair the scale, please contact our nearest service.

Error communicates:

Communicate	Possible cause	Remedy
<i>C-1 ... 6</i> (over 1 min.)	selftests failed	if displayed more than 1 minute, contact an authorised service
<i>Err-b</i>	the scale was switched on with loaded pan	remove a load from the pan
	mechanical damage of the load cell	contact an authorised service
<i>L</i>	pan missing	put the pan on
	mechanical damage	contact an authorised service
<i>H</i>	overloading	remove the load from the pan
	mechanical damage	contact an authorised service
 indicator does not appear	unstable ground vibrations air flows	place the scale on a stable ground not affected by mechanical vibrations and airflows
	scale is damaged	contact an authorised service
- - - - -	taring in progress	as above
- -	taring could not be finished (the load is too small or B\G key was used)	zero the scale or press B\G key again
- -	the load is too big to be zeroed	tare the scale (→T←)

Declaration of Conformity

We:

AXIS Spółka z o.o. 80-125 Gdańsk, ul. Kartuska 375B

confirm with all responsibility that scales:

B30E, B60E, B150E

marked with CE mark comply with the following:

1. EN 61010-1 standard Safety requirements for electrical equipment for measurement, control and laboratory use. General requirements harmonized with the directive 73/23/EEC (Low Voltage Directive).
2. EN 55022:2000 standard Limits and methods of measurement of radio disturbance characteristics of information technology equipment and IEC 61000-4-3 Electromagnetic compatibility (EMC) - Part 4-3: Testing and measurement techniques - Radiated, radio-frequency, electromagnetic field immunity test, harmonised with the Council Directive 89/336/EEC.

Additionally scales with the following markings on the name plate:

- a sticker with two-digit number of the year in which the mark was affixed and the number of the Notified Body responsible for EC verification
- a green metrology sticker with "M" mark,
- a protective seal affixed by the Notified Body



comply with requirements stipulated on the EC Type-Approval Certificate No. PL 04 022 and was verified by Notified Body No. 1440 to comply with:

3. EN 45501 Metrological aspects of non-automatic weighing instruments harmonised with the Council Directive 90/384/EEC amended with 93/68/EEC.

Additional information

- Conformity evaluation for the Council Directive 73/23/EEC and 89/336/EEC were carried out by Laboratorium Badawcze Oddziału Instytutu Elektrotechniki in Gdańsk, accredited by PCA
- EC Type-Approval Certificate No. PL 04 022 was issued by Główny Urząd Miar in Warsaw (Notified Body no. 1440).

Gdańsk, 5.09.2006 r.

Per pro Director of AXIS Sp. z o.o.:

Production Manager Jan Kończak

A handwritten signature in black ink, appearing to read 'Jan Kończak', is written over a horizontal line. Below the line, the word 'Signature' is printed.

Appendix A

Information's concerning double-range scale (options)

1. General description

Double-range scale's have capability of work with greatest accuracy in bottom measuring range part. Weighing of smallest mass is more precise.

This type of scale's have two measurement range:

- Max_1 - 50 % of maximum load (mostly),
- Max_2 - 100% of maximum load,

and adequate reads digit: d_1 i d_2 ($d_1 < d_2$).

Double-range options causes change of scale's operation:

- after turn on (in small mass range 0- Max_1) scale displays result with reading unit d_1 ,
- when the load pass the Max_1 scale changes reading unit on d_2 ; from this moment scale displays result with reading unit d_2 on all measure range (0- Max_2),
- return to unit d_1 is succeed after zeroing the scale ($\rightarrow 0 \leftarrow$ key), or when all mass is removed from pan (indicator " $\rightarrow 0 \leftarrow$ ").

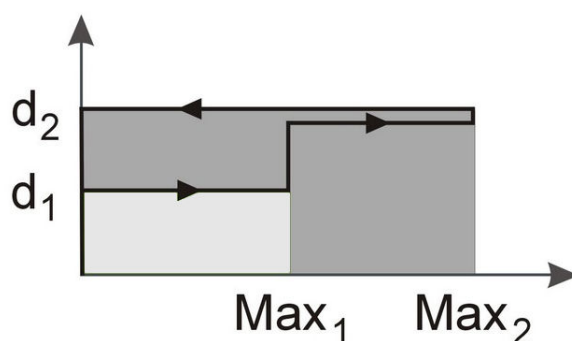

2. Double-range scale parameters

Scale type	B30EZ	B60EZ	B150EZ
Maximal load (Max ₁ /Max ₂)	15/30kg	30/60kg	60/150kg
Minima load (Min)	100g	200g	400g
Readout unit (d ₁ /d ₂)	5/10g	10/20g	20/50g
Verification unit (e ₁ /e ₂)	5/10g	10/20g	20/50g
Accuracy class	III		
Tare range	-30kg	-60kg	-150kg
EC verification	✓	✓	✓

Notes

