

P180E

Portable LED Light

User Manual

Table of Contents

What's In The Box	1
Getting To Know The Light	2
Set Up And Basic Operation	4
Optional Accessories	7
Specifications	8
For Your Safety	9

What's In The Box

- P180E Light with Cold Shoe Mount w/ Stud

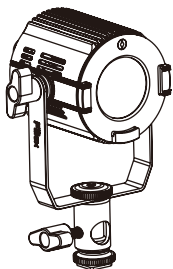

- 4 Leaf Barndoor

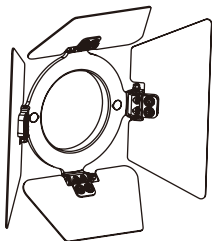

- Power Supply

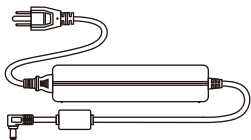

Getting To Know The Light

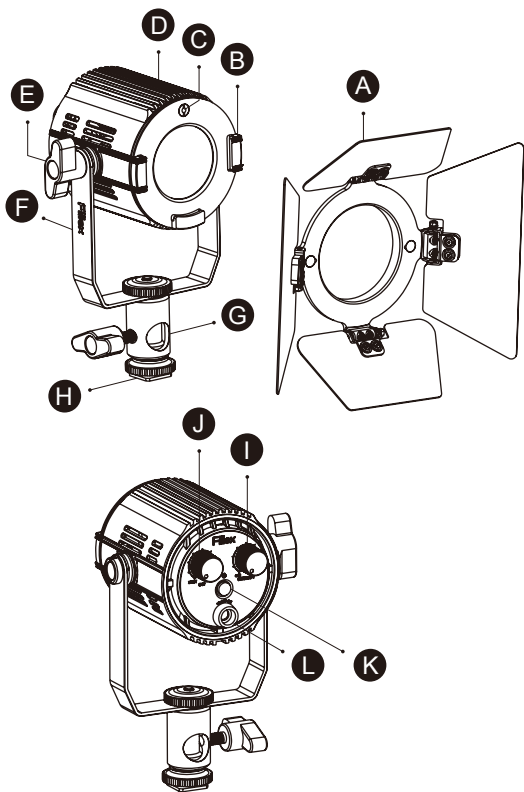

- A 4 Leaf Barndoor
- B Barndoor Slot
- C Barndoor Fix Ball
- D Air Vents
- E Yoke Knob
- F Yoke
- G Light Stand Adapter
- H Cold Shoe Mount w/ Stud
- I Light Intensity Knob
- J CCT Tuning Knob
- K On/ Off Button
- L DC Power Input Jack

Set Up And Basic Operation

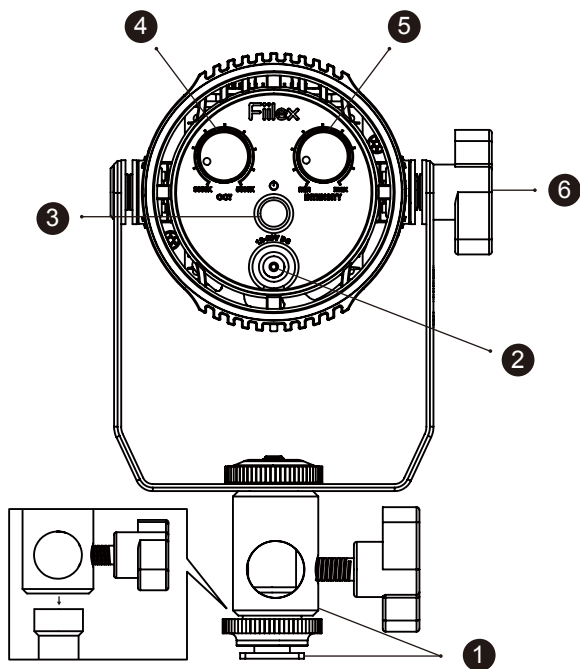

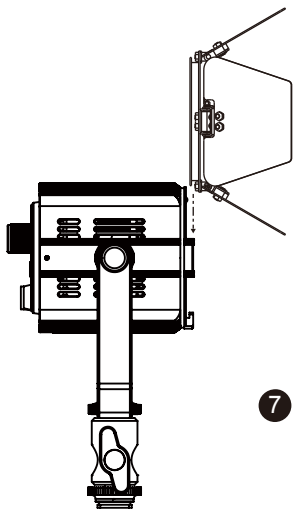

7

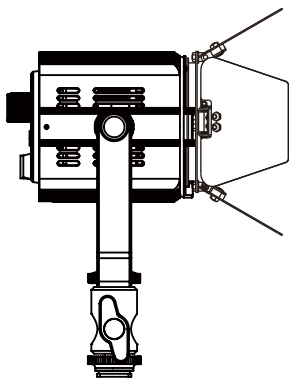

- 1 Mount Light Stand Adapter (G) to 5/8 Stud on Light stand or use Cold Shoe Mount (H) to attach to camera.
- 2 Insert the AC/DC Power Adapter into the Power Input Jack (L).
- 3 Press the On/Off Button (K) to power on the P180E.
- 4 Adjust the color temperature with the CCT Tuning Knob (J).
- 5 Adjust the brightness with the Light Intensity Knob (I).
- 6 Loosen the Yoke Knob (E) to install optional Rain Guard or Umbrella Holder.
- 7 Slide the Barndoor (A) into the Barndoor Slot (B) until it clicks into place.

Optional Accessories

Fresnel Lens

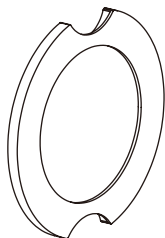

D-tap Cable

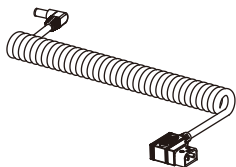

Dome Diffuser

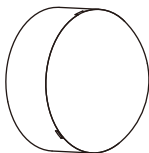

Rain Guard

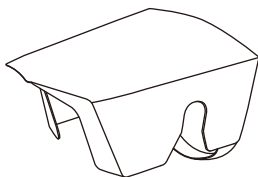

See website for additional accessories. www.filex.com

Specifications

Size (without Barndoor)

2.9" x 2.9" x 3.8" / 74.2 x 74.2 x 98mm

Weight (Includes Yoke)

1.2 lb/527g

LED

Dense Matrix LED

Thermal Design

Advanced Vapor Cooling System

CCT Range

Continuous from 3000 - 5600 K

CRI

>92

Power Consumption

40W Max / Comparable in output to 200W Tungsten

Power Input

12 to 24V DC

AC Adapter

100-240V AC, 50-60Hz (In) / 19V DC, 65W Max (Out)

Operating Temperature

-30 to 40 °C

Weather Resistance

IP-24 Rating

For Your Safety

- Do not attempt to disassemble the body of the P180E.
- Do not directly cover the side and/or back air vents.
Allow for proper air flow.
- Use only included power supply or optional D-Tap Cable.
Failure to do so may cause damage to the LED light.
- Use only a soft, dry towel to gently clean the exterior of light when needed.
- Before powering up for the first time, please remove any or all protective membranes from the light.

Fiilex[™]

Fiilex.com

1689 Regatta Blvd. Richmond, CA 94804

(510)620-5155 . Fiilex@Fiilex.com

Information and Specifications in this document are subject to change without notice. DiCon Lighting, Inc. assumes no responsibility or liability for any error or inaccuracies that may appear in this manual. Unlawful reproduction or distribution in any manner without the written permission of DiCon Lighting, is strictly prohibited.

© DiCon Lighting 1996-2014 All Rights Reserved

Fiilex™



Fiilex.com