

Stat Fax[®] 303 Plus

Operator's Manual



TABLE OF CONTENTS

1.0 Introduction.....	1
1.1 Applications	1
1.1.1 Intended Use	1
1.1.2 Summary of the Instrument	1
1.2 Principles of Operation	2
1.3 Warning Markings	3
1.3.1 Safety Symbols	3
1.3.2 Safety Terms	3
1.4 Safety Precautions.....	4
1.5 Installation.....	6
1.5.1 General Installation	6
1.5.2 Serial Port.....	7
1.5.3 Internal Printer	8
1.5.4 Check-out Procedure.....	8
1.6 Major Parts and Controls	9
1.7 Keyboard Functions.....	10
1.8 Specifications.....	12
2.0 Operating Procedures.....	15
2.1 General Selections	15
2.1.1 Selecting a Strip Format.....	16
2.1.2 Selecting a Mode.....	17
2.1.3 Quitting a Mode	18
2.1.4 Selecting Filters	18
2.1.5 Selecting a Blank	19
2.1.6 Selecting Duplicates.....	19
2.1.7 Unit Codes	20
2.1.8 Selecting Cutoff Interpretations.....	20
2.1.9 Selecting Control Options.....	21
2.1.10 Selecting an END location.....	22
2.1.11 Strip Carrier Loading and Positioning.....	22
2.2 Calculation Programs.....	23
2.2.1 Absorbance Mode	23
2.2.2 Calibrator (Single Standard) Mode.....	23
2.2.3 Cutoff Mode.....	24
2.2.4 Cutoff Control Mode (C/O Control).....	26
2.2.5 Regression Mode	28
2.2.6 Point-to-Point Mode.....	30
2.2.7 % Absorbance Multi-Point Mode	31
2.2.8 Uptake Mode.....	32
2.3 User Test Menu.....	32
2.3.1 Storing a Test.....	32
2.3.2 Deleting a Test.....	33
2.3.3 Recalling a Test.....	33

2.4 Special Features	34
2.4.1 Clock and Calendar	34
2.4.2 Lamp Saver	34
2.4.3 Flags and Error Messages	34
2.4.4 Differential Absorbances	35
2.4.5 Calibration and Linearity	36
3.0 Additional Tips and Information	37
3.1 Restoring Electronic Calibration.....	37
3.2 Operating Precautions.....	37
3.3 Maintenance.....	38
3.4 Troubleshooting.....	39
3.5 References.....	41
4.0 Appendices.....	43
4.1 Appendix 1: Dri-Dye [®] Check Strips.....	44
4.2 Appendix 2: Test Log	45
4.3 Appendix 3: Sample Printouts	46
4.4 Appendix 4: Contact Information	48

1.0 INTRODUCTION

1.1 Applications

1.1.1 Intended Use

This microstrip reader is a laboratory instrument intended for in-vitro diagnostic use. It is a compact, microprocessor-controlled, photometer system designed to read and calculate the results of endpoint colorimetric assays, which are read in microtiter strips. This general purpose instrument is intended to be used by trained laboratory professionals.

1.1.2 Summary of the Instrument

The instrument reads monochromatically or bichromatically, and has 3 models; a four filter model (405, 450, 492, and 630 nm), a six-filter UV model (405,450,492,630,545, and 340nm), and a 6-filter VIS model (405,450,492,630,600, and 545 nm). Substitute wavelengths in the range of 340 nm to 700 nm are also available on specially ordered models. It is designed to accept many single column microstrips up to 12 wells in length, as well as break-apart wells, whether the wells have flat- or round bottoms. An accessory carrier is available for use with dual column 2x8-well strips and single-column 8 well strips. The user need only position the carrier to the desired row; the instrument automatically positions the strips, reads absorbances, calculates concentrations, and prints results. It comes with a built-in thermal graphics printer with the capability to plot standard curves.

Besides providing absorbance readings, this instrument also offers pre-programmed modes for performing the most commonly used calculations, multiple convenience features, and user programmable memory to further facilitate testing.

Preprogrammed Modes

The reader is programmed with many keyboard-selectable general purpose programs. Each mode is self-prompting, to reduce error and simplify operation. The general purpose programs include absorbance, single point calibration, cutoff determination, multi-point linear and log-logit regressions and point-to-point connections, multi-point % absorbance calculations, and an uptake mode. Each mode is described in detail in section 2.2-Calculation Programs. These calculation modes have been selected to facilitate the performance of enzyme immuno assays, drug levels, and other similar tests.

Convenience Features

Multiple convenience features include automatic blanking options and the ability to indicate the locations of positive and negative controls and to enter control acceptance criteria for automatic comparisons, to select positive and negative interpretations based on concentration value, and to edit out discrepant duplicates with automatic reread and recalculation. Instructions for each of these modes and convenience features are provided in this manual.



User Programmable Memory

User-programmable memory allows the operator to store test protocols, recall tests by number, and delete unwanted tests from a user-generated test menu. Instructions for using this memory are given in section 2.3.3-Recalling a Test.

Besides quick, accurate, and reproducible results, the instrument offers maintenance-free and easy operation, versatility, and economy. A stable factory-calibrated durable design, with a timed lamp saving feature, further assures the reliability of this instrument.

1.2 Principles of Operation

Light energy from an overhead lamp is focused by a lens, directed through an aperture, and then passed vertically through the sample. Below the sample, a continuously rotating wheel positions the filters so that readings can be taken very quickly at both the primary and differential wavelengths. Use of bichromatic differential absorbance values corrects for optical imperfections in the plastic wells, differences in well meniscus, turbidity, and lamp variation. A photo detector convert's transmitted light energy into electrical signals, which are amplified and interpreted.

1.3 Warning Markings

1.3.1 Safety Symbols

Safety symbols which may appear on the product:



WARNING
Risk of Shock



Protective Ground
(Earth) Terminal



CAUTION
Refer To Manual



BIOHAZARD
Risk of infection

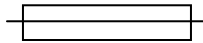

FUSE: For continued protection against the risk of fire, replace only with fuse of the specified type and current ratings. Disconnect equipment from supply before replacing fuse.

1.3.2 Safety Terms

These terms may appear on the product:

DANGER indicates an injury immediately accessible as you read the marking.

WARNING indicates an injury hazard not immediately accessible as you read this marking.

CAUTION indicates a hazard to property including the product.

Terms which may appear in this manual:



WARNING statements identify conditions or practices that could result in injury or loss of life. **WARNING** indicates an injury hazard not immediately accessible as you read the marking.



CAUTION statements identify conditions or practices that could result in damage to this product or other property.

BIOHAZARD: Biohazards are biological agents that can cause disease in humans. Lab workers handling potentially infectious materials must use universal precautions to reduce the risk of exposure to these agents.

1.4 Safety Precautions

To assure operator safety and prolong the life of your instrument, carefully follow all instructions outlined below.

Read Instructions

Review the following safety precautions to avoid injury and prevent damage to this instrument or any products connected to it. To avoid potential hazards, use this instrument only as specified. For best results, familiarize yourself with the instrument and its capabilities before attempting any clinical diagnostic tests. Refer any questions to your instrument service provider.

Servicing

There are no user-serviceable parts inside the instrument. Refer servicing to qualified service personnel. Use only factory authorized parts. Failure to do so may void the warranty.

Personal Protective Equipment

Many diagnostic assays utilize materials which are potentially biohazardous. Always wear protective apparel and eye protection while using this instrument.

Follow Operating Instructions

Do not use the instrument in a manner not specified by the manual or the protection provided by the instrument may be impaired.

Use Proper Power Cord

Use only the power cord specified for this product and certified for the country of use.

Ground the Product

This product is grounded through the grounding conductor of the power cord. To avoid electric shock, the grounding conductor must be connected to earth ground. An alternate method is to attach a ground strap from the external grounding terminal on the rear panel of the instrument to a suitable ground such as to a grounded pipe or some metal surface to earth ground.

Observe All Terminal Ratings

To avoid fire or shock hazard, observe all ratings and markings on the instrument. Consult this manual for further ratings information before making connections to the instrument.

Install as Directed

The Microstrip Reader should be installed on a sturdy, level surface capable of supporting the instrument's weight of 13 lbs (5.9 kg) safely for safety and ventilation purposes. The mounting surface should be free of vibrations.

Provide Proper Ventilation

Refer to the installation instructions for details on installing the product so it has proper ventilation. The instrument should be surrounded by the following clearances: 8 cm around perimeter of unit and 8 cm on top.

Do Not Operate Without Covers

Do not operate this instrument with covers and panels removed.

Use Proper Fuse

Use only the fuse type and rating specified by the manufacturer for this instrument. Use of a fuse with an improper rating may pose a fire hazard. Refer to the section on Trouble Shooting for details on fuse replacement.

Avoid Exposed Circuitry

Do not touch exposed connections and components when power is present.

Avoid Excessive Dust

Do not operate in an area with excessive dust.

Do Not Operate With Suspected Failures

If you suspect there is damage to this instrument, have it inspected by a qualified service person.

Do Not Operate in Wet/Damp Conditions**Do Not Operate In An Explosive Atmosphere****Keep Instrument Surfaces Clean and Dry**

Solvents such as acetone or thinner will damage the instrument. Do not use solvents to clean the unit. Avoid abrasive cleaners; the display overlay is liquid-resistant, but is easily scratched.

The exterior of the instrument may be cleaned with a soft cloth using plain water. If needed, a mild all-purpose or nonabrasive cleaner may be used. A 10% solution of chlorine bleach (5.25% Sodium Hypochlorite) or 70% isopropyl alcohol may be used as a disinfectant. Take special care not to spill liquid inside the instrument.

Operating Precautions

Be sure to run a sufficient number of controls in each assay. If controls are not within their acceptable limits, disregard test results.

Biohazard Precautions

BIOHAZARD



WARNING - If any materials are overturned during operation, immediately set the power switch to OFF (0). This material should be treated as potentially biohazardous. Appropriate cleanup and disposal of biohazardous waste should be used.

1.5 Installation

1.5.1 General Installation

Unpack Instrument

Carefully unpack the instrument, removing it from its plastic bag. Report any damage to your freight carrier at once. The box should also contain the Owner's Manual and a serial cable.

NOTE: Retain the original packing material for future use in the event that the instrument is shipped to another location or returned for service.

Instrument Mounting and Use

Place the instrument on a flat working surface capable of safely supporting the weight of the instrument (approx. 21 lbs, 9.5 kg). Excessive vibration during reading may cause poor repeatability; thus, a sturdy working surface is required. A clearance of at least 3 inches (8cm) around the instrument is required to assure optimal ventilation. It is recommended that the instrument be operated within an ambient temperature range of 18-35°C and humidity of less than 80%.

Power Switch Position

When installing the power cord or if changing the setting on the voltage select switch the unit should be turned off. Look at the rear panel of the instrument to check that the power switch is in the Off position.

Power Cord Requirements

Use only the power cord specified for this product and certified for the country of use. For 110-120 V units used inside the US use a UL listed cord set consisting of a minimum 18 AWG, Type SVT or SJT three conductor cord, maximum 3 meters (10 feet) in length, rated 10 A, 125 V, with a parallel blade, grounding type attachment plug.

For 220-240 V units used inside the US use a UL listed cord as above, except rated 250 V, with a tandem blade, grounding type attachment plug. The cord set provided by the manufacturer meets these requirements.

Safety Grounding

Do not alter or defeat the safety grounding methods provided. To avoid the risk of electric shock, the third prong of the AC power plug must be connected to conductive parts internal to the equipment. Internal fasteners to grounding points are marked by the IEC 417 symbol 5019



. DO NOT loosen or remove these fasteners or connections. An alternate method of grounding is provided by connecting the grounding terminal located on the rear panel, to a suitable ground.

To avoid electric shock, the power cord protection ground conductor must be connected to ground.

Voltage Select Switch

Locate the voltage select switch on the rear panel. This is a 2-position slide switch that will configure the instrument to accept either 230V or 115V input. Do not connect equipment to the power supply before changing the line voltage selection switch.



Warning: To prevent permanent damage to the instrument, this switch must be set for the appropriate input voltage before powering up.

When you can see the 230V label, the instrument is set for 230V input. If you plug the instrument into an 115V power supply while 230V is selected, the instrument will have insufficient operating power.

To select 115V input, insert a straight screwdriver blade (or similar instrument) into the slot on the switch, and slide it into its alternate position. Upon sliding the switch, you will see the 115V label appear.



Warning: If the instrument is configured to accept 115V and you plug it into a 230V power supply, the fuses will blow and permanent damage to the electronics may result.

Assure Clean Power Availability

The circuit used should be substantially free of large voltage transients (Kilovolt amp loads) such as large pumps, large centrifuges, refrigerators and freezers, air conditioners, large autoclaves, ovens, and dryers. The instrument may fail to operate normally if the power supply is interrupted. If this occurs, turn the instrument off for a moment. When you turn the instrument back on, it will resume normal operation, but a standard curve which was not stored in nonvolatile memory will be lost.

Fuse Requirements

The fuses are located internally in the instrument; there are two fuses, fusing both sides of the main power supply. Fuse failure is a very rare occurrence and should indicate malfunction of the equipment requiring service by qualified personnel.

The fuses used within this instrument are 1/2 Amp T rated (slow blow), 250 V. Cartridge size is 3AG or size "0", dimensions 1/4 x 1-1/4" (6.3 x 32 mm). For continued protection against risk of fire, use the same fuse for either 115 or 230 V line voltage selection. Disconnect power cord from mains supply before replacing fuses.

1.5.2 Serial Port

The serial port on the back of the instrument echoes the data shown on the internal printer, except for data printed in graphical mode (i.e., standard curve plots). You may use the serial port with the strip reader to output to a PC, but this will require a cable and software not provided with the reader. Contact your dealer for the appropriate cable. Remember that the microstrip reader only sends data out. It does not accept any input from the external equipment.

The serial connector of the reader is located on the right side of the rear panel. Interface: "DB-9P" is configured for data terminal equipment ("D" connector with 9 male pin contacts.) Pin 1 is ground, Pin 2 is the transmit data output.



Data is transmitted at 2400 baud, with 1 start bit, 1 stop bit, 8 data bits in ASCII Code, and no parity bit (RS-232 signal levels).

With both the reader and the receiving equipment turned off, plug in both ends of the cable. Then turn the receiving equipment on. Finally, turn on the strip reader. It is important to have the receiving equipment ready before starting up the strip reader so that data will not be lost.

1.5.3 Internal Printer

If there is no paper in the printer, install a new roll of paper as follows:

How to install a roll of paper:

Remove the paper cover by pinching its sides together and pulling up. Unroll about 10 inches (25cm) of paper, and place the roll on the table behind the instrument. A ragged edge or wrinkled paper will be difficult to load and could cause a paper jam. Feed a clean cut edge of the paper from the back, into the printer, along the top edge of the metal guide inside the printer paper well. Feed slightly more than 1 inch (3 cm) of paper in, then press the PAPER key several times to automatically feed the paper through the printer. You will see the paper feed up through the paper slot in front. If you have difficulty, cut a new straight edge before trying again. Drop the roll of paper into the printer paper well in back, spooling up any loose paper. Replace the paper cover by pinching its sides together and placing it down over the roll of paper. Use of the paper cover is optional for holding the paper down into the printer paper well.

1.5.4 Check-out Procedure

After installation and each time you start up the instrument, perform the following instrument checkout procedure. If any portion of the procedure does not check out properly, contact your dealer to arrange for assistance.

Turn the power switch on. The printer should print the instrument name and “:X,” where X is the software revision level. Then the time and date will print. If they are not correct, see section 2.4.1, Clock and Calendar, for setting time and date. Look for “Ready” and the correct time in the display. Press the ABS key. Look into the strip track for light, indicating that the lamp is lit. See “ABSORBANCE MODE” displayed and printed. The instrument will then display “SELECT FILTER”. Select 405-630nm. Then see “Set Carrier” in the display. Now load the empty carrier over the carrier bar and press the BLANK key and the ENTER key. The instrument will read air. Check that the carrier moves in and back out of the instrument. Check that all 8 or 12 of the readings are $0.000 \pm 0.005A$. Poor repeatability of the absorbance readings for air indicates possible electronic problems.

1.6 Major Parts and Controls

The following labeled sketches will help you to locate and identify the major parts of the microstrip reader. More details on the operation of each feature are provided in section 2, Operating Procedures. The voltage select switch is on the base. The power switch and serial connector are on the rear panel.

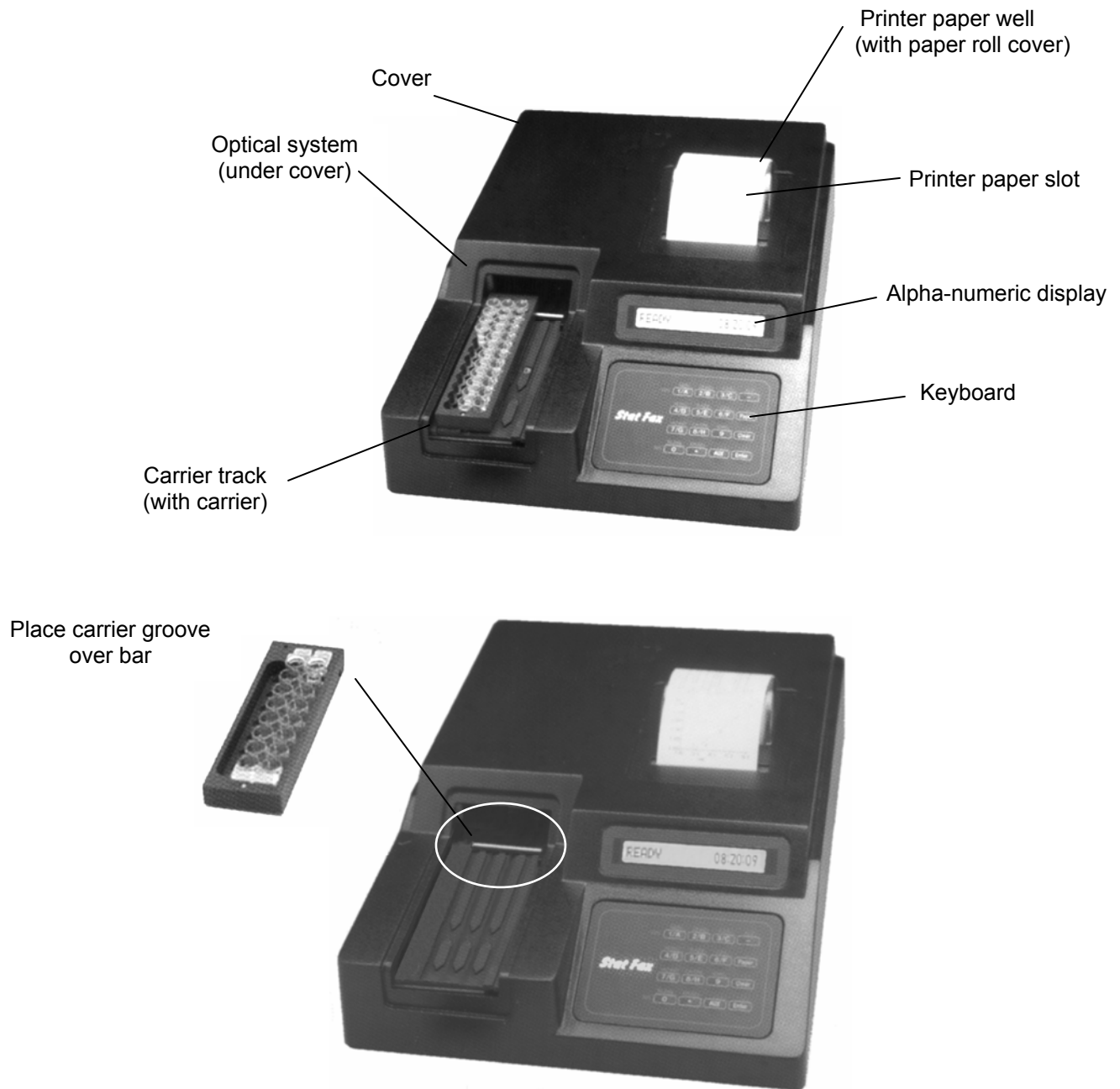

1.7 Keyboard Functions

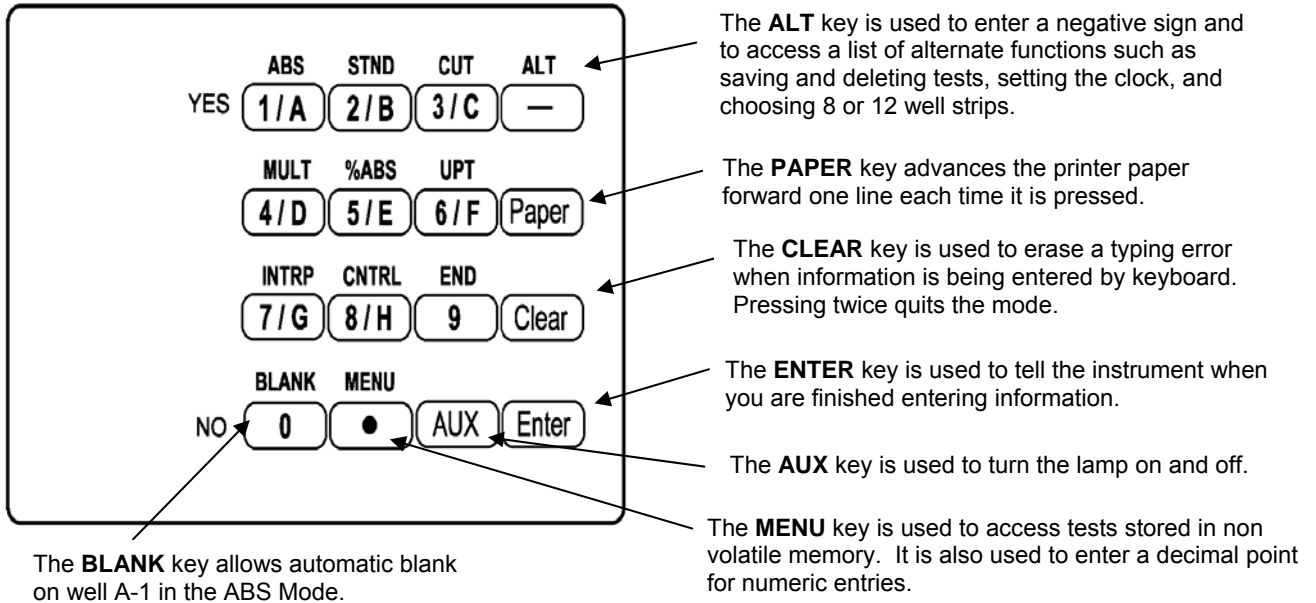

The numeral keys serve several functions. As numbers, they are used to enter test parameters, and to make filter selections. Any key serving multiple functions will respond to the displayed request for information.

ABS, STND, CUT, MULT, %ABS, and UPT, are the keys used to select a mode of operation.

ABS stands for Absorbance Mode.

STND stands for Calibrator (Single Standard) Mode.

CUT stands for Cutoff Mode and offers two choices: Cutoff Control, and Cutoff mode with Reverse Cutoff option.

MULT stands for Multi-Standard Mode and offers two choices: regression (including linear, log, and log-logit), and point-to-point connection.

%ABS stands for Percent Absorbance Multi-Point Mode.

UPT stands for Uptake Mode.

Pressing the INTRP key causes the reader to ask for positive and negative cutoff points to be used for automatic sample interpretation.

Pressing the CNTRL key causes the reader to ask for the locations and acceptance criteria of high and low controls to be used for automatic labeling.

The END key allows the user to select the total number of wells to read and print.

The key assignments for the filters are as follows:

For all models: key 1 is 405nm, key 2 is 450nm, key 3 is 492nm, key 4 is 630nm

6 filter UV: key 5 is 545nm, key 6 is 340nm

6 filter VIS: key 5 is 600nm, key 6 is 545nm

The 1 and 0 keys are also used to answer YES and NO questions.



1.8 Specifications

Photometric

Linear Measurement Range	0.00 to 3.0 Absorbance Units (A)
Photometric Accuracy	\pm (1% of the reading + 0.01 A) from 0 to 1.5A \pm (2% of the reading + 0.01 A) from 1.5 to 3.0A
Stability	Drift of no more than 0.005A in 8 hours
Warm up Time	45 seconds, built-in
Light Source	Tungsten Lamp
Standard Wavelengths	Standard: 405, 450, 492, 630nm Six Filter UV: 405, 450, 492, 630, 545, and 340 nm Six Filter VIS: 405, 450, 492, 630, 600, and 545 nm
Type of Filter	3-cavity hard coat interference filter, 10nm half band pass typical
Vessel	Single, double, or break apart strips, up to 12 wells long, 3 strip loading capacity

Electronic and Software

Speed	Reads, calculates and prints results for up to 12 wells in about 30 seconds
Display	LCD, 16" characters, 5x7 dot matrix
Internal Printer	Thermal, dot matrix, 20 characters per line
Keyboard	16-key, membrane switch, 4X4
Calculation Modes	Single point calibration, Multi-point calibration with regression or point-to-point curve fit, cutoff, cutoff control, % Absorbance Multi-Point, Uptake.
Serial Port	Output only, 2400 Baud, 1 start bit, 8 data, 1 stop, no parity, no handshake
Power Source	Switch selectable power supply (115V or 230V indicated) Voltage Source 110-120/220-240 VAC from 50 to 60 Hz, CAT II Power consumption is less than 50 Watts Fuse: two 1/2A, T rating, 250V, 3AG type fuse All power cords must be approved for the country of use

Certifications and Compliances	NRTL Listed Standard UL -61010A-1, Electrical Equipment for Laboratory Use. CE Certificate of Conformity. Conforms to the following standards: EN 61010-1, EN 61326, following the provisions of the 98/79/EC IVD directive
---	--

Physical

Enclosure	ABS Plastic cover with metal base
Dimensions	Approx. 9"x 12" x 3", (23 x 30 x 8 cm) 13 lbs (5.9 Kg)

Environmental Conditions for Safe Operation

Indoor use
Altitude up to 2000m
Temperature 5°C to 40°C (Although it may be safe to operate in these conditions, it may not be suitable for the performance of your tests; check with your supplier.)
Humidity 80% for temperature up to 31°C, decreasing linearity to 50% humidity at 40°C
Mains supply voltage fluctuations not to exceed \pm 10% of nominal voltage

Recommended Environmental Conditions

Recommended Operating Temperature 18-35°C
Recommended Operating Humidity Less than 80%

Optional Accessories

Available from your dealer DRI-DYE Check Strips for instrument QC, replacement lamps, fuses, thermal paper, serial cable

Design and instrument specifications are subject to change without notice.



Notes:

2.0 OPERATING PROCEDURES

When reading microstrips, the instrument must be programmed to calculate and to label wells and results according to the operator's specifications. For test procedures with many entries, it is recommended that inexperienced operators prepare a list of their selections before beginning operation.

Alternately, these tests can be stored in non-volatile memory to reduce set up requirements to a single step for subsequent uses. When tests are recalled from the user menu, all of the general selections will have been predetermined. Section 2.1 provides information about making general selections such as mode, filter, blank, duplicates, cutoffs, and controls. Section 2.2 follows with mode-specific instructions for each of the general purpose calculation programs. Section 2.3 explains how to create and use your own test menu (stored in nonvolatile memory). Finally, Section 2.4 provides specific details on the operation of additional special features (i.e. clock and calendar, lamp saver, etc.).

2.1 General Selections

Although many features are available to aid the user, this instrument may be operated very simply in most modes by bypassing optional features.

For every test, the instrument will require a mode selection and filter choices. Thereafter, only those questions that pertain to the calculation mode selected will be asked. In the absorbance mode, for example, there are no further selections required.

Here is a list of questions to review before beginning a test:

1. What strip length will be used? (8 wells or 12 wells)
2. What strip type will be used? (e.g., break apart)
3. What calculating program will be used?
4. What filters are optimal? (operating and differential wavelengths)
5. Is a blank required? Desired?
6. What is the calibrator value(s)?
7. Will blanks, calibrators and/or specimens be read singly, or in duplicate?
8. Will locations of 1 or more controls be marked? If so, you will need to indicate row and strip number for each.
9. Will control acceptance criteria be entered for automatic comparison? If so, what are the limits?
10. Will a cutoff value be used to label any samples as positive? (If so, the value which begins the positive range will be required.)
11. Will a cutoff value be used to indicate negative samples or define an equivocal zone? If so, results less than what cutoff should be labeled as negative?
12. Will you be running partial strips? If so, you may want to assign an END location.



13. Will this test be stored? If so, you must remember to store it before you cancel the mode.
14. For modes using duplicate calibrators, the instrument will ask you if you accept the standard curve before proceeding. What criteria will be used to determine “bad curves?” Then, you will be asked which points you wish to delete. Again, some preestablished criteria for selecting “bad points” and perhaps a maximum number of acceptable deletions might be needed.

NOTES:

1. For the purposes of this manual, the terms “standard(s)” and “calibrator(s)” are used interchangeably to designate reference materials of known concentrations. The terms “specimen(s)” and “sample(s)” are also used interchangeably to mean materials of unknown concentrations.
2. Pressing the ENTER key will bypass many unwanted options.

To begin, turn the instrument on and perform the Check Out Procedure (Section 1.5.4). When it is finished, the instrument will display “**Set Carrier**”. Press the CLEAR key twice to cancel the Check Out. See “**Ready**” and the time in the display.

If you do not wish to perform the Check Out, turn the instrument on and see “**Ready**” and the time in the display. The lamp will warm up for 45 seconds. During this time, you may begin making your selections. If the lamp warm up is not completed by the time you press the ENTER key to read the first strip, the display will indicate “**LAMP WARM UP 00**” where 00 represents the number of seconds remaining. When the instrument is ready, a double beep will be heard, and the instrument will begin reading.

GENERAL OPERATION TIPS:

- Wipe any dust or fingerprints from the bottoms of the strips before using.
- Do not read strips that contain bubbles or condensation.
- Use the same volume for the blank as you use for the samples.

2.1.1 Selecting a Strip Format

Microstrips are typically either 8 or 12 wells in length. Using the keyboard, this instrument can be configured for reading and labeling either type of strip. When using the standard 12-well carrier, you may still select either strip format.

First, press the ALT key. ALT stands for alternate functions. You can use this key to access several functions, including changing the strip type. The first display is “**SAVE TEST Y/N**”. Respond by pressing the NO key. Next you will see “**STRIP TYPE Y/N**”. This time, answer with the YES key.

The display will ask “**8 WELLS Y/N**”. If you want to read 8 well strips, answer YES and see “**8 Well Strips (A-H)**” printed. If you want to read 12 well strips, press NO and see “**12 Well Strips 1-12**” printed. The display will return to “**Ready**”.

You may change between reading 8 well strips and 12 well strips via the ALT key whenever the display indicates “**Ready**”.

If a test is stored in the test menu, the strip type will also be saved.

2.1.2 Selecting a Mode

This instrument contains several pre-programmed general purpose calculations which have been selected to facilitate data handling for enzyme immunoassays and other similar tests.

1. Absorbance Mode (ABS key)
2. Calibrator (Single Standard) Mode (STND key)
3. Cutoff Mode (CUT key)
4. Multi Standard Mode (MULT key) - includes Regression Mode and point-to-point calculation.
5. % Absorbance Multi-Point Mode (%ABS key)
6. Uptake Mode (UPT key)
7. Alternately, a previously-stored test could be recalled from your user test menu at this time. (Instructions for that are found in section 2.3, User Test Menu) (MENU key)

The mode designations are located above the first 6 numbered keys on the keypad. When any of these is selected, the printer will print the date, the time, and the name of the mode selected, and the display will indicate the next instruction.

A brief description of each mode follows. For a more detailed description, see section 2.2.

In the **Absorbance Mode**, the Microstrip Reader reads and prints the absorbances at the user-selected wavelengths. Blanking is optional.

In the Calibrator (**Single Standard**) **Mode**, the instrument first accepts a calibrator singly or in duplicate, then calculates concentrations based on a single-point standard curve passing through the point (0,0). A blank is required in the first well (or first two wells if duplicate blank is selected). A factor (equal to the concentration of the calibrator \div the absorbance of the calibrator) is generated in this mode and then multiplied by subsequent absorbances to determine concentrations. Duplicates, cutoff interpretation, and control options are available.

In the **Cutoff Mode**, a number of negative controls are read, followed by a number of positive controls. Blanking on the first well is optional. The instrument calculates the mean of the positives and the mean of the negatives. It also checks the individual control wells or the means for QC purposes. It adds three terms: one user-entered number "X" multiplied by the mean of the negative controls, another user-entered number "Y" multiplied by the mean of the positive controls, and a third user-entered number "Fac". The user may also select an equivocal range. This determines cutoff points for interpretation of subsequent specimens.

In the **Cutoff Control Mode**, negative controls, cutoff controls, and positive controls may be read in any combination. Blanking on the first well is optional. The instrument calculates a cutoff value from the mean of cutoff controls. It also checks the individual control wells or the means for QC purposes. The user may select Correction factor and equivocal range options. These adjust the cutoff value to determine cutoff points for interpretation of subsequent specimens.



The **Regression Mode** accepts calibrators, and calculates sample concentrations based on the best fit (linear regression). Regressions may be calculated for linear or logarithmic data, as well as log/logit data. A blank is optional. Duplicates, cutoff interpretation, and control options are available.

In the **Point to Point Mode**, several calibrators may be read and a blank is optional. Line segments connect the points for subsequent calculation of sample concentrations.

In the Percent **Absorbance Multi-Point Mode**, a point-to-point curve is generated, and the absorbance of the A_0 calibrator is assigned 100%. Subsequent absorbances are reported as both concentrations and percents of the A_0 calibrator. A blank is optional. Duplicates, cutoff interpretation, and control options are available.

The **Uptake Mode** requires one calibrator and no blank. Concentrations are calculated based upon a factor which equals the concentration of the calibrator multiplied by its absorbance. This factor is divided by each subsequent absorbance to determine specimen concentration.

2.1.3 Quitting a Mode

If a test is to be saved in the user test menu, this must be done before canceling the mode. See section 2.3.1 for instructions on Storing a User Test.

To quit a mode, press the CLEAR key twice. This may be done at any time. Mode selection keys will not respond if they are pressed without canceling the previous mode first. Press the CLEAR key twice before initiating the next mode.

2.1.4 Selecting Filters

Each mode begins by asking you to choose an operating filter and a differential filter. The filter choices are shown below along with their keyboard assignments:

	<u>Standard</u>	<u>Six UV</u>	<u>Six VIS</u>
Key 1:	405nm	405nm	405nm
Key 2:	450nm	450nm	450nm
Key 3:	492nm	492nm	492nm
Key 4:	630nm	630nm	630nm
Key 5:	-	545nm	600nm
Key 6:	-	340nm	545nm

First you will see “**SELECT FILTER**” in the display. Choose the correct number, and then press ENTER. After the primary filter has been entered, you will see “**SELECT DIF FILTR**”. Again, use the number keys to select the desired filter. You may select 0 for no differential filter if monochromatic reading is desired (If so, refer to Section 2.4.4, Differential Absorbances). If you enter an incorrect filter selection, press the CLEAR key twice to cancel the mode, and then begin again with the primary wavelength. Your choices will be printed, and the operating mode will resume.

The instrument will read every well at both selected wavelengths, reporting the difference of the two (absorbance at primary wavelength minus absorbance at differential wavelength). Be sure to select a differential wavelength at which your chromophore has little or no absorbance; otherwise, sensitivity may be lost.

2.1.5 Selecting a Blank

If the instrument is not “blanked”, the readings are relative to air (no well or contents). The difference between a water blank and an air blank is typically less than 0.020A when reading bichromatically.

The Calibrator (Single Standard) Mode requires that a blank be used in the first well of the first strip. The Uptake Mode operates with no blank. All of the other modes offer the option of a blank in the first well or no blank at all.

The material of choice is a reagent blank that best defines the absorbance of “zero-concentration”.

The absorbance which is printed for a blank well is the absorbance of the blank material relative to air. This absorbance value is automatically subtracted from subsequent absorbances before printing and calculating.

2.1.6 Selecting Duplicates

In most modes, you have the option of reading either one well or two consecutive wells of the blank and calibrators. When duplicates are chosen, the mean absorbance reading is used as the reference absorbance for the blank and calibrator.

You may also choose to read specimens singly or in duplicate. If duplicate samples are selected, the mean absorbance reading will be used to calculate the result for the pair. The reported results for each sample are based on a single concentration value.

To make selections, use the YES and NO keys to answer questions when they are displayed. If you select YES to the prompt “**Duplicates Y/N**”, the display will show the following prompts: “**Dup Blanks Y/N**”, “**Dup Calbrtr Y/N**”, and “**Dup Samples Y/N**”. You may choose duplicates in any combination. When you have made all the selections for duplicates, select YES when the display shows “**Done Y/N**” and your selections will be printed.

Duplicates must be pipetted into consecutive wells.

Controls are read in duplicate only if the samples are selected in duplicate. When using the controls locator feature, only label one location of the control duplicate pair. (See section 2.1.9 for more information about the controls locator feature.)

When using multi-point modes, the absorbances of duplicates will be averaged to designate a single point. For example, consider a 3-point linear regression for which the 3 calibrators are read in duplicate. For calculating the standard curve, $n=3$, $n\neq 6$. If one well of a pair is deleted during an editing cycle, then the other well will represent the mean point and $n=3$, $n\neq 2$ and $n\neq 5$.



2.1.7 Unit Codes

16 units of measurement designations, plus a blank selection (no unit label) are provided for labeling the concentration column:

0	Conc	8	EV
1	AU/mL	9	U/mL
2	Ratio	10	A/mL
3	IU/mL	11	ppm
4	uIU/mL	12	ppb
5	% CAL	13	Abs
6	GPL/mL	14	Index
7	MPL/mL	15	

When the display prompts "**Select Units Y/N**", select YES to choose a unit designation. The display will then prompt "**Key unit code #**". To print the list of units, press 9,9, ENTER. To choose a unit of measurement, select the numerical designation and press ENTER. The selected unit will be displayed along with "**Y/N**". If the displayed unit is correct, press YES. If the unit selected is incorrect, press NO to return to the previous prompt. If no unit labeling is desired, select 15, ENTER.

2.1.8 Selecting Cutoff Interpretations

Samples may be labeled as Positive, Equivocal, or Negative, according to operator-entered criteria. The criteria used are either a single upper cutoff or both an upper and lower cutoff. When a single upper cutoff is used, any concentration which is equal to or greater than the cutoff will be labeled as positive. The letters "P" and "N" are shown in the right-most column of the printout to designate these interpretations. If an upper and a lower cutoff are both used, then the concentrations which are greater than or equal to the upper cutoff are still labeled as positive, but only concentrations less than the lower cutoff are labeled as negative. All other concentrations are labeled "E" for equivocal.

To make cutoff selections: Whenever "**Set Carrier**" is displayed, you may press the INTRP key. (There are three exceptions: absorbance mode, cutoff mode and cutoff control mode) You will see "**Pos > =**" in the display. Type in the upper cutoff, then press the ENTER key. Next, the instrument will display "**Neg <**". If you do not need a lower cutoff, press the ENTER key to bypass this step. Otherwise, enter the value of the lower cutoff and press ENTER. The cutoff(s) will be printed. Check the printout to see that they are correct before proceeding.

In Point to Point and Multipoint % Abs modes, you may also choose to flag samples having absorbance values higher than the highest calibrator or lower than the lowest calibrator.

2.1.9 Selecting Control Options

There are two optional features that facilitate the location and analysis of controls and their results. First, the locations of up to 3 (total) positive and negative (or high and low) controls will be indicated on the printout, if programmed by the operator. Additionally, the operator may enter a control acceptance range for the high control, and an upper limit for the low control. The instrument will print the control criteria and automatically compare the resulting concentrations of "located" controls with these limits. Control results are flagged on the printout.

Control locations and acceptance ranges are entered using the CNTRL key when "**Set Carrier**" is being displayed in any mode (except the absorbance mode, cutoff mode and cutoff control mode). The location of only one well is needed to identify a control being read in duplicate. Control locations must be designated to make automatic comparisons to user-entered acceptance ranges.

When you press the CNTRL key, the instrument will display "**CONTROLS HI=1 LO=0**". Press the 1 key, and then ENTER to select a positive (or high) control. Press 0, ENTER to select a negative (or low) control. For both high and low controls, the instrument will ask for the row and strip number or letter, by first displaying "**ROW (A-H)?**" Type in the row letter, and then press ENTER. You will see "**Strip (1-12)?**" Type in the strip number, and then press ENTER.

Note: If you are in the 8-well mode, the first set of wells (right-most carrier position) will be Strip 1, row A through H. If you are in the 12-well mode, the first set of wells (right-most carrier position) will be Row A, strip 1 through 12.

After you locate the first high control, the instrument asks for the greatest acceptable value for the high control(s) by displaying "**HC Hi > =**". The upper and lower values which you enter for the positive controls will be considered within range, while values lower than the low value or higher than the high value will be considered out of range. You must enter the limits using the same concentration units which are used for your calibrators. Type in the upper limit and press ENTER. Then the instrument will display "**HC Lo <**". Type in the lower limit and press ENTER. The instrument will then display "**CONTROLS, HI=1 LO=0**" again.

A total of three controls (all high, all low, or some of each) may be located. All high controls will be compared to the range you entered for the first high control. For low controls, there is only an upper limit. The message "**LC HI > =**" will be displayed to prompt for the value above which the low control will be considered too high. When you have finished entering controls, press ENTER again to return to the "**Set Carrier**" prompt.

If control locations are entered for wells that have been reserved for either the blank or calibrators, then the blank and calibrator indicators will override positive and negative control indicators when the sample identifications are printed. "**H**", "**L**", or no flag are used to indicate high, low, or in range respectively.

If your test is stored, the locations and acceptance criteria of the controls entered will also be stored for later recall.



2.1.10 Selecting an END location

If you wish to read partial strips, you may use the **END** key to return the strip to home without reading an entire strip. When the display shows “**Set Carrier**”, press the **END** key and enter the number of total wells you wish to read. If you are reading multiple strips, the instrument will function normally until the partial strip is reached.

2.1.11 Strip Carrier Loading and Positioning

The three-position carrier (12 well standard, 8 well available as an accessory) fits into the instrument by placing the carrier's groove over the bar on the instrument. Place your strip such that the blank well or first well is located in the well closest to the carrier groove. If using break-apart wells in the 12 well carrier, start from the front of row A and fill all 12 locations, then begin at the front of row B, etc., and continue until done. Ensure that the wells are firmly placed in the carrier; wells that are not fully seated may be seated too high to enter the instrument's optical system. Slide the carrier to position the strip you wish to read in the center of the instrument's read area. A panel with a notch assists you in lining up your carrier; align the strip you are reading with the notch.

The instrument requires placement of the first standards in strip 1/A, but has no specificity for subsequent strips. The printout will show the location of the carrier for each strip read.

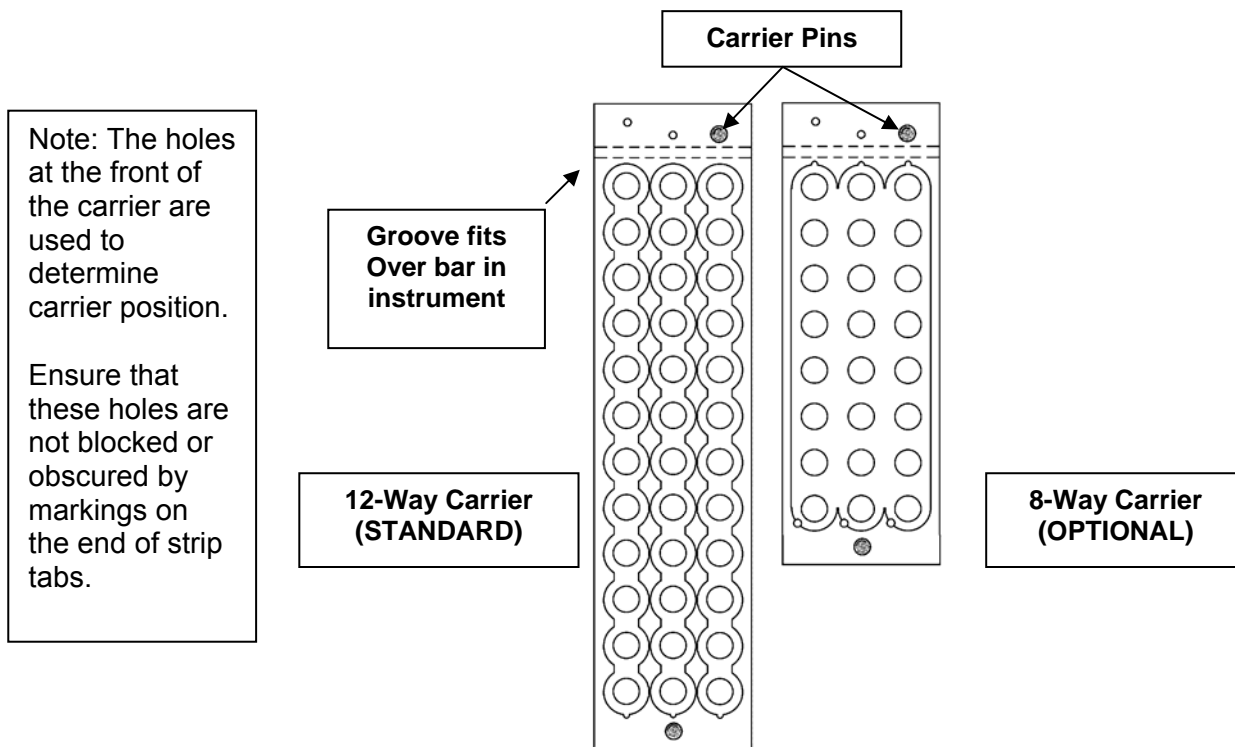

2.2 Calculation Programs

Be sure to familiarize yourself with the general selections in section 2.1. Unless otherwise specified, all general selections are available as described. In addition, all modes may be stored and recalled in the user test menu (section 2.3), and any additional prompts that appear in recalled tests are discussed in section 2.3.3. Note that the Absorbance and Uptake Modes do not have curve storage. When selected, all modes print the date, time, mode, and strip type (8 or 12). The instrument automatically transports the samples through the optical system and back out again, with the carrier position and readings displayed and printed simultaneously. The instrument reads and prints results of an 8 well strip in about 30 seconds. Sample printouts from all modes are found in Section 4.3, Appendix 3.

2.2.1 Absorbance Mode

In this mode, absorbances will be read at the user selected wavelengths, and the absorbance will be displayed and printed. Use of a blank is optional.

After the filters are selected, the reader displays “**Set Carrier**”, “**Then Press Enter**”. Press the BLANK key to blank on the first well. - “Blank(s) in well 1” is printed. Position the carrier in the instrument to read your first strip and press ENTER. Absorbance mode does not require the first strip to be in the right-most carrier position. The instrument reads the strip and simultaneously displays and prints the results. If blanking was selected, the letter “**B**” will appear beside the first well number

When the instrument is ready for the next strip, the display will indicate “**Set Carrier**”, “**Then Press Enter**”. To continue reading in the Absorbance mode, position the carrier for the next strip and press the ENTER key. Since there are no concentration interpretations in absorbance mode, the cutoff and control options are not available.

Press the CLEAR key twice to cancel the mode.

2.2.2 Calibrator (Single Standard) Mode

In this mode, a single calibrator material of known concentration is used to calculate concentrations of unknown samples according to Beer’s Law. Well #A-1 (the first well of the right-most carrier position) is always considered to be the blank, with the calibrator well(s) immediately following. If the duplicate blank option is selected, the first two wells contain the blank material.

After the filter, duplicates, and unit options, the instrument will display “**Cal 1 =**”. Type the concentration value assigned to your calibrator material, then press the ENTER key. The printer will print “**Cal 1 = XXXX**”, where XXXX is the calibrator value you have entered. Note that the instrument allows calibrator values up to 999999, and calibrators less than 1000 can have up to two places after the decimal point. Decimal places for the reported concentrations will be the same as those selected for the calibrator.

The display will then prompt “**Cal Limits Y/N**”. Select NO to continue, or select YES to enter absorbance limits for the calibrator, the display will prompt “**Cal 1 >=**”. Enter the minimum acceptable absorbance value for the calibrator.

“**Set Carrier to X**”, “**Then Press Enter**” is displayed, where X is either 1 or A, depending on the strip type. Load the first strip into the right-most carrier position and press ENTER. While the strip is being automatically positioned for reading, the display will indicate “**Positioning Strp**”.

The instrument will read the strip and simultaneously display and print the results. A letter “**B**” will appear beside the first well or wells to indicate blanking. The symbol “**C1**” will be printed beside the calibrator well or wells, indicating that the well(s) contained calibrator material.

The display will then prompt “**PLOT CURVE Y/N**”. Press YES to print the curve. Press NO and the display will prompt “**Accept Curve Y/N**”. Press YES if the curve is acceptable. Press NO and the display will prompt “**Re Start Y/N**”. Press YES to recall the test, or NO to return to the “**Accept Curve Y/N**” prompt.

2.2.3 Cutoff Mode

In the Cutoff Mode, X is multiplied by the mean of the negative controls, Y is multiplied by the mean of the positive controls, and each of these two numbers are added to the FAC to obtain the cutoff value.

For example, your package insert says that the cutoff value is $.1 * \text{the mean of the positive controls} + .02$. You would enter 0 for X, .1 for Y, and .02 for FAC.

a.) To select this mode, press the CUT key. The display will then show “**C/O Control Y/N**”. If you wish to use cutoff controls, press YES and go on to section 2.2.3-b; otherwise, when you press NO the display will show “**Cutoff Mode Y/N**”. The cutoff mode uses the equation:

$$\text{CO} = X * \text{mNC} + Y * \text{mPC} + \text{Fac}$$

where CO is the cutoff absorbance, mNC is the mean of the negative controls, and mPC is the mean of the positive controls. X, Y, and FAC are user entered coefficients that can have any positive or negative numerical value (including 0 and 1). Press YES. After the filters are selected, if you chose no differential, the Offset Absorbance questions will follow (see section 2.4.4-Differential Absorbances for instructions).

The instrument will give you the choice for reverse cutoff. The display will show “**POS IF > C/O Y/N**”. Press YES to choose the regular Cutoff Mode. If you press NO, the display will show “**POS IF < C/O Y/N**”. Press YES to select the Reverse Cutoff Mode, in which absorbances lower than the cutoff are labeled positive. Note that in the Reverse Cutoff Mode, negative controls have high absorbances and positive controls have low absorbances. All relation signs (> and <) are reversed in this mode. The regular Cutoff Mode is described below, followed by notes on the Reverse Cutoff Mode. In addition, the “Blank” is not subtracted in the reverse cutoff option. The following description is for the normal cutoff mode.

The instrument will then prompt “**BLANK Y/N**”. If you press yes, the instrument will display “**Blank <=?**”. The reader will use this value to check that the blank is valid. Type the greatest acceptable absorbance value for the blank material relative to air, and then press ENTER. The blank absorbance will be subtracted from all subsequent wells, and will be flagged if it exceeds the set limit.

The instrument now prompts for the X, Y and Factor values. Type each of these values followed by the ENTER key. If Y=0 and Factor=0, the display will prompt “**Min C/O Y/N**”. Press YES if your test has a minimum cutoff value. If $X * \text{mNC}$ is less than the Min C/O, the Min C/O will be used as the cutoff. The display will prompt “**Min C/O =**”. Enter the minimum cutoff value.

After these values are entered into the equation, the instrument prompts "**Equiv Range Y/N**". If you answer YES, you will be able to enter an equivocal range based on factors of the cutoff value. The instrument will prompt "**Neg < X*COV; X=**". Enter a number which, when multiplied by the cutoff value, will be the upper limit of the Negative range (enter 1 if you want Negative values to be all values less than the cutoff value). The display will then prompt "**Pos >= X*COV: X=**". Enter a number which, when multiplied by the cutoff value, will be the lower limit of the Positive range (enter 1 if you want Positive values to be all values greater than or equal to the cutoff value). Any samples with absorbances falling between these ranges will be labeled "E" (equivocal).

The display will show: "**Num. of NCs =**". Type in the number of Negative Controls and press ENTER.

If you select 2 or more wells for each control the display will prompt "**Check mean Y/N**". Press NO if the criteria apply to the individual wells or YES if the criteria apply to the mean of the wells

The display will show "**mNeg C. <=**", "**mNeg C. >=**". Type in each value and press ENTER.

The display will show "**Num. of PCs=**". Type in the number of Positive Controls and press ENTER.

The display will show "**Pos C. >=**", "**Pos C.<=**". Type in each value and press ENTER.

The total number of controls, plus the blank, must be less than or equal to 8. If more are entered, "**Too many controls**" and "**TEST ENDED**" will be printed, and the mode will automatically cancel.

"**Set Carrier to X**", "**Then Press Enter**" is displayed, where X is either 1 or A, depending on the strip type. In Cutoff Mode, you may not select additional Controls or Cutoffs. Load the first strip into the right-most carrier position and press ENTER. While the strip is being automatically positioned for reading, the display will indicate "**Positioning Strp**".

The instrument reads the strip and prints the results. Four columns are printed.

"**Well**" tells which well the reading is from.

"**Abs**" prints the absorbance reading.

"**Index**" prints the ratio of the sample to the positive interpretation cutoff.

"**I**" prints sample interpretations:

N - indicates a negative reading,

P - indicates a positive reading, or

E - indicates an equivocal reading

Error messages will also print in the Interpretation column:

H - indicates that the blank or the individual control exceeded the limit entered.

L - indicates that the individual control was lower than the limit entered.



After the first strip is read (and the test is valid) the display will prompt **“C/O Abs OK Y/N”**. If the cutoff value is acceptable, press YES. If the cutoff value is not acceptable, press NO. If the test is stored, the display will prompt **“Recall Test Y/N”**. If the test is not stored, the display will prompt **“Re Start Y/N”**. In either case, press YES to run the test again, press NO to return to **“C/O Abs OK Y/N”**, or press the CLEAR key twice to cancel the mode.

If the test is invalid for any reason, **“Test is invalid”** will be printed after the control readings and only the absorbance readings will be printed.

The instrument will be ready for the next strip when it displays **“Set Carrier”**, **“Then Press Enter”**. To continue reading in the Cutoff mode, load the next strip and press the ENTER key.

Press CLEAR twice to cancel the mode.

Reverse Cutoff Mode:

The Reverse Cutoff Mode provides the ability to interpret low absorbances as positive results. Answer **“N”** to the prompt **“POS IF > C/O Y/N”**, then answer **“Y”** to the prompt **“POS IF < C/O Y/N”**. This will label results **“P”** if they are below the cutoff absorbance and **“N”** if they are above the cutoff. Blank, positive and negative controls, coefficients, and cutoff parameters are entered following the displayed prompts, which occur in the same order described in the regular cutoff mode.

NOTE: Be sure to read the “<=” and “=>” signs in each display, because blank, positive control, and negative control parameters are entered in a reverse way when using this option.

Note that the blank is not subtracted from subsequent sample absorbances. All other calculations and criteria for an acceptable run in the Reverse Cutoff Mode are identical to those in the regular Cutoff Mode.

2.2.4 Cutoff Control Mode (C/O Control)

In this mode, instead of using the means of the negative and positive controls to determine the cutoff, controls (labeled CCs) are used to do so. The positive and negative controls are used for QC criteria.

To select this mode, press the CUTOFF key. The display will then show **“C/O Control Y/N”**. Press YES.

After the filters are selected, if you chose no differential, the Offset Absorbance questions will follow (see section 2.4.4-Differential Absorbances for instructions).

The display will show **“BLANK Y/N”**. Press NO for the photometer to blank on air. Press YES, and the instrument will display **“Blank <= ?”**. The reader will use this value to check that the blank is valid. Type the greatest acceptable absorbance value for the blank material relative to air, and then press ENTER. The blank absorbance will be subtracted from all subsequent wells, and will be flagged if it exceeds the set limit.

The display shows: **“Equiv Range Y/N”**. If you answer YES, you will be able to enter an equivocal range based on factors of the cutoff value. The instrument will prompt **“NEG<X*COV;X=”**.

Enter a number which, when multiplied by the cutoff value, will be the upper limit of the Negative range (enter 1 if you want Negative values to be all values less than the cutoff value). The display will prompt "**POS>=X*COV; X=**". Now enter a number which, when multiplied by the cutoff value, will be the lower limit of the Positive range (enter 1 if you want Positive values to be all values greater than or equal to the cutoff value). Any samples with absorbances falling between these ranges will be labeled "Equivocal".

The instrument then asks for the number of each type of control to be read. You may select 0 for # of Neg Controls and/or Pos Controls, but you must choose at least one Cutoff Control. The instrument will also ask for the absorbance acceptance criteria for the mean of each type of control.

For each type of control, the instrument asks for the number of each type of control to be read, the absorbance acceptance criteria, and if the criteria apply to the individual wells or the mean of the wells for that control.

The display will show "**Num. of NCs =**". Type in the number of Negative Controls and press ENTER.

The display will show: "**Neg C. <=**", "**Neg C. >=**". Type in each value and press ENTER.

If you select 2 or more wells for each control the display will prompt "**Check mean Y/N**". Press NO if the criteria apply to the individual wells or YES if the criteria apply to the mean of the wells.

The display will show: "**Num. of CCs =**". Type in the number of Cutoff Controls and press ENTER.

The display will show: "**C/O C.>=**", "**C/O C.<=**". Type in each value and press ENTER.

The display will show: "**Num. of PCs=**". Type in the number of Positive Controls and press ENTER.

The display will show: "**Pos C. >=**", "**Pos C. <=**". Type in each value and press ENTER.

The instrument will then prompt "**Corr Factor=Y/N**". This correction factor is multiplied by the mean of the C/O Controls to result in the actual cutoff value. Press NO if you do not want to use a correction factor. Press YES and the display will show "**Corr Factor=**". You may enter a correction factor with up to 3 decimal places.

The display will show: "**Done Y/N**". Press YES to run the test. Press NO to select options for additional quality control values. You may choose to check the ratio or the difference between the means of the positive and negative controls to assure adequate distinction. The display will show: "**Ratios Y/N**". Press YES to enter the ratio value for "**mP/mN >=**". Enter the lowest acceptable ratio for the mean of the positive controls to the mean of the negative controls. Press NO and the display will show "**Difference Y/N**". Press YES and the display will show "**mP-mN >=**". Enter the lowest acceptable difference for the mean of the positive controls minus the mean of the negative controls.

Many options not required can be bypassed by pressing ENTER. Otherwise, type each value and press ENTER. Once all information has been entered, "**Set Carrier to X**", "Then Press Enter" is displayed, where X is either 1 or A, depending on the strip type. Load the first strip into the right-most carrier position and press ENTER. While the strip is being automatically positioned for reading, the display will indicate "**Positioning Strp**".



You may use the “END” function at this time to read only part of a strip by following the instructions in section 2.1.10 - Selecting an END location. Load the carrier and press the READ key. The instrument will then begin to read the first strip and print the results, labeling the controls as “NC” or “PC”.

NOTE: All controls plus the blank must fit into 8 wells. If more are entered, “Too many controls”, and “TEST ENDED” will print and the mode will cancel.

After the first strip is read, the display shows “**C/O Abs OK Y/N**”. If the cutoff absorbance value is acceptable, press YES. “**C/O Abs is stored**” will print. If the cutoff absorbance value is not acceptable, press NO. If the test is stored, the display will show “**Recall test Y/N**”. If the test is not stored, the display will show “**Re start Y/N**”. In either case, press YES to run the test again, press NO to return to the “**C/O Abs OK Y/N**” prompt, or press the CLEAR key twice to cancel the mode.

The instrument will be ready for the next strip when it displays “**Set Carrier**” “**Then Press Enter**”. To continue reading in the C/O Control mode, load the next strip and press the ENTER key.

If you want to store this test in your user-test menu, be sure to store it prior to canceling (see section 2.3.1-Storing a Test). Press the CLEAR key twice to cancel the mode.

2.2.5 Regression Mode

Press the MULT key (multi-point modes) to access the regression mode. “**Regression Y/N**” will be displayed. Answer YES.

This mode calculates a best fit linear equation based upon the standard points. It is designed for use with either linear, logarithmic, or log-logit data, with absorbance on the y-axis and concentration on the x-axis.

After filter selection, you are prompted to select your axes type. There are five possible formats: Linear, Log Abs, Log Conc, Log/Log, and Log/Logit. The first choice displayed is “**Linear Y/N**”, where both the absorbance data (y) and the concentration data (x) are linear. Press YES to select, NO to continue. Next is “**Log Abs Y/N**” where the natural log of the absorbance*1000 is plotted against the concentration. Note that in logarithmic calculations, resulting concentrations will be the same no matter what logarithmic base is used (ln or log), but slopes and intercepts will vary. Press YES to select, NO to continue. Next is “**Log Conc Y/N**”, where absorbance is linear and concentration is logged. Press YES to select, NO to continue. Next is “**Log/Log Y/N**”, where the log is taken of both absorbance*1000 and concentration. Press YES to select, NO to continue. Next is “**Log/Logit Y/N**”, where a log/logit calculation is done. The first calibrator must be the 0 calibrator (instrument assigned), and have the darkest absorbance of all the calibrators. Press YES to select, NO to recycle the options.

After the blank and duplicate selections, the display prompts for the number of calibrators to be used by displaying “# of Cals = ”. The number of calibrators must be less than or equal to eight (seven with a blank). The display then prompts for unit selection.

The instrument will then prompt you to enter the calibrator values. As you enter the values, the printer will print:

“CAL 1= XXXX”

“CAL 2= XXXX”

“CAL 3= XXXX”.....

where XXXX represents the calibrator values you entered. Except for the log/logit mode, which requires increasing calibrator values and decreasing calibrator absorbance, the points may be entered in any order, but must be read in that same order for accurate pairing. The regression line may be used for both positive and negative slopes. The number of standards must be less than or equal to eight (seven with a blank).

NOTE: When using a format which calculates the ln of the concentration, do not use 0.0 for the concentration, since ln 0 is not defined. Likewise, when using ln of 1000*Abs, the absorbance values must be non-zero and positive.

Note that the instrument allows calibrator values up to 999999, and calibrators less than 1000 can have up to two places after the decimal point. Decimal places for the reported concentrations will be the same as those selected for calibrator 1.

After all the calibrator values have been entered, the display will prompt **“Off Curve Ok Y/N”**. Press YES if all samples are valid. Press NO to flag all samples having absorbance values higher than the highest calibrator or lower than the lowest calibrator. Note that the **“Off Curve”** flagging feature requires that the calibrators be entered and read from lowest concentration for calibrator #1 to highest concentration for the final calibrator.

“Set Carrier to X”, **“Then Press Enter”**, where X is either 1 or A, depending on the strip type. Load the first strip into the right-most carrier position and press ENTER. While the strip is being automatically positioned for reading, the display will indicate **“Positioning Strp”**.

After the strip or strips containing the standards are read, there will be a pause after the standard curve is read. Next, the slope and intercept of the linear regression will be printed. The correlation coefficient (r) will also be given as an aid in determining the acceptability of the curve. The display will prompt **“PLOT CURVE Y/N”**. To plot the regression line press YES. Press NO to continue without printing the curve.

If calibrators were read in duplicate, you may choose to edit the curve. The display will prompt **“DELETE WELLS Y/N”**. Use the YES or NO key to answer. If you press NO, the instrument will proceed to read and calculate the remainder of the strips. If you choose to edit the curve by pressing the YES key, the display will ask for the location of the well(s) that are to be deleted. Enter the wells one by one. You may delete as many as one from each pair, **but you may not delete an entire point**. When you have finished deleting wells, press the ENTER key again. The standard curve will be recalculated showing an “X” beside the deleted well(s). If one of a duplicate pair is deleted, the remaining point will be considered as the value for that standard. The new slope, intercept, and correlation coefficient will be printed. Again the operator will have an opportunity to see the graph and to edit. This may be repeated as many times as desired until either an acceptable curve is obtained, or the mode is canceled. To continue reading specimens, answer NO to the question **“DELETE WELLS Y/N”**.

The instrument will be ready for the next strip when it displays **“Set Carrier”**, **“Then Press Enter”**. To continue reading in the Regression mode, load the next strip and press the ENTER key. Press CLEAR twice to cancel the mode.

2.2.6 Point-to-Point Mode

Press the MULT key and answer NO to the display “Regression Y/N”. The next display is “Pt to Pt Y/N”. Press YES to select the point-to-point mode.

The Point-to-Point Mode is a multi-point calibrator mode that allows the operator to enter several different calibrator concentrations. These are used to calculate the concentrations of unknown samples according to Beer’s Law. The resulting calibrator curve is a series of line segments connecting the calibrator points. If you wish to use the point (0,0), you must include it as a calibrator.

Unknown samples are calculated as follows:

First, the unknown sample’s bichromatic differential absorbance is calculated and compared to the calibrator absorbances. Then, the line segment used for determining the concentration of the unknown is the one connecting the pair of standards whose absorbances are closest above and below the unknown absorbance. An unknown sample whose absorbance is greater than the greatest calibrator absorbance is calculated on the line passing through the greatest 2 calibrator points. Likewise, an unknown sample whose absorbance is less than the lowest calibrator absorbance is calculated on the line passing through the lowest 2 calibrator points.

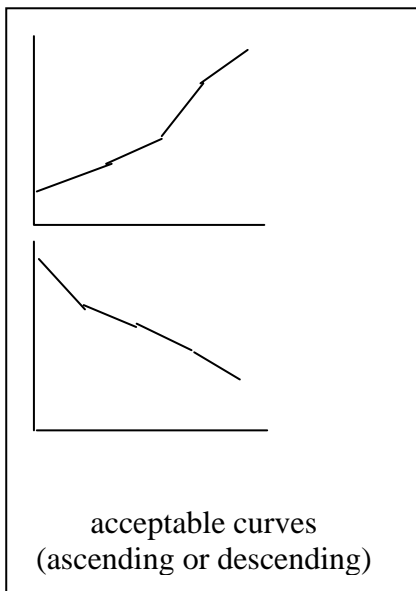

The calibrators’ absorbances must be either decreasing or increasing down the strip; i.e., if the first calibrator is the darkest, the second must be the next darkest, etc., and if the first calibrator is the lightest, the second must be the next lightest, etc.

After filter, blank, and duplicates selections, the display prompts for the number of standards to be used by displaying “# of Cals = ”. The number of standards must be less than or equal to eight (seven with a blank). The display then prompts for unit selection.

The display will then prompt you to enter the calibrator values. As you enter the values, the printer will print:

“CAL 1= XXXX”

“CAL 2= XXXX”

“CAL 3= XXXX”

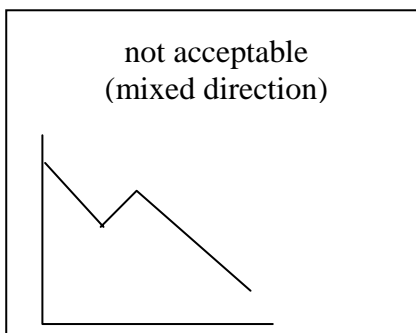

where XXXX represents the calibrator values you entered. Note that the instrument allows calibrator values up to 999999, and calibrators less than 1000 can have up to two places after the decimal point. Decimal places for the reported concentrations will be the same as those selected for calibrator 1.

After all the calibrator values have been entered, the display will prompt “Off Curve Ok Y/N”. Press YES if all samples are valid. Press NO to flag all samples having absorbance values

higher than the highest calibrator or lower than the lowest calibrator. Note that the “Off Curve” flagging feature requires that the calibrators be entered and read from lowest concentration for calibrator #1 to highest concentration for the final calibrator.

“Set Carrier to X”, “Then Press Enter” is displayed, where X is either 1 or A, depending on the strip type. Load the first strip into the right-most carrier position and press ENTER. While the strip is being automatically positioned for reading, the display will indicate “Positioning Strp”.

After the strip or strips containing the standards are read, there will be a pause after the standard curve is read. The display will prompt “PLOT CURVE Y/N”. Press YES to plot the curve. Press NO to continue without printing the curve.

If calibrators were read in duplicate, you may choose to edit the curve. The display will prompt “DELETE WELLS Y/N”. Use the YES or NO key to answer. If you press NO, the instrument will proceed to read and calculate the remainder of the strips. If you choose to edit the curve by pressing the YES key, the display will ask for the location of the well(s) that are to be deleted. Enter the wells one by one. You may delete as many as one from each pair, **but you may not delete an entire point**. When you have finished deleting wells, press the ENTER key again. The standard curve will be recalculated showing an “X” beside the deleted well(s). If one of a duplicate pair is deleted, the remaining point will be considered as the value for that standard. Again the operator will have an opportunity to see the graph and to edit. This may be repeated as many times as desired until either an acceptable curve is obtained, or the mode is canceled. To read and calculate specimens, answer NO to the question “DELETE WELLS Y/N”.

The instrument will be ready for the next strip when it displays “Set Carrier”, “Then Press Enter”. To continue reading in the Point-to-Point mode, load the next strip and press the ENTER key.

Press CLEAR twice to cancel the mode.

2.2.7 % Absorbance Multi-Point Mode

Press the %ABS key. The % Absorbance Multi-Point Mode (%A/A₀ Multi-Pt.) is a multi-point calibrator mode that allows the operator to enter several different calibrator concentrations. These are used to calculate the concentrations of unknown samples according to Beer’s Law. The resulting calibrator curve is a series of line segments connecting the calibrator points, which is similar to the point-to-point mode. In addition, the calibrator with the highest absorbance (A₀ calibrator) is assigned a value of 100%, and all samples have an additional reported value of 100*(sample Abs / A₀ Cal Abs).

Unknown samples are calculated as in the point-to-point mode (see section 2.2.6). The additional %A/A₀ calculation is made as above, and printed on a second sample data line.

Note: The calibrators’ absorbances must be decreasing down the strip; i.e., the first calibrator is the darkest, the second must be the next darkest, etc. The plotted curve shows absorbance vs. %A/A₀.

Note: If you are using a stored curve, you must still run the A₀ calibrator to recalibrate the stored curve. All samples will be calculated using the stored %A/A₀ values for the curve and the newly-run A₀ calibrator absorbance.

Except for the differences mentioned above, please follow the procedures for running the Point-to-Point mode to proceed in this mode.



2.2.8 Uptake Mode

The Uptake mode (UPT) is a modified Calibrator mode often required for uptake assays. Be careful to use your cutoff options correctly in this mode. In this mode, a factor is calculated by multiplying the absorbance of a single calibrator by its concentration. This factor is then divided by each subsequent absorbance to calculate the concentrations of unknown samples. No blank may be used and the calibrator must be in the first well. Note that this mode will neither print nor store the curve.

After filter, duplicates, and unit selections, the display prompts "**CAL1=**". Type in the calibrator concentration (up to 999999, up to two places after the decimal point for CAL1 < 1000) and press ENTER.

The display will then prompt "**Cal Limits Y/N**". Select NO to continue, or select YES to enter absorbance limits for the calibrator, the display will prompt "**Cal 1 >=**". Enter the minimum acceptable absorbance value for the calibrator.

"**Set Carrier to X**", "**Then Press Enter**" is displayed, where X is either 1 or A, depending on the strip type. Load the first strip into the right-most carrier position and press ENTER. While the strip is being automatically positioned for reading, the display will indicate "**Positioning Strp**".

The instrument will be ready for the next strip when it displays "**Set Carrier**", "**Then Press Enter**". To continue reading in the Uptake mode, load the next strip and press the ENTER key.

Press CLEAR twice to cancel the mode.

2.3 User Test Menu

This instrument offers the operator 8K bytes of non-volatile memory. This is user programmable memory (enough for about 31 tests) that will not be lost when the instrument is turned off. Test selections may be stored so that setup time is significantly reduced when the same assay is repeated. Curves are stored in all modes except Absorbance and Uptake. The time and date are maintained using this same type of memory.

Items in non-volatile memory may be entered, recalled, and deleted from memory by the operator following the instructions in this section.

There are several test numbers reserved for factory use. The user should not come across these in normal use; however, if one is inadvertently selected, it may be aborted by turning the instrument off and then back on.

2.3.1 Storing a Test

Tests are stored in a user test menu by number, with an option to store by name. The first test that you store will be test number 1; the next test will be test number 2, and so on. When you want to recall a test, you will be asked to enter the test number. A running list or log book should be kept with your instrument to help you identify your numeric entries. A sample format for this log can be found at the end of this manual. Each time you store a test, the instrument will assign the next available test number. Remember to update your log. The instrument will record the date and time that each test was stored or last modified.

The ALT key is used to save a test in the menu. Any time after you have made your general selections, but BEFORE either turning the instrument OFF or canceling the mode, you may press the ALT key to store a test. The display will ask “**SAVE TEST Y/N**”. Press the YES key and the display will ask “**NAME TEST Y/N**”. If you press the YES key, the display will show the first portion of a string of characters:

ABCDEFGHIJKLMN OPQRSTUVWXYZ 0123456789%-.

The flashing cursor indicates the selected character. Use the 4 key to move the string to the left and the 6 key to move to the right (continue scrolling to the right to access the rest of the text string). When the cursor is located on the first character of your test’s name, press the ENTER key. The display will show the letter chosen. Again, adjust the cursor, and press ENTER when you have the next letter selected. The display will show the name up to this point. If you make an error, press the CLEAR key and begin the name again. Continue until you have entered the test’s entire name (up to 12 characters), then press ENTER a second time while the name is shown in the display. The printer and display will indicate “**SAVED AS TEST #XX**”, where XX represents the next available number. The standard curve for an assay is saved with the test and may be used upon recall.

2.3.2 Deleting a Test

To remove a test from the user menu, press the ALT key. First you will see “SAVE TEST Y/N”. Press NO. Then you will see “STRIP TYPE Y/N”. Again, press the NO key. Now you will see “DELETE TEST Y/N”. Answer YES.

When you see “DELETE TEST” in the display again, type in the number of the test you wish to delete and press the ENTER key. The instrument will display “DELETE TEST Y/N”. Press YES to confirm the deletion of this test. The test number will then be available for the next user stored test. Be sure to update your log. The printout will also indicate “DELETED TEST # XX”. Pressing NO will abort the deletion.

To delete all user tests, press TEST and enter 183. “Erase Tests Y/N” will be displayed. If you select YES, the display will return to “Ready”. All stored tests will be cleared.

2.3.3 Recalling a Test

Use the MENU key to access the user test menu. The instrument will display “**SELECT TEST**”. Type in the number which identifies the desired test and press ENTER. Entering the number “99” will print your entire user menu.

When you select a stored test, its test parameters are printed for your review. In modes other than Absorbance and Uptake, the previous curve is also recalled. If a curve has been stored for a test, you are given the option of running a new curve and deciding whether to accept the new curve or use the previous curve. When you recall a test, you are first allowed to use the old curve (data will be printed and you may plot the curve). If you do not use the old curve, you must run a new curve. If at this point you do not want to accept the new curve, you can restart the test at the beginning, again with the option to use the old curve or run a new one.

NOTE: Since many assays require re-running calibrators, you must ensure that curve storage is appropriate for your assay. If using a stored curve is inappropriate, you should re-run your calibrators upon test recall by selecting NO when “STORED CURVE Y/N” is prompted.



2.4 Special Features

2.4.1 Clock and Calendar

To set the correct time and date, use the ALT key to access the command for setting the clock. When you press ALT, you will first see “**SAVE TEST Y/N**”. Press NO. Then you will see “**STRIP TYPE Y/N**”. Again, press the NO key. Now you will see “**DELETE TEST Y/N**”. Answer NO. Then you will see “**SET CLOCK Y/N**”. This time, press the YES key.

Depending upon the selected date format, the display will ask for the month, the day, and the year (last 2 digits), by displaying “**Date: MM.DD.YY**”, or the day, month, and year by displaying “**DD.MM.YY**”. Use two digits for each entry and separate the entries using the decimal point key. When the proper date is displayed, press ENTER.

The instrument will then display “**Time: HH.MM.SS**”, asking you to enter the hour (1-24), minutes, and seconds. Again, use two digits for each entry, and separate your entries using the decimal point key. When entering hour, use 13 for 1PM, 14 for 2PM, etc. Press ENTER when the displayed time is correct.

You may configure the reader to display the date either as day.month.year or as month/day/year. To select a date format, first press the MENU key and then enter test #100. The display will indicate the use of the 0 key to pick the MM/DD format and the use of the 1 key to select the DD.MM format. Use the 1 or 0 key to choose and then press ENTER. The display will return to “**Ready**”.

Once set, the time and date will not be lost when the instrument is turned off or unplugged. The time will be displayed whenever the instrument displays “**Ready**”. The time and date will be printed on all assay reports on either printer. The date last modified will be stored with each test in the menu.

2.4.2 Lamp Saver

To prolong the lamp life, the instrument is programmed to turn off the lamp automatically after a few minutes of idle time. The lamp automatically comes on when you enter a mode, or press ENTER to continue reading in a mode in which the lamp has timed out. You may also press “**AUX**” to turn lamp on or off. Pressing the ENTER key when “**Set Carrier**” is in the display will cause the lamp to turn on and warm up. After the lamp warms up for 45 seconds, the reader will proceed to operate in the previous mode with no need to re-blank or recalibrate.

2.4.3 Flags and Error Messages

Flags are printed messages or labels used to alert the operator of special conditions such as approaching limitations. After printing the warnings, the instrument will often continue to perform. It is the operator's responsibility to assess any implications. Error messages appear on the display when the instrument fails to continue to operate. These messages help the operator locate the cause of the problem since it must be overcome before proceeding. The Microstrip Reader employs these flags and error messages:

“**>3.00**” is reported in the absorbance field if a reading exceeds 3A.

“**>10**6**” is printed as the concentration value whenever the calculated result is greater than 6 digits and can not be properly printed in the concentration field.

“**CONTROLS FULL**” is displayed if a fourth control location is attempted.

“**Off Curve**” is printed when a sample value is greater than the highest calibrator or less than the lowest calibrator.

“**PRINTER JAM**” is displayed when the internal printer paper path is obstructed. It must be cleared before printing can resume. To avoid this problem, never feed paper backwards, and never load paper with a rough cut edge.

“**Mechanism Error**” and “**TEST ENDED**” are both displayed and printed when the strip can not be transported properly. This usually indicates improper strip loading, obstruction, or a mechanical failure. Use only standard size microstrips and microwells, and ensure they are seated firmly in the carrier.

“**Lamp/filter(s) low!**” is printed when less light than necessary is detected, which may indicate that the lamp's light is low or that the light through a specific filter is low. You will be given the option to continue to read, but this message may indicate decreased linearity. You may require lamp replacement or filter replacement. Call your dealer for service assistance if needed.

“**Reposition Carrier**” is printed if you attempt to use a carrier position other than the right-most for your first strip in a mode. Reposition the carrier to the right-most position and re-run.

“**No Carrier**” is printed if you press Enter to read when no carrier is loaded.

“**MEMORY IS FULL**” is displayed if you attempt to store more tests than are available.

“**DO ABS SET TEST 212!**” is printed when the factory set absorbance gain calibration has been lost from non-volatile memory. Instructions are located in Section 3.1, Restoring Electronic Calibration.

2.4.4 Differential Absorbances

This instrument requires the selection of two filters: the operating filter and a differential filter. Use of the bichromatic differential absorbance increases precision, since the element of variation that is caused by imperfections in plastic microtiter strips is removed from the results.

In order to preserve the sensitivity, however, it is important not to choose a differential filter where the chromophore being assayed exhibits substantial absorbance. A monochromatic option is available for use in scanning the filters independently. To look at only 1 filter, select 0 as the differential filter.

When reading monochromatically, the blank absorbance is elevated relative to the curvature of the meniscus. A correction, called “offset absorbance”, can be entered by the user to compensate for this effect.

To determine the correct offset absorbance, read a well of your blank material in the absorbance mode, monochromatically without blank or offset. Determine the difference between the observed and expected value. This is your offset absorbance.

When no differential filter is selected, the message “**OFFSET ABS Y/N**” is displayed. If you answer YES, you see “**OFFSET ABS =**”. Enter the value that should be subtracted from the observed blank absorbance.



2.4.5 Calibration and Linearity

Every instrument is calibrated during manufacture, using standards whose absorbance readings are traceable to the NIST. Each instrument is also tested to verify its linearity to 2A. No calibration adjustment is accessible to the operator, since the pre-set calibration is very stable. Absolute calibration can not be readily verified without using a specifically designed product called DRI-DYE® Check Strips, available from your instrument supplier. This is because in vertical photometry, the fill volume and degree of meniscus determine the pathlength, and absorbance is proportional to pathlength.

For lab test results that are based upon standards rather than upon absolute absorbances, the linearity of the instrument is the more critical indicator of instrument performance. A gradual reduction in linearity is indicative of filter degradation. If this occurs, filter replacement will be required for continued reliable operation. A monthly verification of instrument calibration and linearity is recommended. Such monitoring can be done using DRI-DYE Check Strips®. There is more information about DRI-DYE Check Strips® in the Appendix.

3.0 ADDITIONAL TIPS AND INFORMATION

3.1 Restoring Electronic Calibration

This instrument allows the entry of permanent calibration data by keyboard. This data is entered at the factory as the original calibration data and is maintained in the non-volatile RAM of the instrument. The data is also printed on the CALIBRATION DATA label affixed to the bottom of the unit.

DO NOT ALTER ANY POTENTIOMETER SETTING. SUCH ALTERATION RENDERS THE FACTORY CALIBRATION DATA INVALID!

If the calibration data is lost, the printout will show the message, “**DO ABS SET TEST #212!**”. If the data is not restored, the message will continue to be printed each time the unit is turned on and every time a new mode is selected or ended. The mode will operate, but calibration must be restored to assure accuracy.

If the date is lost, reenter the date and time **before** restoring the calibration data. Then, enter the data from the CALIBRATION DATA label by using the **MENU (.)** key and selecting test **212**. When the display prompts “**ABS FACTOR=**”, enter the number from the ABSORBANCE line.

If the message “**ADJUST OUT OF RANGE**” appears, simply re-enter the correct data. To print a report of the entered data, run test 213. The data in test 213 should match the data from the CALIBRATION DATA label.

Note: When the stored calibration data is lost, the absorbance factor is set to 1.000. The instrument will not accept a change greater than $\pm 10\%$ (.900 - 1.100) for the absorbance factor. If the calibration data is lost, these limits assure that the instrument requires only minimal adjustment from the keyboard to remain calibrated. Note that the number entered in test #212 is multiplied by the current absorbance factor (set to 1 when reset). Thus, running test #212 (and entering a factor) more than once will result in an incorrect absorbance factor. Confirm that the factor is correct by running test #213.

3.2 Operating Precautions

Most errors in clinical laboratory testing are due not to bad reagents or malfunctioning instrumentation but rather to operator error. We have taken several steps in the design of the Microstrip Reader to minimize operator error: stable factory calibration, automatic zeroing, complete operator prompting, detailed labeling, pre-programmed calculations, comprehensive visual and audible feedback, flags and error messages, and minimal maintenance requirements. The following precautions are offered to further assure quality laboratory results.

- Read your instrument instruction manual before performing patient testing, and then keep it handy as a reference. Be sure that you fully understand the purpose and limitations of this instrument. Use of the bichromatic differential absorbance, for instance, generally increases precision, since the element of variation caused by imperfections in disposable plastic strips is removed from the results. In order to preserve sensitivity, however, it is important to select the correct combination. It is also advisable to make dilutions of solutions that exceed 2.0A. You must also understand the relationship of read volume to absorbance.
- Use clean strips and follow the instructions for blanking and standardizing very closely. (Use of the appropriate blanking material is also very important...water alone is not always specified.) Do not read wells with bubbles or condensation.

- Check your display and printed results during operation. Your display and printer provide useful information such as the values you enter, the mode of operation you select, whether or not you remembered to blank, and all absorbance readings. Monitoring the printer and display during operation may help you detect an error in the making.
- Check the calibration and linearity of your instrument against some standard reference periodically. DRI-DYE® Check Strips are recommended.
- Appropriate controls should be run with each assay as indicated in the package inserts of the chemistry products used. If controls do not give expected results, the assay is invalid.

3.3 Maintenance

It is important to follow the installation instructions carefully, using only a suitable power supply and placing the instrument with the proper clearance for good air circulation around it. Excessive vibration should be avoided. During shipments, use the original packing material or other suitable protective foam.

This reader is essentially a maintenance free instrument. To ensure maximum trouble free operation, the instrument need only be kept dry. Although the filters are well sealed, their life may be decreased if the instrument is maintained in a very humid environment (greater than 80% humidity). Using the instrument in an air conditioned room is recommended for humid climates. Extreme temperature shock is also harmful to the filters. Maximum changes of 5°C per minute are recommended especially at the lower limits of -50°C, where permanent damage may occur. The upper limits of adequate performance for the filters are 120°C. The instrument is designed for use at 20°C and performs according to specifications in the range of 18-35°C.

Cleaning should be done only when obviously necessary. Use a dry cloth or duster to remove dry dust and dirt. Use only a slightly damp, soft cloth to clean up spills. Water or 70% isopropanol may be used to dampen the cloth. Use of other chemicals or abrasive scrubbing may damage the cover. Be careful not to soak liquids up under the keyboard overlay. If this happens, simply allow the keyboard to dry before resuming operation. Such a spill does not present a hazard, but may cause temporary malfunction of the keys.

3.4 Troubleshooting

Using the following guidelines, simple problems can often be isolated and corrected by the operator. If your instrument continues to malfunction, you may need to speak with someone from technical services for more information, or send your instrument to be repaired. Service and repair work should be performed only by trained service personnel. Consult your dealer to make arrangements if service is needed.

Problem: “**Mechanism Error**” message is displayed.

Solution: Turn the instrument off for about 5 seconds. When you turn it back on, the cup holder may be driven out very slowly towards the front.

IF THE INSTRUMENT CONTINUES TO MALFUNCTION, CALL YOUR DEALER TO ARRANGE FOR SERVICE.

Problem: “**PRINTER JAM**” is displayed.

Solution: This is usually caused by a small piece of paper lodged between the flying print head and the side of the printer mechanism. Turn the instrument off. Reach into the printer mechanism with a pair of tweezers, and carefully remove the paper. Take care not to damage the Teflon pressure bar located behind the print head. If you are unable to clear the jam, call your dealer to arrange for service.

You may continue to use the instrument, but results will not be printed on the internal printer. After each well is read, the result will remain on the display to permit the user to note the result. Press ENTER to advance the strip to the next well.

Problem: The lamp does not light.

Solution: Lamp replacement is an infrequent event, since the lamp is rated to read over 50,000 strips, and your lamp saver feature minimizes idle time. Lamp replacement is indicated if the lamp does not light, or if the lamp output flag is printed. Call your dealer to arrange for lamp replacement service.

Problem: The instrument is several years old and has lost some linearity with time.

Solution: You may need new filters. Return the instrument for replacements. To retard the deterioration of filters, store in an air conditioned environment, and do not expose to severe temperature shock. Call your dealer to arrange for service.

Problem: Incorrect answers are obtained.

Solution:

- a. Check that the procedures and materials used were valid. Turbid or contaminated reagents, for example, may affect absorbance readings. Be sure that you are reading in the specified range of the instrument, and using an appropriate chromophore. Wells should not have bubbles, condensation, severe scratches or smudges.
- b. Review the procedure for blanking. Remember to use the same volume for the blank and the samples.
- c. Be certain that reagents are dispensed into the correct wells. Refer to the operating instructions for each mode regarding correct placement of the blank and calibrator materials.

d. Check the tapes to be sure that no flags were printed that would indicate improper results. (See section 2.4.3 for a review of flags and error messages.)

IF THE INSTRUMENT CONTINUES TO MALFUNCTION, CALL YOUR DEALER TO ARRANGE FOR SERVICE.

Problem: The instrument lacks reproducibility.

Solution:

a. Check that the substance is not affected by the warming of the lamp. First, perform the instrument **CHECK OUT PROCEDURE** in section 1.5.4 to ensure proper operation. If the instrument is acceptable, insert a strip with water in all wells, read it several times, and observe whether or not the “drifting” disappears. A strip of 12 wells of uniformly pipetted water, read in the absorbance mode and blanked on the first well, should consistently provide results within $\pm 0.01A$.

b. Very high absorbance readings are “noisier” than lower readings. Be sure you are operating within the acceptable range of the instrument. For best results, make dilutions of very dark samples before reading.

c. Perform the check out procedure to verify good repeatability when reading air.

Problem: The printing is dim or incomplete.

Solution: Use only the specified paper available from your dealer.

Problem: The normal operation of the instrument is suddenly interrupted.

Solution: As with all microprocessor-controlled devices, fluctuations and interruptions of the power supply may cause the Microstrip Reader to fail. The keys may not respond to touch, and the display may remain fixed. Turn the power switch off and wait for about 5 seconds. Then turn it back on. The instrument will start up normally.

If this interruption to normal operation occurs with frequency, you should try plugging your instrument into a different circuit. Choose a circuit that is free of large transient voltages such as pumps, refrigerators, etc. If this is not possible, install a commercially available surge protector (or noise filter).

Problem: The external printer fails to print.

Solution: Once you are certain that it is turned on, consult the printer manual for the correct dip switch settings. Refer to sections 1.5.3 of this manual for more information about printer requirements. If only one setting is wrong, the printer will either print nonsense characters or nothing at all.

Support is available to help you solve any technical problem or question with this instrument. Please call, fax, or write your dealer for immediate attention.

3.5 References

1. Interference filter temperature and humidity recommendations adapted from: Melles Griot Optical Guide 3, (1985) pp 266-269.
2. Other engineering data supplied by Awareness Technology, Inc., Palm City, FL (1987-2006).
3. Data on Dri-Dye® Check Strips provided by Awareness Technology, Inc., Palm City, FL (1988-2006).



Notes:

4.0 APPENDICES

Appendix 1 contains information concerning Dri-Dye® Check Strips, which can be used to verify proper calibration and linearity of your Microstrip Reader instrument.

Appendix 2 is a sheet which may be used to document your stored menu tests.

Appendix 3 is a set of sample printouts of data from each calculation mode. Some modes have been set up to show various options available in many modes, such as control location, blank location, duplicate options, curve plotting, and cutoff interpretations.

Appendix 4 provides contact information in the event the user has questions regarding instrument operation.



DRI-DYE®

CHECK STRIPS

Dri-Dye Check Strips® offer an easy means of verifying proper calibration and linearity on a routine basis. If a strip reader can obtain acceptable results with this kit, then the instrument demonstrates **linearity, calibration, filter integrity, repeatability, and lack of stray light**. Therefore, proper use of Dri-Dye Check Strips® is recommended to assure long term instrument performance verification.

Dri-Dye Check Strips® contain 5 absorbance levels of predisposed chromophore with NIST traceable absorbance values assigned. Simply add water, wait, mix, and read.

Using predisposed dyes reduces the degree of pipetting precision required to reconstitute the check set strips. Since the strip reader looks through the sample from top to bottom, volume is proportional to pathlength and hence to absorbance. If a well is reconstituted with too much water, the decrease in concentration will be corrected by the increase in pathlength. In fact, the system is self-correcting for random pipetting errors up to 10%.

The charts and graphs provided in the kit allow instant interpretation of results, because they are designed to replace the normal calculations with easy to visualize, built-in acceptance ranges.

DRI-DYE® Check Strips can be ordered from your dealer.

Available for the following wavelengths:

DRI-DYE® Check Strips-405 - for 405nm

DRI-DYE® Check Strips-450 - for 450nm

DRI-DYE® Check Strips-492 - for 492nm

4.3 Appendix 3: Sample Printouts

02/06/01 13:17
 Absorbance Mode 12
 Filters: 405 630nm

Blank(s) in Well 1

 Well Abs

 Strip: A
 Carrier Position A
 1 B 0.1370
 2 0.1599
 3 0.2855
 4 0.4422
 5 0.5444
 6 0.6622
 7 0.8200
 8 0.9899
 9 1.1599
 10 1.2055
 11 1.3100
 12 1.4233

02/06/01 13:26
 Calibrator Mode 8
 Filters: 405 630nm
 Duplicate Calibrtr
 Blank(s) in Well 1
 Call 1 = 50.00 AU/mL
 Cal 1 >= 0.50 Abs

Pos >= 25.00 AU/mL
 Neg < 20.00 AU/mL
 Hi C at= 0
 Hi C >= 50.00 AU/mL
 Lo C < 25.00 AU/mL

Well Abs AU/mL I

 Strip: 1
 Carrier Position 1
 1 0.001 0.000
 2 1.064 50.000
 3 0.974 50.000
 4 0.747 36.680
 5 0.681 34.420
 6 0.437 21.440
 7 0.333 16.460
 8 0.241 11.050

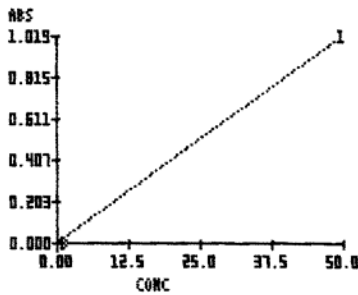

02/06/01 13:51
 Cutoff Ctrl Mode 8
 Filters: 405 630nm
 Blank(s) in Well 1
 blank <= 1.1000 Abs
 Neg <= 0.9000 Abs
 Num. of NCS = 1
 Neg. C. <= 0.2000 Abs
 Num. of CCs = 3
 Pos. C. <= 0.2500 Abs
 Num. of PCs = 2
 Neg. C. <= 0.2500 Abs
 Num. of PCs = 2
 Pos. C. >= 0.5000 Abs
 Well Abs Index I

Strip: 1
 Carrier Position 1
 B 0.000
 NC 0.177
 NC(2) = 0.183
 PC 1.077
 PC(2) = 1.284
 PC(2) = 1.100
 C/O Abs = 0.190
 1 0.575 1.900
 2 0.514 1.700
 3 0.469 1.500
 Curve is stored

Strip: 2
 Carrier Position 2
 4 0.500 1.490
 5 0.000 0.000
 6 0.000 0.000
 7 0.157 0.550
 8 0.222 0.800
 9 0.263 0.800
 10 0.307 1.000
 11 0.307 1.000

02/07/01 16:00
 Cutoff Ctrl Mode 8
 Filters: 405 630nm
 Blank <= 0.6500 Abs
 Pos >= 1.1000 Abs
 Neg <= 0.9000 Abs
 Num. of NCS = 1
 Neg. C. <= 0.2000 Abs
 Num. of CCs = 3
 Pos. C. <= 0.2500 Abs
 Num. of PCs = 1
 Neg. C. <= 1.0000 Abs
 Pos. C. >= 1.0000 Abs
 Corr Fac 2.750
 P-M N >= 1.0000

Well Abs Index I

Strip: 1
 Carrier Position 1
 B 0.019
 NC 0.148
 NC(1) = 0.148
 CC(1) = 0.782
 CC(2) = 0.731
 CC(3) = 0.778
 PC(1) = 1.533
 PC(1) = 1.533
 C/O Abs = 0.533
 1 0.198 0.700
 2 0.796 1.300
 Curve is stored

Total wells = 4
 Strip: 2
 Carrier Position 1
 4 0.740 1.100
 5 0.661 1.100
 6 0.624 1.000
 7 0.370 0.600

02/13/01 09:59
 Pt to Pt 8
 Filters: 450 630nm
 Duplicate Calibrtr
 Cal1 = 25.00
 Cal2 = 50.00
 Cal3 = 75.00
 Cal4 = 100.00
 Flag Off Curve

Pos >= 60.0 Conc
 Neg < 40.0 Conc

Well	Abs	Conc	I
Strip: 1			
Carrier Position 1			
A	C1	1.728	0.00
%A/Ao= 100.0			
B	C2	1.041	25.00
%A/Ao= 60.2			
C	C3	0.463	50.00
%A/Ao= 26.7			
D	C4	0.085	100.00
%A/Ao= 4.9			
E	1	0.947	29.07
%A/Ao= 54.7			
F	2	1.479	9.06
%A/Ao= 85.5			
G	3	0.231	80.74
%A/Ao= 13.3			
H	4	0.777	36.42
%A/Ao= 44.9			

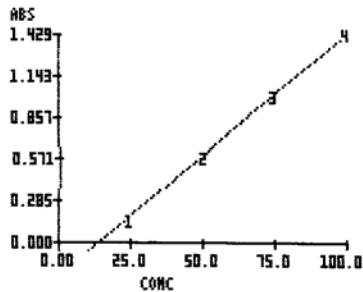

Curve is stored

Carrier	Position	2	OFF
1	0.083	29.07	FF
2	0.151	29.07	FF
3	0.247	29.07	FF
4	0.578	29.07	FF
5	0.635	29.07	FF
6	0.778	29.07	FF
7	0.621	29.07	FF
8	0.256	29.07	FF

02/07/01 16:37
 %A/Ao Multi-Pt 8
 Filters: 405 630nm
 Cal1 = 25.00
 Cal2 = 50.00
 Cal3 = 75.00
 Cal4 = 100.00

Well Abs Conc I

Well	Abs	Conc	I
Strip: 1			
Carrier Position 1			
A	C1	1.728	0.00
%A/Ao= 100.0			
B	C2	1.041	25.00
%A/Ao= 60.2			
C	C3	0.463	50.00
%A/Ao= 26.7			
D	C4	0.085	100.00
%A/Ao= 4.9			
E	1	0.947	29.07
%A/Ao= 54.7			
F	2	1.479	9.06
%A/Ao= 85.5			
G	3	0.231	80.74
%A/Ao= 13.3			
H	4	0.777	36.42
%A/Ao= 44.9			

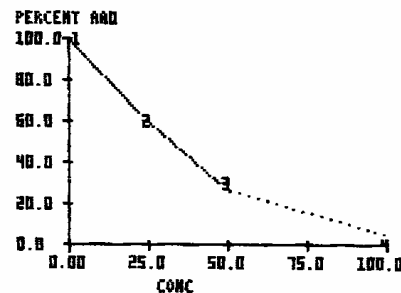

02/07/01 16:30
 Regression 8
 Filters: 405 630nm
 Linear
 Duplicate Calibrtr
 Blank(s) in Well 1
 Cal1 = 25.00
 Cal2 = 50.00
 Cal3 = 100.00

Pos >= 50.0 Conc
 Neg < 40.0 Conc
 Hi C. at: H 1
 HC Hi >= 200.0 Conc
 HC Lo < 50.0 Conc

Well	Abs	Conc	I
Strip: 1			
Carrier Position 1			
A	B	0.000	0.00
B	C1	0.266	25.00
C	C2	0.222	50.00
D	C3	0.616	100.00
E	1	1.169	180.00
F	C3	0.982	160.00
G	HC	1.586	147.5 P

r = 0.994 y c = 0.051
 slope = 0.01043

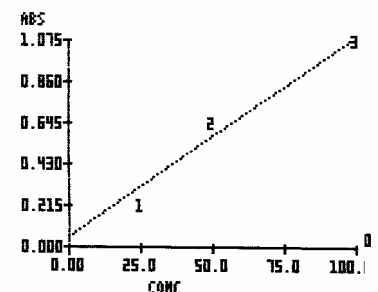

Curve is stored

Carrier	Position	3	FF
1	0.222	50.00	FF
2	0.177	50.00	FF
3	0.774	69.50	FF
4	0.733	66.00	FF
5	0.700	70.00	FF
6	1.144	144.2	FF
7	0.214	15.7	FF
8	0.781	70.1	FF

4.4 Appendix 4: Contact Information

In the unlikelyhood that you should ever experience a problem with your instrument, please consult your dealer first.

Dealer:

If the dealer is unable to resolve the problem, support staff at Awareness Technology is happy to assist you, and can be reached in the United States by:

- Phone: (772) 283-6540
- Fax: (772) 283-8020
- e-mail: support@awaretech.com
- Mailing address: Awareness Technology, Inc.

P.O. Drawer 1679
Palm City, FL 34991
USA

When contacting us, please provide the following:

- the serial number of the instrument
- a description of the problem with as much detail as possible
- printouts, which can be submitted to us by mail, fax or email.