

KENWOOD

CD-RECEIVER

KDC-W9537U
KDC-W9537UY

INSTRUCTION MANUAL

Kenwood Corporation



Contents

Safety precautions	3	CD/Audio file (USB/iPod/Internal Memory) control features	26	Local Seek	
Notes	4	Playing CD & Audio file		Tuning Mode	
General features	8	Playing USB (iPod) device		AF (Alternative Frequency)	
Power		Playing Internal Memory		Restricting RDS Region (Region Restrict Function)	
Selecting the Source		Playing External Disc		Auto TP Seek	
Volume		Pause and play		Monaural Reception	
Attenuator		Drive Search		Auxiliary Input Display Setting & Disc Naming	
Audio Control		Fast Forwarding and Reversing		Selecting Russian Characters	
Audio Setup		Music Search		Text Scroll	
Subwoofer Output		Disc Search/Folder/Album Search		Built-in Auxiliary input Setting	
Loudness		Direct Music Search		Power OFF Timer	
Supreme Setting		Direct Disc Search		CD Read Setting	
TEL Mute		Play function of CD and Audio file		Picture downloading	
Function Control mode		File Select		Firmware version display	
Sound Management system		Disc Naming (DNPS)		Internal Memory Format	
Position Control		Text/Title Scroll		Demonstration mode setting	
Equalizer Control		Recording & Downloading	32	Basic Operations of remote control	47
WOW HD Control		About Internal Memory		Accessories/ Installation Procedure	49
Memory mode		Copying from USB device		Connecting Wires to Terminals	50
Memory Recall mode		Setting the recordable time		Installation/ Removing the Unit	52
Display Type Selection		Recording music CD		Troubleshooting Guide	53
Status Setting		Deleting files in memory		Specifications	56
Graphic Display Selection		Menu system	37		
Text Display Selection		Menu System			
The text display		Security Code			
Font Color Selection		Source Select Mode			
Icon Display Switching		iPod mode setting			
External Display Selection		Touch Sensor Tone			
Angle Control		Manual Clock Adjustment			
Theft Deterrent Faceplate		Date Adjustment			
Tuner features	21	Date Mode			
Tuning		Synchronize Clock			
Direct Access Tuning		DSI (Disabled System Indicator)			
Station Preset Memory		Display Illumination Control			
Auto Memory Entry		Dimmer			
Preset Tuning		Contrast Adjustment			
RDS features	23	Display-reversing Setting			
Traffic Information		Built-in Amp Setting			
Radio Text Scroll		Dual Zone System Setting			
PTY (Program Type)		B.M.S. (Bass Management System)			
Program Type preset		B.M.S. Frequency Offset			
Changing Language for PTY Function		AMP Control			
		News Bulletin with Timeout Setting			

Safety precautions

⚠ WARNING

To prevent injury or fire, take the following precautions:

- To prevent a short circuit, never put or leave any metallic objects (such as coins or metal tools) inside the unit.
- Do not watch or fix your eyes on the unit's display when you are driving for any extended period.
- Mounting and wiring this product requires skills and experience. For safety's sake, leave the mounting and wiring work to professionals.

⚠ CAUTION

To prevent damage to the machine, take the following precautions:

- Make sure to ground the unit to a negative 12V DC power supply.
- Do not install the unit in a spot exposed to direct sunlight or excessive heat or humidity. Also avoid places with too much dust or the possibility of water splashing.
- Do not place the faceplate (and the faceplate case) in areas exposed to direct sunlight, excessive heat or humidity. Also avoid places with too much dust or the possibility of water splashing.
- To prevent deterioration, do not touch the terminals of the unit or faceplate with your fingers.
- Do not subject the faceplate to excessive shock, as it is a piece of precision equipment.
- When replacing a fuse, only use a new fuse with the prescribed rating. Using a fuse with the wrong rating may cause your unit to malfunction.
- Do not apply excessive force to the open faceplate or place objects on it. Doing so will cause damage or breakdown.
- Use only the screws provided or specified for installation. If you use wrong screws, you could damage the unit.

Attach the panel while you are on the vehicle

The panel lock arm appears when the panel is removed. Therefore, the panel must be attached while the electrical system of the car is operating.

Do Not Load 8 cm (3 in.) CDs in the CD slot

If you try to load a 8 cm (3 in.) CD with its adapter into the unit, the adapter might separate from the CD and damage the unit.

About CD players/disc changers connected to this unit

Kenwood disc changers/ CD players released in 1998 or later can be connected to this unit.

Refer to the catalog or consult your Kenwood dealer for connectable models of disc changers/ CD players. Note that any Kenwood disc changers/ CD players released in 1997 or earlier and disc changers made by other makers cannot be connected to this unit.

Connecting unsupported disc changers/CD players to this unit may result in damage.

Set the "O-N" Switch to the "N" position for the applicable Kenwood disc changers/ CD players.

The functions you can use and the information that can be displayed may differ depending on the models being connected.



- You can damage both your unit and the CD changer if you connect them incorrectly.

Lens Fogging

When you turn on the car heater in cold weather, dew or condensation may form on the lens in the CD player of the unit. Called lens fogging, this condensation on the lens may not allow CDs to play. In such a situation, remove the disc and wait for the condensation to evaporate. If the unit still does not operate normally after a while, consult your Kenwood dealer.

Notes

- If you experience problems during installation, consult your Kenwood dealer.
- When you purchase optional accessories, check with your Kenwood dealer to make sure that they work with your model and in your area.
- Characters that conform to ISO 8859-1 can be displayed.
- Characters that conform to ISO 8859-5 or ISO 8859-1 can be displayed. Refer to <Selecting Russian Characters> (page 44). (Russian sales area of KDC-W9537UY)
- The RDS feature won't work where the service is not supported by any broadcasting station.
- In this document, the description indicator will light means a status is displayed. Refer to <Display Type Selection>(page 16) for the details of the status display.
- The illustrations of the display, the function icon and the panel appearing in this manual are examples used to explain more clearly how the controls are used. Therefore, what appears on the display in the illustrations may differ from what appears on the display on the actual equipment, and some of the illustrations on the display may be inapplicable.

How to reset your unit

- If the unit fails to operate properly, press the Reset button. The unit returns to factory settings when the Reset button is pressed.
- Remove the USB device before pressing the Reset button. Pressing the Reset button with the USB device installed can damage the data contained in the USB device. For how to remove the USB device, refer to <Playing USB (iPod) device> (page 26).
- Stop recording and copying before pressing the reset button. If the reset button is pressed while writing to the internal memory such as when recording or copying, the data in the internal memory may be damaged. Refer to <Recording music CD>(page 34) and <Copying from USB device>(page 33) for information on canceling recording or copying.
- Press the reset button if the disc auto changer fails to operate correctly. Normal operation should be restored.

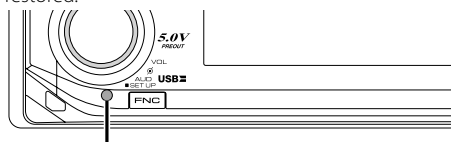

Reset button

Cleaning the Unit

If the faceplate of this unit is stained, wipe it with a dry soft cloth such as a silicon cloth.

If the faceplate is stained badly, wipe the stain off with a cloth moistened with neutral cleaner, then wipe it again with a clean soft dry cloth.



- Applying spray cleaner directly to the unit may affect its mechanical parts. Wiping the faceplate with a hard cloth or using a volatile liquid such as thinner or alcohol may scratch the surface or erase characters.

Cleaning the Faceplate Terminals

If the terminals on the unit or faceplate get dirty, wipe them with a clean soft dry cloth.

Before using this unit for the first time

This unit is initially set on the Demonstration mode.

When using this unit for the first time, cancel the <Demonstration mode Setting> (page 46).

About KENWOOD "Music Editor" of PC application attached to KDC-W9537U/W9537UY

- "Music Editor" is recorded in the CD-ROM attached to this unit.
- Refer to the attached installation manual for the installation method of "Music Editor".
- Refer to the user's manual recorded in the installation CD-ROM and Help of "Music Editor" for the operation method of "Music Editor".
- The unit can play CD/ USB device created by "Music Editor".
- Information about "Music Editor" upgrade is put on the site, www.kenwood.com.

About Audio file

• Playable Audio file

AAC-LC (.m4a), MP3 (.mp3), WMA (.wma), WAV (.wav)

• Playable disc media

CD-R/RW/ROM

• Playable disc file format

ISO 9660 Level 1/2, Joliet, Romeo, Long file name.

• Playable USB device

USB mass storage class, iPod with KCA-iP200

• Playable USB device file system

FAT16, FAT32

Although the audio files are complied with the standards listed above, the play maybe impossible depending on the types or conditions of media or device.

• Playing order of the Audio file

In the example of folder/file tree shown below, the files are played in the order from ① to ⑩.

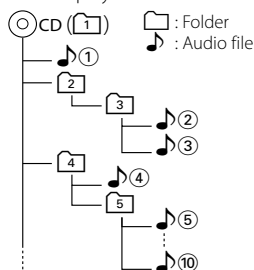

An online manual about audio files is put on the site, www.kenwood.com/audiofile/. On this online manual, detailed information and notes which are not written in this manual are provided. Make sure to read through the online manual as well.



- In this manual, the word "USB device" is used for flash memories and digital audio players which have USB terminals.
- The word "iPod" appearing in this manual indicates the iPod connected with the KCA-iP200 (optional accessory). The iPod connected with the KCA-iP200 can be controlled from this unit. iPods that can be connected with the KCA-iP200 are the iPod nano and the iPod with video. When an iPod is connected using a commercially available USB cable, it is handled as a mass-storage-class device.
- For the supported formats and types of USB device, refer to www.kenwood.com/usb/.

About USB device

- Install the USB device in the place where it will not prevent you from driving your vehicle properly.
- You cannot connect a USB device via a USB hub.
- Take backups of the audio files used with this unit. The files can be erased depending on the operating conditions of the USB device. We shall have no compensation for any damage arising out of erasure of the stored data.
- No USB device comes with this unit. You need to purchase a commercially available USB device.
- For how to play the audio files recorded in a USB device, see <CD/Audio file (USB/iPod/Internal Memory) control features> (page 26).
- When connecting the USB device, usage of the CA-U1EX (option) is recommended. Normal playback is not guaranteed when a cable other than the USB compatible cable is used. Connecting a cable whose total length is longer than 5 m can result in abnormal playback.

About ODD (Offset Dual Differential) D/A System

The high quality sound play is to be done by ODD D/A System. Dual D/A converters are built-in the ODD D/A System, and the digital processing is isolated and controlled separately for front channel so the channel separation is improved sharply.

Also, the ODD D/A System produces the data by which the sound data is offset on the minus side and converts the two signals (original and offset data) to the analog signal, which has less noise and distortion, by the synthetic process.

However, ODD D/A System will be disabled if the following settings are selected.

- When "2 ZONE" of <Audio Setup> (page 9) is "ON".

About DAB Tuner control

Refer to [A] group on the Instruction manual of DAB Tuner KTC-9090DAB (optional accessory) for the control method of DAB Tuner function.

However, the following control methods of the function for this unit may be differed from the Instruction manual; therefore, refer to the following supplemental instruction.

<Auto Ensemble Memory Entry>

1. Select the preset band for Auto Ensemble Memory Entry.
2. Press the [AME] button for at least 2 seconds. Open Auto Ensemble Memory Entry. After storing in the memory finishes, the number of the pre-set buttons and the ensemble label are displayed.

<Service Preset Memory>

For how to operate Memory, refer to <Station Preset Memory> in this instruction manual.

<Recalling a Preset Service>

For how to operate Recall, refer to <Preset Tuning> in this instruction manual.

<Changing the preset programme types>

For how to operate PTY preset, refer to <Program Type preset> in this instruction manual.

<Searching by programme type and language> and <Languages to be displayed> in <Programme Type (PTY) Function>

At the operation to press [DISP] button, use [TI] button instead.

About Bluetooth Hands free control

Refer to the instruction manual of the Bluetooth Hands Free Box KCA-BT100 (optional accessory).

However, the following control methods of the function for this unit may be different from the Instruction manual; therefore, refer to the following supplemental instruction.

<Dialing by Using the Quick Dialing Function>

1. Press the Control knob. Select the "DIAL" display.
2. Press the [FNC] button.
3. Select the number to recall by turning the Control knob.
4. Press the Control knob.

<Registering to the Preset Dial Number List>

1. Operation is the same. Refer to the instruction manual of KCA-BT100.
2. Press the [FNC] button.
3. Select the number to memory by turning the Control knob.
4. Press the Control knob for at least 1 second.

<Deleting a Registered Cell-Phone>

- 1-3. Operation is the same. Refer to the instruction manual of KCA-BT100.
4. Press the Control knob.
5. Select "YES" using the Control knob.
6. Press the Control knob.
7. Press the [FNC] button.

About Menu operation

For how to operate Menu, refer to <Menu System> in this instruction manual. For the items to be set up, refer to the instruction of Hands Free Box.

About display of Cell-Phone Status

Cell-Phone Status is displayed in the status display of this unit. For the information about the displayed icons, refer to the instruction manual of Hands Free Box. Bluetooth connection status cannot be displayed.

Handling CDs

- Do not touch the recording surface of the CD.
- Do not stick tape etc. on the CD, or use a CD with tape stuck on it.
- Do not use disc type accessories.
- Clean from the center of the disc and move outward.
- When removing CDs from this unit, pull them out horizontally.
- If the CD center hole or outside rim has burrs, use the CD only after removing the burrs with a ballpoint pen etc.

CDs that cannot be used

- CDs that are not round cannot be used.

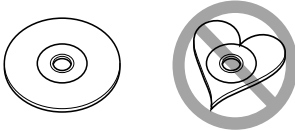

- CDs with coloring on the recording surface or CDs that are dirty cannot be used.

- This unit can only play the CDs with . This unit may not correctly play discs which do not have the mark.

- You cannot play a CD-R or CD-RW that has not been finalized. (For the finalization process refer to your CD-R/CD-RW writing software, and your CD-R/CD-RW recorder instruction manual.)

This Product is not installed by the manufacturer of a vehicle on the production line, nor by the professional importer of a vehicle into an EU Member State.

Information on Disposal of Old Electrical and Electronic Equipment (applicable for EU countries that have adopted separate waste collection systems)



Products with the symbol (crossed-out wheeled bin) cannot be disposed as household waste.

Old electrical and electronic equipment should be recycled at a facility capable of handling these items and their waste byproducts. Contact your local authority for details in locating a recycle facility nearest to you. Proper recycling and waste disposal will help conserve resources whilst preventing detrimental effects on our health and the environment.

The marking of products using lasers (Except for some areas)

CLASS 1 LASER PRODUCT

The label is attached to the chassis/case and says that the component uses laser beams that have been classified as Class 1. It means that the unit is utilizing laser beams that are of a weaker class. There is no danger of hazardous radiation outside the unit.

WOW HD, SRS and  symbol are trademarks of SRS Labs, Inc. WOW HD technology is incorporated under license from SRS Labs, Inc.

iPod is a trademark of Apple, Inc., registered in the U.S. and other countries.

The "AAC" logo is trademark of Dolby Laboratories.

General features

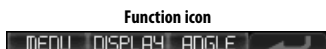
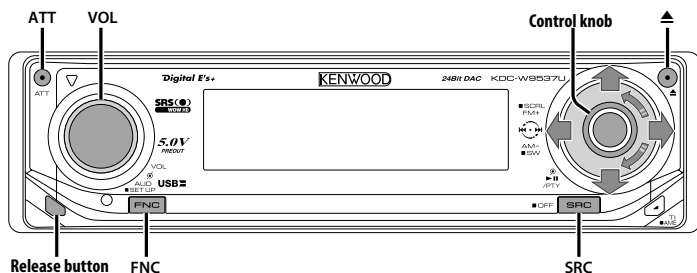

Power

Turning ON the Power

Press the [SRC] button.



- When the power is ON, the <Security Code> (page 38) is displayed as "CODE ON" or "CODE OFF".

Turning OFF the Power

Press the [SRC] button for at least 1 second.

Selecting the Source

There are two types of source selection methods depending on the setting.

SRC Select mode 1:

- 1 Press the [SRC] button.
- 2 Turn the Control knob or push it towards left or right.
- 3 Press the Control knob.

SRC Select mode 2:

Press the [SRC] button.

Source required	Display
Tuner	"TUNER"
USB device (iPod)	"USB" ("iPod")
Internal Memory	"Internal Memory"
CD	"Compact Disc"
External disc (Optional accessory)	"CD Changer"
Auxiliary input	"AUX"
Auxiliary input (Optional accessory)	"AUX EXT"
Standby (Illumination only mode)	"STANDBY"



- This unit automatically turns full power OFF after 20 minutes lapses in Standby mode in order to save the vehicle's battery.
The time until full power OFF can be set in <Power OFF Timer> (page 44).
- When connection of the iPod is recognized, the source display changes from "USB" to "iPod".
- Switch between SRC Select mode 1 and 2 in <Source Select mode> (page 38).
- USB (iPod) or Internal Memory source is recognized as CD source on the connected unit.

Volume

Increasing Volume

Turn the [VOL] knob clockwise.

Decreasing Volume

Turn the [VOL] knob counterclockwise.

Attenuator

Turning the volume down quickly.

Press the [ATT] button.

Each time you press the button, the Attenuator turns ON and OFF.

When the Attenuator is ON, the "ATT" indicator blinks.

Audio Control

1 Select the source to adjust

Press the [SRC] button.

Refer to <Selecting the Source> (page 8).

2 Enter Audio Control mode

Press the [VOL] knob.

3 Select the Audio item to adjust

Press the [VOL] knob.

Each time you press the knob, the item to be adjusted alternates between the items shown in the table below.

4 Adjust the Audio item

Turn the [VOL] knob.

Adjustment Item	Display	Range
Rear Volume	"REAR VOLUME"	0 — 35
Subwoofer level	"SUBWOOFER LEVEL"	-15 — +15
Balance	"BALANCE"	Left 15 — Right 15
Fader	"FADER"	Rear 15 — Front 15

Exit Audio Control mode. (Volume control mode)

5 Exit Audio Control mode

Press any button.

Press a button other than the [VOL] knob, [▲] and [ATT] button.

Audio Setup

Setting the Sound system, such as Volume offset and Dual Zone.

1 Select the source to adjust

Press the [SRC] button.

Refer to <Selecting the Source> (page 8).

2 Enter Audio Setup mode

Press the [VOL] knob for at least 1 second.

3 Select the Audio Setup item to adjust

Press the [VOL] knob.

Each time you press the knob, the item to be adjusted alternates between the items shown in the table below.

4 Setup the Audio item

Turn the [VOL] knob.

Adjustment Item	Display	Range
Volume offset	"VOLUME OFFSET"	-8 — ±0 (AUX: -8 — +8)
Dual Zone System	"2 ZONE"	ON/OFF



- Volume offset: Sets each source's volume as a difference from the basic volume.
- Dual Zone System
Main source and sub source (Auxiliary input) output Front channel and Rear channel separately.
 - Set up the channel of sub source by <Dual Zone System Setting> (page 41).
 - Select Main source by [SRC] button.
 - Adjust the volume of Front channel by [VOL] knob.
 - Adjust the volume of Rear channel by <Audio Control> (page 9).
 - The DSP Control will be disabled.
- You can use the Dual Zone System only when you have set the rear speaker to any mode other than "None" in the <Sound Management system> (page 12).

5 Exit Audio Setup mode

Press the [VOL] knob for at least 1 second.

General features

Subwoofer Output

Turning the Subwoofer output ON or OFF.

Push the Control knob toward down for at least 2 seconds.

Each time you push the knob, Subwoofer output switches ON and OFF.

When it is ON, "SUBWOOFER ON" is displayed.

Loudness

Compensating for low and high tones during low volume. (Only the low tone is compensated for when the tuner is selected as a source.)

1 Enter Loudness mode

Using the Control knob, select "DSP" > "SND CONT" > "LOUD".

For the operation method, refer to <Function Control mode> (page 11).

2 Select the Loudness

Turn the Control knob.

Each time you push the knob, the Loudness turns ON and OFF.

3 Exit Loudness mode

Press the Control knob.

In Audio file source

Supreme Setting

When AAC, MP3 or WMA files encoded at a low bit rate (less than 128kbps (fs=44.1k, 48kHz)) are played, this function restores their high frequency region to approach the sound quality of equivalents of these files encoded at a high bit rate. Processing is optimized for the compression format used (AAC, MP3, or WMA), and adjustment is made for the bit rate used.

1 Enter Supreme Setting mode

Using the Control knob, select "DSP" > "SND CONT" > "Supreme".

For the operation method, refer to <Function Control mode> (page 11).

2 Select the Supreme

Turn the Control knob or push it towards left or right.

Display	Setting
"Supreme ON"	Plays sound using the Supreme function.
"Supreme OFF"	Plays the original sound stored in the audio file.

3 Exit Supreme Setting mode

Press the Control knob.



- The sound effect may be imperceptible depending on the relationship between the audio file format and setting.
- This function is not available on iPod.

TEL Mute

The audio system automatically mutes when a call comes in.

When a call comes in

"CALL" is displayed.

The audio system pauses.

Listening to the audio during a call

Press the [SRC] button.

The "CALL" display disappears and the audio system comes back ON.

When the call ends

Hang up the phone.

The "CALL" display disappears and the audio system comes back ON.



- To use the TEL Mute feature, you need to hook up the MUTE wire to your telephone using a commercial telephone accessory. Refer to <Connecting Wires to Terminals> (page 50).

Function Control mode

To set up various functions of this unit, select tree-structured function items.

1 Enter Function Control mode

Press the [FNC] button.

2 Select your desired setup item

Select a setup item using the Control knob.

Operation type	Operation
Movement between items	Turn the Control knob.
Selection of item	Press the Control knob.
Return to previous item	Press the [FNC] button.

Functions of items are as follows:

Display	Icon	Function of setup item
"Menu"	"MENU"	Allows you to set up the environment. Refer to <Menu system> (page 37).
"DSP"	"DSP"	Sets the DSP function. Refer to page 12 to page 16.
"Display Select"	"DISPLAY"	Allows you to set up the display. Refer to page 16 to page 19.
"Angle Adjust"	"ANGLE"	Allows you to set the panel angle. Refer to <Angle Control> (page 20).
"Preset Memory"	"PMEMORY"	Allows you to put stations in the memory. Refer to <Station Preset Memory> (page 22).
"File Scan" etc.	"SCAN" etc.	Allows you to set how to play the CD and audio file. Refer to <Play function of CD and Audio file> (page 29).
"Return"		Returns to the previous item.

3 Select an option for the selected item

Refer to the related pages for the operation of each option.

4 Exit Function Control mode

Press the [FNC] button for at least 1 second.

General features

Sound Management system

1 Enter Sound Management mode

Using the Control knob, select "DSP" > "S.M.S".

For the operation method, refer to <Function Control mode> (page 11).

2 Select the Sound Management item to adjust

Turn the Control knob or push it towards left or right.

Press the Control knob.

Icon	Sound Management Item
"CABIN"	Cabin Setting
"SPEAKER" > "FRONT" > "LOCATION"	Speaker Location Front
> "SIZE"	Speaker Size Front
> "TWEETER"	Speaker Select Tweeter
> "REAR" > "LOCATION"	Speaker Location Rear
> "SIZE"	Speaker Size Rear
> "SUB-W" > "SIZE"	Speaker Size Subwoofer
"DTA" > "FRONT"	DTA Front
> "REAR"	DTA Rear
> "SUB-W"	DTA Subwoofer
"X'OVER"* > "FRONT"	Front High Pass Filter
> "REAR"	Rear High Pass Filter
> "SUB-W"	Subwoofer Low Pass Filter

* The following adjustment items can be selected by up or down knob for "X'OVER".

Icon	Display	Sound Management Item
> "FRONT"	"fc"	Front High Pass Filter Cut off Frequency
	"Slope"	Front High Pass Filter Slope
> "REAR"	"fc"	Rear High Pass Filter Cut off Frequency
	"Slope"	Rear High Pass Filter Slope
> "SUB-W"	"fc"	Subwoofer Low Pass Filter Cut off Frequency
	"Slope"	Subwoofer Low Pass Filter Slope
	"Phase"	Subwoofer Low Pass Filter Phase



- "CABIN"
Set the type of vehicle for the sound position setting of the DSP.
- "SPEAKER"
Sets the size and location of the speakers.

- "DTA" (Digital Time Alignment).

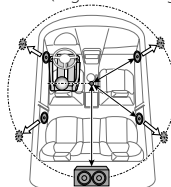

Fine tune the difference in distance between speakers set with Cabin Setting. Use together with <Position Control> (page 13)

- 1 Set reference point so that the front/rear positions and height are at the position of the ears of the person sitting in the front seat and the left/right position is at the center of the cabin.
 - 2 Measure the distance from the reference point to the speaker.
 - 3 Calculate the difference in distance with reference to the farthest speaker.
- "X'OVER" (Crossover Network Setup)
You can manually set a crossover frequency for the speakers.

3 Adjust the Sound Management item

Turn the Control knob or push it towards left or right.

Each time you push the knob, the setting alternates between the settings shown in the table below.

"CABIN"

Sound Management Item	Range
Cabin Setting	OFF/ Compact/ Sedan/ Wagon/ Minivan/ SUV/ Passenger Van

"SPEAKER"

Sound Management Item	Range
Speaker Location Front	Door/ On Dash/ Under Dash
Speaker Size Front	16cm/ 17cm/ 18cm/ 4×6/ 5×7/ 6×8/ 6×9/ 7×10/ O.E.M./ 10cm/ 13cm
Speaker Size Tweeter	None/ Use
Speaker Location Rear	• Door/ Rear Deck • 2nd Row/ 3rd Row (Minivan/ Passenger Van)
Speaker Size Rear	16cm/ 17cm/ 18cm/ 4×6/ 5×7/ 6×8/ 6×9/ 7×10/ None/ O.E.M./ 10cm/ 13cm
Speaker Size Subwoofer	25cm/ 30cm/ 38cm Over/ None/ 16cm/ 20cm

"DTA"

Sound Management Item	Range
DTA Front/	0 — 290 (cm)
DTA Rear/	
DTA Subwoofer	

"X'OVER"

Sound Management Item	Range
Front High Pass Filter Cut off Frequency/ Rear High Pass Filter Cut off Frequency	Through/ 30 — 100/ 120/ 150/ 180/ 220/ 250 (Hz)
Front High Pass Filter Slope/ Rear High Pass Filter Slope/ Subwoofer Low Pass Filter Slope	-12/ -18/ -24 dB/Oct
Subwoofer Low Pass Filter Cut off Frequency	30 — 100/ 120/ 150/ 180/ 220/ 250 (Hz)/ Through
Subwoofer Low Pass Filter Phase	Normal/ Reverse

4 Exit Sound Management mode

Press the [FNC] button.

Position Control

1 Enter Position mode

Using the Control knob, select "DSP" > "SND CONT" > "POSITION".

For the operation method, refer to <Function Control mode> (page 11).

2 Select the Position item to adjust

Turn the Control knob or push it towards left or right.

Icon	Position Item
"PRESET"	Preset Position
"MANUAL"	Manual Position

3 Enter the Position item

Press the Control knob.

4 Adjust the Position item

Preset Position Setting

Push the Control knob towards right or left.

Each time you push the knob, the setting alternates between the settings shown in the table below.

Range
All/ Front-Left/ Front-Right/ Front

Manual Position Setting

1 Select the items to adjust for Position.

Push the Control knob towards up or down.

Display	Position Item
"L" "FRONT"	Front Left
"L" "REAR"	Rear Left
"L" "SW"	Subwoofer Left
"FRONT" "R"	Front Right
"REAR" "R"	Rear Right
"SW" "R"	Subwoofer Right

2 Adjust the Position.

Turn the Control knob or push it towards left or right.

Each time you push the knob, the setting alternates between the settings shown in the table below.

Range
0 — 100 (cm)

5 Exit Position mode

Press the [FNC] button.



- About the position setting
First, set the using environment with "DTA" in <Sound Management system> (page 12).
Preset position setting is for selecting the actual listening position.
Manual position setting is for further adjustment of the position selected in preset position setting. This setting value can be memorized for each preset position.
- When using the Subwoofer Left and Subwoofer Right as a single sub woofer, set the left side and right side to the same value.
- Preset Position initial settings

Preset Position	Front		Rear		Subwoofer	
	Left	Right	Left	Right	Left	Right
ALL	0	0	0	0	0	0
Front-Left	0	35	0	35	0	0
Front-Right	35	0	35	0	0	0
Front	0	0	100	100	0	0

General features

Equalizer Control

1 Select the source to adjust

Press the [SRC] button.

Refer to <Selecting the Source> (page 8).

2 Enter Equalizer Control mode

Using the Control knob, select "DSP" > "SND CONT" > "EQ".

For the operation method, refer to <Function Control mode> (page 11).

3 Select the Equalizer Control item to adjust

Turn the Control knob or push it towards left or right.

Icon	Equalizer Control Item
"PRESET"	System Q Setting
"FRONT"	Equalizer Front Setting
"REAR"	Equalizer Rear Setting

4 Enter the Equalizer Control item

Press the Control knob.

5 Adjust the Equalizer control item

System Q Setting

Turn the Control knob or push it towards left or right.

Each time you push the knob, the setting alternates between the settings shown in the table below.

Display	Sound setting
"User"/"Natural"/"Rock"/"Pops"/"Easy"/"Top40"/"Jazz"	User/Natural/Rock/Pops/Easy/Top 40/Jazz



- User memory:
The values set on the <Equalizer Front Setting/ Equalizer Rear Setting>.
- To get the best sound, first go through <Sound Management system> (page 12).

Equalizer Front Setting/

Equalizer Rear Setting

1 Select a frequency band you wish to adjust.

Turn the Control knob or push it towards left or right.

Each time you push the knob, the band alternates between "1" (Band 1) and "4" (Band 4).

2 Select the items to adjust for Equalizer.

Push the Control knob towards up or down.

Each time you push the knob, the item to be adjusted alternates between the items shown in the table below.

3 Adjust the Equalizer.

Turn the Control knob or push it towards left or right.

Each time you push the knob, the setting alternates between the settings shown in the table below.

Display	Equalizer adjustment item	Range
"F0"	Equalizer Front Center Frequency/ Equalizer Rear Center Frequency	Refer to the followings.
"Q"	Equalizer Front Quality/ Equalizer Rear Quality	0.25/ 0.50/ 1.00/ 2.00
"Gain"	Equalizer Front Level/ Equalizer Rear Level	-9/ -7/ -5/ -3/ -2/ -1/ 0/ +1/ +2/ +3/ +5/ +7/ +9
"Effect"	Equalizer Front Effect/ Equalizer Rear Effect (BAND1 only)	OFF/ ON



- The frequency which can be selected by each Frequency band is shown below.

Band	Frequency
Band1	60/ 80/ 100/ 120/ 160/ 200 Hz
Band2	250/ 315/ 400/ 500/ 630/ 800/ 1k Hz
Band3	1.25/ 1.6/ 2/ 2.5/ 3.15/ 4 kHz
Band4	5/ 6.3/ 8/ 10/ 12.5/ 16 kHz

- "Effect"
Amplifies the range lower than the center frequency as well as the low center frequency.

4 Exit frequency band.

Press the Control knob.

6 Exit Equalizer Control mode

Press the [FNC] button.

WOW HD Control

1 Select the source to adjust

Press the [SRC] button.

Refer to <Selecting the Source> (page 8).

2 Enter WOW HD Control mode

Using the Control knob, select "DSP" > "SND CONT" > "WOW HD".

For the operation method, refer to <Function Control mode> (page 11).

3 Select the WOW HD Control item to adjust Turn the Control knob or push it towards left or right.

Press the Control knob.

Icon	WOW HD Control Item
"PRESET"	Preset WOW HD
"FRONT"	>"FOCUS" FOCUS
	>"TruBass" TruBass Front
	>"Space" SRS 3D Space Control
	>"Center" SRS 3D Center Control
	>"Defini" Definition Front
"REAR"	>"TruBass" TruBass Rear
	>"Defini" Definition Rear

4 Adjust the WOW HD control item Turn the Control knob or push it towards left or right.

Each time you push the knob, the setting alternates between the settings shown in the table below.

WOW HD Control Item	Range
Preset WOW HD	Middle/ High/ User/ Through/ Low
FOCUS	OFF/ 1 — 9
TruBass Front/ TruBass Rear	OFF/ 1 — 9
SRS 3D Space Control	OFF/ 1 — 9
SRS 3D Center Control	-4 — Neutral — 4
Definition Front/ Definition Rear	OFF/ 1 — 9



- Preset WOW HD:
FOCUS, TruBass, 3D Space Control, 3D Center Control and Definition are all set.
- FOCUS: Adjusts the vertical position of the front speaker and sound image by virtual adjustment.
- TruBass: Assists the playback for the super bass sound.
- SRS 3D Space Control: Adjusts the soundscape.
- SRS 3D Center Control:
Adjusts the center image such as vocal part in music.
- Definition:
Improves sound quality in high range and creates clear sound.

5 Exit WOW HD Control mode Press the [FNC] button.



- To get the best sound, first go through <Sound Management system> (page 12).

Memory mode

Storing the values of DSP in memory.

1 Adjust the item you wish to put in memory

By referring to <Sound Management system> (page 12), <Position Control> (page 13), and <Equalizer Control> (page 14), adjust the item you wish to put in the memory.

2 Enter Memory mode

Using the Control knob, select "DSP" > "PRESET" > "MEMORY".

For the operation method, refer to <Function Control mode> (page 11).

3 Select the number to put in the memory Turn the Control knob.

4 Determine whether to put the Audio Preset in the memory

Press the Control knob.

"Memory?" is displayed.

5 Put the Audio Preset in the memory

Select "YES" using the Control knob.

"Memory Completed" is displayed.

6 Exit Memory mode Press the [FNC] button.



- "Memory 1": When you press the Reset, all the sources will be the setting value which is registered.
- "Memory 1", "Memory 2":
The memory cannot be erased by the Reset button.
- The following items cannot be registered.
System Q Setting

General features

Memory Recall mode

Recall the value in the memory by the memory mode.

1 Select the source to adjust

Press the [SRC] button.

2 Enter recall mode

Using the Control knob, select "DSP" > "PRESET" > "RECALL".

For the operation method, refer to <Function Control mode> (page 11).

3 Select the recall item

Select the recall number using the Control knob.

Press the Control knob.

Recall the value put by <Memory mode> (page 15).

"Recall?" is displayed.

4 Recall the Audio Preset

Select "YES" using the Control knob.

"Recall Completed" is displayed.

5 Exit Memory Recall mode

Press the [FNC] button.

Display Type Selection

Changing the display mode.

1 Enter Display Type Selection mode

Using the Control knob, select "DISPLAY" > "TYPE".

For the operation method, refer to <Function Control mode> (page 11).

2 Select the Display Type

Turn the Control knob.

Select from the following display types:

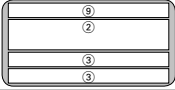
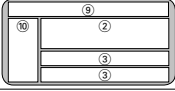
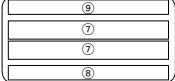
Display	Display Type
"TYPE SELECT [A]"	
"TYPE SELECT [B]"	
"TYPE SELECT [C]"	
"TYPE SELECT [D]"	

3 Exit Display Type Selection mode

Press the Control knob.

4 Enter Display Mode Selection mode (Display Type B/ Display Type C only)

Using the Control knob, select "DISPLAY" > "MODE".

5 Select the Display Mode

Turn the Control knob.

Select from the following display mode:

Mode	"TYPE SELECT [B]"	"TYPE SELECT [C]"
B-1/ C-1		
B-2/ C-2		
B-3/ C-3		

6 Exit Display Mode Selection mode

Press the Control knob.



- ①, ②, ③, ④, ⑤, ⑥, ⑦, ⑧ Text display part
⑨ Status display
⑩ Icon display part
⑪ Graphic display part
- To change the information by the Display Type, refer to the page on the following table for the methods to alternate by the Display Type.

Display Type	A	B-1	B-2	B-3	C-1	C-2	C-3	D
Text ①	18	—	18	—	—	18	—	—
Text ③	—	18	—	—	18	—	—	—
Text ④	—	—	18	—	—	18	—	—
Text ⑤	—	—	18	—	—	18	—	—
Text ⑥	—	—	—	18	—	—	18	—
Text ⑦	—	—	—	—	—	—	—	18
Status ⑨	17	—	—	—	—	—	—	—
Icon ⑩	—	—	—	—	19	19	19	—
Graphic ⑪	17	—	—	—	—	—	—	—

- With Display type D, text is displayed between the top and bottom rows when blank is set in the top or bottom row.
- Text display part ⑥
If whole information cannot be displayed within four rows, hold down on [FM] of the Control knob for at least 1 second to display the remaining portion of the information.

Display Type A

Status Setting

Determine whether the On and Off statuses of various functions are to be displayed on the Display Type A.

1 Enter Status Setting mode

Using the Control knob, select "DISPLAY" > "STATUS".

For the operation method, refer to <Function Control mode> (page 11).

2 Select the Status display

Turn the Control knob.

3 Exit Status Setting mode

Press the Control knob.

Display Type A

Graphic Display Selection

Changing the graphic Display.

1 Enter Graphic Display Selection mode

Using the Control knob, select "DISPLAY" > "GRAPHIC".

For the operation method, refer to <Function Control mode> (page 11).

2 Select the graphic display

Turn the Control knob or push it towards left or right.

Select from the following displays:

Graphic display	Display
Movie 1 – 2	
Spectrum analyzer 1 – 8	
Wallpaper 1 – 12	
Downloaded Wallpaper*	
Wallpaper scan	"SCAN"

* For Download Wall Paper, refer to <Picture downloading> (page 45).

3 Exit Graphic Display Selection mode

Press the Control knob.



- During standby, Spectrum analyzer cannot be selected.

General features

Text Display Selection

Changing the text display.

1 Enter Text Display Selection mode

Using the Control knob, select "DISPLAY" > "TEXT".

For the operation method, refer to <Function Control mode> (page 11).

2 Select the text

Turn the Control knob or push it towards left or right.

See <The text display> (page 18).

Select the row (only for display type with multiple rows)

Push the Control knob towards up or down.

The cursor (▶) moves to the selected text display part.

3 Exit Text Display Selection mode

Press the Control knob.



- When LX-AMP is connected, the item setup by the Display mode of LX-AMP is displayed. (Other than B-3 or C-3 display mode)
- When the music number exceeds 1000, only the last 3 digits of its number are displayed.
- Music title, Artist name, and Album name cannot be displayed in WAV file.
- When playing music from iPod or music edited by "Music Editor", the folder name display may show something different such as playlist or artist name depending on the music selection procedure.
- Same information cannot be displayed in text display part. However, the blank display is able to have multiple selections.
- If the selected display item does not have any information, alternative information is displayed. May be blank depending on the displayed row.

The text display

In Tuner source

Information	Display	Condition
Program Service name (FM)	"Frequency/PS"	① ④
Program Service name (FM)	"PS Name"	③
Title & Artist name* (FM)	"Title/Artist"	①③④⑤⑥⑦
Station name* (FM)	"Station Name"	①③④⑤⑥⑦
Radio text plus* (FM)	"Radio Text Plus"	①③④⑤⑥⑦
Radio text (FM)	"Radio Text"	①③④⑤⑥⑦
Frequency (MW, LW)	"Frequency"	① ④
Spectrum Analyzer & Clock	"Speana/Clock"	③④⑤
Clock	"Clock"	① ⑦
Date	"Date"	①③④⑤ ⑦
Blank	"Blank"	①③④⑤ ⑦

* Information of Radio text plus is displayed.

In CD & External disc source

Information	Display	Condition
Disc title	"Disc Title"	①③④⑤⑥⑦
Track title	"Track Title"	①③④⑤⑥⑦
Track number & Play time	"P-Time"	① ④
Disc name preset	"DNPS"	①③④⑤ ⑦
Spectrum Analyzer & Clock	"Speana/Clock"	③④⑤
Clock	"Clock"	① ⑦
Date	"Date"	①③④⑤ ⑦
Blank	"Blank"	①③④⑤ ⑦

In Audio file source

Information	Display	Condition
Music title & Artist name	"Title/Artist"	①③④⑤⑥⑦
Album name & Artist name	"Album/Artist"	①③④⑤⑥⑦
Folder name	"Folder Name"	①③④⑤⑥⑦
File name	"File Name"	①③④⑤⑥⑦
Play time & Music number	"P-Time"	① ④
Spectrum Analyzer & Clock	"Speana/Clock"	③④⑤
Clock	"Clock"	① ⑦
Date	"Date"	①③④⑤ ⑦
Blank	"Blank"	①③④⑤ ⑦

In Standby

Information	Display	Condition
Standby	"Source Name"	① ④
Clock	"Clock"	①③④⑤ ⑦
Date	"Date"	①③④⑤ ⑦
Blank	"Blank"	①③④⑤ ⑦

In Auxiliary input source

Information	Display	Condition
Auxiliary input name	"Source Name"	① ④
Spectrum Analyzer & Clock	"Speana/Clock"	③ ④ ⑤
Clock	"Clock"	① ⑦
Date	"Date"	① ③ ④ ⑤ ⑦
Blank	"Blank"	① ③ ④ ⑤ ⑦



- See <Display Type Selection> (page 16) for the display position of "Condition".

Display Type A/ Display Type B/ Display Type C

Font Color Selection

Selecting the display font color.

1 Enter Font Color Selection mode

Using the Control knob, select "DISPLAY" > "COLOR".

For the operation method, refer to <Function Control mode> (page 11).

2 Select the text display part

Select the character color/ outline color (Display Type A only)

Push the Control knob towards up or down.

Display	Setting
"FILL-IN"	The color of the text fill.
"OUTLINE"	The color of the text outline.

Select the row (only for display type with multiple rows)

Push the Control knob towards up or down.

The cursor (▶) moves to the selected text display part.

3 Select the Font Color

Basic color (12 colors)

Push the Control knob towards right or left.

Detail color (115 colors)

Turn the Control knob.

4 Exit Font Color Selection mode

Press the Control knob.

Display Type C

Icon Display Switching

Changing the Icon Display.

1 Enter Icon select mode

Using the Control knob, select "DISPLAY" > "SIDE".

2 Switch the Icon display

Turn the Control knob or push it towards left or right.

Select from the following displays:

Icon display	Display
Source graphic	"Source"
Text label	"Text"
Album art (iPod or "Music Editor" media)	"Photograph"

3 Exit Icon select mode

Press the Control knob.



- The Album art display function is not used to display the image corresponding to the tag recorded in the Audio file.
- If Album art display is selected during playback of an iPod or "Music Editor" media on which no album art is recorded, a source icon is displayed.
- During Album art downloading, "Down-loading" is displayed. Downloading requires a maximum of 30 seconds.

External Display Selection

Changing the display in the connected External Display.

1 Enter External display select mode

Using the Control knob, select "DISPLAY" > "OUT".

For the operation method, refer to <Function Control mode> (page 11).

"Display Out Select" is displayed.

2 Select the display

Turn the Control knob or push it towards left or right.

Select your desired display.

3 Exit display control mode

Press the Control knob.

General features

Angle Control

Setting the panel angle.

1 Enter Angle Control mode

Using the Control knob, select "ANGLE".

For the operation method, refer to <Function Control mode> (page 11).

2 Set the panel angle

Turn the Control knob to right or push it towards right.

Each time you turn the Control knob, the panel angle is changed in four levels.

3 Exit Angle Control mode

Press the Control knob.

Theft Deterrent Faceplate

The faceplate of the unit can be detached and taken with you, helping to deter theft.

Removing the Faceplate

Press the Release button.

The faceplate is unlocked, allowing you to detach it.

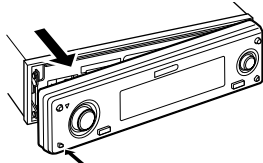

- The faceplate is a precision piece of equipment and can be damaged by shocks or jolts.
- Keep the faceplate in its faceplate case while detached.
- Do not expose the faceplate (and the faceplate case) to direct sunlight or excessive heat or humidity. Also avoid places with too much dust or the possibility of water splashing.

Reattaching the Faceplate

1 Align the shaft on the unit with the depression on the faceplate.

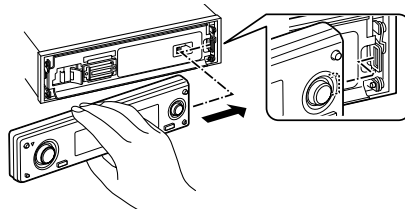

2 Push the faceplate in until it clicks.

The faceplate is locked in place, allowing you to use the unit.

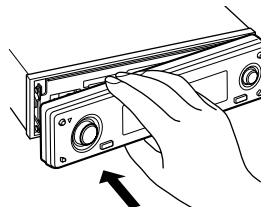

Tuner features

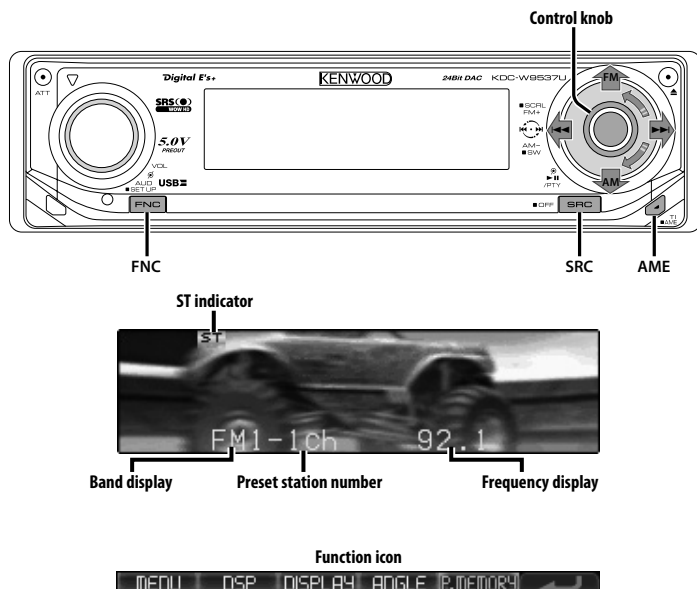

Tuning

Selecting the station.

1 Select tuner source

Press the [SRC] button.

Select the "TUNER" display.

Refer to <Selecting the Source> (page 8).

2 Select the band

Push the Control knob towards [FM] or [AM].

Each time you push the knob toward [FM], it switches between the FM1, FM2, and FM3 bands.

3 Tune up or down band

Push the Control knob towards [◀◀] or [▶▶].



- During reception of stereo stations the "ST" indicator is ON.

Function of remote control

Direct Access Tuning

Entering the frequency and tuning.

1 Select the band

Press the [FM] or [AM] button.

2 Enter Direct Access Tuning mode

Press the [DIRECT] button on the remote control.

"- - - -" is displayed.

3 Enter the frequency

Press the number buttons on the remote control.

Example:

Desired frequency	Press button
92.1 MHz (FM)	[0], [9], [2], [1]
810 kHz (AM)	[0], [8], [1], [0]

Cancelling Direct Access Tuning

Press the [DIRECT] button on the remote control.



- You can enter the FM band frequency in steps of a minimum of 0.1 MHz.

Tuner features

Station Preset Memory

Putting a station in the memory.

1 Select the band

Push the Control knob towards [FM] or [AM].

2 Select the frequency to put in the memory

Push the Control knob towards [◀◀] or [▶▶].

3 Enter Preset Memory mode

Using the Control knob, select "P.MEMORY".

For the operation method, refer to <Function Control mode> (page 11).

4 Select the number to put in the memory

Turn the Control knob.

5 Determine the number to put in the memory

Press the Control knob.

6 Allow the determined number to take effect

Press the Control knob.

Canceling the Preset Memory mode

Press the [FNC] button.

Auto Memory Entry

Putting stations with good reception in the memory automatically.

1 Select the band for Auto Memory Entry

Push the Control knob towards [FM] or [AM].

2 Open Auto Memory Entry

Press the [AME] button for at least 2 seconds.

When 6 stations that can be received are put in the memory Auto Memory Entry closes.



- When the <AF (Alternative Frequency)> (page 42) is ON, only RDS stations are put in the memory.
- When Auto Memory Entry is done in the FM2 band, the RDS stations preset in the FM1 band are not put in the memory.

Likewise, when Auto Memory Entry is done in the FM3 band, RDS stations preset in FM1 or FM2 are not put in the memory.

Preset Tuning

Recalling the stations in the memory.

1 Select the band

Push the Control knob towards [FM] or [AM].

2 Enter Preset Tuning Select mode

Turn the Control knob.

3 Select a desired station in the memory

Turn the Control knob.

4 Recall the station

Press the Control knob.

Canceling Preset Tuning

Press the [FNC] button.

PTY (Program Type)

Selecting the Program Type and searching for a station.

1 Enter PTY mode

Press the Control knob.

"PTY SELECT" is displayed.



- This function cannot be used during a traffic bulletin or AM reception.

2 Select the Program Type

Turn the Control knob or push it towards up or down.

Each time you push the knob, the Program Type alternates between the program types shown in the table below.

No.	Program Type	Display
1.	Speech	"All Speech"
2.	Music	"All Music"
3.	News	"News"
4.	Current Affairs	"Current Affairs"
5.	Information	"Information"
6.	Sport	"Sport"
7.	Education	"Education"
8.	Drama	"Drama"
9.	Culture	"Cultures"
10.	Science	"Science"
11.	Varied	"Varied Speech"
12.	Pop Music	"Pop Music"
13.	Rock Music	"Rock Music"
14.	Easy Listening Music	"Easy Listening M"
15.	Light Classical	"Light Classic M"
16.	Serious Classical	"Serious Classics"
17.	Other Music	"Other Music"
18.	Weather	"Weather & Metr"
19.	Finance	"Finance"
20.	Children's programs	"Children's Prog"
21.	Social Affairs	"Social Affairs"
22.	Religion	"Religion"
23.	Phone In	"Phone In"
24.	Travel	"Travel & Touring"
25.	Leisure	"Leisure & Hobby"
26.	Jazz Music	"Jazz Music"
27.	Country Music	"Country Music"
28.	National Music	"National Music"
29.	Oldies Music	"Oldies Music"
30.	Folk Music	"Folk Music"
31.	Documentary	"Documentary"



- Speech and Music include the Program type shown below.
Music: No.12 — 17, 26 — 30
Speech: No.3 — 11, 18 — 25, 31
- The Program Type can be put in the preset memory and recalled quickly. Refer to the <Program Type preset> (page 24).
- You can change the display language. Refer to <Changing Language for PTY Function> (page 25).

3 Search for the selected Program Type station

Push the Control knob towards [◀◀] or [▶▶].

When you want to search for other stations, push [◀◀] or [▶▶] of the Control knob again.



- When the selected Program Type is not found, "No PTY" is displayed. Select another Program Type.

4 Exit PTY mode

Press the Control knob.

Program Type preset

Putting the Program Type in the Preset button memory and quick recall.

Presetting the Program Type

1 Select the Program Type to preset

Refer to <PTY (Program Type)> (page 24).

2 Enter Program Type preset mode

Press the [FNC] button.

3 Select the number you want to put in the memory

Turn the Control knob or push it towards left or right.

4 Preset the Program Type

Press the Control knob for at least 1 second.

5 Exit Program Type preset mode

Press the [FNC] button.

Recalling the preset Program Type

1 Enter PTY mode

Refer to <PTY (Program Type)> (page 24).

2 Enter Program Type preset mode

Press the [FNC] button.

3 Select the number you want to recall from the memory

Turn the Control knob or push it towards left or right.

4 Recall the Program Type

Press the Control knob.

5 Exit Program Type preset mode

Press the [FNC] button.

Changing Language for PTY Function

Selecting the Program Type display language.

1 Enter PTY mode

Refer to <PTY (Program Type)> (page 24).

2 Enter Changing Language mode

Press the [TI] button.

3 Select the language

Turn the Control knob or push it towards up or down.

Each time you push the knob, the language alternates between the languages shown in the table below.

Language	Display
English	"English"
Spanish	"Spanish"
French	"French"
Dutch	"Dutch"
Norwegian	"Norwegian"
Portuguese	"Portuguese"
Swedish	"Swedish"
German	"German"

4 Exit Changing Language mode

Press the [TI] button.

CD/Audio file (USB/iPod/Internal Memory) control features

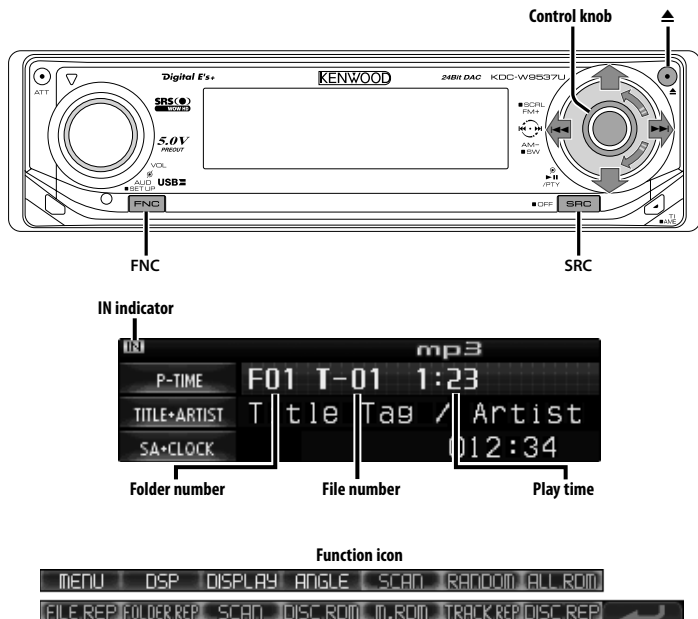

Playing CD & Audio file

When there is no disc inserted

- 1 Open the panel
Press the [\blacktriangle] button.
- 2 Insert a disc.



- When the faceplate slides open, it might interfere with the shift lever or other vehicle function. If this happens, pay attention to safety and move the shift lever or take an appropriate action to remove the obstacle, then operate the unit.
- Insert the disc horizontal to the slot. If you insert the Disc as you push down on the Disc, it may scratch the Disc.



- For the audio files and discs you can play with this unit, refer to <About Audio file> (page 5).
- When a disc is inserted the "IN" indicator is ON.

When a disc is inserted

- Press the [SRC] button.
Select the "Compact Disc" display.
Refer to <Selecting the Source> (page 8).

Eject the disc

- 1 Eject the disc
Press the [\blacktriangle] button.
- 2 Return the panel to the original position
Press the [\blacktriangle] button.



- You can eject the disc for 10 minutes after switching off the engine.

Playing USB (iPod) device

When the USB device is not connected

- Connect the USB device**
Playback of the file contained in the USB device starts.

When the USB device is connected

- Select USB source**
Press the [SRC] button.
Select the "USB" (or "iPod") display.
Refer to <Selecting the Source> (page 8).



- For the audio files that can be played with this unit and the devices that can be connected to this unit, refer to <About Audio file> (page 5).
- The word "iPod" appearing in this manual indicates the iPod connected with the KCA-iP200 (optional accessory). Refer to <About Audio file> (page 5).
- If you start playback after connecting the iPod, the music that has been played by the iPod is played first. In this case, "RESUMING" is displayed without displaying a folder name, etc. Changing the browse item will display a correct title, etc.
- When the iPod is connected to this unit, "KENWOOD" or "✓" is displayed on the iPod to indicate that you cannot operate the iPod.
- When the USB device is connected to this unit, it can be charged up provided that this unit is powered.
- When the Multi Card Reader is used, refer to <Drive Search> (page 27).
- After you stopped playing a file contained in the USB device, you can restart playing the file from the point where you stopped its playback. Even after removing the USB device, you can restart playing the file from the point where you stopped its playback as long as the files contained in the USB device are all the same.
- Be sure to insert the USB device connector as far as it will go.

Removing the USB device

- 1 Set the remove mode as the USB source**
Press the [▲] button for at least 2 seconds.
"USB REMOVE" display blinks.
- 2 Remove the USB device.**

Playing Internal Memory

Press the [SRC] button.
Select the "Internal Memory" display.
Refer to <Selecting the Source> (page 8).

Playing External Disc

Playing discs set in the optional accessory disc player connected to this unit.

Press the [SRC] button.

Select the display for the disc player you want. Refer to <Selecting the Source> (page 8).

Display examples:

Display	Disc player
"CD Changer"	CD changer
"MD Changer"	MD changer



- The functions that can be used and the information that can be displayed will differ depending on the external disc players being connected.

Pause and play

Press the Control knob.

Each time you press the knob, the audio pauses or plays.

Drive Search

Selecting the device inserted in the Multi Card Reader.

1 Put the playback to pause

Press the Control knob.

2 Select a device

Push the Control knob towards up or down.

3 Restart playback

Press the Control knob.



- This unit is compliant with Multi Card Readers with a maximum of 4 slots.
- If a device is inserted during connection of the Multi Card Reader, it is not recognized. Select the Remove mode with reference to <Playing USB (iPod) device> (page 26), remove the Card Reader, and then insert the memory.

CD/Audio file (USB/iPod/Internal Memory) control features

Fast Forwarding and Reversing

Fast Forwarding

Hold down toward [▶▶] with the Control knob.
Release to resume the playback.

Reversing

Hold down toward [◀◀] with the Control knob.
Release to resume the playback.



- There is no sound while the Audio file is being searched.

Music Search

Switching between music contained in the disc or folder being played now.

Push the Control knob towards [◀◀] or [▶▶].

Function of disc changer/ Audio file

Disc Search/Folder/Album Search

Switching between folders/albums contained in the disc changer, media, or device being played now.

Push the Control knob towards up or down.



- Disabled when "RESUMING" is displayed on the iPod.

Function of remote control

Direct Music Search

Doing Music Search by entering the music number.

1 Enter the music number

Press the number buttons on the remote control.



- You can select Direct music Search up to 999.

2 Do music Search

Press the [◀◀] or [▶▶] button.

Cancelling Direct Music Search

Press the [▶II] button.



- This function is not available on iPod and the music edited by "Music Editor".

Function of disc changers with remote control

Direct Disc Search

Doing Disc Search by entering the disc number.

1 Enter the disc number

Press the number buttons on the remote control.

2 Do Disc Search

Press the [FM+] or [AM-] button.

Cancelling Direct Disc Search

Press the [▶II] button.

Play function of CD and Audio file

Setting up the Repeat Play and Scan Play.

1 Set up the play function

Using the Control knob, set your desired setup item to On/Off.

For the operation method, refer to <Function Control mode> (page 11).

When the play function is turned on, "ON" is displayed.

Display	Icon	Function
"File Scan"	"SCAN"	Successively plays the audio files in the current folder or genre.
"Folder RDM"	"RANDOM"	Plays the audio files in the current folder or genre at random.
"All Random"	"ALL RDM"	Plays the audio files in the current disc, USB device or Internal Memory at random.
"File Repeat"	"FILE REP"	Plays the current audio file repeatedly.
"Folder Repeat"	"FOLDER REP"	Plays the audio files in the current folder or genre repeatedly.
"(Track) Scan"	"SCAN"	Plays the beginnings of the music on the current CD/MD one after another for 10 seconds each.
"Disc Random"	"RANDOM"	Plays the music on the current CD/MD at random.
"Magazine RDM"	"M.RDM"	Plays the music in the disc changer at random.
"(Track) Repeat"	"TRACK REP"	Plays the current music on the current CD/MD repeatedly.
"Disc Repeat"	"DISC REP"	Plays the music on the current CD/MD repeatedly.

2 Select an option for the selected item

Press the Control knob.

Pressing the Control knob switches between options.

3 Exit Play Function Set mode

Press the [FNC] button.



- Only the icons available to the current source are displayed.
- Location played with "File Scan"
 - Audio file: First 10 seconds
 - Music Editor media: First 10 seconds or the part picked by Intro Skip (30 seconds)During Intro Skip, turn the control knob left or right to change the song.
The scan method depends on the Music Editor setting. See the Music Editor help for details.
- During random play, turn the control knob right to randomly select the next song.

CD/Audio file (USB/iPod/Internal Memory) control features

Function of Audio file

File Select

Selecting the music you want to listen to from the device or media being played now.

1 Enter File Select mode

Turn the Control knob.

2 Search for music

Select the category item using the Control knob.

Operation system for iPod

Operation type	Operation
Movement between items	Turn the Control knob.
Selection of item	Press the Control knob.
Return to previous item	Push the Control knob towards up.
Return to first item	Push the Control knob towards up for at least 1 second.

Operation system for other than iPod

Operation type	Operation
Movement between items	Turn the Control knob.
Selection of item	Push the Control knob towards right.
Return to previous item	Push the Control knob towards left.
Return to first item	Push the Control knob towards left for at least 1 second.

The "◀" or "▶" symbol shown beside the displayed item indicates that the item is preceded or followed by another item.

Selecting a music will play it from the beginning.

Canceling File Select

Press the [FNC] button.



- Even when the iPod is connected, you can change the operation method from <Operation method for iPod> to <Operation method for other than iPod>. Refer to <iPod mode Setting> (page 39).

Disc Naming (DNPS)

Attaching a title to a CD.

1 Play the disc you want to attach a name to



- A title cannot be attached to MD or Audio file media.

2 Enter Menu mode

Using the Control knob, select "MENU".

For the operation method, refer to <Function Control mode> (page 11).

3 Select Name set mode

Turn the Control knob.

Select the "Name Set" display.

4 Enter Name set mode

Press the Control knob for at least 1 second.

5 Move the cursor to the enter character position

Push the Control knob towards right or left.

6 Select the character type

Press the Control knob.

Each time you press the knob, the character type alternates between the types shown in the table below.

Character type
Alphabet upper case
Alphabet lower case
Numbers and symbols
Special characters (Accent characters)

7 Select the characters

Turn the Control knob or push it towards up or down.



- You can enter characters by using a remote control with a number button.
Example: If you enter "DANCE".

Character	Button	Times pressed
"D"	[3]	1
"A"	[2]	1
"N"	[6]	2
"C"	[2]	3
"E"	[3]	2

8 Repeat steps 5 through 7 and enter the name.

9 Exit Menu mode

Press the [FNC] button.



- When operation stops for 10 seconds the name at that time is registered, and Name Set mode closes.
- Media that you can attach a name to
 - Internal CD player: 10 discs
 - External CD changer/ player: Varies according to the CD changer/ player. Refer to the CD changer/ player manual.
- You can change the name of a CD by the same operation you used to name it.

Text/Title Scroll

Scrolling the displayed CD text, Audio file text, or MD title.

Push the Control knob toward up for at least 2 seconds.



- When the <Display Illumination Control> (page 40) is set to OFF, the display may black out while scrolling.

Recording & Downloading

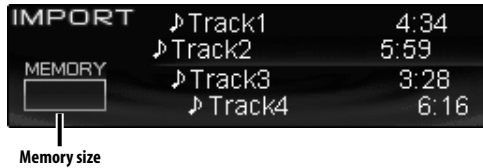
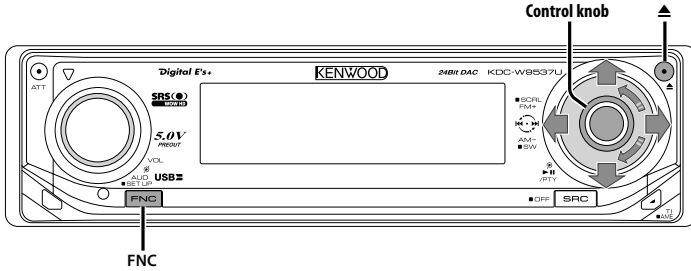

Function icon



About Internal Memory

Audio files can be stored in internal memory. The stored audio files can be played in the same manner as CDs.

Audio files can be stored by recording a music CD or copying from a USB device.

To play the stored audio file, refer to <CD/Audio file (USB/iPod/Internal Memory) control features> (page 26).

• Built-in flash memory

512 MB

• Max. recording time/ tracks

Approx. 16 hours/ Approx. 240 tracks
(Assuming that each track is in the 64 kbps WMA format with playback time of about 4 min.)



Notes on recording, copying, and erasing

- Kenwood will not be responsible for the loss or damage to the music or sound data in case recording fails due to machine fault or failure.
- Audio files may be lost if the engine is started while recording or copying.
- Record or copy with the engine running.

- Do not press the reset button or remove the battery while recording, copying, or erasing. Otherwise, the audio file in the internal memory may be lost.
- The audio file in the internal memory cannot be copied to another media.
- Only the following controls can be used while recording, copying, or erasing:
 - Volume
 - Attenuator
 - Power off

When recording or copying is interrupted

If ACC is turned off while recording or copying, a screen to confirm whether to continue recording or copying appears next time ACC is turned on (Resume function).

- 1 When "Checking the condition..." is displayed, "Continue Ripping?" or "Continue USB Copy?" is also displayed.
- 2 Turn on the engine and then select "YES".
- 3 Press the Control knob.
Recording or copying resumes.



- Resume is canceled if "CANCEL" or "NO" is selected.
 - "CANCEL": Press the Control knob.
 - "NO": Select "NO" using the Control knob. Press the Control knob.
- The resume function may be disabled depending the condition of the vehicle or battery. The audio file may be lost if the resume function is disabled. Record or copy while the engine is running.

Copying from USB device

Copy audio files and folders from USB device to internal memory.

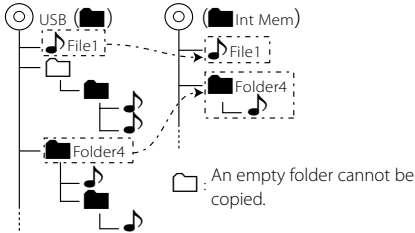

- Read <About Internal Memory> (page 32) before starting copy.

1 Connect the USB device to copy.

2 Enter Copy mode

Using the Control knob, select "COPY".

For the operation method, refer to <Function Control mode> (page 11).

3 Select a file/folder to copy

Select the audio file or folder using the Control knob.

Operation type	Operation
Movement between items	Turn the Control knob or push it towards up or down.
Selection of item	Push the Control knob towards right.
Return to previous item	Push the Control knob towards left.
Return to first item	Push the Control knob towards left for at least 1 second.
Confirm item	Press the Control knob.

4 Start copy

Select "OK" using the Control knob.

Number of files copied

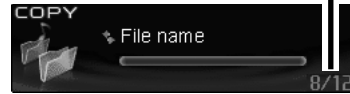

"Completed" is displayed when copying completes.

Canceling copy

1 Cancel copy

Press the [FNC] button.

Exits Copy mode if pressed by step 3.

2 Select "YES"

Select "YES" using the Control knob.

5 Exit Copy mode

Select "EXIT" using the Control knob.

Returns to step 3 if "NEXT" is selected.



- If a folder is selected, the files in the folder are copied. Sub folders are not copied.
- If there is a file or folder with the same name, a message is displayed. If you select "OK", a number is added as "Name_001".
- If there is not enough space for the selected file or folder, "OVER" is displayed. Reduce the number of files to copy or erase unnecessary files in the USB memory.
- If copying is canceled or if space runs out while copying, the files copied up to that point remain.
- The displayed space is a rough estimate. The actual size may be smaller or greater.
- Audio files with DRM can be copied, but cannot be played.
- Files cannot be copied from an iPod.
- Depending on the digital audio player, it may not be possible to copy files.
- When files are copied from Music Editor media, the copied audio files are played as normal audio file. Song selection using the Music Editor media function is not possible.

Recording & Downloading

When music CD is inserted

Setting the recordable time

Set the recordable time for recording music CD.

1 Enter Mode setting

Using the Control knob, select "IMPORT CD" > "MODE SET".

For the operation method, refer to <Function Control mode> (page 11).

2 Set the recordable time

Turn the Control knob.

Display	Setting	Max. recording time*
"Standard"	Standard recording	Approx. 8 hours
"Long Play"	⋮	Approx. 12 hours
"Super Long Play"	Extended time recording	Approx. 16 hours

3 Exit Mode setting

Press the Control knob.



- * The maximum recordable time is obtained when there is no other file. The actual recording time depends on the song.
- The sound quality for Extended recording is lower than for Standard recording.

Recording music CD

Music CD can be compressed and stored in internal memory.

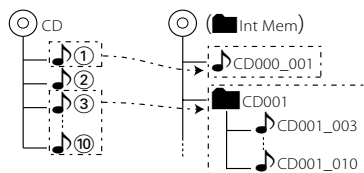

- Read <About Internal Memory> (page 32) before starting copy.
- Music CD can be recorded only from the internal CD. Recording is performed at x1 speed.

1 Insert a CD-DA

Insert the music CD to record.

Refer to <Playing CD & Audio file> (page 26).

2 Change to import mode

Using the Control knob, select "IMPORT CD" > "IMPORT".

For the operation method, refer to <Function Control mode> (page 11).

3 Select record mode

Push the Control knob towards right or left.

Multiple song record mode is set when the control knob is turned right and single song record mode is set when it is turned left.

4 Select the song to record

Turn the Control knob or push it towards up or down.

Record mode	Operation
Single song	Selects a single song.
Multi song	Selects all songs or from specified song to the last song.

5 Confirm the song

Press the Control knob.

6 Name the target file or folder

Using the Control knob, select "NAME SET".

Recording starts if "SKIP" is selected.

7 Enter Name set mode

Press the Control knob.

8 Enter the name

Operation type	Operation
Move the cursor to the enter character position	Push the Control knob towards right or left.
Select the character type*	Press the Control knob.
Select the characters	Turn the Control knob or push it towards up or down.

* Each time you press the knob, the character type alternates between the types shown in the table below.

Character type	
	Alphabet upper case
	Alphabet lower case
	Numbers and symbols
	Special characters (Accent characters)



- Enter characters by using a remote control with numbers buttons.

Example: If you are entering "DANCE".

Character	"D"	"A"	"N"	"C"	"E"
Button	[3]	[2]	[6]	[2]	[3]
Times pressed	1	1	2	3	2

9 Confirm the name

Using the Control knob, select "ENTER".

10 Start recording

Press the Control knob.

Recording track no. and remaining time

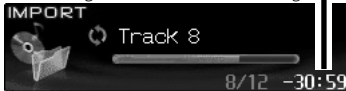

"Completed" is displayed when recording completes.

Canceling recording

1 Cancel recording

Press the [FNC] button.

Exits Import Mode when pressed by step 4.

2 Select "YES"

Select "YES" using the Control knob.

11 Exit Record mode

Select "EXIT" using the Control knob.

Returns to step 3 if "NEXT" is selected.



- Recording is possible only from music CD and not from CD containing audio files. Copy audio files from USB device.
- Sound may skip due to vibration when the vehicle is in motion. The song will be recorded together with the skip.
- Normal recording or playback may not be possible with some CDs.
- DSP cannot be enabled while recording, but it can be enabled during playback.
- When a song is selected, the remaining recording time is decreased by the length of the recording. The remaining recording time is a rough estimate. It may increase or decrease when recording is completed.
- If recording is canceled or if space runs out while recording, the recorded songs will remain.
- There is no tag (song information) on the recorded file.
- File name or folder name may contain up to 16 characters.
- If a folder name is specified when recording multiple songs, the file name will be "foldername_tracknumber".
- If there is a file or folder with the same name, a number is added as "Name_001".
- If file name or folder name is not specified:
 - Single song recording: Files are named sequentially starting from "CD000_001.wma".
 - Multi song recording: Folders are named sequentially starting from "CD001".
 - File and folder name are incremented successively from the last number even if files in the middle are deleted. The number returns to 001 when 999 is reached.
 - Setting file name and folder name is recommended.

Recording & Downloading

Deleting files in memory

Deleting audio files in memory.



- Read <About Internal Memory> (page 32) before starting to delete.
- Deleted files and folder cannot be restored.
- Use Format to delete all songs. Refer to <Internal Memory Format> (page 46).

1 Select Internal Memory source

Press the [SRC] button.

Select the "Internal Memory" display.
Refer to <Selecting the Source> (page 8).

2 Enter Delete mode

Using the Control knob, select "DELETE".

For the operation method, refer to <Function Control mode> (page 11).

3 Select a file/folder to delete

Select the audio file or folder using the Control knob.

Operation type	Operation
Movement between items	Turn the Control knob or push it towards up or down.
Selection of item	Push the Control knob towards right.
Return to previous item	Push the Control knob towards left.
Return to first item	Push the Control knob towards left for at least 1 second.
Confirm item	Press the Control knob.

4 Start deleting

Select "OK" using the Control knob.

Number of files deleted

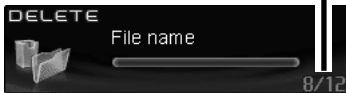

"Completed" is displayed when deleting completes.

Canceling delete

1 Cancel delete

Press the [FNC] button.
Exits Delete mode when pressed by step 3.

2 Select "YES"

Select "YES" using the Control knob.

5 Exit Delete mode.

Select "EXIT" using the Control knob.

Returns to step 3 if "NEXT" is selected.

Menu system

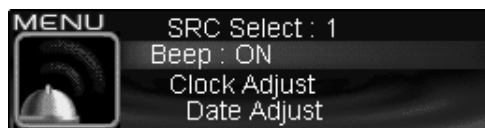
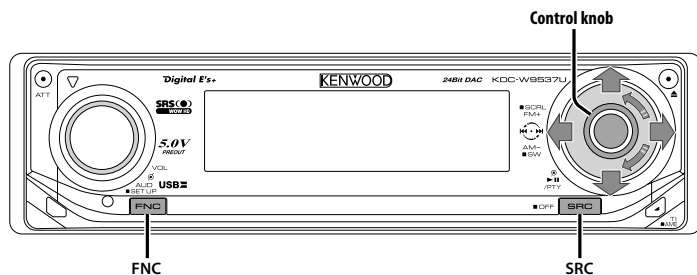

Function icon



Menu System

Setting beep sound during operation, etc. functions.

The Menu system basic operation method is explained here. The reference for the Menu items and their setting content is after this operation explanation.

1 Enter Menu mode

Using the Control knob, select "MENU".

For the operation method, refer to <Function Control mode> (page 11).

2 Select the menu item

Turn the Control knob or push it towards up or down.

Example: When you want to set the beep sound select the "Beep" display.

3 Set the menu item

Push the Control knob towards right or left.

Example: When you select "Beep", each time you push the knob it alternates between "Beep : ON" or "Beep : OFF". Select 1 of them as the setting.

You can continue by returning to step 2 and setting other items.

4 Exit Menu mode

Press the [FNC] button.



- When other items those applicable to the basic operation method above are displayed, their setting content chart is entered. (Normally the setting listed at the top of the chart is the original setting.) Also, the explanation for items that are not applicable (<Manual Clock Adjustment> etc.) are entered step by step.

Menu system

In Standby mode

Security Code

Activating the Security Code disables the usage of audio unit by someone else. Once the Security Code is activated, the entry of authorized Security Code is required to turn on the audio unit when it is removed from the vehicle. Indication of this Security Code activation prevents your precious audio unit from stealing.



- When you activate the Security Code function, it cannot be released.

Note, your Security Code is the 4 digit number entered in your "Car Audio Passport" in this package.

1 Enter Standby

Press the [SRC] button.

Select the "STANDBY" display.

Refer to <Selecting the Source> (page 8).

2 Enter Menu mode

Using the Control knob, select "MENU".

For the operation method, refer to <Function Control mode> (page 11).

"Security Set" is displayed.

3 Enter Security Code mode

Press the Control knob for at least 1 second.

When "Enter" is displayed, "SECURITY SET" is also displayed.

4 Select the digits to enter

Push the Control knob towards right or left.

5 Select the Security Code numbers

Turn the Control knob or push it towards up or down.

6 Repeat steps 4 and 5, and complete the Security Code.

7 Confirm the Security Code

Press the Control knob for at least 3 seconds.

When "Re-Enter" is displayed, "SECURITY SET" is also displayed.

8 Do the step 4 through 7 step operation, and reenter the security code.

"Approved" is displayed.

The Security Code function activates.



- If you enter a Code different from your Security Code, you have to start over from step 4.

9 Exit Security Code mode

Press the [FNC] button.

Resetting the Security Code function when the audio unit is first used after removed from the battery power source or the Reset button is pressed

1 Turn the power ON.

2 Do the step 4 through 7 step operation, and reenter the security code.

"Approved" is displayed.

Now, you can use the unit.



- If an incorrect code is entered, "Waiting" is displayed, and the input prohibition periods shown in the table below is generated.

After the input prohibition time lapses, "SECURITY" is displayed, and you can reenter the code.

Number of times the incorrect code was input	Input prohibited time
1	—
2	5 minutes
3	1 hour
4	24 hours

In Standby mode

Source Select Mode

Setting up the Source Select mode.

Display	Setting
"SRC Select : 1"	Displays source icons for your choice.
"SRC Select : 2"	Allows you to select sources one after another.

In USB mode with iPod connected

iPod mode setting

Setting up the iPod operation method in File Select.

Display	Setting
"iPod Mode : ON"	Uses the operation method similar to that of iPod.
"iPod Mode : OFF"	Uses the operation method different from that of iPod.

In Standby mode

Touch Sensor Tone

Setting the operation check sound (beep sound) ON/OFF.

Display	Setting
"Beep : ON"	Beep is heard.
"Beep : OFF"	Beep canceled.

In Standby mode

Manual Clock Adjustment



- You can do this adjustment when the <Synchronize Clock> (page 40) is set as OFF.

1 Select Clock Adjustment mode

Turn the Control knob.

Select the "Clock Adjust" display.

2 Enter Clock Adjust mode

Press the Control knob for at least 1 second.

The clock display blinks.

3 Selecting the item (hours or minutes) to adjust

Push the Control knob towards right or left.

The items that are blinking are items that you can adjust.

4 Adjust each item

Turn the Control knob or push it towards up or down.

5 Exit Clock adjustment mode

Press the [FNC] button.

In Standby mode

Date Adjustment

1 Select Date Adjust mode

Turn the Control knob.

Select the "Date Adjust" display.

2 Enter Date Adjust mode

Press the Control knob for at least 1 second.

The date display blinks.

3 Selecting the item (day, month, or year) to adjust

Push the Control knob towards right or left.

The items that are blinking are items that you can adjust.

4 Adjust each item

Turn the Control knob or push it towards up or down.

5 Repeat step 3 and 4 operation and adjust the date.

6 Exit Date adjustment mode

Press the [FNC] button.

In Standby mode

Date Mode

Setting the date format.

1 Select Date Mode

Turn the Control knob.

Select the "Date Mode" display.

2 Enter Date mode

Press the Control knob for at least 1 second.

3 Select the date format

Turn the Control knob or push it towards up or down.

4 Exit Date mode

Press the [FNC] button.

Menu system

In Standby mode

Synchronize Clock

Synchronizing the RDS station time data and this unit's clock.

Display	Setting
"SYNC : ON"	Synchronizes the time.
"SYNC : OFF"	Adjust the time manually.



- It takes 3 to 4 minutes to synchronize the clock.

In Standby mode

DSI (Disabled System Indicator)

A red indicator will blink on the unit after the faceplate is removed, warning potential thieves.

Display	Setting
"DSI : ON"	LED flashes.
"DSI : OFF"	LED OFF.

Display Illumination Control

This function turns off the display when you perform no operation for 5 seconds. This function is effective when you are driving at night.

Display	Setting
"Display : ON"	Keeps the display on.
"Display : OFF"	Turns off the display when you perform no operation for 5 seconds.



- Set the Display Illumination Control when the <Demonstration mode Setting> (page 46) is set to OFF.
- When the display is off, pressing any key will turn on the display.
- When the display is off, you cannot perform any operation except for the following:
 - Volume
 - Attenuator
 - Selecting the source
 - Ejecting the disc
 - Turning off the power
 - USB remove mode
- During function control, such as the Menu System, the display stays on.

In Standby mode

Dimmer

Dimming this unit's display automatically when the vehicle light switch is turned ON.

Display	Setting
"Dimmer : ON"	The display dims.
"Dimmer : OFF"	The display doesn't dim.

In Standby mode

Contrast Adjustment

Adjusting the display contrast.

Display and Setting
"Contrast : 1"
:
"Contrast : 4" (Original setting)

In Standby mode

Display-reversing Setting

If no operation is performed for a predetermined period of time, switching between negative and positive display modes takes place automatically. Display-reversing maintains the initial brightness of the display for a long period of time.

Display	Setting
"Display N/P : Auto"	Auto reverse display
"Display N/P : POSI"	Positive display only



- Switching between negative and positive display may not take place depending on the displayed mode.

In Standby mode

Built-in Amp Setting

Controlling the built-in amplifier.
Turning OFF this control enhances the preout quality.

Display	Setting
"AMP : ON"	The built-in amplifier activates.
"AMP : OFF"	The built-in amplifier deactivates.

*Other than Standby mode/
When the Dual Zone System is ON*

Dual Zone System Setting

Setting the Front channel and Rear channel sound in the Dual Zone System.

Display	Setting
"Zone 2 : Rear"	Sub source (Auxiliary input source) is to be rear channel.
"Zone 2 : Front"	Sub source (Auxiliary input source) is to be front channel.

Other than Standby mode

B.M.S. (Bass Management System)

Adjust the bass boost level of the external amplifier using the main unit.

Display	Setting
"AMP Bass : Flat"	Bass boost level is flat.
"AMP Bass : +6"	Bass boost level is low (+6dB).
"AMP Bass : +12"	Bass boost level is mid (+12dB).
"AMP Bass : +18"	Bass boost level is high (+18dB).



- Refer to the catalog or instruction manual for power amplifiers that can be controlled from this unit.
- For amplifiers, there are the models you can set from Flat to +18 dB, and the models you can set from Flat to +12 dB.

When an amplifier that can only be set to +12 is connected to the unit, "AMP Bass : +18" will not work correctly even if it is selected.

Other than Standby mode

B.M.S. Frequency Offset

Setting the central frequency, boosted by B.M.S.

Display	Setting
"AMP FREQ : Normal"	Boost with the normal central frequency.
"AMP FREQ : Low"	Drop the normal central frequency 20%.

When LX AMP unit connecting

AMP Control

You can control the LX AMP connected to the unit.

1 Select AMP Control mode

Turn the Control knob.

Select the "AMP Control" display.

2 Enter AMP Control mode

Press the Control knob for at least 1 second.

3 Select the AMP Control item for adjustment

Push the Control knob towards up or down.



- For the details on the AMP Control item, see the instruction manual attached to the LX AMP.

4 Adjust the AMP Control item

Push the Control knob towards right or left.

5 Exit AMP Control mode

Press the [FNC] button.



- You cannot use the LX AMP operation during standby mode.

Menu system

News Bulletin with Timeout Setting

The tuner automatically changes when a news bulletin starts even if the radio is not being listened to. Also, you can set the time interval when interruption is prohibited.

Display and Setting

"News : OFF"

"News : 00min"

⋮

"News : 90min"

When you set "News : 00min" — "News : 90min", the News Bulletin Interrupt function is ON.

When the news bulletin starts, "NEWS" is displayed, and the tuner changes to the news bulletin.



- If you choose the "News : 20min" setting, further news bulletins will not be received for 20 minutes once the first news bulletin is received.
- The news bulletin volume is the same level that was set for <Traffic Information> (page 23).
- This news bulletin function is only available if the desired station sends PTY-code for news bulletin or belongs to <Enhanced Other Network>-Network sending PTY-code for news bulletin.
- When the News Bulletin Interrupt function is ON, the tuner changes to an FM station.

In Tuner mode

Local Seek

Only stations whose reception is good are searched in auto seek tuning.

Display

"Local Seek : OFF"

"Local Seek : ON"

Setting

The local seek function is OFF.

The local seek function is ON.

In Tuner mode

Tuning Mode

Sets the tuning mode.

Tuning mode	Display	Operation
Auto seek	"Seek Mode : Auto1"	Automatic search for a station.
Preset station seek	"Seek Mode : Auto2"	Search in order of the stations in the Preset memory.
Manual	"Seek Mode : Manual"	Normal manual tuning control.

AF (Alternative Frequency)

When the reception is poor, automatically alternate to another frequency broadcasting the same program in the same RDS network with better reception.

Display	Setting
"AF : ON"	The AF function is ON.
"AF : OFF"	The AF function is OFF.

When the AF function is ON, the "RDS" indicator is ON.



- When no other stations with stronger reception are available for the same program in the RDS network, you may hear the incoming broadcast in bits and snatches. Turn OFF the AF function in such a case.

Restricting RDS Region (Region Restrict Function)

You can choose whether or not to restrict the RDS channels, received with the AF function for a particular network, to a specific region.

Display	Setting
"Regional : ON"	The Region Restrict Function is ON.
"Regional : OFF"	The Region Restrict Function is OFF.



- If AF function is not restricted to the specified region and network, the AF function sets up to search the station with good reception in the same RDS network.

Auto TP Seek

When the TI function is ON and the reception is poor while listening to a traffic information station, another traffic information station with better reception will be searched for automatically.

Display	Setting
"Auto TP Seek : ON"	The Auto TP Seek Function is ON.
"Auto TP Seek : OFF"	The Auto TP Seek Function is OFF.

In FM reception

Monaural Reception

You can reduce the noise when stereo broadcasts are received as monaural.

Display	Setting
"MONO : OFF"	The monaural reception is OFF.
"MONO : ON"	The monaural reception is ON.

Auxiliary Input Display Setting & Disc Naming

Selecting the display when alternating to Auxiliary input source. For the Disc Naming refer to the <Disc Naming (DNPS)> (page 30).

1 Select Auxiliary input source

Press the [SRC] button.

Select the "AUX"/ "AUX EXT" display.
Refer to <Selecting the Source> (page 8).

2 Enter Menu mode

Using the Control knob, select "MENU".

For the operation method, refer to <Function Control mode> (page 11).

3 Select Auxiliary input display setting mode

Turn the Control knob.

Select the "Name Set" display.

4 Enter Auxiliary input display setting mode

Press the Control knob for at least 1 second.

The selected Auxiliary input display is displayed.

5 Select the Auxiliary input display

Turn the Control knob or push it towards up or down.

Each time you push the knob, the display alternates as listed below.

- "AUX"/"AUX EXT"
- "DVD"
- "PORTABLE"
- "GAME"
- "VIDEO"
- "TV"

6 Exit Auxiliary input display setting mode

Press the [FNC] button.



- When operation stops for 10 seconds, the name at that time is registered, and the Auxiliary input display setting mode closes.
- The Auxiliary input display can be set only when the built-in auxiliary input or the auxiliary input of optional KCA-S220A is used.

Menu system

Function of KDC-W9537UY

In Standby mode

Selecting Russian Characters

Setting up the display of Russian characters and undistinguishable English characters.

Display	Setting
"Russian : ON"	Displays texts using Russian characters.
"Russian : OFF"	Displays texts using European characters.



- Texts displayed using Russian characters are as follows.
 - Folder name/ File name/ Music title/ Artist name/ Album name
 - KCA-BT100 (optional accessory)
- Texts cannot distinguish upper case and lower case in Russian characters.

Text Scroll

Setting the displayed text scroll.

Display	Setting
"Scroll : Manual"	Doesn't scroll.
"Scroll : Auto"	Scrolls when the display changes.



- The text scrolled is listed below.
 - CD text
 - Folder name/ File name/ Music title/ Artist name/ Album name
 - MD title
 - Radio text

In Standby mode

Built-in Auxiliary input Setting

Set the Built-in Auxiliary Input function.

Display	Setting
"Built in AUX : OFF"	When selecting the source there's no Auxiliary Input.
"Built in AUX : ON"	When selecting the source there's Auxiliary Input.

In Standby mode

Power OFF Timer

Setting the timer to turn this unit's power OFF automatically when Standby mode continues. Using this setting can save the vehicle's battery power.

Display	Setting
"Power OFF : - - - -"	Power OFF Timer function is OFF.
"Power OFF : 20min" (Original setting)	Turns the power OFF after 20 minutes.
"Power OFF : 40min"	Turns the power OFF after 40 minutes.
"Power OFF : 60min"	Turns the power OFF after 60 minutes.

In Standby mode

CD Read Setting

When there is a problem with playing a CD with special format, this setting plays the CD by force.

Display	Setting
"CD Read : 1"	Play CD and Audio file.
"CD Read : 2"	Play CD by force.



- Some music CDs may not play even in the "CD Read : 2" mode.

In Standby mode

Picture downloading

Downloading wallpapers. You can use downloaded pictures for the display of this unit.

1 Connected the USB device or Insert a CD-R/CD-RW

Connect the USB device containing the files to be downloaded into this unit.

Or with the USB device removed, insert a CD-R/CD-RW containing files to be downloaded into this unit.

Refer to <Playing CD & Audio file> (page 26) for details.



- Our URL <http://www.kenwood.net-disp.com> describes how to make CD-R/CD-RW/USB device.

2 Enter Standby

Press the [SRC] button.

Select the "STANDBY" display.

Refer to <Selecting the Source> (page 8).

3 Enter Menu mode

Using the Control knob, select "MENU".

For the operation method, refer to <Function Control mode> (page 11).

4 Select the picture downloading

Turn the Control knob.

Select the "DISP Data DL" display.

5 Enter the downloading mode

Press the Control knob for at least 1 second.

"File Check!!" display blinks.

6 Select files to be downloaded

Turn the Control knob or push it towards up or down.

Press the Control knob.

7 Start downloading

Select "YES" using the Control knob.

When the downloading finishes, "Finished" is displayed.



- Picture downloading may take as long as 20 minutes.



Canceling Downloading

Press the [FNC] button.

8 Exit the downloading mode

Press the [FNC] button.



- Do not operate this unit while downloading to prevent data from being damaged.
- The number of files that can be downloaded.
 - Wallpaper: 1 file
- When a new wallpaper is downloaded, it is overwritten to the currently downloaded wallpaper. There is no way to delete the downloaded pictures.
- The downloaded pictures can be used for display. <Graphic Display Selection> (page 17)
- When you cannot download the pictures to this unit, there may be a problem with the CD-R/CD-RW/USB device write method. Refer to the URL <http://www.kenwood.net-disp.com>.

PICTURE ENGINE

Picture Engine is an application software distributed from Kenwood's official website. Utilizing this software, you can create an original still image file. As for the download of application, please browse "<http://www.kenwood.net-disp.com/>" for directions.

Menu system

In Standby mode

Firmware version display

Displaying the firmware version with the unit.

Turn the Control knob.

Select the "F/W Version : " display.

In Internal Memory source

Internal Memory Format

Perform format to delete all audio files stored in internal memory.



- The content of formatted memory cannot be restored. Be careful when formatting.

1 Enter Internal Memory

Press the [SRC] button.

Select the "Internal Memory" display.

2 Enter Menu mode

Using the Control knob, select "MENU".

For the operation method, refer to <Function Control mode> (page 11).

3 Select the Internal Memory Format

Turn the Control knob.

Select the "INT.MEM.Format" display.

4 Enter the Formatting mode

Press the Control knob for at least 1 second.

"Format?" is displayed.

5 Start format

Select "YES" using the Control knob.

"Format..." display blinks.

When the formatting finishes, "Completed" is displayed.

6 Exit Formatting mode

Press the [FNC] button.

In Standby mode

Demonstration mode setting

Sets the demonstration mode.

1 Select the Demonstration mode

Turn the Control knob.

Select the "DEMO Mode" display.

2 Set the Demonstration mode

Press the Control knob for at least 2 seconds.

Each time you press the knob at least 2 seconds, the Demonstration mode alternates between the settings shown in the table below.

Display	Setting
"DEMO Mode : ON"	The Demonstration mode function is ON.
"DEMO Mode : OFF"	Exit Demonstration mode (Normal mode).

Basic Operations of remote control

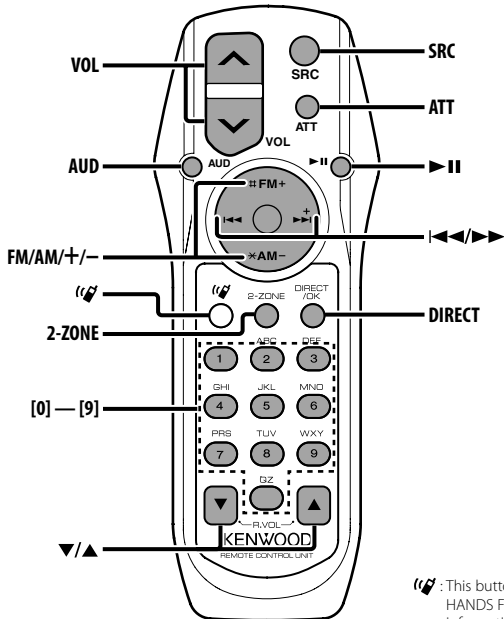

: This button is used when Kenwood Bluetooth HANDS FREE BOX is connected. For more information, refer to the instruction manual of Bluetooth HANDS FREE BOX.

Loading and Replacing the battery

Use two "AA"/ "R6"-size batteries.
Slide the cover while pressing downwards to remove it as illustrated.
Insert the batteries with the + and – poles aligned properly, following the illustration inside the case.

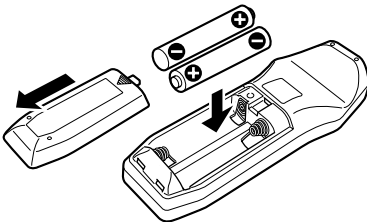

▲WARNING

- Store unused batteries out of the reach of children.
Contact a doctor immediately if the battery is accidentally swallowed.



- Do not set the remote control in hot places such as on the dashboard.

Basic operations

[VOL] buttons

Adjusts the volume.

[SRC] button

Each time you press the button, the source alternates.

For the source alternating order refer to <Selecting the Source> (page 8).

[ATT] button

Turns the volume down quickly.

When the button is pressed again, the volume returns to the previous level.

Basic Operations of remote control

Audio Control

[AUD] button

Selects the Audio item to be adjusted.

[VOL] buttons

Adjusts the Audio item.



- Refer to <Audio Control> (page 9) for the operation method, such as the procedures for Audio control and others operations.

Dual Zone System

[2-ZONE] button

Each time you press the button, "2 ZONE" of <Audio Setup> (page 9) is turned ON or OFF.

[▲]/ [▼] buttons

Adjusts the volume of the rear channel.
The rear channel activates while the Dual Zone System is ON.

In Tuner source

[FM]/ [AM] buttons

Selects the band.
Each time you press the [FM] button, the band alternates between the FM1, FM2, and FM3 bands.

[◀◀]/ [▶▶] buttons

Tune up or down band.

[0] — [9] buttons

Press buttons [1] — [6] to recall preset stations.

[DIRECT] button

Enters and cancels the <Direct Access Tuning> (page 21) mode.

[▶ II] button

Enters and cancels the <PTY (Program Type)> (page 24) mode.

In Disc/USB (iPod)/Internal Memory source

[◀◀]/ [▶▶] buttons

Going forwards and backwards between music.

[+]/ [-] buttons

Going forwards and backwards between disc/ folders.

[▶ II] button

Each time you press the button, the music is played or paused.

[0] — [9] buttons

When in <Direct Music Search> (page 28) and <Direct Disc Search> (page 28), enters the music/ disc number.

Accessories/ Installation Procedure

Accessories

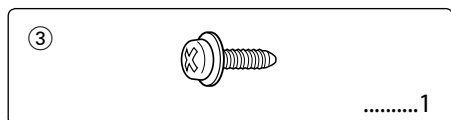
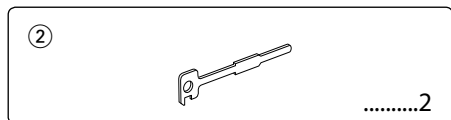
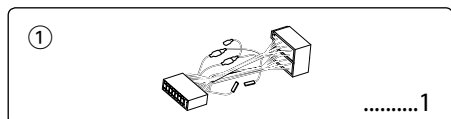

Installation Procedure

1. To prevent short circuits, remove the key from the ignition and disconnect the ⊖ terminal of the battery.
2. Make the proper input and output wire connections for each unit.
3. Connect the wire on the wiring harness.
4. Take Connector B on the wiring harness and connect it to the speaker connector in your vehicle.
5. Take Connector A on the wiring harness and connect it to the external power connector on your vehicle.
6. Connect the wiring harness connector to the unit.
7. Install the unit in your car.
8. Reconnect the ⊖ terminal of the battery.
9. Press the reset button.



- If the power is not turned ON ("Protect" is displayed), the speaker wire may have a short-circuit or touched the chassis of the vehicle and the protection function may have been activated. Therefore, the speaker wire should be checked.
- Use a commercially available conversion connector if the connector does not fit in the vehicle connector.
- If your car is not prepared for this special connection-system, consult your Kenwood dealer.

- Make sure that all wire connections are securely made by inserting jacks until they lock completely.
- If your vehicle's ignition does not have an ACC position, or if the ignition wire is connected to a power source with constant voltage such as a battery wire, the power will not be linked with the ignition (i.e., it will not turn on and off along with the ignition). If you want to link the unit's power with the ignition, connect the ignition wire to a power source that can be turned on and off with the ignition key.
- If the fuse blows, first make sure that the wires have not caused a short circuit, then replace the old fuse with one with the same rating.
- Insulate unconnected wires with vinyl tape or other similar material. To prevent short circuits, also do not remove the caps on the ends of the unconnected wires or the terminals.
- Connect the speaker wires correctly to the terminals to which they correspond. The unit may receive damage or fail to work if you share the ⊖ wires and/or ground them to any metal part in the car.
- After the unit is installed, check whether the brake lamps, indicators, wipers, etc. on the car are working properly.
- If the console has a lid, make sure to install the unit so that the faceplate does not hit the lid when closing and opening.
- Mount the unit so that the mounting angle is 30° or less.

If You Want to Connect iPod

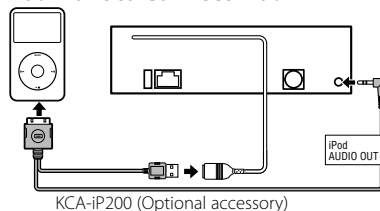

- No other optional accessory can be connected because the USB connector and the AUX input are used for iPod connection.
- Dual Zone System in <Audio Setup> (page 9) will become unavailable.

Connecting Wires to Terminals

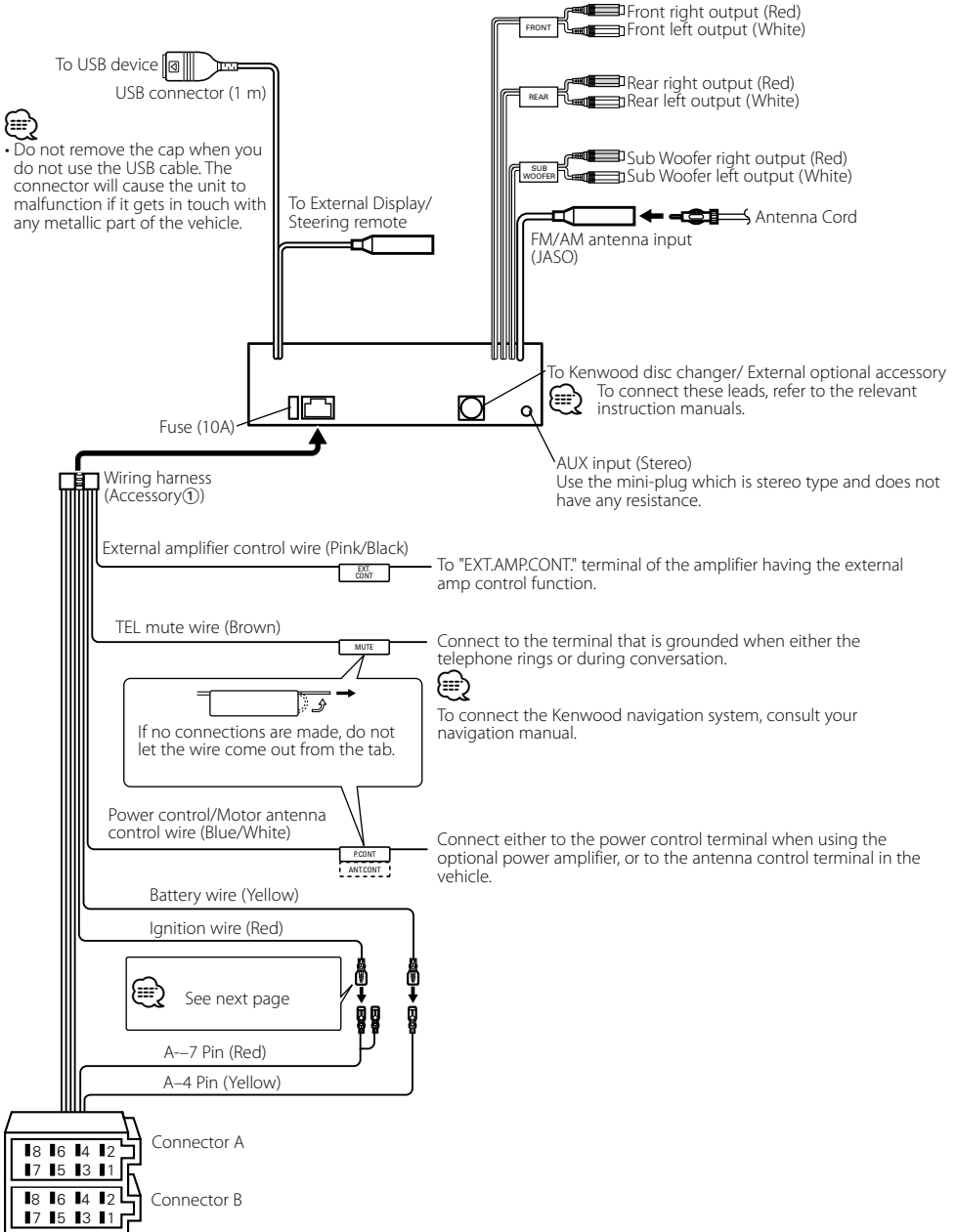

Connector Function Guide

Pin Numbers for ISO Connectors	Cable Colour	Functions
External Power Connector		
A-4	Yellow	Battery
A-5	Blue/White	Power Control
A-6	Orange/White	Dimmer
A-7	Red	Ignition (ACC)
A-8	Black	Earth (Ground) Connection
Speaker Connector		
B-1	Purple	Rear Right (+)
B-2	Purple/Black	Rear Right (-)
B-3	Gray	Front Right (+)
B-4	Gray/Black	Front Right (-)
B-5	White	Front Left (+)
B-6	White/Black	Front Left (-)
B-7	Green	Rear Left (+)
B-8	Green/Black	Rear Left (-)

⚠ WARNING

Connecting the ISO Connector

The pin arrangement for the ISO connectors depends on the type of vehicle you drive. Make sure to make the proper connections to prevent damage to the unit.

The default connection for the wiring harness is described in [1] below. If the ISO connector pins are set as described in [2] or [3], make the connection as illustrated.

Please be sure to reconnect the cable as shown [2] below to install this unit to the **Volkswagen** vehicles etc.

- [1] (Default setting) The A-7 pin (red) of the vehicle's ISO connector is linked with the ignition, and the A-4 pin (yellow) is connected to the constant power supply.

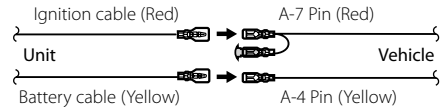

- [2] The A-7 pin (red) of the vehicle's ISO connector is connected to the constant power supply, and the A-4 pin (yellow) is linked to the ignition.

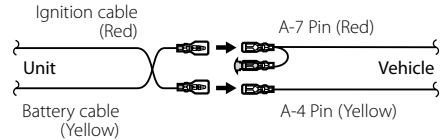

- [3] The A-4 pin (yellow) of the vehicle's ISO connector is not connected to anything, while the A-7 pin (red) is connected to the constant power supply (or both the A-7 (red) and A-4 (yellow) pins are connected to the constant power supply).

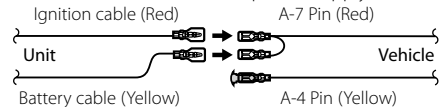

- When the connection is made as in [3] above, the unit's power will not be linked to the ignition key. For that reason, always make sure to turn off the unit's power when the ignition is turned off.

To link the unit's power to the ignition, connect the ignition cable (ACC...red) to a power source that can be turned on and off with the ignition key.

Installation/Removing the Unit

Installation

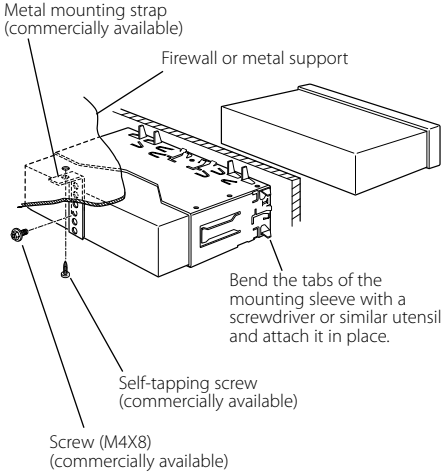

- Make sure that the unit is installed securely in place. If the unit is unstable, it may malfunction (for example, the sound may skip).

Screwing the Faceplate on the Unit

If you want to fasten the faceplate to the main unit so that it does not fall off, screw in the provided screws in the holes shown below.

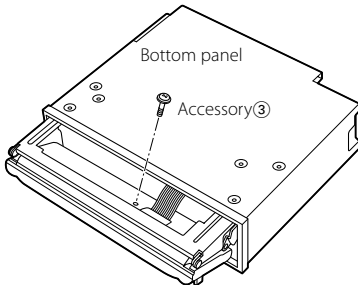

- Never insert the screw in any other screw hole than the one specified. If you screw them in another hole, it will contact and may cause damage to the mechanical parts inside the unit.

Removing the hard rubber frame

- 1 Engage the catch pins on the removal tool and remove the two locks on the upper level. Upper the frame and pull it forward as shown in the figure.

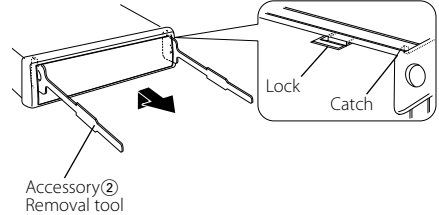

- 2 When the upper level is removed, remove the lower two locations.



- The frame can be removed from the bottom side in the same manner.

Removing the Unit

- 1 Refer to the section <Removing the hard rubber frame> and then remove the hard rubber frame.
- 2 Remove the screw (M4 x 8) on the back panel.
- 3 Insert the two removal tools deeply into the slots on each side, as shown.
- 4 Lower the removal tool toward the bottom, and pull out the unit halfway while pressing towards the inside.

Screw (M4X8)
(commercially available)

Accessory ②

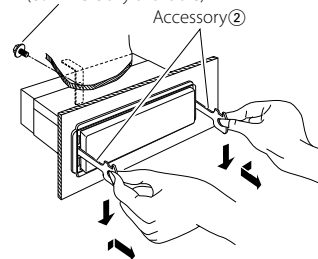

- Be careful to avoid injury from the catch pins on the removal tool.
- 5 Pull the unit all the way out with your hands, being careful not to drop it.

Troubleshooting Guide

Disc source

? The specified disc does not play, but another one plays instead.

- ✓ The specified CD is quite dirty.
 - ☞ Clean the CD.
- ✓ The disc is loaded in a different slot from that specified.
 - ☞ Eject the disc magazine and check the number for the specified disc.
- ✓ The disc is severely scratched.
 - ☞ Try another disc instead.

? Cannot remove disc.

- ✓ Downloading picture.
 - ☞ Eject is disabled while downloading picture.

Audio file source

? The sound skips when an Audio file is being played.

- ✓ The media is scratched or dirty.
 - ☞ Clean the media, referring to the CD cleaning of the section on <Handling CDs> (page 7).
- ✓ The audio file is broken or not supported.
 - ☞ Damaged and unsupported files are skipped.
- ✓ The recording condition is bad.
 - ☞ Record the media again or use another media.

USB device source

? The USB device is not detected.

- ✓ The USB connector is disconnected.
 - ☞ Connect the connector of the USB device properly.

? The USB device does not play its audio files.

- ✓ The USB connector is disconnected.
 - ☞ Connect the connector of the USB device properly.

? Cannot USB remove mode.

- ✓ Downloading picture.
 - ☞ USB remove mode is disabled while downloading picture.

The messages shown below display your systems condition.

- Eject: • No disc magazine has been loaded in the changer. The disc magazine is not completely loaded.
• No CD in the unit.
- No Disc: No disc has been loaded in the disc magazine.
- TOC Error: • No disc has been loaded in the disc magazine.
• The CD is quite dirty. The CD is upside-down. The CD is scratched a lot.

- Read Error: • The number of files or folders which are stored in the connected USB device is above the limitation.
• The file system of the connected USB device is broken.
☞ Copy the files and folders for the USB device again referring to <http://www.kenwood.com/usb/>. If the error message is still displayed, initialize the USB device or use other USB devices.
- Error 05: The disc is unreadable.
- Blank Disc: Nothing has been recorded on the MD.
- No Track: No tracks are recorded on the MD, although it has a title.
- No Panel: The faceplate of the slave unit being connected to this unit has been removed.
- Error 77: The unit is malfunctioning for some reason.
☞ Press the reset button on the unit. If the "Error 77" code does not disappear, consult your nearest service center.
- Mecha Error: Something is wrong with the disc magazine. Or the unit is malfunctioning for some reason.
☞ Check the disc magazine. And then press the reset button on the unit. If the "Mecha Error" code does not disappear, consult your nearest service center.
- Hold Error: The protective circuit in the unit activates when the temperature inside the automatic disc changer exceeds 60°C (140°F), stopping all operation.
☞ Cool down the unit by opening the windows or turning on the air conditioner. As the temperature falls below 60°C (140°F), the disc will start playing again.
- No Name: Attempted to display DNPS during the CD play having no disc names preset.
- Waiting: Radio text data is being received. Radio text plus requires more time to load than radio text.
- Load: Discs are being exchanged in the Disc changer.
- Checking:
Reading: The unit is reading the data on the disc, USB device or Internal Memory.
- IN (Blink): The CD player section is not operating properly.
☞ Reinsert the CD. If the CD cannot be ejected or the display continues to flash even when the CD has been properly reinserted, please switch off the power and consult your nearest service center.

Protect:	The speaker wire has a short-circuit or touches the chassis of the vehicle, and then the protection function is activated. <ul style="list-style-type: none"> ➤ Wire or insulate the speaker cable properly and press the reset button. If the "Protect" code does not disappear, consult your nearest service center. 	Over Capacity:	Recording or copying was canceled because internal memory space ran out while recording from music CD or copying from USB device. <ul style="list-style-type: none"> ➤ Delete unnecessary files and record or copy once more.
Unsupported File:	An Audio file is played with a format that this unit cannot support.	Name Exists. Rename... :	The name entered while recording CD already exists. Or a file or folder with the same name already exists while copying from USB device. <ul style="list-style-type: none"> ➤ Change the name or delete the existing file and record or copy once more.
Copy Protection:	A copy-protected file is played.	Name Exists. Auto Rename? :	
DEMO MODE:	The Demonstration mode has been selected. <ul style="list-style-type: none"> ➤ The <Demonstration mode Setting> (page 46) is ON. Turn it OFF. 	Import Error:	Recording is canceled because there is a scratch on the CD and it cannot be played.
No Device:	The USB device is selected as a source although no USB device is connected.	Copy Error:	<ul style="list-style-type: none"> • An incompatible digital audio player was used. • Cannot copy because the USB device is not firmly inserted.
N/A Device:	An unsupported USB device is connected. <ul style="list-style-type: none"> ➤ For the supported USB devices, refer to <http://www.kenwood.com/usb/>. 	Delete Error:	
No Music Data/ Error 15:	<ul style="list-style-type: none"> • The connected USB device contains no playable audio file. • The Internal Memory source contains no playable audio file. • Media was played that does not have data recorded that the unit can play. 	Format Error:	Abnormal condition detected while deleting or formatting. <ul style="list-style-type: none"> ➤ Repeat the operation once more. This may take some time. If the message recurs, contact your nearest Kenwood dealer.
USB ERROR:	The connected USB device is rated a current capacity higher than the allowable limit. <ul style="list-style-type: none"> ➤ Check the USB device with reference to <http://www.kenwood.com/usb/>. Some trouble may have occurred to the connected USB device. <ul style="list-style-type: none"> ➤ Change the source to any source other than USB. Remove the USB device. 	Can't Download:	
iPod Error:	Connection to the iPod has failed. <ul style="list-style-type: none"> ➤ Remove the USB device and then reconnect it. ➤ Confirm that the software for the iPod is the latest version. 	Download Error:	This unit does not work properly for some reason. <ul style="list-style-type: none"> ➤ Press the reset button to download it again. If this error is still displayed, consult a local Kenwood dealer. ➤ Try all over again from the start. If this error is still displayed, consult a local Kenwood dealer.
USB REMOVE:	The Remove mode has been selected for the USB device. You can remove the USB device safely.	No Display File:	No file that can be downloaded is contained in the CD-R/ CD-RW/ USB device. <ul style="list-style-type: none"> ➤ Make sure that a files created with referring to <http://www.kenwood.net-dsp.com> is contained in the CD-R/ CD-RW/ USB device. Do not delete the extension (.kbn) created when the file was created.
		Incorrect File:	The file selected to be downloaded has a format that this unit cannot read. <ul style="list-style-type: none"> ➤ Recreate the file.
		Writing Error:	Writing failed while the file was downloaded. <ul style="list-style-type: none"> ➤ Try the downloading again.

Specifications

Specifications subject to change without notice.

FM tuner section

- Frequency range (50 kHz space)
 - : 87.5 MHz – 108.0 MHz
- Usable sensitivity (S/N = 26dB)
 - : 0.7 μ V/75 Ω
- Quieting Sensitivity (S/N = 46dB)
 - : 1.6 μ V/75 Ω
- Frequency response (\pm 3.0 dB)
 - : 30 Hz – 15 kHz
- Signal to Noise ratio (MONO)
 - : 65 dB
- Selectivity (DIN) (\pm 400 kHz)
 - : \geq 80 dB
- Stereo separation (1 kHz)
 - : 35 dB

MW tuner section

- Frequency range (9 kHz space)
 - : 531 kHz – 1611 kHz
- Usable sensitivity (S/N = 20dB)
 - : 25 μ V

LW tuner section

- Frequency range
 - : 153 kHz – 281 kHz
- Usable sensitivity (S/N = 20dB)
 - : 45 μ V

CD player section

- Laser diode
 - : GaAlAs
- Digital filter (D/A)
 - : 8 Times Over Sampling
- D/A Converter
 - : 1 Bit
- Spindle speed (Audio file)
 - : 1000 – 400 rpm (CLV 2times)
- Wow & Flutter
 - : Below Measurable Limit
- Frequency response (\pm 1 dB)
 - : 10 Hz – 20 kHz
- Total harmonic distortion (1 kHz)
 - : 0.008 %
- Signal to Noise ratio (1 kHz)
 - : 110 dB
- Dynamic range
 - : 93 dB
- MP3 decode
 - : Compliant with MPEG-1/2 Audio Layer-3
- WMA decode
 - : Compliant with Windows Media Audio
- AAC decode
 - : AAC-LC ".m4a" files

- WAV decode
 - : Linear-PCM

USB Interface

- USB Standard
 - : USB 1.1/ 2.0
- Maximum Supply current
 - : 500 mA
- File System
 - : FAT16/ 32
- MP3 decode
 - : Compliant with MPEG-1/2 Audio Layer-3
- WMA decode
 - : Compliant with Windows Media Audio
- AAC decode
 - : AAC-LC ".m4a" files
- WAV decode
 - : Linear-PCM

Audio section

- Maximum output power
 - : 50 W x 4
- Output power (DIN 45324, +B=14.4V)
 - : 30 W x 4
- Speaker Impedance
 - : 4 – 8 Ω
- Tone action
 - Band 1 : 60 – 200 Hz \pm 9 dB
 - Band 2 : 250 – 1k Hz \pm 9 dB
 - Band 3 : 1.25k – 4k Hz \pm 9 dB
 - Band 4 : 5k – 16k Hz \pm 9 dB
- Preout level / Load (during disc play)
 - : 5000 mV/10 k Ω
- Preout impedance (during disc play)
 - : \leq 80 Ω

Auxiliary input

- Frequency response (\pm 1 dB)
 - : 20 Hz – 20 kHz
- Input Maximum Voltage
 - : 1200 mV
- Input Impedance
 - : 100 k Ω

General

- Operating voltage (11 – 16V allowable)
 - : 14.4 V
- Current consumption
 - : 10 A
- Installation Size (W x H x D)
 - : 182 x 53 x 155 mm
- Weight
 - : 1.5 kg