

USER MANUAL

04/08/16 CHANNELS

DIGITAL VIDEO RECORDER

INSTRUCTION MANUAL

To obtain the best performance and ensure device function correctly, please read this instruction manual carefully and completely.

INSTRUCTION MANUAL

To obtain the best performance and ensure device function correctly, please read this instruction manual carefully and completely.

FCC Compliance

USER-INSTALLER CAUTION: YOUR AUTHORITY TO OPERATE THIS FCC VERIFIED EQUIPMENT COULD BE VOIDED IF YOU MAKE CHANGES OR MODIFICATIONS NOT EXPRESSLY APPROVED BY THE PARTY RESPONSIBLE FOR COMPLIANCE TO PART 15 OF THE FCC RULES.

NOTE: THIS EQUIPMENT HAS BEEN TESTED AND FOUND TO COMPLY WITH THE LIMITS FOR A CLASS A DIGITAL DEVICE, PURSUANT TO PART 15 OF THE FCC RULES. THESE LIMITS ARE DESIGNED TO PROVIDE REASONABLE PROTECTION AGAINST HARMFUL INTERFERENCE WHEN THE EQUIPMENT IS OPERATED IN A COMMERCIAL ENVIRONMENT. THIS EQUIPMENT GENERATES, USES, AND CAN RADIATE RADIO FREQUENCY ENERGY AND IF NOT INSTALLED AND USED IN ACCORDANCE WITH THE INSTRUCTION MANUAL, MAY CAUSE HARMFUL INTERFERENCE TO RADIO COMMUNICATIONS.

OPERATION OF THIS EQUIPMENT IN A RESIDENTIAL AREA IS LIKELY TO CAUSE HARMFUL INTERFERENCE IN WHICH CASE THE USER WILL BE REQUIRED TO CORRECT THE INTERFERENCE AT HIS OWN EXPENSE.

THIS CLASS A DIGITAL APPARATUS MEETS ALL REQUIREMENTS OF THE CANADIAN INTERFERENCE-CAUSING EQUIPMENT REGULATIONS.



WARNINGS, CAUTIONS & COPYRIGHT

WARNINGS



TO REDUCE THE RISK OF FIRE OR ELECTRIC SHOCK, DO NOT EXPOSE THIS PRODUCT TO RAIN OR MISTURE.

DO NOT INSERT ANY METALLIC OBJECT THROUGH VENTILATION GRILLS.

CAUTION

	CAUTION RISK OF ELECTRIC SHOCK DO NOT OPEN	
<p>CAUTION: TO REDUCE THE RISK OF ELECTRIC SHOCK. DO NOT REMOVE COVER (OR BACK). NO USER-SERVICEABLE PARTS INSIDE. REFER SERVICING TO QUALIFIED SERVICE PERSONNEL.</p>		

Explanation of Graphical Symbols

	The lightning flash with arrowhead symbol, within an equilateral triangle, is intended to alert the user to the presence of insinuated "dangerous voltage" within the products enclosure that may be of sufficient magnitude to constitute a risk of electric shock to persons.
	The exclamation point within an equilateral rhombus is intended to alert the user to the presence of important operating and maintenance (servicing) instruction in the literature accompanying the product.

USERS OF THE SYSTEM ARE RESPONSIBLE FOR CHECKING AND COMPLYING WITH ALL FEDERAL, STATE, AND LOCAL LAWS AND STATUTES COIPCERNING THE MONITORING AND RECORDING OF VIDEO AND AUDIO SIGNALS. ULTRAK SHALL NOT BE HELD RESPONSIBLE FOR THE USE OF THIS SYSTEM IN VIOLATION OF CURRENT LAWS AND STATUTES.

COPYRIGHT

THE TRADEMARKS MENTIONED IN THE MANUAL ARE LEGALLY REGISTERED TO THEIR RESPECTIVE COMPANIES.

TABLE OF CONTENTS

1	INTRODUCTION	5
1.1	FEATURE.....	5
1.2	SPECIFICATION.....	5
2	HARDWARE OVERVIEW	8
2.1	FRONT PANEL.....	8
2.2	BACK PANEL.....	10
2.3	ADVANCED AUTO SWITCH, ZOOM, PTZ, COPY KEY CONTROL & USB INFORMATION.....	12
2.4	EXTERAL ALARM.....	12
2.5	IR REMOTE CONTROL.....	14
3	SYSTEM SETUP	15
3.1	MENU SETUP INTERFACE(GUI).....	15
3.2	LIVE VIEWING AND POP-UP MENU.....	17
3.3	CAMERA SETUP.....	19
3.4	MOTION SETUP.....	21
3.5	RECORD SETUP.....	23
3.6	ALARM SETUP.....	27
3.7	NETWORK SETUP.....	27
3.8	SYSTEM SETUP.....	30
3.9	HARD DISK SETUP.....	33
3.10	BACKUP SETUP.....	34
4	DVR PLAYBACK	36
4.1	TIME SEARCH.....	37
4.2	EVENT SEARCH.....	38
5	BACKUP PLAYBACK	39
5.1	MAIN SCREEN SETTING.....	39
5.2	CD/DVD BACKUP PLAYBACK.....	44
5.3	USB & LOCAL BACKUP FILE PLAYBACK.....	45
5.4	BACKUP FILE TO AVI.....	47
6	NETWORK VIEWING & PLAYBACK	48
6.1	IP ADDRESS SETUP ON PC SITE.....	48
6.2	OPTIONAL MICROSOFT INTERNET EXPLORER SETUP.....	49
6.3	LOGIN.....	52
6.4	REMOTE CONTROL.....	53
6.5	CONFIGURE.....	58
7	3GPP APPLICATION & SETTING	66
	APPENDIX A: RECORDING TIME LAPSE (HOURS)	68
	FULL D1- 720x480	68

HALF D1- 720x240 70
CIF-360x240 73
APPENDIX B: HDD COMPATIBLE TABLE 76
APPENDIX C: ERROR MESSAGE LIST..... 77

1 INTRODUCTION

1.1 FEATURE

- H.264 video compression.
- 120 PPS
- Recording quality/ rate adjustment per channel available.
- Support CMS (Central Management System)/ 3GPP.
- Audio Backup / Audio Streaming.
- Graphic User Interface (GUI).
- Support time-point backup function under Ethernet remote control mode. User can select any time period to process backup from remote side.
- Support time-search & event-search function under Ethernet remote control mode.
- Up to four online clients for independent remote control; individual live-time, play-back & time-search function available.
- Support PPPoE/ Static/ DHCP IP & DDNS.
- Real Triplex, recording/ live-time & playback operation at the same time available.
- ID function supplied from IR remote controller. User can control different DVRs at the same time by using one IR remote controller.

1.2 SPECIFICATION

VIDEO			
MODEL NO.	DVR204	DVR208	DVR216
MODE	Triplex		
LIVE-TIME RESOLUTION	NTSC: 720x480 PAL: 720x576	NTSC: 720x480 PAL: 720x576	NTSC: 720x480 PAL: 720x576
LIVE-TIME DISPLAY RATE (ANALOG MODE)/ (Frame / Sec)	NTSC: 4 x 30 PAL: 4 x 25	NTSC: 4 x 30 PAL: 4 x 25	NTSC: 4 x 30 PAL: 4 x 25
SPLIT SCREEN	1, 4	1, 4, 9	1, 4, 9, 13, 16
VIDEO INPUT	BNC x 4	BNC x 8	BNC x 16
VIDEO OUTPUT (BNC)	BNC x 1	BNC x 2	BNC x 1
VIDEO OUTPUT (SPOT MONITOR)	NO	NO	BNC x 1
VIDEO OUTPUT (S-VIDEO)	NO	1	NO
VIDEO OUTPUT (VGA)	Yes	Yes	Yes
AUDIO			
AUDIO INPUT	RCA x 1		
AUDIO OUTPUT	RCA x 1		
AUDIO BACKUP	Yes		

AUDIO STREAMING	Yes	
RECORDING		
COMPRESSION TYPE	H.264	
RECORDING RESOLUTION	NTSC: 720 x 480/ PAL: 720 x 576 NTSC: 720 x 240/ PAL: 720 x 288 NTSC: 360 x 240/ PAL: 360 x 288	
RECORDING RATE (FULL D1)	NTSC: 720 x 480 up to 30 PPS PAL: 720 x 576 up to 25 PPS	NTSC: 720 x 480 up to 60 PPS PAL: 720 x 576 up to 50 PPS
RECORDING RATE (HALF D1)	NTSC: 720 x 240 up to 60 PPS PAL: 720 x 288 up to 50 PPS	NTSC: 720 x 240 up to 120 PPS PAL: 720 x 288 up to 100 PPS
RECORDING RATE (CIF)	NTSC: 360 x 240 up to 120 PPS PAL: 360 x 288 up to 100 PPS	NTSC: 360 x 240 up to 240 PPS PAL: 360 x 288 up to 200 PPS
RECORDING MODE	Manual / Schedule / Alarm	
PLAYBACK & SEARCH		
PLAYBACK SPEED	Fast Forward X 2 X 4 X 8 Fast Backward X 2 X 4 X 8 field by field Playback Pause	
TIME SEARCH	Yes	
EVENT SEARCH	Yes	
EVENT LIST	3000 records per H.D.D (Maximum)	
OSD & CONTROL INTERFACE		
TITLE	8 Characters	
ON SCREEN DISPLAY & SETUP	Time / Date / Setup Menu	
GRAPHIC USER INTERFACE (GUI)	Yes	
DVR CONTROL PANEL	Yes	
MOUSE	Yes	
IR REMOTE CONTROLLER	Yes	
IE BROWSER	Yes	
PLAYER	Yes	
STORAGE & BACKUP DEVICE		
INTERNAL HDD SUPPORT	SATA HDD x 1	SATA HDD x 2
USB PAN DRIVE BACKUP	Yes	
CD/ DVD RW BACKUP	No	

NETWORK			
ETHERNET	Yes		
ETHERNET COMPRESSION FORMAT	H.264		
DDNS	Yes		
E-MAIL & FTP	Yes		
NETWORK IP	Static/ Dynamic/ PPPoE		
MULTI-REMOTE CLIENT	Yes (4 Clients at the same time available)		
PDA/ CELL PHONE SUPPORT	Yes (MPEG4)		
3GPP	Yes (MPEG4)		
ALARM			
ALARM INPUT	4 In (NO/ NC)		
ALARM OUTPUT	1 Out (NO/ NC)		
MOTION DETECTION	Yes		
VIDEO LOSS DETECTION	Yes		
ALARM RECORDING	Yes		
BUZZER	Yes		
SETUP & OTHER FUNCTIONS			
DAYLIGHT SAVING TIME	Yes		
PTZ CONTROL	Yes		
RS-232	No		
RS-485	Yes		
DIGITAL ZOOM	Yes		
PASSWORD CONTROL	Two levels, one for system and the other for HDD format		
KEY-LOCK	Yes		
MULTI-LANGUAGE	Yes		
FIRMWARE UPDATE	USB Host & Update on line		
OTHERS			
POWER INPUT	DC 12V		
POWER CONSUMPTION	12W (without HDD)	16W (without HDD)	22W (without HDD)
DIMENSIONS (W x H x D)	230mm x 44mm x 215mm	360mm x 60mm x 308mm	
WEIGHT (kg)	1.4(without HDD)	3.0(without HDD)	
OPERATION TEMPERATURE	0 - 40 °C		

* SPECIFICATIONS ARE SUBJECT TO CHANGE WITHOUT NOTICE

2 HARDWARE OVERVIEW

2.1 FRONT PANEL

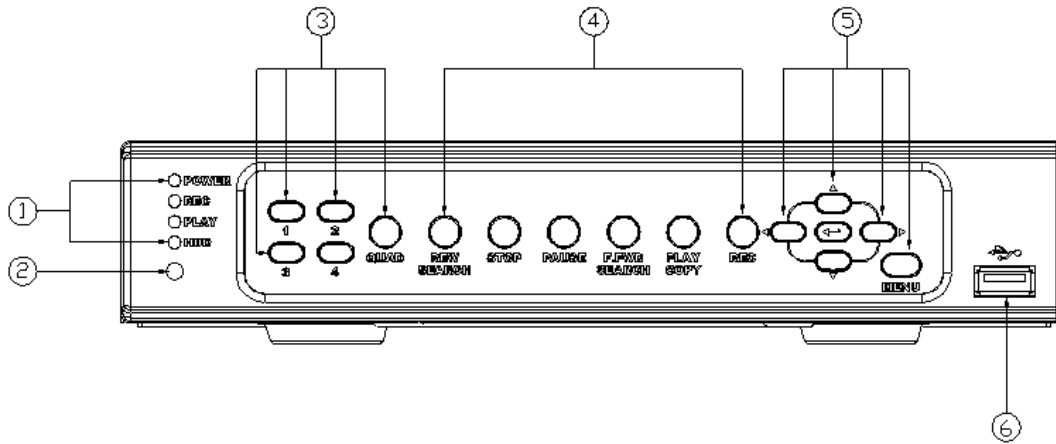

DVR204

DVR OPERATION

NO.	LABEL	OPERATION	PTZ
1	LED REC	Led Indicator	
2	○	IR Sensor For Remote Control.	
3	1-4 & Quad	Press The Button To Display No.1~No.4 Full Screen and Quad Screen	
4	CONTROL PANEL	Record, Playback And other control buttons.	
5	▲▼◀▶ & MENU & ENTER	Button Of Controller. Button Of Menu Screen Button Of Enter key	UP, DOWN, LEFT & RIGHT
6	🔌	USB Connector.	

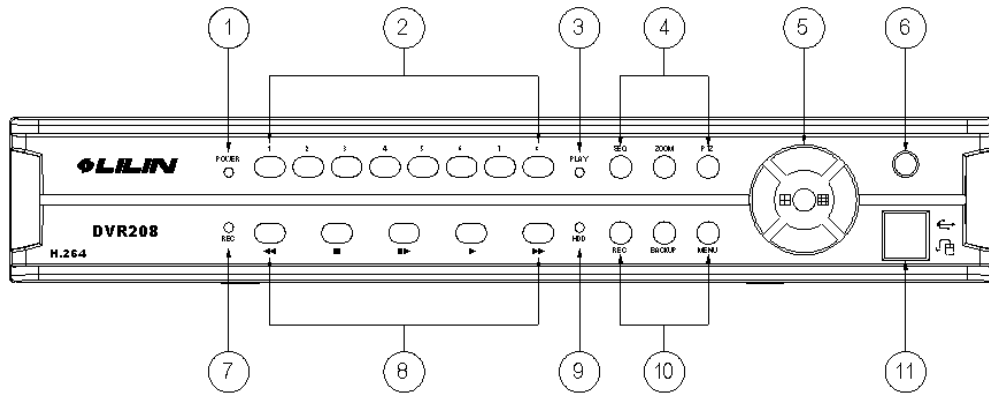

DVR208

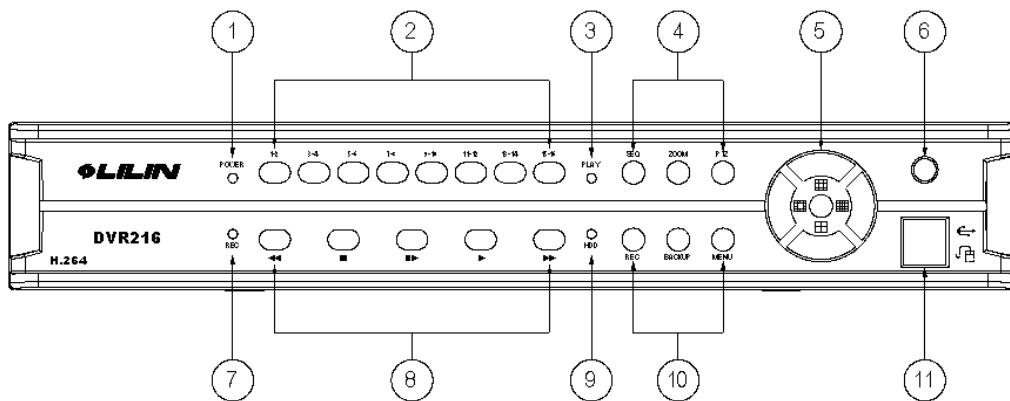

DVR216

NO.	LABEL	OPERATION	PTZ
1	POWER LED	Power Led Indicator	
2	1-8 (DVR208)	Press The Button To Display No.1~No.8	
	1-2, 3-4, 5-6, 7-8, 9-10, 11-12, 13-14, 15-16 (DVR216)	Press The Button To Display No.1~No.16	
3	PLAY LED	Play Led Indicator	
4	FUNCTION PANEL	SEQ, Zoom and PTZ buttons	
5	▲▼◀▶ & ENTER	Button Of Controller. Button Of Enter key	UP, DOWN, LEFT & RIGHT
6	○	IR Sensor For Remote Control	
7	REC LED	Recording Led Indicator	
8	CONTROL PANEL	F.FWD, STOP, PLAY and FORWARD control buttons.	
9	HDD LED	HDD Led Indicator	
10	FUNCTION PANEL	REC, BACKUP and MENU buttons	
11		USB and Mouse (Only by supplied mouse) Connectors.	

2.2 BACK PANEL

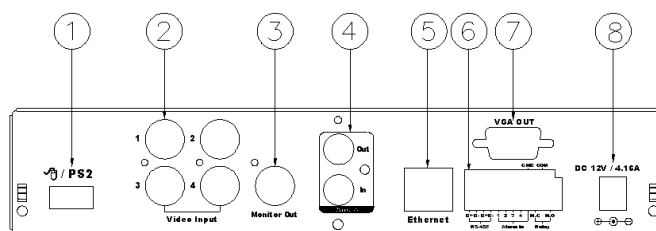

DVR204

NO.	LABEL	OPERATION
1		USB Mouse Connector (Only by supplied mouse).
2	VIDEO INPUT	Video input with BNC connector.
3	MONITOR OUT	Video output with BNC connector.
4	AUDIO OUT/ IN	Audio output/ input.
5	ETHERNET	RJ-45 connector for network.
6	RS-485/ ALARM/ RELAY	4 pin connector for external control unit, 5 pin connector for Alarm input and 3 pin connector for relay
7	VGA D-SUB OUT	Connect to CRT or LCD monitor.
8	POWER	Power switcher: DC 12V 5A / 50-60 Hz input.

NOTE: Please plug in the supplied mouse to DVR mouse connector before turn on the DVR. DO NOT REMOVE and PLUG IN the supplied mouse while DVR is operating.

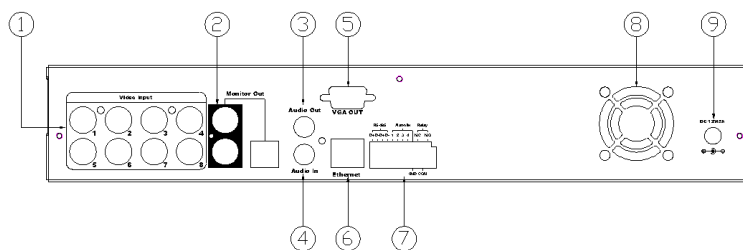

DVR208

NO.	LABEL	OPERATION
1	VIDEO INPUT	Video input with BNC connector
2	MONITOR OUT	Video output with BNC connector
3	AUDIO OUT	Audio output
4	AUDIO IN	Audio input.
5	VGA D-SUB OUT	Connect to CRT or LCD monitor.
6	ETHERNET	RJ-45 connector for network.
7	RS-485/ ALARM/ RELAY	4 pin connector for external control unit, 5 pin connector for Alarm input and 3 pin connector for relay
8	FAN	Fan
9	POWER	Power switcher: DC 12V 5A / 50-60 Hz input.

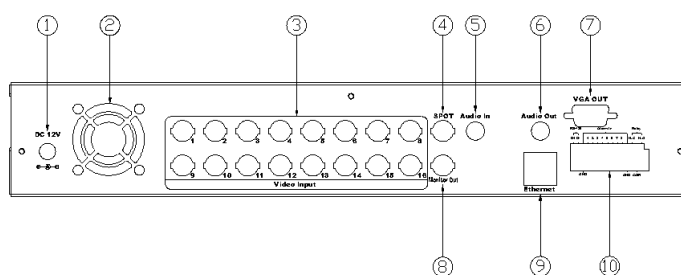

DVR216

NO.	LABEL	OPERATION
1	POWER	Power switcher: DC 12V 5A input.
2	FAN	Fan
3	VIDEO INPUT	Video input with BNC connector
4	SPOT	SPOT video output.
5	AUDIO IN	Audio input.
6	AUDIO OUT	Audio output
7	VGA D-SUB OUT	Connect to CRT or LCD monitor.
8	MONITOR OUT	Video output with BNC connector
9	ETHERNET	RJ-45 connector for network.
10	RS-485/ ALARM/ RELAY	2 pin connector for external control unit, 10 pin connector for Alarm input and 3 pin connector for relay

2.3 ADVANCED AUTO SWITCH, ZOOM, PTZ, COPY KEY CONTROL & USB INFORMATION

AUTO SWITCH : In the split screen mode, use the “F.FWD SEARCH” keys in the front panel to enable auto switch function. Moreover, press “QUAD” key again to disable it. (In DVR204 Module); moreover, use “SEQ” button can also enable auto switch function. Press “SEQ” button again can terminate auto switch function. (In DVR208/ DVR216 Module.)

PTZ : When camera supported PTZ function, user can use “F.FWD SEARCH” button on the front panel to perform PTZ function. Press ▲▼◀▶ to select and change setup value. Press “F.FWD SEARCH” again to disable PTZ function (In DVR204 Module). In DVR208/ DVR216 module, use “PTZ” button on the front panel can enable PTZ function and then press “PTZ” button again to disable PTZ function.

COPY : Within the playback mode, press “PLAY COPY ” button to start backup record and press “PLAY COPY ” again to end backup(DVR204 Module). The user can see the backup image approx. 3 ~5 sec. In DVR208/DVR216 Module, press “Backup” button to start backup and then press it again to end backup function.

2.4 EXTERAL ALARM

There are three types of alarms that the system can be configured to handle. They are Motion detection Alarm, External Alarm and Video Loss Alarm.

A. Motion detection Alarm and External Alarm:

When motion detection or External Alarm was triggered, there are 5 possible actions will be taken.

- a. Changes recording speed as alarm recording speed.
- b. Monitor will display corresponding full screen alarm channel, it will switch automatic mode to manual mode if buttons pressing activity occurred in 5 seconds.
- c. Relays can be activated by motion detection or external alarm when turning on.
- d. The camera title will be transformed into color of yellow when motion is happening, “ALARM” text will show up when external alarm is triggered.

B. Video Loss Alarm:

The default setting of Video Loss alarm is enabled.

Terminal Connectors:

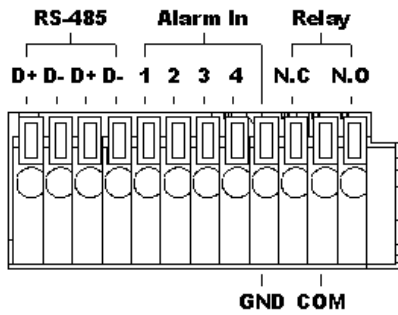

(DVR204/ DVR208)

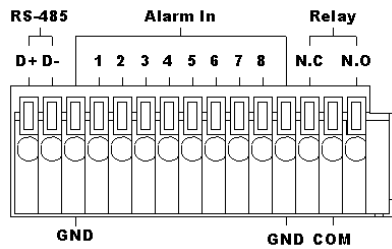

(DVR216)

D+	RS-485 sends +/ receives +
D -	RS-485 sends -/ receives -
D+	RS-485 sends +/ receives +
D -	RS-485 sends -/ receives -
ALARM1-4	Camera alarm input.
GND	GND.
N.C	Relay N.C.
COM	Relay COM
N.O	Relay N.O.

EXAMPLE 1 : Connect Alarm In One with PIR (Passive Infrared).

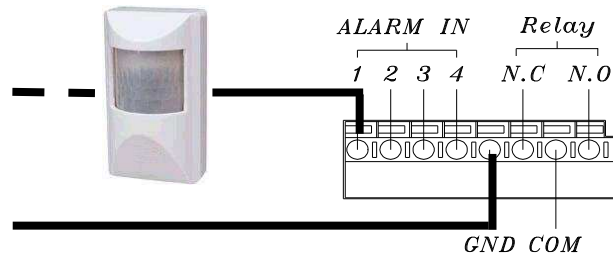

EXAMPLE 2 : Connect with Alarm Siren at Relay N.O.

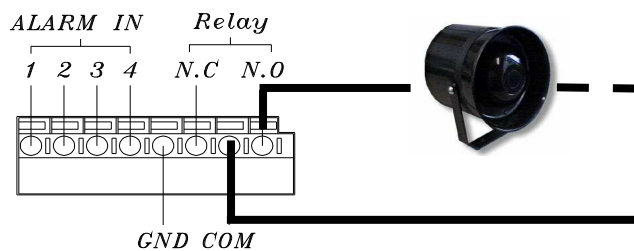



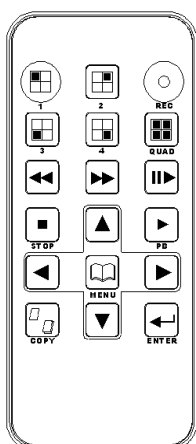



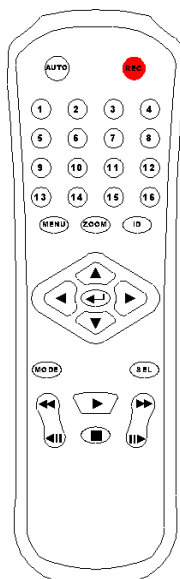

2.5 IR REMOTE CONTROL



(DVR204)



(DVR208/DVR216)

ITEM	
REC	Press REC to start recording and press twice to stop.
AUTO	Press AUTO to activate sequence display of channels (DVR208/DVR216 USE ONLY)
1 - 4	Select channel 1-4 with full screen. (DVR204 USE ONLY)
1-16	Select channel 1-16 with full screen. (DVR208/DVR216 USE ONLY)
QUAD	Fast backward. (DVR204 USE ONLY)
MODE	Split Screen Switch (DVR208/ DVR216 USE ONLY)
SEL	Press this button to select the different assembled of camera formats or perform PTZ functions. Moreover, under the 16 split screen and full screen modes, press this button for switching Audio ON/ OFF. (DVR208/DVR216 USE ONLY)
	Picture by picture backward.
	Picture by picture forward.
	Fast Forward.
	Play video forward.
COPY	Switch channel format. (DVR204 USE ONLY)
	Move upward or increase the number.
	Move rightward or increase the number.
	Move downward or decrease the number.
	Move leftward or decrease the number.
	Enter selected items.
MENU	Enter or Exit Main Menu.
STOP	Stop the playback.

3 SYSTEM SETUP

3.1 MENU SETUP INTERFACE(GUI)



A. CAMERA SET



B. MOTION SETUP

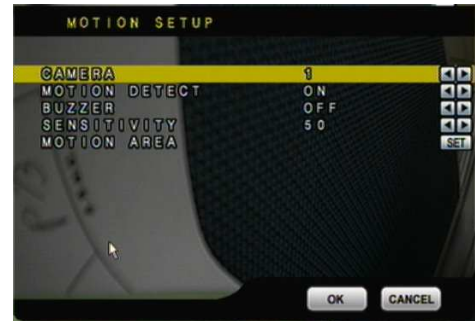

C. RECORD SETUP



D. ALARM SETUP

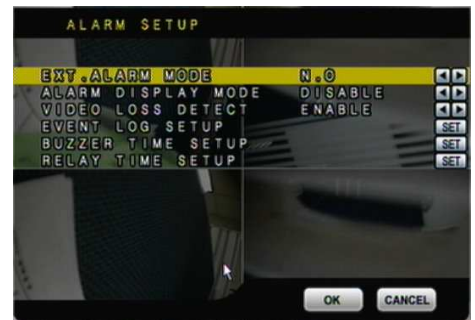

E. NETWORK SETUP



F. SYSTEM SETUP



G.  HARD DISK SETUP

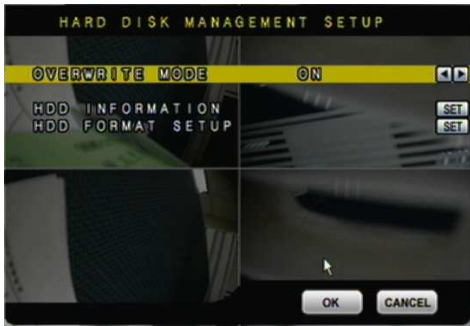

H.  BACKUP SETUP







3.2 LIVE VIEWING AND POP-UP MENU



NOTE : All of the images and icons are presented by DVR204 Module.

NOTE : The pop-up menu can be activated by moving the mouse cruise to the bottom of the live viewing screen.

- A.**  **GUI MENU BAR**
With live viewing mode, press this button to get into the GUI menu.
- B.**  **DISK INFORMATION**
With live viewing mode, press this button to display disk information.
- C.**  **DIGITAL ZOOM**
In the full screen mode, left-click the button of the mouse to pull a range to zoom in or zoom out the image. User can right-click the button of the mouse to disable this function. (NOTE: Using the mouse to operate digital zoom can zoom in to max. 16 times.) Moreover, user can also use compound key on the front panel to perform this function. (First, click ENTER/COPY Key and then click ▲▼◀▶ key to select zoom in or zoom out position. Finally, click ENTER/COPY key again to complete the setting. Moreover, click MENU Key to disable digital zoom function. Using the panel key to perform zoom in function is fixed at 2 times.)
- D.**  **PTZ CONTROLLER**
Within live-viewing mode, Clicks this button to get into the PTZ setup menu. User can also use PTZ key on the front panel to perform this function. Moreover, user can right-click the button of the mouse or press the PTZ key on the front panel again to exit PTZ Setup.

NOTE : Only for the camera supported PTZ function.

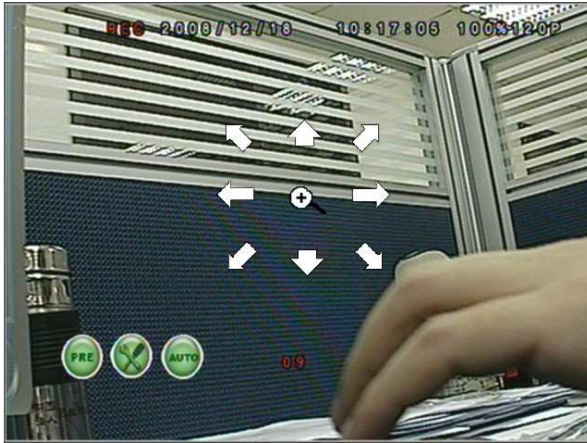

PTZ CONTROL



Under PTZ control mode, press



into PTZ setup menu. User can also press the “MENU” key on the DVR front panel to get into PTZ setup menu.

Press  to process Preset Point setup and press “” to exit setup



To process AUTO function.



Press  button to entry PTZ preset point menu.



SAVE PRESET NUMBER: Press **SET** to save preset point number and its position.

GO TO PRESET NUMBER: Press **SET** to go to the setup preset point number position.

PTZ SETUP MENU



- ID : Use the mouse wheel to setup the PTZ camera ID number.
- PAN SPEED: Use the mouse wheel to change the left-right speed.
- TILT SPEED: Use the mouse wheel to change the up-down speed.
- AUTO SPEED: Use the mouse wheel to change the auto patrol speed.
- BAUD RATE: Use the mouse wheel to change the BAUD rate.
- PROTOCOL: Use the mouse wheel to change the connection protocol.

E. AUDIO CONTROL

Press this button to turn the audio on or off.

F. DISPLAY CONTROL

Within live-viewing or playback mode, use display control to switch the camera channel.

G. RECORD AND PLAYBACK CONTROL

Same as front panel controller and remote controller.

3.3 CAMERA SETUP



Press ▲ or ▼ to select items.
 Press ◀ or ▶ to change values.
 Press SET to see more options.

A. CAMERA

Press ◀ or ▶ / mouse wheel to switch channels.

B. VIDEO ADJUST

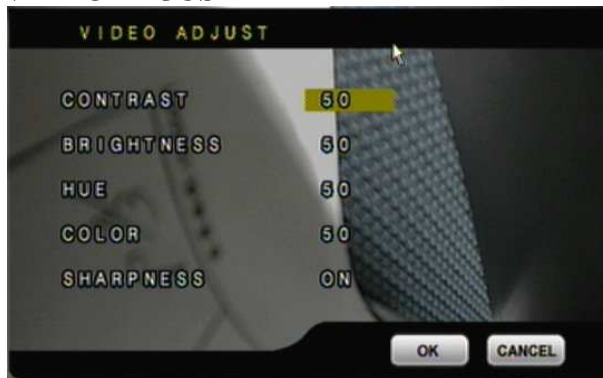

B-1. CONTRAST

Press ◀ or ▶ / mouse wheel to change contrast level.

B-2. BRIGHTNESS

Press ◀ or ▶ / mouse wheel to change brightness level.

B-3. HUE

Press ◀ or ▶ / mouse wheel to change HUE level.

B-4. COLOR

Press ◀ or ▶ / mouse wheel to change color level.

B-5. SHAPRNESS

Press ◀ or ▶ / mouse wheel to change sharpness level.

C. CAMERA TITLE



Use mouse to select and change character.

D. DISPLAY

Press ◀ or ▶ to/ mouse wheel change value for the corresponding camera would be displayed on the screen or not.

E. DWELL TIME

Press ◀ or ▶ / mouse wheel to ON/OFF auto switch and the switch sec..

F. PTZ SETUP



- ID : Use the mouse wheel to setup the PTZ camera ID number.
- PAN SPEED: Use the mouse wheel to change the left-right speed.
- TILT SPEED: Use the mouse wheel to change the up-down speed.
- AUTO SPEED: Use the mouse wheel to change the auto patrol speed.
- BAUD RATE: Use the mouse wheel to change the BAUD rate.
- PROTOCOL: Use the mouse wheel to change the connection protocol.



3.4 MOTION SETUP

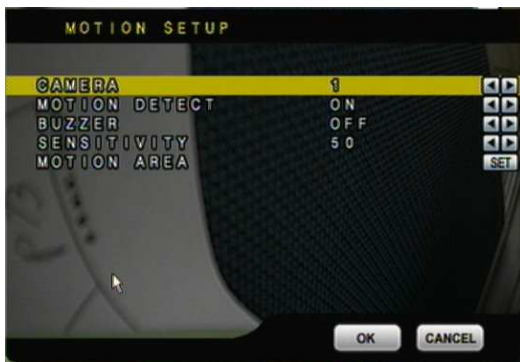

- Press ▲ or ▼ to select items.
- Press ◀ or ▶ to change values.
- Press SET to see more options.

A. CAMERA

Press ◀ or ▶ / mouse wheel to switch channels.

B. MOTION DETECT

Press ◀ or ▶ / mouse wheel to change value for motion detect function.

C. BUZZER

Press ◀ or ▶ / mouse wheel to change value for buzzer while motion detected.

D. SENSITIVITY

Press ◀ or ▶ / mouse wheel to change sensitivity value from 001 (minimum) to 100 (maximum).

E. MOTION AREA SETUP

1. Press **SET** to enter Motion Area Setting. (**Note: The default setting of all area is “MOTION ON”.**)



2. Use the mouse to select which block is needed.



The green area shows the area without motion detection.

3. Left-Click the mouse to see more options or exit the setup.

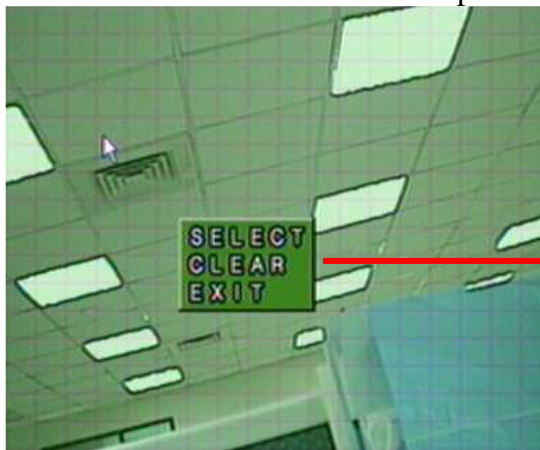

SELECT: Cancel the selected area.

CLEAR: Select the area without motion detection.

EXIT: Exit the motion detection setup.

3.5



RECORD SETUP



Press ▲ or ▼ to select items.
 Press ◀ or ▶ to change values.
 Press SET to see more options.

A. RESOLUTION

Press ◀ or ▶ / mouse wheel to switch record resolution.

FULL D1: 720 x 480 (NTSC)/ 720 x 576 (PAL)
 HALF D1: 720 x 240 (NTSC)/ 720 x 288 (PAL).
 CIF: 360 x 240 (NTSC)/ 360 x 288 (PAL).

NOTE: If record resolution is altered in here, **DVR will reboot** automatically.

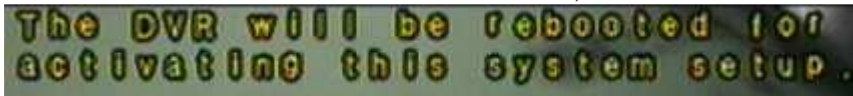

B. NORMAL RECORD PPS

Press **SET** to change the PPS in normal recording. User can click “AVERAGE” to set PPS automatically by system or change the PPS for each channel manually.

Record Resolution: FULL D1: 720 x 480 (NTSC)/ 720 x 576 (PAL)
 HALF D1: 720 x 240 (NTSC) / 720 x 288 (PAL)



Record Resolution: CIF: 360 x 240 (NTSC) / 360 x 288 (PAL)



C. ALARM RECORD PPS

Press **SET** to change the PPS in alarm recording. User can click “AVERAGE” to set PPS automatically by system or change the PPS for each channel manually.

Record Resolution: FULL D1: 720 x 480 (NTSC)/ 720 x 576 (PAL)
HALF D1: 720 x 240 (NTSC) / 720 x 288 (PAL)



Record Resolution: CIF: 360 x 240 (NTSC) / 360 x 288 (PAL)



D. ALARM RECORD DURATION

Press ◀ or ▶ to set dwell time of alarm recording.

E. RECORD QUALITY

Press **SET** to entry to the record quality setup. There are NORMAL RECORD QUALITY and ALARM RECORD QUALITY two items can be set.



E-1. NORMAL RECORD QUALITY

Press **SET** to switch normal record quality of each channel (FULL D1: 720 x 480 (NTSC) / 720 x 576 (PAL), HALF D1: 720 x 240 (NTSC) / 720 x 288 (PAL)) or each two channels (360 x 240 (NTSC) / 360 x 288 (PAL)). User can use mouse wheel to change the image quality of each single channel: LOW/ MEDIUM/ HIGH/ BEST, or use “ALL” to switch the image quality of all channels at once.

Record Resolution: FULL D1: 720 x 480 (NTSC)/ 720 x 576 (PAL)
HALF D1: 720 x 240 (NTSC) / 720 x 288 (PAL)



Record Resolution: CIF: 360 x 240 (NTSC) / 360 x 288 (PAL)



E-2. ALARM RECORD QUALITY

Press **SET** to switch alarm record quality of each channel (FULL D1: 720 x 480 (NTSC) / 720 x 576 (PAL), 720 x 240 (NTSC) / 720 x 288 (PAL)) or each two channels (360 x 240 (NTSC) / 360 x 288 (PAL)). User can use mouse wheel to change the image quality of each single channel: LOW/ MEDIUM/ HIGH/ BEST, or use "ALL" to switch the image quality of all channels at once.

Record Resolution: FULL D1: 720 x 480 (NTSC)/ 720 x 576 (PAL)
HALF D1: 720 x 240 (NTSC) / 720 x 288 (PAL)



Record Resolution: CIF: 360 x 240 (NTSC) / 360 x 288 (PAL)



F. RECORD MODE

Press ◀ or ▶ to switch record mode to MANUAL/ SCHEDULE 1 / SCHEDULE 2/
SCHEDULE 3/ SCHEDULE 4/ SCHEDULE 5

G. AUDIO RECORD

Press ◀ or ▶ to switch AUDIO RECORD ON or OFF.

H. SCHEDULE SETUP

Press **SET** to get into schedule setup menu ◦



1. Use mouse to select schedule day/ time/ mode.
2. Click **OK** to save change and exit.

3.6



ALARM SETUP

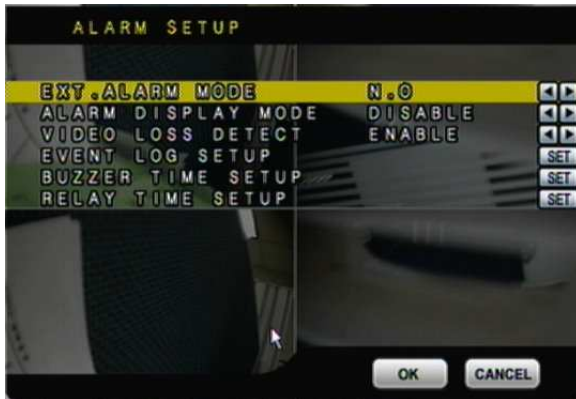

Press ▲ or ▼ to select items.
 Press ◀ or ▶ to change values.
 Press SET to see more options.

A. EXT. ALARM MODE

Select N.C for “normal close” alarm input, or select N.O for “normal open” alarm input.

B. ALARM DISPLAY MODE

Press ◀ or ▶ / mouse wheel to change value for ALARM DISPLAY MODE with full screen.

C. VIDEO LOSS DETECT

Press ◀ or ▶ / mouse wheel to switch VIDEO LOSS ALARM ON or OFF.

D. EVENT LOG SETUP

Press **SET** to change value for MOTION EVENT / VIDEO LOSS EVENT to ON / OFF.

E. BUZZER TIME SETUP

Press **SET** to set dwell time of BUZZER/ ALARM.

F. RELAY TIME SETUP

Press **SET** to set dwell time of RELAY.

3.7



NETWORK SETUP



Press ▲ or ▼ to select items.
 Press ◀ or ▶ to change values.
 Press SET to see more options.

A. IP MODE

Press ▲ or ▼ to select items and ◀ or ▶ / mouse wheel to change to STATIC IP or DHCP.

B. HTTP PORT

Press ▲ or ▼ to select items and ◀ or ▶/ mouse wheel to change WEB PAGE PORT.

C. IP ADDR

Press ▲ or ▼ to select items and **SET** to change IP ADDRESS.

D. NETMASK

Press ▲ or ▼ to select items and **SET** to change SUBNET MASK.

E. GATEWAY

Press ▲ or ▼ to select items and **SET** to change Default GATEWAY.

F. DNS1

Press ▲ or ▼ to select items and **SET** to change DNS.

G. DNS2

Press ▲ or ▼ to select items and **SET** to change OTHER DNS.

H. PPPoE

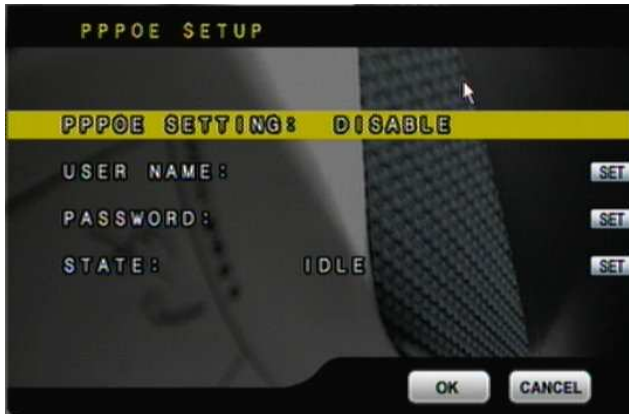

H-1. PPPoE SETTING

Press ◀ or ▶/ mouse wheel to ENABLE / DISABLE PPPoE.

H-2. USER NAME

Use mouse to setup user name for ADSL account.

H-3. PASSWORD

Use mouse to setup password for ADSL account.

H-4. STATE

Press SET to display status of PPPoE ◦

I. DDNS SETUP



I-1. DDNS SETTING : Press ◀ or ▶ / mouse wheel to set DDNS ENABLE / DISABLE.

I-2. PROVIDER : Press ◀ or ▶ / mouse wheel to select DDNS provider.

I-3. USER NAME : Press **SET** to setup user name.

I-4. UPDATE SCHEDULE : Use **SET** to dwell time of updating schedule.

I-5. STATE : Press **SET** to display status of DDNS.

J. RTSP SETUP



J-1. RTSP PORT: Press **SET** to setup RTSP port. The default value is 554.

J-2. RTP START PORT: Press **SET** to setup RTP start port.

J-3. RTP END PORT: Press **SET** to setup RTP end port.

J-4. VIDEO QUALITY: Press ◀ or ▶ / mouse wheel to select video quality. There are BEST, HIGH, STANDARD, MEDIUM & LOW five options.



Press ▲ or ▼ to select items.
Press ◀ or ▶ to change values.
Press SET to see more options.

A. DATE / TIME SETUP

Press **SET** to set DATE / TIME.

A-1. TIME

Use mouse wheel to change DATE/ TIME.

A-2. DATE FORMAT

Use mouse wheel to change DATE. There are DD/MM/YYYY, YYYY/MM/DD and MM/DD/YYYY three modes.

A-3. NTP MODE

Use mouse wheel to change NTP. When NTP is enable, use **SET** to change SERVER IP and use ◀ or ▶ / mouse wheel to change GMP and UPDATE TIME.



B. SYSTEM TYPE

Press ◀ or ▶ / mouse wheel to change the system type. Moreover, **DVR will reboot** while changing the system type.

C. KEYBOARD LOCK

Press ◀ or ▶ / mouse wheel to switch ON/ OFF. There are OFF, TYPE 1 and TYPE 2 three options.

OFF : UNLOCK.

TYPE 1 : Only can switch split screen and full screen. The user can operate AUTO and MENU functions as well. However, the password has to be filled in to implement playback mode.

TYPE 2 : LOCK (Except MENU button). The password has to be filled in to implement playback mode.

After KEYBOARD LOCK mode setup, please set up **PASSWORD**

Without password, un-authorized users could access into SYSTEM SETUP and make changes of settings easily.

D. DVR ID NUMBER

Press ◀ or ▶ / mouse wheel to change values.

ID NUMBER is required to make difference of each DVR.

E. DISPLAY SETUP

Press SET to ENABLE or DISABLE display of CAMERA TITLE / DVR STATUS / DATE / TIME.

F. LANGUAGE

Press ◀ or ▶ to change on-screen-display (OSD) language.

G. SYSTEM PASSWORD

Press ▲ or ▼ to select items and ◀ or ▶ to change values.

Default password: 1111.

H. FIRMWARE UPDATE

Press **YES** to start firmware update. After updated, the DVR will reboot automatically.

At this moment, please do not turn off the DVR manually.

NOTE: 1. Please format USB flash memory with FAT32.

2. For function stability, we suggest user to STOP recording function before processing firmware update function.

I. LOAD DEFAULT

Press **SET** button to entry CONFIGURE SET screen. There are LOAD SETUP FROM DEFAULT, LOAD SETUP FROM USB and BACKUP SETUP TO USB three parts.

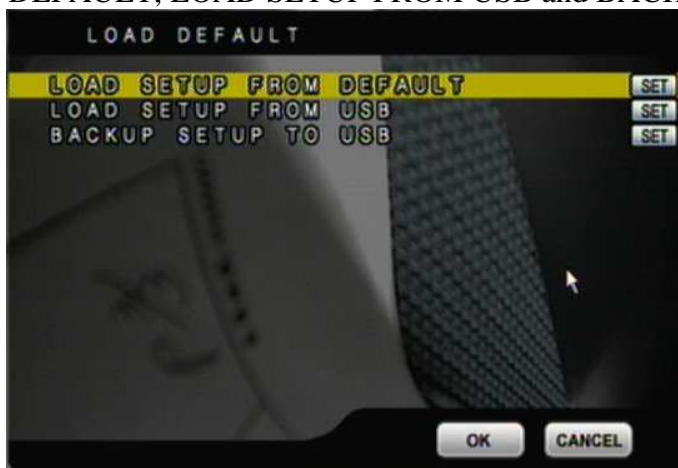

I-1. LOAD SETUP FROM DEFAULT: Press **SET** button to load the setting back to factory default.

I-2. LOAD SETUP FROM USB: Press **SET** button to load the pen drive setting to the current DVR.

I-3. BACKUP SETUP TO USB: Press **SET** button to backup the current DVR setting into pen drive.

J. DAYLIGHT SAVING TIME SETUP

Press ◀ or ▶ / mouse wheel to change the DAYLIGHT MODE option: Disable, Manual and Auto.

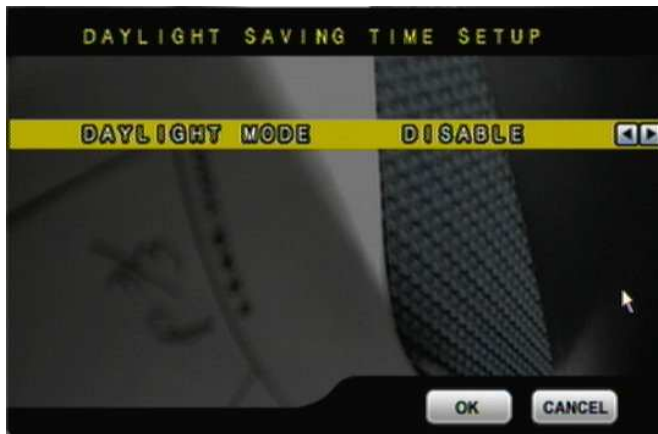

J-1. MANUAL MODE

Use **SET** to change the Day Light Saving start and end time.

Press ◀ or ▶ / mouse wheel to change DELAY TIME

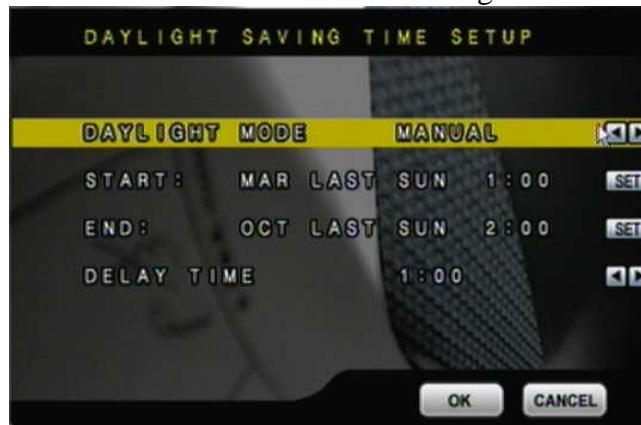

J-2. AUTO MODE

Press ◀ or ▶ / mouse wheel to change CITY option. Different CITY will have different START, END and DELAY TIME.



3.9



HARD DISK SETUP

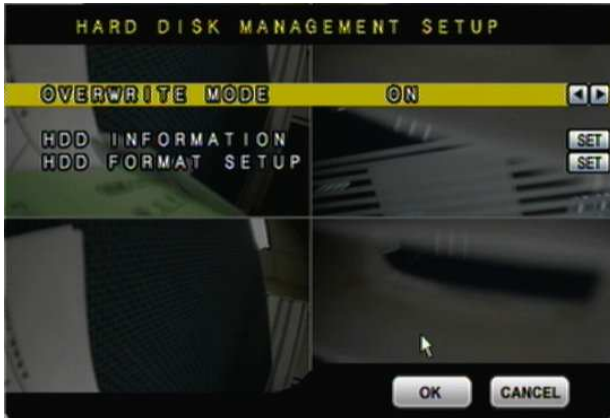

A. OVERWRITE MODE

Press ◀ or ▶ to change value OVERWRITE MODE ON or OFF.

B. CAPACITY WARNING (When Overwrite Mode is OFF, Capacity Warning will enable)

Press ◀ or ▶ to change value to 20/ 15/ 10 or 5% with non-overwrite mode. When LEFT RATIO is below the setting, it will enable AUDIBLE ALARM (If AUDIBLE ALARM of BUZZER of ALARM SETUP is ON).

C. HDD INFORMATION

Press SET to display HDD information.

D. HDD FORMAT SETUP

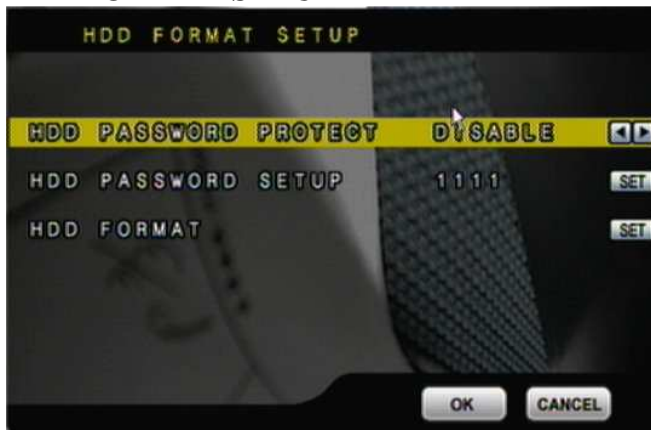

D-1. HDD PASSWORD PROTECT

Press ◀ or ▶ / mouse wheel to change value for hard disk format password protection.

D-2. HDD PASSWORD

Press **SET** then use mouse to change password.
Default password : 1111

D-3. HDD FORMAT

Press **SET** to get into FORMAT setup.
Press YES or NO to execute.

3.10 BACKUP SETUP



Press ▲ or ▼ to select items.
Press ◀ or ▶ to change values.
Press SET to see more options.

NOTE: *For function stability, Ethernet remote control function (IE) will be stopped when processing backup function.

*USB DEVICE BACKUP : 3.2MB/ per sec.

A. USB BACKUP

Due to each USB device with different USB driver ICs, their compatibilities differ, too. This system is compatible with most of USB flash memory. If there is compatible issue, please refer to **APPENDIX B**. In addition, please format USB flash memory with FAT32.



BEFORE BACKUP

- A. In live viewing mode, insert USB device into a USB port of the DVR.
- B. Get into playback mode by PLAY TIME SEARCH or EVENT LIST SEARCH and play back videos that are going to be as backup.

VIDEO BACKUP

In multiplexer or full screen mode, press  to start backup and press  to end backup. The system will backup automatically.

PICTURE BACKUP

In multiplexer or full screen mode, press  and press . The system will start backup picture by picture.

USB BACKUP MENU



- User can use the mouse wheel to change the backup Start/ End time ◦

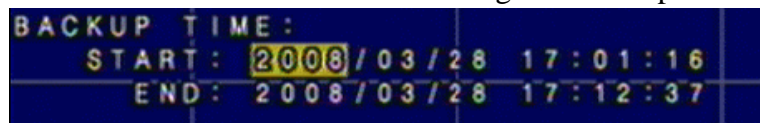

- Click  to start backup, the total process will be shown on screen.

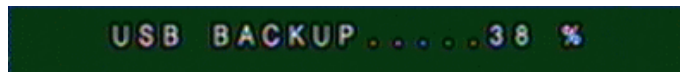

BACKUP FILE NAME

Each backup file will be named as START TIME.

EXAMPLE: 174624.264 is 17:46:24

AFTER BACKUP





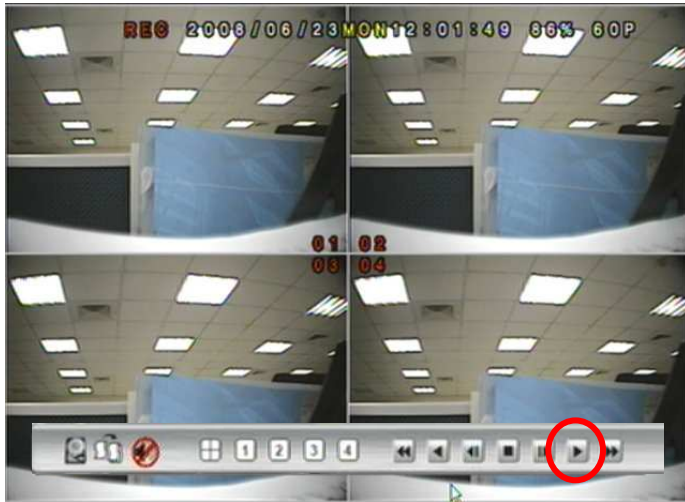

After backup, the system will copy "R6VIEWER.EXE" automatically on USB device for the user to play back backup file.

4 DVR PLAYBACK

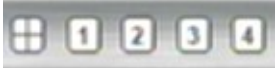

Click the playback button on the pop-up menu.

Note: the pop-up menu can be activated by moving the mouse cursor to the bottom of the live viewing screen.

- A.  **DISK INFORMATION**
With playback mode, press this button to display disk and pen drive information.
- B.  **RECORD BACKUP**
With playback mode, press this button to backup record (.264 video backup) and press this button again to finish backup. For performing the single image backup (.Y42 single image backup), press  first and then click this button to backup the necessary image.
- C.  **AUDIO CONTROL**
Press this button to turn the audio on or off
- D.  **DISPLAY CONTROL**
Within playback mode, use display control to switch the camera channel.
- E.  **RECORD AND PLAYBACK CONTROL**
Same as front panel controller and remote controller.

4.1 TIME SEARCH

Double click Left button of mouse to trigger play time search.



Please set the start and end time to search.



4.2 EVENT SEARCH



Double click Left button of mouse to trigger event search.



Please select the event to playback.



NOTE: Display the type of the event as follows.

POWER	If the DVR got power loss, it will record the date and time of rebooting.
RECORD	If REC button has been pressed, it will record the date and time in the event list.
V.LOSS	When a camera signal is lost, it will record the date, time, and corresponding channel. Moreover, the  icon will display on the corresponding channel.
ALARM	When ALARM is triggered, it will record the date, time, and corresponding channel. Moreover, the  icon will display on the corresponding channel.
MOTION	When MOTION is detected, it will record the date, time, and corresponding channel. Moreover, the  icon will display on the corresponding channel.

5 BACKUP PLAYBACK

SYSTEM REQUIREMENT

CPU: Intel Celeron 1.6G

MEMORY: 256MB.

VGA: 32MB

VGA RESOLUTION: 1024 x 768.

OS: Windows XP / 2000

SUGGESTED REQUIREMENT

CPU: Intel P4 2.8G

MEMORY: 512MB or above

VGA: 64MB or above

VGA RESOLUTION: 1024 x 768

OS: Windows XP / 2000

5.1 MAIN SCREEN SETTING

A. MAIN SCREEN

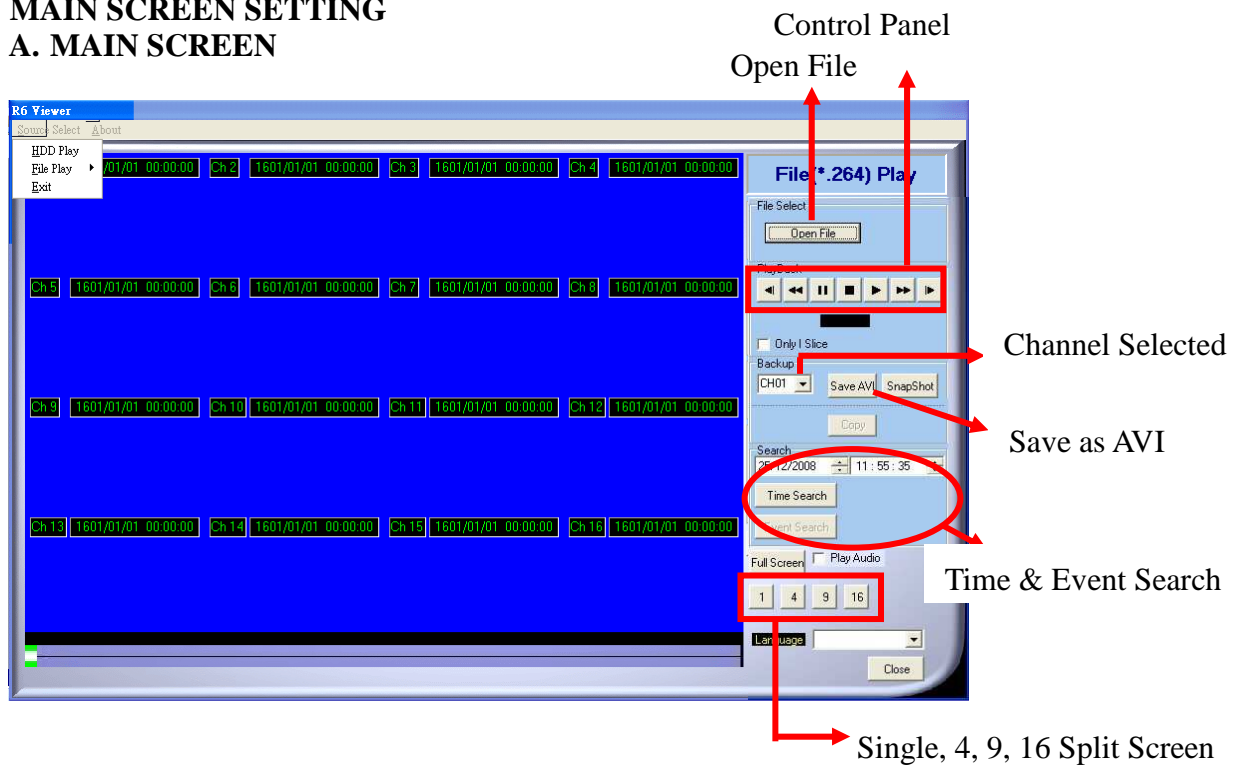

B. HDD PLAY

Play about all the data from the Hard disk of DVR or perform the specific Time and Event Search to play.

Note: Remove the DVR HDD and connect to the PC first. Then, use DVR

player  (R6Viewer.exe) to play the data of HDD. DVR player (R6Viewer.exe) can be attained from the attached CD or via the Internet; moreover, while performing USB backup and DVD-RW backup, the software will be built automatically as well.



B-1. TIME SEARCH

Insert search Date and Time and then click  to play all the searched film.

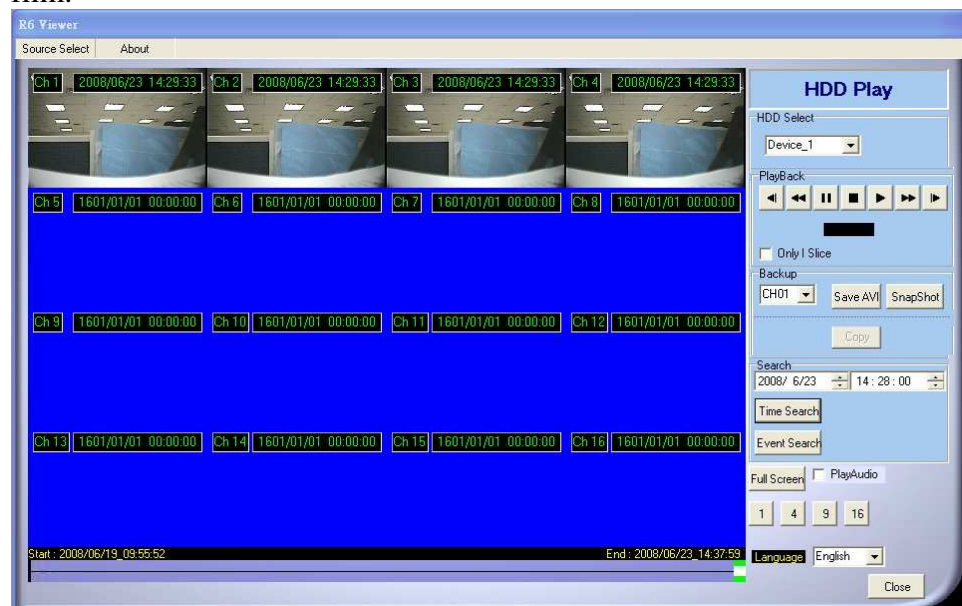

B-2. EVENT SEARCH

It will display all the events which are reserved within the DVR HDD after press **Event Search** (Shown in the following) and double click left button of mouse to trigger event.

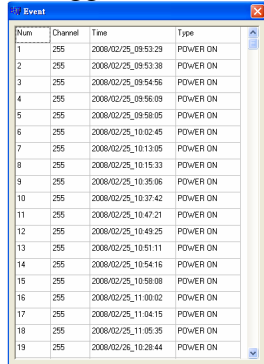

Num	Channel	Time	Type
1	255	2008/02/25_09:53:29	POWER ON
2	255	2008/02/25_09:53:38	POWER ON
3	255	2008/02/25_09:54:56	POWER ON
4	255	2008/02/25_09:56:09	POWER ON
5	255	2008/02/25_09:58:05	POWER ON
6	255	2008/02/25_10:02:45	POWER ON
7	255	2008/02/25_10:13:05	POWER ON
8	255	2008/02/25_10:15:33	POWER ON
9	255	2008/02/25_10:35:06	POWER ON
10	255	2008/02/25_10:37:42	POWER ON
11	255	2008/02/25_10:47:21	POWER ON
12	255	2008/02/25_10:49:25	POWER ON
13	255	2008/02/25_10:51:11	POWER ON
14	255	2008/02/25_10:54:16	POWER ON
15	255	2008/02/25_10:58:08	POWER ON
16	255	2008/02/25_11:00:02	POWER ON
17	255	2008/02/25_11:04:15	POWER ON
18	255	2008/02/25_11:05:35	POWER ON
19	255	2008/02/25_10:28:44	POWER ON

B-3. HDD COPY

Copied and reserved the DVR HDD data to other data storage device.

Press **Copy** button, the Copy screen will pop-up.

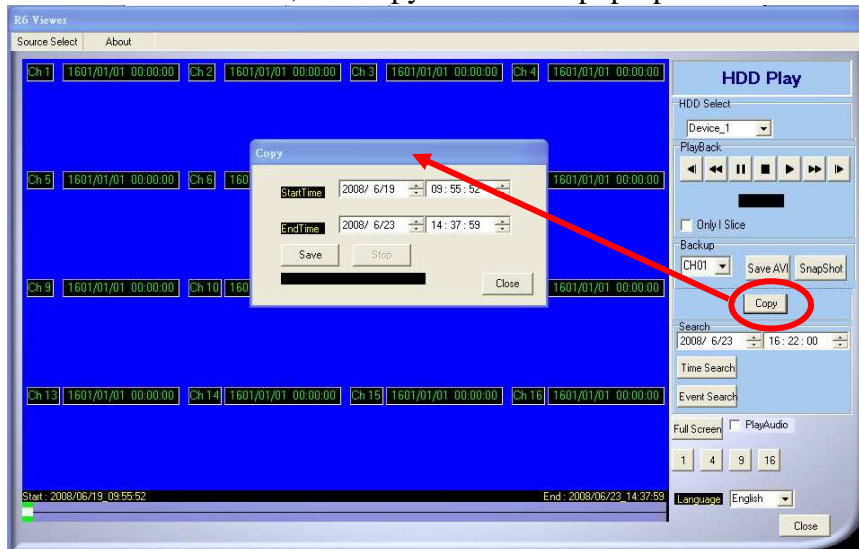

Then, select the “StartTime” and “EndTime”.

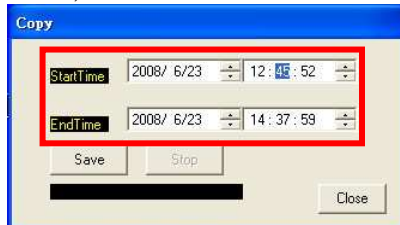

After that, press **Save** button to choose the storage destination and press **Save** to start reserving.

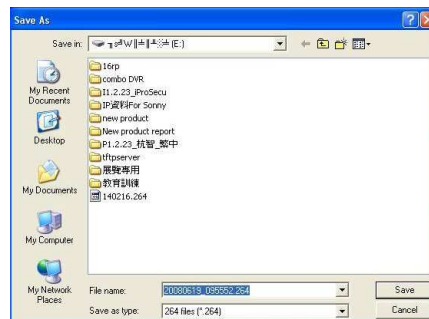

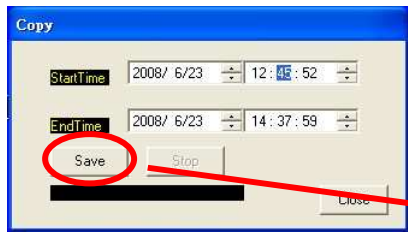

Finally, the complete information will pop-up while finished storage.



R6viewer.exe

(R6 Viewer.exe) can play not only DVR H.D.D. but also the *.264 and *.Y42 files which are reserved within the data storage devices. (i.e. CD/DVD disc, pen drive and the PC H.D.D which the data backup from DVR H.D.D)

C. File (*.264) Play

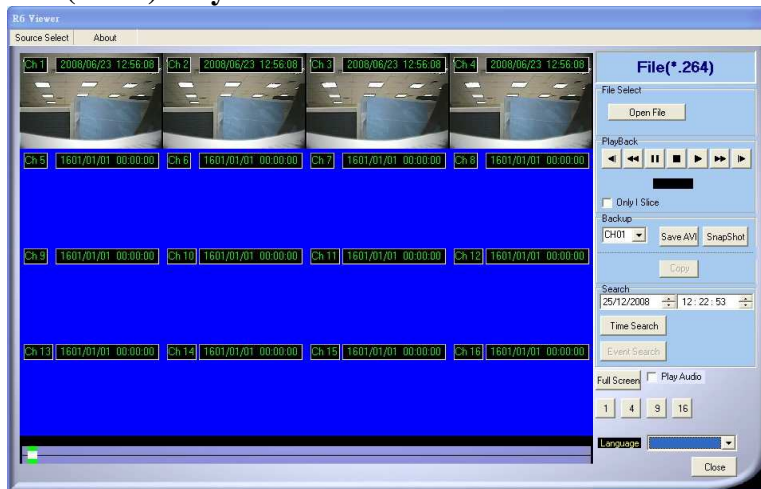

D. File (*.Y42) Play

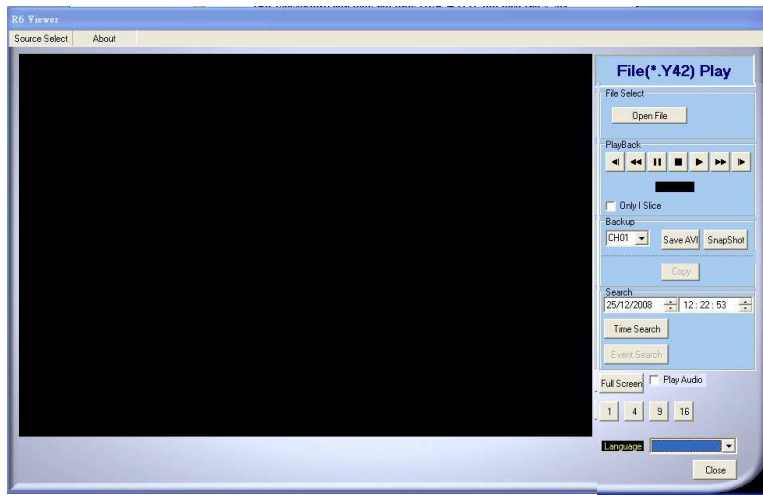

5.2 CD/DVD BACKUP PLAYBACK

- A. Insert the CD/DVD disk into CD/DVD ROM, the software will auto pop out, and select "Open File" and pick up the file.

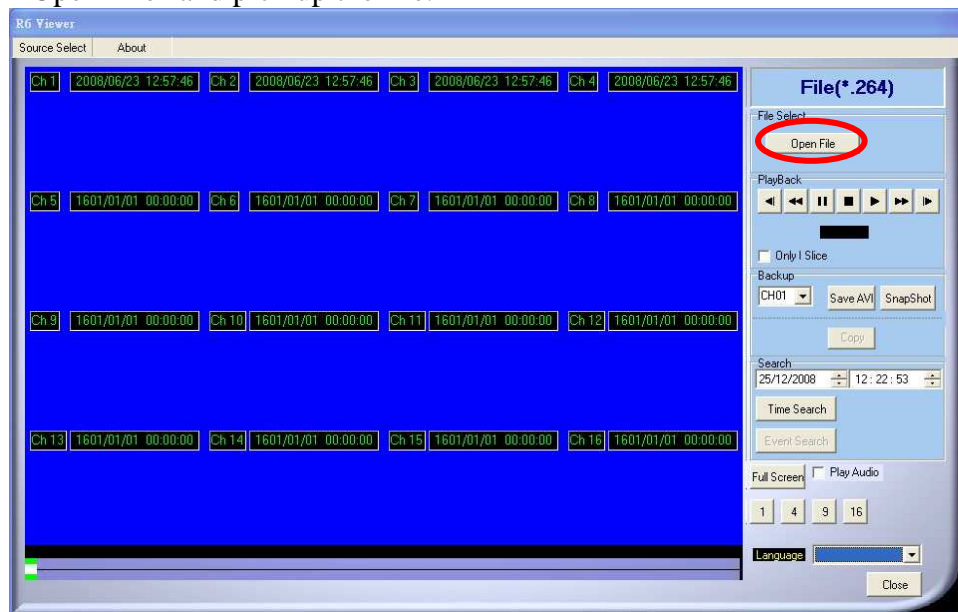

- B. Press the  icon to play the video.

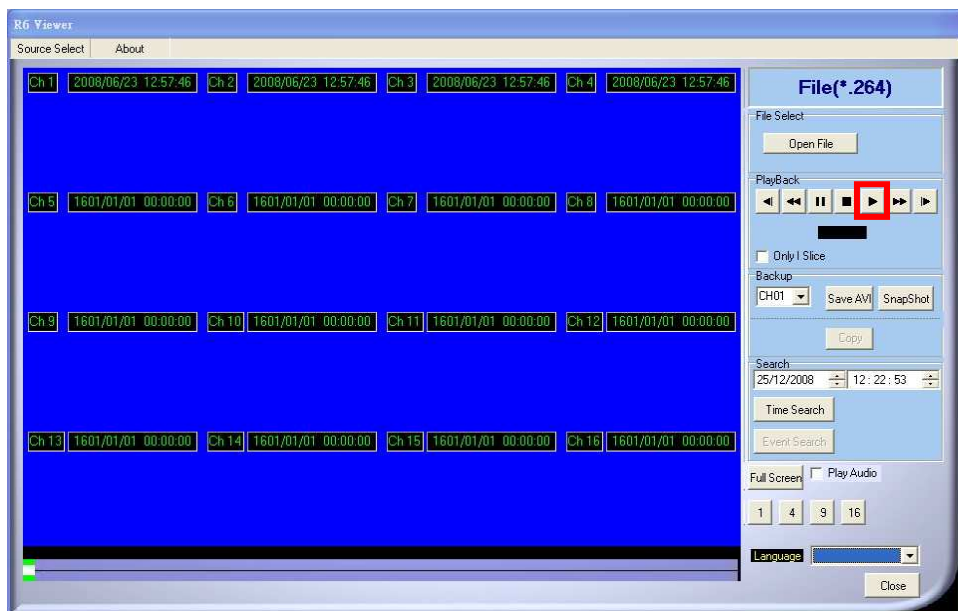

5.3 USB & LOCAL BACKUP FILE PLAYBACK

A. Plug the USB disk into PC or check the local backup folder.

If using USB mode, please double click the player.exe from the pop-up diagram. (As below)

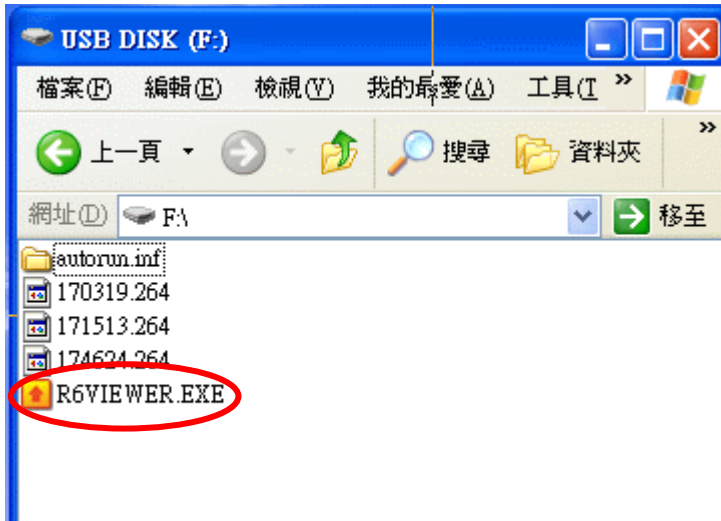

B. The play backup program would appear on the screen, select "Open File".

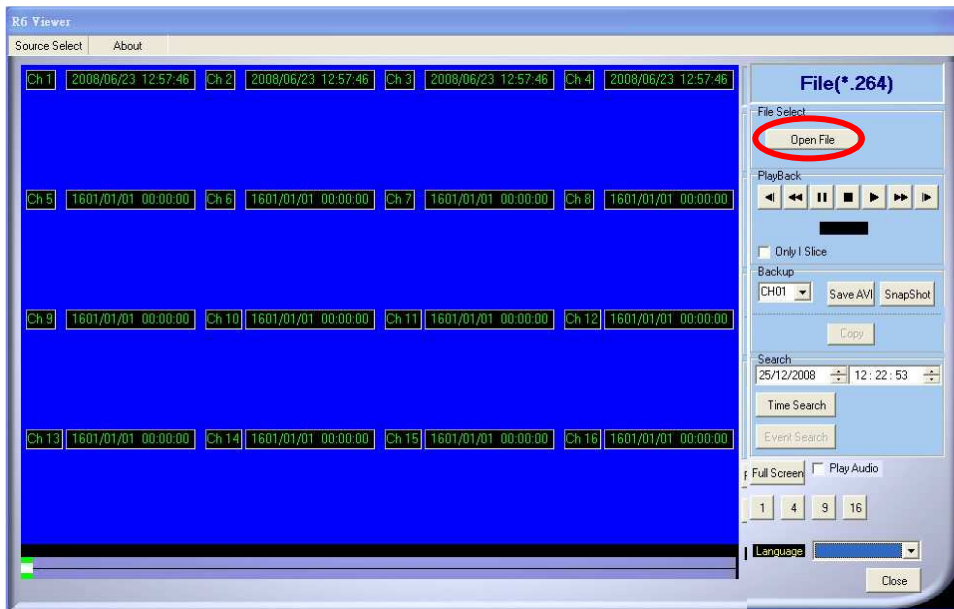

C. Open the USB disk located driver letter. (Example E:) or the local backup folder, and pick the file to playback.

The backup file will named as the time when backup, as like:
170319.264 will be 17:03:19

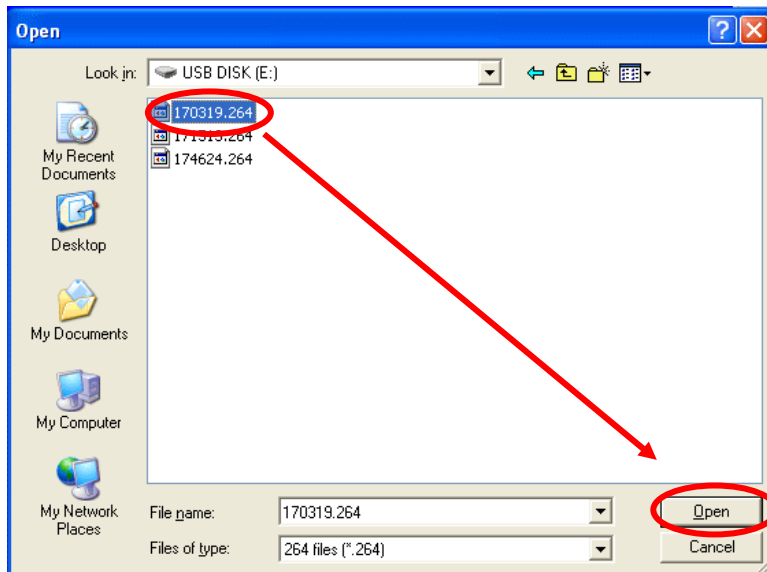

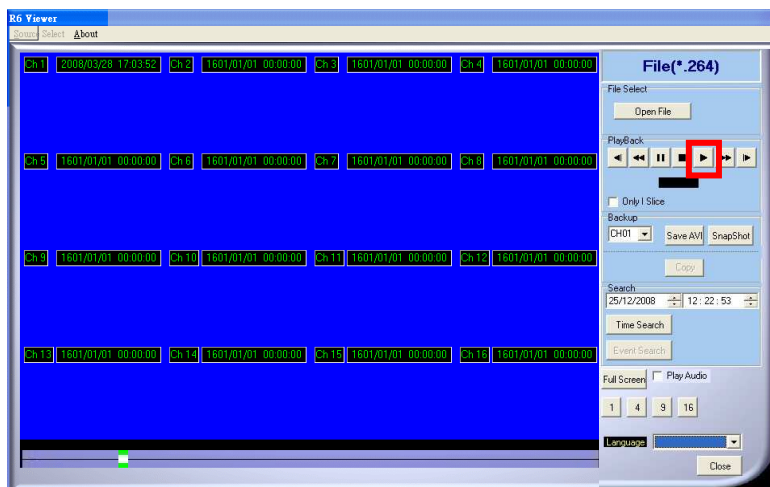

D. Press the play icon to play the video or still picture.

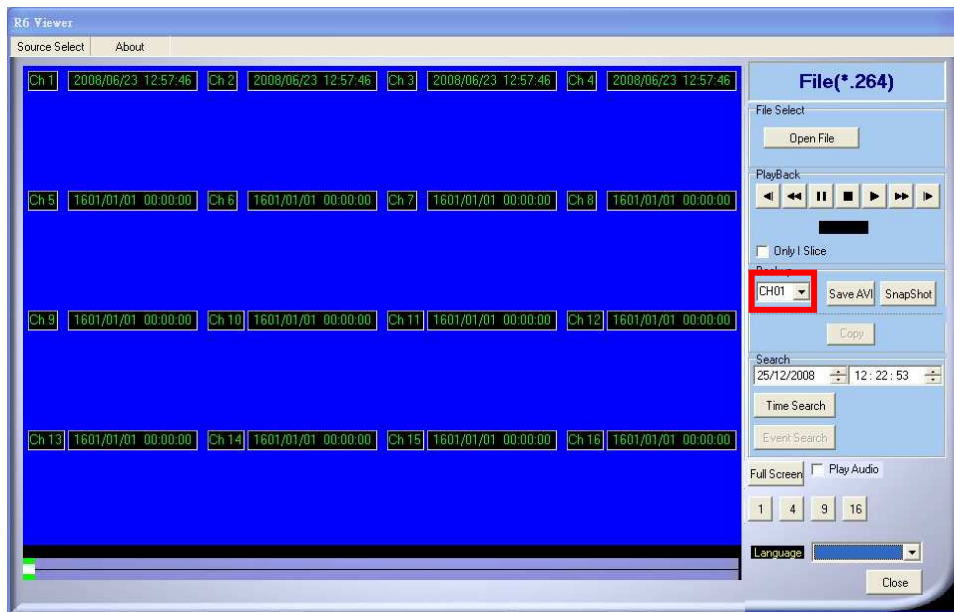

5.4 BACKUP FILE TO AVI

A. Please select specific channel to backup.



B. During video playback mode please press AVI bottom  to start.

C. Make up a filename and path than press  bottom to start AVI backup.

D. Press AVI bottom  to finish backup.

6 NETWORK VIEWING & PLAYBACK

SYSTEM REQUIREMENT

CPU: Intel Celeron 1.6G

MEMORY: 256MB.

VGA: 32MB

VGA RESOLUTION: 1024 x 768.

OS: Windows XP / 2000

SUGGESTED REQUIREMENT

CPU: Intel P4 2.8G

MEMORY: 512MB or above

VGA: 64MB or above

VGA RESOLUTION: 1024 x 768

OS: Windows XP / 2000

6.1 IP ADDRESS SETUP ON PC SITE

Install cameras inside in LAN or use network cable to connect with PC. This is for IPInstallerEng.exe to set up IP address of cameras. If OS is Windows XP SP2 or above, the following Windows Security Alert will popup. Then, please click on **Unblock**.



Then, IPInstallerEng.exe will popup:
DVR default IP address is 192.168.1.220

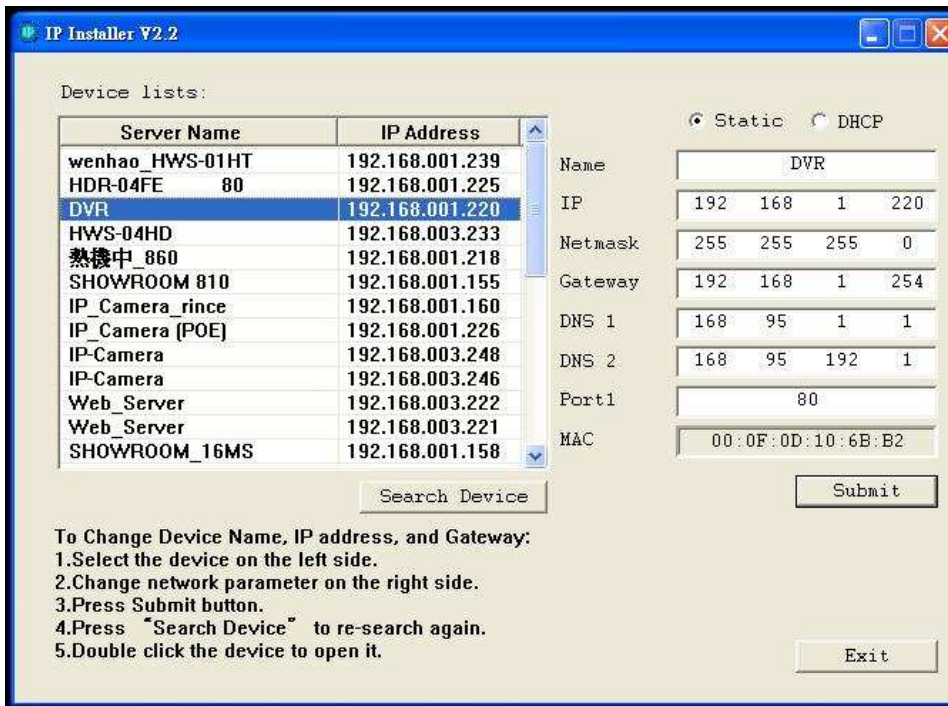

NOTE: Please input correct network parameters without blank spaces.

On Device Lists, it lists all servers. Click on one server and then its IP setting will show on the right side. After editing the parameters and clicking on Submit, the following dialogue box will popup. And, it will reboot the device with new parameters.

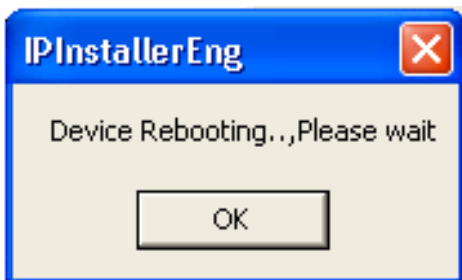

6.2 OPTIONAL MICROSOFT INTERNET EXPLORER SETUP OPTION 1: DISABLE ACTIVEX WARNING

- A. IE → Tools → Internet Options → Security → Custom Level → Security Settings → Download unsigned ActiveX controls → Enable or Prompt (recommend).
- B. IE → Tools → Internet Options → Security → Custom Level → Security Settings → Initialize and script ActiveX controls not marked as safe → Enable or Prompt (recommend).

1

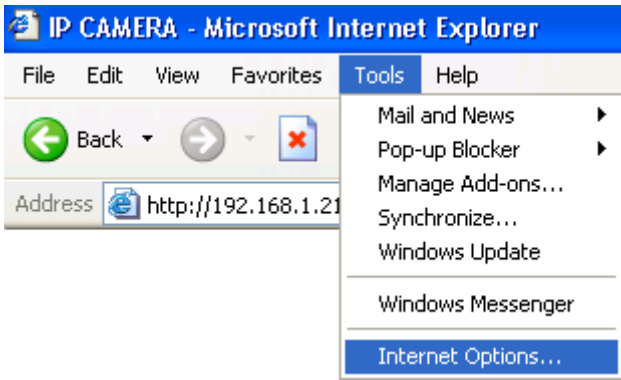

2

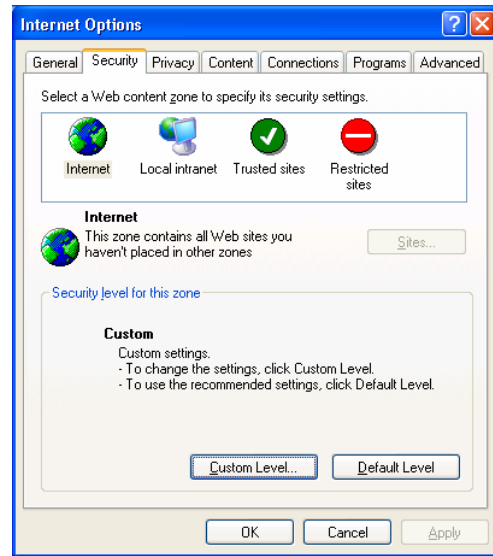

3

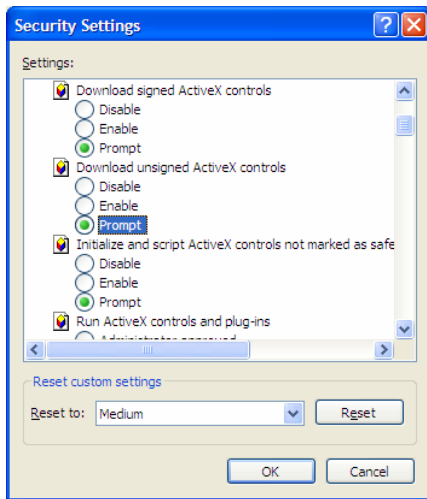

4

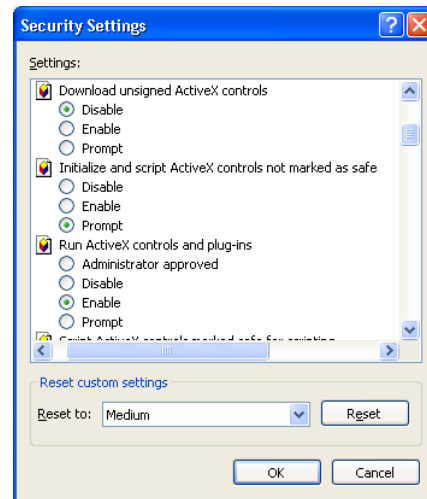

5

Above three options are all based on select as the prompt.
As indicated in the dialogue box. Please select "YES."

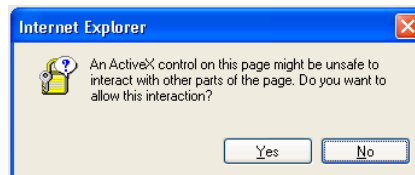

OPTION 2: ADD TO TRUSTED SITES

IE → Tools → Internet Options → Security → Trusted sites → Sites

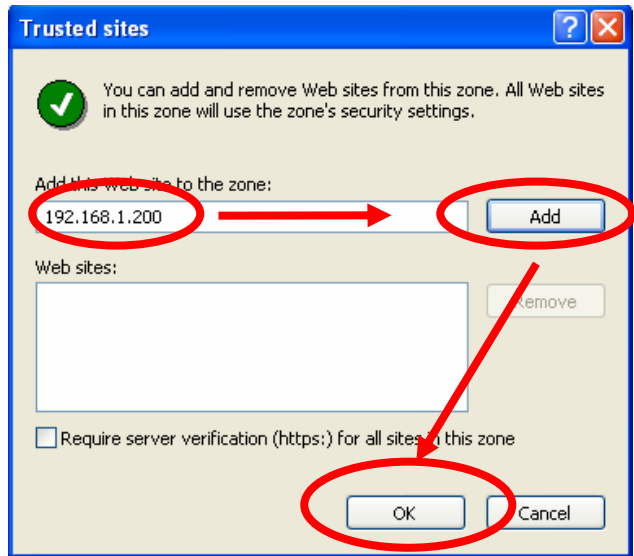
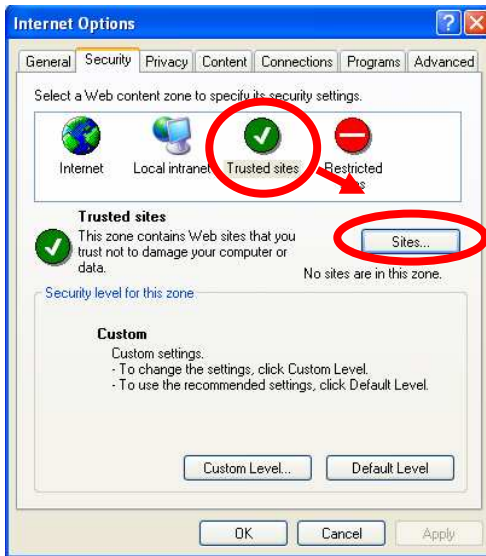

6.3 LOGIN

A. INSTALL ACTIVEVEX

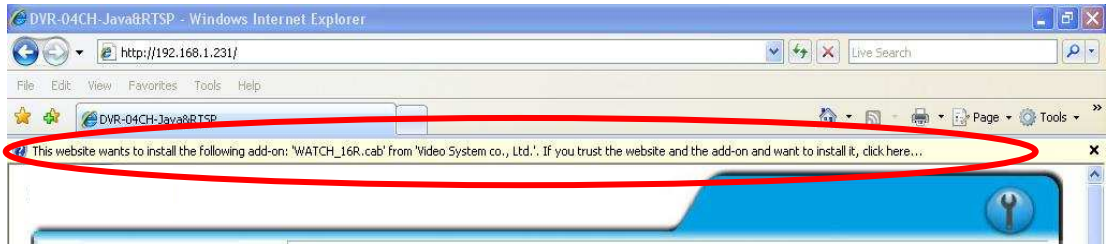

B. START INSTALL ACTIVEVEX

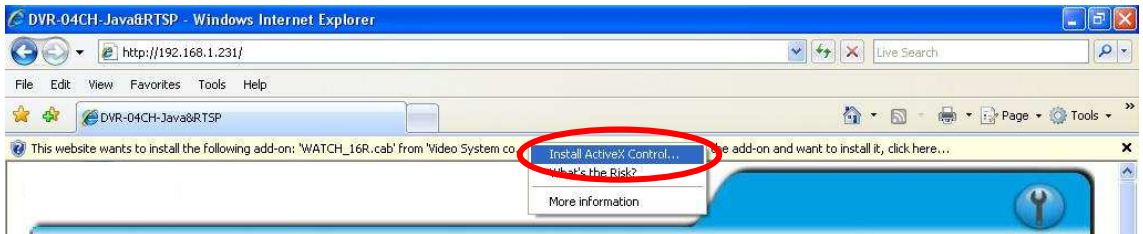

C. ACCOUNT & PASSWORD LOGIN

After IP setup and connect to network or LAN, type IP address on IE Browser directly. The following User name & Password Login window will popup.



Default user name: admin

Default password: admin

6.4 REMOTE CONTROL

LIVE VIEWING

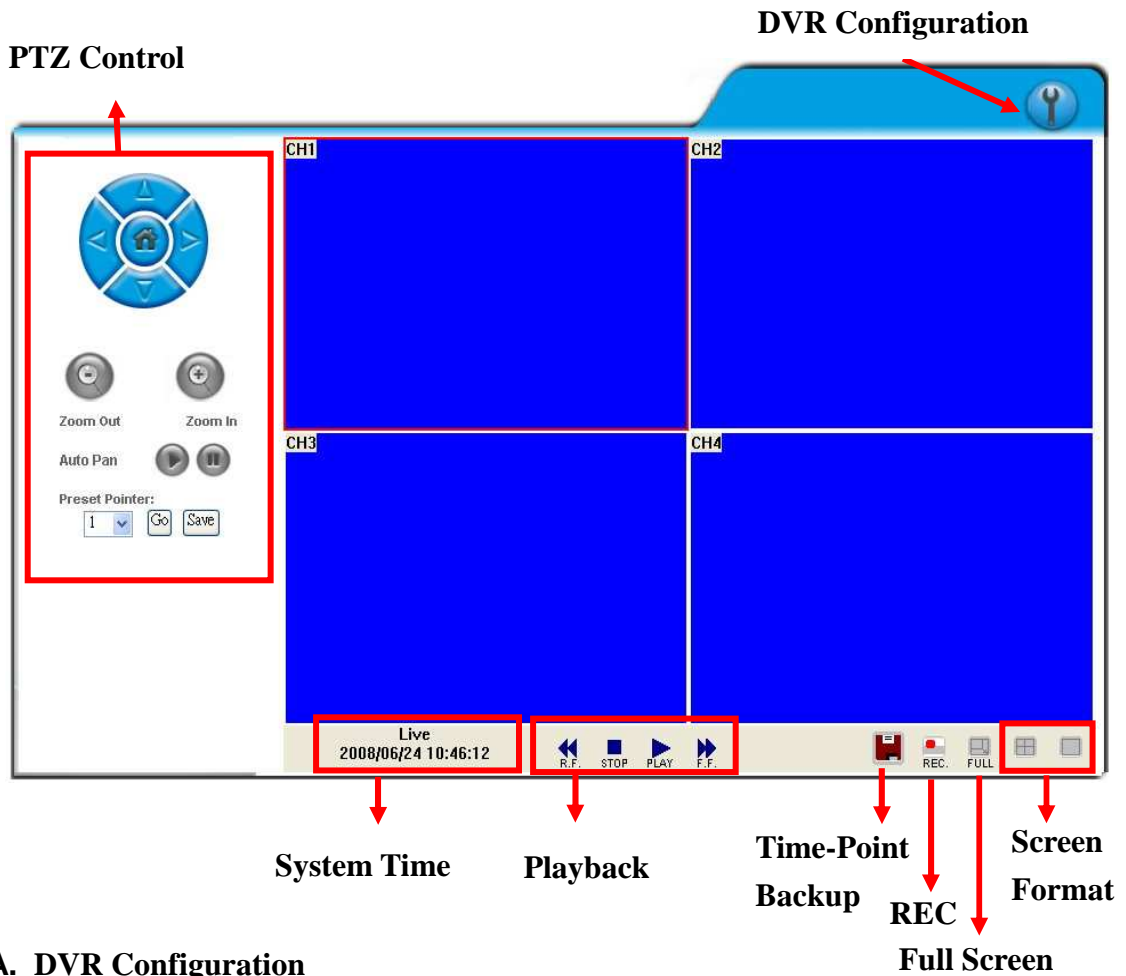

A. DVR Configuration
Get into DVR network menu.

B. PTZ Control
PTZ control function panel

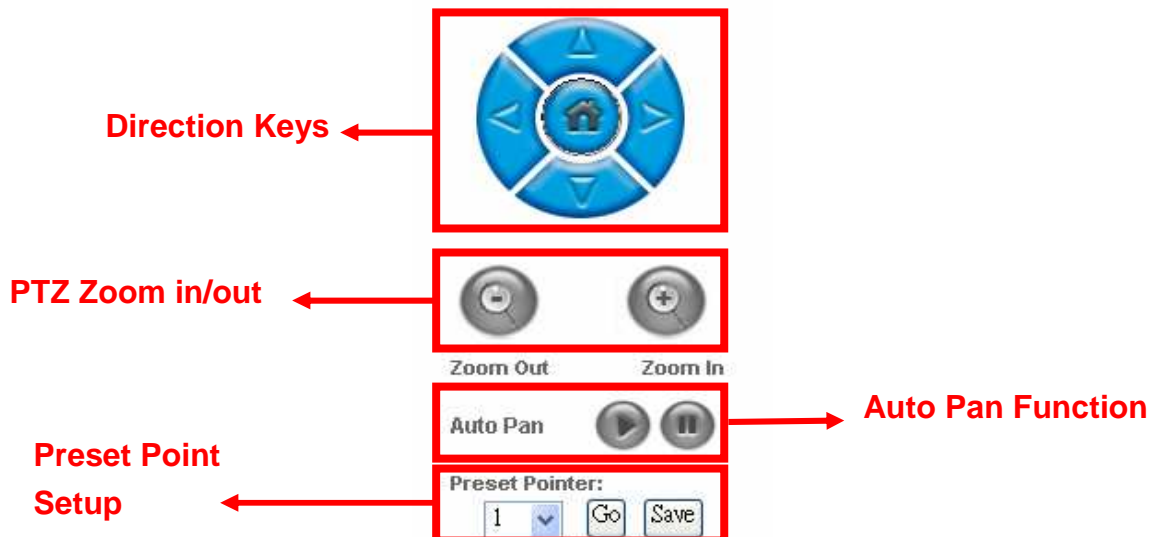

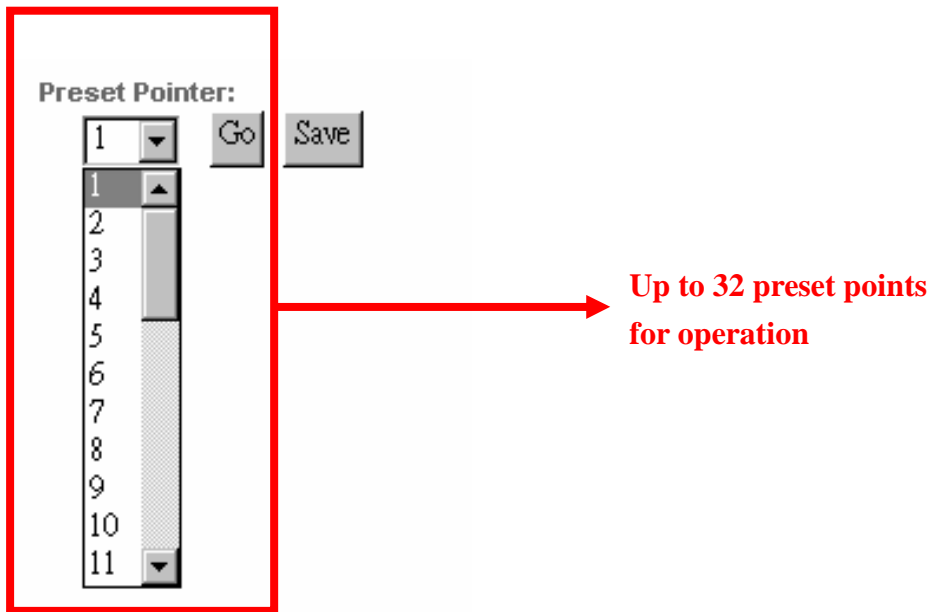

C. SYSTEM TIME

Live viewing mode: The current live viewing time.

D. SCREEN FORMAT

Switch screen format and click twice to switch different channels with full screen.

E.  **Full Screen.** Click again to return.

F.  **REC.** Videos are saved as AVI file.

G.  **Playback**

H.  **Time-Point Backup**

Click  and playback window will popup

PLAYBACK by TIME SEARCH & EVENT SEARCH

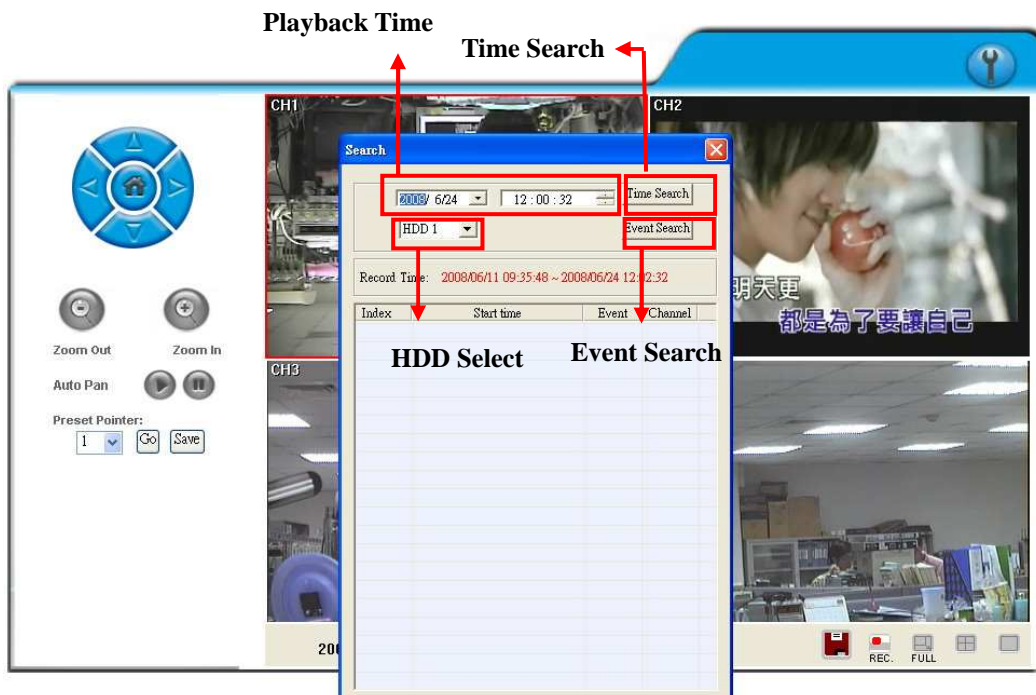

A. HDD Select

User can select HDD1 or HDD2 for playback

B. Playback Time

User can select the time then press "Time Search" for playback.

C. Time Search

User can select the time then press "Time Search" for playback.

D. Event Search

User can select event item by pressing "Event Search" for playback.

Click  to operate Time-Point backup.

TIME-POINT BACKUP

First, select Start and End backup time which have to among the Record Time.

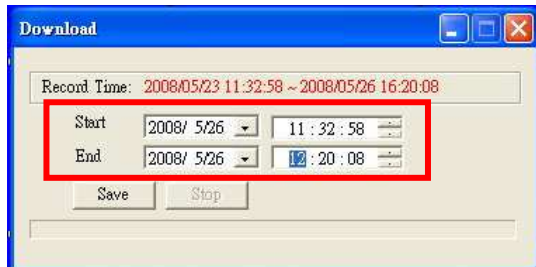

Then, click **Save** button to select the position on PC where the user is going to backup the data. After that, press **OK** button to start the backup.

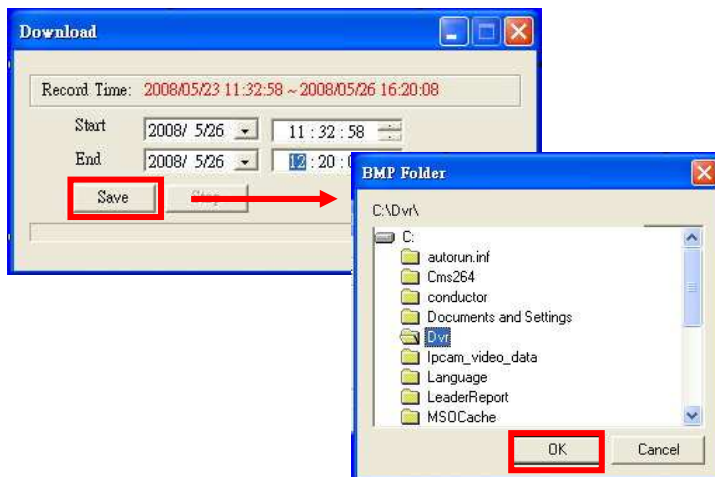

Finally, double-click the left button of the mouse to open the saved backup file. The backup file

will named as the time when start to backup, such as, (20080526113258.264) will be 2008/05/26 11:32:58.



OTHER FUNCTIONS

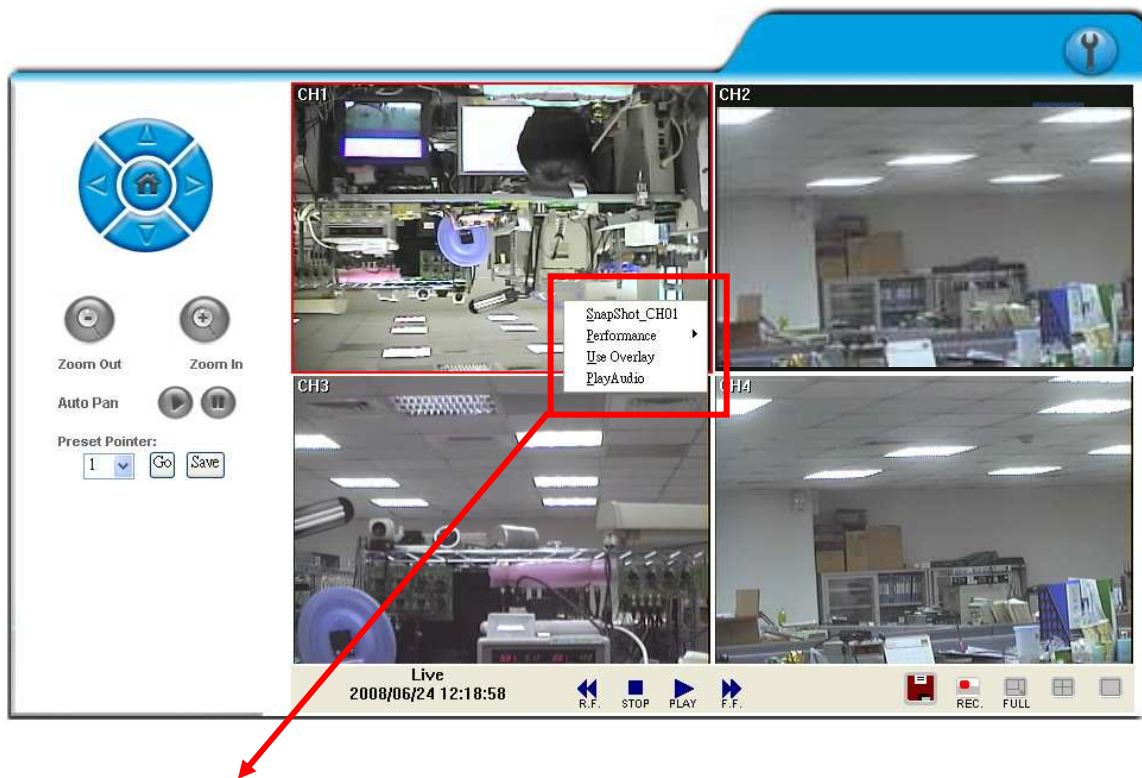

User can use other functions by clicking the left of mouse

A. Snapshot:

User can save any single picture from image.

B. Performance:

User can select image quality (high, medium & low).

C. Use Overlay:

User can use Overlay function.

D. Play audio:

User can play audio function by channel.

Note: remote user can receive audio from DVR & the audio will be saved with image when processing video backup.

6.5 CONFIGURE

A. System - System Information

System Information	
Server Information	
Server Name:	DVR-04CH
MAC Address:	00:0f:0d:00:21:a6
Language :	<input checked="" type="radio"/> English <input type="radio"/> 繁體中文 <input type="radio"/> 简体中文
NTP Setting	
Time zone:	GMT-08:00
NTP Server:	198.123.30.132
Interval:	12Hours
<input type="button" value="Apply"/>	

A-1 SYSTEM INFORMATION

SERVER NAME: This name will show on the IP Installer.

LANUGAGE : There are English, Traditional Chinese, and Simplified Chinese.

A-2 NTP Setting

NTP SERVER: Revise the time of DVR via different NTP Server.

Note: Time zone and Interval cannot adjust in here (User can adjust both in DATE and TIME SETUP option of DVR Menu).

B. SYSTEM – USER MANAGEMENT

User Management			
Anonymous User Login			
<input checked="" type="radio"/> YES <input type="radio"/> NO			<input type="button" value="Setting"/>
Add User			
Username:	<input type="text"/>		
Password:	<input type="text"/>		
Confirm:	<input type="text"/>		
<input type="button" value="Add/Set"/>			
User List			
Username	User Group	Modify	Remove
admin	Administrator	Edit	

User Management provides 3 levels of limits of authority: Administrator (the highest), User, and Guest.

Administrator: Possessing the highest level of authority to operate full functions within network.

User: Having Live Image and Video Playback authority. Moreover, PTZ controlled is included as well.

Guest: Only have Live Image authority.

Default administrator account: Username: admin Password: admin

B-1. ANONYMOUS USER LOGIN:

YES: Accept anonymous user login without password as guest login.

NO: Anonymous login unacceptable.

B-2. USER MANAGEMENT:

Add: Input Username and Password and then click on **Add/Set** to save.

Modify: Click on selected User name on User List and the following window will popup. After inputting Password and Confirm Password, click on **OK**.

Remove: Click on selected User name on the user list and click on **Remove**.



C. SYSTEM / SYSTEM UPDATE

C-1. Firmware Upgrade: Click on the “Browse” button to select the latest firmware and then press “Upgrade” button to upgrade the firmware.

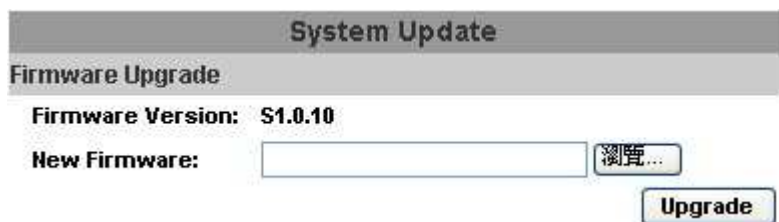

C-2. Load Default: There are three kinds of Settings. One is Load Setup From Default, another is Load Setup From and the other is Backup Setup.



Load Setup From Default: Press “Setting” button to load factory default.

Load Setup From: Click on “Browse...” button to select DVR setting file and then press “Setting” button to upload the setting file to DVR.

Backup Setup: Click on “Download” button to download the DVR setting file into the specific storage device.

D. NETWORK – IP SETTING

IP Setting	
IP Assignment	
<input type="radio"/> DHCP	
<input checked="" type="radio"/> Static	
IP Address:	<input type="text" value="192.168.1.231"/>
Subnet Mask:	<input type="text" value="255.255.255.0"/>
Gateway:	<input type="text" value="192.168.1.254"/>
DNS 0:	<input type="text" value="168.95.1.1"/>
DNS 1:	<input type="text" value="168.95.192.1"/>
Port Assignment	
Web Page Port:	<input type="text" value="80"/>
UPnP	
UPnP:	<input checked="" type="radio"/> Enabled <input type="radio"/> Disabled
<input type="button" value="Apply"/>	

D-1. IP ASSIGNMENT

DHCP: In Dynamic Host Configuration Protocol (DHCP) mode, DHCP server will get setting done automatically.

STATIC IP: Please input IP address, Subnet Mask, and Gateway based on network environment.

D-2. PORT ASSIGNMENT

With IP Share (Router), the following Ports needed to be adjusted in case of conflict.

D-3. UPnP

If UPnP service is enabled on your computer, the DVR will automatically be detected and a new icon will be added to “My Network Places”. However, if UPnP service is disabled, the DVR will not be detected automatically.

Note: UPnP must be enabled on your computer.

E. NETWORK – PPPoE

PPPoE	
PPPoE Setting	
<input type="radio"/> Enabled <input checked="" type="radio"/> Disabled	
Username:	<input type="text"/>
Password:	<input type="password"/>
Send mail after dialed	
<input type="checkbox"/> Enabled	
Subject:	<input type="text"/>
<input type="button" value="Apply"/>	

E-1. PPPoE SETTING

Click on Enabled to enable ADSL dial function.

Username: Username for ADSL account.

Password: Password for ADSL account.

After dialed successfully, new IP address will appear.

E-2. SEND MAIL AFTER DIALED

Click on Enabled to enable SEND MAIL AFTER DIALED function.

E-3. SUBJECT

Mail subject.

F. NETWORK / DDNS SETTING

DDNS

DDNS Setting

Enabled Disabled

Provider:

Hostname:

Username:

Password:

Schedule Update: Minutes

State

Note:

1. Schedule Update: Feature of DDNS schedule update is designed for IP products which installed behind the ICS or NAT devices. Update range from every 5 (minutes) to 5000 (minutes) and 0 remain to off.
2. Please note that the hostname will be blocked by DynDNS.org if schedule update is more than once every 5 minutes to 60 minutes. In general, schedule update in every 1440 minutes is recommended.

Click on Enabled to enable DDNS function.

F-1. DYNDNS.ORG

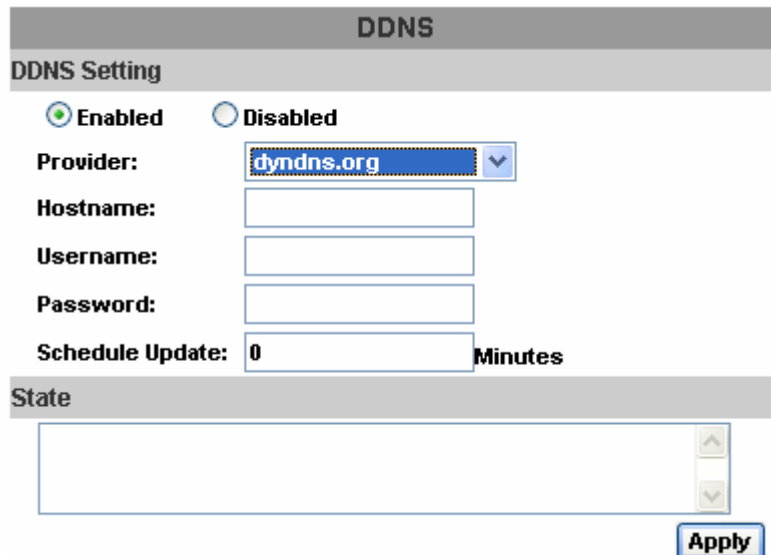

The screenshot shows the DDNS Setting page for dyndns.org. The page has a grey header with 'DDNS' in the center. Below the header is a section titled 'DDNS Setting'. It contains two radio buttons: 'Enabled' (selected) and 'Disabled'. There are four input fields: 'Provider' (a dropdown menu with 'dyndns.org' selected), 'Hostname', 'Username', and 'Password'. Below these is a 'Schedule Update' field with the value '0' and the unit 'Minutes'. At the bottom of the settings section is a 'State' dropdown menu, which is currently empty. An 'Apply' button is located at the bottom right of the page.

DDNS SETTING - DYNDNS.ORG

PROVIDER: Select dyndns.org

HOSTNAME: The registered hostname in DYNDNS.ORG.

USERNAME: The registered username in DYNDNS.ORG.

PASSWORD: The registered password in DYNDNS.ORG.

SCHEDULE UPDATE: A period of time to update IP address.

STATE

1. Updating: Information update.
2. Idle: Stop service.
3. DDNS registered successfully, now log by
<http://<username>.ddns.camddns.com>: Registered successfully.
4. Updating Failed, the name is already registered.
5. Updating Failed, please check your internet connection.

F-2. DDNS.CAMNND.S.COM

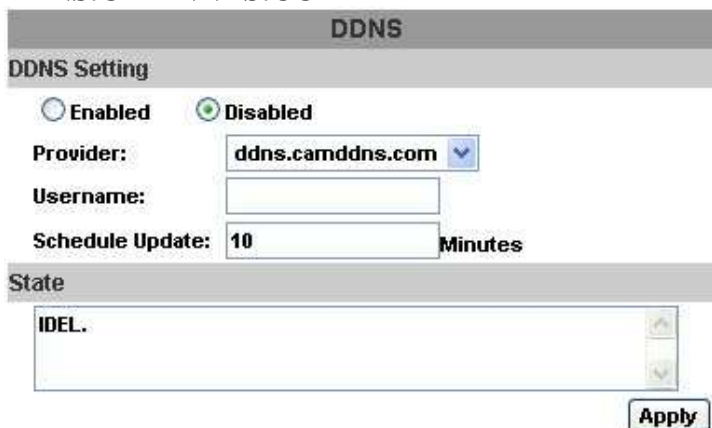

The screenshot shows the DDNS Setting page for ddns.camddns.com. The page has a grey header with 'DDNS' in the center. Below the header is a section titled 'DDNS Setting'. It contains two radio buttons: 'Enabled' and 'Disabled' (selected). There are three input fields: 'Provider' (a dropdown menu with 'ddns.camddns.com' selected), 'Username', and 'Schedule Update' (with the value '10' and the unit 'Minutes'). At the bottom of the settings section is a 'State' dropdown menu, which currently shows 'IDEL.'. An 'Apply' button is located at the bottom right of the page.

Note:

1. Schedule Update: Feature of DDNS schedule update is designed for IP products which installed behind the ICS or NAT devices. Update range from every 5 (minutes) to 5000 (minutes) and 0 remain to off.
2. Please note that the hostname will be blocked by DynDNS.org if schedule update is more than once every 5 minutes to 60 minutes. In general, schedule update in every 1440 minutes is recommended.

DDNS SETTING – DDNS.CAMDdns.COM

PROVIDER: Select ddns.camddns.com

USERNAME: The registered username in DDNS.CAMDdns.COM.

SCHEDULE UPDATE: A period of time to update IP address.

STATE

1. Updating: Information update.
2. Idle: Stop service.
3. DDNS registered successfully, now log by
http://<username>.ddns.camddns.com: Registered successfully.
4. Updating Failed, the name is already registered.
5. Updating Failed, please check your internet connection.

DDNS Setting Steps:

Press ① “ENABLE” option to enable DDNS function and select ②

“**ddns.camddns.com**” of the provider drop down list which is suggested to use. In

the following, insert ③ the username which the user wants to apply

(i.e. **DVR_GODDNS** in here). After that, click ④ “Apply” button to apply a

DDNS domain name.

The screenshot shows the DDNS configuration interface. At the top, the title is "DDNS". Below it, the section is "DDNS Setting". There are two radio buttons: "Enabled" (selected) and "Disabled". A red box labeled "1." highlights the "Enabled" radio button. Below this, there are three fields: "Provider:" with a dropdown menu showing "ddns.camddns.com" (highlighted with a red box and "2."), "Username:" with a text input field containing "DVR_GODDNS" (highlighted with a red box and "3."), and "Schedule Update:" with a text input field containing "60" and the label "Minutes". Below these fields is a "State:" section with a text area containing "Updating...". At the bottom right, there is an "Apply" button (highlighted with a red box and "4.") and a "Cancel" button.

Finally, the DVR domain name **5** (http://DVR_GODDNS.ddns.camddns.com) will be shown on the state block.

DDNS

DDNS Setting

Enabled Disabled

Provider:

Username:

Schedule Update: Minutes

State

5.

- NOTE:**
1. If the user selects another provider which is ddns2.ydsdvr.com, all of the setting steps are the same with ddns.camddns.com setting.
 2. However, if dyndns.org provider is selected, please go to www.dyndns.org website to register the account first. The user has to fill in the username, password and hostname for applying the account. After the user applied the account successfully, the dyndns.org will give the user a complete DDNS domain name.
 3. If setting up IP schedule update too frequently, the IP may be blocked. In general, schedule update every day (1440 minutes) is recommended.

G. NETWORK / Mail & FTP

Click on “Motion” or “Alarm” option to enable Mail Setting and FTP Setting function.

Mail & FTP

Mail Setting: Motion Alarm

Mail Server:

Username:

Password:

Sender's Mail:

Receiver's Mail:

Bcc Mail:

Event Subject:

FTP Setting: Motion Alarm

FTP Server:

Username:

Password:

Port:

Path:

Mail Server: The IP address of Mail Server (i.e. mail.huntelec.com.tw).
Username: The username while log in to the mail server.
Password: The password while log in to the mail server.
Sender's Mail: The sender's account when send the mail via this mail server.
Receiver's Mail: The receiver's mail address.
Bcc Mail: The receiver's mail address for Bcc Mail.
Event Subject: The subject of this mail. (Default value is ALARM MAIL)

FTP Server: The IP address of FTP Server.
Username: The username while log in to the ftp server.
Password: The password while log in to the ftp server.
Port: The port number of file transmission. (Default value is 21)
Path: The ftp path where the user wants to reserve the information.

Finally, click on **Apply** button to reserve the setting.

H. OTHERS / Player Downloaded

User can click "Run" button to download the player to local PC.

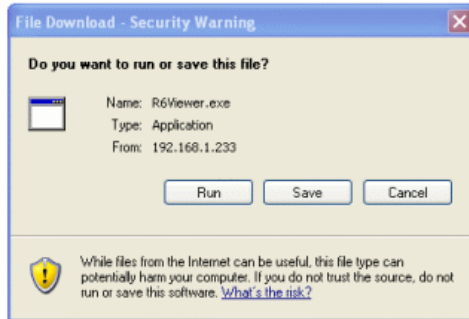

I. OTHERS/ Mobile Viewer

Click the drop down list of connection mode to select the sort of mobile viewer connection. Then click **Apply** to reserve the setting. There are JAVA / iPhone and 3GPP (MPEG4) two options. Moreover, the video quality can be setup as well.



J. OTHERS / DVR Setting

DVR setting can be changed via the Internet.

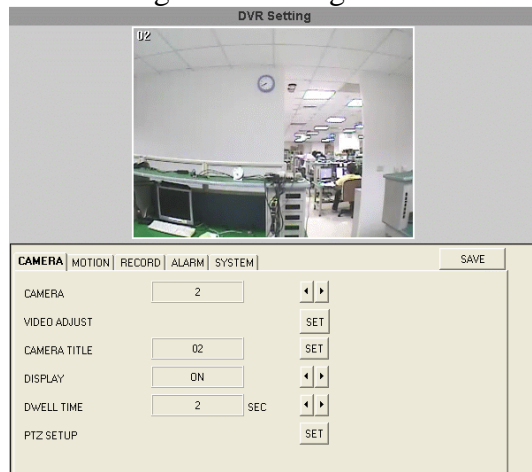

7 3GPP APPLICATION & SETTING

3GPP (also known as 3rd Generation Partnership Project) is a corporation which formulate 3rd-generation communication standard specification. Via this wireless communication protocol, the 3G mobile can perform the remote control. The following example is operated by Sony Ericsson 3G mobile phone:

<p>1. Press MENU KEY to get into menu.</p>	<p>2. Select Internet services</p>
	
<p>3. In the Internet services page, press More KEY</p>	<p>4. Select Enter address, and press Select KEY</p>
	
<p>5. Select New address , and press Enter KEY</p>	<p>6. Fill in address <code>rtsp:// <<IP>>/channel</code> (<code>rtsp://220.137.65.246/CH03</code>) and press Go To KEY.</p>
	

7. **“Connected to media server”** will appear



8. Success with vivid image



- * 1. 3GPP BANDWIDTH: Minimum 30kbit /sec. per channel.
- 2. CONNECTION NUMBERS: Maximum 16 people per channel.

APPENDIX A: RECORDING TIME LAPSE (HOURS)

FULL D1- 720x480

160 GB Hard Disk												Unit: Hour		
Recording Speed (IPS)	PICTURE QUALITY (KB)													
	LOW			MEDIUM			HIGH			BEST				
	simple	complex	average	simple	complex	average	simple	complex	average	simple	complex	average		
	0.80	5.63	3.52	4.38	10.38	6.78	3.64	13.43	8.98	5.60	17.06	15.66		
60	970	137	553	190	74	132	213	57	135	138	45	91		
30	1941	275	1108	380	149	264	426	115	270	277	91	184		
15	3883	551	2217	761	299	530	853	231	542	554	182	368		
8	7281	1034	4157	1427	560	993	1600	433	1016	1040	341	690		
4	14563	2068	8315	2855	1121	1988	3200	867	2033	2080	683	1381		

250 GB Hard Disk												Unit: Hour		
Recording Speed (IPS)	PICTURE QUALITY (KB)													
	LOW			MEDIUM			HIGH			BEST				
	simple	complex	average	simple	complex	average	simple	complex	average	simple	complex	average		
	0.80	5.63	3.52	4.38	10.38	6.78	3.64	13.43	8.98	5.60	17.06	15.66		
60	1517	215	866	297	116	206	333	90	211	216	71	143		
30	3034	430	1732	594	233	413	666	180	423	433	142	287		
15	6068	861	3464	1189	467	828	1333	361	847	866	284	575		
8	11377	1616	6496	2230	876	1553	2500	677	1588	1625	533	1079		
4	22755	3232	12993	4461	1753	3107	5001	1355	3178	3250	1067	2158		

400 GB Hard Disk												Unit: Hour		
Recording Speed (IPS)	PICTURE QUALITY (KB)													
	LOW			MEDIUM			HIGH			BEST				
	simple	complex	average	simple	complex	average	simple	complex	average	simple	complex	average		
	0.80	5.63	3.52	4.38	10.38	6.78	3.64	13.43	8.98	5.60	17.06	15.66		
60	2427	344	1385	475	186	330	533	144	338	346	113	229		
30	4854	689	2771	951	373	662	1066	289	677	693	227	460		
15	9709	1379	5544	1903	747	1325	2133	578	1355	1387	455	921		
8	18204	2585	10394	3569	1402	2485	4000	1084	2542	2600	853	1726		
4	36408	5171	20789	7138	2804	4971	8001	2168	5084	5201	1707	3454		

500 GB Hard Disk												Unit: Hour		
Recording Speed (IPS)	PICTURE QUALITY (KB)													
	LOW			MEDIUM			HIGH			BEST				
	simple	complex	average	simple	complex	average	simple	complex	average	simple	complex	average		
	0.80	5.63	3.52	4.38	10.38	6.78	3.64	13.43	8.98	5.60	17.06	15.66		

60	3034	430	1732	549	233	413	666	180	423	433	142	287
30	6068	861	3464	1189	467	828	1333	361	847	866	284	575
15	12136	1723	6929	2379	934	1656	2667	722	1694	1733	569	1151
8	22755	3232	12993	4461	1753	3107	5001	1355	3178	3250	1067	2158
4	45511	6464	25987	8923	3506	6214	10002	2710	6356	6501	2134	4317

750 GBHard Disk

Unit: Hour

Recording Speed (IPS)	PICTURE QUALITY (KB)											
	LOW			MEDIUM			HIGH			BEST		
	simple	complex	average	simple	complex	average	simple	complex	average	simple	complex	average
	0.80	5.63	3.52	4.08	10.38	6.78	3.64	13.43	8.98	5.60	17.06	15.66
60	4551	646	2598	892	350	621	1000	271	635	650	213	431
30	9102	1292	5197	1784	701	1242	2000	542	1271	1300	426	863
15	18204	2585	10349	3569	1402	2485	4000	1084	2542	2600	853	1726
8	34133	4848	19490	6692	2629	4660	7501	2032	4766	4876	1601	3238
4	68266	9696	38981	13385	5259	9322	15003	4065	9534	9752	3202	6477

1THard Disk

Unit: Hour

Recording Speed (IPS)	PICTURE QUALITY (KB)											
	LOW			MEDIUM			HIGH			BEST		
	simple	complex	average	simple	complex	average	simple	complex	average	simple	complex	average
	0.80	5.63	3.52	4.08	10.38	6.78	3.64	13.43	8.98	5.60	17.06	15.66
60	6068	861	3464	1189	467	828	1333	361	847	866	284	575
30	12136	1723	6929	2379	934	1656	2667	722	1694	1733	569	1151
15	24272	3447	13859	4759	1869	3314	5334	1445	3389	3467	1138	2302
8	45511	6464	25987	8923	3506	6214	10002	2710	6356	6501	2134	4317
4	91022	12929	51975	17847	7012	12429	20004	5421	12712	13003	4269	8636

HALF D1- 720x240

80 GB Hard Disk												Unit: Hour
Recording Speed (PPS)	PICTURE QUALITY (KB)											
	LOW			MEDIUM			HIGH			BEST		
	simple	complex	average	simple	complex	average	simple	complex	average	simple	complex	average
	1.00	3.80	2.40	2.00	6.00	4.00	5.00	10.00	7.50	6.00	17.00	11.50
120	194	51	122	97	32	64	38	19	28	32	11	21
60	388	102	245	194	64	129	77	38	57	64	22	43
30	776	204	490	388	129	258	155	77	116	129	45	87
15	1553	408	980	776	258	517	310	155	232	258	91	174
8	2912	766	1839	1456	485	970	582	291	436	485	171	328
4	5825	1533	3679	2912	970	1941	1165	582	873	970	342	656

160 GB Hard Disk												Unit: Hour
Recording Speed (PPS)	PICTURE QUALITY (KB)											
	LOW			MEDIUM			HIGH			BEST		
	simple	complex	average	simple	complex	average	simple	complex	average	simple	complex	average
	1.00	3.80	2.40	2.00	6.00	4.00	5.00	10.00	7.50	6.00	17.00	11.50
120	388	102	245	194	64	129	77	38	57	64	22	43
60	776	204	490	388	129	258	155	77	116	129	45	87
30	1553	408	980	776	258	517	310	155	232	258	91	174
15	3106	817	1961	1553	517	1035	621	310	465	517	182	349
8	5825	1533	3679	2912	970	1941	1165	582	873	970	342	656
4	11650	3066	7358	5825	1941	3883	2330	1165	1747	1941	685	1313

250 GB Hard Disk												Unit: Hour
Recording Speed (PPS)	PICTURE QUALITY (KB)											
	LOW			MEDIUM			HIGH			BEST		
	simple	complex	average	simple	complex	average	simple	complex	average	simple	complex	average
	1.00	3.80	2.40	2.00	6.00	4.00	5.00	10.00	7.50	6.00	17.00	11.50
120	606	159	382	303	101	202	121	60	90	101	35	68
60	1213	319	766	606	202	404	242	121	181	202	71	136
30	2427	638	1532	1213	404	808	485	242	363	404	142	273
15	4854	1277	3065	2427	809	1618	970	485	727	809	285	547
8	9102	2395	5748	4551	1517	3034	1820	910	1365	1517	535	1026
4	18204	4790	11497	9102	3034	6068	3640	1820	2730	3034	1070	2052

400 GB Hard Disk												Unit: Hour
Recording Speed (PPS)	PICTURE QUALITY (KB)											
	LOW			MEDIUM			HIGH			BEST		
	simple	complex	average	simple	complex	average	simple	complex	average	simple	complex	average
1.00	3.80	2.40	2.00	6.00	4.00	5.00	10.00	7.50	6.00	17.00	11.50	

(PPS)	simple	complex	average	simple	complex	average	simple	complex	average	simple	complex	average
	1.00	3.80	2.40	2.00	6.00	4.00	5.00	10.00	7.50	6.00	17.00	11.50
120	970	255	612	485	161	323	194	97	145	161	57	109
60	1941	511	1226	970	323	646	388	194	291	323	114	218
30	3883	1022	2452	1941	647	1294	776	388	582	647	228	437
15	7767	2044	4905	3883	1294	2588	1553	776	1164	1294	456	875
8	14563	3832	9197	7281	2427	4854	2912	1456	2184	2427	856	1641
4	29127	7665	18396	14563	4854	9708	5825	2912	4368	4854	1713	3283

500 GB Hard Disk

Unit: Hour

Recording Speed (PPS)	PICTURE QUALITY (KB)											
	LOW			MEDIUM			HIGH			BEST		
	simple	complex	average	simple	complex	average	simple	complex	average	simple	complex	average
	1.00	3.80	2.40	2.00	6.00	4.00	5.00	10.00	7.50	6.00	17.00	11.50
120	1213	319	766	606	202	404	242	121	181	202	71	136
60	2427	638	1532	1213	404	808	485	242	363	404	142	273
30	4854	1277	3065	2427	809	1618	970	485	727	809	285	547
15	9709	2555	6132	4854	1618	3236	1941	970	1455	1618	571	1094
8	18204	4790	11497	9102	3034	6068	3640	1820	2730	3034	1070	2052
4	36408	9581	22994	18204	6068	12136	7281	3640	5460	6068	2141	4104

750 GB Hard Disk

Unit: Hour

Recording Speed (PPS)	PICTURE QUALITY (KB)											
	LOW			MEDIUM			HIGH			BEST		
	simple	complex	average	simple	complex	average	simple	complex	average	simple	complex	average
	1.00	3.80	2.40	2.00	6.00	4.00	5.00	10.00	7.50	6.00	17.00	11.50
120	1820	479	1149	910	303	606	364	182	273	303	107	205
60	3640	958	2299	1820	606	1213	728	364	546	606	214	410
30	7281	1916	4598	3640	1213	2426	1456	728	1092	1213	428	820
15	14563	3832	9197	7281	2427	4854	2912	1456	2184	2427	856	1641
8	27306	7185	17245	13653	4551	9102	5461	2730	4095	4551	1606	3078
4	54613	14371	34492	27306	9102	18204	10922	5461	8191	9102	3212	6157

1T Hard Disk

Unit: Hour

Recording Speed (PPS)	PICTURE QUALITY (KB)											
	LOW			MEDIUM			HIGH			BEST		
	simple	complex	average	simple	complex	average	simple	complex	average	simple	complex	average
	1.00	3.80	2.40	2.00	6.00	4.00	5.00	10.00	7.50	6.00	17.00	11.50
120	2427	638	1532	1213	404	808	485	242	363	404	142	273
60	4854	1277	3065	2427	809	1618	970	485	727	809	285	547

30	9709	2555	6132	4854	1618	3236	1941	970	1455	1618	571	1094
15	19418	5110	12264	9709	3236	6472	3883	1941	2912	3236	1142	2189
8	36408	9581	22994	18204	6068	12136	7281	3640	5460	6068	2141	4104
4	72817	19162	45989	36408	12136	24272	14563	7281	10922	12136	4283	8209

CIF-360x240

80 GB Hard Disk												Unit: Hour
Recording Speed (PPS)	PICTURE QUALITY (KB)											
	LOW			MEDIUM			HIGH			BEST		
	simple	complex	average	simple	complex	average	simple	complex	average	simple	complex	average
	0.50	1.90	1.20	1.00	3.00	2.00	2.50	5.00	3.75	3.00	8.75	5.88
240	194	51	122	97	32	64	38	19	28	32	11	21
120	388	102	245	194	64	129	77	38	57	64	22	43
60	776	204	490	388	129	258	155	77	116	129	44	86
30	1553	408	980	776	258	517	310	155	232	258	88	173
15	3106	817	1961	1553	517	1035	621	310	465	517	177	347
8	5825	1533	3679	2912	970	1941	1165	582	873	970	332	651
4	11650	3066	7358	5825	1941	3883	2330	1165	1747	1941	665	1303

160 GB Hard Disk												Unit: Hour
Recording Speed (PPS)	PICTURE QUALITY (KB)											
	LOW			MEDIUM			HIGH			BEST		
	simple	complex	average	simple	complex	average	simple	complex	average	simple	complex	average
	0.50	1.90	1.20	1.00	3.00	2.00	2.50	5.00	3.75	3.00	8.75	5.88
240	388	102	245	194	64	129	77	38	57	64	22	43
120	776	204	490	388	129	258	155	77	116	129	44	86
60	1553	408	980	776	258	517	310	155	232	258	88	173
30	3106	817	1961	1553	517	1035	621	310	465	517	177	347
15	6213	1635	3924	3106	1035	2070	1242	621	931	1035	355	695
8	11650	3066	7358	5825	1941	3883	2330	1165	1747	1941	665	1303
4	23301	6132	14716	11650	3883	7766	4660	2330	3495	3883	1331	2607

250 GB Hard Disk												Unit: Hour
Recording Speed (PPS)	PICTURE QUALITY (KB)											
	LOW			MEDIUM			HIGH			BEST		
	simple	complex	average	simple	complex	average	simple	complex	average	simple	complex	average
	0.50	1.90	1.20	1.00	3.00	2.00	2.50	5.00	3.75	3.00	8.75	5.88
240	606	159	382	303	101	202	121	60	90	101	34	67
120	1213	319	766	606	202	404	242	121	181	202	69	135
60	2427	638	1532	1213	404	808	485	242	363	404	138	271
30	4854	1277	3065	2427	809	1618	970	485	727	809	277	543
15	9709	2555	6132	4854	1618	3236	1941	970	1455	1618	554	1086
8	18204	4790	11497	9102	3034	6068	3640	1820	2730	3034	1040	2037
4	36408	9581	22994	18204	6068	12136	7281	3640	5460	6068	2080	4074

400 GB Hard Disk												Unit: Hour
-------------------------	--	--	--	--	--	--	--	--	--	--	--	------------

Recording Speed (PPS)	PICTURE QUALITY (KB)											
	LOW			MEDIUM			HIGH			BEST		
	simple	complex	average	simple	complex	average	simple	complex	average	simple	complex	average
	0.50	1.90	1.20	1.00	3.00	2.00	2.50	5.00	3.75	3.00	8.75	5.88
240	970	255	612	485	161	323	194	97	145	161	55	108
120	1941	511	1226	970	323	646	388	194	291	323	110	216
60	3883	1022	2452	1941	647	1294	776	388	582	647	221	434
30	7767	2044	4905	3883	1294	2588	1553	776	1164	1294	443	868
15	15534	4088	9811	7767	2589	5178	3106	1553	2329	2589	887	1738
8	29127	7665	18396	14563	4854	9708	5825	2912	4368	4854	1664	3259
4	58254	15330	36792	29127	9709	19418	11650	5825	8737	9709	3328	6518

500 GB Hard Disk

Unit: Hour

Recording Speed (PPS)	PICTURE QUALITY (KB)											
	LOW			MEDIUM			HIGH			BEST		
	simple	complex	average	simple	complex	average	simple	complex	average	simple	complex	average
	0.50	1.90	1.20	1.00	3.00	2.00	2.50	5.00	3.75	3.00	8.75	5.88
240	1213	319	766	606	202	404	242	121	181	202	69	135
120	2427	638	1532	1213	404	808	485	242	363	404	138	271
60	4854	1277	3065	2427	809	1618	970	485	727	809	277	543
30	9709	2555	6132	4854	1618	3236	1941	970	1455	1618	554	1086
15	19418	5110	12264	9709	3236	6472	3883	1941	2912	3236	1109	2172
8	36408	9581	22994	18204	6068	12136	7281	3640	5460	6068	2080	4074
4	72817	19162	45989	36408	12136	24272	14563	7281	10922	12136	4161	8148

750 GB Hard Disk

Unit: Hour

Recording Speed (PPS)	PICTURE QUALITY (KB)											
	LOW			MEDIUM			HIGH			BEST		
	simple	complex	average	simple	complex	average	simple	complex	average	simple	complex	average
	0.50	1.90	1.20	1.00	3.00	2.00	2.50	5.00	3.75	3.00	8.75	5.88
240	1820	479	1149	910	303	606	364	182	273	303	104	203
120	3640	958	2299	1820	606	1213	728	364	546	606	208	407
60	7281	1916	4598	3640	1213	2426	1456	728	1092	1213	416	814
30	14563	3832	9197	7281	2427	4854	2912	1456	2184	2427	832	1629
15	29127	7665	18396	14563	4854	9708	5825	2912	4368	4854	1664	3259
8	54613	14371	34492	27306	9102	18204	10922	5461	8191	9102	3120	6111
4	109226	28743	68984	54613	18204	36408	21845	10922	16383	18204	6241	12222

1T Hard Disk

Unit: Hour

Recording	PICTURE QUALITY (KB)											
-----------	----------------------	--	--	--	--	--	--	--	--	--	--	--

Speed (PPS)	LOW			MEDIUM			HIGH			BEST		
	simple	complex	average	simple	complex	average	simple	complex	average	simple	complex	average
	0.50	1.90	1.20	1.00	3.00	2.00	2.50	5.00	3.75	3.00	8.75	5.88
240	2427	638	1532	1213	404	808	485	242	363	404	138	271
120	4854	1277	3065	2427	809	1618	970	485	727	809	277	543
60	9709	2555	6132	4854	1618	3236	1941	970	1455	1618	554	1086
30	19418	5110	12264	9709	3236	6472	3883	1941	2912	3236	1109	2172
15	38836	10220	24528	19418	6472	12945	7767	3883	5825	6472	2219	4345
8	72817	19162	45989	36408	12136	24272	14563	7281	10922	12136	4161	8148
4	145635	38325	91980	72817	24272	48544	29127	14563	21845	24272	8322	16297

* The value is for reference only

APPENDIX B: HDD COMPATIBLE TABLE

Brand	Model	Capacity	others
SEAGATE	STM3250820AS	250 GB	7200 10
	ST3250310SV	250GB	SV35.3
	ST3400620AS	400 GB	7200 10
	ST3500320SV	500GB	SV35.3
	ST3500320AS	500GB	7200 11
	ST3500418AS	500GB	7200 12
	ST3750640AS	750 GB	7200 10
	ST3750330AS	750 GB	7200 11
	ST31000333AS	1TB	7200 11
	ST31000340AS	1TB	7200 11
	ST31000340NS	1TB	Barracuda ES.2
	ST31000340SV	1TB	SV35.3
	ST31500341AS	1.5TB	7200 11
WD	WD1600AAJS	160 GB	7200 CB
	WD2500AAKS	250 GB	7200 CB
	WD2500AVVS	250 GB	7200 GP
	WD5000AACS	500 GB	7200 GP
	WD5000AVVS	500 GB	7200 GP
	WD5000AAKS	500GB	7200 CB
	WD6400AAKS	640 GB	7200 BLUE
	WD6400AVVS	640 GB	7200 GP
	WD7500AACS	750GB	7200 GP
	WD7500AVVS	750GB	7200 GP
	WD10EACS	1TB	7200 GP
	WD10EADS	1TB	Caviar Green
	WD10EVDS	1TB	Green Power
	WD10EVVS	1TB	7200 GP
	WD15EADS	1.5TB	7200 GP
	WD15EARS	1.5TB	7200 GP
	WD20EADS	2.0TB	7200 GP
HITACHI	HDS721616PLA380	160 GB	7200
	HDT725025VLA380	250 GB	7200
	HDT725032VLA360	320 GB	7200
	HDP725050GLA360	500 GB	7200
	HCP725050GLA380	500GB	7200
	HDT721010SLA360	1TB	7200

* The compatible table is for reference only

APPENDIX C: ERROR MESSAGE LIST

ERROR MESSAGE	ERROR STATUS & REASON	NOTE
DISK ACCESS ERROR!	H.D.D. Data structure Un-normal. Data does not record into DVR or bad sector on DVR H.D.D. Please install another H.D.D. and perform the record again.	
UPDATE FILE ERROR!	Please re-download the update file and update again.	
FIRMWARE UPGRADE FAILED	Please reboot the DVR and upgrade the firmware. Please send the DVR back to repair when DVR is disability.	
MEDIA ACCESS FAIL!	The USB file format is incorrect (Please format the pen drive to FAT32) or Pen Drive is setup to ONLY READ mode (Please annul ONLY READ mode) when reserve the data by using Pen Drive. The data cannot be burn into CD/DVD disc. Please change another CD/DVD disc and backup the file in CD/DVD disc storage.	
NO FILE!	There is no upgrade file within Pen Drive or the name of upgrade file does not correspond with DVR format. Please adjust the upgrade file name based on the following information. 16CH -> UpdateR.bin 08CH -> Update8.bin 04CH -> Update4.bin	
USB DEVICE NOT FOUND NO USB	Pen Drive undetected. Please Unplug the Pen Drive and plug it again.	
BACKUP START TIME ERROR	Backup start time error.	
BACKUPEND TIME ERROR	Backup end time error.	
DISK ERROR	The data cannot be burn into CD/DVD disc. Please change another CD/DVD disc and backup the file.	
FAN FAILED	Fan Error Warning.	
NO LOG DATA	No Events Record.	
SCHEDULE RECORD	The condition is caused by trying to stop recording when perform the schedule record. Please setup the record to manual mode and then stop the record.	
PLEASE SELECT ONE CAMERA	The message will be shown while using the ZOOM function under split screen condition. Please switch the screen into full screen mode and then operate the ZOOM function.	