

Safety Instructions

1. The S360 Spectral Spinner is designed for indoor use only.
2. DO NOT expose the product to a high humidity environment. It may damage the LED grow lights used with the product.
3. DO NOT cover or place objects over the S360 Spectral Spinner. It should not be contained within an airtight space.
4. The product is 1 m in diameter. Make sure there is enough space around the unit.
5. Make sure all wires are secure and do not interfere with working unit.
6. The power supplies should never but fixed above the hanging bars. They should always be secured below the hanging bars.

Mechanical Dimensions

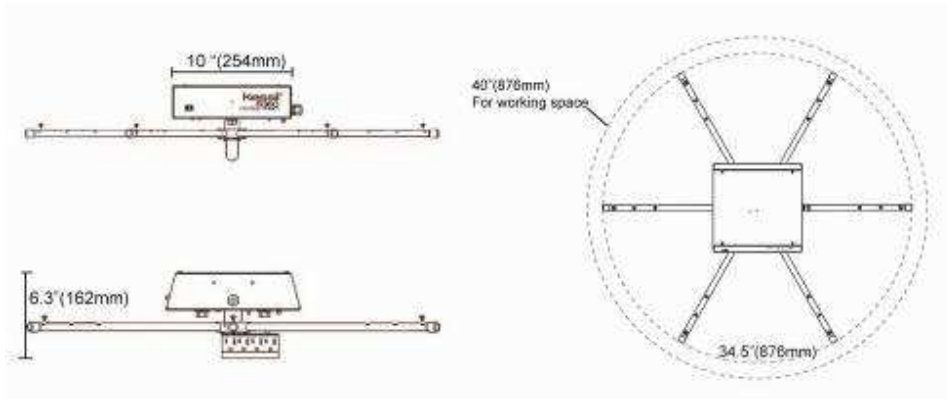

Thanks for changing it to inches! However, can you keep the mm numbers too? Put them in parentheses.

Required Tools



KESSIL S360 SPECTRAL SPINNER User Manual

Package Contents

- | | | | |
|------------------|------|------------------------|-------|
| a. Velcro Straps | (6x) | d. 6-Port Power Outlet | (1x) |
| b. Cable Tie | (2x) | e. Hanging Bar | (6x) |
| c. Triangle Hook | (2x) | f. Screw | (12x) |

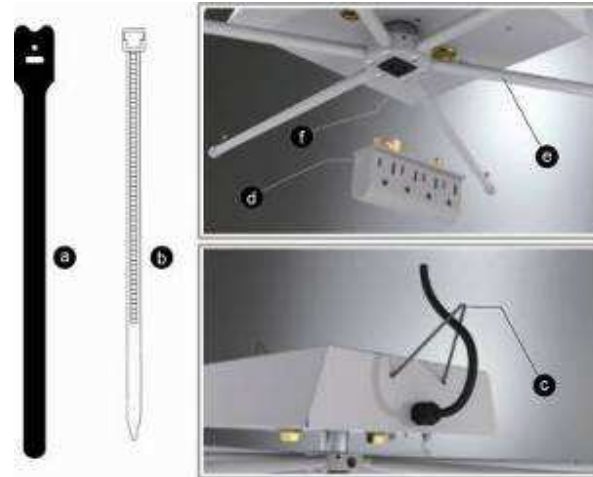

Installation Guide

1. Remove contents from package. Flip the body of the unit over.



2. Insert hanging bars (e) into designated slots and screw them in.

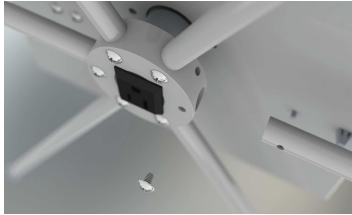

3. Insert 6-port power outlet (d) into the center of the body.

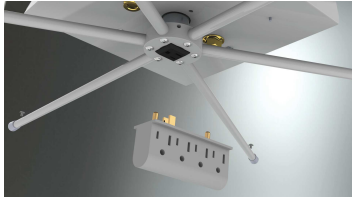

4. Turn the entire unit back over.

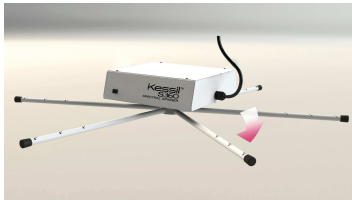

5. Loop triangle hooks (c) through the holes at the ends of the unit.

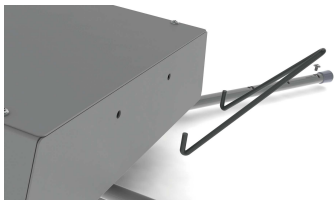

6. Take out your Kessil grow lights. Secure power supplies with the black Velcro straps (a) provided.

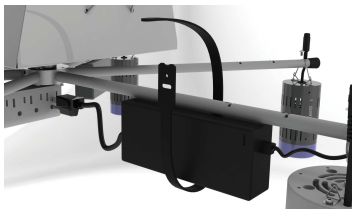

7. Plug the power supplies into the outlet (d).

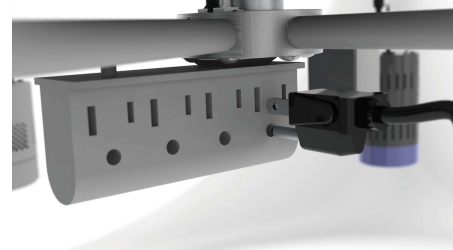

8. Secure the lights to the ends of the hanging bars (e).

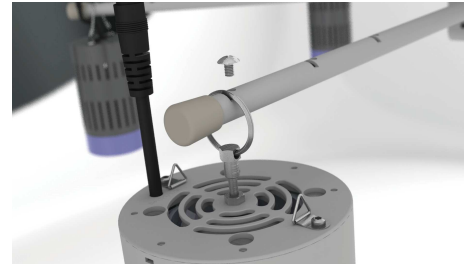

9. Plug in the unit to turn on.

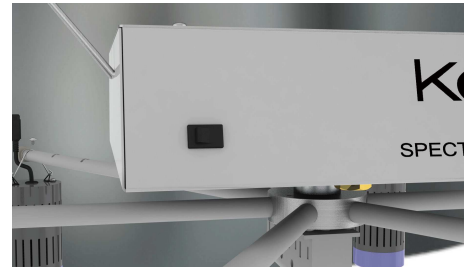

Kessil Lighting

1689 Regatta Blvd

Richmond, CA 94804

www.kessil.com

Copyright © 2011 All Rights Reserved