

AEM33 485 DIN

INSTRUCTIONS

1 SAFETY

This instrument is manufactured in compliance with EN61010-1 Cat III for nominal operating voltages of 400V L-L and 230V L-N, to ensure safe operation the user must comply with the following instructions:

- Ensure that the supply voltage is correct.
- The auxiliary mains supply is internally fused at 250V, 100mA Type 2. External fusing is required if the auxiliary supply voltage exceeds 250V.
- Maintenance and/or repairs must be carried out only by qualified, authorised personnel.
- If there is ever the suspicion that safe use is no longer possible, the instrument must be disconnected and precautions must be taken against accidental use.
- Operation is no longer safe:
 - 1) If there is clearly visible damage
 - 2) If the instrument no longer functions
 - 3) After prolonged storage in unsuitable conditions.

1.1 OPERATOR SAFETY

Read these instructions carefully before installing and utilising the instrument.
The instrument described in this user manual is intended for use by properly trained staff only. Maintenance and/or repairs must be carried out by authorised personnel only. For proper, safe use of the instrument and for maintenance and/or repair, it is essential that the persons instructed to carry out these procedures follow normal safety precautions.

2 SYMBOLS

CAUTION: Failure to follow the instructions may result in personal injury or damage to equipment.

NOTE: Failure to follow the instructions may result in an instrument malfunction.

3 CONNECTION DIAGRAMS

Standard Connections

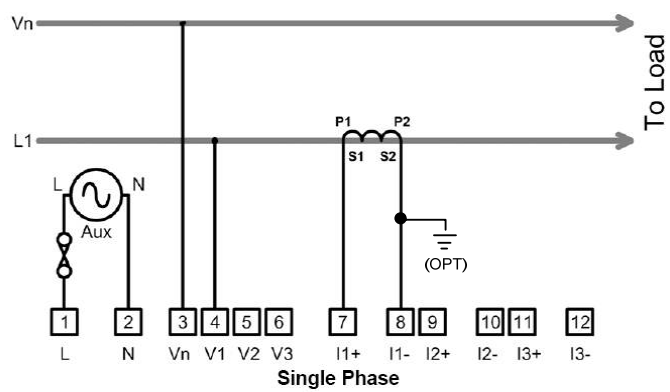
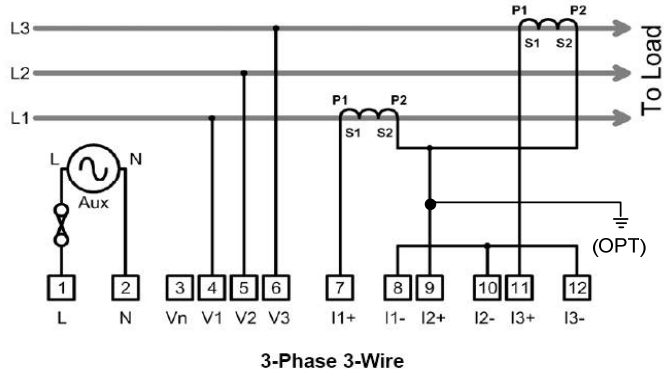
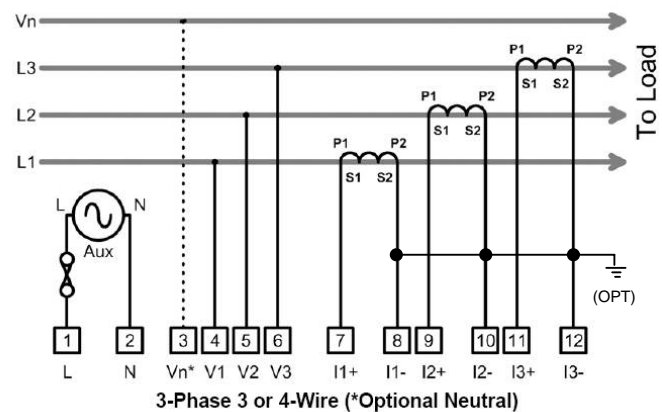

CAUTION: The instrument is internally fused at 250V 100mA. External fusing is required if the supply voltage exceeds 250V.

3.1 CONNECTION OF THE CURRENT INPUT

The AEM33 is suitable for use with current transformers (CTs) with 5A secondary output. Metering quality CTs of Class 1 accuracy with a minimum rating of 2.5VA are recommended.

Connections should be made according to the diagrams above.

3.2 PULSE OUTPUT CONNECTIONS



CAUTION:

The pulse output contacts are rated at 100mA AC/DC, 100V max. Under no circumstances should this rating be exceeded.

The AEM33 is fitted with dual pulse outputs. Output 1 provides a pulse proportional to kWh, output 2 provides a pulse proportional to kVArh. Each output has a telltale l.e.d. on the front panel which flashes 'on' to indicate a pulse being generated.

The pulse connections are as follows:

Pulse 1: Terminals 31 & 32

Pulse 2: Terminals 29 & 30

The contacts are volt free and therefore an external power supply must be provided.

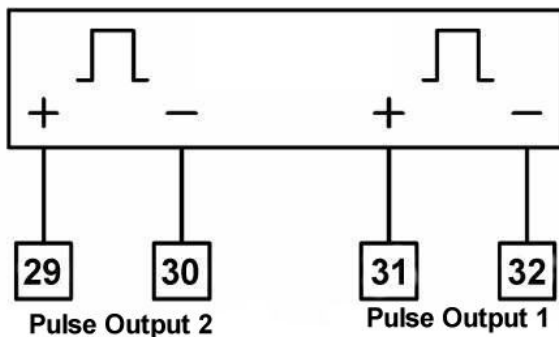

PULSE OUTPUT CONNECTIONS

3.3 RS485 CONNECTIONS

The RS485 output consists of 3 terminals (15, 16 & 17) at the top left of the unit. These should be connected via the correct specification cable to the data bus. (Refer to Elcomponent for cable recommendations.) Terminal connections are as follows:

15 = A 16 = B 17 = 0 V (A&B are signal cables.)

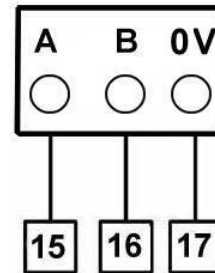

NOTE: It is essential that the polarity is respected when other units are connected to the bus.

4 INSTRUMENT OPERATION & SET-UP

When the instrument is powered up, the display will initially show the internal software version, then after a few seconds will start displaying measured values. The four buttons allow the user to scroll through the available measurements.

ENERGY DISPLAYS

Press  to select kWh, kVArh and Hours Run display pages.



Active Energy Register





Reactive Energy Register



Hours Run

The Hours Run register accumulates the total time during which the average 3 phase load current exceeds a preset level. This is always displayed with a resolution 0.1 hour. The percentage level of (I1+I2+I3) at which the Hours Run register accumulates is user programmable from 1% to 100% of full scale current.

Press  and  together and hold for 2 seconds to reset the hours run register.

VOLTAGE DISPLAYS

Press  to select from the following displays:



P1 230.0 V

Phase-n Voltages 1 - 3



L1 400.0 V

Line-Line Voltages 1 - 3

CURRENT DISPLAYS

Press  to select the following display



P1 200.0 A

Phase 1 - 3 Current

POWER DISPLAYS

Press  to select from the following displays:

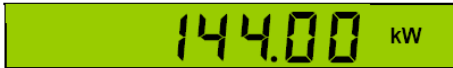

144.00 kW

System Active Power



PFC 1.00

System Power Factor (C=Capacitive)



F 50.0

Frequency, Hz (Phase 1 voltage)



P1 48.00 kW

Phase 1-3 Active Power



PFC 1.00

Phase 1-3 Power Factor (C=Capacitive)





NOTE: The values for phase power factor may be used to verify correct CT position & orientation.





INSTRUMENT SET-UP

The display shows the CT set-up screen. The instrument settings are entered from this point, starting with the CT values.

CT SET-UP

To enter programming mode press  and  simultaneously for 5 seconds. The CT primary value may then be set from the following nominal values (secondary value must be 5A):



5, 10, 15, 20, 30, 40, 50, 60, 80, 100, 150, 200, 250, 300, 400, 500, 600, 800, 1000, 1200, 1250, 1500, 1600, 2000, 2400, 3000, 2500, 4000, 4500, 5000, 5500, 6000, 6500, 7000, 7500, 8000, 8500, 9000, 9500, 10000, 10500, 11000, 11500, 12000, 12500, 13000, 13500, 14000, 14500, 15000, 15500, 16000, 16500, 17000, 17500, 18000, 18500, 19000, 19500, 2000, 205000, 21000, 21500, 22500, 23000, 23500, 24000, 24500, 25000

Press the  or  key until the desired current is displayed. If the desired CT value is not present in the above list, the ratio may be 'fine adjusted' as follows: Press and hold the  and  buttons simultaneously for 2 seconds to enter 'Fine Adjust Mode'. This is indicated by a decimal point displayed immediately to the right of the defined parameter viz: "Ct." this enables the CT primary value to be changed in 10A steps until the desired ratio is displayed. Press the  key to store the value and advance the page.



VT SET-UP

The default voltage setting is 400V and this value should not be altered.



PULSE SET-UP

The pulse rate value (PLr) may be set between 0.1 and 100 pulses per unit. Press the  or  key until the desired pulse is displayed. Note that the unit of energy (Wh/kWh/MWh) will automatically change to reflect the primary values of CT & VT previously set. The pulse value is set for both outputs during the process. Press the  key to store the value and advance the page.

The pulse duration value (PLt) may be set in increments between 100mS & 20 seconds as required.

The Pulse Output Test (Pto) allows the meter pulse output and connected data collection hardware to be tested, regardless of whether an actual load is present. Press the  button to start the test. The display will show "Ptr" and both outputs will pulse simultaneously. This is verified by the front panel i.e.d.s. Press the  and  together to stop the test and reset the test counter.

HOURS RUN SET-UP

The hours run preset level may be set between 1% and 100% of the full scale current. Press the  or  key until the desired value is displayed. Press the  key to store the value and advance the page.

RS485 SET-UP

This allows the baud rate and MODBUS address to be set. Use the ▲ and ▼ buttons to set the desired baud rate. Press the ◀ key to store the value and advance the page.

Use the ▲ and ▼ buttons to set the unit address. Press the ◀ key to store the value and save and exit from the set-up menu. The display will show 'storing' to confirm this action.

5 TECHNICAL CHARACTERISTICS

Connection: 3 Phase 3 or 4 wire Unbalanced, 3 Phase Balanced, Single Phase Load.

Inputs: Voltage: 400/230V 3 Phase 3/4 wire
Current: 5A – External CTs. Fully isolated.

Burden: <0.1VA per phase Current/Voltage

Pulse Output: Opto isolated volt free contact
Rating: 100mA ac/dc, 100V ac/dc max
Value: 1 pulse per kWh
1 pulse per 10 kWh
1 pulse per 100 kWh
1 pulse per 1000 kWh
Duration: 100ms
Isolation: 2.5kV for 1 minute

Power Supply: 230V 50/60Hz +/- 15%

Overload: Voltage x 4 for 1 hour
Current x 40 for 0.5 seconds max

Consumption: 2VA

Weight: 325g

IP Rating: Instrument = IP20 Front panel = IP40

Temp Range: -10° - +65°

Dims: 106w x 58d x 90h mm (6 DIN)



NOTE: Do not expose the instrument display to direct sunlight.

ELCOMPONENT
Making sense of your energy 

Unit 5 Southmill Trading Centre, Southmill Road, Bishop's Stortford, Herts. CM23 3DY.

01279 503173 sales@elcomponent.co.uk

www.elcomponent.co.uk