

User Manual

FreeStyl 1 Single Line Long Range Cordless Telephone



EnGenius Customer Service
U. S.: 1-888-735-7888, <http://www.ingeniustech.com/>
Canada: 1-888-397-2788, <http://www.ingeniuscanada.com/>

Table of Contents

Safety Instructions	4
General Safety Instructions	4
Product Safety Instructions	4
Battery Safety Instructions	6
Regulatory Information	7
Equipment Checklist	10
Handset Illustration	11
Handset Features	12
Basic Handset Features	12
Additional Handset Features	14
Base Illustration	20
Base Features	21
Basic Base Station Features	21
Charger Illustration	23
Charger Features	24
Getting Started	25
Base Station Installation	25
Handset and Charger Installation	26
Basic Operations	27
Operation Modes	27
A. Base Operation Modes	27
B. Handset Operation Modes	27
Making a Telephone Call	29
Making an 2-Way/ Intercom Call	30
A. Handset to Handset Calls	30
B. Intercom/2-Way from Base to Handset	30
C. Intercom/2-Way from Handset to Base	31
Making a Broadcast	31
A. Handset to Handset Calls	31
B. Broadcasting from Base to Handset	32
C. Broadcasting from Handset to Base	32
Redial	33
Receiving a Telephone Call	33
Receiving an Intercom Call	34

Ending a Call.....	35
Adjusting Handset Receiver (Earpiece) Voice Volume	35
Adjusting Handset Speakerphone Voice Volume.....	35
Adjusting Base Speakerphone Voice Volume.....	35
Placing a Call On Hold.....	36
Mute.....	36
Do Not Disturb (Silent Ring).....	37
Key Guard.....	37
Battery Recharge and Replacement.....	37
Advanced Operations.....	39
Handset Registration.....	39
Handset Group Subscription.....	40
Call Transfer.....	41
Phonebook Operations.....	42
Call Barring.....	46
Programmable Feature Call.....	48
Caller ID.....	49
Base Speed Dial Setting.....	51
Base Ringer Setting.....	52
Visual Message Waiting Indicator (VMWI).....	52
Adjust Handset Microphone Gain.....	52
Adjust Headset Ring.....	53
Baby Monitor.....	53
Part 68 Statement.....	59
Index.....	61
Technical Specifications.....	65

Safety Instructions

Caution: *Your wireless telephone gives you freedom and flexibility to stay in touch while you move around. However, when using your phone equipment, safety instructions should be followed to avoid the risks of fire, electric shock, injury to person, and damage to property.*

General Safety Instructions

1. When using your wireless phone, ensure your safety and the safety of others:
 - a. Always watch where you are walking and standing.
 - b. Don't let a phone call distract you from working safely.
 - c. If power goes out, it won't work. Recommend backup power.
2. In an emergency:
 - a. If an emergency occurs, dial the emergency phone number. Remember: if you are in an area where your phone does not have a clear signal from the base, it is highly probable that the call may not go through. Locate the nearest landline telephone or other communications device to call for help.
 - b. Emergency calls may not automatically provide emergency personnel with your name, phone number or location.
3. Notice to Hearing Aid Users: This phone system is compatible with inductively coupled hearing aids.
4. Notice to Cardiac Pacemaker Users: Preliminary studies done by the US FDA and others have shown that, although interference to the implanted cardiac pacemaker may occur when operating very closely, wireless telephones "do not seem to pose a significant problem for pacemaker wearers." However, until more is known, FDA suggests that people with pacemakers may want to take precautions when using or carrying a wireless telephone to ensure that there is ample distance between the telephone and the pacemaker. Do not carry the handset in a breast pocket. If you have any reason to suspect that interference is taking place, turn off your handset immediately.

Product Safety Instructions

1. Read and understand all instructions.
2. Follow all warnings and instructions including those marked on the product.

3. Changes or modifications to this product not expressly approved by the manufacturer will void the warranty and the FCC authorization to operate the equipment. Use only manufacturer provided accessories.
4. Do not use the telephone near water. Never spill liquid of any kind on this product.
5. Unplug the product from the wall telephone jack and power outlet before cleaning. Do not use liquid or aerosol cleaners. Use damp cloth for cleaning.
6. Do not place this product on an unstable cart, stand, or table. The product may fall and cause personal injury or damage to the product or other property.
7. Power Outage: In the event of a power outage, your handset charger will not recharge the handset battery, and the base station will not allow you to make an outgoing call or take an incoming call. Both the charger and the base station require electricity for operation. You should have a telephone that does not require electricity available for use during power outage, or have a temporary backup power supply.
8. Slots or openings in the product's housing are provided for ventilation. These openings must not be blocked or covered. Placing the product on a bed, carpeting, or other similar surface may block these openings and should be avoided. This product should never be placed near or over a radiator or heat register, or in a built-in installation unless proper ventilation is provided.
9. Never push objects of any kind into this product through housing slots/openings as they may damage the product, touch dangerous voltage points or short out parts that could result in fire, electric shock, or injury.
10. This product should be operated only from the type of power source indicated on the marking label. If you are not sure of the type of power supply to your home, consult your dealer or local power company.
11. Do not overload wall power outlets and extension cords as this may result in fire or electric shock.
12. To avoid electric shock or burn, do not disassemble this product. Send this product to an authorized service center when service or repair work is required. Call Customer Service for locations near you. Opening or removing covers may expose you to dangerous voltages, electrical currents or other risks. Incorrect reassembling of the product may cause electric shock when the product is subsequently used.
13. Avoid using the product during a storm. There may be a risk of electric shock from lightning.
14. Do not place the product where persons can step, trip, or fall on it.

15. Do not place conductive objects over or near the antenna.
16. Do not use the product to report a gas leak while in the vicinity of the leak.
17. Do not install the base station or the handset charger near microwave ovens, radios, TV sets, speakers, or other electrical equipment. These appliances may cause interference to the product or experience interference from the product.
18. Unplug the base station or the charger adaptor from the power outlet and refer to an authorized service center under the following conditions:
 - a. If liquid has been spilled into the product.
 - b. When the power supply cord or plug is damaged or frayed.
 - c. If the product has been exposed to rain or water.
 - d. If the product does not operate normally by following the operating instructions.
 - e. If the product has been dropped or housing has been damaged.
 - f. If the product shows a distinct change in performance.

Battery Safety Instructions

1. Use only manufacturer approved Li-ion rechargeable batteries and charger. Do not use other types of rechargeable batteries or non-rechargeable batteries. The batteries could short-circuit, and the battery enclosure may be damaged causing a hazardous condition.
2. Follow the charging instruction in this manual and instruction labels and markings in the handset and charger compartments.
3. Battery must be recycled or disposed of properly. Do not dispose the battery in a fire. The cells may explode.
4. Do not dispose of the battery in municipal waste. Check with local codes for disposal instructions.
5. Exercise care in handling the batteries in order not to short-circuit the battery with conductive materials such as rings, bracelets, keys, pocketknife, and coins. The battery or conductive material may overheat and cause burn or fire.
6. Do not expose batteries to rain or water.
7. Do not open or mutilate the battery. Released electrolyte is corrosive and may cause injury to eyes or skin. The electrolyte may be toxic if swallowed.
8. During charging, the battery heats up. This is normal and is not dangerous.

Regulatory Information

FreeStyl 1

FCC ID : U2M-FS1

IC : 3616C-FS1

This device complies with Part 15 of the FCC Rules. Operation is subject to the following two conditions:

- 1) this device may not cause harmful interference, and
- 2) this device must accept any interference received, including interference that may cause undesired operation.

Base Station

Federal Communication Commission Interference Statement

This equipment has been tested and found to comply with the limits for a Class B digital device, pursuant to Part 15 of the FCC Rules. These limits are designed to provide reasonable protection against harmful interference in a residential installation. This equipment generates uses and can radiate radio frequency energy and, if not installed and used in accordance with the instructions, may cause harmful interference to radio communications. However, there is no guarantee that interference will not occur in a particular installation. If this equipment does cause harmful interference to radio or television reception, which can be determined by turning the equipment off and on, the user is encouraged to try to correct the interference by one of the following measures:

- Reorient or relocate the receiving antenna.
- Increase the separation between the equipment and receiver.
- Connect the equipment into an outlet on a circuit different from that to which the receiver is connected.
- Consult the dealer or an experienced radio/TV technician for help.

FCC Caution: Any changes or modifications not expressly approved by the party responsible for compliance could void the user's authority to operate this equipment.

This device complies with Part 15 of the FCC Rules. Operation is subject to the following two conditions: (1) This device may not cause harmful interference, and (2) this device must accept any interference received, including interference that may cause undesired operation.

IMPORTANT NOTE:

FCC Radiation Exposure Statement:

This equipment complies with FCC radiation exposure limits set forth for an uncontrolled environment. This equipment should be installed and operated with minimum distance 20cm between the radiator & your body.

This transmitter must not be co-located or operating in conjunction with any other antenna or transmitter.

Industry Canada statement:

This device complies with RSS-210 of the Industry Canada Rules. Operation is subject to the following two conditions:

(1) This device may not cause harmful interference, and (2) this device must accept any interference received, including interference that may cause undesired operation.

IMPORTANT NOTE:

Radiation Exposure Statement:

This equipment complies with IC radiation exposure limits set forth for an uncontrolled environment. This equipment should be installed and operated with minimum distance 20cm between the radiator & your body.

This device has been designed to operate with an antenna having a maximum gain of 2 dBi. Antenna having a higher gain is strictly prohibited per regulations of Industry Canada. The required antenna impedance is 50 ohms.

Portable Handset

Federal Communication Commission Interference Statement

This equipment has been tested and found to comply with the limits for a Class B digital device, pursuant to Part 15 of the FCC Rules. These limits are designed to provide reasonable protection against harmful interference in a residential installation. This equipment generates, uses and can radiate radio frequency energy and, if not installed and used in accordance with the instructions, may cause harmful interference to radio communications. However, there is no guarantee that interference will not occur in a particular installation. If this equipment does cause harmful interference to radio or television reception, which can be determined by turning the equipment off and on, the user is encouraged to try to correct the interference by one of the following measures:

- Reorient or relocate the receiving antenna.
- Increase the separation between the equipment and receiver.

- Connect the equipment into an outlet on a circuit different from that to which the receiver is connected.
- Consult the dealer or an experienced radio/TV technician for help.

FCC Caution: Any changes or modifications not expressly approved by the party responsible for compliance could void the user's authority to operate this equipment.

This device complies with Part 15 of the FCC Rules. Operation is subject to the following two conditions: (1) This device may not cause harmful interference, and (2) this device must accept any interference received, including interference that may cause undesired operation.

IMPORTANT NOTE:

Radiation Exposure Statement:

This equipment complies with FCC radiation exposure limits set forth for an uncontrolled environment. End users must follow the specific operating instructions for satisfying RF exposure compliance. To maintain compliance with FCC RF exposure compliance requirements, please follow operation instruction as documented in this manual.

This transmitter must not be co-located or operating in conjunction with any other antenna or transmitter.

Industry Canada statement:

This device complies with RSS-210 of the Industry Canada Rules. Operation is subject to the following two conditions: (1) This device may not cause harmful interference, and (2) this device must accept any interference received, including interference that may cause undesired operation.

IMPORTANT NOTE:

Radiation Exposure Statement:

This equipment complies with IC radiation exposure limits set forth for an uncontrolled environment. End users must follow the specific operating instructions for satisfying RF exposure compliance. To maintain compliance with IC RF exposure compliance requirements, please follow operation instruction as documented in this manual.

This device has been designed to operate with an antenna having a maximum gain of 2.5dBi. Antenna having a higher gain is strictly prohibited per regulations of Industry Canada. The required antenna impedance is 50 ohms.

Equipment Checklist

1. In a Base + Handset package, please find the following components:
 - a. Base Station x 1
 - b. Base Antenna x 1
 - c. Base AC/DC Adaptor x 1
 - d. Handset x 1
 - e. Handset Antenna (Short) x 1
 - f. 1100mA Li-ion Battery Pack x 1
 - g. Telephone Cord x 1
 - h. User's Manual, Quick Guide, and Warranty Card

2. In a Handset package, please find the following components:
 - a. Handset x 1
 - b. Handset Antenna (Short) x 1
 - c. 1100mA Li-ion Battery Pack x 1
 - d. Charger x 1
 - e. Charger AC/DC Adaptor x 1
 - f. Quick Guide, and Warranty Card

3. Optional Accessory
 - a. Spare Battery x 1700mA Li-ion
 - b. Spare Battery x 1100mA Li-ion
 - c. External Antenna
 - c-1. 10 meters COAX
 - c-2. 20 meters COAX
 - d. Pouch
 - e. Handset Antenna (Long)

Handset Illustration

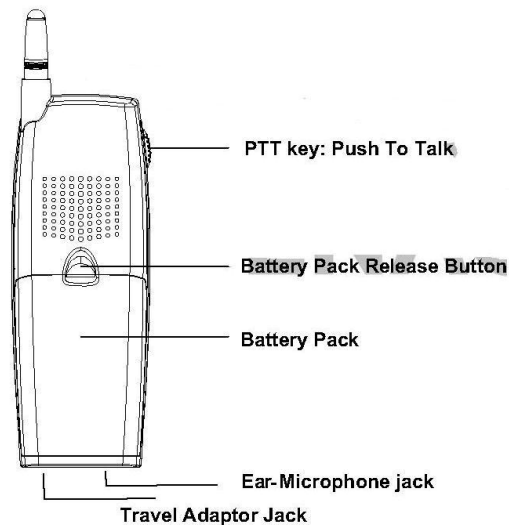
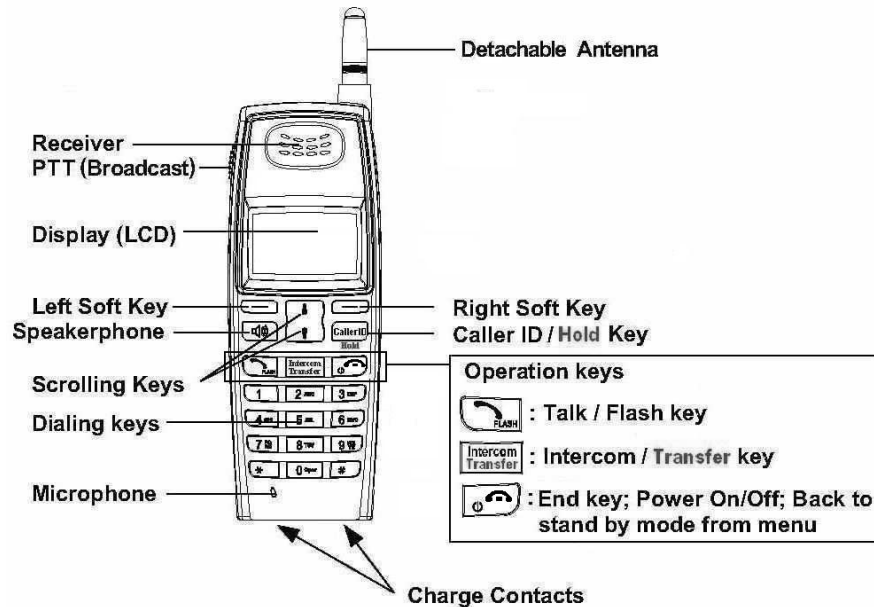

Handset Features



Basic Handset Features



1. 4-line LCD (Liquid Crystal Display)
 - a. The LCD display has LED (Light Emitting Diode) for backlighting.
 - b. The 1st line of LCD consists of icons.
 - c. Icons explanation from left to right



(1)(2)(3)	(4)(5)(6)(7)
FreeStyl 1	
REDIAL	MENU





 - (1) **RSSI** (Receive Signal Strength Indicator)
During a call, the number of bars is proportional to the radio signal strength received.
 - (2) **Link mode**
 - (2.1) **Call in-progress** (ON/OFF-Hook)
Indicates which the phone line of Base is active.
 - (2.2) **Intercom in-progress**
Indicates if Intercom mode is active
Indicate the Handset ID which is making intercom with.
 - (3) **Speech mode**
 - (3.1) **Speaker Indicator**
Indicate if the speaker is active
 - (3.2) **Headset mode**
 - (4) **Sound and Indication**
 - (4.1) **Enable ringer**
 - (4.2) **Disable ringer**
 - (4.3) **Ringer and vibrate mode**
 - (4.4) **Vibrate mode**
 - (4.5) **Message waiting indicator**
 - (5) **Disable PA**
Indicate if the speaker is disable
 - (6) **Two-Digit Address Index**
11 Displays the 2-digit Handset ID.
 - (7) **Battery Strength**
Number of bars is proportional to the amount of battery time remaining.
 - d. The 2nd and 3rd lines of the LCD, maximum 16 characters each, display status, message, menu selections, or user-editable alphanumerical characters.
 - e. The last line displays the left and right soft keys.
2. Ringer
 - a. Rings to an incoming call and intercom call.
 - b. Distinctive alert sounds indicating various events:

- (1) Single beep: successful key entry
 - (2) Double beep: indicates power on/off
 - (3) Triple beep: failed operation
 - (4) Periodic 1-Long-2-Short beep (every 1 minute): low battery warning · out of range · call on hold
 - (5) Periodic Long Series of beeps (repeat every 30 seconds): indicates confirmation for saving success
- Re: No any beep for invalid key entry

3. TALK/FLASH ()
 - a. Places or answers a telephone or intercom call
 - b. Sends a Flash signal to phone line to retrieve a dial tone after the call ends, or to perform the call waiting feature provided by local phone companies during a call.
4. SPEAKERPHONE ()

Press the key to enable/disable the speakerphone during incoming, outgoing or intercom call.
5. 2-WAY INTERCOM / TRANSFER ()
 - a. Places an intercom call to another handset, a group handset (group paging) or all registered handsets.
 - b. Intercom calls are digital, full duplex, and are conducted without the assistance from the base.
6. BROADCAST ()
 - a. Half duplex broadcasting to handsets for immediate announcement.
 - b. Half duplex broadcasting to base station.

Re : Press the  key on the side of handset to activate the broadcast function.
7. Left/Right Soft Keys ()

Make menu selection.
8. Up() /Down() Scrolling Keys
 - a. Scroll through records and menu selections.
 - b. Adjust receiver voice volume when in the Talk mode.
 - c. Press  to adjust ringer volume when in the Standby mode.
 - d. Press  to enter phonebook when in the Standby mode.
9. END; On/Off Key ()

- a. Ends a call.
- b. Leaves current menu operation, up one level.
- c. Press for 3 seconds to off the power

10. CALLER ID Key ()
 - a. Review caller ID list.
 - b. Including received and missed caller ID.

Additional Handset Features

1. Multiple handsets registration
 - a. Up to 9 handsets can be registered to a base station
 - b. ID 11-19: individual Handset IDs.
 - c. ID 91-99: Group IDs. Handsets can “subscribe” from the handset menu to group(s) and be paged when a landline caller or an intercom caller enters a Group ID.
2. Ringer Vibrator
 - a. Two options for Line (incoming call) ringing & Intercom ringing.
 - b. Six-level ringer volume selections (Off/Low/Medium/High/Vibrate/Vibrate & High) for each option.
 - c. Eight ringer type selections for each option.
3. Caller ID



Displays incoming call phone number and name on the LCD (needs Caller ID service from local telephone company)
4. Call waiting with caller ID

Displays 2nd incoming call information on the same phone line when 1st call is in progress (needs Call Waiting with Caller ID service from local telephone company)
5. Name tagging with caller ID

Match the caller ID with the phone book entries; once matched, the LCD screen will display the name or nickname instead of pure caller ID info (needs Call Waiting with Caller ID service from local telephone company)
6. DND (Do Not Disturb, i.e., Silent Ring)
7. Call Logs

- a. Redial: Stores 10 phone numbers (up to 26 digits each) dialed most recently. Can perform last-number redial on all 10 numbers.
 - b. Received & New Call Log: Total 50 entries (16-digit phone number, 16-character names, and Date/Time stamp), needs Caller ID service from local telephone company.
 - c. Phone numbers and names can be saved into phonebook while in display.
8. Call Barring: block outgoing call and incoming call.
- a. Outgoing call:
 - a-1. Block the users from dialing long distance calls or international calls
 - a-2. Up to 5 digits of each call barring setting; up to 5 entries allowed.
 - a-3. If you need to dial a specific number to retrieve the dial tone, you need to key in that number while setting the call barring
 - b. Incoming call:
 - b-1. PA On/Off: Enable or disable the broadcast from other handsets or base. When PA is Off, the handset can't receive broadcast from base or other registered handsets, but it can broadcast to base or other registered handsets.
 - b-2. Line On/Off: Enable or disable the capability to receive incoming call from telephone line. When Line is Off, the handset can't receive incoming call from telephone line, but it can still make outgoing call.
 - b-3. Int. On/Off: Enable or disable the intercom from other handsets or base. When Int. is Off, the handset can't receive intercom from base or other registered handsets, but it can intercom to base or other registered handsets.
 - c. This changing requires to entering the "Call Settings" (**MENU**-4-3). [Note] you need to key in the accurate user ID and password to perform this feature. The default password is "0000"
9. Any Key Answer (except  and **SILENT** Soft Key)
10. Key-guard
- a. When the keyguard is selected, all keys will be locked. Press **UNLOCK** (Left) soft key followed by "*" to release it.
 - b. The keyguard will be automatically enabled once returning back to idle mode for 15 seconds.
11. Dialing Prefix

Up to 14 digits, including pause(s), one access code can be pre-programmed to be added automatically in front of the dialed number when dialing from call logs, phonebook, and dial-and-send dialing.

12. Call Hold
- a. Places call on hold from handset or base.
 - b. Battery Hot Swap: Change battery while call is on hold (call hold on handset).
13. Mute
- a. Press **MUTE** (Left) soft key (handset) during talk, the handset microphone will be muted. Press **UNMUTE** (Left) soft key (handset) to release it.
 - b. Press  during talk, the base microphone will be muted. Press  again to release it.
14. Phonebook
- a. 50 entries, each stores a phone number or handset ID (up to 26 digits) and name (up to 16 characters)
 - b. Alphabetically sorted display and search
 - c. Dial from display
 - d. During the stand-by mode, you can enter the phone book by pressing  scrolling key
 - e. Phone book transfer via air
 - i. Transfer specific phonebook to one handset or all registered handsets
 - ii. Transfer all phonebooks to one handset or all registered handsets
15. Key tone
- a. Four-level key tone volume selections (Off/Low/Medium/High)
 - b. Four key tone type selections
16. Call Timers
- Display call time duration for current call during and immediately after the call
17. Programmable Feature Call
- a. Allow user to pre-program the most frequently used Feature code into FreeStyl 1 which is adjunct to the PBX system.
 - b. Up to 10 entries can be saved.
 - c. Once the feature code is being programmed, you can quickly

perform those functions during the call by pressing **OPTION** soft key.

18. PA On/Off
 - a. Enable or disable the broadcast function.
 - b. When PA is Off, the handset can't receive broadcast from base or other registered handsets; But it can broadcast to base or other registered handsets.
19. Menu Display
 - a. To avoid mis-setup in the "Call Settings" (**MENU-4**), "Phone Settings" (**MENU-5**) and "Base Settings" (**MENU-6**), these settings can be hidden.
 - b. Password is required before enter Menu Display (**MENU-8**), the default password is "0000".
 - c. When enabling the settings, these setting will not displayed any longer, unless disabled by entering Menu Display again.
20. Group Setting

Allow handset to subscribe to one or several groups.
Re: Up to 9 groups can be subscribed.
21. Custom Name

Allow changing the "Welcome" screen to the desired wording or info, such as the user's name.
Re: Up to 32 characters can be entered.
22. Change Pwd

Allow changing the handset password which requires to enter in Call Barring (**MENU-4-4**) and Menu Display (**MENU-8**).
Re:Default is "0000".
23. Change PIN

Allow changing the Base PIN which requires to enter in Base Settings (**MENU-6**).
Re: Default is "0000".
24. DTMF Duration
 - a. From **MENU-6-1** to select variable duration of DTMF tone.
 - b. Default is 100ms.
 - c. When entering the base setting, PIN is required. Default is "0000".

Re: Better to check with your phone company first before changing it.

25. Programmable Flash key timing
 - a. From **MENU-6-2** to select flash key timing
 - b. 9-level (100 ms - 900 ms) timing selections, default= 600 ms.
 - c. The default value (600 ms) works in most areas. Changing this setting may cause Flash key to stop working. Change only when you are certain the new value will work.
 - d. When entering the base setting, PIN is required. Default is "0000".
26. Assign handset ID for new handset
 - a. Using registered handset from **MENU-6-3** to assign a handset ID to a new handset.
 - b. If not assigned handset ID, the system will automatically assign a handset ID to a new handset.
 - c. When entering the base setting, PIN is required. Default is "0000".
27. Clear Handset
 - a. Use registered handset from **MENU-6-4** to remove the other registered handset, in case the other registered handset is defective.
 - b. Once the other registered handset is cleared, the user is able to register a new handset for instead.
 - c. When entering the base setting, PIN is required. Default is "0000".
28. Change PIN

Allow changing the base PIN which requires entering the "Base Settings" (**MENU-6-5**).

 - a. Use registered handset to change PIN from **MENU-6-5**.
 - b. Default PIN is "0000".
 - c. When entering the base setting, PIN is required. Default is "0000".
29. Auto Hang Up feature
 - a. Using registered handset from **MENU-6-6** to turn on/off the Auto hang up feature.
 - b. If turning on the feature, the handset will automatically hang up the call when the other-end hangs up the call.
 - c. When entering the base setting, PIN is required. Default is "0000".
30. Set Time

The set time function allows user to set date/time to support the DTMF caller ID (DTMF caller ID doesn't attach date/time when receiving from PSTN, using this setting, user is able to review the date/time when the caller ID is received).

 - a. Enter **MENU-6** to set Base Settings.

- b. Enter Base PIN (Default is "0000").
- c. Enter "7" to enter Set Time.
- d. Enter 4 digits for MM/DD(Month/Day), then enter 4 digits for hr:mm (Hour : Minute)
- e. Press **SAVE** (left soft key) to finish the setting.

31. Mic Gain

Allow changing the handset microphone gain based on the handset in different environment – Quiet, Normal and Noisy environment. This requires entering the "Phone Settings" (**MENU-5-1**).

32. Headset Ring

Allow changing the ringer emitted either from handset speaker or receiver of headset. This requires entering the "Phone Settings" (**MENU-5-9**).

33. Baby Monitor

Allow setting the handset monitoring the baby room via intercom call. When setting Baby Monitor ON, this dedicated handset will not answer any incoming call, except the 2-way intercom. This requires entering the "Call Settings" (**MENU-4-5**).

Base Illustration

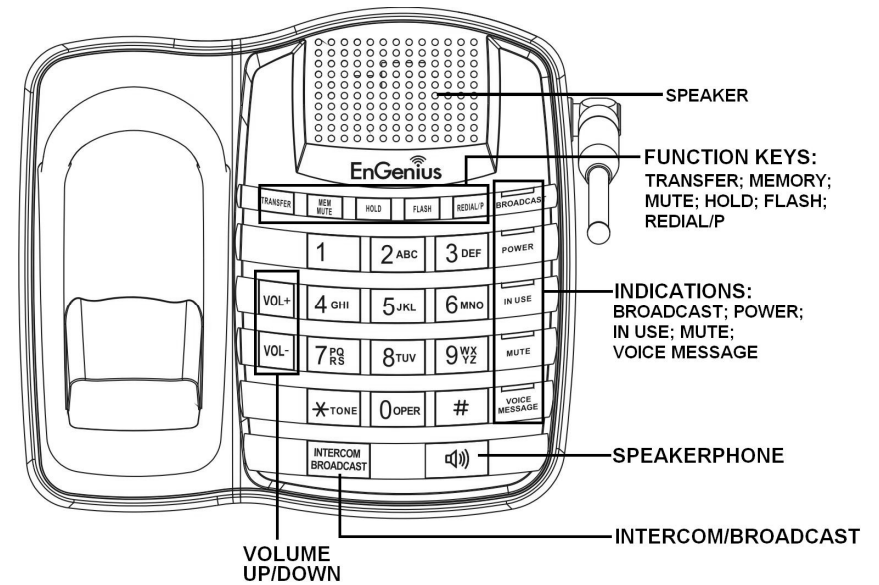

Base Unit Diagram

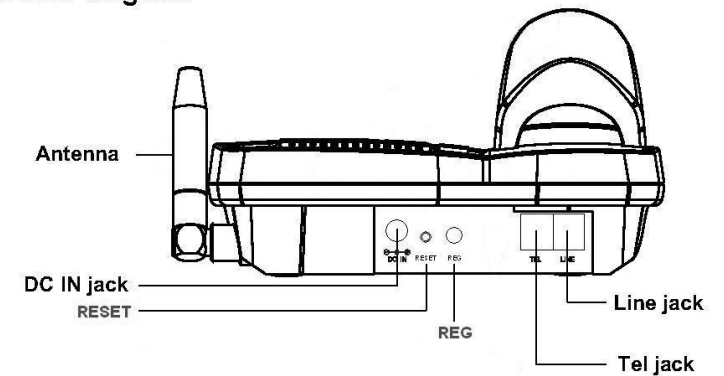

Base Features

Basic Base Station Features

1. Antenna
 - a. The antenna port has a **reverse thread connector**; to remove antenna or cable, turn clockwise; to install, turn counterclockwise. Improper installation may damage the connector
 - b. When using an outdoor antenna, locate the antenna (not the base station itself) as high as possible for a clear transmission path.
2. LED
 - a. Power: it indicates base station has power.
 - b. In-Use: it indicates an active telephone line.
 - c. Broadcast: it indicates "Broadcast" taking place.
 - d. Mute: it indicates "Mute" is active.
 - e. Voice Message: it indicates the voice message received.
3. RESET Button
 - a. Restores base station to factory settings
 - b. Reset button is intended to prevent accidental system reset.
 - c. All handsets (including administrator) need to be re-registered after a base station reset.
4. Registration Button (REG)
Enters registration mode along with handset, assigns handset ID (11-19).
5. Line Jack
Standard RJ-11C/CA-11A connector to plug in the telephone line
6. Telephone Jack
Another RJ-11C to plug in the optional answering machine
7. Dialing Keys
 - a. Enter the phone number after pressing the Speakerphone key.
 - b. Enter the handset ID or Group ID when making the intercom call or broadcast.
 - c. Enter the phone number when storing the base speed dial directory.
8. Function Keys
 - a. TRANSFER (TRANSFER): during talk, press the key to transfer the call to a registered handset.
9. VOLUME keys (VOL+ and VOL-)
 - a. Increase or decrease the ringer volume during standby mode.
 - b. Increase or decrease the voice volume during talk mode.
10. SPEAKERPHONE key (SPEAKERPHONE)
 - a. Press the key to get the dial tone, followed by phone number to make outgoing call.
 - b. Press the key again to hang up the call.
 - c. When enable the speakerphone, the backlight of the key will be turned on too.
11. INTERCOM/BROADCAST Key (INTERCOM/BROADCAST)
 - a. Enter handset ID then press the key to enable the 2-way intercom feature.
 - b. Enter handset ID then press the key for over one second to enable the broadcast feature.
 - c. Press the INTERCOM/BROADCAST Key without entering handset ID first, all registered handset will be enabled.
12. DC In: to plug in the power adaptor
- b. MEMORY (MEM/MUTE): store phone number into speed dial memory of base unit. Up to 20 entries.
- c. MUTE (MEM/MUTE): press the key to mute the microphone.
- d. HOLD (HOLD): press the key to put the call on hold.
- e. FLASH (FLASH): press the key to send a Flash signal to phone line to retrieve a dial tone after the call ends, or to perform the call waiting feature provided by local phone companies during a call.
- f. REDIAL/P (REDIAL/P): press the key to retrieve the last dialed number. Or store a pause time (1 second) while storing the speed dial memory.

Charger Illustration

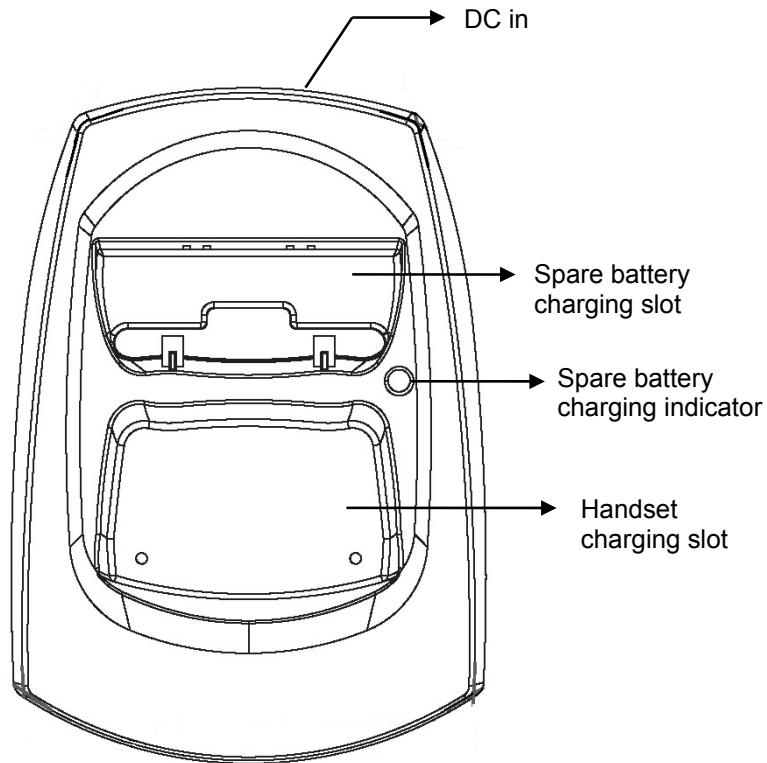

Charger Features

1. DC In
Connects to Charger AC Adaptor.
2. Handset Charging Slot
 - a. Charge handset battery when handset is placed in cradle.
 - b. Refer to the handset LCD for charging status
 - (1) Charging: battery status bar is running and the LCD screen would display: "Charging"
 - (2) Fully Charged: battery status bar stands still and the LCD screen would display "Fully Charged"
 - (3) Charge Fail: Should there be any error occurred during charging mode, the LCD screen would display "Charge Fail"
3. Spare Battery Charging Slot
 - a. Charge spare battery when battery is placed in slot.
 - b. LED as the spare battery charging indicator
 - (1) Slot is empty and the power is on: LED is off
 - (2) Battery is in charging: LED is Orange light
 - (3) Fully Charged: LED is off
4. It is impossible to overcharge the battery using this charger.
5. The adaptor for charging station can be used as travel charger as well. However, you can't turn off the power while you charge the handset via travel charger. A warning message "Unplug Travel Charger then OFF" will be shown on the LCD.

Notes:

1. Fully charge battery packs before first use.
2. Both handset and spare batteries can be charged at the same time.
3. Handset will be "power on" automatically when placing on the charging slot.
4. However, if you run drain the battery, it will take approximately one minute for handset to auto power on.

Getting Started

Base Station Installation

There are three possible base station setups:

- Base station alone
- Base station plus telephone answering device
- Base station plus standard telephone

For best performance, maintain at least a distance of 1 meter (about 3 feet) between the base station and other electronic devices (e.g., TV, computer, stereo, fax machine, answer machine, cordless phone, etc.)

1. Install base station antenna.
The base station's antenna port has a **reverse-thread connector**; to install antenna or cable, turn counter-clockwise; to remove, turn clockwise. Improper installation may damage the connector.
2. Plug the transformer end of the base station AC/DC adaptor into a standard AC electrical power outlet, plug the other end into the "DC In" jack on the back of the base station.
 - a. The base adaptor's DC plug is larger in dimension than the charger's DC plug. The charger adaptor's DC plug will not fit into the base's DC In jack.
 - b. The base station's power supply (DC Adaptor) and telephone line should be plugged into a surge protector with phone line protection.
3. Plug phone cord into the "LINE" Jack
4. A standard telephone or answering machine can be plugged into the adjacent receptacle on the bottom of the base station marked TEL

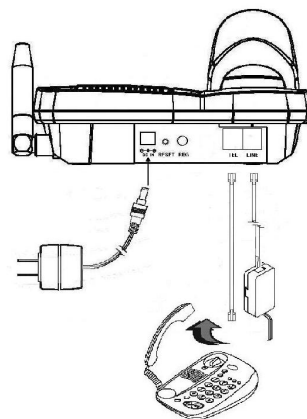

Handset and Charger Installation

1. Plug the transformer end of the Charger AC/DC adaptor into a standard AC electric power outlet, plug the other end into the "DC In" jack on the back of the Charger.
2. Install battery pack onto the handset (Press the battery harder, until hearing a "click" sound).
3. Install handset antenna.
4. Place handset onto the charger front slot.
5. Fully charge the battery for three hours before use.
6. The phone system is now ready to perform basic functions such as making and receiving phone calls and intercom calls. No base station or handset programming is needed for basic operations.

Note:

1. Handset(s) packaged along with a Base Station are pre-registered at the factory. If you have a new handset, you will need to register the handset with the base station in order to be recognized as a member handset by the base(s) and by other handsets. See Handset Registration.
2. Fully charge battery packs before using.

Basic Operations

Operation Modes

Both the base station and handset have levels of operation at which time only certain procedures of functions can be performed.

A. Base Operation Modes

1. **IDLE mode**- this is the default mode. The speakerphone, intercom, broadcast, and volume keys are active in IDLE mode.
2. **TALK mode**- the base operates in this mode during phone call, intercom, and broadcast operation. The dialing, "Transfer", "Memory", "Mute", "Hold", Flash" and "Redial/P" keys are operated in this mode. The "In Use", "Intercom", "Broadcast", and "Mute" LED will light up respectively.
3. **REGISTRATION mode**- the base enters this mode by pressing the REG button for three seconds. There are no active base unit keys once this mode has been entered. Speakerphone and Intercom LEDs will be lighted up in Registration mode, also a prompt ringing will be emitted.

B. Handset Operation Modes

1. **Standby mode**- this is the default mode.
 - a. If there is no on-going activity, the handset automatically goes into SLEEP/IDLE mode to save battery power.
 - b. The handset can be turned off completely by holding down the END key for 3 seconds.
 - c. The idle screen display (custom name) can be edited.
 - d. The 2-digit number represents the handset ID



2. **Menu mode**
 - a. Press the Right soft function key to activate Menu mode.
 - b. In Menu mode, the handset settings and information contained in memory can be changed.
 - c. The functions available through the Menu selection are covered in greater detail from page 50.
 - d. The Menu structure display as below:

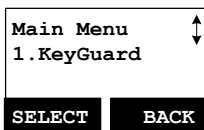

3. Menu Tree

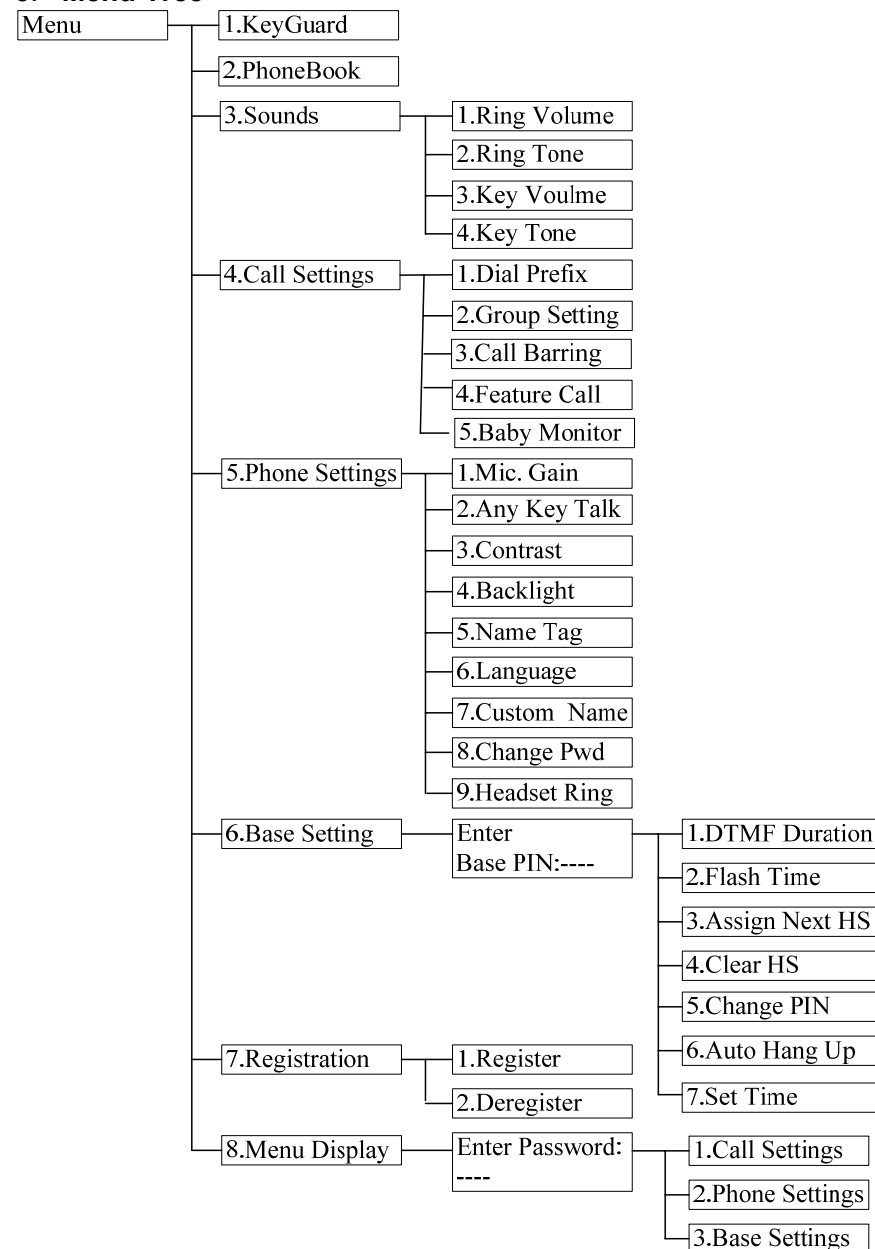

Making a Telephone Call

A. From Handset

1. Press , wait for dial tone, and then enter phone number.

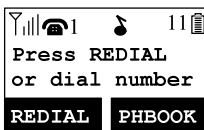



2. Alternatively, you can enter phone number first then press  key.

When using this method, you can use the **CLEAR** (Left) and **DELETE** (Right) soft keys to edit the number entered. "Delete" erases the last digit entered. "Clear" erases the entire line but remains in the dialing mode.



3. **Speed dial** by access the entries in the phone book (Menu→2)

a. Press  or  scrolling key to enter the phone book

b. Press  to dial out the number

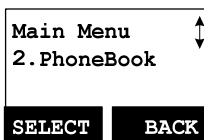

4. To abort dialing, press  key.

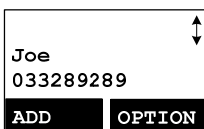

Notes:

1. If the line is occupied, the LCD shows "No Line Available" and handset returns to standby mode.
2. If a link cannot be established, the LCD will show "No Base" after a 12-second time out.
3. A call duration timer will start displaying the length of the call after link is established.

B. From Base

1. Press , wait for dial tone, and then enter phone number.

2. **Speed dial** by access the entries in the base memory.

Press  and the location of speed dial "N" (N : 00~19), then press



3. Press  again to hang up the call.

Making an 2-Way/ Intercom Call

The FreeStyl 1 Cordless Phone System offers private, Intercom/ 2-way radio calls independence of base station. Intercom/ 2-way communication can be placed from or to base stations and handsets.

A. Handset to Handset Calls

1. Press  key followed by a two-digit handset ID or Group ID.

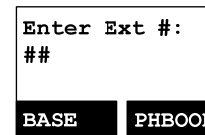



2. Press  key to end the call.



Notes:

1. Intercom calls can be made regardless if the Base Station is present.
2. If a Group ID is entered, the first handset (belonging to that group) that answers will establish a link with the caller. See Handset Group Subscription.
3. If a link cannot be established, the LCD shows "No Connection" after a 12-second time out.

B. Intercom/2-Way from Base to Handset

1. Rapidly press  key twice on the base station to intercom all registered handsets. The first handset to answer will establish a voice link with the base.

2. Press  key on the base station and wait for 2 seconds to intercom all registered handsets. The first handset to answer will establish a voice link with the base.



3. Either press  key followed by a two-digit handset ID/group ID, or press a two-digit handset ID/group ID followed by  key to intercom the designated handset/ group.

4. The INTERCOM LED will flash until a handset responds.

5. The base unit will page for 30 seconds, then terminate the page if no handset responds.

6. Before a handset answers, the INTERCOM can only be cancelled from the base by pressing  again. However, once a handset answers, the base and the answering handset both can end the call.



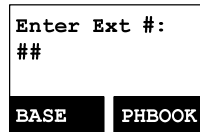

C. Intercom/2-Way from Handset to Base

1. Press  key followed by the left softkey --.
2. The base will ring, until press the  key to connect the intercom call with the handset.



Making a Broadcast





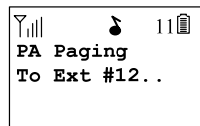
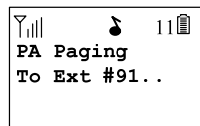
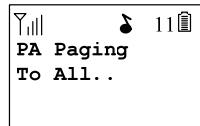

A. Handset to Handset Calls

1. Broadcasting all handsets
 - a. Press and hold  key (left side of handset) from one handset.
 - b. Hear bi-bi-beep while the initiating handset broadcast to all handsets within communication coverage.
 - c. Start to speak the message to be broadcasted once you hear the “beep” sound; the speakerphone of destination handsets will be opened up.
 - d. Release  key to end the broadcasting.
2. Broadcasting a group of handsets
 - a. Enter the Group ID and then press and hold  key (left side of handset).
 - b. Hear bi-bi-beep while the initiating handset broadcast all handsets within communication coverage.
 - c. Start to speak the message to be broadcasted once you hear the “beep” sound; the speakerphone of destination handsets will be opened up.
 - d. Release  key to end the broadcasting.
3. Broadcasting an individual handset
 - a. Enter the Handset ID and then press and hold  key (left side of handset).
 - b. Hear bi-bi-beep while the initiating handset broadcast all handsets within communication



- c. Start to speak the message to be broadcasted once you hear the “beep” sound; the speakerphone of destination handset will be opened up.
- d. Release  key to end the broadcasting.

B. Broadcasting from Base to Handset

1. Broadcasting all handsets
 - a. Press  key and hold for 3 seconds on the base station to broadcast all registered handsets.
 - b. Hearing bi-bi-beep while initiating broadcast to all handsets.
 - c. The BROADCAST LED will light up
 - d. Press the  key again and return to end the broadcasting.
2. Broadcasting a group of handsets
 - a. Enter the Group ID then press  key and hold for 3 seconds.
 - b. Hearing bi-bi-beep while initiating broadcast to the grouped handsets.
 - c. The BROADCAST LED will light up
 - d. Press  key to end the broadcasting.
3. Broadcasting an individual handset
 - a. Enter the Handset ID then press  key and hold for 3 seconds.
 - b. Hearing bi-bi-beep while initiating broadcast to a dedicated handset.
 - c. The BROADCAST LED will light up
 - d. Press  key to end the broadcasting.

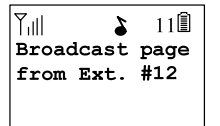
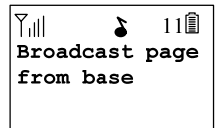
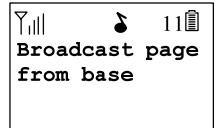

C. Broadcasting from Handset to Base

1. Broadcast to the base station
 - a. Enter the Base ID (10) and then press  key
 - b. Hear bi-bi-beep while the initiating handset broadcast the base stations.
 - c. Start to speak the message to be broadcasted once you hear the “beep” sound; the speakerphone of the base will be opened up

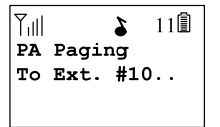



- d. Press the  key to end the broadcasting.

Redial

A. From Handset

1. Press **REDIAL** (Left) softkey.
2. The LCD shows the last phone number dialed. To dial this number, press  key.



3. Use  or  Key to scroll through the last 10 phone numbers dialed. Select and press  key. [Note] Intercom numbers (Handset ID) are not stored in the last 10 numbers dialed log.

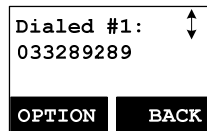

B. From Base

1. Press  key, after hearing the dial tone, followed by the **REDIAL/P** key, the last dialed number will be dialed.
2. Or simply press **REDIAL/P** key the last dialed number will be dialed.

Receiving a Telephone Call

A. Handset

1. When an incoming call arrives, the LCD will show the caller ID message, and the ringer will ring or vibrate unless the ringer has been turned off.
2. If the handset is on the charger cradle (ringer will be temporarily switched to "Ring" if it has been set to "Vibrate"), lift the handset and press  key to start conversation.

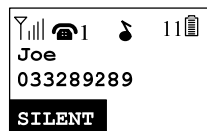

Re: You can turn on the "Any Key Talk" from **MENU**-5-2

Notes:

1. You can press **SILENT** (Left) soft key if you choose to ignore the call. Unlike turning off the ringer (from the handset menu), the **SILENT** key operation is valid only for the current call.
2. If Caller ID service is available, the LCD will display the



incoming call information. If the LCD shows "Private" or "Unknown", the caller's information may have been blocked by the caller or the originating phone company.

B. Base

1. When an incoming call arrives, the ringer will ring, the speaker LED will flash.
2. Press the  to answer the call.

Receiving an Intercom Call

A. Intercom Call from Handset

1. When an intercom call arrives (called from other handsets, ex. Handset 12), the ringer will ring or vibrate unless the ringer has been turned off. Press  to answer the intercom call.
2. If the handset is on the charger cradle (ringer will be temporarily switched to "Ring" if it has been set to "Vibrate"), lift the handset and start conversation.
3. If the handset is not on the cradle, press any key (except  and the **SILENT** soft key) to answer.

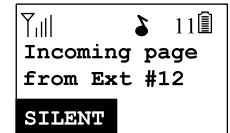

Notes:

1. The LCD displays the caller's Handset ID.
2. You can press the **SILENT** (Left) soft key if you choose to ignore the call. Unlike turning off the ringer the **SILENT** key operation is valid only for the current call.

B. Intercom Call from Base

1. When an intercom call arrives (called from Base), the ringer will ring or vibrate unless the ringer has been turned off. Press  to answer the intercom call.
2. If the handset is on the charger cradle (ringer will be temporarily switched to "Ring" if it has been set to "Vibrate"), lift the handset and start conversation.





Ending a Call



A. from Handset

To end a telephone or intercom call, press  key, or place handset into charger cradle.

B. from Base



To end a telephone call, press  key. To end an intercom call, press  key.

Adjusting Handset Receiver (Earpiece) Voice Volume

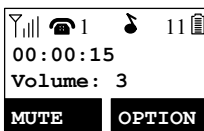
1. Voice volume can only be adjusted during a call.
2. There are 6 levels of volume selections. Use  or  key to adjust
3. The new setting remains effective for all future calls until changed.



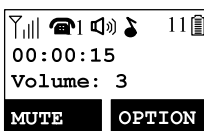

Adjusting Handset Speakerphone Voice Volume

1. Voice volume can only be adjusted during a call (in speakerphone mode).
2. There are 6 levels of volume selections. Use  or  key to adjust
3. The new setting remains effective for all future calls until changed.



Adjusting Base Speakerphone Voice Volume

1. Voice volume can only be adjusted during a call.
2. There are 6 levels of volume selections. Use  or  key to adjust.

3. The new setting remains effective for all future calls until changed.





Placing a Call On Hold



1. When a call is in progress, it can be put on hold by pressing the  key.
2. To return to the conversation, press **UNHOLD** (Left) soft key

You have a call on hold

UNHOLD **XFER**

Notes:

1. The call being placed on hold can be “un-hold” by the handset that puts it on hold. But if the handset press  key to go back standby, then other handsets can press  or  to pick this held call (If press  on base, it can also pick up this held call).
2. Handset LCD displays a call is being on hold. An alert tone (double beep) every 30 seconds will remind the handset that a call is being on hold.
3. If the operation (e.g., call transfer) after putting a call on-hold fails, the held call may be dropped.

3. When a call is in progress via base, it can be put on hold by pressing the  key.
4. To return to the conversation, press  or  key.

Mute

1. After a link is established, you can press **MUTE** (Left) soft key to mute the handset microphone.
2. When mute is active, the other end will not hear your voice, but still can speak to you.

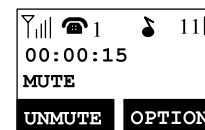

3. To leave the mute state, press **UNMUTE** (Left) soft key. Mute is effective only for the current call.
4. When in a call via base, you can press  to mute the base

microphone.

5. To leave the mute state, press **MEM MUTE** key.

Do Not Disturb (Silent Ring)

1. Enter the key sequence MENU-3-1, then select "Off". Press **SELECT** (Left) to confirm your choice. This will turn off the ringer until it is turned on again from the menu.
Re: When setting the ringer "Off", the standby screen will show "Ringer off".



2. For temporary silencing the ringer when an incoming call arrives, press **SILENT** (Left) soft key.
3. Press the **VOL-** key repeatedly until the base ringer is silent, this will turn off the base ringer. When an incoming call, the base will not ring.
4. Press the **VOL+** key to turn on the base ringer.

Key Guard

1. To prevent accidental dialing, you can press **MENU** (Right) soft key, then press "1" to select KeyGuard option. The handset keypad is locked. No key entry is accepted.
2. To unlock the keypad, press **UNLOCK** (Left) soft key, then, within 2 seconds, press the digit "*" to unlock.
3. Once returning back to idle mode for 15 seconds, the keyguard will be automatically enabled.
4. Key Guard is in effect until unlocked.

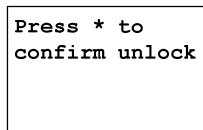
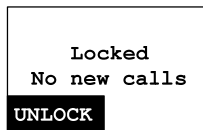

Battery Recharge and Replacement

1. Charge the battery when one or several of the following happen:
 - a. Phone beeps twice every two seconds.

- b. Battery icon is empty.
- c. Phone does not respond when a key is pressed.
- d. LCD and backlighting become dim.
- e. Talk range shortfall is experienced.



2. You can replace the handset battery after placing the call-in-progress on hold.
3. Battery talk time and standby time vary depending on the talk/standby pattern and the operating distance. Putting the handset back to charger cradle as often as possible is recommended for best performance. **Use only manufacturer provided battery and charger!**

Advanced Operations

Handset Registration



1. If your handset(s) is purchased as part of a system, it has been pre-registered with the base station at the factory.
2. If Handset ID as “00,” that means it is a new handset or the ID has been erased. You need to register the handset with the base station.

3. Registration:

- a. Press **MENU-7** to enter the registration mode
- b. Press and hold the base’s Registration (REG) button for 2 seconds until the  and  LEDs lighting up and flashing, also the base will emit ringing to remind you the base is in the registration mode..
- c. Press handset key “1”, this completes the registration process. The base station will assign a handset ID between 12 and 19. The assigned ID will be displayed on the handset LCD, indicating successful registration.
- d. Repeat above steps for all additional handsets.



4. De-registration:

- a. You can de-register the handset you’re using from the base. De-registration will reset the Handset ID to 00, erase the system security code, and free up the old ID for future registration.
- b. After deregistration, the handset will not be able to use the base to make or receive phone calls, nor can it intercom other handsets.
- c. Press **MENU-7** to enter the registration mode
- d. Press and hold the base’s REG button for 2 seconds until until the  and  LEDs lighting up and flashing.
- e. Press the handset number key “2”, this completes the de-registration process. Upon successful de-registration, the handset will show ID “00”.



Notes:

1. The base has a 30 second registration timeout starting from pressing the REG button. The handset has a 12 second registration timeout starting from the registration or de-registration option has been selected. The base and handset will automatically exit registration mode after timeout.
2. Repeat registration or de-registration process if unsuccessful.

Handset Group Subscription

1. Up to nine handset groups (91-99) can be defined and handsets can decide which group(s) they want to be in.
2. For example, Group 1 represents the Customer Service Group, Group 2 represents the Sales Group, and Group 3 is the Marketing Group. Suppose that Handset 11 wants to receive incoming rings for all Sales and Marketing related calls. Then handset 11 will need to “subscribe” to Group 2 and Group 3.

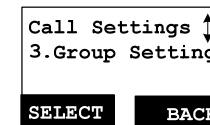
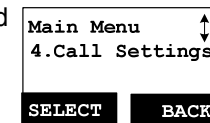

3. Group Selections:

- a. Press handset **MENU-4** to enter the Call Settings menu
- b. Press number “2”, handset enters group setting menu.
- c. Press **OPTION** soft key and followed by “1” key to subscribe the group (“9 #” , #:1~9). Enter 1~9.
- d. Repeat for all desired groups.



- e. Delete group selections by pressing **OPTION** soft key and followed by “2” to Unsubscribe the group.



Notes:

1. The handset can change group affiliations at any time.
2. The base is not responsible for group assignments. Consequently, it cannot de-subscribe a handset from a group.

3. When an intercom caller enters a group ID, all handsets subscribed to this group will ring. The first handset to answer will establish a link with the caller. Afterward, it is a one-to-one call, not a one-to-many call.

Call Transfer

While a telephone call is in progress, you can transfer it between different handsets or transfer to base.

Direct transfer from handset

1. Press **CALLER ID HOLD** key to put the call on hold.
2. Press **XFER** (Right) soft key, followed by the destination handset ID or **BASE** (Left), then the held call will be transferred directly.

After the call transferred to destination handset or Base, the original handset will go back to standby mode automatically.

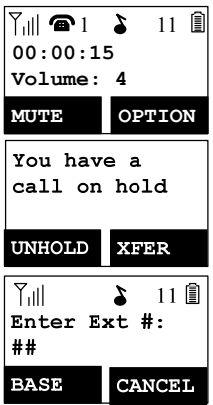

Indirect transfer from handset

If you want to talk to the destination handset or Base before the call transferred, you can follow with below method:

1. During the call, press **INTERCOM TRANSFER** key, followed by entering the destination handset ID or **BASE** (Left).
2. Press the **FLASH** or **INTERCOM BROADCAST** of the destination handset or press the **INTERCOM BROADCAST** key of base to answer the intercom call, you can now talk to the destination handset. After the talking, press **FLASH** to end the intercom call, then the destination handset is able to pick up the incoming call.

After the call transferred to destination handset or Base, the original handset will go back to standby mode automatically.

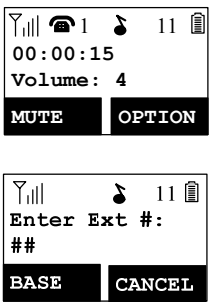

Direct transfer from base

1. Press base **HOLD** key to put the call on hold.
Re: When call on hold, the base In Use & speakerphone LED will be flashing.
2. Either press **TRANSFER** key followed by the destination handset ID, or enter the destination handset ID followed by **TRANSFER** key, the destination handset will ring. Press **FLASH** or **INTERCOM BROADCAST** key of destination handset to pick up the call.

After the call pick up by destination handset, the base will go back to standby mode automatically.

Indirect transfer from base

If you want to talk to the destination handset before the call transferred, you can follow with below method:

1. Either press **INTERCOM BROADCAST** key followed by the destination handset ID, or enter the destination handset ID followed by **INTERCOM BROADCAST** key, the destination handset will ring.
2. Press the **FLASH** or **INTERCOM BROADCAST** of the destination handset to answer the intercom call, you can now talk to the destination handset.

After the talking, press base **INTERCOM BROADCAST** to end the intercom call, then the destination handset will pick up the held incoming call.

Notes: If the destination handset does not answer after handset paging timeout, the call is routed back to the originating handset.

Phonebook Operations

1. You can store up to 50 entries in the phonebook. Each entry can contain a phone number or handset ID (up to 26 digits) and a name (up to 16 characters).
2. To access the phonebook, press **MENU** (Right) soft key, follow by "2"; or press **scrolling key** while the handset is in standby mode.

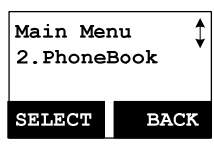

3. To add a new entry:

a. Press **ADD** (Left) soft key.

b. Enter the name when LCD prompts "Name?" Use **DELETE** (Right) soft key to delete the last digit entered. When completed, press **SAVE** (Left) soft key to save.

Re: Up to 16 characters can be entered as the name.

c. You will then be prompted to enter a number for the name just entered.

Re: Up to 26 digits can be entered as the number.

d. After entering the number, press the **SAVE** (Left) soft key to save this entry into phonebook.

e. Enter a phonebook entry without a name, the all records without name will be placed on top of the phonebook list.

f. To enter the name, press the corresponding keypad number one or more times according to the order of the character on the key.

See table below for a list of available characters and their orders. For example, press "2" once for the character "A", twice for "B", etc.

Joe
033289289
ADD **OPTION**

Name?
-
Caps = *
SAVE **DELETE**

Number?
-
SAVE **DELETE**

Notes:

- When enter a phone number, the cursor automatically advances to the next digit field. Use or scrolling key to move the cursor backward or forward to insert or delete (the digit above the cursor, or left of the cursor if cursor is on the right of the last digit).
- When entering a name, the cursor automatically advances to the next character field if you press a different key for the next character. If you need to enter consecutive characters from the same key, you can wait for the cursor to advance or use or scrolling key to move the cursor backward or forward manually. Also use or to move the cursor to insert (to the left of the cursor) or delete (the character above the cursor, or left of the cursor if cursor is on the right of the last character).
- By default, all letters are entered in the upper case. Use the * key to toggle between upper and lower cases.

4. A "Pause" entry represents a 1 second delay in dialing the following digits, which is useful when calling a sequence of segmented numbers (e.g., access code, credit card number, auto-attendant entries, etc.) Pause is entered by pressing the # key twice (LCD displays P). Entering pause twice (PP) will result in 2 seconds pause in the dialing.

5. Character Table:

Key	Characters and Orders
1	' + , . * () & 1
2	A B C 2
3	D E F 3
4	G H I 4
5	J K L 5
6	M N O 6
7	P Q R S 7
8	T U V 8
9	W X Y Z 9
0	0
*	Caps – when in character editing. * – when in number editing.
#	Space & # – when in character editing # & P (Pause) – when in number editing

- The entries are alphabetically sorted and stored as a list in an ascending order (A to Z) from the top of the list.
- The first line of LCD display shows name and the 2nd line shows the phone number. If the phone number is longer than 16 digits, press **OPTION** (Right) soft key and select Option 3 to view the complete number.
- To search for a record:
 - Use scrolling key to enter the Phone Book mode.
 - Press a key that corresponds to the first character of the name you are looking for.
 - For example, you are looking for "EnGenius", and then press the number "3" once.
 - Use or scrolling key to locate the exact record you are looking for.

7. To erase phonebook:

- a. Use or scrolling key or the alphabetical search method to locate the record to be erased or edited.

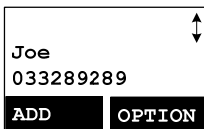

- b. Press **OPTION** (Right) soft key to enter editing menu.

- c. Press "1" to erase the desinated phone entry.
- d. LCD shown "Delete entry?" Press **YES** (Left) soft key to confirm your change.

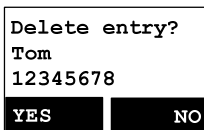

8. To edit phonebook:

- a. Use or scrolling key or the alphabetical search method to locate the record to be erased or edited.

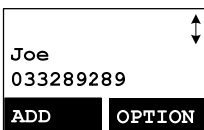

- b. Press **OPTION** (Right) soft key to enter editing menu.

- c. Press "2" to edit the desinated phone entry.

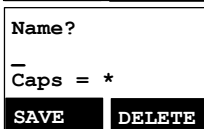

9. Dial from display:

- a. Press or to dial the phone number or Handset ID displayed.

10. To transfer phonebook:

To transfer phonebook, both parties have to enter the phonebook transfer mode firstly by following below:

- a. Press **OPTION** follow by **5** or or scrolling key when handset in phonebook mode.
- b. For phone sending party, press **1** to enter sending mode.
 - i. Either press **TX ALL** (left softkey) to transfer all phonebook entries to another handset(s).
 - ii. Or press **TX ONE** (right softkey) to transfer one entry to another handset(s).
 - iii. Press 2-digit handset ID or group ID, then select all phonebook entries or one entry to be transferred.
Re : "00" means all handsets
 - iv. During phonebook transferring, LCD shows "Sending" and 2-digit

countdown on the LCD to indicate the phonebook numbers which are waiting for sending.

- c. For phonebook receiving party, press **2** to enter receiving mode.
 - i. When entering the receiving mode, LCD shows "Ready".
 - ii. Start to receive phonebook, LCD shows "Get phonebook from Ext. # : xx".
 - iii. A beep emitted when receiving each phonebook.
 - iv. When the phonebook receiving, 2-digit countdown on the LCD to indicate the phonebook numbers which are waiting for receiving.

Re: The phonebook transfer through the wireless interface, it may partially miss transmission by interference.

Call Barring

- 1. Block the users from dialing the long distance calls or international calls. And also block the incoming call from outside line or other registered handset.
You need the password to enter the setting. The default PW is "0000".

- 2. Press **MENU**-4-3 to enter Call Barring. Enter the password, followed by **OK** (Left) soft key

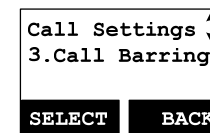

Block Outgoing Call

- 1. Press **SELECT** to confirm your selection for "Outgoing".

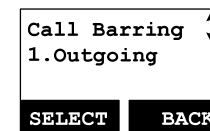

- 2. Use or scrolling key to switch between On and Off of this setting. Press **SELECT** to confirm your selection.

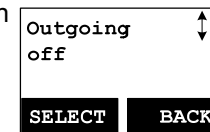

Re : The default of Call Barring is "Off".

3. To add the Call Barring code

- a. Once turn on the Call Barring feature, you can key in the "Call Barring" code. Press **ADD** (Left) soft key then start entering the Call Barring code After the number entered, press **SAVE** (Left) soft key to save it.

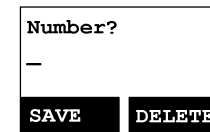

- (1) Up to 5 digits can be edit to be Call Barring code. For example, if you want to block all call dialing to Manhattantt, NY area, you can enter 1212 as the Call Barring code.
- (2) If you base station is adjunct to a PBX system, please also include that specific number to retrieve the PSTN tone.

- b. Press **OPTION** to delete or edit the Call Barring codes.
- c. Up to 5 set of Call Barring codes can be programmed.
- d. If wants to block all outgoing calls, enter “* * * * *”, press **SAVE** (Left) soft key to save it, all outgoing calls will be restricted.

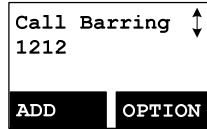

Block Incoming Call

- 1. Press **SELECT** to confirm your selection for “Incoming”.

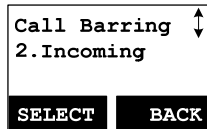

Use or scrolling key to select blocking item.

- a. Press **SELECT** to confirm your selection for receiving or blocking broadcasting.

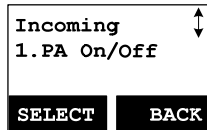

Press **CHANGE** to switch between On and Off of this setting.

Re: “On” means to be able to receive broadcast from other hansets or base. “Off” means to restrict the broadcast from other handsets or base.

- b. Press **SELECT** to confirm your selection for receiving or blocking line call.

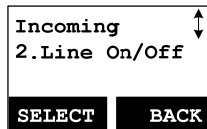

Press **CHANGE** to switch between On and Off of this setting.

Re: “On” means to be able to receive calls from outside line; “Off” means to restrict calls from outside line .

- c, Press **SELECT** to confirm your selection for receiving or blocking intercom call.

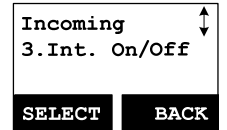

Press **CHANGE** to switch between On and Off of this setting.

Re: “On” means to be able to receive intercom calls from other handsets or base; “Off” means to restrict intercom calls from other handset or base.

Programmable Feature Call

- 1. If FreeStyl1 base unit is installed behind a PBX system, it is feasible to pre-program some feature call along with the PBX’s feature code into the system.
- 2. Up to 10 most frequently used feature call codes can be pre-programmed.
- 3. Name and enter feature call codes:

- a. Press **MENU** (Right) soft key while the handset is in the standby mode.
- b. Press “4”, followed by “4” to enter the “Feature Call” menu.
- c. Press **ADD** (Left) soft key to add a new entry of feature call.
- d. Key in the name of feature call, like editing a phonebook entry, i.e. “PBX Transfer”. Press **SAVE** (Left) soft key to confirm.

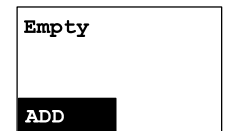
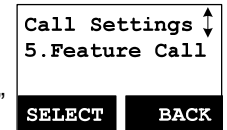

- e. Key in the feature call code of the correspondence PBX feature i.e. F * 70. Press **SAVE** (Left) soft key to confirm. Re: “F” represent the Flash signal.

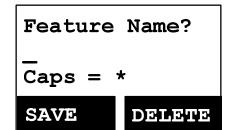

- f. The 1st feature call and correspondence feature call code you entered will appear on the LCD screen.



- g. Press **OPTION** (Right) soft key to delete or edit the feature call you programmed into the system.
 h. Repeat the same operations to program 2nd and even more feature call that you will use frequently.

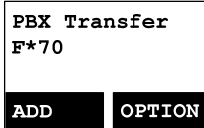

4. Using pre-programmed feature call during the call.

- a. Press **OPTION** (Right) soft key while the handset is in the talk mode.
 b. Press the correspondence number of the feature call which you want to perform i.e. press "0" to perform the "PBX Transfer".

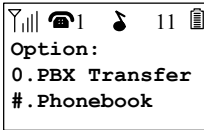
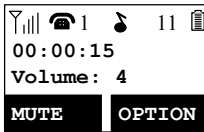

Notes:

1. This feature call would be useful if the FreeStyl 1 base unit is adjunct to a PBX system,
2. if you have not pre-programmed any feature call into the system, only "#.Phonebook" in the **OPTION** menu.
3. The FreeStyl 1's programmable feature call may not function with all PBX or Key phone systems due to the diversity of various proprietary systems.

Caller ID

1. Contact with your local phone company to subscribe to this feature. The phone system receives and displays Caller ID information transmitted by your local phone company. This information may include the phone number, date, time. This unit can store up to 50 calls.

2. The display will show the date and time of call on the first line, followed by the name on the second line, and the phone number on the third line. An unread record will have a "NEW" at the end of the first line of display.
3. When viewing a call record, the number can be dialed, stored to the phonebook or deleted.

View Call Log

1. To view the call log, press **GALLERID** to enter the Call Log. Press **UP** or **DOWN** key to scroll through the numbers and names when available.
2. Press **OPTION** (Right) soft key, you can **UP** or **DOWN** key to choose save, delete, clear all.
- a. Save call log:

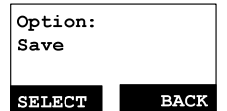
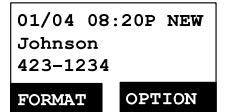

- (1) Press **SELECT** (Right) soft key, you can use **UP** or **DOWN** key to scroll the name, and press **DELETE** to edit the name. Then press **SAVE** (Left) soft key to save the name.
- (2) Use **UP** or **DOWN** key to scroll the number, and press **DELETE** to edit the number. Then press **SAVE** (Left) soft key to save the number.
- (3) After above process, the call log saved into phonebook.

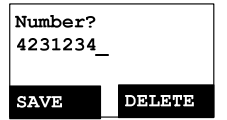

- b. Delete call log:
- (1) Press **SELECT** (Right) soft key followed by **YES** (Left) soft key to confirm deleting.

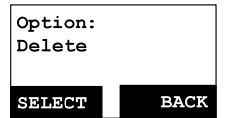

- c. Clear All:
- (1) Press **SELECT** (Right) soft key followed by **YES** (Left) soft key to confirm clearing all caller ID records.

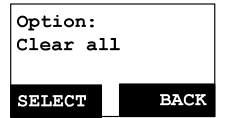

Call a Caller ID

1. When display a caller ID, Press **CALL** or **CALL** to dial this number.

- The displayed caller ID normally will be a 10-digit number with a 3-digit area code followed by the 7-digit telephone number.

```
01/04 08:20P NEW
Johnson
555-423-1234
FORMAT OPTION
```

The number in call log can be modified to comply with the local dialing rules.

- Press **CALLERID** key, use or key to scroll the call log.
- To display the telephone number without “1” or area code, press **FORMAT** (Left) soft key.
- For example, the number stored in the call log is “1-555-423-1234”, press the **FORMAT** (Left) soft key once, the displayed number will be changed to “423-1234”. Press the **FORMAT** (Left) soft key a second time, it will be changed to “555-423-1234”. Press the **FORMAT** (Left) soft key a third time, it will be changed to original number “1-555-423-1234”.
- Press or to dial this displayed number which complies with the dialing rules.

```
01/04 08:20P NEW
Johnson
423-1234
FORMAT OPTION
```

```
01/04 08:20P NEW
Johnson
1-555-423-1234
FORMAT OPTION
```

Note: Normally the standard format of telephone number is 10-digit or 11-digit, if the number doesn't meet the format (For example, over 11-digit), then the displayed number will not be modified as above item 5 when press **FORMAT** (Left) soft key.

Base Speed Dial Setting

- You can store up to 20 entries in the speed dial memory. Each speed dial memory can contain a phone number (up to 32 digits).
- Base during standby mode, press **MEM MUTE** key, enter the telephone number.
- Press **MEM MUTE** key, followed by a 2-digit memory location, base then will emit a two short tone (Bi-Bi) to confirm the setting.
Re: The memory location is “00” ~ “19”.
- When using the base speed dial, press **MEM MUTE** key followed by 2-digit memory location (“00”~”19”), then press the key.

The base will dial the telephone number accordingly.

Base Ringer Setting

- You can change the base ringer by following :
- Base during standby mode, press **MEM MUTE** key twice, followed by or key, the base speaker will emit the varied ringer (up to 8 ringer tones).
- Press **MEM MUTE** key to confirm the setting.
- To adjust the ringer volume, two options can be followed:
 - Base during standby mode, press or key.
 - When incoming call, press or key.
 - When press or key to adjust the volume, the speaker will emit the loudness of ringer, you can choose the preference.
Re: The loudness level of ringer is “0~4”, “0” means ringer “Off”.

Visual Message Waiting Indicator (VMWI)

VMWI feature supported the FSK message which received from telephone line; It will activate a message icon of handset and flash the VOICE MESSAGE LED of base.

Notes:



- A subscription to telephone company voice mail service is required.
- If the handset still indicates the icon even after you have listened all messages, turn it off by pressing and holding “Caller ID” key on the handset.

Adjust Handset Microphone Gain

In case you will use the handset in different workplace or environment, to perform better voice quality for the other end, you can adjust the handset microphone gain to suit for variable place.

- Press **MENU** (Right) soft key while the handset is in the standby mode.
- Press “5” (Phone Settings), followed by “1” to enter the “Mic. Gain”

menu.

- c. Use  or  key to scroll the “Standard”, “Medium” and “Low” options.
- d. If you are using the handset in quiet environment, like office or meeting room, the level of “Standard” is recommended.

If you are using the handset in a noisy environment, like factory or outdoor place, the level of “Medium” or “Low” is recommended.

Adjust Headset Ring

When using headset, to avoid missing the call due to the ringer emitted from receiver of headset, you can change the ringer emitting from either handset speaker or receiver of headset.

- a. Press **MENU** (Right) soft key while the handset is in the standby mode.
- b. Press “5” (Phone Settings), followed by “9” to enter the “Headset Ring” menu.
- c. Select “On”, the ringer will be emitted from the receiver of headset; If select “Off”, the ringer will be emitted from handset speaker.

Baby Monitor

You can set any one handset as a “baby unit” to monitor the movement of baby or older person.

When enabling the baby monitor, the “baby unit” will automatically enter the monitoring mode via 2-way intercom.









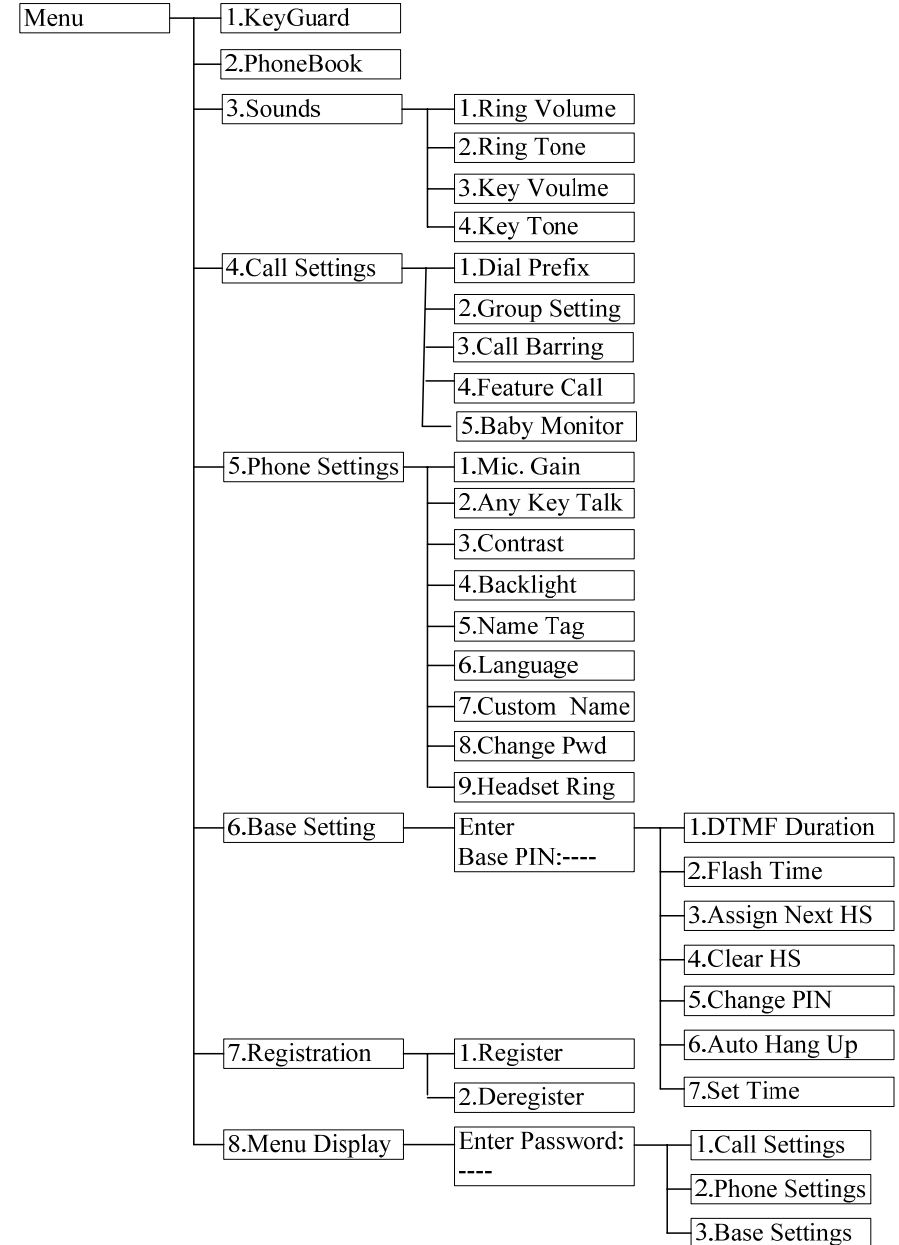













For example, if setting handset A as a “baby unit”, when making an intercom call from handset B, the handset A will automatically enter monitoring mode without ringing; Also you can hear the all movements around the handset A via the handset B.



- a. Press **MENU** (Right) soft key while the handset is in the standby mode.
- b. Press “4” (Call Settings), followed by “5” to enter the “Baby Monitor” menu.
- c. Press “CHANGE” to switch ON or OFF (default is OFF).

Re: To avoid any disturbance, during the monitoring, the dedicated handset will not answer any incoming call, except the intercom.

Menu Tree



1. Press **MENU** (Right) soft key to enter menu mode while the phone is in standby mode.
 Re: You can either press  or , followed by **SELECT** (Left) soft key to confirm the selected menu. Or Press the digit directly to confirm the selected menu. For example, press **MENU** (Right) soft key -3-1 to select the Ring Volume.
2. Press "1" to select KeyGuard (see Key Guard operation on page [37](#)).
3. Press "2" to add, delete, edit, view and edit the phonebook (see Phonebook instruction on page [42](#)).
4. Press "3" to set Sounds settings:
 - a. Press "1" to select Ring Volume:
 Two options for ring volume: Line (for incoming call) and Intercom (for intercom call). Set each option respectively.
 When setting each option, use  or  to scroll through 6 options: "Off", "Low", "Medium", "High", "Vibrate" and "Vibrate & High". Press **SELECT** (Left) soft key to save selection. Default = Medium.
 - b. Press "2" to select Ring Tone:
 Two options for ring tone: Line (ring tone for incoming call) and Intercom (ringer for intercom call). Set each option respectively.
 Use the  or  to scroll through 8 ringers, press **SELECT** (Left) soft key to save selection. Default = 1.
 - c. Press "3" to select Key Volume when a key is pressed:
 Use  or  to scroll through 4 options: Off, Low, Medium, and High. Press **SELECT** (Left) soft key to save selection. Default = Medium.
 - d. Press "4" to select Key Tone:
 Use the  or  to scroll through 4 options: 1, 2, 3 and 4. Press **SELECT** (Left) soft key to save selection. Default = 1.
5. Press "4" to set Call Settings:
 - a. Press "1" to set Dial Prefix:
 - (1) Press  or  to turn of or off the dial prefix feature. Default = Off.
 - (2) If "On" is selected, the handset is prompted to enter the prefix number, up to 14 digits can be entered.
 - (3) Use **Delete** (Right) soft key to edit prefix number.
 - (4) Press **SAVE** (Left) soft key to confirm the selection.
 - (5) When this feature is turned on, the LCD will prompt the user on each outgoing phone call, the current prefix is also displayed.
 - (6) This feature is useful for access code, calling card, and credit card calls, etc.
 - b. Press "2" to Group Select: see Handset Group Subscription on page [40](#).
 - c. Press "3" to set Call Barring: see Call Barring operation on Page [46](#).
 - d. Press "4" to set Feature Call: see Feature Call operation on Page [48](#).
 - e. Press "5" to set Baby Monitor: see Baby Monitor operation on Page [53](#).
6. Press "5" to set Phone Settings:
 - a. Press "1" to set Mic Gain: See Mic Gain operation on Page [52](#).
 - b. Press "2" to set Any Key TALK:
 Use **CHANGE** (Left) soft key to select and confirm on or off.
 Re: a. When set "on", press any key (except ) to answer the incoming call.
 b. When set "on", the handset will automatically answer the call while lift the handset from cradle.
 - c. Press "3" to set LCD Contrast:
 - (1) Use  or  to scroll through option 1~8. Default is 4.
 - (2) Press **SAVE** (Left) soft key to confirm selection.
 - d. Press "4" to set LCD Backlight:
 - (1) Use  or  to scroll through option 1~3 (1.8 seconds 2.On 3.Off). Default is "8 seconds".
 - (2) Press **SAVE** (Left) soft key to confirm selection.
 - e. Press "5" to set Name Tag:
 - (1) Use  or  to scroll through option on or off. Default is "Off".
 - (2) Press **SAVE** (Left) soft key to confirm selection.
 Re: When Set "on", if matching the caller ID with the phone book entries; once matched, the LCD screen will display the name or nickname instead of pure caller ID info (needs Call Waiting with Caller ID service from local telephone company)
 - f. Press "6" to set Language:
 - (1) Use  or  to scroll through option 1~3 (1.English 2.Spanish 3.French). Default is "English".
 - (2) Press **SAVE** (Left) soft key to confirm selection.
 - g. Press "7" to set Custom Name:
 - (1) Enter characters using the Character Table and method discussed in the Phonebook section.
 - (2) Use  or  to move the cursor backward or forward to insert (to the left of the cursor) or delete (the character above the cursor, or left of the cursor if cursor is on the right of the last character).
 - (3) Press **SAVE** (Left) soft key to confirm setting.

- Re: Once entering the custom name, the greeting of LCD in standby mode will be changed as the entering.
- h. Press “8” to Change Password:
 - (1) Enter original password (4 digits) when enter this menu.
 - (2) Enter new password then press **SAVE** (Left) soft key to confirm new password.
 - i. Press “9” to set Headset Ring: See Headset Ring operation on Page 53.
7. Press “6” to set Base Settings:
When enter this menu, you must enter PIN code first (4 digits).
Re: The PIN code is for Base Settings.
- a. Press “1” to set DTMF Duration.
 - (1) Enter the DTMF duration (90~200ms), press **OK** (Left) soft key to confirm the setting. Default is 100ms.
Re: Please check with your dealer before you change it. If the duration not match with PSTN or PBX setting, it may operate faultily.
 - b. Press “2” select flash key timing. Default is 600ms.
 - (1) Use  or  to scroll through option 1~9 (100~900ms).
 - (2) Press **SELECT** (Left) soft key to confirm selection.
Re: The default value (US version: 600ms; AU version 100ms) works in most areas. Changing this setting may cause Flash key not working. Change only when you are certain of the new value would work.
 - c. Press “3” to set Assign Next HS
 - (1) Enter 2-digit handset ID followed by pressing **OK** (Left) soft key.
 - (2) When register a new handset, the base will assign the specific handset ID which assigned in advance to the new handset.
 - d. Press “4” to set Clear HS
 - (1) Enter 2-digit handset ID followed by pressing **OK** (Left) soft key.
 - (2) The base will erase the handset ID from system.
 - e. Press “5” to Change PIN:
 - (1) Enter the new PIN followed by **OK** (Left) soft key.
Re: Default PIN is “0000”.
 - f. Press “6” to set Auto Hang Up:
 - (1) Use **CHANGE** (Left) soft key to select and confirm on or off. The Default PIN is “0000”.
Re: When setting “on”, the FreeStyl 1 will automatically hang up if the far end caller hung up already. However, this function depends on if there is “Line Reversal” signal sent out by PBX or PSTN, after the call hung up.
 - g. Press “7” to Set Time to support DTMF Caller ID:

- (1) Use **CHANGE** (Left) soft key to select and confirm on or off. The Default PIN is “0000”.
8. Press “7” to register & de-register handset: see Handset Registration operation on Page 39.
 9. Press “8” to set Menu Display:
To avoid mis-setup of Call Settings (MENU-4), Phone Settings (MENU-5) and Base Settings (MENU-6), you can hide these menus, so that other handset users won’t have chance to mis-setup these settings.
Re: When entering the Menu Display, you have to enter password first.
 - a. Press “1” to set hiding/un-hiding of the Call Settings menu.
 - (1) Use **CHANGE** (Left) soft key to select and confirm on or off.
 - b. Press “2” to set hiding/un-hiding of the Phone Settings menu.
 - (1) Use **CHANGE** (Left) soft key to select and confirm on or off.
 - c. Press “3” to set hiding/un-hiding of the Base Settings menu.
 - (1) Use **CHANGE** (Left) soft key to select and confirm on or off.
 Re: Select “On” means the menu will be displayed on screen. Select “Off” means the menu will be hidden.

Part 68 Statement

This equipment complies with Part 68 of the FCC rules and the requirements adopted by the ACTA. On the bottom of this equipment is a label that contains, among other information, a product identifier in the format US: SNIW403BFS1. If requested, this number must be provided to the telephone company.

The REN is used to determine the number of devices that may be connected to a telephone line. Excessive RENs on a telephone line may result in the devices not ringing in response to an incoming call. In most but not all areas, the sum of RENs should not exceed five (5.0). To be certain of the number of devices that may be connected to a line, as determined by the total RENs, contact the local telephone company. For products approved after July 23, 2001, the REN for this product is part of the product identifier that has the format US: SNIW403BFS1. The digits represented by 03 are the REN without a decimal point (e.g., 03 is a REN of 0.3). For earlier products, the REN is separately shown on the label.

If your equipment causes harm to the telephone network, the telephone company may discontinue your service temporarily. If possible, they will notify you in advance. But if advance notice is not practical, you will be notified as soon as possible. You will be informed of your right to file a complaint with the FCC. Your telephone company may make changes in its facilities, equipment, operations or procedures that could affect the proper functioning of your equipment. If they do, you will be notified in advance to give you an opportunity to maintain uninterrupted telephone service.

If you experience trouble with this telephone equipment, please contact the following address and phone number for information on obtaining service or repairs.

The telephone company may ask that you disconnect this equipment from the network until the problem has been corrected or until you are sure that the equipment is not malfunctioning.

This equipment may not be used on coin service provided by the telephone company. Connection to party lines is subject to state tariffs.

Company: EnGenius Technologies, Inc.

Address: 1580 Scenic Avenue, Costa Mesa, CA 92626 USA

Tel no.: 1-714-432-8668

A plug and jack used to connect this equipment to the premises wiring and telephone network must comply with the applicable FCC Part 68 rules and requirements adopted by the ACTA. A compliant telephone cord and modular plug is provided with this product. It is designed to be connected to a compatible modular jack that is also compliant. See installation instructions for details.

Index

- 2
2-Way Intercom, 13, 22, 30, 31
- A
Adjusting Receiver (Earpiece) Voice Volume, 35
Adjusting Handset Speakerphone Voice Volume, 35
Adjusting Base Speakerphone Voice Volume, 35
Administrator Features, 21
- B
Base ID, 32
Base Illustration, 20
Base Operation, 27
Base PIN, 17, 18
Base Ringer Setting, 52
Base Setting, 17, 18, 57, 58
Base Speed Dial, 51
Base Station, 5, 6, 7, 10, 13, 14, 21, 25, 26, 27, 30, 32, 39, 47
Base Station Features, 21
Base Station Installation, 25
Battery, 5, 6, 10, 12, 13, 16, 24, 26, 27, 37, 38
Battery Recharge and Replacement, 37
Battery Safety Instructions, 6
Battery Strength, 12
Broadcast, 13, 15, 21, 22, 27, 31, 32, 47
Broadcasting a Group of Handsets, 31, 32
Broadcasting all Handsets, 32
Broadcasting an Individual Handset, 32
- C
Call Barring, 15, 17, 46, 56
Call Log, 14, 50
Call Timer, 16
Call Transfer, 36, 41
Call Hold, 16
Caller ID, 14, 18, 33, 49, 52, 56, 57
Call in-progress, 12
Call Settings, 15, 17, 40, 55, 58
Call Waiting, 13, 22
Call Waiting with Caller ID, 14, 56
Cardiac Pacemaker, 4
Change PIN, 17, 57

Charger Features, 24
Charger Illustration, 23

- D
De-registration, 39
DND, 14
Do Not Disturb (Silent Ring), 14, 37
DTMF Tone, 17
DTMF Duration, 17, 57
- E
Electric Shock, 4, 5
Emergency, 4
Equipment Checklist, 10
- F
FCC, 5, 7, 8, 9, 59
FCC Radiation Exposure Statement, 7
FDA, 4
Flash, 13, 17, 22, 27, 30, 34, 39, 42, 48, 52, 57
Feature Call, 16, 48, 56
- G
General Safety Instructions, 4
Group ID, 14, 21, 30, 31, 32, 41, 45
Group Settings, 17, 40
Group Selections, 40
- H
Handset and Charger Installation, 26
Handset Charging Slot, 24
Handset Features, 12, 14
Handset Group Subscription, 40, 56
Handset ID, 12, 14, 16, 18, 21, 22, 27, 30, 31, 32, 33, 34, 39, 41, 42, 45, 57
Handset Registration, 39, 58
Handset to Handset Call, 30, 31
Hearing Aid, 4
- I
IDLE Mode, 27
- K
Key Guard, 37, 55
Key Tone, 16, 55

Key Volume, 55

- L

Line Jack, 21
Lithium-Ion (Li-Ion), 6, 10
Line Reversal, 57
Line Ringing, 14

- M

Making a Broadcast, 31
Making a Telephone Call, 29
Making an 2-Way/ Intercom Call, 30
Memory, 22, 27, 29, 51
Menu Display, 17, 58
Menu Mode, 26, 55
Multiple Handsets Registration, 14
Mute, 16, 21, 22, 27, 36

- N

Name Tagging, 14, 56

- O

Outdoor Antenna, 21

- P

Part 68 Statement, 59
Phonebook, 13, 15, 16, 42, 46, 48, 49, 50, 55, 56
Phone Settings, 17, 19, 52, 56, 58
Placing a Call On Hold, 36
Power Outage, 5
Product Safety Instructions, 4
Programmable Flash, 17
Programmable feature call, 16, 48

- R

Receiving a Telephone Call, 33
Receiving an Intercom Call, 34
Redial, 15, 22, 27, 33
REG, 21, 39
Registration Button, 21
Registration Mode, 21, 27, 39
Regulatory Information, 7
REN, 59

Reset Button, 21

Reverse Thread Connector, 21
Ringer, 12, 14, 19, 37, 52, 53, 55
Ringer Volume, 13, 14, 22, 52
RSSI, 12

- S

Safety Instructions, 4
SILENT, 14, 15, 33, 34, 37
Spare Battery, 10, 24
Spare Battery Charging Slot, 24
Speed Dial, 21, 23, 29, 51
Speakerphone, 13, 21, 22, 27, 31, 32, 35, 42

- T

Talk Mode, 13, 22, 27, 49
Talk/Flash, 13
Technical Specifications, 65
Transformer, 25, 26
Two-Digit Address Index, 12

- V

Vibrator, 14
View Call log, 50
Visual Message Waiting Indicator, 52

- W

Warning Message, 24

Technical Specifications

Electrical Specifications	Base Station	Portable Handset
Frequency	902-928 MHz	902-928 MHz
RF Power	Peak: 27 dBm Average: 21 dBm	Peak: 26 dBm Average: 20 dBm
Channel Spacing	101 kHz	101 kHz
Number of Channels	252	252
Modulation	Differentially Encoded MSK	Differentially Encoded MSK
Multiple Access	Frequency Hopping TDD	Frequency Hopping TDD
Frequency Hopping Rate	100 per second	100 per second
TDMA Frame Length	10 ms	10 ms
Number of Slots/Frame	4	4
Receiver Sensitivity	< -111 dBm (@ BER 10 ⁻²)	< -111 dBm (@ BER 10 ⁻²)
Antenna Connector	Reverse TNC	Non-standard
Antenna Gain	2 dBi	1.5 dBi (short antenna) 2.5 dBi (long antenna)
TX Power Control Range	19~27dBm	19~26dBm
Telephone Interface	RJ11 x 2	NA
Speech Coding	8 kbps G.729AB	8 kbps G.729AB
Channel Coding	8 kbps Convolutional + CRC	8 kbps Convolutional + CRC
Transmission Data Rate	85.333 kbps	85.333 kbps
User Data Rate	64 kbps duplex	64 kbps duplex
Duplex	Time Division Duplex (TDD)	Time Division Duplex (TDD)
Voice Quality	TIA/EIA-470B	TIA/EIA-470B
No. of System ID	65,536	65,536
Ring Signal	20-50 Hz, 30-90 Vrms	NA
Flash Time	100-900 ms programmable	NA
Power Source	AC/DC 100~240V/12V, 1A SW Adapter	3.7V/1100 mAh Li-Ion Battery Optional: 3.7V/1700mAh
Charger Current	NA	550 mA (850 mA for Spare Battery Slot)
Charge Time	NA	3 hours
Regulation Compliance	FCC Part 15, Part 68	FCC Part 15, Part 68 Hearing Aid Compatible
Operating Temperature	0 – 50 °C	-10 – 60 °C
Storage Temperature	-40 – 70 °C	-40 – 70 °C
Humidity	20 – 75 %	20 – 75 %
Dimension with antenna	190(W) x 160(D) x 208 (H) mm	167(L) x 47(W) x 28(D) mm
Weight	500g	130g

Notes:

1. NA = Not Applicable.
2. The manufacturer reserves the right to change designs and specifications without notice.