

Compact Disc Player

Operating Instructions



CDP-CX400

WARNING

To prevent fire or shock hazard, do not expose the unit to rain or moisture.

To avoid electrical shock, do not open the cabinet. Refer servicing to qualified personnel only.

For the customers in the United States

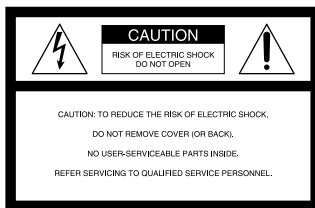

This symbol is intended to alert the user to the presence of uninsulated "dangerous voltage" within the product's enclosure that may be of sufficient magnitude to constitute a risk of electric shock to persons.



This symbol is intended to alert the user to the presence of important operating and maintenance (servicing) instructions in the literature accompanying the appliance.

INFORMATION

This equipment has been tested and found to comply with the limits for a Class B digital device, pursuant to Part 15 of the FCC Rules. These limits are designed to provide reasonable protection against harmful interference in a residential installation. This equipment generates, uses, and can radiate radio frequency energy and, if not installed and used in accordance with the instructions, may cause harmful interference to radio communications. However, there is no guarantee that interference will not occur in a particular installation. If this equipment does cause harmful interference to radio or television reception, which can be determined by turning the equipment off and on, the user is encouraged to try to correct the interference by one or more of the following measures:

- Reorient or relocate the receiving antenna.
- Increase the separation between the equipment and receiver.
- Connect the equipment into an outlet on a circuit different from that to which the receiver is connected.
- Consult the dealer or an experienced radio/TV technician for help.

CAUTION

You are cautioned that any changes or modifications not expressly approved in this manual could void your authority to operate this equipment.

Owner's Record

The model and serial numbers are located at the rear of the unit. Record the serial number in the space provided below. Refer to them whenever you call upon your Sony dealer regarding this product.

Model No. CDP-CX400

Serial No. _____

for the customers in North America



ENERGY STAR® is a U.S. registered mark. As ENERGY STAR® Partner, Sony Corporation has determined that this product meets the ENERGY STAR® guidelines for energy efficiency.

(Except for customers in the United States)

This appliance is classified as a CLASS 1 LASER product.

The CLASS 1 LASER PRODUCT MARKING is located on the rear exterior.

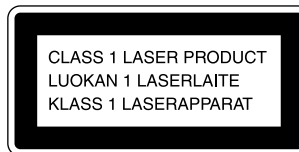

Welcome!

Thank you for purchasing this Sony Compact Disc Player. Before operating the unit, please read this manual thoroughly and retain it for future reference.

About This Manual

The instructions in this manual are for model CDP-CX400.

Conventions

- Instructions in this manual describe the controls on the player. You can also use the controls on the remote if they have the same or similar names as those on the player.
- The following icons are used in this manual:



Indicates that you can do the task using the remote.



Indicates hints and tips for making the task easier.

TABLE OF CONTENTS

Getting Started

Unpacking	4
Hooking Up the System	4
Connecting Another CD Player	6
Inserting CDs	7

Playing CDs

Playing a CD	10
Using the Display	11
Locating a Specific Disc	12
Specifying the Next Disc to Play	14
Playing the Disc Just Inserted (Easy Play)	14
Playing Discs in Various Modes (Repeat/Shuffle Play)	15
Creating Your Own Program (Program Play)	16
Using the Timer	19
Fading In or Out	19

Storing Information About CDs (Custom Files)

What You Can Do With the Custom Files	20
Labeling Discs (Disc Name)	20
Storing Custom File Information Using a Keyboard	23
Storing Specific Tracks (Delete Bank)	24
Grouping Discs (Group File)	24
Classifying Discs According to Artist Name (Artist File)	26
Storing Your Favorite Tracks (Hit List)	29

Using the Player with Another Component

Controlling Another CD Player (Advanced Mega Control)	31
Playing Alternately (No-Delay Play/X-Fade Play)	32
Controlling the Player by Another Unit	33

Additional Information

Precautions	34
Notes on CDs	34
Troubleshooting	35
Specifications	35

Index

Index	Back cover
-------------	------------

Unpacking

Check that you received the following items:

- Audio cord (1)
- Monaural (2P) mini-plug cord (1) (Connecting cord for CONTROL A1 II) (supplied for Canadian models only)
- Remote commander (remote) (1)
- Size AA (LR6) batteries (2)

Inserting batteries into the remote

You can control the player using the supplied remote. Insert two size AA (LR6) batteries (supplied) by matching the + and – ends on the batteries to the diagram inside the battery compartment. Insert the negative (–) end first, then push in and down until the positive (+) end clicks into position. When using the remote, point it at the remote sensor  on the player.

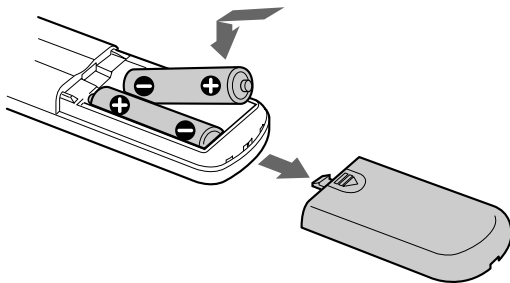

When to replace batteries

With normal use, the batteries should last for about six months. When the remote no longer operates the player, replace all the batteries with new ones.

Notes

- Do not leave the remote near an extremely hot or humid place.
- Do not drop any foreign object into the remote casing, particularly when replacing the batteries.
- Do not expose the remote sensor to direct sunlight or leave too near lighting apparatuses. Doing so may cause a malfunction.
- If you do not use the remote for an extended period of time, remove the batteries to avoid possible damage from battery leakage and corrosion.

Hooking Up the System

Overview

This section describes how to hook up the CD player to an amplifier. Be sure to turn off the power of each component before making the connections.

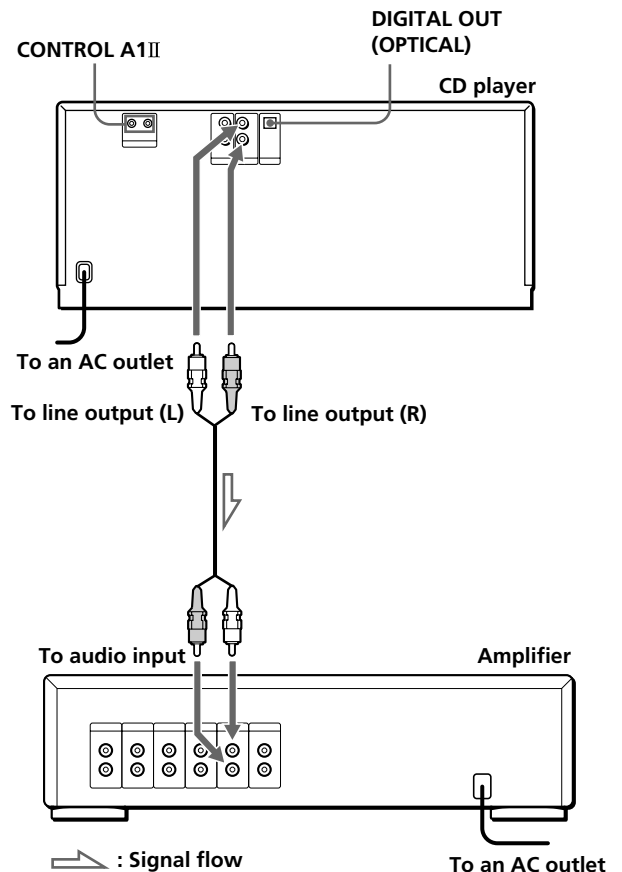

What cords will I need?

Audio cord (supplied) (1)

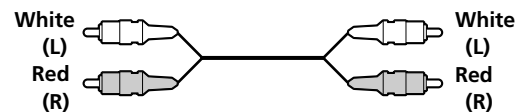

Hookups

When connecting an audio cord, be sure to match the color-coded cord to the appropriate jacks on the components: Red (right) to Red and White (left) to White. Be sure to connect firmly to avoid hum and noise.

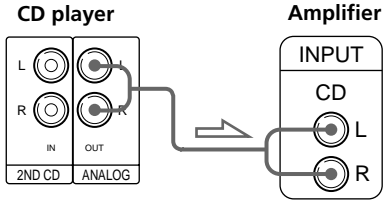

- **If you have a digital component such as a digital amplifier, D/A converter, DAT, or MD**
Connect the component via the DIGITAL OUT (OPTICAL) connector using an optical cable (not supplied). Take off the cap and plug in the optical cable.
Note that you cannot use fading in or out (page 19) and Time Fade (page 19) functions when making this connection.

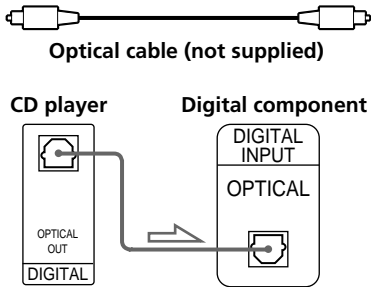

Note

When you connect via the DIGITAL OUT (OPTICAL) connector, noise may occur when you play CD software other than music, such as a CD-ROM.

💡 If you have a Sony component with the CONTROL A1II (or CONTROL A1) jack

Connect the component via the CONTROL A1II (or CONTROL A1) jack. You can simplify the operations of audio systems composed of separate Sony components. For details, refer to the supplementary "CONTROL A1II Control System" instructions.

Connecting the AC power cord

Connect the AC power cord to a wall outlet.

Note on placement of the player

Be sure to place the player in a flat, horizontal place. If the player is left in a slanted position, it may cause a malfunction or damage the player.

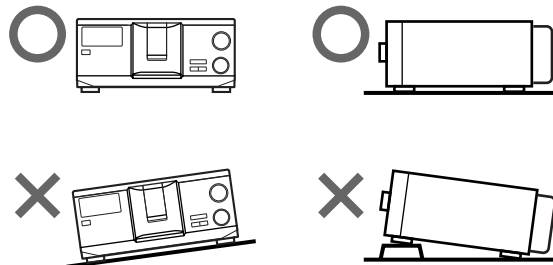

Connecting Another CD Player

If you have a Sony CD player in which 5, 50, 200, 300, or 400 discs can be inserted and which is equipped with the CONTROL A1II (or CONTROL A1) jack and the command mode of that player can be set to CD 3, you can control that player as the second player with this player. After connecting this player and an amplifier, follow the procedure below. Be sure to turn off the power of each player before making this connection.

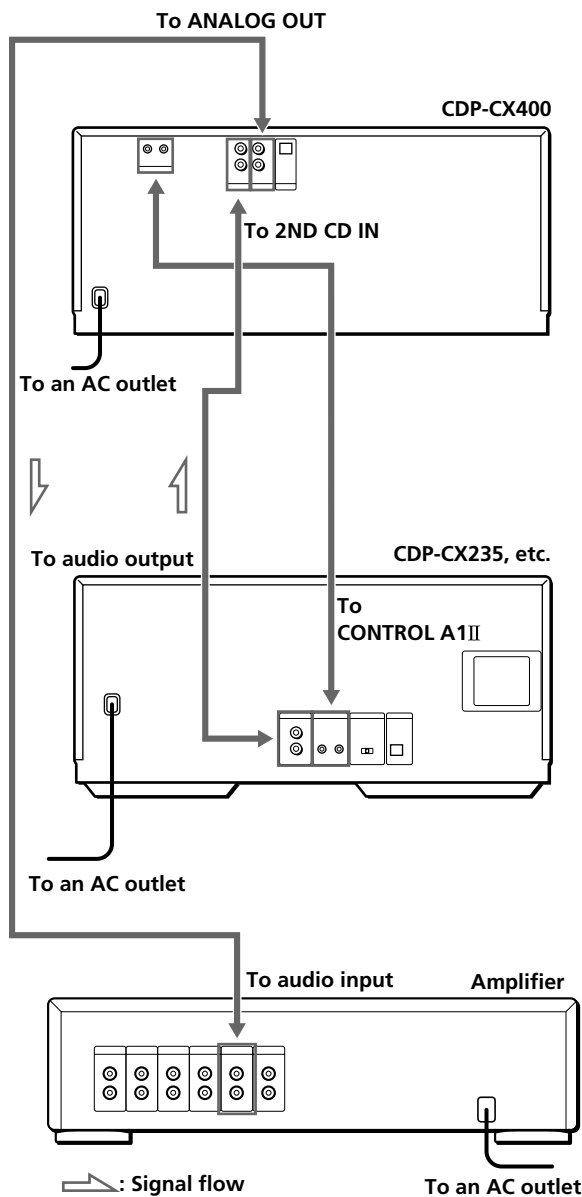

What cords will I need?

- Audio cord (1) (Use the cord supplied with the player to be connected.)
- Monaural (2P) mini-plug cord (1) (supplied for Canadian models only)

1 Connect the players with an audio cord (see also "Hookups" on page 5).

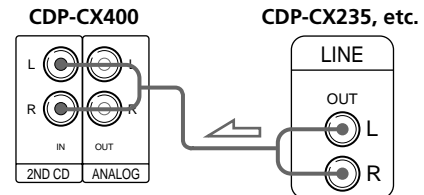

2 Connect the players with a monaural (2P) mini-plug cord.

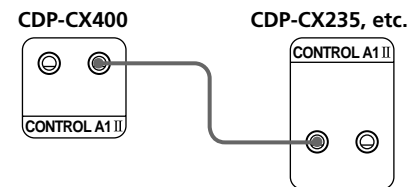

For details on this connection, refer to the supplementary "CONTROL A1II Control System" instructions.

3 Set the command mode of this player to CD1 (factory setting) or CD2, and set that of the second player to CD3. Check the display for the current command mode of this player, if the mode is CD3, change the mode as described on the next page.

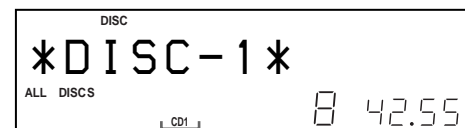

Current command mode

For details on how to operate the second player, see "Controlling Another CD Player" on page 31 and "Playing Alternately" on page 32.

4 Connect the AC power cord of both players to an AC outlet.

Notes

- Do not connect any player other than the one used as the second player to the 2ND CD IN jacks of this player.
- When connecting a second CD player, do not connect the DIGITAL OUT (OPTICAL) connector of this player to the amplifier.

Changing the command mode of the player

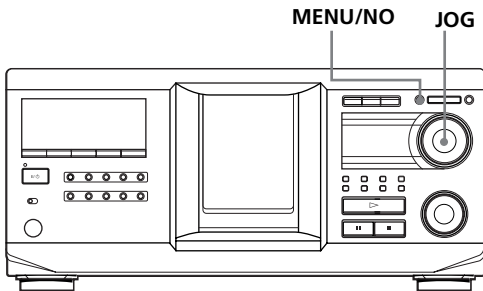

- 1 Press MENU/NO.
- 2 Turn the JOG dial until "Command Mode?" appears in the display.
- 3 Push the JOG dial.
The current command mode appears.

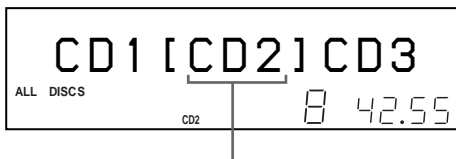

Current command mode

- 4 Turn the JOG dial to select CD1 or CD2, then push the JOG dial again.

Inserting CDs

You can insert up to 400 discs into this player.

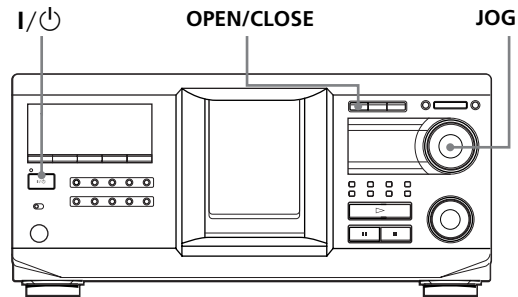

Top view of the disc slot

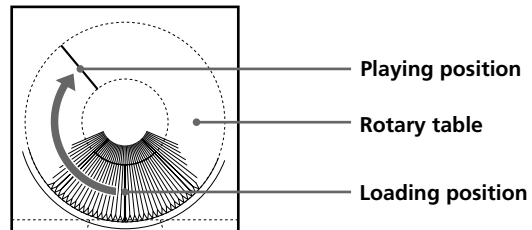

- 1 Press I/POWER to turn on the player.
- 2 Open the front cover by pressing OPEN/CLOSE.

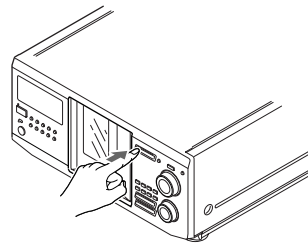

- 3 Turn the JOG dial until you find the disc slot where you want to insert a disc, while checking the disc number (written beside every slot and also indicated in the small display).

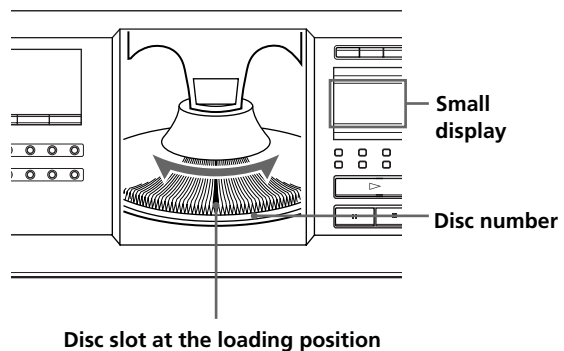

(continued)

The disc number at the loading position appears in the display. If the disc has a Disc Name (see page 20), the Disc Name appears instead of the disc number. As you turn the JOG dial, the disc number or the Disc Name changes.

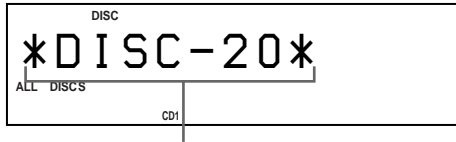

Disc number or the Disc Name

You can classify discs by using the Group File function or Artist Name function. This feature lets you easily find the disc you want to play. For details, see "Grouping discs (Group File)" on page 24 and "Classifying discs according to Artist Name (Artist File)" on page 26.

- 4 Insert a disc with the label side facing right.

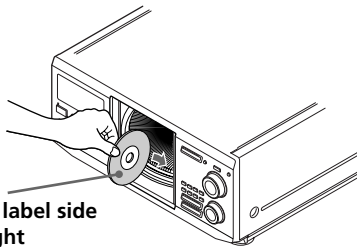

With the label side facing right

After inserting the disc, you can enter the original disc title to replace the disc number (see "Labeling discs (Disc Name)" on page 20) so you can locate it easily whenever you want to play it.



- 5 Repeat steps 3 and 4 to insert more discs.
- 6 Close the front cover by pressing OPEN/CLOSE.

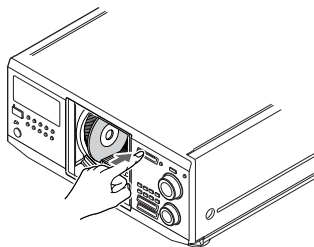

The rotary table turns and the disc slot at the loading position is set to the playing position. Always keep the front cover closed except when inserting or removing discs.

CAUTION

- **Do not insert an 8 cm (3-inch) CD adaptor.**

The player cannot play an 8 cm CD. Do not insert an 8 cm (3-inch) CD or an 8 cm (3-inch) CD adaptor (CSA-8). It may damage the player and disc.

- **Do not move the player after inserting discs.**

- Be sure to place the player in a flat, horizontal position. Do not place the player in a slanted position.

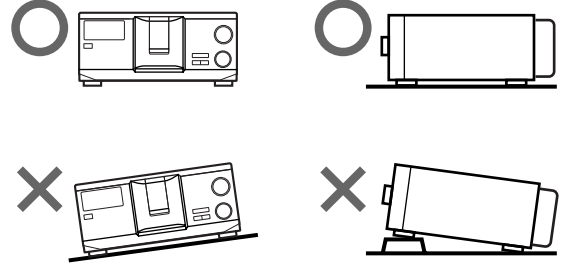

- Do not move the player and avoid any physical shock after inserting discs.
- When transporting the player, remove all discs from the player.

- **Make sure to insert the disc at a right angle to the rotary table.**

If the disc is not inserted into the slot completely (ex. when you press ) , reinsert the disc at a right angle to the rotary table.

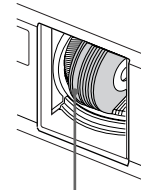



Disc that is not fully inserted

- **Do not attach seals or stickers, etc. to CDs.**

If seals or stickers, etc. are attached to a CD, the player may not operate properly and the player or the disc may be damaged.

Notes



- If you drop a disc into the player and/or the CD does not go into the slot correctly, consult your nearest Sony dealer.
- Make sure the rotary table comes to a complete stop before inserting or removing discs.
- The front panel closes automatically when you press  . Be careful not to put your hand into the player after pressing  , otherwise your hand may be caught in the front panel.

Removing CDs

After following steps 1 to 3 of “Inserting CDs” on page 7, remove the discs. Then close the front cover.



To remove discs easily

After following steps 1 to 3 of “Inserting CDs” on page 7, press  (DISC EJECT). The disc in the selected slot moves up and you can remove the disc easily. When you press  again, the disc returns to the loaded position. If the disc does not return to the loaded position, reinsert the disc.

Playing a CD

You can play all the tracks on a disc in the original order (Continuous Play). You can also play up to 400 discs consecutively. Make sure you have inserted the discs correctly as indicated on pages 7 and 8.

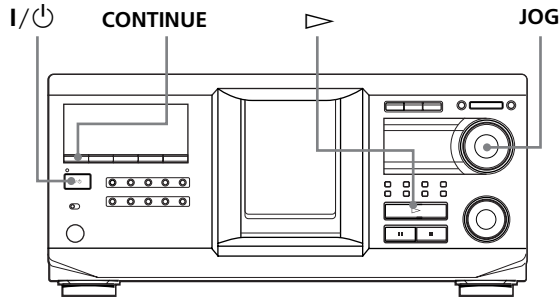

- 1 Turn on the amplifier and select the CD playing position.
- 2 Press I/⏻ to turn on the player.
- 3 Press CONTINUE to select ALL DISCS or 1 DISC Continuous Play mode. Each time you press CONTINUE, "ALL DISCS" or "1 DISC" appears alternately in the display.

When you select The player plays

ALL DISCS	All discs in the player consecutively in the order of disc number. Empty disc slots are skipped.
1 DISC	Only the one disc you have selected.

- 4 Turn the JOG dial until the desired disc number or Disc Name (see page 20) appears in the display to select the first disc (ALL DISCS) or the disc you want (1 DISC).

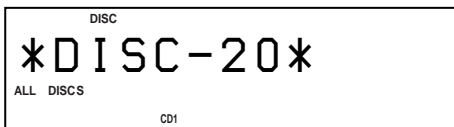

- 5 Push the JOG dial to start playing and adjust the volume on the amplifier. The selected disc is set to the playing position, and the player plays all the discs from the selected one (ALL DISCS) or all the tracks once (1 DISC).

Operations you way want to do during play

To	Do this
Stop playback	Press ■.
Pause	Press ■■.
Resume playing after pause	Press ■■ or ▷.
Go to the next disc	Press DISC SKIP + once. Hold down the button to skip other discs.
Go back to the preceding disc	Press DISC SKIP - once. Hold down the button to skip other discs.
Go to a specific track directly	Press the number button of the track on the remote. When you directly locate a track numbered over 10, press >10 first, then the corresponding number buttons.
Go to a point in a track while monitoring the sound	Press ◀◀ (backward)/▶▶ (forward) on the remote and hold down until you find the point.
Go to a point in a track by observing the display	Press ◀◀ (backward)/▶▶ (forward) on the remote and hold down until you find the point during pause. You will not hear the sound during the operation.
Go to the next track	Turn the ◀◀ AMS ▶▶ dial clockwise by one click.
Go back to the preceding track	Turn the ◀◀ AMS ▶▶ dial counterclockwise by one click.
Stop playing and remove the disc	Press OPEN/CLOSE.

When you turn off the player

The player remembers the last playing disc and the play mode: Continuous (on page 10), Shuffle (on page 15), or Program (on page 16). When you turn on the player again, the player plays the same disc in the same play mode.

Note

If "⌂" appears in the large display, the disc has reached the end while you were pressing ▶▶. Turn the ◀◀ AMS ▶▶ dial counterclockwise or press ◀◀ to go back.

Using the Display

You can check stored disc information, such as the Disc Names (see page 20) or Artist Names (see page 26), by using the display.

Unlike a normal CD, a CD TEXT disc includes information such as the disc title or artist name. The display shows the CD TEXT information so that you can check the current disc title, artist name, and track title. When the player detects a CD TEXT disc, "CD TEXT" appears in the display. If your CD TEXT disc has multi-language capacity, "MULTI CD TEXT" appears in the display. If you want to check the information in another language, refer to "Selecting the language of the CD TEXT information" on page 12.

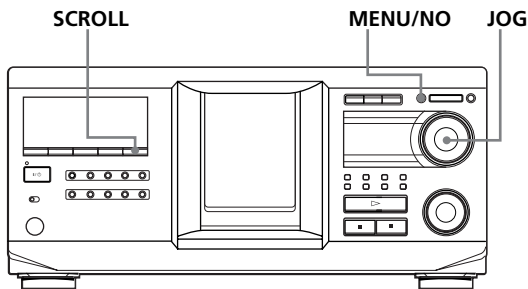

Display information of the normal discs

Display information in stop mode

The display shows the current disc number, total number of tracks, and total playing time of the disc.

Current disc number or Disc Name etc.

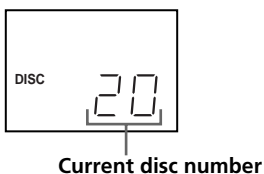
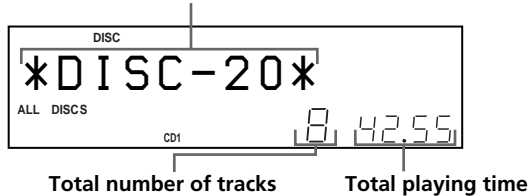

Display information of the playing disc

While playing a disc, the display shows the current disc number, track number, playing time of the track, and the next disc number.

Current disc number or Disc Name etc.

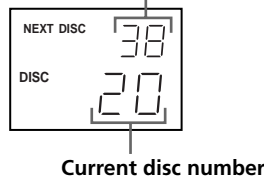
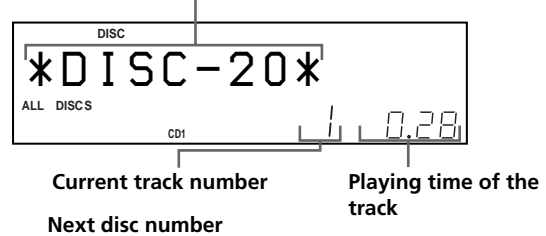

The large display shows up to 13 characters of the information. When you press SCROLL, all the information scrolls in the display.

The information is displayed as follows:

- When the Artist Name is assigned to the current disc
Disc Name/Assigned Artist Name
- When no Artist Name is assigned to the current disc
Disc Name

Display information of CD TEXT discs

Display information in stop mode

The display shows the disc title. When you press SCROLL, the disc title scrolls in the display. When you assign the artist Name (see page 26), the artist name also appears and scrolls in the display.



Display information while playing a disc

The display shows the disc and track title alternately. When you press SCROLL, the disc title and track title scroll in the display.

The display shows up to 13 characters of the information. When you press SCROLL, all the information scrolls in the display.

(continued)

The information is displayed as follows:

- When the Artist Name is assigned to the current disc
Disc title of CD TEXT / Assigned Artist Name
- When no Artist Name is assigned to the current disc
Disc title of CD TEXT / Artist name of CD TEXT

Selecting the language of the CD TEXT information

You can select the language used to display the CD TEXT information when you select a CD TEXT disc with multi-language information.

Once you select the language, the display shows the information in the selected language until you turn off the player. If the player cannot read the language memorized in a CD TEXT disc, "other lang." appears.

- 1 Press MENU/NO in stop mode.
"Select lang.?" flashes.

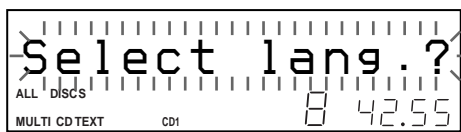

- 2 Push the JOG dial.
The current operating language flashes.

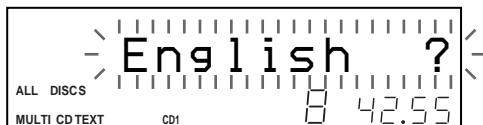

- 3 Turn the JOG dial until the language you want appears in the display.
- 4 Push the JOG dial to select the language.
"Reading text" appears momentarily, then the display shows the information in the selected language.

You can check the current language

- 1 Press MENU/NO while playing a CD TEXT disc.
"Show lang.?" flashes.
- 2 Push the JOG dial.
The current language appears momentarily.
You can also check the current language while selecting a CD TEXT disc without multi-language information.

Note

If you select a CD TEXT disc that does not contain the information of the selected language, the display shows the information in another language according to the disc's priority.

Locating a Specific Disc

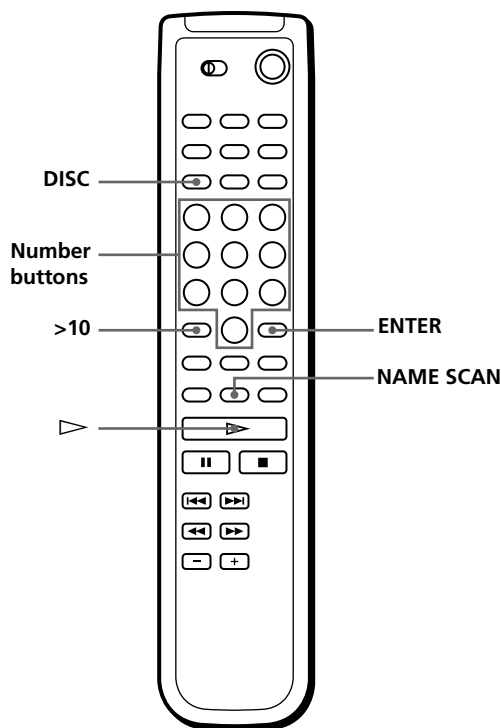
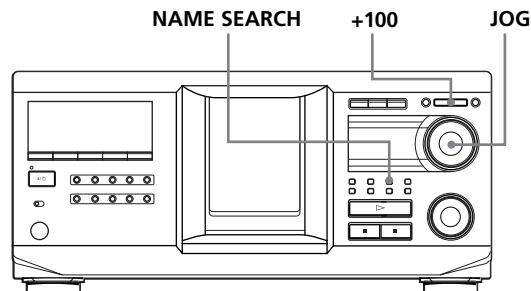

Locating a disc on the player

Turn the JOG dial until the desired disc number or Disc Name (see page 20) appears in the display. Push the JOG dial to start play.

To skip discs quickly

Press +100. Each time you press +100, the player skips 100 discs.

Locating a disc directly using the remote

- 1 Press DISC.
- 2 Press the number button of the disc.
Example: To enter number 35
Press 3 then 5.
To enter number 100
Press 1, then 10/0 twice.
- 3 Press ENTER to start play.

Locating a disc by searching for a specific Disc Name (Name Search)

You can search for and locate a desired disc by the first character of the Disc Name (see page 20). The Name Search function can display the Disc Name in alphabetical order.

- 1 Press NAME SEARCH.
"NAME SEARCH" appears in the display.
- 2 Turn the JOG dial to find the desired disc.
As you turn the JOG dial, the Disc Names starting with the input character appear in the display.

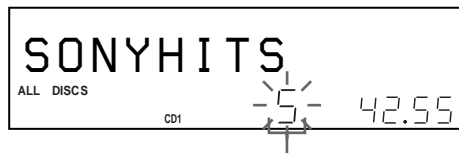

First character

The following characters are displayed as the first character.

A B C D E F G H I J K L M N O P Q R S T U V W X
Y Z 0 1 2 3 4 5 6 7 8 9

If "NOT FOUND" appears in the display while inputting the first character with the JOG dial, no disc has been labeled using the input character.

Notes

- When searching for input characters, blanks and symbols before the first character in the Disc Name are ignored.
- When searching for input characters, upper and lower cases cannot be differentiated.

- 3 Push the JOG dial to select the disc.
In Program Play mode, the disc will be added to the end of the program.

To cancel Name Search

Press NAME SEARCH again.

Note

The Name Search function on the player does not work during ALL DISCS shuffle play.

To locate a disc by scanning each Disc Name (Name Scan)

You can locate a desired disc quickly by scanning the Disc Names (see page 20) in the display.

Note that you cannot use this function in the ALL DISCS Shuffle Play mode.

- 1 Press NAME SCAN.
"NAME SCAN" appears in the display, and the Disc Names scroll in the display.
- 2 Press \triangleright when the Disc Name of the desired disc appears.
The disc is set to the playing position, and the player starts playing.

In Program Play mode, the disc is added to the end of the program if you press ENTER instead of \triangleright .

Note

If "NO ENTRY" appears in the display, no disc has been labeled with the Disc Name. Try the Name Scan function again after labeling the discs.

Specifying the Next Disc to Play

You can specify the next disc to play while playing a disc in Continuous or 1 DISC Shuffle Play mode.

While playing a disc, turn the JOG dial. "NEXT DISC" flashes in the display and the disc number or Disc Name (see page 20) changes as you turn the JOG dial. When the desired disc number or Disc Name appears in the display, stop turning the JOG dial.

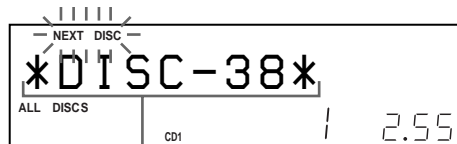

Next disc number or the Disc Name

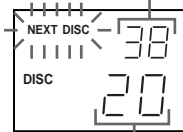

Current disc number

After the current disc is played, the next disc you have specified starts playing.

If you want to skip to the next disc right away, push the JOG dial while playing the current disc.

To cancel the disc you have specified

Press CONTINUE twice.

Playing the Disc Just Inserted (Easy Play)

You can play the disc that was just inserted in slot 1 by pressing only one button.

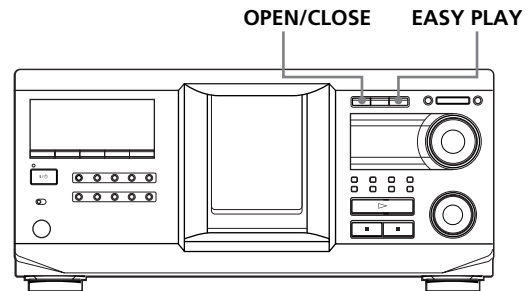

- 1 Open the front cover by pressing OPEN/CLOSE.
- 2 Press EASY PLAY.
Slot 1 moves into loading position.
- 3 Insert the disc in slot 1.
- 4 Press EASY PLAY.
The EASY PLAY button is lit and the player starts playing the disc in slot 1.

Note

The Easy Play function can play only the disc in slot 1.

To cancel the Easy Play function

Press ■.

Playing Discs in Various Modes (Repeat/Shuffle Play)

You can play discs or tracks repeatedly (Repeat Play) in any play mode.

You can also have the player “shuffle” the tracks and play in random order (Shuffle Play). The player shuffles all the tracks on all discs or on the disc you specify.

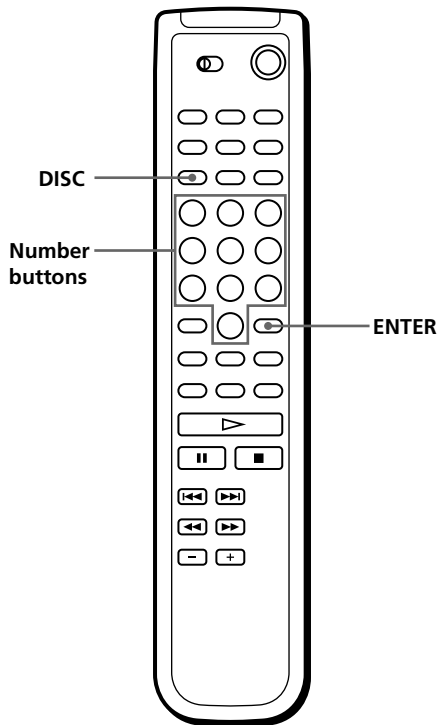
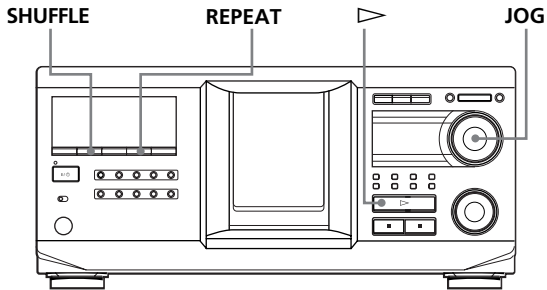

Playing repeatedly (Repeat Play)

Press REPEAT while playing a disc. “REPEAT” appears in the display. The player repeats the discs/tracks as follows:

When the disc is played in	The player repeats
ALL DISCS Continuous Play (page 10)	All tracks on all discs
1 DISC Continuous Play (page 10)	All tracks on the current disc
ALL DISCS Shuffle Play (page 15)	All tracks on all discs in random order
1 DISC Shuffle Play (page 16)	All tracks on the current disc in random order
Program Play (page 16)	The same program

To cancel Repeat Play

Press REPEAT twice.

To repeat the current track

While the track you want is being played, press REPEAT one or more times until “REPEAT 1” appears in the display.

To cancel Repeat 1 Play

Press REPEAT.

Playing all tracks on all discs in random order

- 1 Press SHUFFLE repeatedly until “ALL DISCS” and “SHUFFLE” appear in the display.
- 2 Press ▷. ALL DISCS Shuffle Play starts. “[]” appears in the display while the player is shuffling the discs or the tracks.



Playing all tracks on a specified disc in random order

- 1 Press SHUFFLE repeatedly until "1 DISC" and "SHUFFLE" appear in the display.
- 2 Turn the JOG dial until the desired disc number appears in the display.
When using the remote, first press DISC, then press the number button of the disc.
- 3 Press ▷.
1 DISC Shuffle Play starts.
"1 3" appears in the display while the player is shuffling the tracks.

To cancel Shuffle Play

Press CONTINUE.

 **You can start Shuffle Play while playing**
Press SHUFFLE, and Shuffle Play starts from the current track.

 **You can go to the next disc during 1 DISC Shuffle Play** 
Press DISC SKIP +.

 **You can specify the next disc to play during 1 DISC Shuffle Play**
Turn the JOG dial to specify the next disc. After all the tracks on the current disc are played in random order, the next disc starts playing. If you want to skip to the next disc right away, push the JOG dial while playing the current disc.

Notes

- You cannot specify the next disc to play during ALL DISCS Shuffle Play.
- Even if you press ■ or turn off the player during ALL DISCS Shuffle Play, the player remembers which discs or tracks were played and which were not. Therefore, if you want to start ALL DISCS Shuffle Play again from the beginning, be sure to repeat the procedure from step 1.

Creating Your Own Program (Program Play)

You can arrange the order of the tracks and/or discs to create three different programs that are stored automatically. A program can contain up to 32 "steps." One "step" may contain a track or a whole disc. You can make programs using the controls on the remote or on the player. However, the programming procedures are different.

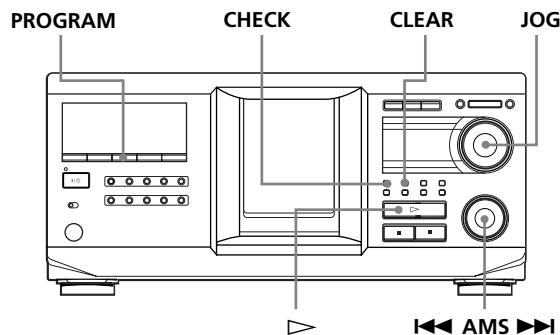

Creating a program on the player

1 Press PROGRAM until the desired program number (PROGRAM 1, 2, or 3) appears in the display.
If a program is already stored in the selected program number, the last step of the program appears in the display. When you want to erase the whole program, hold down CLEAR until "CLEAR" appears in the display (see page 17).

2 Turn the JOG dial until the desired disc number appears in the display.



3 To program a whole disc, skip this step.
Turn the ◀◀ AMS ▶▶ dial until the desired track number appears in the display.

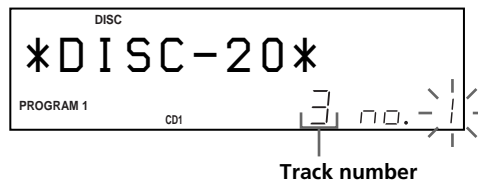

4 Push the JOG dial.

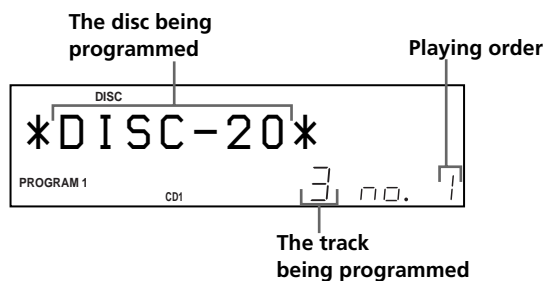

5 To program other discs/tracks, do the following:

To program	Repeat Step(s)
All tracks of another disc(s)	2 and 4
Other tracks on the same disc	3 and 4
Other tracks on other discs	2 to 4

6 Press \triangleright to start Program Play.

To cancel Program Play

Press CONTINUE.

The programs remain even after Program Play ends
When you press \triangleright in Program Play mode, you can play the same program again.

When you press PROGRAM to select Program Play during Continuous or Shuffle Play
The program is played after the current track.

The program remains until erased
Even if you replace discs, the programmed disc and track numbers remain. Therefore, the player will play the new disc and track numbers. However, the programmed disc and track numbers that are not found in the player or on the disc are deleted from the program, and the rest of the program is played in the programmed order.

You can select the program number (PROGRAM 1, 2, or 3) by using the remote
Press PROGRAM on the remote repeatedly until the desired program number appears in the display.

Note

If you select Group Play mode (on page 26), Artist Play mode (on page 28), or Hit List (on page 29), Program Play will be canceled.

Checking the programmed order

You can check your program before or after you start playing.

Press CHECK.

Each time you press this button, the display shows the disc and track number of each step in the programmed order. (When a whole disc is programmed as one step, "AL" appears instead of the track number.) After the last step in the program, the display shows "- END -" and returns to the original display.

Changing the programmed order

You can change your program before you start playing.

To	You need to
Erase a track or disc	Press CHECK until the track or disc you don't want appears in the display, then press CLEAR.
Erase the last track or disc in the program	Press CLEAR. Each time you press the button, the last programmed track or disc will be cleared.
Add tracks or discs to the end of the program	Follow the programming procedure.
Erase the whole program completely	Hold down CLEAR until "CLEAR" appears in the display to erase the whole program, then create a new program following the programming procedure.

Erasing the program stored in memory

- 1 Press PROGRAM repeatedly in stop mode until the program number (PROGRAM 1, 2, or 3) you want to erase appears in the display.
- 2 Press and hold CLEAR until "CLEAR" appears in the display.

Creating a program using the remote

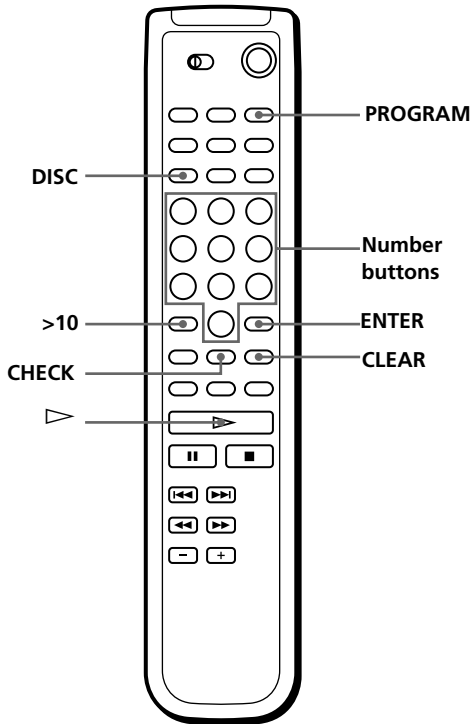

1 Press PROGRAM until the program number you want (PROGRAM 1, 2, or 3) appears in the display.

2 Press DISC.

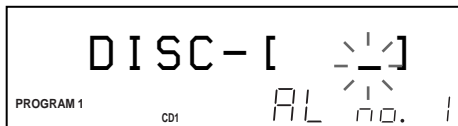

3 Press the number button of the disc.



4 To program a whole disc, press ENTER and go to step 6.



5 First press >10 then press the number button of the track.
When you select the track number less than 10, press 10/0 first, and then press the corresponding number to enter a track number from 1 to 9.

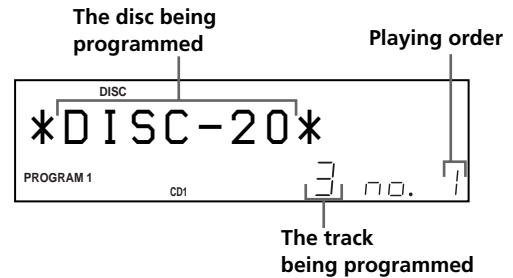



6 To program other discs/tracks, do the following:

To program	Repeat Step(s)
All tracks of another disc(s)	2 to 4
Other tracks on the same disc	5
Other tracks on other discs	2 to 5

7 Press ENTER or ▷ to start Program Play.

To cancel Program Play

Press CONTINUE.

 You can check or change the program by pressing the CHECK or CLEAR button on the remote 
See page 17.

Using the Timer

You can start playing a disc at any given time by connecting a timer (not supplied). Refer also to the instructions for the timer if you need help.

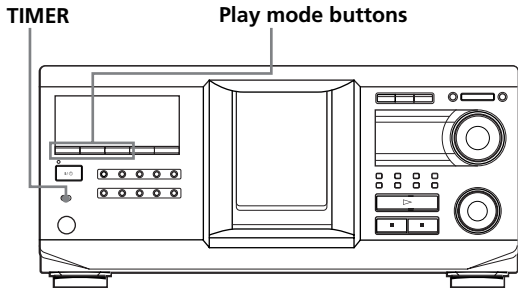

- 1** Press one of the play mode buttons to select the desired play mode.
- 2** Set **TIMER** on the player to **PLAY**.
- 3** Set the timer to the desired time.
The player turns off. When the set time comes, the player turns on and starts playing.
- 4** After you have used the timer, set **TIMER** on the player to **OFF**.

Fading In or Out

You can manually fade the sound in or out to prevent tracks from starting or ending abruptly.

Note that you cannot use this effect when you use the **DIGITAL OUT (OPTICAL)** connector.

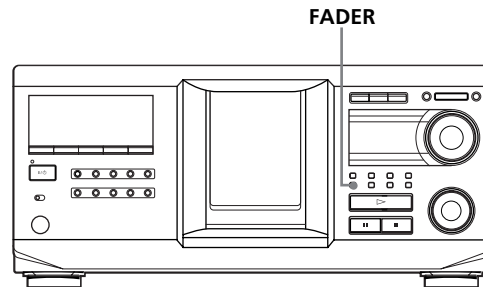

To	Press FADER
Start play fading in	During pause. "FADE" flashes and "FADE IN" appears in the display. The play fades in.
End play fading out	When you want to start fading out. "FADE" flashes and "FADE OUT" appears in the display. The play fades out and the player pauses.

Note

Fading lasts for about 5 seconds.

What You Can Do With the Custom Files

The player can store four types of information called "Custom Files" for each disc. Once you have stored Custom Files for a disc, the player automatically recalls what you have stored whenever you select the disc. Note that Custom Files are erased if you do not use the player for about one month.

You can store this information:

When you use	You can
Disc Name (page 20)	Label discs using up to 20 characters
Delete Bank (page 24)	Delete unwanted tracks and store only the tracks you want
Group File (page 24)	Group discs in up to eight groups, to locate them easily
Artist File (page 26)	Classify discs according to an artist name

Where are Custom Files stored?

Custom Files are stored not on the disc, but in the player's memory. Therefore you cannot use Custom Files when you play the disc on other players.

If you replace discs with Custom Files

The Custom File information you have stored remains, since the Custom File information is assigned to each slot. Erase all the Custom Files (Disc Name, Delete Bank, Group File, and Artist File) of the old disc, and then file the new disc information in the Custom Files.

Erasing all Custom Files of all discs

- 1 Press MENU/NO.
- 2 Turn the JOG dial until "ALL ERASE ?" appears.
- 3 Push the JOG dial.
"ALL ERASE ??" flashes.
- 4 Push the JOG dial.
"ALL ERASE" appears in the display, and all Custom Files are erased.

Note

When you perform the operation as described above, all of your own settings are deleted and the original factory settings are restored.

Labeling Discs (Disc Name)

You can label discs using up to 20 characters and have the player display the Disc Name each time you select the disc. The Disc Name can be anything you like, such as a title, musician's name, category, or date of purchase. You can also label the discs in the second player.

💡 When you select a CD TEXT disc

The disc title is automatically stored as the Disc Name. If the disc title has more than 20 characters, only the first 20 characters of the disc title are stored (see page 11). When you replace a disc with a CD TEXT disc, the disc title of the CD TEXT disc is also stored automatically. Note that you cannot change the Disc Name of a CD TEXT disc.

💡 You can label discs while the front cover is open

Labeling discs on the player

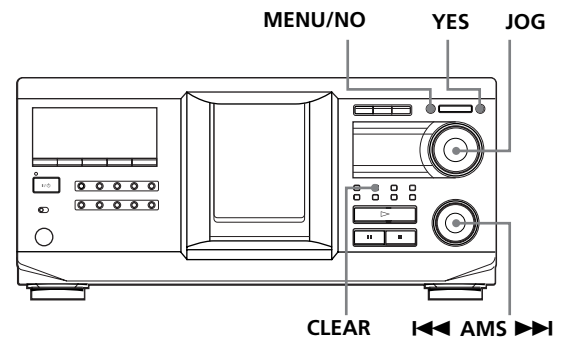

- 1 Turn the JOG dial until the disc number to which you want to assign a Disc Name appears in the display.
When you label a disc with the front cover closed, the disc number of the disc at the playing position appears.
When you label a disc with the front cover open, the disc number at the loading position appears.
- 2 Press MENU/NO.
"NAME IN ?" flashes.
- 3 Push the JOG dial.
The flashing cursor (▣) appears.

- 4** Turn the JOG dial until the desired character appears in the display. The cursor disappears and the first space for the Disc Name flashes. As you turn the JOG dial clockwise, the characters appear in the following order. Turn the JOG dial counterclockwise to go in reverse order.

(space) A B C D E F G H I J K L M N O P Q R S T U
 V W X Y Z a b c d e f g h i j k l m n o p q r s t u v w
 x y z 0 1 2 3 4 5 6 7 8 9 ! " # \$ % & ' () * + , - . / : ; <
 = > ? @ _



- 5** Push the JOG dial to select the character. The selected character lights up, and the flashing cursor appears at the next space to be input.

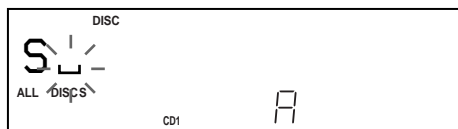

To make a correction

Press CLEAR and begin again by inputting the correct characters.

- 6** Repeat steps 4 and 5 to input more characters.
7 Press YES to store the Disc Name. The display shows the Disc Name.



Repeat steps 1 to 7 to assign Disc Names to other discs.

To change the character type quickly while inputting characters

Press SCROLL in step 4 above. The character on the cursor changes to the first character of each character type. Each time you press SCROLL, the character type changes as follows:

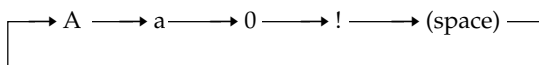

Changing the Disc Name

- 1** Follow steps 1 to 3 in “Labeling discs on the player” on page 20 to select the Disc Name you want to change.
2 Turn the ◀◀ AMS ▶▶ dial to move the cursor to the position you want to change. When the cursor position is on a character, the character flashes but when the cursor position is on a blank space, the cursor (␣) appears in the display.

To change characters

Turn the JOG dial until the desired character appears in the display.

To add characters

Push the JOG dial. The new blank space appears next to the selected character, then turn the JOG dial until the desired character appears in the display.

To erase characters

Press CLEAR. The selected character disappears.

To erase all characters for the current Disc Name

Turn the ◀◀ AMS ▶▶ dial to move the cursor to the first character, then press and hold CLEAR until all the characters are erased.

- 3** Repeat step 2 to change more characters.
4 Press YES to store the Disc Name.

Erasing the Disc Name

- 1** Follow steps 1 to 3 in “Labeling discs on the player” on page 20 to select the Disc Name you want to erase.
2 Turn the ◀◀ AMS ▶▶ dial to move the cursor to the first character, then press and hold CLEAR until all the characters are erased.
3 Press YES. The Disc Name disappears.

Storing Information About CDs (Custom Files)

Labeling discs using the remote

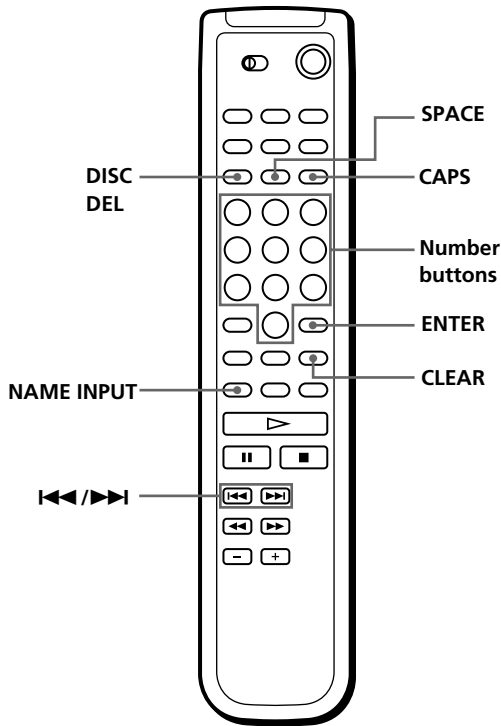

- 1 Press DISC.
- 2 Press the number button of the disc you want to label, then press ENTER.
- 3 Press NAME INPUT.
The flashing cursor () appears.
- 4 Press CAPS to find the desired letter type.
Each time you press the button, the letter type changes cyclically among capital letters (A), small letters (a), and numbers (1). To select a symbol, select the capital or small letter type. The selected letter type appears in the display.

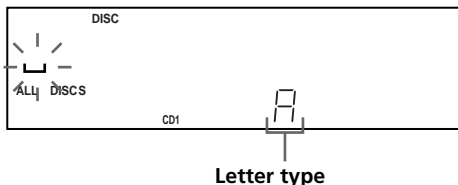

- 5 To input a letter, press the number button corresponding to the desired letter (indicated beside each number button).
The cursor disappears and the first space for the Disc Name flashes.
Each time you press the button, the letter changes cyclically among the ones indicated beside the button.

To input symbols, press the number button 1 repeatedly until the desired symbol appears in the display.

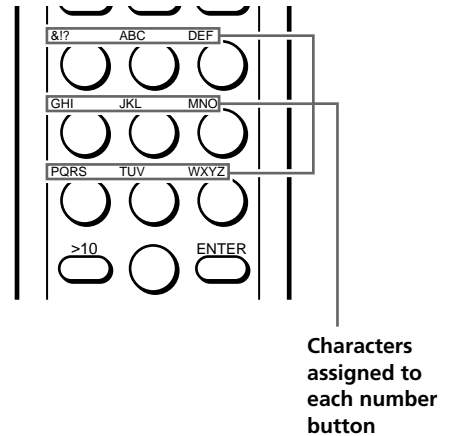

Example: To select the letter E
Press the number button 3 twice.

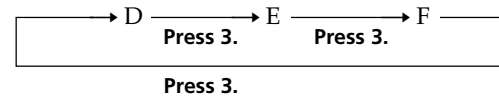

To insert a space, press SPACE once.

To input a number, press CAPS twice to change the letter type, then press the desired number button.

- 6 Press  to select the character.
The selected character lights up, and the flashing cursor appears at the next space to be input.
You can also go to the next space by pressing other number buttons.
- 7 Repeat Steps 4 through 6 to input more characters.
- 8 Press ENTER to store the Disc Name.
The Disc Name lights up in the display.



Repeat Steps 1 through 8 to assign Disc Names to other discs.

💡 If you make a mistake while inputting the character(s)

To correct a character that was input

- 1 Press **◀** or **▶** until the cursor moves to the incorrect character.



- 2 Press DEL to delete the incorrect character.



- 3 Input the correct character.



To correct the character currently being input

- 1 Press DEL to delete the incorrect character.
- 2 Input the correct character.

To insert a character(s) between the input characters

Press **◀** or **▶** until the cursor moves next to the point you want to insert, and enter the character(s).

Storing Custom File Information Using a Keyboard

You can store the Disc Name for each disc, one by one, using an IBM-compatible PC keyboard* (not supplied).

* The keyboard's power consumption must be 120 mA or less.

Keyboard jack

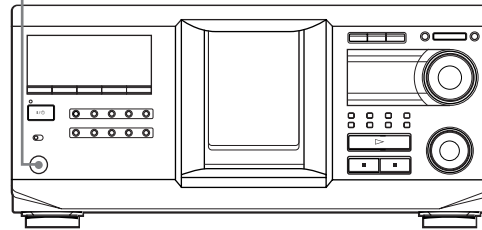

- 1 Connect a keyboard to the keyboard jack on the front panel of the player.

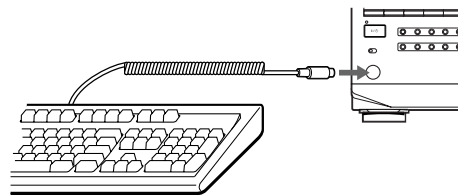

- 2 After selecting the desired disc on the player, press the Enter key.
- 3 Input the desired characters, then press the Enter key to store the information.

💡 You can delete all characters of a selected item
While holding down the Shift key, press the Delete key.

Notes

- If the cursor keys do not work correctly and you cannot complete the task using the keyboard, disconnect the keyboard then reconnect it to the player and try again.
- If the keyboard is not a USA model (shown below), the characters may be input differently from those on the keys.

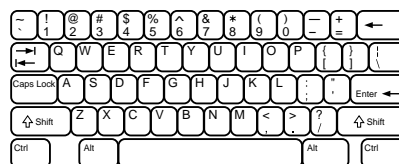

Storing Specific Tracks (Delete Bank)

You can delete unwanted tracks and store only the tracks you want. When you select the disc containing a Delete Bank, the player will play only the remaining tracks.

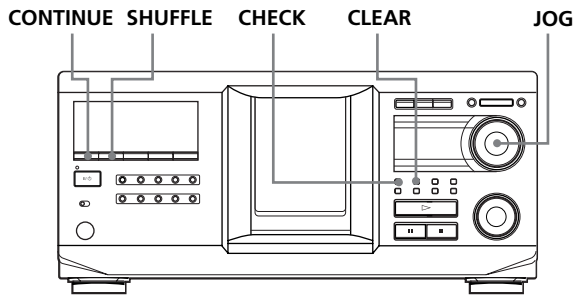

- 1 Press CONTINUE or SHUFFLE before you start playing.
- 2 Turn the JOG dial to select the disc.
- 3 Press CHECK repeatedly until the track you want to delete appears in the display.



- 4 Press CLEAR. "DELETE" and "OFF" appear in the display.



If you want to recover the track, press CLEAR again.

- 5 Repeat steps 3 and 4 to delete more tracks.

💡 You can recover all the tracks you have deleted
Hold down CLEAR until "ALL ON" appears in the display.

Note

The deleted tracks are skipped even in Shuffle or Program Play modes (when the whole disc containing a Delete Bank is programmed as one step).

Grouping Discs (Group File)

You might find that too many discs make it hard to find the disc you want. This player has a feature that lets you classify discs into eight groups. Each disc can be put into only one group.

Once you classify discs, you can enjoy Continuous, Shuffle, or Repeat Play within a certain group (Group Play).

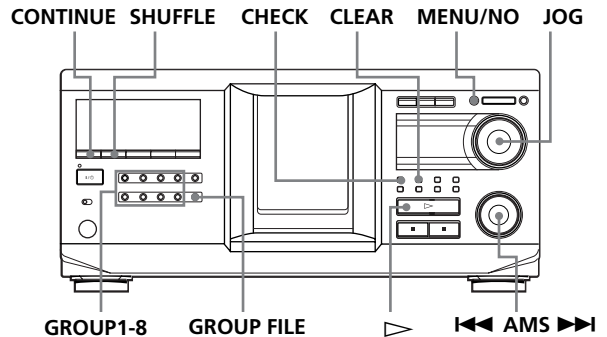

Assigning discs to groups

- 1 Press CONTINUE or SHUFFLE before you start playing.
- 2 Turn the JOG dial to select the disc you want to assign to a group.
- 3 Press GROUP FILE. "Select G1-G8" appears in the display.
- 4 Press one of the GROUP1-8 buttons to which you want to assign the disc. "GROUP FILE" and the group number appear in the display and the disc is assigned to that group.

Deleting discs from a group

- To delete a disc from a group
 - 1 Turn the JOG dial until the disc number you want to delete from the group appears in the display.
 - 2 Press GROUP FILE. "Select G1-G8" appears in the display.
 - 3 Press CLEAR. "GROUP ERASE" appears in the display.
- To delete all discs from a group, press CLEAR while holding down whichever GROUP1-8 button you want to clear.

Labeling groups (Group Name)

You can label the preset group number anything you like, such as a category, using up to 13 characters. Note that you cannot store the Group Name if you have not assigned any disc to the group.

- 1 Press MENU/NO.
"NAME IN ?" flashes.
- 2 Turn the JOG dial until the group number you want to label appears in the display, and then push the JOG dial.
The flashing cursor (▬) appears.

- 3 Turn the JOG dial until the desired character appears in the display.
The cursor disappears and the first space for the Group Name flashes.
As you turn the JOG dial clockwise, the characters appear in the following order. Turn the JOG dial counterclockwise to go in reverse order.

(space) A B C D E F G H I J K L M N O P Q R S T U
V W X Y Z a b c d e f g h i j k l m n o p q r s t u v w
x y z 0 1 2 3 4 5 6 7 8 9 ! " # \$ % & ' () * + , - . / : ; <
= > ? @ _

- 4 Push the JOG dial to select the character.
The selected character lights up, and the flashing cursor appears at the next space to be input.

To make a correction

Press CLEAR and begin again by inputting the correct characters.

- 5 Repeat steps 3 and 4 to input more characters.
See also "Labeling discs on the player" on page 20 for details.
- 6 Press YES to store the Group Name.

Changing the Group Name

- 1 Follow steps 1 and 2 in "Labeling groups (Group Name)" on page 25 to select the Group Name you want to change.
- 2 Turn the ◀◀ AMS ▶▶ dial to move the cursor to the position you want to change.
When the cursor position is on the character, the character flashes, and when the cursor position is on a blank space, the cursor (▬) appears in the display.

To change characters

Turn the JOG dial until the desired character appears in the display.

To add characters

Push the JOG dial. The new blank space appears next to the selected character, then turn the JOG dial until the desired character appears in the display.

To erase characters

Press CLEAR. The selected character disappears.

- 3 Repeat step 2 to change more characters.
- 4 Press YES to store the Group Name.

Erasing a Group Name

- 1 Follow steps 1 and 2 in "Labeling groups (Group Name)" on page 25 to select the Group Name you want to erase.
- 2 Press and hold CLEAR until all the characters are erased.
- 3 Press YES.
The Group Name is erased.

Playing discs in a group on the player (Group Play)

You can enjoy Continuous or Shuffle Play within a group.

- 1 Select the desired play mode before you start playing.

When you select	The player plays
ALL DISCS Continuous Play	All tracks on all discs in the group consecutively
1 DISC Continuous Play	All tracks on the specified disc in the group consecutively
ALL DISCS Shuffle Play	All tracks on all discs in the group in random order
1 DISC Shuffle Play	All tracks on the specified disc in the group in random order

- 2 Press one of the GROUP1-8 buttons to select the group and press \triangleright .
Group Play starts from the disc with the lowest number and located closest to the playing position. If the disc at the playing position is put into the selected group, the play starts from that disc.

To cancel Group Play

Press the GROUP1-8 button that was selected. "GROUP OFF" appears in the display.

During Group Play, you can locate a desired disc within a group by scanning or searching for Disc Names

See "Locating a disc by searching for a specific Disc Name (Name Search)" on page 13, or "To locate a disc by scanning each Disc Name (Name Scan)" on page 13.

You can specify the disc to play when starting Group Play

After selecting the group, turn the JOG dial to select the disc, then push the JOG dial.

Note

If "NO ENTRY" appears in the display, no disc has been put into the selected group.

Classifying Discs According to Artist Name (Artist File)

You can classify discs by storing Artist Names into the player and assigning them to each disc. Each Artist Name can use up to 20 characters. Once you assign an Artist Name to a disc, you can enjoy Continuous, Shuffle, or Repeat Play within discs assigned same Artist Name and you can search for the desired disc easily. You can also store a category name instead of an Artist Name. Up to 200 Artist Names can be stored.

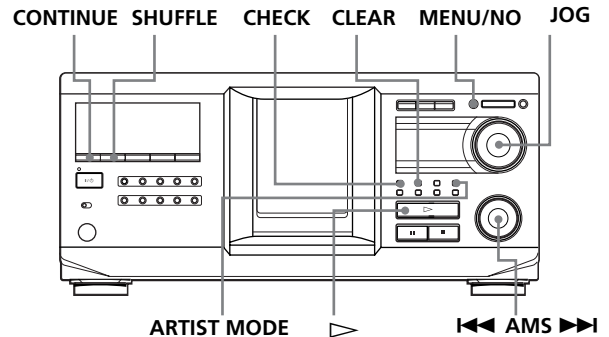

Storing the Artist Name

- 1 Press MENU/NO.
- 2 Turn the JOG dial until "ART.NAME IN?" appears in the display.
- 3 Push the JOG dial.
"New Artist" flashes.
- 4 Push the JOG dial.
The flashing cursor (▣) appears.
- 5 Turn the JOG dial until the desired character appears in the display.
The cursor disappears and the first space for the Artist Name flashes.
As you turn the JOG dial clockwise, the characters appear in the following order. Turn the JOG dial counterclockwise to go in reverse order.

(space) A B C D E F G H I J K L M N O P Q R S T U
V W X Y Z a b c d e f g h i j k l m n o p q r s t u v w
x y z 0 1 2 3 4 5 6 7 8 9 ! " # \$ % & ' () * + , - . / : ; <
= > ? @ _

- 6** Push the JOG dial to select the character.
The selected character lights up, and the flashing cursor appears to indicate the next space to be input.
To make a correction
Press CLEAR and begin again by inputting the correct characters.
- 7** Repeat steps 5 and 6 to input more characters.
See also "Labeling discs on the player" on page 20 for details.
- 8** Press YES to store the Artist Name.

Changing the Artist Name

- 1** Follow steps 1 to 3 in "Storing the Artist Name" on page 26.
- 2** Turn the JOG dial until the artist name you want to change appears in the display, then push the JOG dial.
- 3** Turn the ◀◀ AMS ▶▶ dial to move the cursor to the position you want to change.
When the cursor position is on the character, the character flashes, and when the cursor position is on a blank space, the cursor (▢) appears in the display.
To change characters
Turn the JOG dial until the desired character appears in the display.
To add characters
Push the JOG dial. The new blank space appears next to the selected character, then turn the JOG dial until the desired character appears in the display.
To erase characters
Press CLEAR. The selected character disappears.
- 4** Repeat step 3 to change more characters.
- 5** Press YES to store the Artist Name.

You can also erase the Artist Name while assigning the Artist Name

- 1** In step 2 above, turn the JOG dial until the Artist Name you want to erase appears in the display, then push the JOG dial.
- 2** Press and hold CLEAR until the Artist Name is erased.
- 3** Press YES.
The Artist Name and "ARTIST ERASE?" appears alternately in the display.
- 4** Press YES.
The Artist Name is erased.

Erasing the Artist Name

- 1** Press MENU/NO.
- 2** Turn the JOG dial until "ARTIST FILE?" appears in the display.
- 3** Push the JOG dial.
- 4** Turn the JOG dial until the desired Artist Name appears in the display.
- 5** Press and hold CLEAR for a few seconds.

Note

When you erase the Artist Name, the Artist File of the Artist Name is also erased.

Assigning an Artist Name to a disc (Artist File)

- 1** Turn the JOG dial to select the disc you want to assign an Artist Name.

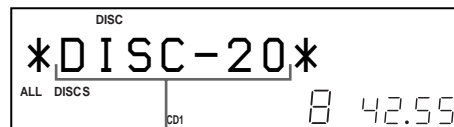

The disc to be assigned the artist name.

- 2** Press MENU/NO.
- 3** Turn the JOG dial until "ARTIST FILE?" appears in the display.
- 4** Push the JOG dial.
- 5** Turn the JOG dial until the desired Artist Name appears in the display.
The Artist Names are displayed in alphabetical order.



- 6** Press the JOG dial to assign the Artist Name.

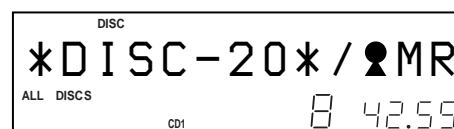



You can assign an Artist Name to a disc while the front cover is open

Note

You cannot assign an Artist Name to a disc when no Artist Name is stored. In this case, "ARTIST FILE" does not appear in the display in step 3 above.

Removing the Artist Name from the disc

- 1** Turn the JOG dial to select the desired disc.
- 2** Press MENU/NO.
- 3** Turn the JOG dial until "ARTIST FILE?" appears in the display.
- 4** Push the JOG dial.
- 5** Turn the JOG dial counterclockwise until "FILE ERASE?" appears in the display, then push the JOG dial.
The assigned Artist Name is removed from the selected disc.

Playing discs assigned the same Artist Name (Artist Play)

You can enjoy Continuous or Shuffle Play within discs that are assigned the same Artist Name.

- 1** Select the desired play mode before you start playing.

When you select	The player plays
ALL DISCS Continuous Play	All tracks on all discs assigned same artist name consecutively
1 DISC Continuous Play	All tracks on the specified disc assigned same artist name consecutively
ALL DISCS Shuffle Play	All tracks on all discs assigned same artist name in random order
1 DISC Shuffle Play	All tracks on the specified disc assigned same artist name in random order

- 2** Press ARTIST MODE.
ARTIST MODE flashes.
- 3** Turn the JOG dial to select the desired Artist Name.
- 4** Push the JOG dial.
ARTIST MODE lights up.
- 5** Turn the JOG dial to select the desired disc, then push the JOG dial.
Artist play starts.

To cancel Artist Play

Press ARTIST MODE so that ARTIST MODE goes off.



You can specify the disc to play when starting Artist Play

After selecting the Artist Name, turn the JOG dial to select the disc, then push the JOG dial.

Note

You cannot select an Artist Name if no discs are assigned to that Artist Name.

Storing Your Favorite Tracks (Hit List)

You can store the tracks you play frequently and select those tracks by checking the track numbers or titles (see page 29) in the Hit List.
You can put up to 32 tracks in the Hit List.

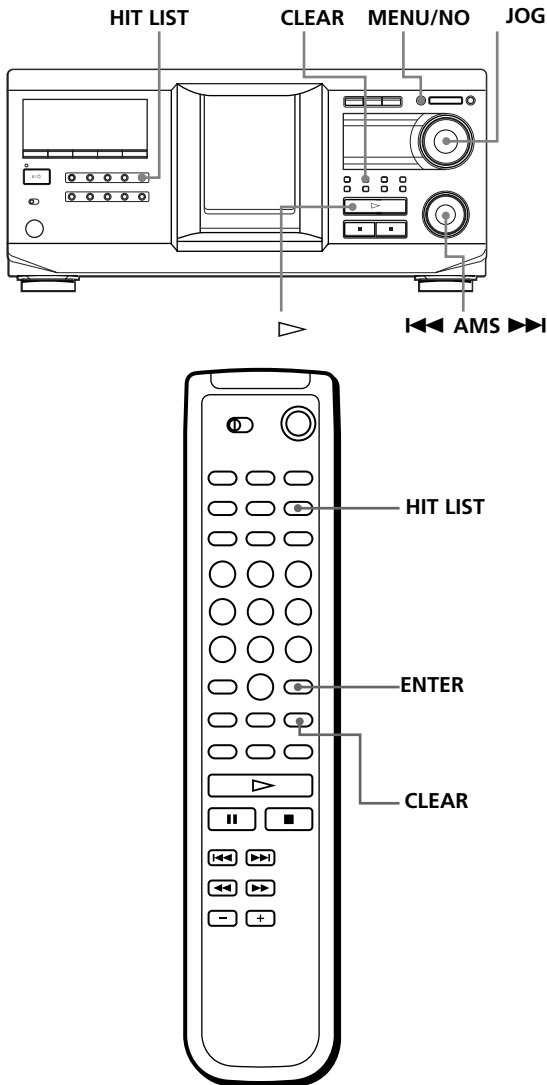

Playing tracks in the Hit List

- 1 Press HIT LIST before you start playing.
The HIT LIST button lights up and "HIT LIST" appears in the display.
- 2 Turn the JOG dial or the ◀◀ AMS ▶▶ dial until the desired track appears in the front panel display.
- 3 Push the JOG dial or press ▶ to start playing.
When using the remote, press ENTER.



The Hit List remains until erased

Even if you replace discs, the Hit List you create remains. Therefore, the player will substitute the new tracks into the Hit List.

Notes

- The track you select in step 2 will be listed as the first track in the Hit List, and you cannot arrange the order of the tracks in the Hit List.
- When you play tracks in the Hit List, the Group, Artist, or Program play is canceled.

Deleting tracks from the Hit List

- 1 Follow steps 1 and 2 in "Playing tracks in the Hit List" on page 29.
- 2 Press CLEAR.
The selected track is deleted from the Hit list.

To delete all the tracks of the Hit List

When the HIT LIST button lights up, press and hold CLEAR while in stop mode until "CLEAR" appears.

Putting tracks into the Hit List

Press HIT LIST while playing your favorite track. The "HIT" indication and "List in" appear in the display.

Notes

- When you input the 33rd track into the Hit List, the 32nd track will be replaced.
- You cannot store tracks from the second CD player.

Labeling tracks in the Hit List (Hit Title)

You can label tracks in the Hit List in either of the two methods described below.

To label tracks while in play mode

1 Press MENU/NO while playing a track in the Hit List.
“HIT NAME ?” appears in the display.

2 Push the JOG dial.
The flashing cursor (▣) appears in the display.

3 Turn the JOG dial until the desired character appears in the display.
The selected character for the Hit Title flashes.
As you turn the JOG dial clockwise, the characters appear in the following order. Turn the JOG dial counterclockwise to go in reverse order.

(space) A B C D E F G H I J K L M N O P Q R S T U
V W X Y Z a b c d e f g h i j k l m n o p q r s t u v w
x y z 0 1 2 3 4 5 6 7 8 9 ! " # \$ % & ' () * + , - . / : ; <
= > ? @ _

4 Push the JOG dial to select the character.
The selected character lights up, and the flashing cursor appears at the next space to be input.

To make a correction

Press CLEAR and begin again by inputting the correct characters.

5 Repeat steps 3 and 4 to input more characters.
See also “Labeling discs on the player” on page 20 for details.

6 Press YES to store the Hit Title.

To label tracks while in stop mode

1 While the HIT LIST button is lit, select the track you want to label by turning the JOG dial or the ◀◀ AMS ▶▶ dial.

2 Press MENU/NO.
The flashing cursor (▣) appears in the display.

3 Follow steps 3 to 6 in “To label tracks while in play mode” to input the characters.



You can store a CD TEXT disc's track titles in the Hit List

The CD TEXT disc's track title is stored as a Hit Title automatically when the track is put into the Hit List.

Controlling Another CD Player (Advanced Mega Control)

This unit can control a second CD player (see "Connecting another CD player" on page 6). Even when a second CD player is connected, the controls on both of the units will function. When you press the play button on either unit, the operating player stops and the idle player starts. Make sure that "2nd DETECTED" appears in this player's display after turning on both players. Note that, depending on the player, you may not be able to operate all the functions of the second CD player.

The controls indicated in the illustration below are effective while the MEGA CONTROL button is lit. To operate the master player, press MEGA CONTROL so that the MEGA CONTROL button goes off, and to operate the second player, press MEGA CONTROL so that the MEGA CONTROL button lights up.

Play mode buttons
(CONTINUE/SHUFFLE/
PROGRAM/REPEAT)

MEGA CONTROL MENU/NO JOG

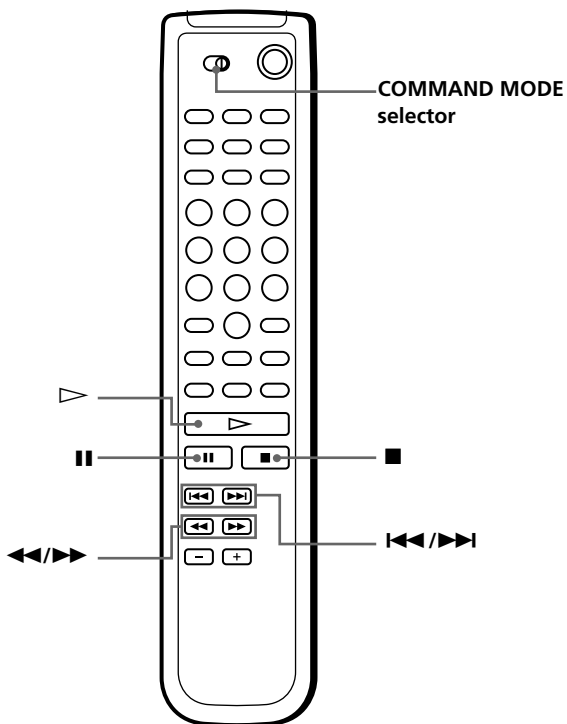
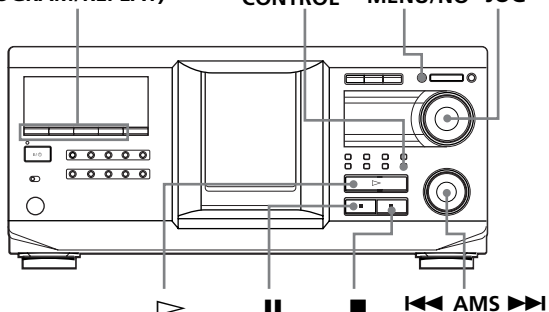

- 1 Press MEGA CONTROL on this player. The MEGA CONTROL button and "2nd" in the display light up. The display shows the current disc number or Disc Name of the second player.

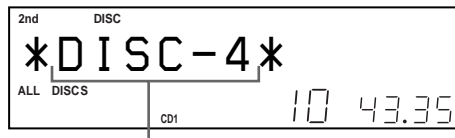

Current disc number or the Disc Name

- 2 Select the desired play mode. To program tracks, use the controls on the second player.
- 3 Press ▷ on this player to start playing. The play starts and the display shows the current disc, track numbers, and the playing time of the track. While the MEGA CONTROL button is lit, you can control the second player with the controls on this player.

To control the master player again

Press MEGA CONTROL. The MEGA CONTROL button goes off and you can control the master player.

To control the second player directly using the supplied remote

Set CD 1/2/3 on the remote to CD 3 which is the same position as the COMMAND MODE selector on the rear panel of the second player.

Loading the Disc Names of the second CD player

If the second CD player has the Disc Name function (see page 20), you can load the Disc Names of the second CD player into this player's memory and display them on this player.

- 1 Press MENU/NO.
- 2 Turn the JOG dial until "LOAD 2ndNAME?" flashes in the display.

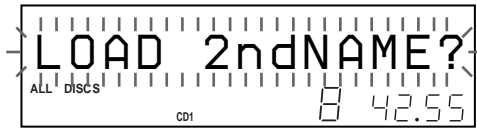

- 3 Push the JOG dial.
This player starts loading. (Loading takes about one minute.)

Labeling discs of the second CD player

You can label discs of the second CD player or change the Disc Names loaded from the second CD player.

- 1 Press MEGA CONTROL.
The MEGA CONTROL button lights up.
- 2 Turn the JOG dial to select the disc you want to assign a Disc Name to.
If the disc slot you select does not contain a disc, "NO DISC" appears in the display and you cannot assign a Disc Name.
- 3 Press MENU/NO.
"NAME IN?" appears.
- 4 Push the JOG dial.
- 5 Input the new Disc Name following the procedure in "Labeling discs (Disc Name)" on page 20.

Note

The new Disc Names are stored on this player's memory, so you cannot display them on the second CD player.

Playing Alternately (No-Delay Play/X-Fade Play)

When you connect a second player, you can play tracks in this player and those from the second player alternately from any play mode (see "Connecting another CD player" on page 6).

Select one of the following methods:

- **No-Delay Play:** The current player changes at each track. Each time the current player changes to the other player, the other player starts play without a break in sound immediately after the current player ends play. The other player skips the lead-in portion and starts playing from where the sound actually begins.
- **X-Fade Play:** The current player changes at each track or at the specified interval. You can select the interval, 30, 60, or 90 seconds. Each time the current player changes to the other player, the sound from both players is mixed. The current player ends play by fading out, and the other player starts play by fading in.

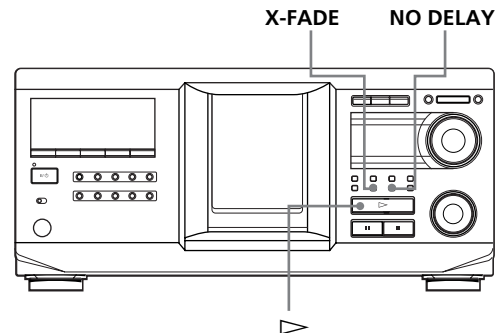

- 1 Select the desired disc and play mode for each player.
- 2 **When you select No-Delay Play**
Press NO DELAY.
"NO DELAY" appears in the display.

When you select X-Fade Play

Press X-FADE.

"X-FADE" appears in the display.

Each time you press the X-FADE button, the indication appears as follows:

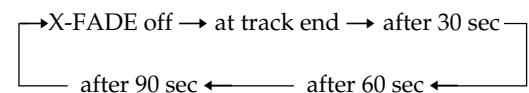

To change the current player each time a whole track is finished, select "at track end."

To change the current player at the specified interval, press X-FADE repeatedly until the interval you want appears in the display.

- Press \triangleright to start playing.
The MEGA CONTROL button lights up when a track in the second player is selected.

To cancel No-Delay/X-Fade Play

Press the corresponding button repeatedly until "NO DELAY" or "X-FADE" disappears from the display. The current player continues playing.



You can change the method (No-Delay or X-Fade) during play

Press the corresponding button (NO DELAY or X-FADE) following the procedure in step 2.



You can start X-Fade at any point of the track

Press FADER during X-Fade Play.
Even after you have set the X-Fade mode and started X-Fade play, you can start X-Fade manually at any point you like. Note that you cannot do this operation while the sound from both players is mixed.

Notes

- Play starts from the second player if you start play while the MEGA CONTROL button is lit.
- When one player has played all the discs or tracks in the player ahead of the other player, play stops.
- Do not use the controls on the second player during No-Delay/X-Fade Play. They may not work correctly.

Controlling the Player by Another Unit

Controlling the player by another unit

When you connect the player to a Sony MD deck compatible with the Mega Control function, or operate a Sony MD deck by using computer software such as "MD Editor," you must set the player as shown below:

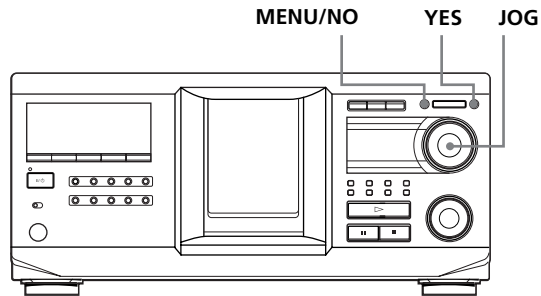

- Press MENU/NO.
- Turn the JOG dial until "CONTROL A1 ?" appears in the display window.
- Press YES.

To return to normal setting

After following steps 1 and 2, and "CONTROL A1II ?" is displayed, then press YES.

Notes

- You can perform the operation above correctly only when you operate Disc 1 to Disc 200.
- You cannot operate this player correctly from another player that does not have the CONTROL A1II jack. In this case, operate the other player from this player.

Precautions

On safety

- Caution — The use of optical instruments with this product will increase eye hazard.
- Should any solid object or liquid fall into the cabinet, unplug the player and have it checked by qualified personnel before operating it any further.

On power sources

- Before operating the player, check that the operating voltage of the player is identical with your local power supply. The operating voltage is indicated on the nameplate at the rear of the player.
- The player is not disconnected from the AC power source (mains) as long as it is connected to the wall outlet, even if the player itself has been turned off.
- If you are not going to use the player for a long time, be sure to disconnect the player from the wall outlet. To disconnect the AC power cord (mains lead), grasp the plug itself; never pull the cord.
- The AC power cord must be changed only at a qualified service shop.

On placement

- Place the player in a location with adequate ventilation to prevent heat build-up in the player.
- Do not place the player on a soft surface such as a rug that might block the ventilation holes on the bottom.
- Do not place the player in a location near heat sources, or in a place subject to direct sunlight, excessive dust or mechanical shock.

On operation

- If the player is brought directly from a cold to a warm location, or is placed in a very damp room, moisture may condense on the lenses inside the player. Should this occur, the player may not operate properly. In this case, leave the player turned on for about an hour until the moisture evaporates.

On adjusting volume

- Do not turn up the volume while listening to a portion with very low level inputs or no audio signals. If you do, the speakers may be damaged when a peak level portion is played.

On cleaning

- Clean the cabinet, panel and controls with a soft cloth slightly moistened with a mild detergent solution. Do not use any type of abrasive pad, scouring powder or solvent such as alcohol or benzine.

On transportation

- When transporting the player, open the front cover then remove all the discs from the player and turn the power off.

If you have any questions or problems concerning your player, please consult your nearest Sony dealer.

Notes on CDs

On handling CDs

- To keep the disc clean, handle the disc carefully.
- Do not stick paper or tape on the disc.

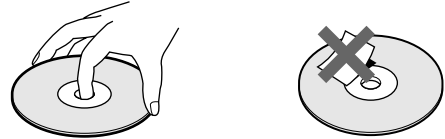

- Do not expose the disc to direct sunlight or heat sources such as hot air ducts, nor leave it in a car parked in direct sunlight as there can be considerable rise in temperature inside the car.
- After removing a disc from the disc slot, store the disc in its case.

On cleaning

- Before playing, clean the disc with a cleaning cloth. Wipe the disc from the center out.

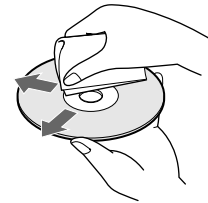

- Do not use solvents such as benzine, thinner, commercially available cleaners or anti-static spray intended for vinyl LPs.

Troubleshooting

If you experience any of the following difficulties while using the player, use this troubleshooting guide to help you remedy the problem. Should any problem persist, consult your nearest Sony dealer.

There's no sound.

- ➔ Check that the player is connected securely.
- ➔ Make sure you operate the amplifier correctly.

The CD does not play.

- ➔ There's no CD inside the player ("–NODISC–" appears). Insert a CD.
- ➔ Insert the CD with the label side facing right.
- ➔ Clean the CD (see page 34).
- ➔ Moisture has condensed inside the player.
Remove the disc and leave the player turned on for about an hour (see page 34).

The remote does not function.

- ➔ Remove obstacles in the path of the remote and the player.
- ➔ Point the remote at the remote sensor  on the player.
- ➔ Be sure to set up the remote correctly.
- ➔ Replace all the batteries in the remote with new ones if they are weak.
- ➔ Set the command mode of the remote according to the command mode of the player.

The player functions incorrectly.

- ➔ The microcomputer chips may be operating incorrectly. Disconnect the AC power cord, then connect it back to the wall outlet to reset the player.

Specifications

Compact disc player

Laser	Semiconductor laser ($\lambda = 780 \text{ nm}$) Emission duration: continuous
Laser output	Max 44.6 μW * * This output is the value measured at a distance of 200 mm from the objective lens surface on the Optical Pick-up block with 7 mm aperture.
Frequency response	2 Hz to 20 kHz $\pm 0.5 \text{ dB}$
Dynamic range	More than 93 dB
Harmonic distortion	Less than 0.0045%

Output

	Jack type	Maximum output level	Load impedance
LINE OUT	Phono jacks	2 V (at 50 kilohms)	Over 10 kilohms
DIGITAL OUT (OPTICAL)	Optical output connector	-18 dBm	Wave length: 660 nm

General

Power requirements	120 V AC, 60 Hz
Power consumption	16 W
Dimensions (approx.) (w/h/d)	430 × 189 × 537 mm (17 × 7 1/2 × 21 1/4 in.) incl. projecting parts
Mass (approx.)	8.8 kg (19 lbs 7 oz.)

Supplied accessories

See page 4.

Design and specifications are subject to change without notice.

Index

A, B

- Advanced Mega Control 31
- AMS 10
- Artist name 26
- Automatic Music Sensor. *See* AMS

C

- CD TEXT 11
- Changing
 - Artist Name 27
 - Disc Name 21
 - Group Name 25
- Connecting 4
 - another CD player 6
- Continuous Play 10
- Controlling another CD player 31
- Custom Files
 - Artist File 26
 - Delete Bank 24
 - Disc Name 20
 - Group File 24
 - Hit List 29
 - what you can do with 20

D

- Delete Bank 24
- Disc Name 20

E

- Easy Play 14
- Erasing
 - Artist Name 27
 - Custom Files 20
 - Delete Bank 24
 - Disc Name 21
 - Group Name 25
 - Hit List 29

F

- Fading 19

G

- Grouping Discs 24

H

- Handling CDs 34
- Hit List 29
- Hookups 4
 - overview 4

I

- Inserting CDs 7

J, K

- JOG dial 7

L

- Labeling a disc 20
- Locating
 - by monitoring 10
 - by scanning 10
 - directly 13
 - using AMS 10

M, N, O

- Name Scan 13
- Name Search 13
- No-Delay Play 32

P, Q

- Playback
 - Artist Name Play 28
 - Continuous Play 10
 - Easy Play 14
 - Group Play 26
 - Playing alternately 32
 - Program Play 16
 - Repeat Play 15
 - Shuffle Play 15
 - X-Fade Play 32
- Program 16
 - changing 17
 - checking 17
 - erasing 17

R

- Remote control 4
- Repeating 15
- Rotary table 7

S

- Searching. *See* Locating
- Selecting the language 12
- Shuffle Play 15
- Specifying the next disc 14
- Storing
 - information about CDs 20
 - specific tracks 24

T

- Timer play 19
- Troubleshooting 35

U, V, W

- Unpacking 4

X, Y, Z

- X-Fade Play 32

Names of controls

Buttons

- ARTIST MODE 28
- CAPS 22
- CHECK 17
- CLEAR 17
- CONTINUE 10
- DEL 23
- DISC 13
- DISC SKIP +/- 10
- EASY PLAY 14
- ENTER 13
- FADER 19
- GROUP 26
- GROUP 1-8 24
- GROUP FILE 24
- HIT LIST 29
- MEGA CONTROL 31
- MENU/NO 7, 12, 20, 30
- NAME SCAN 13
- NAME SEARCH 13
- NO DELAY 32
- Number 13
- OPEN/CLOSE 7
- PROGRAM 16
- REPEAT 15
- SHUFFLE 15
- SCROLL 11
- SPACE 22
- X-FADE 32
- YES 21, 33
- > 10
- || 10
- 10
- ≡ 10
- ◀▶/▶▶ 10
- ◀◀/▶▶▶ 10
- > 10 10
- +100 12

Control

- JOG dial 7
- ◀◀ AMS ▶▶▶ 10

Switches

- COMMAND MODE 31
- TIMER 19
- I/⏻ 10

Jacks

- CONTROL A1II 5
- DIGITAL OUT (OPTICAL) 5
- 2ND CD IN 6

Others

- Disc slots 7
- Display 11
- Front cover 7
- Rotary table 7
- Ⓜ 4