

User's Manual

BV7940

**IN-DASH DVD/MP3/CD RECEIVER
WITH 3.6-INCH WIDESCREEN TFT MONITOR**

**WITH USB AND SD MEMORY CARD PORTS
AND FRONT PANEL AUX INPUT**



BV7940

**IN-DASH DVD/MP3/CD RECEIVER
WITH 3.6-INCH WIDESCREEN TFT MONITOR
WITH USB AND SD MEMORY CARD PORTS
AND FRONT PANEL AUX INPUT**

03.2012

tech support: www.bossaudio.com/support



BOSS Audio Systems • 3451 Lunar Court • Oxnard, CA 93030

www.bossaudio.com

800.999.1236

BOSS[®]
AUDIO SYSTEMS

BOSS[®]
AUDIO SYSTEMS

To ensure safety while driving

and to comply with laws,

drivers should not watch video or

operate the video device while driving.

WARNINGS

► When Driving

Keep the volume level low enough to aware of the road and traffic conditions.

▲ CAUTION

In some countries, it's unlawful to operate a vehicle while video is displayed in the driver's viewing area. Please always switch the unit's display to "Font Type Display" mode by pressing the DISP button while driving.

For safety reason, the driver should only enjoy / watch the video while the car is in parking mode.

► When Car Washing

Do not expose the product to water or excessive moisture. This could cause electrical shorts, fire or other damage.

▲ CAUTION

In order to avoid any accident, the driver must not watch video while driving. This unit is designed to not allow watching moving video while driving. Park your car in a safe place and engage the 'PARKING BRAKE WIRE' before watching moving video.

► When Parked

Parking in direct sunlight can produce very high temperatures inside your vehicle. Give the interior a chance to cool down before starting playback.

► Use the Proper Power Supply

This product is designed to operate with a 12 volt DC, negative ground battery system (the regular system in a North American car).

► Protect the Disc Mechanism

Avoid inserting any foreign objects into the slot of this player. Failure to follow this may cause malfunction or permanent damage due to the precise mechanism of this unit.

▲ CAUTION

THIS MOBILE MULTIMEDIA PLAYER IS A CLASS I LASER PRODUCT. THIS UNIT USES A VISIBLE/INVISIBLE LASER BEAM WHICH COULD CAUSE HAZARDOUS RADIATION IF EXPOSED DIRECTLY. BE SURE TO OPERATE THE MOBILE MULTIMEDIA PLAYER CORRECTLY AS INSTRUCTED.

USE OF CONTROLS OR ADJUSTMENTS OR PERFORMANCE OR PROCEDURES OTHER THAN THOSE SPECIFIED HEREIN MAY RESULT IN HAZARDOUS RADIATION EXPOSURE.

DO NOT OPEN COVERS AND DO NOT REPAIR BY YOURSELF PLEASE REFER SERVICING TO A QUALIFIED TECHNICIAN.

NOTE:

1. TO REDUCE THE RISK OF FIRE OR ELECTRIC SHOCK, DO NOT EXPOSE THIS EQUIPMENT TO RAIN OR MOISTURE.
2. TO REDUCE THE RISK OF FIRE OR ELECTRIC SHOCK, AND ANNOYING INTERFERENCE, USE ONLY THE RECOMMENDED ACCESSORIES.
3. THIS DEVICE IS INTENDED FOR CONTINUOUS OPERATION.

DISC AND FORMAT SUPPORTS

This unit can play various video/audio format which stored into Disc/USB or SD card on Media Player.

The following chart helps you to check if a disc is supported by this unit, as well as what functions are available for a given disc type.

Disc format
Digital Versatile Discs (MultiMedias)
Video CDs (VCDs)
Digital Versatile Discs Recordable (MultiMedia +/-R)
Digital Versatile Discs Rewritable (MultiMedia +/-RW)
Compact Discs (CDs)
CD Recordable (CD-R)
CD Rewritable (CD-RW)

Audio Format

Playback CD-DA and MP3 or WMA digital music file on CD-ROM or MultiMedia- ROM or USB or Memory Card.

Note of MP3 and WMA:

Support Maximum 2000 files
 Maximum 30 characters display
 Supported Sampling frequencies; 32kHz, 44.1kHz, 48kHz.
 Supported Bit-Rates: 64-256 kbps variable bit rate

Video Format

Playback IMAGE JPEG, DVD Video, MPEG4 . On CD-ROM or Multimedia - ROM or USB or Memory Card.

Noted of MPEG4

Supported decoding MPEG-4 video defined by ISO 14496-2 Standard:

1. Simple Profile (SP) and
2. Advance Simple Profile (ASP)

Supported file format: MP4 and .M4a (audio only)

Unsupported Discs

8 cm Disc
 CDV, CDI, CDG,
 LD
 MultiMedia RAM

Note on Region Code

MultiMedia players and MultiMedia Video discs Have their own Region Code numbers. This unit Can play the disc of all region code numbers.



Disc Maintenance

Before playing, wipe the disc using a clean cloth, working from the center hole towards the outside edge.

Never use benzene, thinners, cleaning fluids or anti-static liquids or any other solvent.



NOTE

A disc may become somewhat scratched (although not enough to make it unusable) depending on you handle it and conditions in the usage environment. Note these scratches are not an indication of any problem with the player.

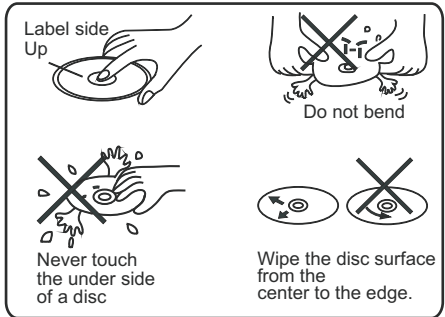

INSTALLATION

The following illustration shows a typical installation. If you have any questions or require information regarding installation kits, consult your customer car audio dealer or a company supplying kits.

If you are not sure how to install this unit correctly, have it installed by a qualified technician.

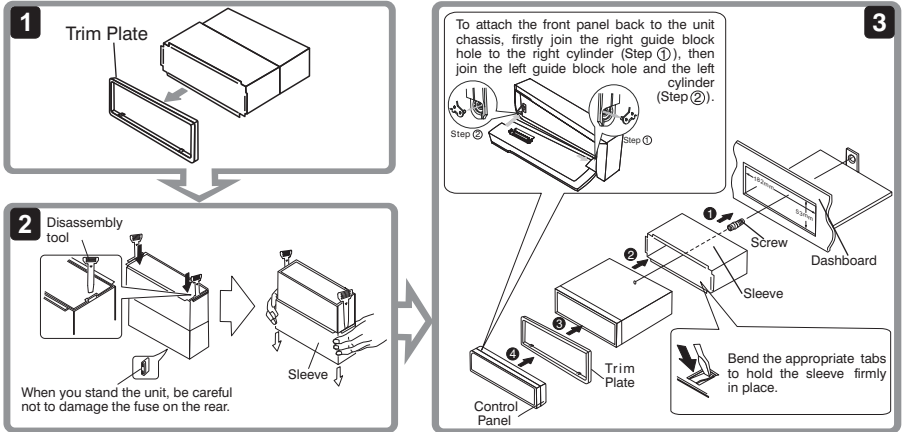

Removing the unit

Before removing the unit, release the rear section.

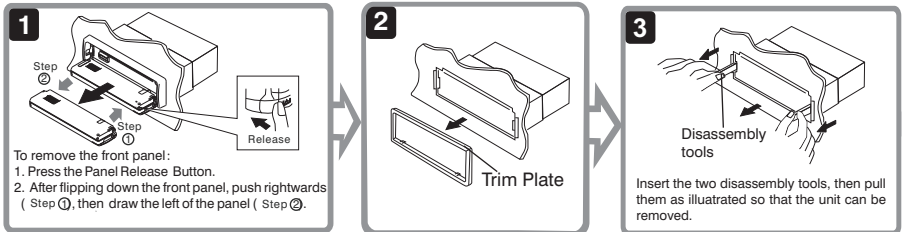

When using the optional stay

Stay(option)

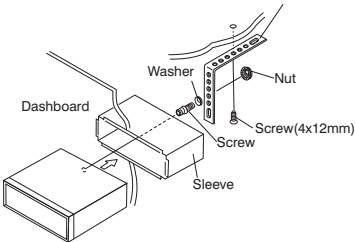

Install the unit at an angle of less than 30°.

When installing the unit without using the sleeve

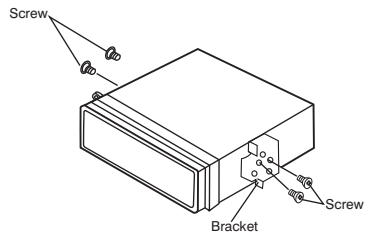

Installation using the screw holes on the sides of the unit. Fastening the unit to the factory radio mounting bracket.

CONNECTING THE SYSTEM

About Parking Wire

▲ CAUTION

In order to avoid any accident, the driver must not watch video while driving. This unit is designed to not allow watching moving video while driving. Park your car in a safe place and engage the parking brake before watching moving video.

NOTE

The Video Blocking system under Parking Brake **NOT ENGAGED** only control this unit's display. This system will not affect the Video Output thru the rear RCA Video Output.

TIPS

Be sure to connect Parking Brake connection lead. (please see more details on " Wiring Diagram.")

NOTE

If watch moving video from Disc or AV In source but Parking Brake is **NOT PROPERLY CONNECTED**, the video signal will be blocked by the system and the below display will be show on TFT:



**Video Blocked |
Engage Parking
Brake to enjoy video**

About The Reverse Wire For Back Up Camera System

If user connected a back up camera system to this unit, when the vehicle is in reverse Gear (Back Up mode), the front in-dash TFT display will automatically switch to Back Up Camera Video signal regardless whatever mode is currently displayed on the front in-dash TFT.

Tips

Be sure to connect Reverse wire properly. (please see more details on " Wiring Diagram.")

CONNECTING THE SYSTEM

Wiring Diagram

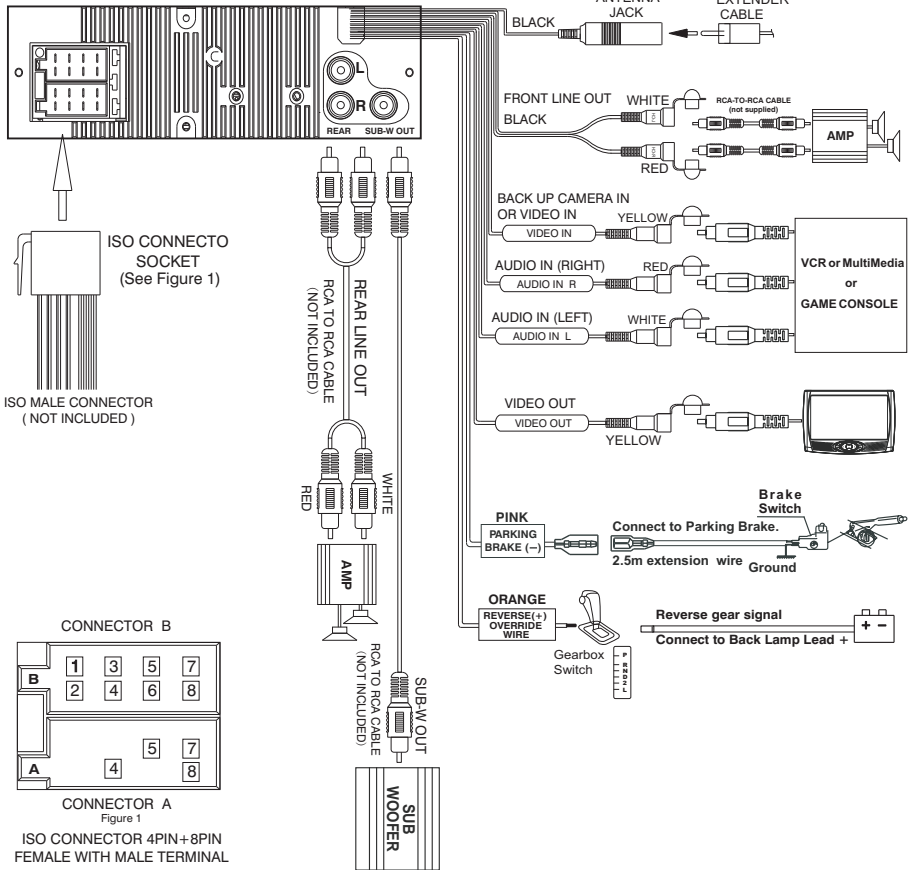

ISO CONNECTOR WIRING CHART

PIN	WIRE COLOR	FUNCTION/LABEL
A4	YELLOW	BATTERY(+)
A5	BLUE	CONNECT TO SYSTEM CONTROL TERMINAL OF THE POWER AMP OR AUTO ANTENNA RELAYCONTROL TERMINAL(max 150mA 12VDC)
A7	RED	IGNITION(ACC)
A8	BLACK	GROUND
B1	VIOLET	RIGHT REAR SPEAKER (+)
B2	VIOLET/BLACK	RIGHT REAR SPEAKER (-)
B3	GREY	RIGHT FRONT SPEAKER (+)
B4	GREY/BLACK	RIGHT FRONT SPEAKER (-)
B5	WHITE	LEFT FRONT SPEAKER (+)
B6	WHITE/BLACK	LEFT FRONT SPEAKER (-)
B7	GREEN	LEFT REAR SPEAKER (+)
B8	GREEN/BLACK	LEFT REAR SPEAKER (-)

THE FUNCTIONS OF MAIN UNIT

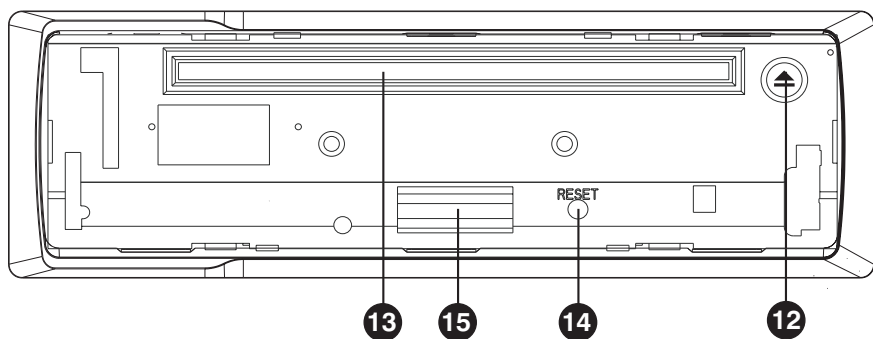
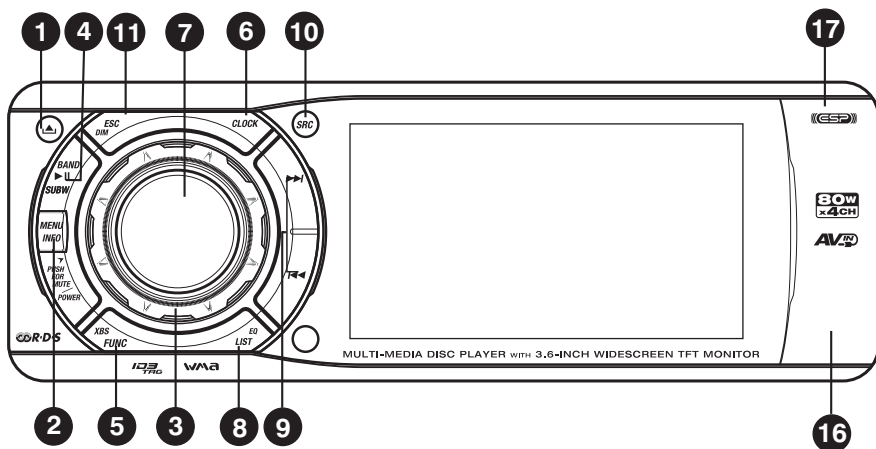

No.	Item	Descriptions
1	(RELEASE)	▶ Press this button to open the control panel.
	MENU	▶ Press this button to access into the SystemMenu mode.
2	INFO	▶ Under RDS mode, press repeatedly to view RDS received information. ▶ Under MultiMedia playback mode, press repeatedly to view play information: Title--->Chapter--->Play time
3	ENCODER VOLUME	▶ Rotate the Encoder Volume Knob to increase and decrease the volume. (The Maximum volume level is "46".)
4	BAND /	▶ Under Tuner mode, short press this button to change between BAND FM1, FM2, FM3, AM1(MW1) or AM2 (MM2) . ▶ Under Media playback mode, short press this button to Pause/ Resume Play the music.
	SUB-W	▶ Press and hold this button to turn On/Off the subwoofer function.
5	FUNC (FUNCTION)	▶ Press this button to enter into the Function mode.
	XBS	▶ Hold & press this button to turn On/Off the Bass booster function.

THE FUNCTIONS OF MAIN UNIT





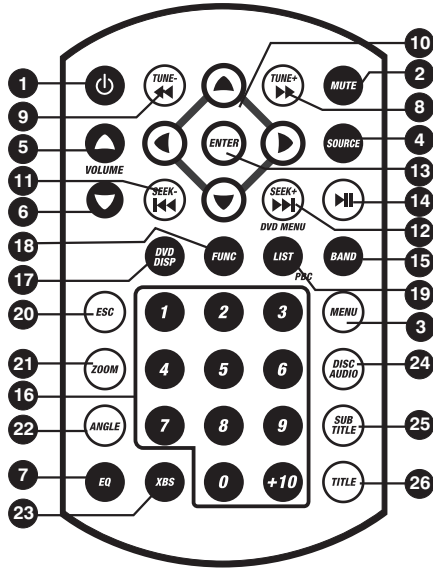













6	CLOCK	▶ Press this button to view the Clock, press this button again to return to previous mode.
7	MUTE ① POWER	▶ Short press this button to turn Mute or restore volume. ▶ Press this button or any other button on the front panel (except Release button) to turn the unit on. Hold & press this button again to turn the unit off.
8	LIST	▶ Under tuner mode, press this button to Show The List of stored station. ▶ Under the Media playback mode, press this button to list the searching of Tracks or Files on the Media playback mode. ▶ Under the MultiMedia/MP4 mode, press this button to list the searching of MultiMedia Root Menu or Files on the playback mode. ▶ Under the VCD mode, press this button to turn On/Off the PCB function.
	EQ	▶ Hold & press this button to select the Preset Equalizer setting: OFF -> ROCK -> POP -> JAZZ -> TECHNO -> CLASSIC
9	TUNE UP/DOWN FILE UP/DOWN FAST BACKWARD / FORWARD	▶ Under tuner mode, press and hold this button momentarily to enter into the Auto Seek/ Manual Seek mode. ▶ Under media playback mode, press these buttons to skip a chapter / track / scene / file. ▶ Under media playback mode, press and hold momentarily to fast forward / backward the Disc.
10	SOURCE	▶ Press this button to select different source playback mode: TUNER / DISC / USB / SD CARD / AV IN mode.
11	ESC DIM	▶ Press this button to quick return previous menu or mode. ▶ Hold & press this button to adjust the TFT dimmer High or Low.
12	 EJECT	▶ Press this button to eject the Disc.
13	DISC SLOT	▶ Insert the disc into CD slot. The CD will begin to play.
14	RESET	▶ User can reset the unit to its default setting. Press this button by using a ball-point pen or sharp object.
15	SD CARD SLOT	▶ This unit can support playback MP3/WMA/JPEG/MPEG4/ DIVX format which are stored on the SD Card.
16	USB SLOT (The USB slot behind the USB/AV-IN jack door)	▶ This unit can support playback MP3/WMA/JPEG/MPEG4/ DIVX format which are stored on the USB memory stick.
17	AV-IN JACK (The AV-IN slot behind the USB/AV-IN jack door)	▶ This unit is allowed to connect with external Audio/Video system such like Digital Camera or Game Console. User can connect the external A/V system thru the A/V in jack on front panel.

THE FUNCTIONS OF REMOTE CONTROL



No.	Button	Item	Decriptions
1		POWER ON OFF	Press this button to turn On / Off the unit.
2		MUTE	Press this button to turn the Mute On / Off.
3		SYSTEM MENU	Hold & press this button to enter into the System Menu mode.
4		SOURCE	Press this button to enter into the SOURCE mode.
5		VOLUME +	Press this button to increase the volume.
6		VOLUME -	Press this button to decrease the volume.
7		EQ	Press this button to enter into the preset Equalizer setting mode.
8			Under the tuner mode, press this button to access the Manual Seek mode. Under the media playback mode, press this button fast forward through the music under media player mode.
9			Under the tuner mode, press this button to access the Manual Seek mode. Under the media playback mode, press this button fast backward through the music under media player mode.
10		UP/DOWN LEFT/RIGHT	Use these buttons to move cursor up/down/left/right.

THE FUNCTIONS OF REMOTE CONTROL

11			Under the tuner mode, press this button access Auto Seek mode. Under the media playback mode, press this button to skip backward of the previous chapter.
12			Under the tuner mode, press this button access Auto Seek mode. Under the media playback mode, press this button to skip forward of the next chapter.
13		ENTER	Use this button to confirm the selection.
14		PLAY/PAUSE	Press this button to Pause / Resume Play the music under media playback mode.
15		BAND	Press this button to return previous menu. Under the tuner mode, press this button to change the radio Band.
16		NUMERIC BUTTONS	When in media playback mode use this button for track or file number direct access and use when function need numeric selection or input.
17		MultiMedia DISPLAY	Press this button and the information displayed on the TFT may vary according to this disc or files type.
18		FUNCTION	Press this button to enter into the function mode.
19		LIST	Under tuner mode,press this button to Show The List of stored station. Under the Media playback mode, press this button to list the searching of Tracks or Files on the Media playback mode. Under the MultiMedia/MP4 mode, press this button to list the searching of MultiMedia Root Menu or Files on the playback mode. Under the VCD mode, press this button to turn On/Off thePCB function.
20			Press this button to quick return previous menu or mode.
21		ZOOM	When playback the MultiMedia, press this button repeatedly to increase the magnification level.
22		ANGLE	Under MultiMedia mode, press this button while playing a scene recorded with multiple angles to change the angle.
23		IX-BASS	Press this button to turn On/Off the iX-BASS booster function.
24		DISC AUDIO	Under MultiMedia mode, press this button during playback to change the audio language, if available on the disc.
25		SUBTITLE	Under MultiMedia mode, press this button during playback to turn on/off subtitles and change the subtitles.
26		TITLE	Under MultiMedia mode, press this button to bring up the Title Menu.

ADJUST SETTINGS

Press the MENU/INFO button access into the System Menu. User can rotate the Encoder Volume Knob to select the below options, then press Power/Mute to confirm.

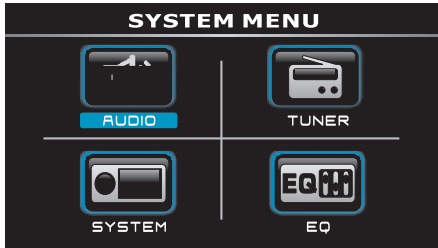

Adjust Audio Setting

User can rotate the Encoder Volume Knob to select the below Audio Settings, then press Power/Mute to confirm.

▶ Bass

User can use the Encoder Volume knob to adjust the desired Bass level range from -6 to +6.

▶ Treble

User can use the Encoder Volume knob to adjust the desired Treble level range from -6 to +6.

▶ Fader

User can use the Encoder Volume knob to adjust the Fader between the front and rear speakers from 12R (full rear) to 12F (full front).

▶ Balance

User can use the Encoder Volume knob to adjust the Balance between the right and left speakers from 12R (full right) to 12L (full left).

Tuner Setting

User can rotate the Encoder Volume Knob to adjust the Tuner Settings, then press Power/Mute to confirm.

▶ Tuner Area

This option allows the selection of the frequency spacing appropriate for your area. Rotate the Encoder Volume Knob to select the Tuner Area: U.S.A, Europe, Oirt, Latin.

▶ RDS On/Off

User can rotate the Encoder Volume Knob to turn the RDS On or Off.

Adjust System Setting

User can rotate the Encoder Volume Knob to select the System Settings, then press Power/Mute to confirm.

▶ Beep Tone

To adjust the Beep Tone On/Off. The beep tone feature allows the selection of an audible beep tone to be heard each time a button is pressed on the face of the radio.

▶ Time Set

The time on the clock will be set to 12:00 as the default. User can rotate the Encoder Volume Knob to adjust the HOUR / MINUTE.

Preset Equalizer Setting

Under the Preset EQ Setting, there are the below 8 different types of preset equalizer available for user selection.

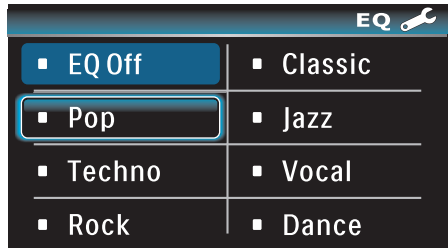

TIPS

Press and hold LIST button on the front panel is to quick get into the Preset Equalizer Setting menu.

TUNER OPERATIONS

Adjust Tuner Function

Press the FUNC button under Tuner mode access into the Tuner Function menu. User can rotate the Encoder Volume Knob to select the below options:

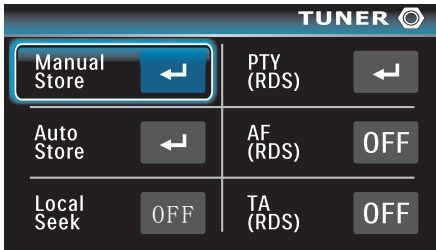

▶ Manual Store

Use this function to save the current frequency to memory stations. User can press the Power/Mute to enter into the manual store memory stations.

▶ Auto Store

After Auto Store & saved the 6 strongest stations, the unit will automatically enter present scan one time.

▶ Local Seek

To receive more radio stations or only stations with strong signal, you can adjust the tuner sensitivity. User can press the Power/Mute to turn On/Off the Local Seek mode.

[Local Seek On]: Only stations with strong signal can be broadcast.

[Local Seek Off]: Stations with strong and weak signals can be broadcast.

▶ PTY Seek

User can press the Power/Mute button get into the PTY List to select the desired PTY mode.

▶ AF On/Off

User can press the Power/Mute button to turn the AF On or Off.

▶ TA On/Off

User can press the Power/Mute button to turn the TA On or Off.

Tune To Radio Station

Press the BAND button to change between FM bands and AM(MW) bands.

Tune To Preset Station

Press the LIST button to get into the preset stations list, and user can use the Encoder Volume Knob to select which preset station he would listen to, and press the Power/Mute button to confirm the selection.

Manual Seek

Press and hold **◀▶** buttons on front panel to access into the Manual Seek mode.

Auto Seek

Press and hold **◀▶** buttons on front panel to access into the Auto Seek mode, and the unit will auto search for the next radio station.

NOTE

AF, TA & PTY only appearing in the function list, after changed the Tuner Area to "Europe".

ABOUT RDS

NOTE

This unit default at USA Tuner Area. RDS function only activated after selected the Tuner Area to “ Europe”.

TIPS

Please refer Adjust Settings “ Tuner Setting” for details how to select the Tuner Area.

The RDS (Radio Data System) function operate only in areas with FM stations broadcasting RDS signals. If you tune to and RDS station, and RDS icon and information about the presenter, station or program is displayed.

This unit support below RDS features:

▶ **PTY (Program Type)**

Before tuning to RDS stations, you can select program type and let the unit search only for programs of the selected category.

MUSIC GROUP	SPEECH GROUP
POP M , ROCK M	NEWS, AFFAIRS, INFO
EASY M, LIGHT M	SPORT, EDUCATE, DRAMA
CLASSICS, OTHER M	CULTURE, SCIENCE, VARIED
JAZZ, COUNTRY	WEATHER, FINANCE, CHILDREN
NATIONM, OLDIES, FOLKM	SOCIAL, RELIGION, PHONE IN
TEST, ALARM, MANUAL	TRAVEL, LEISURE, DOCUMENT

▶ **AF (Alternate Frequencies)**

If the radio signal come from the current station is poor, you can turn on the AF (Alternate Frequency) function to let the unit searches for another station with stronger signal but with the same program identification as the current station automatically.

▶ **TA (Receive Traffic Announcement)**

If you do not want to miss traffic announcement during enjoying music, you can turn on the TA (Traffic Announcement) function.

TA On When there is traffic announcement, the unit switches to the tuner mode (regardless of the current mode) and begins to broadcast the announcement on traffic conditions. When the traffic announcement is over, it returns to the previous mode.

TA Off Traffic announcement does not cut in.

▶ **CT (Clock Time)**

The RDS signal broadcast together with the clock time to the unit automatically.

MEDIA PLAYER OPERATIONS (Disc/USB/SD Card)



This unit can play various video / audio stored into Disc / USB or SD Card on media player.

You can play commercially available audio CDs and these Discs:

- Digital Versatile Discs (MultiMedias)
- Video Cds (VCDs)
- Digital Versatile Discs Recordable (MultiMedia+/-R)
- Digital Versatile Discs Rewritable (MultiMedia+/-RW)
- Compact Discs (CDs)
- CD Recordable (CD-R)
- CD Rewritable (CD-RW)

NOTE

Please ensure that the disc contains playable content.

1. Press  on the front panel to release the panel.
2. Insert a CD with the printed side facing up, then close the panel, the unit will play starts automatically.
 - Press the BAND/|| to pause the music play. Press this button again to resume music play.
 - Press the <</>> to skip forward to the beginning of the next or previous chapter.
 - Press and hold the <</>> to fast forward or fast rewind through the disc. Press these buttons again to resume normal playback.
3. Press  to take out the CD.

USB Device Operation

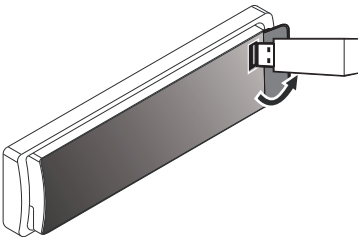

Flip open the USB plastic cover, insert the USB device into the USB socket. The unit starts playing from the USB device automatically.

NOTE

Ensure that the USB device contains playable music.

Memory Card Operation

▶ Insert The Memory Card

1. Press  on the front panel to release the panel.
2. After flipping down the front panel, push rightwards, then draw the left of the panel.
3. Insert the Memory Card into the card slot, then close the panel, the unit will play starts automatically.

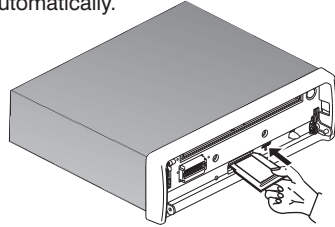

NOTE

Ensure that the memory card contains playable music.

▶ Remove The Memory Card

press the card until you hear a click sound, the card is now disengaged. then remove the card.

Media Playing

▶ Repeat

During the media playback, press the FUNC button to adjust the different Repeat mode.

For MULTIMEDIA/VCD mode

- [Repeat CH]: repeat playback the current the chapter.
- [Repeat TT]: repeat playback the current title.
- [Repeat Off]: cancel all the repeat function.

For MP3/WMA/CD mode

- [Repeat Off]: play all tracks repeatedly
- [Repeat One]: play the current track repeatedly
- [Repeat Folder]: play all tracks in the current folder repeatedly

Random

User can play audio tracks/files or VCD videos in random order. During the playback, press the FUNC button to turn On/Off the random function.

MEDIA PLAYER OPERATIONS (Disc/USB/SD Card)

Skip/Search

1. Under the Media playback, press the LIST button access into the playlist menu. User can rotate the Encoder Volume Knob to select the below options:

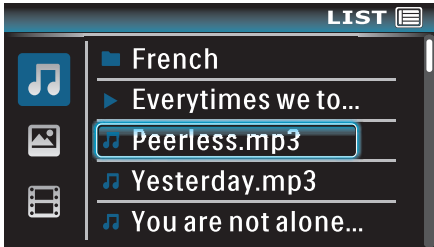

- : to display all available audio folders / track.
- : to display all available pictures folders / files.
- : to display all available video folders / files.

2. Under the MultiMedia playback mode, press the LIST button can access into the MultiMedia Root Menu.

Audio Channel

During the VCD playback, press the FUNC button access into the Channel mode. Press the Power/Mute to select the available audio channels provided by the disc (Stereo, Left, Right).

PBC Playback

PBC playback allows you to play Video CDs interactively. During the VCD playback, press the FUNC button access into the Pbc mode, press the Power/Mute to turn PBC On or Off.

[PBC On]: it will switch to OFF and continue playback.

[PBC Off]: it will switch to ON and return to menu screen.

TIPS

Press the LIST button on the front panel is quick to turn the PBC On or OFF.

Video Setting

Under MultiMedia/VCD playback, press the FUNC button access into the Video Setting mode, the below Setup menu will appear:



- **[BRIGHT]:** change the Bright level from 0 to 7.
- **[CONTRAST]:** change the Contrast level from 0 to 7.
- **[COLOR]:** change the Color level from 0 to 7.
- **[Reset]:** reset to default setting.

MULTIMEDIA Audio

During the MultiMedia playback, press the FUNC button access into the MultiMedia Audio to change the audio language (MultiMedia only).

Subtitle Language

During the MultiMedia playback, press the FUNC button access into the Subtitle to turn On/Off subtitles and change the subtitles (MultiMedia only).

Angle

Under the FUNC menu, user can press Aangle while playing a scene recorded with multiple angles to change the angle (MultiMedia only).

Aspect Ratio

The TV Aspect setting allows the user to select the aspect ratio of the TV (MultiMedia and VCD only).

Under the FUNC menu, user can use the Encoder Volume Knob to select the following options:

4:3=Aspect ratio of TV is 4:3

16:8=Aspect ratio of TV is 16:9. Both wide screen and 4:3 contents will fill the entire screen.

AV-In Mode

Select the AV Mode

Your can connect up to 1 AV device, press the SOURCE button to enter into the AV mode:

AV - 1 IN = Front panel AV in

AV - 2 IN = RCA back of unit

AV -1 In

This unit is allowed to connect with external Audio/Video system such like Digital Camera or Game Console. User can connect the external A/V system thru the A/V in jack on front panel.

Connect the A/V In

Connect the external signal to A/V in jack located at the front of the panel, then press Source button to select A/V mode. Press Mode Button again to cancel A/V mode and retrun to previous mode.

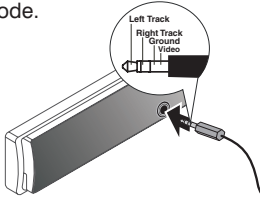

AV - 2 In

Connect the external signal to the RCA line in jack located at the rear of the unit, then press SOURCE button to select AV -2 In.

TIPS

If there is no any external AV System input, then the TFT will be show " NO VIDEO SIGNAL".



SPECIFICATIONS

TFT Screen Section

Screen Size: 3.6" (Measured Diagonally)
Screen Type: TFT Liquid Crystal Display active matrix
Resolution: 320 x 240

MultiMedia / CD Section

Compatible Disc/Format	See " Disc Note" for more details description
Signal to Noise Ratio	≥ 90 dB
Dynamic Range	≥ 90 dB
Frequency Response	20Hz to 20Khz +/-3dB
Channel Separation	2 Channel (Stereo) >60dB @1khz

Video Section

Color System	NTSC / PAL/SCEAM
Video Output	Composite 1.0 Vp-p (+/- 0.2) 75 - ohm
Video Input	Composite 1.0 Vp-p (+/- 0.2) 75 - ohm

Audio Section

Max Output Power	80W x 4 channels
Load Impedance (speakers)	4 ohms
Line out level / load	400mV / 10k ohm load
Line out Impedance	200 ohm

Auxiliary Input Section

Frequency response	20Hz to 20KHz -3dB
Input Maximum Voltage	1200 mV
Input Impedance	4.7k ohm

Radio Section

FM

Frequency Range	87.5-108.0 MHz (Europe) 87.5-107.9 MHz (U.S.A)
Usable Sensitivity	≤ 15dB at S/N 30 dB
Stereo Separation	25 dB at 1KHz
S/N Ratio	50 dB

AM or MW

Frequency Range	522-1620 Khz (Europe) 530-1720 (U.S.A)
Usable Sensitivity	< 40dB at S/N 20dB
S/N Ratio	40 dB

General

Operating Voltage	DC 11 -14.4V
Grounding System	Negative Ground
Fuse:	15-Amp Mini ATM Type
Operating Temperature:	0° C to 50° C
Unit Mounting Angle	≤ 30°

TROUBLESHOOTING

Before going through the check list, check wiring connection. If any of the problems persist after check list has been made, consult your nearest service dealer.

Symptom	Cause	Solution
No power	The car ignition is not on.	If the power supply is properly connected to the car accessory terminal, switch the ignition key to "ACC"
	The fuse is blown.	Replace the fuse.
Disc cannot be loaded or ejected	Presence of CD disc inside the player.	Remove the disc in the player, then put a new one.
	Inserting the disc in reverse direction.	Insert the compact disc with the label facing upward.
	Compact disc is extremely dirty or defective disc.	Clean the disc or try to play a new one.
	Temperature inside the car is too high.	Cool off or until the ambient temperature returns to normal.
	Condensation.	Leave the player to off for an hour or so, then try again.
No sound	Volume is in minimum.	Adjust volume to a desired level.
	Wiring is not properly connected.	Check wiring connection.
The operation keys do not work	The built-in microcomputer is not operating properly due to noise.	Press the RESET button. Front panel is not properly fixed into its place
Sound skips.	The installation angle is more than 30 degrees.	Adjust the installation angle to less than 30 degrees.
	The disc is extremely dirt or defective disc.	Clean the compact disc. Then try to play a new one.
The radio does not work. The radio station automatic selection does not work.	The antenna cable is not connected.	Insert the antenna cable firmly.
	The signals are too weak.	Select a station manually.
ERROR	Mechanism Error	Press the eject button to correct the problem. If the error code does not disappear, consult your nearest service dealer.
Disc Error	Maybe disc dirty / disc scratched /disc upside down.	Replace the disc.



If at any time in the future you should need to dispose of this product please note that Waste electrical products should not be disposed of with household waste. Please recycle where facilities exist. Check with your Local Authority or retailer for recycling advice.(Waste Electrical and Electronic Equipment Directive)