



INSTALLATION MANUAL FOR AIR CURTAIN MODELS



TABLE OF CONTENTS

- ▶ **Safety Information**
 - TAC-48 Installation Tips _____ 1
 - Safety Precautions _____ 2
 - Proper Disposal _____ 3
 - Connecting Electricity _____ 4
 - Adapter Plugs _____ 4

- ▶ **Installation / Operation Instructions**
 - Ownership _____ 5
 - Required Tools _____ 5
 - Uncrating _____ 5
 - Locating _____ 5
 - Installation of Leg/Castors _____ 6
 - Electrical Instructions _____ 7
 - Leveling Cabinet _____ 7
 - Conductors and Circuits _____ 8
 - Start-up & Light Switch Location _____ 9
 - Mechanical Temperature Control
Adjustments _____ 10-11
 - Defrost Timer Instructions _____ 12
 - Digital Temperature Control Adjustments _____ 13
 - Remote Unit Installation _____ 14
 - Shelving & Flavor Strip Installation _____ 15

- ▶ **Maintenance, Care & Cleaning**
 - Cleaning Condenser Coil _____ 16-17
 - Stainless Steel Equipment Care & Cleaning – 18-19
 - Light Bulb Replacement _____ 19
 - Warranty (U.S.A. & CANADA ONLY!) _____ 20

*Spanish, German, French, and Dutch version included.

CONGRATULATIONS!

You have just purchased the finest commercial refrigeration available. You can expect many years of trouble-free operation.

TAC (TRUE AIR CURTAIN MODELS)

NOTICE TO CUSTOMER:

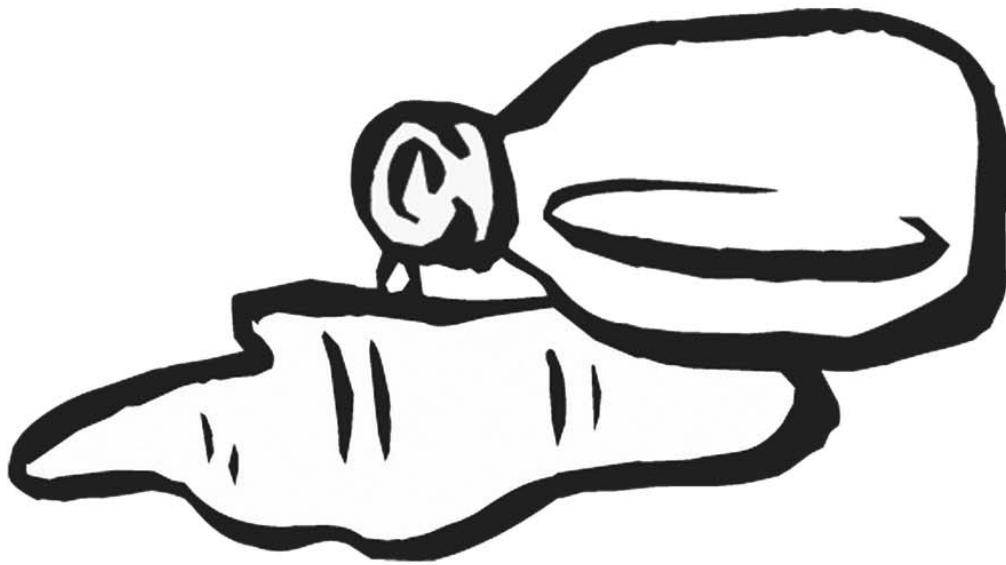

**Loss Or Spoilage of
Products In Your True
Air Curtain Refrigerator
Is NOT Covered By
Warranty.**

True Manufacturing Company, Inc.

TAC (True Air Curtain) Recommended Operating Conditions

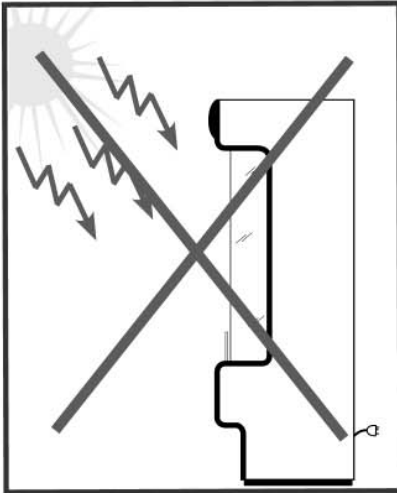

• Units should not be installed in direct sunlight.

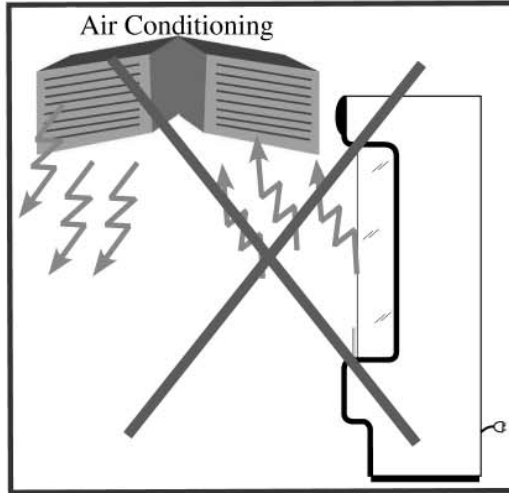

• Units should not be installed near HVAC vents.

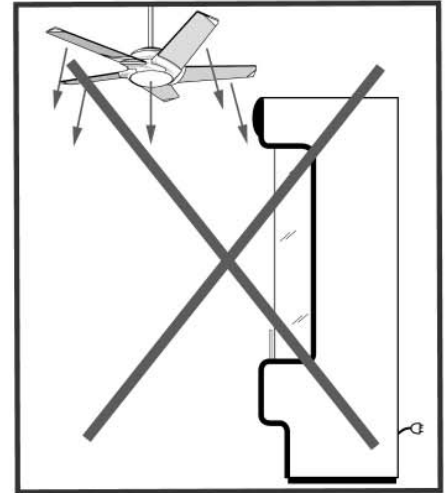

• Units should not be installed near fans.

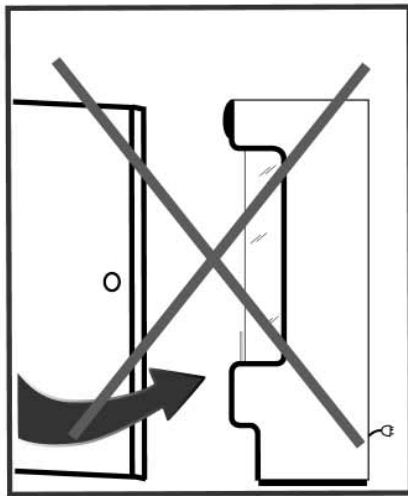

• Units should not be installed near doorways.

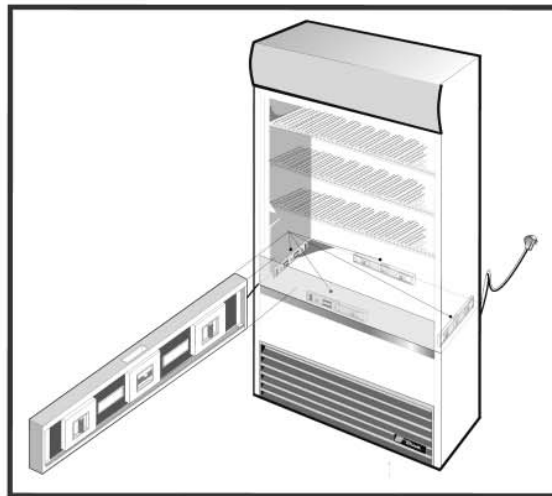

• Level cabinet front to back and side to side.

• Check for proper clearance for air flow.



• Operating environment not to exceed 75°F (23°C) and 55% humidity.

• Do not load product to where it would over hang the shelf.

SAFETY INFORMATION

How to Maintain Your Unit to Receive the Most Efficient and Successful Operation

You have selected one of the finest commercial refrigeration units made. It is manufactured under strict quality controls with only the best quality materials available. Your TRUE cooler, when properly maintained, will give you many years of trouble-free service.

WARNING!

Use this appliance for its intended purpose as described in this Owner Manual.

SAFETY PRECAUTIONS

When using electrical appliances, basic safety precautions should be followed, including the following:

- This refrigerator must be properly installed and located in accordance with the Installation Instructions before it is used.
- Do not allow children to climb, stand or hang on the shelves in the refrigerator. They could damage the refrigerator and seriously injure themselves.
- Do not touch the cold surfaces in the refrigerated compartment when hands are damp or wet. Skin may stick to these extremely cold surfaces.
- Do not store or use gasoline or other flammable vapors and liquids in the vicinity of this or any other appliance.
- Keep fingers out of the “pinch point” areas; clearances between the doors and cabinet are necessarily small; be careful closing doors when children are in the area.

NOTE: We strongly recommend that any servicing be performed by a qualified individual.

- Unplug the refrigerator before cleaning and making repairs.
- Setting temperature controls to the 0 position does not remove power to the light circuit or evaporator fans.

SAFETY INFORMATION

DANGER!
RISK OF CHILD ENTRAPMENT

PROPER DISPOSAL OF THE REFRIGERATOR

Child entrapment and suffocation are not problems of the past. Junked or abandoned display cases are still dangerous... even if they will sit for “just a few days.” If you are getting rid of your old display case, please follow the instructions below to help prevent accidents.

Before You Throw Away Your Old Refrigerator or Freezer:

- Take off the doors.
- Leave the shelves in place so that children may not easily climb inside.

Refrigerant Disposal

Your old refrigerator may have a cooling system that uses “Ozone Depleting ” chemicals. If you are throwing away your old refrigerator, make sure the refrigerant is removed for proper disposal by a qualified service technician. If you intentionally release any refrigerants you can be subject to fines and imprisonment under provisions of the environmental regulations.

USE OF EXTENSION CORDS

NEVER USE AN EXTENSION CORD! TRUE will not warranty any display case that has been connected to an extension cord.

SAFETY INFORMATION

WARNING!

HOW TO CONNECT ELECTRICITY

Do not, under any circumstances, cut or remove the third (ground) prong from the power cord. For personal safety, this appliance must be properly grounded.

The power cord of this appliance is equipped with a 3-prong (grounding) plug which mates with a standard 3-prong (grounding) wall outlet to minimize the possibility of electric shock hazard from this appliance.

Have the wall outlet and circuit checked by a qualified electrician to make sure the outlet is properly grounded.

If the outlet is a standard 2-prong outlet, it is your personal responsibility and obligation to have it replaced with the properly grounded 3-prong wall outlet.

The unit should always be plugged into it's own individual electrical circuit, which has a voltage rating that matches the rating plate.

This provides the best performance and also prevents overloading building wiring circuits which could cause a fire hazard from overheated wires.

Never unplug your freezer by pulling on the power cord. Always grip plug firmly and pull straight out from the outlet.





Repair or replace immediately all power cords that have become frayed or otherwise damaged. Do not use a cord that shows cracks or abrasion damage along its length or at either end.

When removing the freezer away from the wall, be careful not to roll over or damage the power cord.

USE OF ADAPTER PLUGS

NEVER USE AN ADAPTER PLUG! Because of potential safety hazards under certain conditions, we strongly recommend against the use of an adapter plug.

NEMA plugs
TRUE uses these types of plugs.
If you do not have the right outlet
have a certified electrician install
the correct power source.

 115/60/1
NEMA-5-15R
 115/60/1
NEMA-5-20R
 208-230/60/1
NEMA-6-15R
 208-230/60/1
NEMA-6-20R

INSTALLATION / OPERATION INSTRUCTIONS

INSTALLATION / OPERATION INSTRUCTIONS

OWNERSHIP

To insure that your unit works properly from the first day, it must be installed properly. We highly recommend a trained mechanic and electrician install your True equipment. The cost of a professional installation is money well spent.

Before you start to install your True unit, carefully inspect it for freight damage. If damage is discovered, immediately file a claim with the delivery freight carrier.

True is not responsible for damage incurred during shipment.

REQUIRED TOOLS

- Adjustable Wrench
- Phillips Head Screwdriver
- Level

UNCRATING

Step 1

The following procedure is recommended for uncrating the unit:

- A.** Remove the outer packaging by pulling tri-wall nails from skid. Remove (4) cardboard corner pads and dust cover.
- B.** Inspect for concealed damage. Again, immediately file a claim with the freight carrier if there is damage.

- C.** Move your unit as close to the final location as possible before removing the wooden skid.

LOCATING

Step 2

- A.** Remove packing material behind cabinet as a cushion. Carefully lay the unit on its back to remove skid.

When lifting unit remember to leave the cabinet upright for 24 hours before plugging into power source.

- B.** Remove skid by unscrewing all base rail anchor brackets. Place skid to the side.
- C.** Carefully lift cabinet upright.

Installation Tips

- Place cabinet in an area that will not have any air drafts.
- Excessive airflow around cabinet can effect interior cabinet airflow (air-curtain).
- No HVAC supply or return air vents pushing air into or pulling air out of cabinet.
- No doorways.
- No ceiling fans.
- Do not place into direct sunlight.

NOTE:

Check for correct clearance space in back of cabinet and above. A 4" clearance requirement for the rear of cabinet and 12" clearance above cabinet.

- Maximum ambient condition 75 degrees and 55% Relative Humidity.

Removing skid from bottom of cabinet.



INSTALLATION OF LEGS AND CASTORS

Step 3

Leg Levelers:

If the cabinet is not level use an open-end wrench and turn adjustable tips on legs until cooler is level. (See image 1).

Castor Installation: (Kit Contents)

- 2 - Castor mounting bracket
- 2 - Castor, 2-1/2" diameter wheel with 3/8" - 16 x 1-1/2" threaded stem without brake
- 2 - Castor, 2-1/2" diameter wheel with 3/8" - 16 x 1-1/2" threaded stem with brake
- 4 - Washer, flat, 3/8" I.D. x 1" O.D.
- 4 - Washer, split lock, 3/8" I.D.
- 4 - Nut, hex, 3/8" - 16

(See image 2).

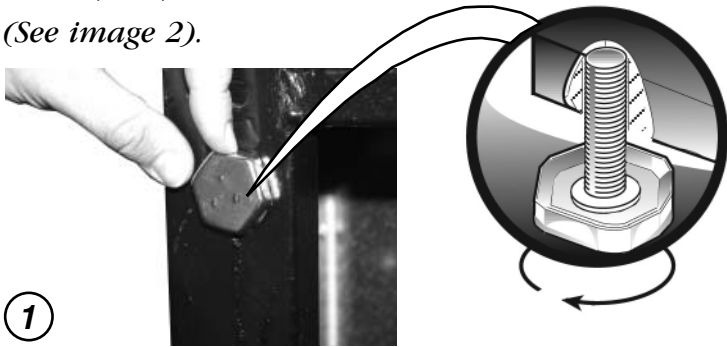

1 Leg levelers in the bottom of the cabinet can be backed out for leveling.

CAUTION
To avoid damage to lower rail assembly, slowly raise unit to upright position after installing castors.

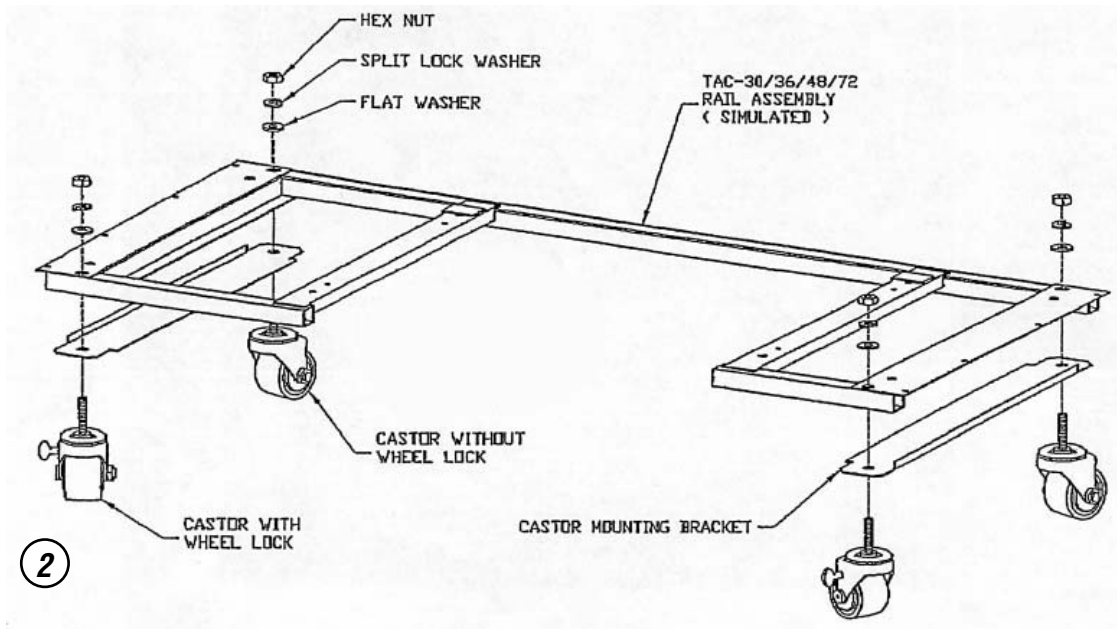

2

INSTALLATION / OPERATION INSTRUCTIONS

LEVELING

Step 4

Securing Castors

A. Set unit in its final location. Be sure there is adequate ventilation in your room. Under extreme heat conditions, (100°F+, 38°C+), you may want to install an exhaust fan.

Warning

Warranty is void if ventilation is insufficient.

B. Proper leveling of your True cooler is critical to operating success (for non-mobile models). Effective condensate removal and door operation will be effected by leveling.

C. The cooler should be leveled inside the cabinet front to back and side to side with a level.

D. Ensure that the drain hose or hoses are positioned in the pan.

E. Free plug and cord from inside the lower rear of the cooler (do not plug in).

F. The unit should be placed close enough to the electrical supply so that extension cords are never used.

Warning

Compressor warranties are void if the unit is more than 8ft. (2.4m) from plug-in connection. TRUE will not warranty any units that are connected to an extension cord.

ELECTRICAL INSTRUCTIONS

Step 5

A. Before your new unit is connected to a power supply, check the incoming voltage with a voltmeter. If anything less than 100% of the rated voltage for operation is noted, correct immediately.

B. All units are equipped with a 8 ft. (2.4m) service cord, and must be powered at proper operating voltage at all times. Refer to cabinet data plate for this voltage.

True requires that a sole circuit be dedicated for the unit. Failure to do so voids warranty.

WARNING

Compressor warranties are void if compressor burns out due to low voltage.

WARNING

Power supply cord ground should not be removed!

NOTE

To reference wiring diagram - Remove lower rear grill. Wiring diagram is positioned on the inside cabinet wall.

INSTALLATION / OPERATION INSTRUCTIONS

CONDUCTORS AND CIRCUITS

Wire Gauge for 2% Voltage Drop in Supply Circuits.

115 Volt Amps	Distance In Feet To Center of Load											
	20	30	40	50	60	70	80	90	100	120	140	160
2	14	14	14	14	14	14	14	14	14	14	14	14
3	14	14	14	14	14	14	14	14	14	14	14	12
4	14	14	14	14	14	14	14	14	14	12	12	12
5	14	14	14	14	14	14	14	12	12	12	10	10
6	14	14	14	14	14	14	12	12	12	10	10	10
7	14	14	14	14	14	12	12	12	10	10	10	8
8	14	14	14	14	12	12	12	10	10	10	8	8
9	14	14	14	12	12	12	10	10	10	8	8	8
10	14	14	14	12	12	10	10	10	10	8	8	8
12	14	14	12	12	10	10	10	8	8	8	8	6
14	14	14	12	10	10	10	8	8	8	6	6	6
16	14	12	12	10	10	8	8	8	8	6	6	6
18	14	12	10	10	8	8	8	8	8	8	8	5
20	14	12	10	10	8	8	8	6	6	6	5	5
25	12	10	10	8	8	6	6	6	6	5	4	4
30	12	10	8	8	6	6	6	6	5	4	4	3
35	10	10	8	6	6	6	5	5	4	4	3	2
40	10	8	8	6	6	5	5	4	4	3	2	2
45	10	8	6	6	6	5	4	4	3	3	2	1
50	10	8	6	6	5	4	4	3	3	2	1	1

Wire Gauge for 2% Voltage Drop in Supply Circuits.

230 Volt Amps	Distance In Feet To Center of Load											
	20	30	40	50	60	70	80	90	100	120	140	160
5	14	14	14	14	14	14	14	14	14	14	14	14
6	14	14	14	14	14	14	14	14	14	14	14	12
7	14	14	14	14	14	14	14	14	14	14	12	12
8	14	14	14	14	14	14	14	14	14	12	12	12
9	14	14	14	14	14	14	14	14	12	12	12	10
10	14	14	14	14	14	14	14	12	12	12	10	10
12	14	14	14	14	14	14	12	12	12	10	10	10
14	14	14	14	14	14	12	12	12	10	10	10	8
16	14	14	14	14	12	12	12	10	10	10	8	8
18	14	14	14	12	12	12	10	10	10	8	8	8
20	14	14	14	12	10	10	10	10	10	8	8	8
25	14	14	12	12	10	10	10	10	8	8	6	6
30	14	12	12	10	10	10	8	8	8	6	6	6
35	14	12	10	10	10	8	8	8	8	6	6	5
40	14	12	10	10	8	8	8	6	6	6	5	5
50	12	10	10	8	6	6	6	6	6	5	4	4
60	12	10	8	6	6	6	6	6	5	4	4	3
70	10	10	8	6	6	6	5	5	4	4	2	2
80	10	8	8	6	6	5	5	4	4	3	2	2
90	10	8	6	6	5	5	4	4	3	3	1	1
100	10	8	6	6	5	4	4	3	3	2	1	1

INSTALLATION / OPERATION INSTRUCTIONS

STARTUP

Step 6

A. The compressor is ready to operate. Plug in the unit.

PLEASE REVIEW THE FOLLOWING CAUTIONS WHEN THE OPTIONAL HEATED PAN IS USED.

CAUTION:
This unit has two power supply cords. Unplug both cords before moving or servicing this appliance.

CAUTION:
This unit has two power supply cords. Connect each plug to a receptacle that is connected to an individual branch circuit.

CAUTION:
This unit has more than one disconnect switch (plug).

- B. Temperature control set at No. 4 position gives refrigerators an approximate temperature of 33°F to 38°F (5°C to 3.3°C). Allow unit to function several hours, completely cooling cabinet before changing the control setting.
- C. Excessive tampering with the control could lead to service difficulties. Should it ever become necessary to replace temperature control, be sure it is ordered from your True dealer or recommended service agent.
- D. Good air flow in your True unit is critical. Be careful to load product so that it neither presses against the back wall, nor comes within four inches of the evaporator housing. Refrigerated air off the coil must circulate down the front of the shelves.

NOTE

If the unit is disconnected or shut off, wait five minutes before starting again.

RECOMMENDATION

Before loading product we recommend you run your True unit empty for two to three days. This allows you to be sure electrical wiring and installation are correct and no shipping damage has occurred. Remember, our factory warranty does not cover product loss!

REPLACEMENT PARTS

TRUE maintains a record of the cabinet serial number for your unit. If at any time during the life of your display case, a part is needed, you may obtain this part by furnishing the model number and serial number to the company from whom you purchased the cabinet. Call Toll-Free: (800)-424-TRUE (Direct to Parts Department). (800)-325-6152 (U.S.A. & Canada only) or call: (636)-240-2400.

Serial Number

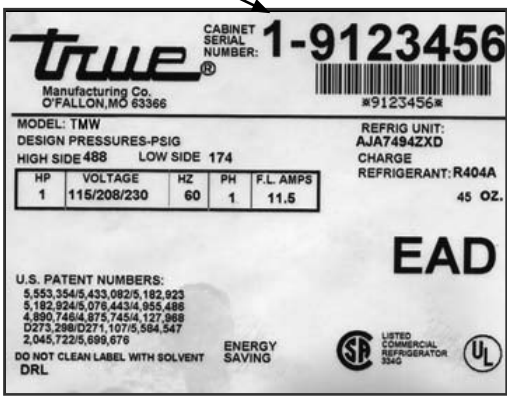

LIGHT SWITCH LOCATION:

The light switch is located behind the interior light on the ceiling. Depending on the model the switch will be either on the left or right side of the ceiling.

REMOTE UNITS (This section applies to remotes only!)

- Remote cabinets must be ordered as remote. We do not recommend converting a standard self contained to remote system.
- All remote cabinets must be hard wired.
- Remote cabinets are not available with castors.
- All remote cabinets come standard using 404A refrigerant.
- All remote units come standard with expansion valve, liquid line solenoid, heated condensate pan, and defrost timer when applicable.
- Contact True Technical Service for BTU requirements.
- No wiring necessary between cabinet and condensing unit.
- All remote condensing units purchased from True are 208/230 volts single phase.

If you have any questions regarding this section, please call True at 1 (800) 325-6152.

INSTALLATION / OPERATION INSTRUCTIONS

TAC MECHANICAL TEMPERATURE CONTROL ALTITUDE ADJUSTMENT

Required Tools:

- Phillips Head Screwdriver
- 1/4" Nut Driver Bit
- Slotted (Standard) Screw Driver
- 5/32" Allen Key

Temperature Control Adjustments:

STEP 1

Unplug the cooler.

Note (Refrigerators):

Temperature Control Knob Location:

Inside the cabinet at the bottom on the left-hand side recessed in the back of cabinet.

STEP 2

Back out two screws, one from each bottom corner of the cabinet. Then the floor of the unit can be pulled out of the cabinet and set to the side. Be careful not to scratch the inside of the cabinet when lifting the floor out of the unit. (See figure 1).

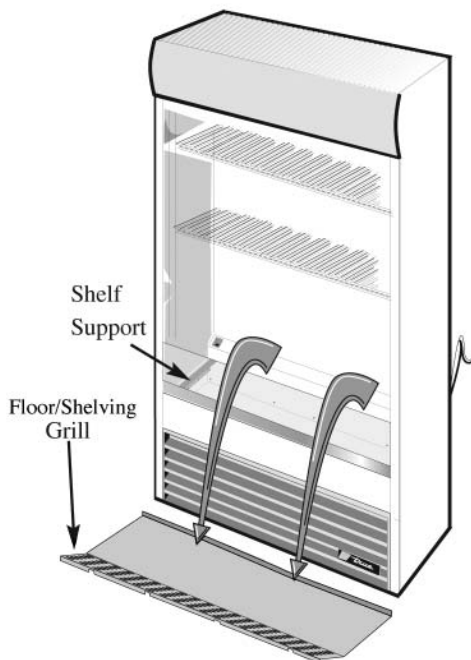

Figure 1

STEP 3

Shelf supports on either side of cabinet come out by backing-out three hex screws (1/4") on each side. Larger units will have a center shelf support that will need to be removed.

STEP 4

Once shelf supports are removed the evaporator coil cover needs to be removed. Back-out four 1/4" hex screws located inside bottom of the cabinet on the rear wall. Then pull off cover by lifting the bottom out. The top of the cover will slip down while you lift the bottom out. (See figure 2).

Note:

Carefully not to disconnect any wires.

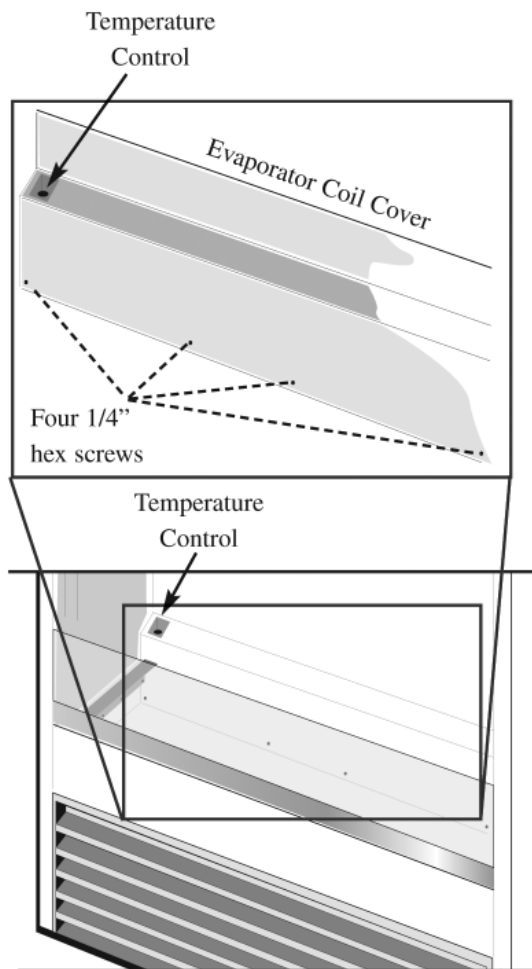

Figure 2

Warning
Wear protective gloves when lifting out evaporator coil cover.

STEP 5

A 5/32" Allen Key will be needed to adjust the temperature cut-out. One clock-wise turn of the cut-out screw means a change in temperature of 2-3° warmer. (See image 3).

Warning
Do not turn the cut-out screw more than one turn from the factory setting.

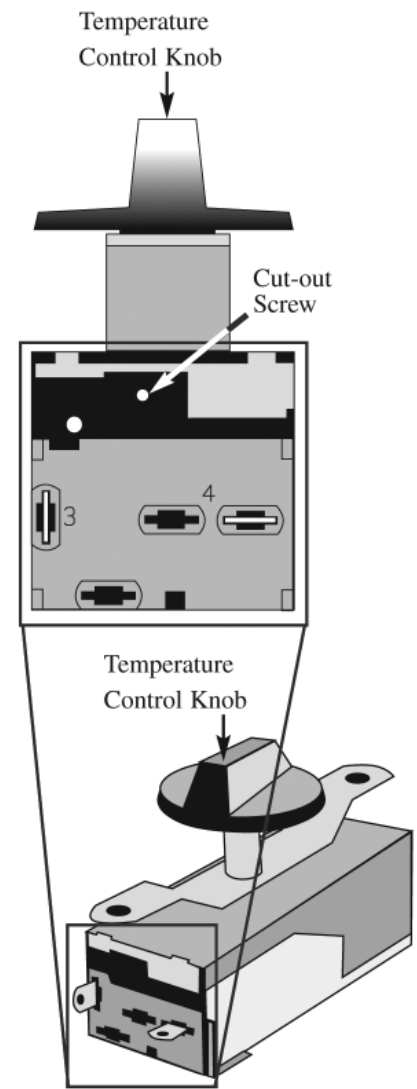

Figure 3

INSTALLATION / OPERATION INSTRUCTIONS

**TAC MECHANICAL TEMPERATURE CONTROL
ALTITUDE ADJUSTMENT ... CONTINUED ...**

Temperature Control Adjustments

An air curtain type of merchandiser is affected by the temperature and relative humidity of the surrounding ambient.

A. The adjustment knob and body of the temperature control is mounted to the left interior back panel of the cabinet, about six inches off of the "floor" of the cabinet, in a recessed area, near the evaporator coil.

-To raise the product temperature (*warm up* the cabinet), turn the control knob counterclockwise.

-To lower the product temperature (*cool down* the cabinet), turn the control knob clockwise.

B. If the above does not give desirable results, further adjustment is possible in the field. Disconnect power to the cabinet. Remove the full length back panel that the temperature control is mounted to: (See figure 1 & 2).

The temperature probe is inserted in the left end of the evaporator coil.

-To raise the product temperature (warm up the cabinet), relocate the temp. control probe in the top tube well location in the end of the coil.

-To lower the product temperature (cool down the cabinet), relocate the temp. control probe in the bottom tube well location in the end of the coil.

Note:

The sensor end of the temp. control should be inserted in the tube well until it stops (bottom out). Reassemble the lower back panel, restart the unit and set the control to midpoint "5", for further temperature adjustment.

End view - left end of the evaporator coil

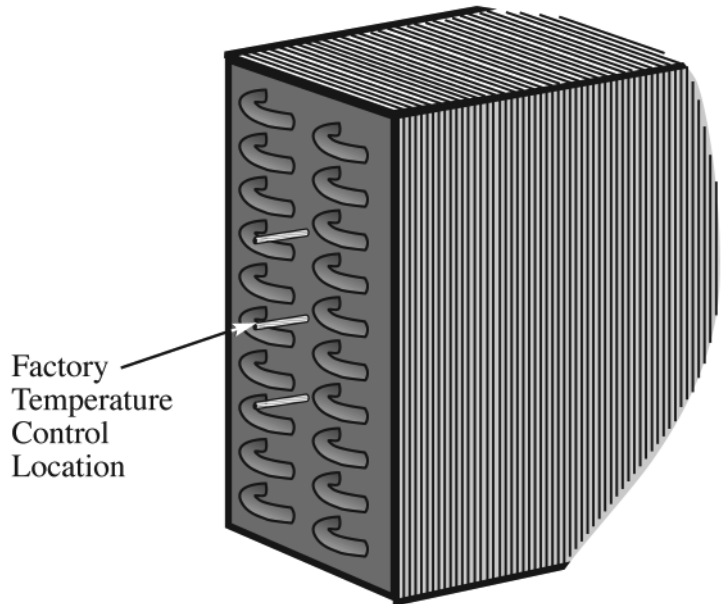

Figure 1

End view - left end of the evaporator coil

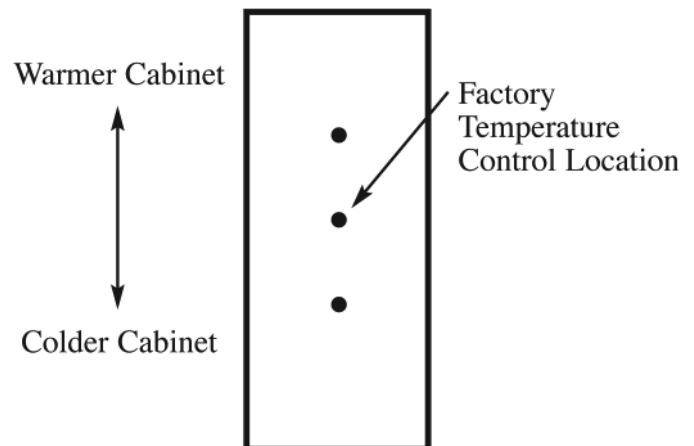

Figure 2

INSTALLATION / OPERATION INSTRUCTIONS

DEFROST TIME CLOCK OPERATION

Instructions for TAC-48, TAC-48GS, and TAC-72RC models.

RECOMMENDED DEFROST SETTINGS:

True Manufacturing has factory set your defrost time clock to a recommended time and duration defrost scenario. Your True equipment has been designed for three defrost periods (6:00 a.m., 2:00 p.m. and 10:00 p.m.). If you decide to deviate from these defrost time settings please follow the procedures for adjustment below.

NOTE:

Defrost timer will need to be set at current time of day before plugging unit into power supply. The defrost times have been set from the factory. If you want to change defrost times please read through the defrost timer instructions.

REQUIRED TOOLS:

- Phillips Screwdriver
- 1/4" Nut Driver or Socket

TAC Defrost Timer Location:

Defrost timer is located in a ballast box behind the front louvered grill on the left side of the unit. Four corner screws on the front louvered grill will need to be removed. The ballast box has two 1/4" hex head screws that need to be removed to gain access to the defrost control.

Setting the timer:

(UNPLUG UNIT FROM POWER SUPPLY!)

DO NOT SET THE TIME BY ROTATING THE "OUTER" DIAL.

Turn the minute hand clockwise until the time of day on the outer dial is aligned with the triangle marker on the inner dial (two o'clock position).

Adjusting The Defrost Timer:
(time initiated, time terminated)

Your True equipment contains a defrost system that is time initiated and time terminated. While True requires a minimum 3 defrost periods not to exceed 30 minutes the procedure on this page should be followed to customize your specific needs.

Notice:

If timer is not set for a minimum of 3 defrost per day for 30 minutes each, the coil may develop excessive frost. This may lead to system failure and product loss, which is not covered under warranty.

The following procedure may be followed to customize your needs.

High usage, high temperature, and high humidity may require 4 defrost settings per day.

WARNING:
Always follow the manufacturer's recommended settings when programming the amount and duration of the defrost cycles.

STEP 1

The white tabs located on the outmost area of the time clock have been factory set for (6:00 a.m., 2:00 p.m., and 10:00 p.m.). Each tab represents 15 minutes of defrost time. Notice that at each defrost time two white tabs are set for 15 minutes each for a total of 30 minutes of defrost.

STEP 2

In order to program the time to begin the defrost cycle, flip the white tabs out to set the defrost time. To eliminate a defrost time flip the white tabs back toward the center of the Defrost Timer.

STEP 3

True recommends a 30 minute defrost cycle three times per day.

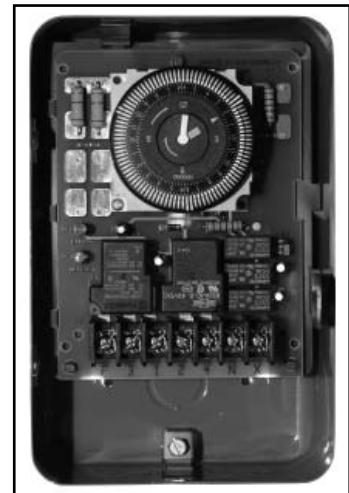

Defrost Timer Box Image 1

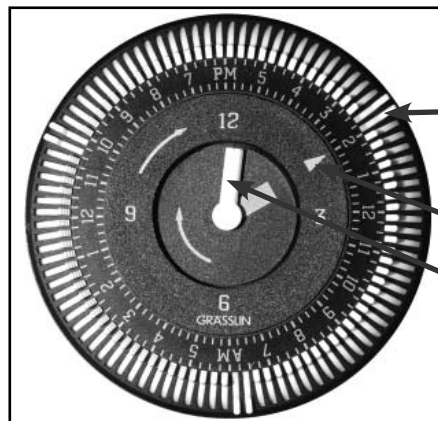

Defrost Timer Image 2

Outer most dial. White tabs represent 15 minutes of defrost time.

Time of day.

Inner most dial.

INSTALLATION / OPERATION INSTRUCTIONS

**TAC DIGITAL TEMPERATURE CONTROL
OPERATION**

Digital Temperature Control Commands



Use of LED

Each LED function is described in the following table.

LED	MODE	Function
	ON	The compressor is running
	FLASHING	- Programming Phase (flashing with LED) - Anti-short cycle delay enabled
	ON	The fan is running
	FLASHING	Programming Phase (flashing with LED)
	ON	The defrost is enabled

KEY COMBINATIONS

- + To lock & unlock the keyboard.
- + To lock & unlock the keyboard.
- + To lock & unlock the keyboard.

HOW TO SEE THE MINIMUM TEMPERATURE:

-
1. Press and release the key.
 2. The "Lo" message will be displayed followed by the minimum temperature recorded.
 3. By pressing the key or waiting for 5 seconds the normal display will be restored.

HOW TO SEE THE MAXIMUM TEMPERATURE:

-
1. Press and release the key.
 2. The "Hi" message will be displayed followed by the maximum temperature recorded.
 3. By pressing the key or waiting for 5s the normal display will be restored.

HOW TO RESET THE MAXIMUM AND MINIMUM TEMPERATURE RECORDED:

To reset the stored temperature, when maximum or minimum temperature is displayed:

1. Press SET key until "rST" label starts blinking.

HOW TO SEE AND MODIFY THE SET POINT:



1. Push and immediately release the SET key: the display will show the Set point value;
2. The SET LED start blinking;
3. To change the Set value push the or arrows within 10 seconds.

TO START A MANUAL DEFROST:



1. Push the Defrost key for more than 2 seconds and a manual defrost will start.

HOW TO LOCK THE KEYBOARD:



1. Keep the and keys pressed together for more than 3 seconds.



2. The "POF" message will be displayed and the keyboard is locked. At this point it is only possible to view the set point and the MAXIMUM OR MINIMUM temperatures stored.

TO UNLOCK THE KEYBOARD:

1. Keep the and keys pressed together for more than 3 seconds.
2. The "PON" message will be displayed and the keyboard is unlocked.

INSTALLATION / OPERATION INSTRUCTIONS

REMOTE UNITS (This section applies to remotes only!)

- Remote cabinets must be ordered as remote. We do not recommend converting from a standard self contained to remote system.
- All remote cabinets must be hard wired.
- No castors available.
- All remote cabinets come standard using 404A refrigerant.
- All remote units come standard with expansion valve, liquid line solenoid, heated condensate pan, and defrost timer when applicable.

- Contact True Technical Service for BTU requirements.
- No wiring necessary between cabinet and condensing unit.
- All remote condensing units purchased from True are 208/230 volts single phase.

If you have any questions regarding this section, please call True at 1-(800)-325-6152.

INSTALLING REMOTE UNITS

A. Refrigeration Line Connections

B. Drain Line Connection

C. Wire Connections

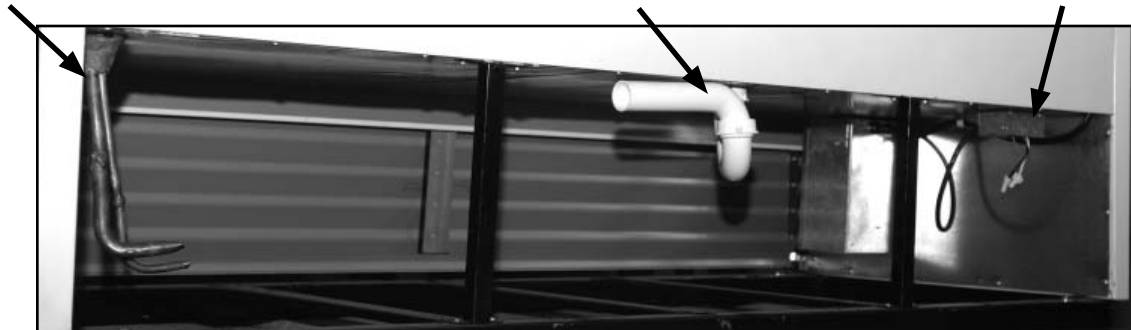

A. Refrigeration Line Connections - This cabinet is built standard with a 404A expansion valve. The temperature control operates a solenoid valve that opens and closes on demand for cooling. It is important to have a licensed refrigeration contractor install the refrigeration system to ensure proper operation of cabinet. For BTU information please contact True Technical Service at 1-800-325-6152

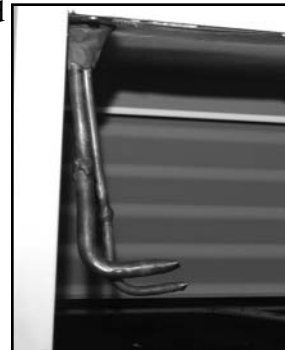

B. Drain Line Connection - A 1 1/2 inch P-trap is also shown in the picture. The trap can be rotated 360 degrees to allow for easy hook up. This should be done to meet local plumbing codes.

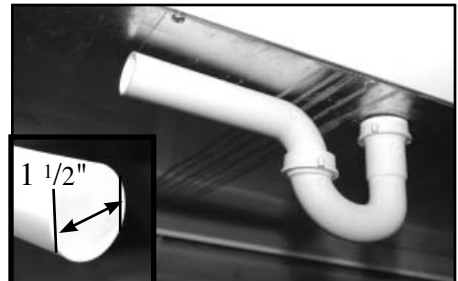

C. Wiring Connections - Wiring connections should be made in the electrical junction box shown in this picture. This cabinet is rated for 115 volt 15 amp circuit. Supply wiring connections should meet local electrical codes

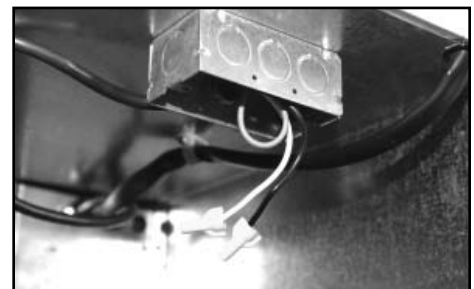

INSTALLATION / OPERATION INSTRUCTIONS

SHELVING INSTALLATION / OPERATION

SHELF INSTALLATION:

Step 1

- A. Hook shelf clips onto shelf standards. (see shelf Install illustration).
- B. Position all four shelf clips equal in distance from the floor for flat shelves.
Wire shelves are oriented so that cross support bars are facing down.

Step 2

Place shelves on shelf clips making sure all corners are seated properly.

NOTE

Do not load product to where it would over hang the shelf.

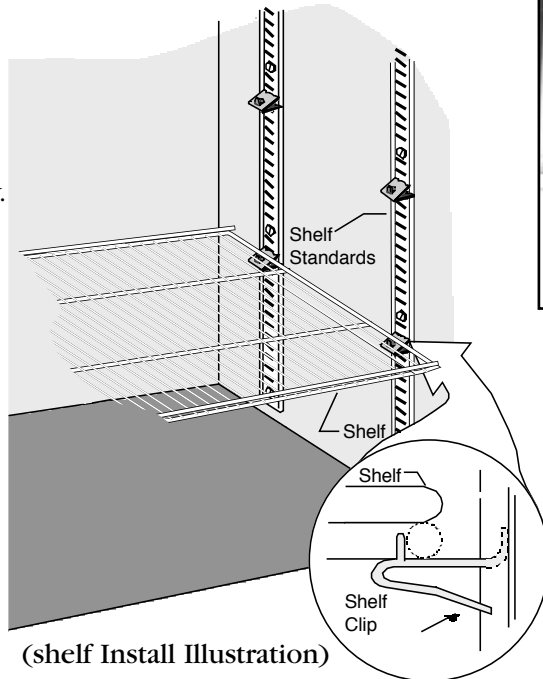

CANTILEVER SHELVING INSTALLATION:

Step 1

- A. Install the shelf supports into the shelf standards that are located in the rear corners of the cabinet. (See photos A & B).

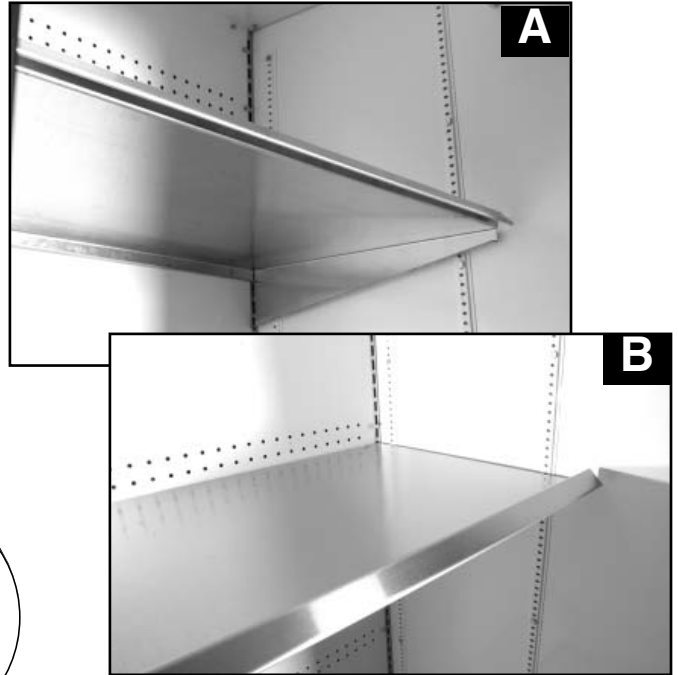

FLAVOR STRIP INSTALLATION

FLAVOR STRIP INSTALLATION:

- A. Take the shelf and turn it around. The back of the shelf should be facing out. (See image 1-2).
- B. The flavor strip snaps onto the shelf with the larger opening of the strip toward the bottom. (See image 3-4).
- C. After flavor strip is installed tags can be put into the flavor strip. (See image 5).

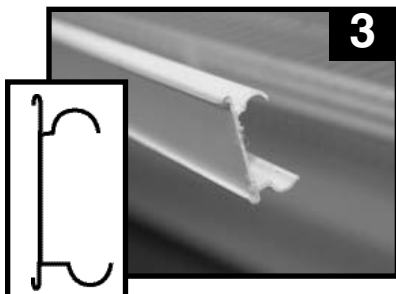
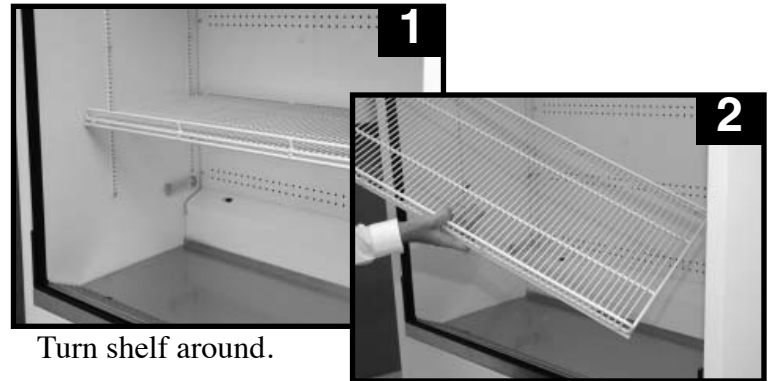

Flavor strip end view

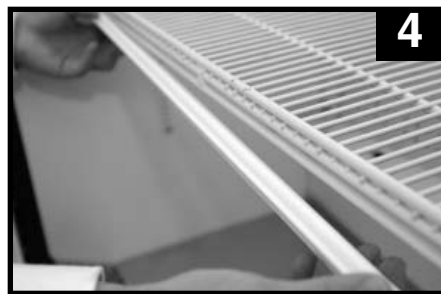

Flavor strip install.



MAINTENANCE, CARE & CLEANING

CLEANING THE CONDENSER COIL

When using electrical appliances, basic safety precautions should be followed, including the following

TOOLS REQUIRED:

- Phillips screwdriver
- Stiff bristle brush
- Adjustable wrench
- Vacuum

Step 1

Disconnect power to unit.

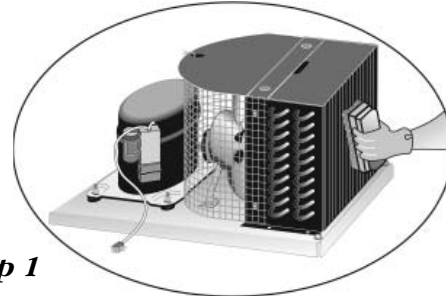

Step 1

Step 2

Take off front lower grill assembly by removing two (2) screws in lower corners.

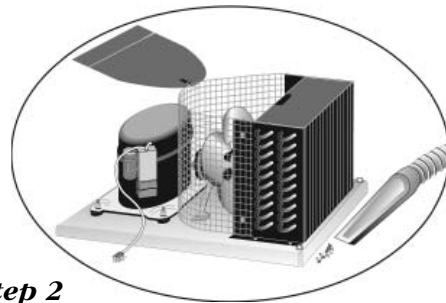

Step 2

Loosen screws holding the top pivot pins. Swing grill up and remove frame hooks from pivot pins at top of louver.

Step 3

Clean off accumulated dirt from condensing coil with a stiff bristle brush.

Step 4

After brushing condenser coil vacuum dirt from coil, and interior floor.

Step 5

Replace grill assembly.

Step 6

Connect unit to power and check to see if condensing unit is running.



All True TAC Models are manufactured with Reversing Condenser Fan Motors. This kind of fan motor allows less dust and dirt to accumulate onto the condenser coil. This reduces the required cleaning time of the condenser coil and allows for less expensive operating costs.

IMPORTANT WARRANTY INFORMATION

Condensers accumulate dirt and require cleaning every 30 days. Dirty condensers result in compressor failure, product loss, and lost sales... which are not covered by warranty.

If you keep the Condenser clean you will minimize your service expense and lower your electrical costs. The Condenser requires scheduled cleaning every thirty days or as needed.

Air is pulled through the Condenser continuously, along with dust, lint, grease, etc.

A dirty Condenser can result in NON-WARRANTEED part & Compressor Failures, Product Loss, and Lost Sales.

Proper cleaning involves removing dust from the Condenser. By using a soft brush, or vacuuming the Condenser with a shop vac, or using CO₂, nitrogen, or pressurized air.

If you cannot remove the dirt adequately, please call your refrigeration service company.

The Condenser looks like a group of vertical fins. You need to be able to see through the condenser for the unit to function at maximum capacity. Do not place filter material in front of condensing coil. This material blocks air-flow to the coil similar to having a dirty coil.

THE CLEANING OF THE CONDENSER IS NOT COVERED BY THE WARRANTY!

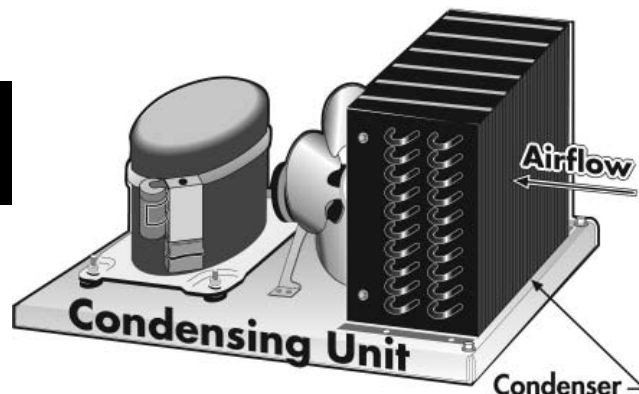

HOW TO CLEAN THE CONDENSER:

- 1. Disconnect the electrical power to the unit.**
- 2. Remove the louvered grill.**
- 3. Vacuum or brush the dirt, lint, or debris from the finned condenser coil.**
- 4. If you have a significant dirt build up you can blow out the condenser with compressed air. (CAUTION MUST BE USED to avoid eye injury. Eye protection is recommended.)**
- 5. When finished be sure to replace the louvered grill. The grill protects the condenser.**
- 6. Reconnect the electrical power to the unit.**

If you have any questions, please call True Manufacturing at 636-240-2400 or 800-325-6152 and ask for the Service Department. Service Department Availability Monday-Friday 7:30 a.m. to 5:30 p.m. and Saturday 7:45 a.m. to 11:45 a.m. CST.

MAINTENANCE, CARE & CLEANING

STAINLESS STEEL EQUIPMENT CARE AND CLEANING

CAUTION: Do not use any steel wool, abrasive or chlorine based products to clean stainless steel surfaces.

• Stainless Steel Opponents

There are three basic things which can break down your stainless steel's passivity layer and allow corrosion to rear its ugly head.

- 1) Scratches from wire brushes, scrapers, and steel pads are just a few examples of items that can be abrasive to stainless steel's surface.
- 2) Deposits left on your stainless steel can leave spots. You may have hard or soft water depending on what part of the country you live in. Hard water can leave spots. Hard water that is heated can leave deposits if left to sit too long. These deposits can cause the passive layer to break down and rust your stainless steel. All deposits left from food prep or service should be removed as soon as possible.
- 3) Chlorides are present in table salt, food, and water. Household and industrial cleaners are the worst type of chlorides to use.

8 steps that can help prevent rust on stainless steel:**1. Using the correct cleaning tools**

Use non-abrasive tools when cleaning your stainless steel products. The stainless steel's passive layer will not be harmed by soft cloths and plastic scouring pads. Step 2 tells you how to find the polishing marks.

2. Cleaning along the polish lines

Polishing lines or "grain" are visible on some stainless steels. Always scrub parallel to visible lines on some stainless steels. Use a plastic scouring pad or soft cloth when you cannot see the grain.

3. Use alkaline, alkaline chlorinated or non-chloride containing cleaners

While many traditional cleaners are loaded with chlorides, the industry is providing an ever increasing choice of non-chloride cleaners. If you are not sure of your cleaner's chloride content contact your cleaner supplier. If they tell you that your present cleaner contains chlorides, ask if they have an alternative. Avoid cleaners containing quaternary salts as they can attack stainless steel, causing pitting and rusting.

4. Water Treatment

To reduce deposits, soften the hard water when possible. Installation of certain filters can remove corrosive and distasteful elements. Salts in a properly maintained water softener can be to your advantage. Contact a treatment specialist if you are not sure of the proper water treatment.

5. Maintaining the cleanliness of your food equipment

Use cleaners at recommended strength (alkaline, alkaline chlorinated or non-chloride). Avoid build-up of hard stains by cleaning frequently. When boiling water with your stainless steel equipment, the single most likely cause of damage is chlorides in the water. Heating any cleaners containing chlorides will have the same damaging effects.

6. Rinse

When using chlorinated cleaners you must rinse and wipe dry immediately. It is better to wipe standing cleaning agents and water as soon as possible. Allow the stainless steel equipment to air dry. Oxygen helps maintain the passivity film on stainless steel.

7. Hydrochloric acid (muriatic acid) should never be used on stainless steel**8. Regularly restore/passivate stainless steel**

MAINTENANCE, CARE & CLEANING

STAINLESS STEEL EQUIPMENT CARE AND CLEANING

Recommended cleaners for certain situations / environments of stainless steel

- A) Soap, ammonia and detergent medallion applied with a cloth or sponge can be used for routine cleaning.
- B) Arcal 20, Lac-O-Nu Ecoshine applied provides barrier film for fingerprints and smears.
- C) Cameo, Talc, Zud First Impression is applied by rubbing in the direction of the polished lines for stubborn stains and discoloring.
- D) Easy-off and De-Grease It oven aid are excellent for removals on all finishes for grease-fatty acids, blood and burnt-on foods.
- E) Any good commercial detergent can be applied with a sponge or cloth to remove grease and oil.
- F) Benefit, Super Sheen, Sheila Shine are good for restoration / passivation.

NOTE:
The use of stainless steel cleaners or other such solvents is not recommended on plastic parts. Warm soap and water will suffice.

LIGHT BULB REPLACEMENT

WARNING: Disconnect power to cabinet before replacing light bulbs.

Light Bulb Replacement:

- Hold firmly on the end of the light bulb and pull toward the center of the cabinet. The lampholders are spring activated so the bulb can easily be replaced. (See Image 1).
- When installing a new bulb make sure the prongs at the end of the bulb seat appropriately into the lampholder. (See Image 2).



IDL (Integrated Door Lighting)

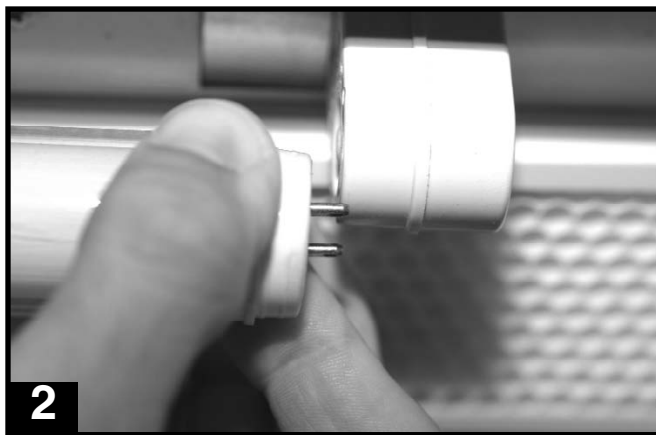

IDL (Integrated Door Lighting)



WARRANTY INFORMATION (U.S.A. & CANADA ONLY!)

ONE YEAR PARTS & LABOR WARRANTY

TRUE warrants to the original purchaser of every new TRUE refrigerated unit, the cabinet and all parts thereof, to be free from defects in material or workmanship, under normal and proper use and maintenance service as specified by TRUE and upon proper installation and start-up in accordance with the instruction packet supplied with each TRUE unit. TRUE's obligation under this warranty is limited to a period of one (1) year from the date of original installation or 15 months after shipment date from TRUE, whichever occurs first.

Any part covered under this warranty that are determined by TRUE to have been defective within one (1) year of original installation or fifteen (15) months after shipment date from manufacturer, whichever occurs first, is limited to the repair or replacement, including labor charges, of defective parts or assemblies. The labor warranty shall include standard straight time labor charges only and reasonable travel time, as determined by TRUE.

ADDITIONAL FOUR YEAR COMPRESSOR WARRANTY

In addition to the one (1) year warranty stated above, TRUE warrants its hermetically and semi-hermetically sealed compressor to be free from defects in both material and workmanship under normal and proper use and maintenance service for a period of four (4) additional years from the date of original installation but not to exceed five (5) years and three (3) months after shipment from the manufacturer.

Compressors determined by TRUE to have been defective within this extended time period will, at TRUE's option, be either repaired or replaced with a compressor or compressor parts of similar design and capacity.

The four (4) year extended compressor warranty applies only to hermetically and semi-hermetically sealed parts of the compressor and does not apply to any other parts or components, including, but not limited to, cabinet, paint finish, temperature control, refrigerant, metering device, driers, motor starting equipment, fan assembly or any other electrical component, etcetera.

404A/134A COMPRESSOR WARRANTY

The four year compressor warranty detailed above will be voided if the following procedure is not carefully adhered to:

1. This system contains R404A or R134A refrigerant and polyol ester lubricant. The polyol ester lubricant has rapid moisture absorbing qualities. If long exposure to the ambient conditions occur, the lubricant must be removed and replaced with new. For oil amounts and specifications please call True technical service department (800-325-6152). Failure to comply with recommended lubricant specification will void the compressor warranty.

2. Drier replacement is very important and must be changed when a system is opened for servicing. A drier using XH-7 desiccant or an exact replacement solid core drier must be used. The new drier must also be the same capacity as the drier being replaced.

3. Micron level vacuums must be achieved to insure low moisture levels in the system. 500 microns or lower must be obtained.

WARRANTY CLAIMS

All claims for labor or parts must be made directly through TRUE. All claims should include: model number of the unit, the serial number of the cabinet, proof of purchase, date of installation, and all pertinent information supporting the existence of the alleged defect.

In case of warranty compressor, the compressor model tag must be returned to TRUE along with above listed information.

Any action or breach of these warranty provisions must be commenced within one (1) year after that cause of action has occurred.

WHAT IS NOT COVERED BY THIS WARRANTY

TRUE's sole obligation under this warranty is limited to either repair or replacement of parts, subject to the additional limitations below. This warranty neither assumes nor authorizes any person to assume obligations other than those expressly covered by this warranty.

NO CONSEQUENTIAL DAMAGES. TRUE IS NOT RESPONSIBLE FOR ECONOMIC LOSS; PROFIT LOSS; OR SPECIAL, INDIRECT, OR CONSEQUENTIAL DAMAGES, INCLUDING WITHOUT LIMITATION, LOSSES OR DAMAGES ARISING FROM FOOD OR PRODUCT SPOILAGE CLAIMS WHETHER OR NOT ON ACCOUNT OF REFRIGERATION FAILURE.

WARRANTY IS NOT TRANSFERABLE. This warranty is not assignable and applies only in favor of the original purchaser/user to whom delivered. ANY SUCH ASSIGNMENT OR TRANSFER SHALL VOID THE WARRANTIES HEREIN MADE AND SHALL VOID ALL WARRANTIES, EXPRESS OR IMPLIED, INCLUDING ANY WARRANTY OF MERCHANTABILITY OR FITNESS FOR A PARTICULAR PURPOSE.

IMPROPER USAGE. TRUE ASSUMES NO LIABILITY FOR PARTS OR LABOR COVERAGE FOR COMPONENT FAILURE OR OTHER DAMAGES RESULTING FROM IMPROPER USAGE OR INSTALLATION OR FAILURE TO CLEAN AND/OR MAINTAIN PRODUCT AS SET FORTH IN THE WARRANTY PACKET PROVIDED WITH THE UNIT.

ALTERATION, NEGLIGENCE, ABUSE, MISUSE, ACCIDENT, DAMAGE DURING TRANSIT OR INSTALLATION, FIRE, FLOOD, ACTS OF GOD. TRUE is not responsible for the repair or replacement of any parts that TRUE determines have been subjected after the date of manufacture to alteration, neglect, abuse, misuse, accident, damage during transit or installation, fire, flood, or act of God.

IMPROPER ELECTRICAL CONNECTIONS. TRUE IS NOT RESPONSIBLE FOR THE REPAIR OR REPLACEMENT OF FAILED OR DAMAGED COMPONENTS RESULTING FROM ELECTRICAL POWER FAILURE, THE USE OF EXTENSION CORDS, LOW VOLTAGE, OR VOLTAGE DROPS TO THE UNIT.

NO IMPLIED WARRANTY OF MERCHANTABILITY OR FITNESS FOR A PARTICULAR PURPOSE: THERE ARE NO OTHER WARRANTIES, EXPRESSED, IMPLIED OR STATUTORY, EXCEPT THE ONE (1) YEAR PARTS & LABOR WARRANTY AND THE ADDITIONAL FOUR (4) YEAR COMPRESSOR WARRANTY AS DESCRIBED ABOVE. THESE WARRANTIES ARE EXCLUSIVE AND IN LIEU OF ALL OTHER WARRANTIES, INCLUDING IMPLIED WARRANTY AND MERCHANTABILITY OR FITNESS FOR A PARTICULAR PURPOSE. THERE ARE NO WARRANTIES WHICH EXTEND BEYOND THE DESCRIPTION ON THE FACE HEREOF.

OUTSIDE U.S.: This warranty does not apply to, and TRUE is not responsible for, any warranty claims made on products sold or used outside the United States.

REMOTE CONDENSERS: True warrants the original purchaser of the remote cabinet one year parts and labor coverage for all cabinet parts thereof to be free from defects in material or workmanship, under normal and proper use and maintenance service, as specified by True. This warranty is limited to the cabinet only. True assumes no liability for remote condensing units.