

DVD HOME THEATER SOUND SYSTEM**DVX-S100**

DVX-S100: DVR-S100 + NX-S100S + NX-S100C + SW-S100

IMPORTANT SAFETY INSTRUCTIONS

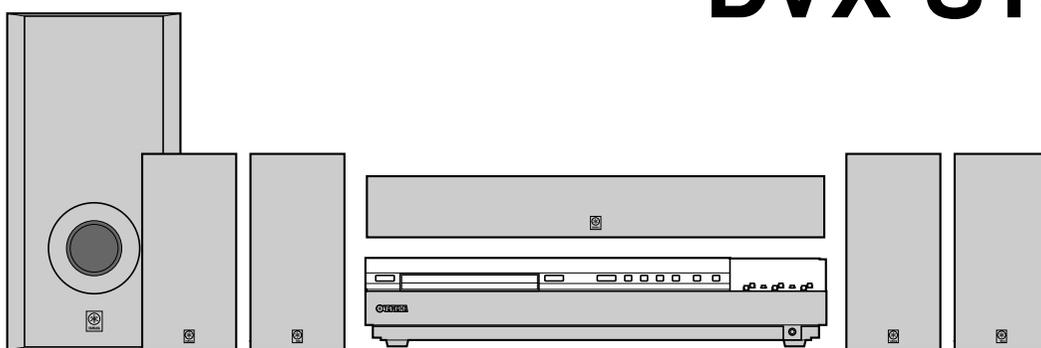
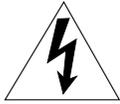

CAUTION

RISK OF ELECTRIC SHOCK
DO NOT OPEN



CAUTION: TO REDUCE THE RISK OF ELECTRIC SHOCK, DO NOT REMOVE COVER (OR BACK). NO USER-SERVICEABLE PARTS INSIDE. REFER SERVICING TO QUALIFIED SERVICE PERSONNEL.

• Explanation of Graphical Symbols

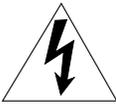

The lightning flash with arrowhead symbol, within an equilateral triangle, is intended to alert you to the presence of uninsulated “dangerous voltage” within the product’s enclosure that may be of sufficient magnitude to constitute a risk of electric shock to persons.



The exclamation point within an equilateral triangle is intended to alert you to the presence of important operating and maintenance (servicing) instructions in the literature accompanying the appliance.

WARNING

TO REDUCE THE RISK OF FIRE OR ELECTRIC SHOCK, DO NOT EXPOSE THIS UNIT TO RAIN OR MOISTURE.

- 1 Read Instructions – All the safety and operating instructions should be read before the product is operated.
- 2 Retain Instructions – The safety and operating instructions should be retained for future reference.
- 3 Heed Warnings – All warnings on the product and in the operating instructions should be adhered to.
- 4 Follow Instructions – All operating and use instructions should be followed.
- 5 Cleaning – Unplug this product from the wall outlet before cleaning. Do not use liquid cleaners or aerosol cleaners. Use a damp cloth for cleaning.
- 6 Attachments – Do not use attachments not recommended by the product manufacturer as they may cause hazards.
- 7 Water and Moisture – Do not use this product near water – for example, near a bath tub, wash bowl, kitchen sink, or laundry tub; in a wet basement; or near a swimming pool; and the like.
- 8 Accessories – Do not place this product on an unstable cart, stand, tripod, bracket, or table. The product may fall, causing serious injury to a child or adult, and serious damage to the product. Use only with a cart, stand, tripod, bracket, or table recommended by the manufacturer, or sold with the product. Any mounting of the product should follow the manufacturer’s instructions, and should use a mounting accessory recommended by the manufacturer.
- 9 A product and cart combination should be moved with care. Quick stops, excessive force, and uneven surfaces may cause the product and cart combination to overturn.



- 10 Ventilation – Slots and openings in the cabinet are provided for ventilation and to ensure reliable operation of the product and to protect it from overheating, and these openings must not be blocked or covered. The openings should never be blocked by placing the product on a bed, sofa, rug, or other similar surface. This product should not be placed in a built-in installation such as a bookcase or rack unless proper ventilation is provided or the manufacturer’s instructions have been adhered to.
- 11 Power Sources – This product should be operated only from the type of power source indicated on the marking label. If you are not sure of the type of power supply to your home, consult your product dealer or local power company. For products intended to operate from battery power, or other sources, refer to the operating instructions.
- 12 Grounding or Polarization – This product may be equipped with a polarized alternating current line plug (a plug having one blade wider than the other). This plug will fit into the power outlet only one way. This is a safety feature. If you are unable to insert the plug fully into the outlet, try reversing the plug. If the plug should still fail to fit, contact your electrician to replace your obsolete outlet. Do not defeat the safety purpose of the polarized plug.
- 13 Power-Cord Protection – Power-supply cords should be routed so that they are not likely to be walked on or pinched by items placed upon or against them, paying particular attention to cords at plugs, convenience receptacles, and the point where they exit from the product.
- 14 Lightning – For added protection for this product during a lightning storm, or when it is left unattended and unused for long periods of time, unplug it from the wall outlet and disconnect the antenna or cable system. This will prevent damage to the product due to lightning and power-line surges.
- 15 Power Lines – An outside antenna system should not be located in the vicinity of overhead power lines or other electric light or power circuits, or where it can fall into such power lines or circuits. When installing an outside antenna system, extreme care should be taken to keep from touching such power lines or circuits as contact with them might be fatal.
- 16 Overloading – Do not overload wall outlets, extension cords, or integral convenience receptacles as this can result in a risk of fire or electric shock.
- 17 Object and Liquid Entry – Never push objects of any kind into this product through openings as they may touch dangerous voltage points or short-out parts that could result in a fire or electric shock. Never spill liquid of any kind on the product.
- 18 Servicing – Do not attempt to service this product yourself as opening or removing covers may expose you to dangerous voltage or other hazards. Refer all servicing to qualified service personnel.
- 19 Damage Requiring Service – Unplug this product from the wall outlet and refer servicing to qualified service personnel under the following conditions:
 - a) When the power-supply cord or plug is damaged,
 - b) If liquid has been spilled, or objects have fallen into the product,
 - c) If the product has been exposed to rain or water,

CAUTION

- d) If the product does not operate normally by following the operating instructions. Adjust only those controls that are covered by the operating instructions as an improper adjustment of other controls may result in damage and will often require extensive work by a qualified technician to restore the product to its normal operation,
 - e) If the product has been dropped or damaged in any way, and
 - f) When the product exhibits a distinct change in performance - this indicates a need for service.
- 20 Replacement Parts – When replacement parts are required, be sure the service technician has used replacement parts specified by the manufacturer or have the same characteristics as the original part. Unauthorized substitutions may result in fire, electric shock, or other hazards.
- 21 Safety Check – Upon completion of any service or repairs to this product, ask the service technician to perform safety checks to determine that the product is in proper operating condition.
- 22 Wall or Ceiling Mounting – The unit should be mounted to a wall or ceiling only as recommended by the manufacturer.
- 23 Heat – The product should be situated away from heat sources such as radiators, heat registers, stoves, or other products (including amplifiers) that produce heat.

- 24 Outdoor Antenna Grounding – If an outside antenna or cable system is connected to the product, be sure the antenna or cable system is grounded so as to provide some protection against voltage surges and built-up static charges. Article 810 of the National Electrical Code, ANSI/NFPA 70, provides information with regard to proper grounding of the mast and supporting structure, grounding of the lead-in wire to an antenna discharge unit, size of grounding conductors, location of antenna discharge unit, connection to grounding electrodes, and requirements for the grounding electrode.

EXAMPLE OF ANTENNA GROUNDING

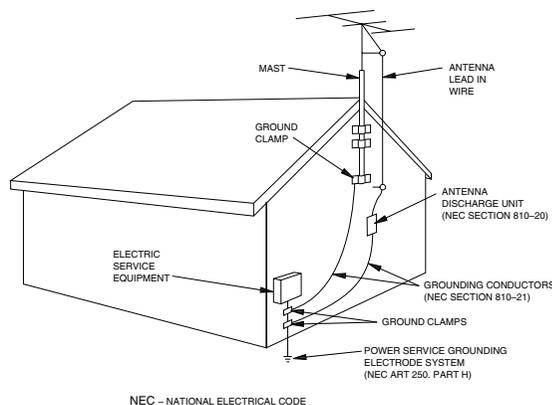

NEC – NATIONAL ELECTRICAL CODE

Note to CATV system installer:

This reminder is provided to call the CATV system installer's attention to Article 820-40 of the NEC that provides guidelines for proper grounding and, in particular, specifies that the cable ground shall be connected to the grounding system of the building, as close to the point of cable entry as practical.

FCC INFORMATION (for US customers only)

1. IMPORTANT NOTICE : DO NOT MODIFY THIS UNIT!

This product, when installed as indicated in the instructions contained in this manual, meets FCC requirements. Modifications not expressly approved by Yamaha may void your authority, granted by the FCC, to use the product.

2. **IMPORTANT :** When connecting this product to accessories and/or another product use only high quality shielded cables. Cable/s supplied with this product **MUST** be used. Follow all installation instructions. Failure to follow instructions could void your FCC authorization to use this product in the USA.

3. **NOTE :** This product has been tested and found to comply with the requirements listed in FCC Regulations, Part 15 for Class "B" digital devices. Compliance with these requirements provides a reasonable level of assurance that your use of this product in a residential environment will not result in harmful interference with other electronic devices. This equipment generates/uses radio frequencies and, if not installed and used according to the instructions found in the users manual, may cause interference harmful to the operation of other electronic devices.

Compliance with FCC regulations does not guarantee that interference will not occur in all installations. If this product is found to be the source of interference, which can be determined by turning the unit "OFF" and "ON", please try to eliminate the problem by using one of the following measures:

Relocate either this product or the device that is being affected by the interference.

Utilize power outlets that are on different branch (circuit breaker or fuse) circuits or install AC line filter/s.

In the case of radio or TV interference, relocate/reorient the antenna. If the antenna lead-in is 300 ohm ribbon lead, change the lead-in to coaxial type cable.

If these corrective measures do not produce satisfactory results, please contact the local retailer authorized to distribute this type of product. If you can not locate the appropriate retailer, please contact Yamaha Electronics Corp., U.S.A. 6660 Orangethorpe Ave, Buena Park, CA 90620.

The above statements apply **ONLY** to those products distributed by Yamaha Corporation of America or its subsidiaries.

CAUTION: READ THIS BEFORE OPERATING YOUR UNIT.

- 1 To assure the finest performance, please read this manual carefully. Keep it in a safe place for future reference.
- 2 Install this sound system in a well ventilated, cool, dry, clean place with at least 10 cm on the top, 10 cm on the left and right, and 10 cm at the back of DVR-S100, and 20 cm on the top, 10 cm on the left and right, and 10 cm at the back of SW-S100 — away from direct sunlight, heat sources, vibration, dust, moisture, and/or cold.
- 3 Locate this unit away from other electrical appliances, motors, or transformers to avoid humming sounds. To prevent fire or electrical shock, do not place this unit where it may get exposed to dripping or splashing, and never put any objects filled with liquids, such as vases, on the top of the unit.
- 4 Do not expose this unit to sudden temperature changes from cold to hot, and do not locate this unit in a environment with high humidity (i.e. a room with a humidifier) to prevent condensation inside this unit, which may cause an electrical shock, fire, damage to this unit, and/or personal injury.
- 5 Avoid installing this unit in a place where foreign objects and liquid might fall. It might cause a fire, damage to this unit and/or personal injury. Do not place the following objects on this unit:
 - Other components, as they may cause damage and/or discoloration on the surface of this unit.
 - Burning objects (i.e. candles), as they may cause fire, damage to this unit, and/or personal injury.
 - Containers with liquid in them, as they may cause electrical shock to the user and/or damage to this unit.
- 6 Do not cover this unit with a newspaper, tablecloth, curtain, etc. in order not to obstruct heat radiation. If the temperature inside this unit rises, it may cause fire, damage to this unit, and/or personal injury.
- 7 Do not plug in this unit to a wall outlet until all connections are complete.
- 8 Do not operate this unit upside-down. It may overheat, possibly causing damage.
- 9 Do not use force on switches, knobs and/or cords.
- 10 When disconnecting the power cord from the wall outlet, grasp the plug; do not pull the cord.
- 11 Do not clean this unit with chemical solvents; this might damage the finish. Use a clean, dry cloth.
- 12 Only voltage specified on this unit must be used. Using this unit with a higher voltage than specified is dangerous and may cause fire, damage to this unit, and/or personal injury. YAMAHA will not be held responsible for any damage resulting from use of this unit with a voltage other than specified.
- 13 To prevent damage by lightning, disconnect the power cord from the wall outlet during an electrical storm.
- 14 Take care of this unit so that no foreign objects and/or liquid drops inside this unit.
- 15 Do not attempt to modify or fix this unit. Contact qualified YAMAHA service personnel when any service is needed. The cabinet should never be opened for any reasons.
- 16 When not planning to use this unit for long periods of time (i.e. vacation), disconnect the AC power plug from the wall outlet.
- 17 Be sure to read the “TROUBLESHOOTING” section on common operating errors before concluding that this unit is faulty.
- 18 Before moving this unit, press STANDBY/ON to set this unit in the standby mode, and disconnect the AC power plug from the wall outlet.
- 19 **VOLTAGE SELECTOR** (General model only)
The **VOLTAGE SELECTOR** on the rear panel of this unit must be set for your local main voltage **BEFORE** plugging into the AC main supply.
Voltages are 220/240 V AC, 50 Hz.

This unit is not disconnected from the AC power source as long as it is connected to the wall outlet, even if this unit itself is turned off. This state is called the standby mode. In this state, this unit is designed to consume a very small quantity of power.

IMPORTANT

Please record the serial number of this unit in the space below.

MODEL:

Serial No.:

The serial number is located on the bottom of the unit.

Retain this Owner's Manual in a safe place for future reference.

FOR CANADIAN CUSTOMERS

To prevent electric shock, match wide blade of plug to wide slot and fully insert.

This Class B digital apparatus complies with Canadian ICES-003.

DANGER

Visible laser radiation when open. Avoid direct exposure to beam.

When this unit is plugged to the wall outlet, do not place your eyes close to the opening of the disc tray and other openings to look into inside.

The laser component in this product is capable of emitting radiation exceeding the limit for Class 1.

The name plate is located on the bottom of the unit.

We Want You Listening For A Lifetime

YAMAHA and the Electronic Industries Association's Consumer Electronics Group want you to get the most out of your equipment by playing it at a safe level. One that lets the sound come through loud and clear without annoying blaring or distortion – and, most importantly, without affecting your sensitive hearing.

Since hearing damage from loud sounds is often undetectable until it is too late, YAMAHA and the Electronic Industries Association's Consumer Electronics Group recommend you to avoid prolonged exposure from excessive volume levels.



CAUTION

CONTENTS

INTRODUCTION

FEATURES	2
CHECKING THE ACCESSORIES	3
INSTALLING BATTERIES IN THE REMOTE	
CONTROL	3
CONTROLS AND FUNCTIONS	4
Front panel	4
Remote control (AMP mode)	6
Front panel display (left)	8
Front panel display (right)	9

PREPARATION

PREPARATION STEPS	10
SPEAKER SETUP	11
Speaker placement	11
Installing the speakers	12
CONNECTIONS	14
Connecting TV and audio/video components	14
Connecting the antennas	16
Connecting the speakers	17
Connecting to an external amplifier	19
Connecting the AC power cord	19
Turning on the power	19
ADJUSTING SPEAKER OUTPUT LEVELS	20
Using the test tone	20

USING BASIC FUNCTIONS

BASIC PLAYBACK	21
Basic operations	21
Selecting a sound field program	23
RECORDING	28

PLAYING A DISC

DISC INFORMATION	29
Types of disc that this unit can play	29
Region management information	29
Notes about handling discs	29
MP3 playback	30
REMOTE CONTROL (DVD MODE)	31
PLAYING A DISC	32
Basic operation	32
ON-SCREEN MENU	34
Operating menu bar	34
Icons for disc menu	35
Icons for player menu	36
USING MULTIPLE FUNCTIONS	38
Using a disc's menu	38
Enhancing video quality	
[U.S.A. and Canada models only]	38
DVD-Audio features	39
Enhancing audio quality (DISC DIRECT)	40
Switching audio tracks, subtitles and angles	41
All group play	42
Programmed play	42
Random play	43
Bookmarks	44
Repeat play	45
Repeat A-B	46

SETUP MENU	47
Operating the setup menu	47
Summary of settings	48
Ratings	51
PCM down conversion	51
Speaker settings	52

TUNING

TUNING	54
Automatic and manual tuning	54
Presetting stations	55
Tuning in to a preset station	56
Exchanging preset stations	56

REMOTE CONTROL FEATURES

OPERATING OTHER COMPONENTS USING THE REMOTE CONTROL	57
Setting the manufacturer code	57

ADJUSTMENTS

SET MENU	59
List of SET MENU items	59
Adjusting the items on the SET MENU	59
1 SPEAKER SET (speaker mode settings)	60
2 LFE LEVEL	61
3 SP DLY TIME (speaker delay time)	62
4 D. RANGE (dynamic range)	62
5 L/R BALANCE (balance of the front left and right speakers)	62
6 HP TONE CTRL (headphone tone control)	62
7 I/O ASSIGN (input assignment)	63
8 INPUT MODE (initial input mode)	63
9 SP/PRE OUT (output source settings)	63
ADJUSTING THE LEVEL OF THE EFFECT SPEAKERS	64
CHANGING THE PARAMETER SETTINGS FOR DSP PROGRAMS	65
Adjusting the delay time	65
Adjusting the parameter settings for PRO LOGIC II Music	66

APPENDIX

TROUBLESHOOTING	67
GLOSSARY	72
SPECIFICATIONS	75

FEATURES

The DVX-S100 is the Home Theater Sound System that delivers a powerful and realistic sound experience like that found in a movie theater just by combining the unit with the TV.

The newest DSP programs will enhance the power and realism of various sources, from movies to concerts, and sporting events. Also, the Silent Cinema program allows you to enjoy the sound field even through the headphones. Since the DVX-S100 consists of a DVD Audio/Video receiver, a center speaker, front speakers, rear speakers and a subwoofer, you can enjoy stronger bass and surround effects as well as a good balance throughout the speakers.

Moreover, the One-touch connection of the speaker connectors designed exclusively for this unit allows you to easily connect the speakers.

- ◆ Built-in 5-channel power amplifier
- ◆ DVD-AUDIO/VIDEO, CD, VCD, MP3, CD-R/RW playback
- ◆ Dolby Pro Logic/Dolby Pro Logic II decoder
- ◆ Dolby Digital/Dolby Digital + Matrix 6.1 decoder
- ◆ DTS/DTS + Matrix 6.1 decoder
- ◆ Sophisticated FM/AM tuner
- ◆ CINEMA DSP: Combination of YAMAHA DSP technology and Dolby Pro Logic, Dolby Digital or DTS
- ◆ Virtual CINEMA DSP
- ◆ SILENT CINEMA DSP
- ◆ Easy connection of the center speaker, front speakers and rear speakers using special speaker connectors designed exclusively for this unit
- ◆ Multi-function remote control which can also be used for other audio/video components of certain manufacturers

■ About this manual

-  indicates a tip for your operation.
- Some operations can be performed by using the buttons on either the main unit or the remote control. In this case, the operations performed by using the remote control are described in this manual.
- This manual is printed prior to production. Design and specifications are subject to change in part for the reason of the improvement in operativity ability, and others. In this case, the product has priority.
- Some of the illustrations and names of the package contents etc written in this manual may differ from the actual products and the names written on the package etc.



Manufactured under license from Dolby Laboratories. "Dolby", "Pro Logic", and the double-D symbol are trademarks of Dolby Laboratories.



"DTS" and "DTS Digital Surround" are registered trademarks of Digital Theater Systems, Inc.

(U.S.A. and Canada models)



"DCDi" is a trademark of Faroudja, a division of Sage Inc.

This product incorporates copyright protection technology that is protected by method claims of certain U.S. patents and other intellectual property rights owned by Macrovision Corporation and other rights owners. Use of this copyright protection technology must be authorized by Macrovision Corporation, and is intended for home and other limited viewing uses only unless otherwise authorized by Macrovision Corporation. Reverse engineering or disassembly is prohibited.

CHECKING THE ACCESSORIES

Check your package to make sure it contains the following items.

DVR-S100

Remote control

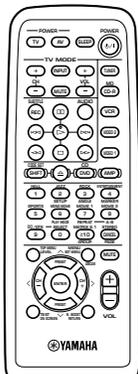

Batteries (x2)
(AA, R06, UM-3)

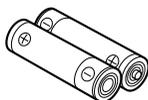

AM loop antenna

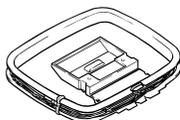

Indoor FM antenna
(U.S.A., Canada and
General models)



(Europe, U.K. and
Australia models)



NX-SW100 (NX-S100S x4, NX-S100C, SW-S100)

Fasteners (4 sets)
for the center
speaker

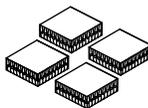

Pads
(2 sets: 16 pieces)



Non-skid pads
(2 sets: 16 pieces)

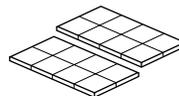

Speaker cables
(for the rear speakers: 15m (x2),
for the front/center
speaker:
5m (x3))

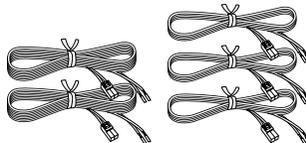

System connector
cable (5m x 1)

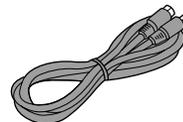

INSTALLING BATTERIES IN THE REMOTE CONTROL

Insert the batteries in the correct direction by aligning the + and - marks on the batteries with the polarity markings (+ and -) inside the battery compartment.

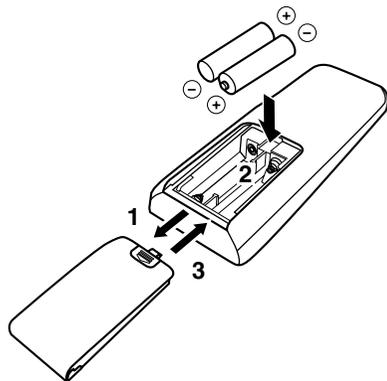

- 1** Press the  part and slide off the battery compartment cover.
- 2** Insert the two batteries (AA, R06, UM-3 type) with + and - oriented properly.
- 3** Slide the cover back on so that it snaps into place.

Notes on batteries

- Change all of the batteries if you notice a decrease in the operating range of the remote control.
- Do not use old batteries together with new ones.
- Do not use different types of batteries (such as alkaline and manganese batteries) together. Read the packaging carefully as these different types of batteries may have the same shape and color.
- If the batteries have leaked, dispose of them immediately. Avoid touching the leaked material or letting it come into contact with clothing, etc. Clean the battery compartment thoroughly before installing new batteries.

Preserving the manufacturer code

Replace batteries early before they become unusable. The manufacturer code set by the user will be preserved for about two minutes when batteries run out or when they are removed. Note that the manufacturer code setting may be lost if more than two minutes elapses. Also, if you press any button on the remote control accidentally while replacing batteries, the manufacturer code will be lost.

CONTROLS AND FUNCTIONS

Front panel

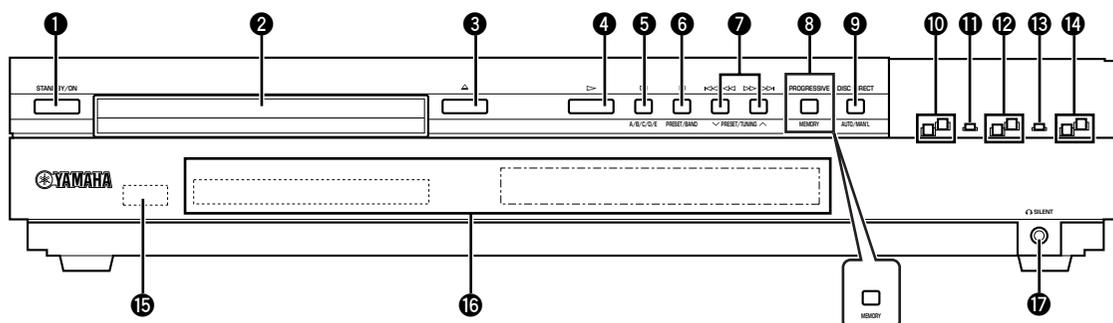

(U.K., Europe, Australia and General models)

1 STANDBY/ON

Turns this unit on, or set it to the standby mode. When you turn this unit on, you will hear a click and there will be a 4 to 5-second delay before this unit can reproduce sound.

Standby mode

In this mode, this unit will consume a small amount of power in order to receive infrared-signals from the remote control.

2 Disc tray

The disc you play is loaded on this tray.

3

Press to open and close the disc tray.

4

Press to start playback.

5 (A/B/C/D/E)

(DVD mode)

Press to stop playback.

(Tuner mode)

Selects preset station groups A to E.

6 (PRESET/BAND)

(DVD mode)

Press to pause.

(Tuner mode)

Switches the reception band between FM and AM and also the mode between the tuning mode and the preset mode.

7 (✓ PRESET/TUNING / PRESET/TUNING ^)

(DVD mode)

Each time these buttons are pressed, the disc begins playing from the beginning of the track you select. When you keep pressing the buttons, the disc searches forward or backward.

(Tuner mode)

Selects preset station numbers 1 to 8 when the colon (:) appears in the front panel display.

Selects the tuning frequency when the colon (:) does not appear.

8 PROGRESSIVE (MEMORY) (U.S.A. and Canada models)

(DVD mode)

Switches between progressive video output and interlace video output.

(Tuner mode)

Stores the current station in the memory.

MEMORY (U.K., Europe, Australia and General models)

(Tuner mode)

Stores the current station in the memory.

9 DISC DIRECT (AUTO/MAN'L)

(DVD mode)

Changes the modes of DISC DIRECT function.

(Tuner mode)

Switches the tuning mode between automatic and manual.

10 INPUT ▲/▼

Selects the input source you want to listen to or watch.

11 INPUT MODE

Sets the priority for the types of input signals (AUTO, DTS, ANALOG) to receive when one component is connected to two or more input jacks.

12 DSP ▲/▼

Selects the DSP program.

13 STEREO

Switches between normal stereo and DSP effect reproduction. When STEREO is selected, 2-channel signals are directed to the front left and right speakers without effect sounds.

14 VOLUME +/-

Controls the output level of all audio channels. This does not affect the recording (Rec) level.

15 Remote control sensor

Receives signals from the remote control.

16 Front panel display

Shows information about the operational status of this unit.

17  SILENT

Allows you enjoy DSP effect for private listening with headphones. When you connect headphones, no signals are output to the speakers.

Remote control (AMP mode)

This section explains the function of each button on the remote control when you operate this unit as an amplifier, not as a tuner or a DVD player. Make sure that the AMP mode is selected before starting operation.

Refer to “REMOTE CONTROL (DVD MODE)” on page 31 for the details about the functions of the remote control when you control this unit in the DVD mode. Also, refer to “OPERATING OTHER COMPONENTS USING THE REMOTE CONTROL” on pages 57 and 58 for the details about its functions when controlling other components connected to this unit.



- The buttons on the remote control whose names are written in purple are operation buttons when you operate this unit in the AMP mode.

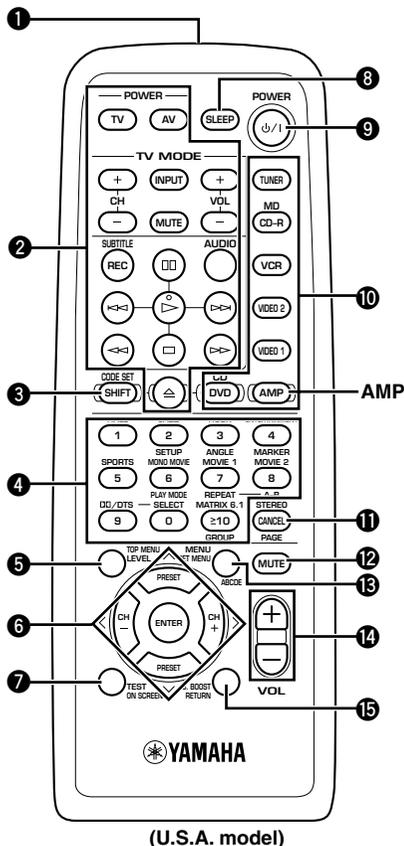

(U.S.A. model)

1 Infrared window

Outputs infrared control signals. Aim this window at the component you want to operate.

2 Basic operation buttons

Used to operate the components selected with input selector buttons.

3 CODE SET

Used when setting up the manufacturer code.

4 DSP program buttons

Select DSP programs for the AMP position. Press a button repeatedly to select a DSP program within that group.

5 LEVEL

Selects the effect speaker channel to be adjusted.

6 Cursor buttons (<, >, ^, v)/ENTER

Select SET MENU items and change the settings on the SETUP menu etc.

7 TEST

Outputs the test tone to adjust the speaker levels.

8 SLEEP

Sets the sleep timer.

9 POWER (phi/I)

Turns this unit on, or set it to the standby mode.

10 Input selector buttons/AMP

Select the input source and set the remote control to operate the selected source component. Sets the remote control to the AMP mode for controlling this unit.

11 STEREO

Switches between normal stereo and DSP effect reproduction. When STEREO is selected, 2-channel signals are directed to the front left and right speakers without effect sounds and all Dolby Digital and DTS signals (except the LFE channel) are mixed down to the front left and right speakers.

12 MUTE

Mutes the sound. Press again to restore the audio output to the previous volume level.

13 SET MENU

Selects the SET MENU mode.

14 VOL +/-

Increases or decreases the volume level.

15 B. BOOST

Turns BASS BOOST function on or off.

■ Using the remote control

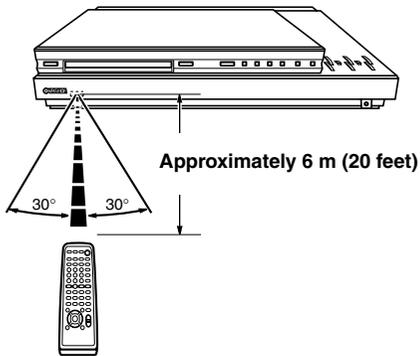

Handling the remote control

- Do not spill water or other liquids on the remote control.
- Do not drop the remote control.
- Do not leave or store the remote control in the following types of conditions:
 - high humidity or temperature such as near a heater, stove or bath;
 - dusty places; or
 - in places subject to extremely low temperatures.

Front panel display (left)

This front panel display mainly displays the information related to the playback of discs.

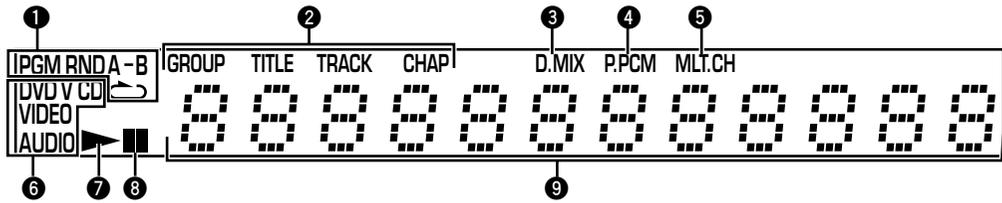

1 Play mode indicators

PGM: Programmed play / **RND:** Random play /
: Repeat play / **A-B** : Repeat A-B

2 Mode type indicators

GROUP: Group mode / **TITLE:** Title mode /
TRACK: Track mode / **CHAP:** Chapter mode

3 D.MIX (Down Mix)

Lights up when the currently playing multi-channel audio track is mixed down into 2-channel.

4 P.PCM (Packed PCM)

Lights up while a P.PCM signal is input.

5 MLT.CH (Multi Channel)

Lights up while a multi-channel signal is output.

6 Disc type indicators

Indicates the type of disc. For example, DVD and AUDIO lights up when playing a DVD-Audio disc.

7

Lights up during playback. Blinks while resume function is working.

8

Lights up while playback is paused.

9 Multi-information display (left)

Shows various information such as title, chapter or track number, elapsed playing time etc.

Front panel display (right)

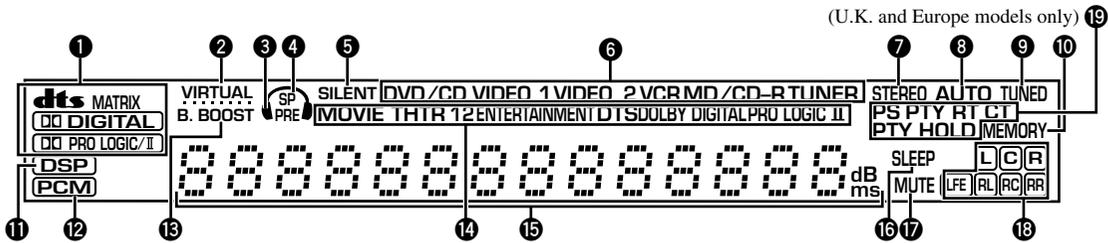

❶ Decoder indicators

Lights up when the **dts**, **DIGITAL**, **PRO LOGIC II** or **MATRIX** are activated.

❷ VIRTUAL indicator

Lights up in the virtual cinema DSP mode.

❸ Headphones indicator

Lights up when headphones are connected.

❹ SP/PRE indicator

The indicator of the item selected in “9 SP/PRE OUT” on the SET MENU lights up. (But it does not light up when headphones are connected.)

❺ SILENT indicator

Lights up when headphones are connected while the digital sound field processor is on.

❻ Input source indicator

Shows the current input source with a cursor.

❼ STEREO indicator

Lights up when this unit is receiving a strong signal for an FM stereo broadcast while the “AUTO” indicator is lit.

❽ AUTO indicator

Shows that this unit is in the automatic tuning mode.

❾ TUNED indicator

Lights up when this unit is tuned to a station.

❿ MEMORY indicator

Flashes to show a station can be stored.

⓫ DSP indicator

Lights up when you select DSP programs.

⓬ PCM indicator

Lights up when this unit is reproducing PCM (pulse code modulation) digital audio signals.

⓭ B. BOOST indicator

Lights up when BASS BOOST is ON. (But it does not light up when headphones are connected.)

⓮ DSP program indicators

The name of the selected DSP program lights up when the ENTERTAINMENT, MOVIE THEATER 1, MOVIE THEATER 2 or **DTS**/DTS SURROUND DSP program is selected.

⓯ Multi-information display (right)

Shows the current DSP program name and other information when adjusting or changing settings.

⓰ SLEEP indicator

Lights up while the sleep timer is on.

⓱ MUTE indicator

Flashes while the MUTE function is on.

⓲ Input channel indicator

Indicates the channel components of input signals being received.

⓳ RDS indicator (U.K. and Europe models)

The name(s) of the RDS data offered by the currently received RDS station light(s) up.
PTY HOLD indicator lights up while searching for stations in the PTY SEEK mode.

PREPARATION STEPS

In order to enjoy sound and video images with this sound system, follow the procedures as described below. See each page for details.

Installing batteries in the remote control (P.3)



Speaker setup (P.11)

- Speaker placement (P.11)
- Installing the speakers (P.12)



Connections (P.14 – 19)

- Connecting TV and audio/video components (P.14)
- Connecting the antennas (P.16)
- Connecting the speakers (P.17)
- Connecting the AC power cord (P.19)
- Turning on the power (P.19)



Adjusting speaker output levels (P.20)

Before connecting components

- Do not connect this unit or other components to the mains power until all connections between the components have been completed.
- Be sure all connections are made correctly, that is to say, L (left) to L, R (right) to R, “+” to “+” and “-” to “-”. Some components require different connection methods and have different jack names. Refer to the operation instructions for each component to be connected to this unit.
- Insert the plugs properly. The speakers may not output any sound or may output noise if they are not inserted properly.
- The name of jack corresponds to input selector.
- The **VOLTAGE SELECTOR** on the rear panel of this unit must be set for your local main voltage **BEFORE** plugging into the AC main supply. Voltages are 220/240 V AC, 50 Hz. (General model)

VOLTAGE SELECTOR

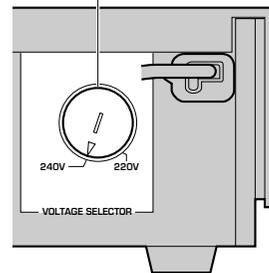

(General model)

After connecting components

- Check them again to make sure they are correct.

SPEAKER SETUP

This unit has been designed to provide the best sound-field quality with a 5-speaker system, using front left and right speakers, rear left and right speakers and a center speaker.

The front speakers are used for the main source sound plus effect sounds. The rear speakers are used for effect and surround sounds. The center speaker is for the center sounds (dialog, vocals, etc.).

Notes

- If you do not use any of effect speakers (rear and/or center), change the settings of SPEAKER SET items at the SET MENU (p.60) to designate the signals to other terminals you connect speakers to.
- If you use speakers (with different tonal qualities) instead of the included speakers, the tone of a moving human voice and other types of sound may not shift smoothly. We recommend that you use speakers from the same manufacturer or speakers with the same tonal quality.

Speaker placement

Refer to the following diagram when you place the speakers.

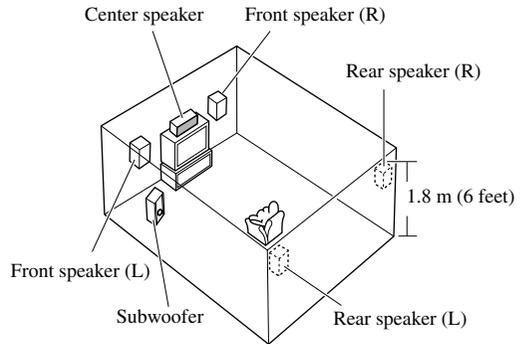

Front speakers

Place the front left and right speakers an equal distance from the ideal listening position. The distance between each speaker and each side of the video monitor should also be the same.

Center speaker

Align the front face of the center speaker with the front face of your video monitor. Place the speaker as close to the monitor as possible (such as directly over or under the monitor) and centrally between the front speakers.

Rear speakers

Place these speakers behind your listening position, facing slightly inwards, nearly 1.8 m (6 feet) above the floor.

Subwoofer

The position of the subwoofer is not so critical, because low bass sounds are not highly directional. But it is better to place the subwoofer near the front speakers. Turn it slightly toward the center of the room to reduce wall reflections.

Note

- Although the speaker system in this unit is magnetically shielded, it may still affect the color on the television monitor when using this unit near the television. Adjust the relative positions of this unit and the television if this happens.

Installing the speakers

■ Placing the center speaker

Place the speaker on TV whose top is flat or on the floor under the TV or inside the TV rack so that it is stabilized. When placing the speaker on top of the TV, to prevent the speaker from falling down, put the provided fasteners at four points on the bottom of the speaker and the top of the TV.

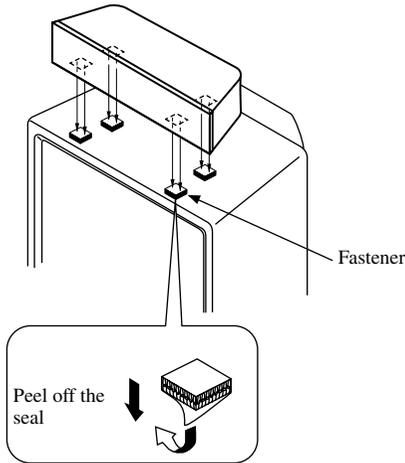

Cautions

- Do not place the speaker on top of the TV whose area is smaller than the bottom area of the speaker. If placed, the speaker may drop out causing an injury to you.
- Do not place the speaker on top of the TV with an inclination.
- Do not touch the adhesive surface after peeling off the seal as this will weaken its adhesive strength.
- Thoroughly wipe clean the surface where the fastener is to be applied. Note that adhesive strength is weakened if the surface is dirty, oily or wet and that this may cause the center speaker to drop.

■ Placing the front and rear speakers

When placing the front and rear speakers on a flat surface, attach the included non-skid pads to the corners on the bottom of the speakers as shown below. This prevents the speakers from sliding around.



■ Mounting the front and rear speakers

When mounting the front and rear speakers on a wall, use the holes on the speakers' back panels.

- 1 Put the provided pads at the four corners on the rear of the front and rear speakers to prevent the front and rear speakers from moving by vibrations.

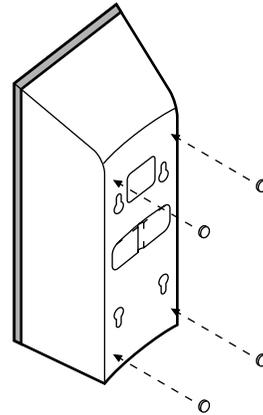

- 2 Fasten screws into a firm wall or wall support as shown below.

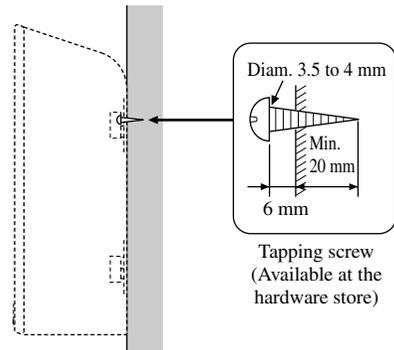

3 Hang the holes on the protruding screws.

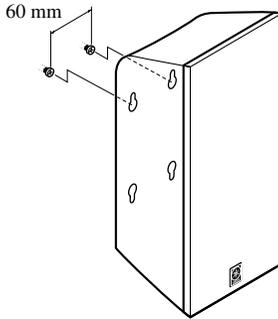

- Make sure that the screws are securely caught by the narrow parts of the holes.
- You can use the lower holes on the rear of the front/rear speakers.

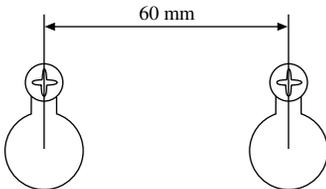

Cautions

- Each speaker weighs 1.1 kg (2 lbs. 6 oz.). Do not mount them on thin plywood or a wall with soft surface material. If mounted, the screws may come out of the flimsy surface and the speakers may fall. This damages the speakers or causes personal injury.
- Do not install the speakers to a wall with nails, adhesives, or any other unstable hardware. Long-term use and vibrations may cause them to fall.
- To avoid accidents resulting from tripping over loose speaker cables, fix them to the wall.
- Select a proper position on the wall to mount the speaker so that no one will injure his/her head or face.

■ If you want to mount a speaker on a commercially available speaker stand (for the front/rear speakers)

The screw holes (at an interval of 60 mm) on the bottom and the rear of the speaker can be used to mount the speaker on a speaker stand.

* Those screw holes can be used with M4 screws only.

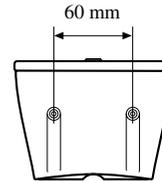

Front/rear speaker
(bottom)

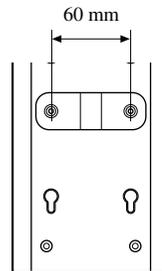

Front/rear speaker
(rear)

CONNECTIONS

Connecting TV and audio/video components

Types of video jacks

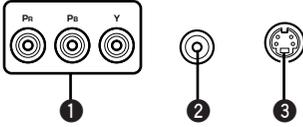

1 COMPONENT VIDEO jacks (U.S.A., Canada, Australia and General models)

Transmit color difference (P_B/C_B, P_R/C_R) and luminance separately and provide the best quality picture.

2 VIDEO jack

Conventional composite video signal.

3 S VIDEO jack

Transmits color and luminance separately and achieves high-quality color reproduction.

Notes

- Each type of video jack works independently. Signals input through the composite video and S video jacks are only output through the corresponding composite video and S video jacks.
- When you connect this unit to a video monitor, a video component and a recording component, connect the same types of jack, for example, the video jack on this unit to the video jack on the video component.
- The description of the component video jacks may differ depending on the component (e.g. Y, C_B, C_R/Y, P_B, P_R/Y, B-Y, R-Y etc.). When using these jacks, refer also to the operation instructions for the component being connected.
- Do not connect this unit to a video monitor through a video cassette recorder. If you do so, the picture may not be played back properly due to the copyright protection technology incorporated in this unit.
- When progressive output (p.38) is selected in the DVD mode, video signals are only output from the component video jacks.

Types of audio jacks

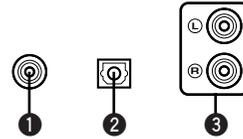

1 COAXIAL jack

Connects a coaxial pin cable and provides the better quality sound than analog audio jacks.

2 OPTICAL jack

Connects an optical fiber cable and provides the better quality sound than analog audio jacks.

3 Analog audio jacks

Connect an audio pin cable.



- 1 and 2 are digital jacks.
- You can use the digital jacks to input PCM, Dolby Digital and DTS bitstreams.
- All digital input jacks are acceptable for 96-kHz sampling digital signals.

Notes

- DIGITAL OUTPUT jack and analog OUT (Rec) jacks are independent. Only digital signals are output from DIGITAL OUTPUT jack and analog signals from OUT (Rec) jacks.
- The OPTICAL jacks on this unit conform to the EIA standard. If you use an optical cable that does not conform to this standard, this unit may not function properly.
- Once you have connected a recording component to this unit, keep its power turned on while using this unit. If the power is off, this unit may distort the sound from other components.

Anti-dust cap

Remove the cap covering the OPTICAL jacks when connecting an optical cable. Safely store the cap and always re-insert it in the terminal when the terminal is not in use. (This cap prevents the entrance of dust.)

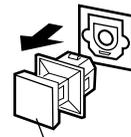

Anti-dust cap

The connection example

Use a commercially available cable specified for connecting each type of jacks.

For Audio component

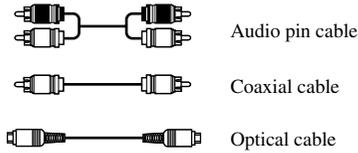

For A/V component

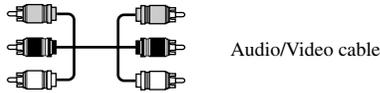

For Video Component

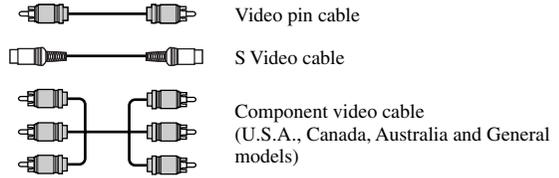

The connection example shown below is just an example. Connect in accordance with the components you have.



- The solid lines indicate the output from this unit and the dotted lines indicate the input to this unit.

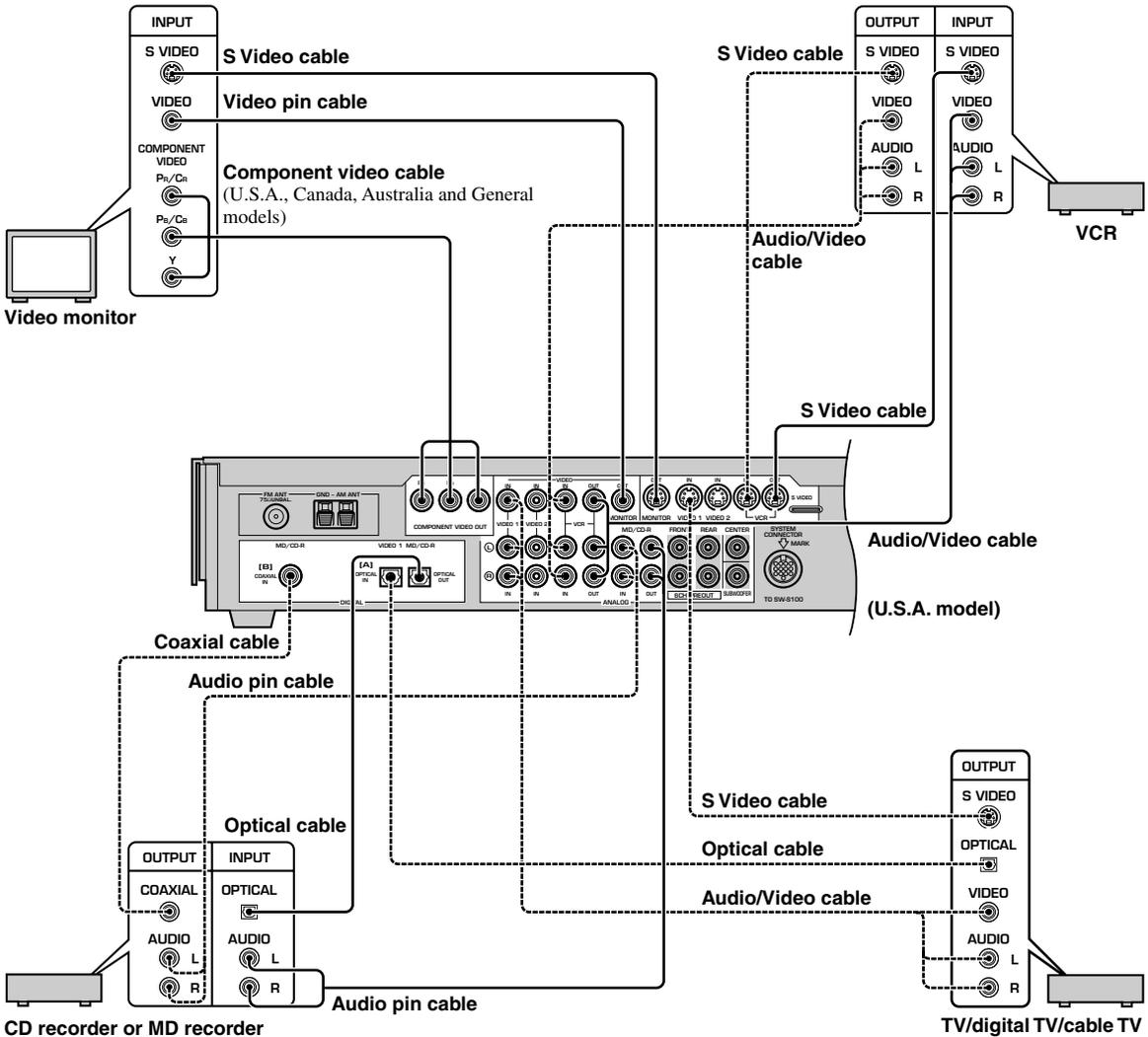

Connecting the antennas

Both AM and FM indoor antennas are included with this unit. In general, these antennas should provide sufficient signal strength.

Connect each antenna correctly to the designated terminals.

■ Connecting indoor FM antenna

Connect the included indoor FM antenna to the FM ANT terminal.

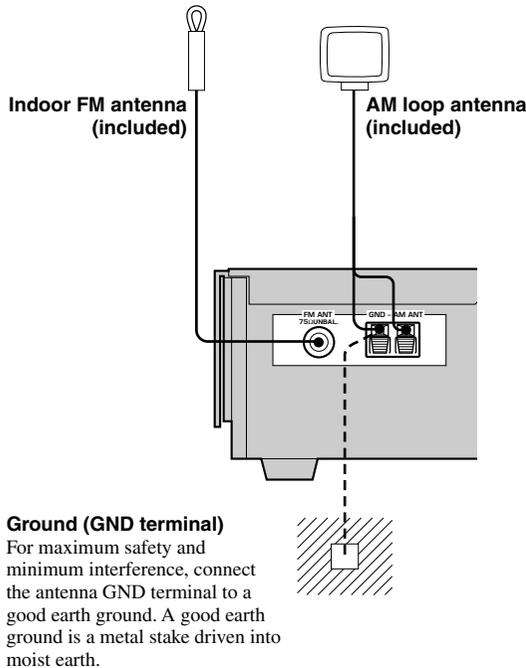

■ Connecting the AM loop antenna

1 Set up the AM loop antenna, then connect it.

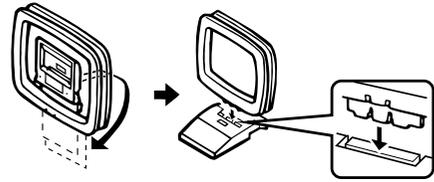

2 Press and hold the tab to insert the AM loop antenna lead wires into the AM ANT and GND terminals.

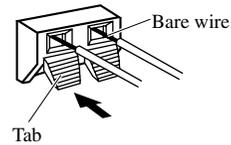

3 Release the tab. (The tab will return to its original position when you release your finger.)

Once connected, pull the wires gently to check that they are connected securely.



4 Orient the AM loop antenna for the best reception.



- A properly installed outdoor antenna provides clearer reception than an indoor one. If you experience poor reception quality, an outdoor antenna may improve the quality. Consult the nearest authorized YAMAHA dealer or service center about the outdoor antennas.

Notes

- The AM loop antenna should be placed away from this unit.
- The AM loop antenna should always be connected, even if an outdoor AM antenna is connected to this unit.

Connecting the speakers

Connect the included speakers to the DVD AUDIO/VIDEO receiver (DVR-S100) using the included speaker cables and system connector cables as shown below.

DVD Audio/Video receiver (DVR-S100)

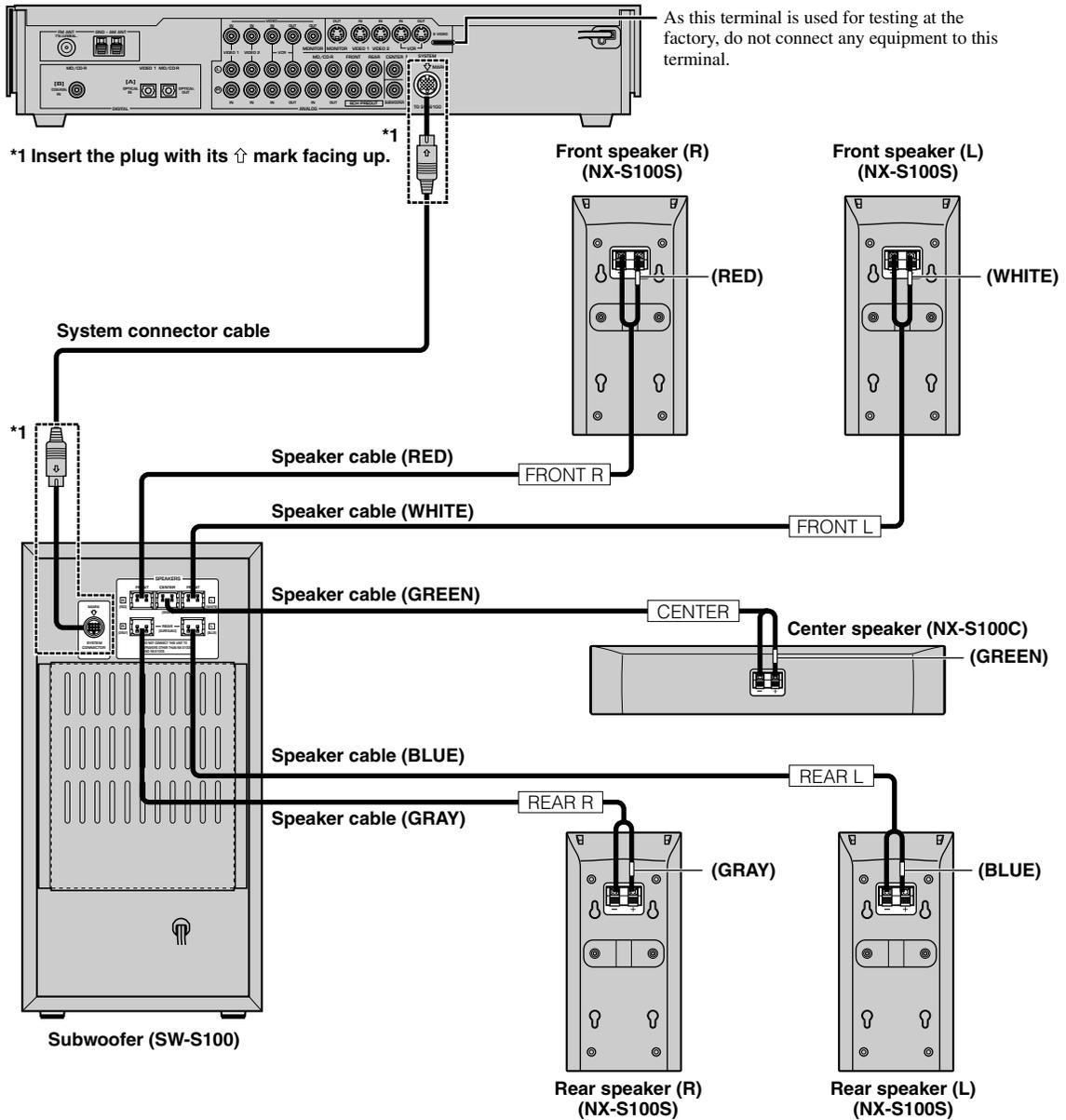

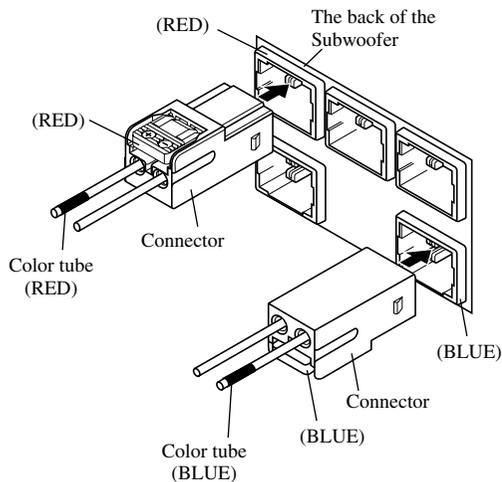

- The connector of the included speaker cable and the terminal of the subwoofer are classified by color. Connect the same colors.
- The label of the speaker is attached to each speaker cable. Connect the speakers in accordance with the labels.
- Connect the color tube of the speaker cable to the plus (+) side of each speaker. If the polarity of the speaker connections is incorrect, the sound will be unnatural and lack bass.
- A cover is attached to the end of the speaker cable. Connect the speakers after removing the cover.
- Make sure that the plugs of the system connector cable and the connectors of the speaker cables are inserted correctly before inserting them.

Notes

- Do not let the bare speaker wires touch each other or any metal part of this unit. This could damage this unit and/or the speakers.
- Do not insert the plug or connector forcibly. Doing so may damage the plug, connector or terminal.
- Do not scratch, forcibly bend, or pull the system connector or speaker cable as this may damage the cable, causing loss of audio output, and may possibly result in a fire or electric shock. Take particular care in making sure that the cable is not squashed by a rack or caster.
- Before disconnecting or connecting the system connector cable, disconnect the power supply cord of the subwoofer and DVD audio/video receiver.

Using commercially available speakers and speaker cables

You can use commercially available speaker cables and speakers except for a subwoofer. If you use them, note the following.

- Use the speaker whose impedance is 6Ω or higher. When using the speaker whose impedance is lower than 6Ω, the protection circuit may start working or this unit may be damaged.
- Use magnetically shielded speakers. If this type of speakers still creates the interference with the monitor, place the speakers away from the monitor.
- Use the speaker cable that is as thick as the included cable. Too thick cables cannot be used.

Exchanging the speaker cables

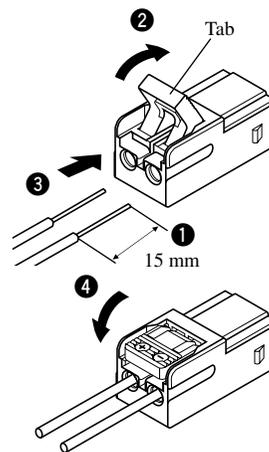

- 1 Remove approximately 15 mm (9/16") of insulation from each of the speaker cables.**
Twist the exposed wires of the cable together to prevent short circuits.
- 2 Open the tab.**
- 3 Pull the inserted bare wire of the speaker cable from the connector and insert the bare wire of the commercially available speaker cable.**
- 4 Return the tab to secure the wire.**

Connecting to an external amplifier

If you want to increase the power output to the speakers, or want to use another amplifier, connect an external amplifier to the 6CH PREOUT jacks as follows.

Note

- When you have connected this unit to an external amplifier, select PRE in “9 SP/PRE OUT” on the SET MENU. (See page 63.)

1 FRONT jacks

Front channel line output jacks.

2 REAR jacks

Rear channel line output jacks.

3 CENTER jack

Center channel line output jack.

4 SUBWOOFER jack

Low bass signals distributed from the front, center and/or rear channels are directed to this jack if they are assigned to this jack. (The cut-off frequency of this jack is 90 Hz.) The LFE (low-frequency effect) signals generated when Dolby Digital or DTS is decoded are also directed if they are assigned to this jack.

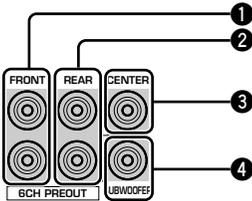

- The adjustments made in the following settings have an effect on the signals output from the 6CH PREOUT jacks.
 - BASS BOOST settings
 - Speaker settings
 - DSP programs

Connecting the AC power cord

Plug in this unit to the wall outlet.

Memory back-up

The memory back-up circuit prevents the stored data from being lost when the power cord is disconnected from the AC outlet, or the power supply is temporarily cut due to power failure. However, if the unit is turned off for more than one week, the stored setting will be cleared. If so, set the setting again.

- Volume level
- Input source
- Speaker output level (center, rear L/R and subwoofer)
- Sleep timer
- Parameter
- Delay time
- Set menu
- Disc direct
- Preset station

Turning on the power

When all connections are complete, turn on the power of this unit.

STANDBY/ON

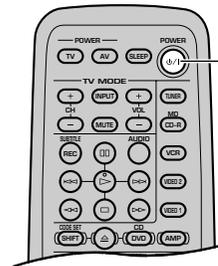

POWER (⏻/⏿)

1 Press STANDBY/ON (POWER (⏻/⏿) on the remote control) to turn on the power of this unit.

2 Turn on the video monitor connected to this unit.

Note

- When you use only some of the included 6 speakers or when using commercially available speakers, adjust speaker mode settings soon after turning the power on. See “1 SPEAKER SET (speaker mode settings)” on page 60 for details.

BASIC PLAYBACK

Basic operations

You can play the software loaded on the audio and video components connected to this unit.

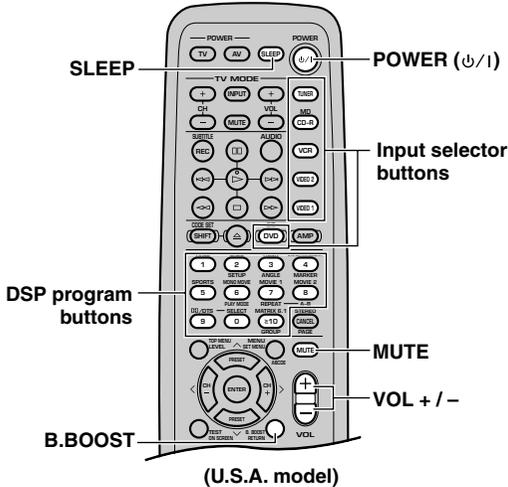

Indication on the front panel display (example):

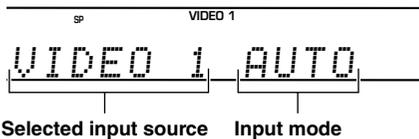

- 1** Press **POWER** (⏻) to turn on the power.
- 2** Turn on the **A/V** component connected to this unit.
- 3** Press **INPUT** ▲/▼ on the front panel repeatedly (one of the input selector buttons on the remote control) to select the input source.
The selected input source name and input mode appear on the front panel display for a few seconds.
- 4** Start playback or select a broadcast station on the source component.
Refer to the operation instructions for the component.

5 Adjust the volume to the desired level.

The volume level is displayed digitally.

Example: -70 dB

Control range: **VOLUME MUTE** (minimum) to 0 dB (maximum)

Note

- If you have connected a recording component to the VCR OUT, or MD/CD-R OUT jacks, and you notice distortion or low volume during playback of other components, try turning the recording component on.

Enhancing the bass tones

Press B. BOOST.

- “Bass Boost ON” appears in the display.
- This function enhances the bass tones of the subwoofer by increasing the level of the low-range frequencies.
- To cancel B. BOOST mode, press B. BOOST again.



- The B. BOOST mode does not function when the headphones are connected.

Note

- If a thudding noise is heard from the subwoofer when this function is turned on, lower the subwoofer level. Otherwise, the subwoofer may be damaged due to an excessive input level of low-bass signal.

To mute the sound

Press MUTE on the remote control.

To resume the audio output, press MUTE again.



- You can also cancel mute by pressing VOL +/-, etc.
- During muting, the “MUTE” indicator flashes on the front panel display.

■ When you have finished using this unit

Press STANDBY/ON on the front panel (POWER (⏻/⏪) on the remote control) to set this unit in the standby mode.

■ Setting the sleep timer

Use this feature to automatically set this unit in the standby mode after the amount of time you have set. The sleep timer is useful when you are going to sleep while this unit is playing or recording a source.



- By connecting a commercially available timer to this unit, you can also set a wake-up timer. Refer to the operation instructions of the timer.

(While playing a source)

Press SLEEP repeatedly to set the amount of time.

Each time you press SLEEP, the front panel display changes as shown below.

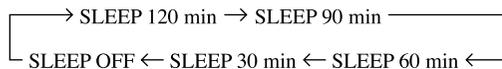

The “SLEEP” indicator lights up on the front panel display soon after the sleep timer has been set. The display then returns to the previous indication.

Canceling the sleep timer

Press SLEEP repeatedly until “SLEEP OFF” appears on the front panel display.

After a few seconds, “SLEEP OFF” disappears, the “SLEEP” indicator goes off and the display returns to the previous indication.



- The sleep timer setting can also be canceled by setting this unit in the standby mode by using POWER (⏻/⏪) on the remote control (or STANDBY/ON on the front panel) or by disconnecting the AC power cord from the AC outlet.

■ Input modes and indications

This unit comes with a variety of input jacks. You can select the type of input signals you desire.

Press INPUT MODE (the input selector button that you have pressed to select the input source on the remote control) repeatedly until the desired input mode is shown on the front panel display.

- **AUTO:** In this mode, the input signal is selected automatically as follows:
 - 1) Digital signal
 - 2) Analog signal
- **DTS:** In this mode, only the digital input signal encoded with DTS is selected.
- **ANALOG:** In this mode, only the analog input signal is selected.



- When AUTO is selected, this unit automatically determines the type of signal. If this unit detects a Dolby Digital or DTS signal, the decoder automatically switches to the appropriate setting.
- Each time you turn on the power of this unit, the input mode is set according to “8 INPUT MODE” setting on the SET MENU (see page 63 for details).

Notes

- When playing a disc encoded with Dolby Digital or DTS on some LD players, the sound output delays for a moment when playback resumes after a search because the digital signal is selected again.
- When playing a LD source that has not been digitally recorded, the sound may not be output for some LD players. In this case, set the input mode to ANALOG.

Notes on playing DTS-CD/LDs

- If the digital output data of the player has been processed in any way, you may not be able to perform DTS decoding even if you make a digital connection between this unit and the player.
- If you play a source encoded with a DTS signal and set the input mode to ANALOG, this unit may reproduce the noise of an unprocessed DTS signal. In this case, connect the source to a digital input jack and set the input mode to AUTO or DTS.
- If you switch the input mode to ANALOG while playing a source encoded with a DTS signal, this unit reproduces no sound.
- If you play a source encoded with a DTS signal with the input mode set to AUTO;
 - This unit automatically switches to the DTS-decoding mode (The “**dts**” indicator lights up) after having detected the DTS signal. When playback of the DTS source is completed, the “**dts**” indicator may flash. While this indicator is flashing, only DTS source can be played. If you want to play a normal PCM source soon, set the input mode back to AUTO.
 - When the input mode is set to AUTO and a search or skip operation is performed during playback of a DTS source, the “**dts**” indicator may flash. If this status continues for longer than 30 seconds, this unit will automatically switch from “DTS-decoding” mode to PCM digital signal input mode. The “**dts**” indicator will turn off.

Selecting a sound field program

This unit's built-in DSP (Digital Sound field Processor) can simulate various acoustic environments, including a concert hall and movie theater, with its 9 sound field programs. For the best results, choose a program appropriate for the selected audio source.

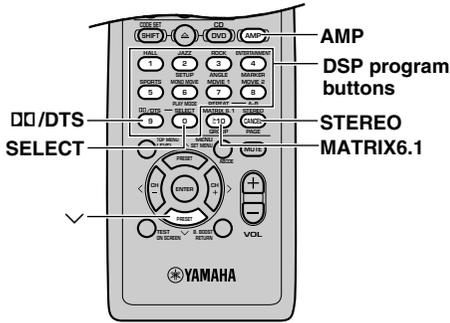

(U.S.A. model)

- 1** Press AMP.
- 2** Press one of the DSP program buttons on the remote control to select the desired program.
- 3** After selecting the desired program, press the same button repeatedly to select the desired sub-program if available.



- You can also select DSP program by pressing DSP ▲/▼ on the front panel.
- Select the DSP program that you feel sounds best regardless of the name and description given for it below.

Indication on the front panel display (example):

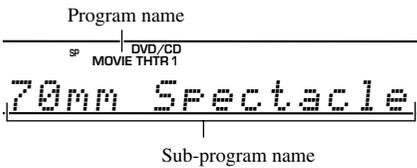

■ Feature of DSP programs

	No.	Program	Features
Hi-Fi DSP (for music sources)	1	CONCERT HALL	A large round concert hall with a rich surround effect. Pronounced reflections from all directions emphasize the extension of sounds. The sound field has a great deal of presence, and your virtual seat is near the center, close to the stage.
	2	JAZZ CLUB	This is the sound field at stage front in "The Bottom Line", a famous New York jazz club, that seats up to 300 people. Its wide left to right seating arrangement offers a real and vibrant sound.
	3	ROCK CONCERT	The ideal program for lively, dynamic rock music. The data for this program was recorded at LA's "hottest" rock club. The listener's virtual seat is at the center-left of the hall.
	4	ENTERTAINMENT/ Disco	This program recreates the acoustic environment of a lively disco in the heart of a big city. The sound is dense and highly concentrated. It is also characterized by a high-energy, "immediate" sound.
		ENTERTAINMENT/ 5ch Stereo	Using this program increases the listening position range. This is a sound field suitable for background music at parties, etc.

	No.	Program	Features
CINEMA-DSP (for video sources)	4	ENTERTAINMENT/ Game	This program adds a deep and spatial feeling to video game sounds.
		ENTERTAINMENT/ Concert Video	This program produces an enthusiastic atmosphere and lets you feel as if you are at an actual jazz or rock concert.
	5	TV SPORTS	With this program, you can enjoy watching various TV programs such as news, variety shows, music programs or sports programs. In a stereo broadcast of a sports game, the commentator is oriented at the center position, and the shouts and the atmosphere in the stadium spread on the surround side, while their spread to the rear is properly restrained.
	6	MONO MOVIE	This program is provided for reproducing monaural video sources (such as old movies). The program produces the optimum reverberation to create sound depth by using only the presence sound field.
CINEMA-DSP (for cinema sources)	7	MOVIE THEATER 1/ Spectacle	This program creates the extremely wide sound field of a 70-mm movie theater. It precisely reproduces the source sound in detail, making both the video and the sound field incredibly real. This is ideal for any kind of video source encoded with Dolby Surround, Dolby Digital or DTS (especially large-scale movie productions).
		MOVIE THEATER 1/ Sci-Fi	This program clearly reproduces dialog and sound effects in the latest sound form of science fiction films, thus creating a broad and expansive cinematic space amid the silence. You can enjoy science fiction films in a virtual-space sound field that includes Dolby Surround, Dolby Digital and DTS-encoded software employing the most advanced techniques.
	8	MOVIE THEATER 2/ Adventure	This program is ideal for precisely reproducing the sound design of the newest 70-mm and multichannel soundtrack films. The sound field is made to be similar to that of the newest movie theaters, so the reverberations of the sound field itself are restrained as much as possible.
		MOVIE THEATER 2/ General	This program is for reproducing sounds from 70-mm and multichannel soundtrack films, and is characterized by a soft and extensive sound field. The presence sound field is relatively narrow. It spatially spreads all around and toward the screen, restraining the echo effect of conversations without losing clarity.
	9	DSP/DTS/ENHANCED	This program ideally simulates the multi-surround speaker systems of the 35-mm film theaters. Dolby Pro Logic and Dolby Pro Logic II decoding, Dolby Digital decoding or DTS decoding and digital sound field processing create precise effects without altering the original sound orientation. The surround effects produced by this sound field wrap around the viewer naturally from the back to the left and right, and toward the screen.
STRAIGHT DECODE	9	DSP/DTS/NORMAL	The built-in decoder precisely reproduces sounds and sound effects from sources. The highly efficient decoding process improves crosstalk and channel separation and makes sound positioning smoother and more precise. In this program, no DSP effect is applied.



- When you set this unit in the standby mode, the current source and DSP program are memorized and are automatically selected when you turn on the power again.
- When you select an input source, this unit automatically selects the last DSP program used with that source.
- The “” indicator does not light up when selecting program No. 9 except in Enhanced mode.

Notes

- There are 9 programs with sub-programs available with this unit. However, the selection depends on the input signal format and not all sub-programs can be used with all input signal formats.
- The acoustics of your listening room affect the DSP program. Minimize the sound reflections in your room to maximize the effect created by the program.
- When a monaural source is being played with PRO LOGIC/Normal or PRO LOGIC/Enhanced, or PRO LOGIC II Movie, no sound will be heard from the front speakers and the rear speakers. Sound can only be heard from the center speaker. (If “1A CENTER” on the SET MENU is set to NON, the center channel sound is output from the front speakers.)

■ Table of Program Names for Each Input Format

This unit automatically chooses the appropriate decoder and DSP sound field pattern according to the input signal format.

No.	Input Program	2 channel	5.1 channel		6.1 channel *	
		ANALOG, PCM, DOLBY DIGITAL, DTS	DOLBY DIGITAL	DTS	DOLBY DIGITAL + Matrix 6.1	DTS + Matrix 6.1
7	MOVIE THEATER 1	70 mm Spectacle	DGTL Spectacle	DTS Spectacle	Spectacle 6.1	Spectacle 6.1
		70 mm Sci-Fi	DGTL Sci-Fi	DTS Sci-Fi	Sci-Fi 6.1	Sci-Fi 6.1
8	MOVIE THEATER 2	70 mm Adventure	DGTL Adventure	DTS Adventure	Adventure 6.1	Adventure 6.1
		70 mm General	DGTL General	DTS General	General 6.1	General 6.1
9	DOLBY DIGITAL	—	Normal	—	Matrix 6.1	—
		—	Enhanced	—	Enhanced 6.1	—
	DTS DIGITAL SUR	—	—	Normal	—	Matrix 6.1
		—	—	Enhanced	—	Enhanced 6.1
	PRO LOGIC	Normal	—	—	—	—
		Enhanced	—	—	—	—
PRO LOGIC II	Movie	—	—	—	—	
	Music	—	—	—	—	

* means the Matrix 6.1 decoder is ON.



- If Dolby Digital Surround EX software or DTS ES software is played when AUTO is selected by pressing the MATRIX 6.1 button on the remote control, the Dolby Digital + Matrix 6.1 or DTS + Matrix 6.1 decoder usually turns on and the corresponding DSP program is selected.
- MATRIX 6.1 on the remote control can be used to play Dolby Digital or DTS 5.1 channel sources with the virtual rear center speaker. In this case the program name changes to the corresponding name for 6.1 channel.
- When playing a 6.1 channel source with MATRIX 6.1 on the remote control turned off, the program name changes to the corresponding name for 5.1 channel.

■ Selecting PRO LOGIC II

You can enjoy the 2-channel sources decoded into five discrete channels by selecting PRO LOGIC II in program No. 9.

(While playing a 2-channel source)

1 Press AMP.

2 Press **D**/DTS.

The previously selected sub program appears on the front panel display.

3 Press SELECT repeatedly to select the decoder, PRO LOGIC II.

4 After selecting on the decoder (PRO LOGIC II), select the mode appropriate for the source by pressing **D**/DTS.

The selection switches as follows;
PRO LOGIC II Movie ↔ PRO LOGIC II Music



- You can select PRO LOGIC, PRO LOGIC II Movie, and PRO LOGIC II Music by pressing DSP ▲/▼ on the front panel repeatedly.

Note

- Playback using DOLBY PRO LOGIC II decoders is possible only for 2-channel signals.

■ Playing Dolby Digital Surround EX or DTS ES software

Press MATRIX 6.1 to turn on the Dolby Digital + Matrix 6.1 or DTS + Matrix 6.1 decoder.

The rear center channel is created from rear left and right channels, and output from virtual rear center speaker.

The display changes AUTO → Matrix6.1 → OFF each time the MATRIX 6.1 button is pressed.

- AUTO: This mode automatically switches Dolby Digital + Matrix 6.1 and DTS + Matrix 6.1 depending on the signal. Virtual rear center speaker does not work for 5.1 channel sources.
- Matrix6.1: This setting produces 6-channel playback of the input source using the Matrix 6.1 decoder. The virtual rear center speaker can be used when playing a 5.1-channel source.
- OFF: Virtual rear center speaker does not work in this setting.



- When the Matrix 6.1 decoder is functioning, the “MATRIX” indicator lights up on the front panel display.

Notes

- Some Dolby Digital Surround EX or DTS ES software may not contain the signal that is necessary for this unit to switch to the Matrix 6.1 decoding mode. To turn on the Matrix 6.1 decoder when playing such a source, select “Matrix6.1”.
- Playing a 6.1-channel source is not possible even if MATRIX6.1 is pressed in the following cases:
 - when “1C REAR LR” in the SET MENU is set to NON;
 - when the sound effect is turned off;
 - when headphones are connected;
 - when a Dolby Digital KARAOKE source is being played;
 - when 5ch Stereo is selected.
- The setting becomes AUTO once this unit turns into standby mode.

■ Virtual CINEMA DSP

With Virtual CINEMA DSP, you can enjoy all DSP programs without rear speakers. It creates virtual speakers to reproduce a natural sound field.

You can listen to virtual CINEMA DSP by setting “1C REAR LR” in the SET MENU to NON. Sound field processing changes to VIRTUAL CINEMA DSP automatically.



- When virtual CINEMA DSP is functioning, the “VIRTUAL” indicator lights up on the front panel display.

Note

- This unit is not set in the virtual CINEMA DSP mode even if “1C REAR LR” is set to NON in the following cases:
 - when the 5ch Stereo, DOLBY DIGITAL Normal, Pro Logic Normal, Pro Logic II, or DTS Normal program is selected;
 - when the sound effect is turned off;
 - when 96-kHz sampling digital signals are input to this unit;
 - when using the test tone; or
 - when connecting the headphones.

■ SILENT CINEMA DSP

You can enjoy a powerful sound field similar to what you could expect from actual speakers with SILENT CINEMA DSP. You can listen to SILENT CINEMA DSP by connecting your headphones to the  SILENT jack while the digital sound field processor is on. Enjoy all the DSP program using the headphones. The “SILENT” indicator lights up on the front panel display. (When sound effects are off, you listen to the source with normal stereo reproduction.)



- When SILENT CINEMA DSP is functioning, the “SILENT” indicator lights up on the front panel display.

Notes

- This feature is not available when 96-kHz sampling digital signals are input to this unit.
- The sound of LFE channel will be mixed and output from the headphone.

■ Normal Stereo Reproduction

Press STEREO to turn off the sound effect for normal stereo reproduction.

Press STEREO again to turn the sound effect back on.

Notes

- If you turn off the sound effects, no sound is output from the center or rear speakers.
- The volume may be greatly reduced when you turn off the sound effects or if you set “4 D. RANGE” on the SET MENU to MIN. In this case turn on the sound effect.
- The sound of LFE channel will be directed to the front left and right or the subwoofer (or both) channels depending on the setting of “1D BASS” on the SET MENU.
- If you turn off the sound effects while a Dolby Digital or DTS signal is being output, the dynamic range of the signal is automatically compressed and the sounds of the center and rear speaker channels are mixed and output from the front speakers.

■ Displaying the information about input signal

During stereo reproduction, you can display information such as the type, format and sampling frequency of the signal input from the components connected to this unit.

(While playing a stereo source)

- 1 Press AMP.
- 2 Press  to display the information about the input signal.



• Format:

The type of an input signal. When digital input is not known, the mode is set to the analog mode.

Input signal	Display
Analog signal	Analog
PCM signal	PCM
Dolby Digital signal	Dolby Digital
DTS signal	DTS
Other digital signals	Unknwn Digital (Unknown Digital)

• fs:

The sampling frequency of an input signal when a digital signal is input. If the frequency is not known, “unknown” appears on the front panel display.

• Audio Channels:

The number of audio channels included in an input signal when a Dolby Digital or DTS signal is input.

• Rate (bit rate):

The amount of data contained in an input signal per second when a Dolby Digital or DTS signal is input. If the bit rate is not known, “unknown” appears on the front panel display.

• Flg (flag):

An identification signal contained in an input signal when a Dolby Digital or DTS signal is input. If the flag is not detected, “None” appears on the front panel display.

■ Notes on 96-kHz sampling digital signals

The digital input jacks of this unit can handle 96-kHz sampling digital signals. Note the following when 96-kHz sampling digital signal is input to this unit:

- DSP programs cannot be selected.
- Sound will be output as 2-channel stereo from only the front left and right speakers. (There may be sound output from the subwoofer depending on the SPEAKER MODE settings on the SET MENU.) Therefore, the level of the effect speakers cannot be adjusted while listening to such a source.

RECORDING

Recording adjustments and other operations are performed from the recording components. Refer to the operation instructions for these components.

1 Turn on the power of this unit and all connected component.

2 Select the source component you want to record from.

The procedure for selecting an input source is the same as the one described in “BASIC PLAYBACK” on page 21.

3 Start playback (or select a broadcast station) on the source component.

4 Start recording on the recording component.

Notes

- Do a test recording before you start an actual recording.
- When this unit is set in the standby mode, you cannot record between the components connected to this unit.
- The setting of BASS BOOST, VOLUME, “5 L/R BALANCE” on the SET MENU and DSP programs does not effect the recorded material.
- A given input source is not output to the same OUT (Rec) channel. (For example, the signal input from VCR IN is not output to VCR OUT.)
- Check the copyright laws in your country to record from records, CDs, radio, etc. Recording of copyrighted material may infringe copyright laws.
- It is not possible to record the sound effect created by this unit’s DSP processing.
- While recording video images played during the DVD mode, do not display ON-SCREEN menu. If displayed, the menu will be also recorded.
- During digital recording, Karaoke vocal and Cinema dialog functions do not work. (See pages 35 and 36.)

If you playback a video source that uses scrambled or encoded signals to prevent it from being dubbed, the picture itself may be disturbed due to those signals.

■ Special considerations when recording DTS software

Attempting to digitally record the DTS bitstream will result in noise being recorded.

■ Timer playback/recording

This unit can perform playback or recording with an external timer (not supplied). Refer to the operating instructions for the component and the timer to be used.

Notes

- Stored data, such as input source, will be reflected when playback or recording with the timer.
- If you do not want any sound output when recording with a timer, turn the volume down.

DISC INFORMATION

Types of disc that this unit can play

This unit is designed for use with following types of disc only. Never attempt to load any other type of disc into this unit because it may damage this unit.



In this manual, the type of discs are indicated as below.

DVD-Video	DVD-Audio	Video CD	Audio CD
DVD-V	DVD-A	VCD	CD

Notes

- This unit is not compatible with Photo-CD, CD-ROM, DVD-ROM, DVD-RAM, SVCD, CDV, etc. (some DVD-R, DVD-RW and DVD+RW can be played).
- Be sure to use only discs made by reliable manufacturers. Some discs cannot be played depending on the disc characteristics or recording conditions.
- Do not use any non standard shaped discs (heart, etc.).

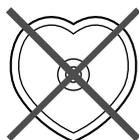

- Some DVD and VCD features described in this manual may not be available or may operate in a different way because they are subject to software producer's design. Check each disc's instruction.
- This unit cannot play the video parts of a disc whose video signal type is PAL. (U.S.A. and Canada models only)

Region management information

This unit is designed to meet DVD standard that supports region management system. Check the regional code number marked on the disc packages. If the number does not match this unit's region number (see the table shown below or the back of this unit), this unit refuses to play that disc.

Model	Region number of this unit	Discs can be played
U.S.A. and Canada models	"1"	"1", "ALL" or a mark which includes the region number "1".
U.K. and Europe models	"2"	"2", "ALL" or a mark which includes the region number "2".
Australia model	"4"	"4", "ALL" or a mark which includes the region number "4".
General model	"3"	"3", "ALL" or a mark which includes the region number "3".

Notes about handling discs

- Hold discs by touching only the edges or center hole.

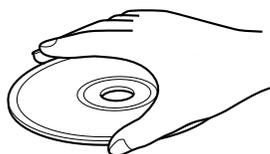

- When a disc is not currently being loaded on the disc tray, store it in an appropriate case.
- Do not use a disc printed on its surface by a commercially available label printer.
- Do not expose discs to direct sunlight, high temperature or high humidity for a long period of time, because these might warp or otherwise damage the disc.

NO!



- Playback of discs is generally not affected by small particles of dust or fingerprints on their playing surface. Even so, they should be kept clean. Wipe by using a clean, dry cloth. Do not wipe with a circular motion; wipe straight outward from the center.

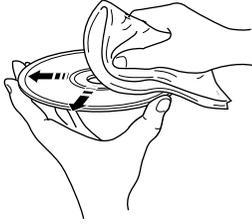

- Do not try to clean the disc's surface by using any type of disc cleaner, record spray, anti-static spray or liquid, or any other chemical-based liquid, because such substances might irreparably damage the disc's surface.

MP3 playback

This unit can play MP3 format audio recorded for personal use with a computer etc. onto CD-R or CD-RW. Play may not be possible in some cases due to the condition of the recording.

Discs recorded using MP3 differ from CDs in the following ways.

Structure of the disc (example)

Since the MP3 format can store several albums on a disc, a folder is assigned to a "Title", and a file is assigned to a "Chapter".

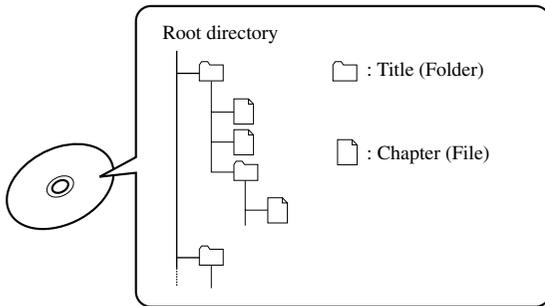

Starting play from a selected chapter

Select a chapter using the numeric buttons (see "To select a specific track" on page 33) and press ENTER.

Repeat play

You can use chapter repeat or title repeat. (See page 45.)

On-screen icons for disc information during play

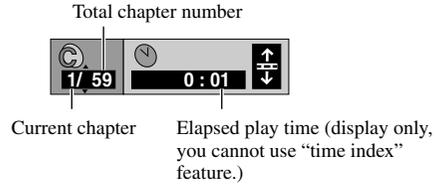

- The following settings are recommended.
 - The bit rate 128kbps
(The bit rates ranging from 32kbps to 320kbps are accepted.)
 - The sampling frequency 44.1kHz
(The sampling frequency 32kHz is not accepted.)

Note

- Chapters may not be played in the order that you arranged them when recording.

REMOTE CONTROL (DVD MODE)

This section explains how each button on the remote control functions when you play a disc. Press DVD first when using this unit as a DVD player.

- The buttons on the remote control whose names are written in green are operation buttons when you operate this unit in the DVD mode.
- When pressing any of ⑦ ⑨ ⑮ ⑰ ⑱ ⑳ while pressing SHIFT, these buttons function to operate this unit as a DVD player.

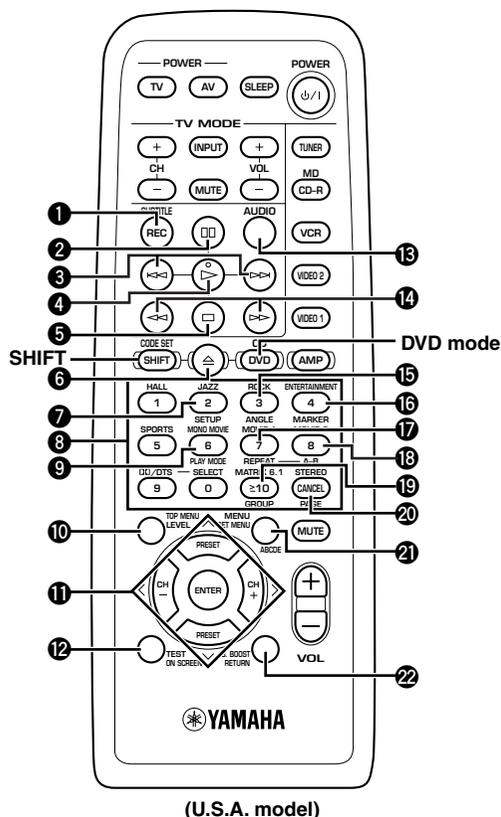

(U.S.A. model)

① SUBTITLE

Press to select a subtitle language.

② □□

Press to pause.

③ ⏮ ⏭ (P.33)

④ ▷

Press to start playback.

⑤ □

Press to stop playback.

⑥ ▲

Press to open and close the disc tray.

⑦ SETUP

Press to call up the setup menu screen.

⑧ Numeric buttons/CANCEL

Press to enter numbers./Press to cancel a specific mode or a setting.

⑨ PLAY MODE

Press to switch among random play, program play, and normal play.

⑩ TOP MENU

Press to display a disc menu screen.

⑪ ^, v, <, >/ENTER

Use to select and determine an item on menu screen, etc.

⑫ ON SCREEN

Press to turn the on-screen icons on and off on the video monitor.

⑬ AUDIO (P.41)

⑭ << >> (P.33)

⑮ ANGLE (P.41)

⑯ MARKER (P.44)

⑰ REPEAT (P.45)

⑱ A-B (P.46)

⑲ GROUP (P.39)

⑳ PAGE (P.40)

㉑ MENU

Press to call up menu screen contained in the disc.

㉒ RETURN

Press to go back to the previous screen when operating in the menu screen.

PLAYING A DISC

Basic operation

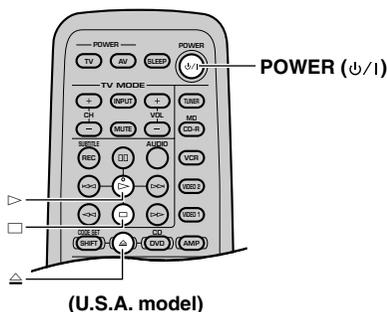
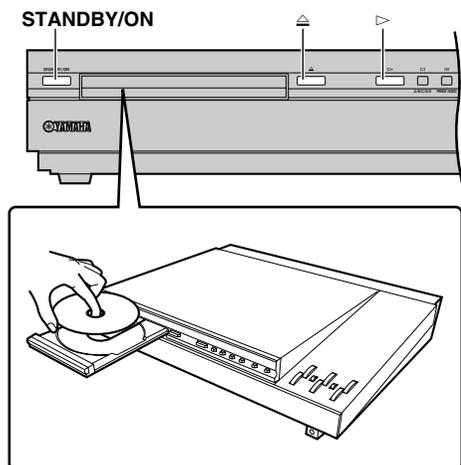

■ To stop playback

Press □.

Resume function

This unit memorizes where □ was pressed as long as this unit is turned on (▶ indicator flashes on the display).

When you press ▷ in this status, playback resumes from where it was stopped.

To clear the memory, press □ once more so that the ▶ indicator goes off. (When a DVD-Video disc is played, a chapter review screen appears.)

Note

- Opening the disc tray cancels the resume function.

Chapter review function **DVD-V**

This function plays the first few seconds of each chapter from the beginning of the title up to the memorized point so that you can review previous chapters.

Press ▷ while the message for chapter review is displayed on the screen.

Notes

- This function may not work with some DVDs.
- Canceling resume function will also clear the chapter review function.

■ After operation

Remove the disc by pressing △ and then press STANDBY/ON on the front panel or POWER(⏻/⏮) on the remote control.

1 Press STANDBY/ON on the front panel or POWER (⏻/⏮) on the remote control to turn the power on.

2 Press △ to open the disc tray.

3 Load a disc.

4 Press ▷.

The disc tray closes and playback starts.



- When a menu screen appears **DVD-A** **DVD-V** **VCD** : See "Using a disc's menu" on page 38.

Notes

- When this unit finishes playing a DVD, this unit stops playback or shows the menu screen.
- This unit cannot play a CD-R or CD-RW disc unless the disc has been finalized. Please make sure to finalize the disc on the CD recorder before playing it on this unit.

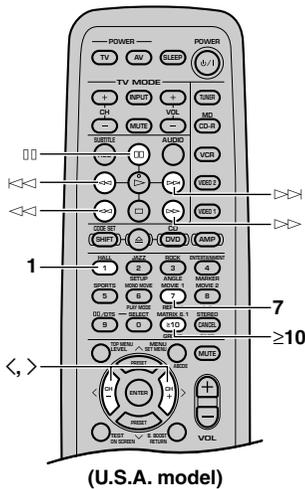

■ Skip

Press \triangleright (or \triangleleft) on the remote control to skip forward (or backward).

or

Press $\triangleright/\triangleright$ (or $\triangleleft/\triangleleft$) on the front panel to skip forward (or backward).

Press \triangleleft on the remote control or $\triangleleft/\triangleleft$ on the front panel once for each chapter (track) to be skipped.

Note

- When playing a VCD with playback control (p.38), skip operation may not function as described above.

■ To select a specific track

VCD **CD**

Enter a desired track number using numeric buttons. To select a two-digit number, press ≥ 10 and then enter the upper figure and the last figure successively.

Example (to select track 17):

1 Press ≥ 10 .

2 Press 1.

3 Press 7.

■ Search

Press \triangleright (or \triangleleft) on the remote control to search forward (or backward).

or

Press and hold $\triangleright/\triangleright$ (or $\triangleleft/\triangleleft$) on the front panel to search forward (or backward).



- To increase the speed, press or keep pressing \triangleright , \triangleleft on the remote control repeatedly or keep pressing $\triangleright/\triangleright$, $\triangleleft/\triangleleft$ on the front panel.

Note

- If you search forward or backward while a Dolby Digital or DTS disc is played, the input mode is automatically switched to the analog mode and cannot be switched to other modes.

■ Pause

Press \square .

To resume play, press \triangleright .

■ Frame advance/reverse

DVD-A **DVD-V** **VCD**

1 Press \square during playback.

2 Press the cursor buttons (\triangleleft , \triangleright).

- To return to normal play, press \triangleright .
- Each time you press the cursor buttons (\triangleleft , \triangleright), or when you keep pressing them, frames keep advancing or reversing.
- Frames also advance when \square is pressed.
- With some DVD-Audio discs, frames advance or reverse only in the video parts.

Note

- With Video CD, you cannot move backward.

■ Slow **DVD-A** **DVD-V** **VCD**

1 Press \square during playback.

2 Press \triangleright (or \triangleleft) on the remote control.

or

Press and hold $\triangleright/\triangleright$ (or $\triangleleft/\triangleleft$) on the front panel.

- To return to normal play, press \triangleright .
- To increase the speed, press or keep pressing \triangleright , \triangleleft on the remote control repeatedly or keep pressing $\triangleright/\triangleright$, $\triangleleft/\triangleleft$ on the front panel.

Note

- With Video CD, you cannot move backward.

ON-SCREEN MENU

You can control various items using on-screen menu bar.

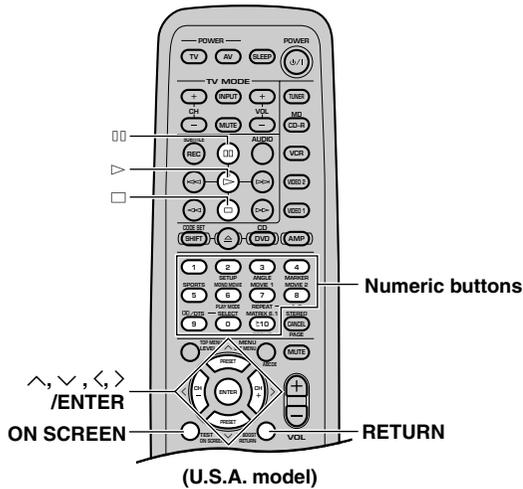

Icons for player menu has 4 different menu bars as below. To switch the menu bar, press the cursor buttons (\wedge , \vee).

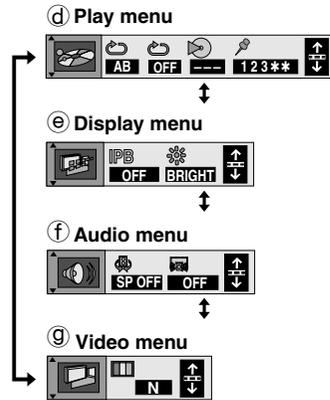

Operating menu bar

1 Press ON SCREEN.

Each time ON SCREEN is pressed, the menu bar changes as below.

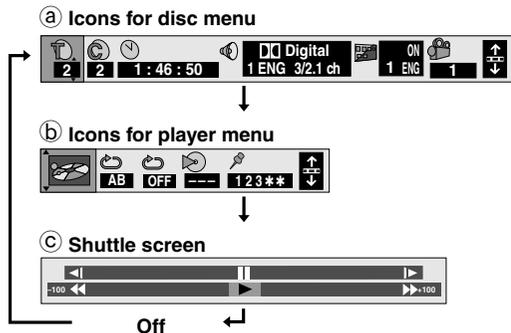

2 Press the cursor buttons (\leftarrow , \rightarrow) to select the item you wish to adjust.

The selected item is highlighted.

3 Press the cursor buttons (\wedge , \vee , \leftarrow , \rightarrow) to change setting.

- With some items, you need to press ENTER or \rightarrow to determine the setting.
- You can also use the numeric buttons when entering numbers to select a chapter, etc.

To turn the screen off

Press RETURN repeatedly.

Note

- Some items cannot be accessed when the play is stopped.

To change the menu bar position

When the menu bar does not appear properly, you can adjust its position.

1 Select the rightmost icon (\oplus).

Example)



2 Press the cursor buttons (\wedge , \vee) to move the menu bar.

Icons for disc menu

eg) DVD-Video



	Title number DVD-V Track number DVD-A VCD CD
	Chapter number DVD-V
	Group number DVD-A
	Time index (hour:minute:second) DVD-A DVD-V You can start play from the desired point by specifying the elapsed time. Eg) If you start play from 1:46:50 (1 hr 46 min 50 sec), press in the following order. [1]→[4]→[6]→[5]→[0]→[ENTER] Changing the time display DVD-A VCD CD Track elapsed time ↓ Track remaining time ↓ Disc remaining time
	Audio mode VCD When you select a channel, sound is output from the channel you have selected. LR ↔ L ↔ R
	DVD-A DVD-V ① Audio track number ② Audio track Language: See [A] for language abbreviations. ③ Audio signal type: See [B] for details.

Notes

- Display may differ in accordance with the disc's specification.
- Time remaining on the disc does not appear during program or random-sequence play.
- When playing a video-CD disc using playback control, no track number or time is displayed.

	Karaoke vocal on/off DVD-A DVD-V (Karaoke DVD only) This works only when DISC DIRECT is functioning. Solo: OFF or ON Duet: OFF, V1+V2, V1 or V2
	DVD-A DVD-V ① Subtitle on/off ② Subtitle language
	Angle number DVD-A DVD-V When selecting an angle number, the scene encoded with that angle is played.
	Playback control Indicates whether playback control is on or off. VCD Playback control cannot be adjusted.
	Page number DVD-A When you select a page number, the picture on that page is played.

[A] Language

ENG: English	SVE: Swedish	CHI: Chinese
FRA: French	NOR: Norwegian	KOR: Korean
DEU: German	DAN: Danish	MAL: Malay
ITA: Italian	POR: Portuguese	VIE: Vietnamese
ESP: Spanish	RUS: Russian	THA: Thai
NLD: Dutch	JPN: Japanese	*: Others

[B] Signal type/data

LPCM/PPCM/Dolby Digital/DTS/MPEG: Signal type
 k (kHz): Sampling frequency
 b (bit): Number of bits
 ch (channel): Number of channels

Example:

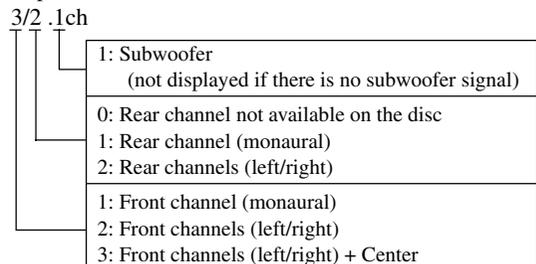

Icons for player menu

■ Play mode menu

eg) DVD-Video



	A-B repeat (→ P.46) DVD-A DVD-V VCD CD [ENTER] (start point)→[ENTER] (finish point) To cancel [ENTER]
	Repeat play (→ P.45) DVD-V C: Chapter, T: Title, OFF: Normal play, T: Track, A: All, G: Group, OFF: Normal play
	Play mode display DVD-A VCD CD The play modes cannot be adjusted. RND: Random play, PGM: Programmed play, ---: Normal play, ALL: All groups DVD-A
	Bookmarks (→ P.44) DVD-A DVD-V VCD CD You can mark at the points where you want to play again. (up to 5 points) To mark a point [<, >]→[ENTER] (at the desired point) ----- To recall a bookmark [<, >]→[ENTER] ----- To erase a bookmark [<, >]→[CANCEL]

■ Display menu

eg) DVD-Video



	IPB display DVD-V Displays the picture type (I/P/B)* of a still picture (when paused). ON ↔ OFF *I/P/B (P.73)
	Display dimmer Changes the brightness of the front panel display. BRIGHT ↔ DIM ↔ AUTO* ↑ When you select AUTO, the front panel display gets darker when the disc on which video images are recorded is being played. But when you pause etc, it gets brighter temporarily.

■ Audio menu

eg) DVD-Video



	This cannot be adjusted.
	Cinema dialog DVD-V (Dolby Digital/DTS 3ch or more channel discs) This works only when DISC DIRECT is functioning. When selecting ON, the volume level of the dialog part output from the center channel increases.

Video menu



	<p>Digital picture mode DVD-A DVD-V VCD</p> <p>N: Normal C: Cinema image (suited for movie viewing) U: User mode</p> <p>To change the user mode</p> <ol style="list-style-type: none"> 1 Select User mode. 2 Press (<, >) to select the item you wish to change. 3 Press (^, v) to change the setting. <p>The following items are displayed when you select "U".</p>
	<p>U Contrast (-7 to +7) Adjusts the contrast between light and dark part of the picture.</p>
	<p>Brightness (0 to +15) Adjusts the brightness of the picture.</p>
	<p>Sharpness (-6 to +6) (U.K., Europe, Australia and General models) Adjusts the horizontal resolution of the picture.</p>
	<p>Color (-7 to +7) Adjusts the shade of the picture's color.</p>

When PROGRESSIVE is on (U.S.A. and Canada models)

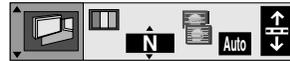

	<p>Digital picture mode DVD-A DVD-V VCD</p> <p>N: Normal C: Cinema image (suited for movie viewing)</p>
	<p>Transfer MODE Selects the method of conversion for progressive output to suit the type of material being played. Auto (normal): for viewing film material Video: for video material</p>

Shuttle screen

<p>Slow-motion play ◀◀: Backward DVD-A DVD-V</p>	<p>Pause DVD-A DVD-V VCD CD</p>	<p>Slow-motion play ▶▶: Forward DVD-A DVD-V VCD</p>
<p>Search ◀◀: Backward DVD-A DVD-V VCD CD</p>	<p>Play DVD-A DVD-V VCD CD</p>	<p>Search ▶▶: Forward DVD-A DVD-V VCD CD</p>

Note

- Slow-motion only works on the video parts of DVD-Audio.

USING MULTIPLE FUNCTIONS

Using a disc's menu

Discs may contain multiple audio tracks, subtitles, index and bonus materials such as movie trailers and cast information, etc. And many of them have menu screens that enable you to control these features. This section gives you general instruction about how to operate these screens. However, the operation methods may differ depending on the disc.

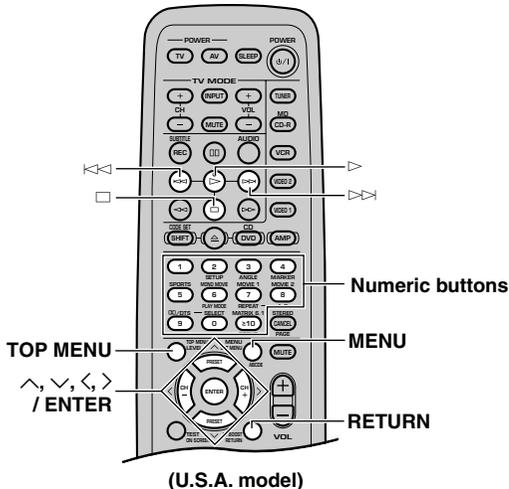

DVD-A DVD-V

1 Press TOP MENU or MENU during playback to show menu screen.

With some discs, menu screen appears automatically when you start playback.

2 Press the cursor buttons (↑, ↓, ←, →) to select the desired item and then press ENTER.

Video CD's playback control VCD

If a Video CD has "playback control" written on it or its jacket, it means that particular scenes or information can be selected for viewing interactively with the television using the menu screen. This unit can play Video CDs with playback control.

Using menus to control play of a Video CD is called "menu play" in these operating instructions.

Numeric buttons: Press to select the desired item.

RETURN: Press to go back to the previous screen.

▷ (PLAY): Press to play the selected item.

▷▷: Press to show the next screen.

◁◁: Press to show the previous screen.

□ (STOP): Press while a menu screen appears on the video monitor to cancel the playback control.

Note

- Playback control is automatically canceled during program play or random-sequence play.

Enhancing video quality [U.S.A. and Canada models only]

This unit's component video outputs are capable of output progressive signals. You can enjoy even higher quality picture if you have connected this unit to a monitor that can receive progressive signals.

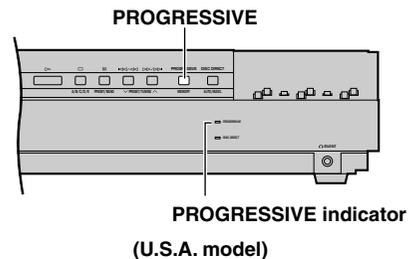

Press PROGRESSIVE on the front panel.

The PROGRESSIVE indicator lights up.

To cancel this feature, press PROGRESSIVE again.

Notes

- If the screen shifts off center when using progressive output, see “Adjusting the screen position” described below.
- When playing 4:3 aspect software with a 16:9 aspect wide-screen monitor using progressive output, the picture may appear horizontally stretched to fill the screen. In that case, change the aspect to the correct one at your monitor. If the monitor cannot change the aspect, it is recommended to turn the progressive feature off. (The progressive output is switched to the interlace output.)
- When the PROGRESSIVE function is working, video signals are output only from the component video jacks.

■ Adjusting the screen position (when using progressive output)

(U.S.A. and Canada models)

With some video monitors, the screen may shift off center with progressive signals output from this unit. To adjust the position, follow the method described below using the remote control.

- 1 Press \square to pause play.**
- 2 Follow the step 1 on “Operating menu bar” on page 34 to show the video menu.**
- 3 Press \triangleright to select the rightmost icon (A).**
- 4 Adjust the position.**
To move to the left, press the numeric button 1.
To move to the right, press the numeric button 3.

Example:



Press 3 to move to the right.

- Pressing the numeric button 2 after pressing 1 or 3 sets the screen back to the original position.
- You can check whether the picture is in the center or not by switching to normal output (press PROGRESSIVE so the indicator turns off).

5 Save the adjusted position.

First press \square and then press SETUP to show setup menu. Then press SETUP once again (or RETURN) and now the position is saved. Even if you skip this procedure, the position is saved until you turn the power off.

CONSUMERS SHOULD NOTE THAT NOT ALL HIGH DEFINITION TELEVISION SETS ARE FULLY COMPATIBLE WITH THIS PRODUCT AND MAY CAUSE ARTIFACTS TO BE DISPLAYED IN THE PICTURE. IN CASE OF 525 PROGRESSIVE SCAN PICTURE PROBLEMS, IT IS RECOMMENDED THAT THE USER SWITCH THE CONNECTION TO THE “STANDARD DEFINITION” OUTPUT. IF THERE ARE QUESTIONS REGRADING OUR VIDEO MONITOR COMPATIBILITY WITH THIS MODEL 525P DVD PLAYER, PLEASE CONTACT OUR CUSTOMER SERVICE CENTER.

This unit is compatible with YAMAHA digital cinema projector DPX-1.

DVD-Audio features DVD-A

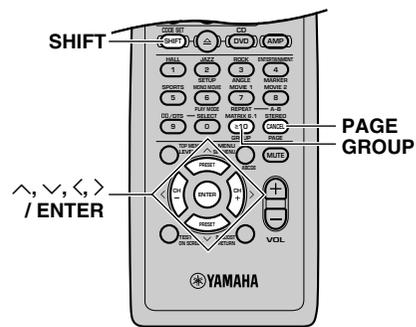

(U.S.A. model)

■ To play a track on a specific group

- 1 Press GROUP while pressing SHIFT.**
The group and track icons appear on the video monitor.
- 2 Press the cursor buttons (\wedge , \vee) to select a group number and press ENTER.**
- 3 Press the cursor buttons (\wedge , \vee) to select a track number and press ENTER.**
The selected track starts to play.



- You can also use the numeric buttons to select a group and a track.

■ To play a bonus group

Some discs contain bonus groups. If it requires 4 digit password, consult the disc jacket, etc.

- 1** Press **□** to stop play.
- 2** Press **GROUP** while pressing **SHIFT**.
The group and track icons appear on the video monitor.
- 3** Press the cursor buttons (**^**, **v**) to select a bonus group and then press **ENTER** or the cursor button (**>**).
- 4** Enter a 4 digit password using the numeric buttons and then press **ENTER**.
- 5** Press the cursor buttons (**^**, **v**) to select a track and then press **ENTER**.

■ To change pages

DVD-Audio may contain some information screens called “pages” that show photo galleries, artist biographies and lyrics, etc.

When it appears, you can move to another page by pressing **PAGE** while **SHIFT** is pressed. (Page number appears on the display when you change pages.).

Enhancing audio quality (DISC DIRECT) **DVD-A** **DVD-V** **VCD** **CD**

If you operate the DISC DIRECT function, a DVD-Audio disc is played with the multi-channels, and the DVD-Audio disc recorded with the 192kHz sampling frequency is played, keeping the original sound quality. This function also has an effect on improving the sound quality of a disc recorded with lower sampling frequency.

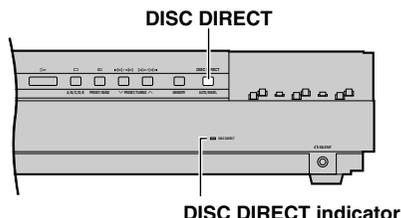

Press DISC DIRECT.

Each time DISC DIRECT is pressed, the display changes as follows: **AUTO**→**ON**→**OFF**→**AUTO** -...

- **AUTO**: Some discs switch this function on or off. (In the case of DVD-Audio discs, **AUTO** is automatically switched to **ON**.)
- **ON**: DISC DIRECT is turned on.
- **OFF** (initial setting): DISC DIRECT is turned off.



- When DISC DIRECT is functioning, the DISC DIRECT indicator on the front panel lights up.
- To adjust the output level of speakers while DISC DIRECT is functioning, see “Speaker settings” on the SETUP MENU on page 52.

Notes

- DISC DIRECT does not function while a SETUP MENU screen is displayed.
- When DISC DIRECT is functioning, note the following:
 - Sound effect is not added to reproduced sound. (Turn DISC DIRECT off to add sound effect.)
 - Only 1E, 5, 9 settings of the SET MENU items function. (See page 59.)
 - The output level of effect speakers cannot be adjusted during playback. (See page 64.)
 - Adjusting the output level of speakers using test tone in the AMP mode cannot be made. (See page 20.)
 - The displays of decoders, PCM, input signal channels etc do not light up on the front panel display.
 - The speaker settings are switched to the settings for DVD use. (See page 52.)
 - When using headphones, set the “Speaker settings” on the SETUP MENU to “2-channel”. (See page 52.)
 - With some discs, sound may not be output from the subwoofer.

Switching audio tracks, subtitles and angles

DVD-A DVD-V VCD

Some discs are encoded with several audio tracks, multilingual subtitles or multiple camera angles. Refer to disc jacket etc. to see which feature is supported.

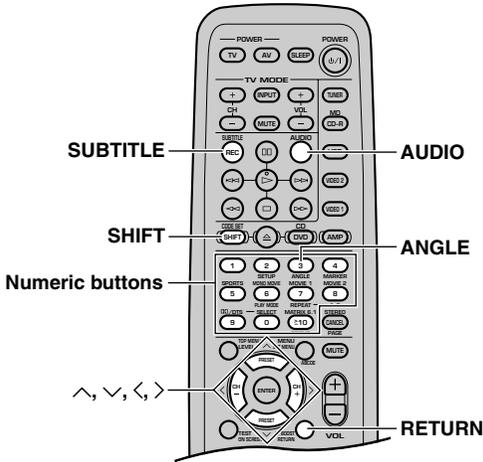

(U.S.A. model)

Audio tracks

Different audio track languages and/or formats can be selected if available on the disc.

Press AUDIO during play.



This icon appears on the video monitor.

- Pressing the button repeatedly toggles through all audio tracks recorded on the disc. You can also use the cursor buttons (^, v) or the numeric buttons to change tracks.

Notes

- Play restarts from the beginning of the current track if you change audio track while playing DVD-Audio, other than video section.
- With DVD-Audio, track number 2 may appear even if the disc does not support multiple audio tracks.
- You can also use the button to turn the vocals on and off on karaoke discs. See the instruction of each disc.

Subtitles

Press SUBTITLE during play.



This icon appears on the video monitor.

- Pressing the button repeatedly toggles through all subtitles recorded on the disc. You can also use the cursor buttons (^, v) or the numeric buttons to change subtitles.

Notes

- "-.-" appears if the disc does not have a subtitle.
- Subtitles may not change immediately after you press the button.

To turn on/off the subtitles:

1 Press SUBTITLE.

2 Press the cursor button (>).
(DVD-A, DVD-V ONLY)

3 Press the cursor buttons (^, v) to select ON and OFF.

Angles

Some DVDs have scenes encoded with multiple camera angles so that different viewpoint can be selected during playback. ANGLE lights up on the front panel display while a scene encoded with multiple angles is being played.

Press ANGLE while pressing SHIFT.



This icon appears on the video monitor.

- Pressing ANGLE repeatedly while pressing SHIFT toggles through all angles recorded on the disc. You can also use the cursor buttons (^, v) or the numeric buttons to change angles.

To turn the icon off

Press RETURN.

Notes

- With some discs, you cannot change audio tracks, subtitles or angles in the way described above. In that case, go to the disc menu and change them.
- With some discs, you cannot change angles.

All group play DVD-A

- 1** Press □ to stop play.
- 2** Press **PLAY MODE** while pressing **SHIFT**.
The “All group play” screen appears.
- 3** Press ▷.

Programmed play DVD-A VCD CD

You can enjoy listening to your favorite tracks selected from a disc in any desired order by programming tracks.

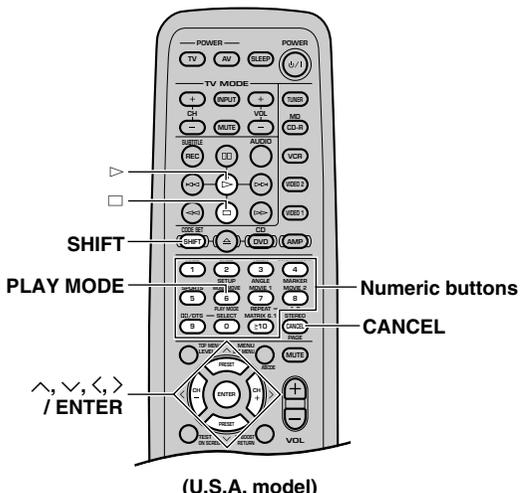

- 1** Press □ to stop play.

- 2** Press **PLAY MODE** repeatedly while pressing **SHIFT** to select the program screen.

Each time you press **PLAY MODE** while pressing **SHIFT**, the screen changes as follows:

Indication on the video monitor (example)

Program screen (Programmed play mode)
Playing in your desired order

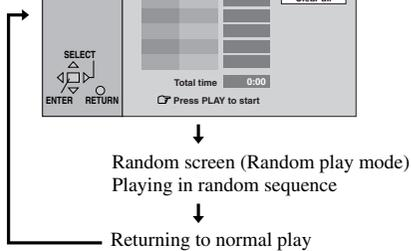
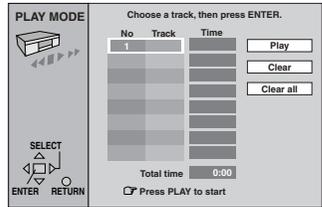

- The “PGM” indicator lights up on the front panel display.

- 3** Press numeric buttons to select the track.

- 4** Press ▷ to start play.



- You can also use the numeric buttons to select a track.

(In the case of DVD-Audio)

- The “All group play” screen is added to step 2.
- In step 4, press the cursor buttons (∧, ∨) to select a group and then press **ENTER**. Then, press the cursor buttons (∧, ∨) again to select a track and then press **ENTER**.
- You can also use the numeric buttons to select a group and a track.

To change or add to the program during programmed play

- 1** Press \square repeatedly to stop programmed play.
- 2** Press the cursor buttons (\wedge , \vee) to select the order of the tracks you want to play.
- 3** Press the numeric buttons to enter a track number.

To cancel the programmed tracks

- 1** Press \square repeatedly to stop programmed play.
- 2** Press the cursor buttons (\wedge , \vee) to select the track you want to cancel.
- 3** Press CANCEL.

Note

- When you program a track of a Video CD (ver.2.0), playback control is canceled during programmed play.

To move up and down the pages on the program screen

Press \llcorner to move up the page, or press \triangleright to move down the page.

To exit programming mode

- 1** Press \square repeatedly to stop programmed play.
- 2** Press PLAY MODE twice while pressing SHIFT.
 - When turning the power off, opening the disc tray, or switching the input source, all the programs are canceled.

Random play DVD-A VCD CD

When you select this mode, this unit plays all tracks on a disc in random sequence.

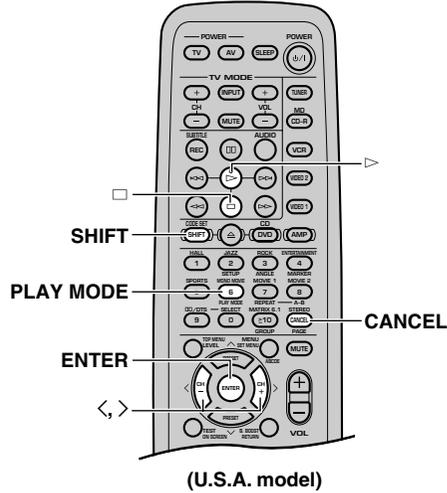

- 1** Press \square to stop play.
- 2** Press PLAY MODE repeatedly while pressing SHIFT.

The "RND" indicator lights up on the front panel display.
- 3** Press \triangleright to start random play.

■ To cancel random mode

1 Press **□** repeatedly to stop playback during random play.

2 Press **PLAY MODE** while pressing **SHIFT**.
The “RND” indicator goes off.
• Opening the disc tray also cancels this mode.

Note

- When this unit is in random mode while a Video CD (ver.2.0) is loaded, playback control is canceled during random play.

■ Random play (DVD-Audio)

In the step 2 of “Random play”, press the cursor buttons (<, >) to select a group and then press **ENTER**.

Eg) DVD-Audio (The disc that has 2 groups.)

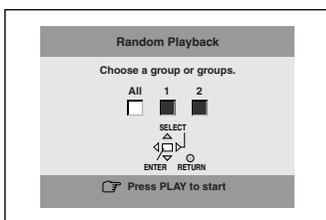

- You can select more than one group.
- You can use the numeric buttons to select a group.

If you want to cancel the group(s) you have selected while selecting them, press the cursor buttons (<, >) to select the group you want to cancel, and then press **CANCEL** or **ENTER**.



- You can also cancel a group by entering the number you want to cancel using numeric buttons.

Bookmarks DVD-A DVD-V VCD CD

This feature allows you to mark up to 5 points so that you can quickly return to those points later.

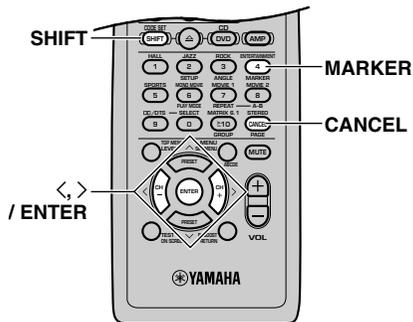

(U.S.A. model)

1 Press **MARKER** while pressing **SHIFT**.



This icon appears on the video monitor.

Highlighted

2 Press the cursor buttons (<, >) to select one of five asterisks.

The selected asterisk is highlighted.

3 Press **ENTER**.

The selected asterisk turns to be the bookmark number.



This icon appears on the video monitor.

Bookmark number

■ To play from the marked point

Press the cursor buttons (<, >) to select a bookmark number and press **ENTER**.

■ To clear a bookmark

Press the cursor buttons (<, >) to select a bookmark number and press **CANCEL**.

Note

- When you open the disc tray, turn this unit off or switch the input source, all bookmarks are cleared.

Repeat play DVD-A DVD-V VCD CD

This function allows you to play your desired chapter, track or disc repeatedly.

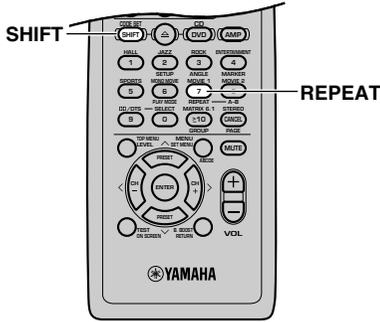

(U.S.A. model)

Press REPEAT while pressing SHIFT during playback to select repeat mode.

Each time this button is pressed, repeat mode changes as follows. The name of the selected repeat mode scrolls once on the multi-information display and the corresponding indicators light up.

Eg) DVD-Video



DVD-Video

- C: CHAPTER: The current chapter is played repeatedly.
 - T: TITLE: The current title is played repeatedly.
 - OFF: NORMAL PLAY: Repeat mode is canceled.
- DVD-Audio/Video-CD/CD**
- T: TRACK: The current track is played repeatedly.
 - A: ALL (Video CD, CD): The current disc is played repeatedly.
 - or
 - G: GROUP (DVD Audio): The current group is played repeatedly.
 - OFF: NORMAL PLAY: Repeat mode is canceled.



- When the repeat mode is OFF, “” indicator goes off.

Notes

- Repeat play may not work properly with some DVD-Video.
- Repeat play does not work with an interactive DVD-Video or during menu play of a VCD with playback control.

Program repeat

DVD-A VCD CD

Press REPEAT while pressing SHIFT during programmed play. (p.42)

Each time you press REPEAT while pressing SHIFT, the repeat mode changes as follows:

Eg) CD



DVD-Audio/Video-CD/CD

- T: TRACK: The current track is played repeatedly.
- A: ALL: The current programmed track is played repeatedly.
- OFF: NORMAL PLAY: Repeat mode is canceled. (returning to normal program play)

Random-sequence repeat

DVD-A VCD CD

Press REPEAT while pressing SHIFT during random play. (p.43)

Each time you press REPEAT while pressing SHIFT, the repeat mode changes as follows:

Eg) CD



DVD-Audio/Video-CD/CD

- T: TRACK: The current track is played repeatedly.
- A: ALL: The current disc is played repeatedly.
- OFF: NORMAL PLAY: Repeat mode is canceled. (returning to normal random play)

Repeat A-B DVD-A DVD-V VCD CD

This function allows you to specify two points and play between them repeatedly.

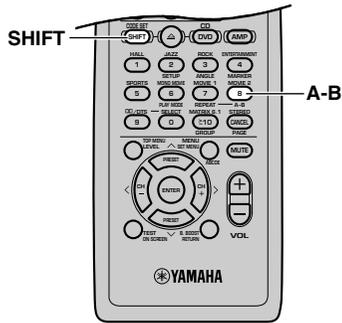

(U.S.A. model)

1 Press A-B while pressing SHIFT during play at the point where you want to start A-B repeat.



This icon appears on the video monitor.



- “” and “A-” light up on the front panel display.

2 Press A-B while pressing SHIFT at the point where you want to end A-B repeat.



This icon appears on the video monitor.



- “B” is added on the front panel display. The section between the point A and B starts playing repeatedly.

To cancel A-B repeat

Press A-B while pressing SHIFT.



This icon appears on the video monitor.

Notes

- This function may not available with some DVD-Video.
- This function works only within a title (DVD-Video) or a track (DVD-Audio, VCD, CD).

SETUP MENU

With the setup menu, you can change this unit's system defaults to suit your preference and this system.

Operating the setup menu

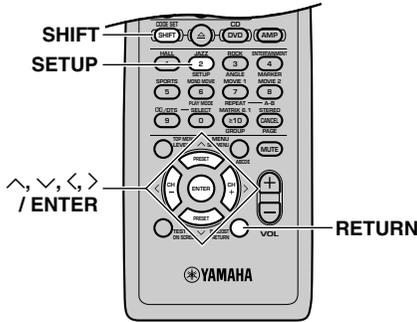

(U.S.A. model)

- 1 Press SETUP while pressing SHIFT.**
The menu screen appears on the video monitor.
- 2 Press the cursor buttons (<, >) to select a menu group.**
There are five menu groups. The screen shows the items that belong to the menu group of the selected tab.

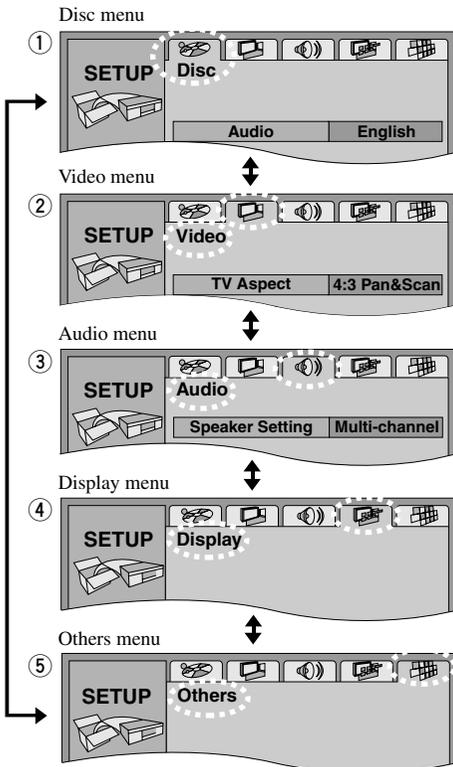

- 3 Press the cursor buttons (∧, ∨) to select the desired item and press ENTER.**

- 4 Press the cursor buttons (∧, ∨) to change the setting and press ENTER.**

When pressing ENTER, you can go back to the screen in step 2.

- **To go back to the previous screen**

Press RETURN.

- **To get out from the setup menu mode**

Press SETUP while pressing SHIFT.

Note

- When you display the setup menu screen, the DISC DIRECT function is automatically turned on. When finishing the setup menu, the setting of the function is automatically returned to the previous setting.

- **To return all the settings on the setup menu to the factory settings**

(While playback is stopped)

Keep pressing and on the front panel together until "Initialized" appears on the video monitor.

Summary of settings

The following chart shows the menu groups and each items. In the “Options” column, the factory settings are underlined.

Menu groups	Items	Options
Disc	Audio <input type="checkbox"/> DVD-A <input type="checkbox"/> DVD-V Select the preferred audio track language.	(U.S.A. and Canada models) <u>English</u> French Spanish Original* Other** (Australia model) <u>English</u> French German Italian Spanish Original* Other** (U.K. and Europe models) <u>English</u> French German Italian Spanish Original* Other** (General model) <u>English</u> Chinese Original* Other**
	Subtitle <input type="checkbox"/> DVD-A <input type="checkbox"/> DVD-V Select the preferred subtitle language.	(U.S.A. and Canada models) <u>Automatic</u> English French Spanish Other** (Australia model) <u>Automatic</u> English French German Italian Spanish Other** (U.K. and Europe models) <u>Automatic</u> English French German Italian Spanish Other** (General model) <u>Automatic</u> English Chinese Other**
	Menus <input type="checkbox"/> DVD-A <input type="checkbox"/> DVD-V Select the preferred disc menu language.	(U.S.A. and Canada models) <u>English</u> French Spanish Other** (Australia model) <u>English</u> French German Italian Spanish Other** (U.K. and Europe models) <u>English</u> French German Italian Spanish Other** (General model) <u>English</u> Chinese Other**
	Ratings <input type="checkbox"/> DVD-V Set a ratings level to limit DVD-Video play. See p.51 for details.	Setting ratings (When level 8 is selected) <u>8 No Limit</u> 1 to 7 0 Lock All Changing ratings (When level 0 – 7 is selected) Unlock Player Change Level Change Password Temporary Unlock
Video	TV Aspect If you connect to a 4:3 conventional-type monitor, select “4:3 Pan&Scan” (left and right sides trimmed when playing 16:9 software) or “4:3 Letterbox” (black areas appear at the top and bottom when playing 16:9 software). Select “16:9” if you connect to a widescreen monitor.	<u>4:3 Pan&Scan</u> 4:3 Letterbox 16:9
	Still Mode Specify the type of picture shown when paused. First select “Automatic”. If a still picture jitters, select “Field”. If details don’t appear clearly enough, select “Frame”.	<u>Automatic</u> Field Frame

Menu groups	Items	Options
Video	Black Level Control (U.S.A. and Canada models) Change the black level of the picture. Select "Lighter" when you connect to the monitor using VIDEO or S VIDEO terminal. Select "Darker" when using COMPONENT terminals.	<u>Lighter</u> Darker
	NTSC Disc Output (U.K., Europe, Australia and General models) Select video signal format (PAL 60 or NTSC) to be output when playing NTSC disc.	(U.K., Europe and Australia models) <u>PAL 60</u> NTSC (General model) PAL 60 <u>NTSC</u>
Audio	Speaker Setting <input type="checkbox"/> DVD-A <input type="checkbox"/> DVD-V Adjust the settings to suit your audio system and your listening environment when DISC DIRECT is functioning. See p.52 for details.	Multi-channel: Select this when connected to multi-channel system. There are three sub-items as below. <ul style="list-style-type: none"> • Speaker presence and size • Delay time • Channel balance
		2-channel: Select this when connected to 2-channel system.
	PCM Down Conversion <input type="checkbox"/> DVD-A <input type="checkbox"/> DVD-V Select how to output the high sampling-frequency audio signals on a disc that is not copyright-protected. See p.51 for details.	<u>No</u> Yes
	Dolby Digital <input type="checkbox"/> DVD-A <input type="checkbox"/> DVD-V Decide the signal type that output from this unit's digital outputs. Select "Bitstream" when connected device has Dolby Digital decoder. Select "PCM" when not.	<u>Bitstream</u> PCM
	DTS Digital Surround <input type="checkbox"/> DVD-A <input type="checkbox"/> DVD-V Decide the signal type that output from this unit's digital outputs. Select "Bitstream" when connected device has DTS decoder. Select "PCM" when not.	<u>Bitstream</u> PCM
	MPEG <input type="checkbox"/> DVD-A <input type="checkbox"/> DVD-V (U.K., Europe and Australia models) Decide the signal type that output from this unit's digital outputs. Select "Bitstream" when connected device has MPEG decoder. Select "PCM" when not.	<u>Bitstream</u> PCM
	D. Range Compression <input type="checkbox"/> DVD-A <input type="checkbox"/> DVD-V (Dolby Digital only) Change the dynamic range for late night viewing. Select "On" to make it easier to hear dialog etc. even at low volume level.	<u>Off</u> On
	Audio during Search <input type="checkbox"/> DVD-A <input type="checkbox"/> DVD-V <input type="checkbox"/> VCD Select whether to have sound during search. Select "Off" if sound distorted when searching with Dolby Digital or DTS material. With DVD-Audio, the sound may be heard even if you select "Off".	<u>On</u> Off
Display	Menu Language Select the preferred language for on-screen messages and setup menu.	(U.S.A. and Canada models) <u>English</u> Français Español (Australia model) <u>English</u> Français Deutsch Italiano Español (U.K. and Europe models) <u>English</u> Français Deutsch Italiano Español (General model) <u>English</u> 中文
	On-Screen Messages Select whether to show on-screen messages or not.	<u>On</u> Off

Menu groups	Items	Options	
Others	DVD-Video Mode Some DVD-Audio discs contain the DVD-Video contents that can be played only by a DVD-Video player. If you want to play the contents, select "On". If not, select "Off".	<u>Off</u>	On
	Demo A demonstration of the unit's on-screen displays starts when you select "On". The demonstration stops when you press button <input type="checkbox"/> etc. and the setting reverts to "Off".	<u>Off</u>	On

Notes

- * If you set to "Original" at Audio, the original language of each disc is selected.
- **If you set to "Other" at Audio, Subtitle or Menus, you need to select a four-digit number of the desired language from the language code list and enter with numeric buttons.
- When the audio you have selected from "audio language" is not recorded on the disc but instead the subtitle of the same language is recorded on it, the subtitle is displayed on the screen. However, if the audio is recorded on the disc, the subtitle is not displayed.

■ Language selection and language code list

Language code list			
6565: Afar	7079: Faroese	7678: Lingala	8375: Slovak
6566: Abkhazian	7082: French	7679: Laotian	8376: Slovenian
6570: Afrikaans	7089: Frisian	7684: Lithuanian	8377: Samoan
6577: Ameharic	7165: Irish	7686: Latvian, Lettish	8378: Shona
6582: Arabic	7168: Scots Gaelic	7771: Malagasy	8379: Somali
6583: Assamese	7176: Galician	7773: Maori	8381: Albanian
6588: Aymara	7178: Guarani	7775: Macedonian	8382: Serbian
6590: Azerbaijani	7185: Gujarati	7776: Malayalam	8385: Sundanese
6665: Bashkir	7265: Hausa	7778: Mongolian	8386: Swedish
6669: Byelorussian	7273: Hindi	7779: Moldavian	8387: Swahili
6671: Bulgarian	7282: Croatian	7782: Marathi	8465: Tamil
6672: Bihari	7285: Hungarian	7783: Malay	8469: Telugu
6678: Bengali; Bangla	7289: Armenian	7784: Maltese	8471: Tajik
6679: Tibetan	7365: Interlingua	7789: Burmese	8472: Thai
6682: Breton	7378: Indonesian	7865: Nauru	8473: Tigrinya
6765: Catalan	7383: Icelandic	7869: Nepali	8475: Turkmen
6779: Corsican	7384: Italian	7876: Dutch	8476: Tagalog
6783: Czech	7387: Hebrew	7879: Norwegian	8479: Tonga
6789: Welsh	7465: Japanese	7982: Oriya	8482: Turkish
6865: Danish	7473: Yiddish	8065: Punjabi	8484: Tatar
6869: German	7487: Javanese	8076: Polish	8487: Twi
6890: Bhutani	7565: Georgian	8083: Pashto, Pushto	8575: Ukrainian
6976: Greek	7575: Kazakh	8084: Portuguese	8582: Urdu
6978: English	7576: Greenlandic	8185: Quechua	8590: Uzbek
6979: Esperanto	7577: Cambodian	8277: Rhaeto-Romance	8673: Vietnamese
6983: Spanish	7578: Kannada	8279: Romanian	8679: Volapük
6984: Estonian	7579: Korean	8285: Russian	8779: Wolof
6985: Basque	7583: Kashmiri	8365: Sanskrit	8872: Xhosa
7065: Persian	7585: Kurdish	8368: Sindhi	8979: Yoruba
7073: Finnish	7589: Kirghiz	8372: Serbo-Croatian	9072: Chinese
7074: Fiji	7665: Latin	8373: Singhalese	9085: Zulu

Note

- Selecting audio, subtitle or disc menu language is a disc-dependent matter. The language selected at the setup menu is not effective if a disc does not have it.

Ratings DVD-V

Depending on software capability, you can prevent discs or scenes with objectionable material from being played according to your desired rating. You can select the level and lock it by designating a password.

Level 8	All DVDs can be played.
Level 7 to 1	Level of restriction becomes severer as the number gets smaller.
Level 0	All DVDs cannot be played.

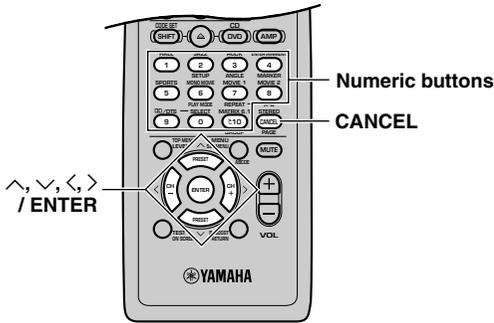

(U.S.A. model)

Setting method (Level 8)

- 1 Press SETUP while pressing SHIFT.**
The menu screen appears on the video monitor.
- 2 Press ∇ to select "Ratings" and press ENTER.**
- 3 Enter 4-digit number with numeric buttons and press ENTER.**
Press CANCEL if you want to re-enter other number.

The screen that confirms your password appears. Do not forget your password.

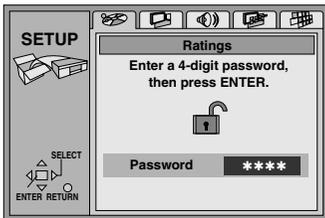

- 4 Press ENTER.**
When you select a disc that exceeds the rating you have set, a message appears on the video monitor. In that case, follow the procedure that appears on the screen. You can go back to the previous screen by pressing ENTER.

To change settings (Level 7 to 0)

When you select "Ratings" in the setup menu, the screen where you enter a password is displayed.

- 1 Enter 4-digit number with numeric buttons and press ENTER.**
Unlock Player: unlocks the rating and returns to level 8.
Change Password: changes the password.
Change Level: changes the level of the rating.
Temporary Unlock: temporarily unlocks the level of the rating. It will be kept unlocked until you switch the input source, turn the power off, or open the disc tray.

- 2 Press the cursor buttons (\wedge , ∇) to select the desired item and press ENTER.**

If you have forgotten your password

Return the setting to the factory setting. See page 47.

Note

- Not only the password setting but also all the other settings will turn back to the factory settings.

PCM down conversion DVD-A DVD-V

Decide whether to output high-quality digital signals (sampling frequency of 88.2 kHz and 96 kHz) or not, in accordance with the capability of the connected component.

- If your A/V component is capable of handling high-rate sampling frequency digital signals, select "No".
- If not, select "Yes" so that digital output signals are converted to 48 kHz or 44.1 kHz.

Note

- If a disc is copyright protected or has a sampling frequency of 176.4 kHz or more, signals are automatically converted to either 48 kHz or 44.1 kHz.

Speaker settings DVD-A DVD-V

When you adjust speakers while DISC DIRECT is functioning, follow the procedures described below.

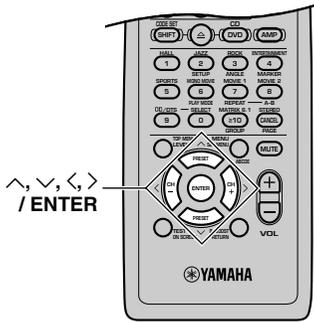

(U.S.A. model)

If you wish to enjoy multi-channel sound reproduction, you need to select “Multi-channel” on the setup menu and make following adjustments.

When you select “2-channel”, that is, when connecting to only 2 speakers or a Dolby Pro Logic decoder, the following adjustments are not necessary.

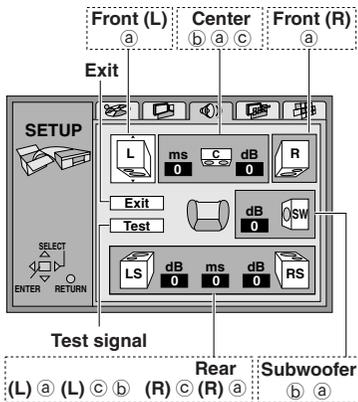

a Output mode

Change the settings of each speaker in accordance with your speaker system.

1 Press the cursor buttons (↑, ↓, ←, →) to select a speaker and press ENTER.

2 Press the cursor buttons (↑, ↓) to select the setting and press ENTER.

- Choices of the speaker size
 - L: Large, Small
 - R: Large, Small
 - C: Large, Small, None
 - SW: Used, Not used
 - LS: Large, Small, None
 - RS: Large, Small, None

The size of L is set to be the same as that of R.

Therefore, if you select Large for L, the size of R is automatically set to Large. This also applies to the sizes of LS and RS.

- Example: Rear left speaker



- ① when the speaker is not used.
- ② when using a large speaker capable of low-frequency (under 100 Hz) output.
- ③ when using a small speaker that is not capable of low-frequency output. (the included speakers, NX-S100S etc.)

- Factory settings of the speaker sizes
 - L/R: Large
 - C/LS/RS: Large
 - SW: Used

b Delay time
(Only center/rear channels of the DVD-Video discs recorded in the Dolby Digital format)

To obtain the maximum effect of Dolby Digital 5.1 channel source, all speakers should be located at the same distance from the listening position. However, in many cases the center speaker is placed in line with the front speakers, etc. You can virtually increase the distance of the center and rear speakers by adjusting the delay time.

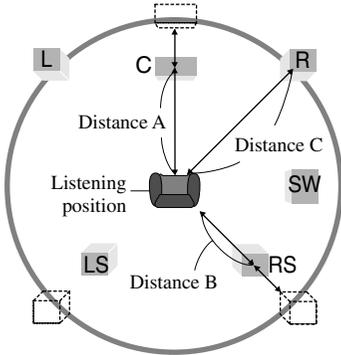

1 Press the cursor buttons (↑, ↓, ←, →) to select a “ms” box and press ENTER.

2 Press the cursor buttons (↑, ↓) to adjust the delay time and press ENTER.

- Settings
 - Distance A, Distance B \geq Distance C: 0 ms
 - Distance A, Distance B < Distance C: The following adjustments should be made.

Center speaker

Difference	Setting
Approx. 50 cm (1 1/2 feet)	1.3 ms
Approx. 100 cm (3 feet)	2.6 ms
Approx. 150 cm (5 feet)	3.9 ms
Approx. 200 cm (6 feet)	5.3 ms

Rear speakers

Difference	Setting
Approx. 200 cm (6 feet)	5.3 ms
Approx. 400 cm (12 feet)	10.6 ms
Approx. 600 cm (18 feet)	15.9 ms

c Speaker balance

You can adjust the output level of each effect speakers (center, rear L/R) using the test tone.

1 Press the cursor buttons (↑, ↓, ←, →) to select “Test” and press ENTER.

The test tone is one speaker at a time in below order, starting with the left front speaker.

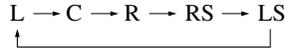

2 Listening to the test tone, press the cursor buttons (↑, ↓) to adjust the volume of effect speakers and press ENTER.

The value in the “dB” box changes.

Note

- The subwoofer cannot output the test tone. Play something and return to this screen to adjust the output level of the subwoofer.

To exit the speaker setting mode

Press the cursor buttons (↑, ↓, ←, →) to select “EXIT” and press ENTER.

Notes

- When DISC DIRECT is functioning, adjust the settings of the speakers on the SETUP MENU screen. However, when it is not functioning, follow the procedure in “ADJUSTING SPEAKER OUTPUT LEVELS” on page 20 to adjust the settings.
- These adjustments may not be effective when the disc’s original sound design is protected. P.PCM indicator lights up or D.MIX indicator turns off in that case.

TUNING

Indication on the front panel (example)

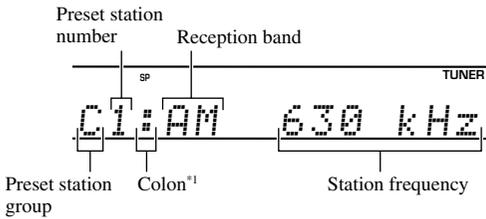

*1 The colon (:) lights up in the preset mode and goes off in the tuning mode.

Automatic and manual tuning

There are 2 ways to tune; automatic and manual. Automatic tuning is effective when station signals are strong and there is no interference.

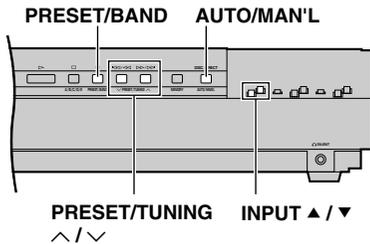

Automatic tuning

1 Press INPUT ▲ / ▼ (TUNER on the remote control) to select TUNER as the input source.

2 Press PRESET/BAND to select the reception band. ("FM" or "AM")

Each time PRESET/BAND is pressed, the mode changes as follows:
FM (Tuning mode) → AM (Tuning mode) → (Preset mode) → FM (Tuning mode) → ...



• Make sure that the colon (:) turns off when the mode switches to the tuning mode.

3 Press AUTO/MAN'L so that the "AUTO" indicator lights up on the front panel display.

4 Press PRESET/TUNING ^ / \ once to begin automatic tuning.

Press ^ to tune in to a higher frequency, or press \ to tune in to a lower frequency.



• Use the manual tuning method if the tuning search does not stop at the desired station because the signal is weak.
• When tuned in to a station, the "TUNED" indicator lights up and the frequency of the received station is shown on the front panel display.

Manual tuning

If the signal from the station you want to select is weak, you must tune in to it manually.

1 Select TUNER and the reception band following steps 1 and 2 described in "Automatic tuning" at left.

2 Press AUTO/MAN'L so that the "AUTO" indicator goes off from the front panel display.

3 Press PRESET/TUNING ^ / \ to tune in to the desired station manually.

Hold down the button to continue the tuning search.



• Manually tuning in to an FM station will automatically change the reception mode to monaural to increase the signal quality.

Presetting stations

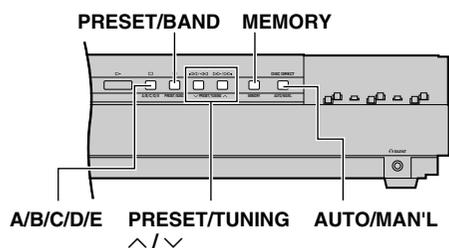

■ Automatically presetting stations (for FM stations)

This function enables this unit to automatically tune in to FM stations with strong signals, and to store up to 40 (8 stations x 5 groups) of those stations in order. This feature enables you to easily tune in to any preset station by selecting the preset station number.

- 1** Press **PRESET/BAND** to select the FM band.
- 2** Press **AUTO/MAN'L** so that the “AUTO” indicator lights up on the front panel display.

- 3** Press and hold **MEMORY** for more than 3 seconds.

The preset number and the “MEMORY” and “AUTO” indicators flash. Then, after about 5 seconds, automatic preset tuning begins from the frequency currently displayed toward the higher frequencies.

When automatic preset tuning is completed, the front panel display shows the frequency of the last preset station.



- When a station data is stored under a preset number, the frequency and reception band are also stored.
- You can manually replace a preset station with another FM or AM station by simply following the procedure in the section “Exchanging preset stations” on page 56.
- If the number of the received stations does not reach E8, automatic preset tuning has automatically stopped after searching all stations.

Notes

- Any stored station data existing under a preset number is cleared when you store a new station under that preset number.
- Only FM stations with sufficient signal strength are stored automatically by automatic preset tuning. If the station you want to store is weak in signal strength, tune in to it manually in the monaural mode, and store it by following the procedure in “Manually presetting stations”.

Automatic preset tuning options

You can select the preset group and number from which this unit will store FM stations and/or begin tuning toward lower or higher frequencies.

- 1** Follow steps 1 and 2 described in “Automatically presetting stations (for FM stations)” on the left.

(After keeping **MEMORY** pressed for more than 3 seconds)

- 2** Press **A/B/C/D/E** and **PRESET/TUNING ^/∨** to select the preset number under which the first station will be stored.

Automatic preset tuning will stop when stations have all been stored up to E8.

- 3** Press **PRESET/BAND** to turn off the colon (:) and then press **PRESET/TUNING ^/∨**.

When pressing ∨, automatic preset tuning begins from the frequency currently displayed toward the lower frequencies, and when pressing ^, it begins toward the higher ones.

■ Manually presetting stations

You can also store up to 40 stations (8 stations x 5 groups) manually.

- 1** Tune in to a station.

See page 54 for tuning instructions.

When tuned in to a station, the front panel display shows the frequency of received station.

- 2** Press **MEMORY**.

The “MEMORY” indicator flashes for about 5 seconds.

- 3** Press **A/B/C/D/E** repeatedly to select a preset station group (A to E) while the “MEMORY” indicator is flashing.

The group letter appears and make sure that the colon (:) appears on the front panel display.

- 4** Press **PRESET/TUNING ^/∨** to select a preset station number (1 to 8) while the “MEMORY” indicator is flashing.

Press ^ to select a higher preset station number.

Press ∨ to select a lower preset station number.

OPERATING OTHER COMPONENTS USING THE REMOTE CONTROL

Setting the manufacturer code (remote control signal assigned to each manufacturer) for your TV, VCR or MD/CD recorder on the remote control allows you to operate not only the DVX-S100 but also your TV, VCR or MD/CD recorder using the remote control.

Note

- Depending on the model, certain components from other manufacturers cannot be controlled, or only limited functions can be controlled, even though the proper manufacturer code has been set. If you encounter this problem, please use the remote control supplied with the component.

Setting the manufacturer code

Manufacturer codes can be set for TV, VCR and MD/CD-R buttons only.

Note

- TV manufacturer codes can be set for the TV button only. However, any of the manufacturer codes can be set for the VCR and MD/CD-R buttons.

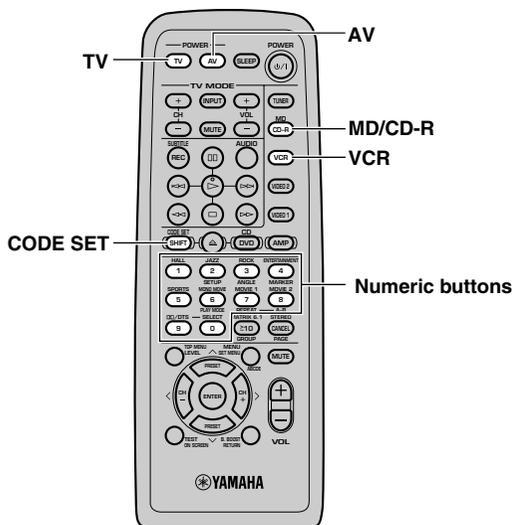

(U.S.A. model)

- 1** While pressing **CODE SET**, press the input selector button (**TV, VCR, MD/CD-R**) for which the manufacturer code is to be set.

Only one manufacturer code can be set for each input selector button.

Note

- Keep pressing **CODE SET** between step 1 and 2.
- Refer to “LIST OF MANUFACTURER’S CODES” at the end of this manual.

- 2** Keeping **CODE SET** pressed, enter the 1-digit device code and the 2-digit manufacturer code for the component to be controlled using the numeric buttons.

You can release **CODE SET** after entering the code.



- The manufacturer code 99 has been set for the remote control selector buttons (TV, VCR and MD/CD-R) at the factory.

- 3** Press **POWER (TV or AV)** and check that the component to be controlled turns on and off (standby).

Precautions when performing the setting

You can operate the component using the TV, VCR or MD/CD-R operation buttons on the remote control once the manufacturer code is set properly. If unsuccessful, perform the procedure from step 1 again. Pay attention to the following points when you perform the procedure.

- Check that the correct remote control selector button has been selected when setting the manufacturer code.
- If more than one code is given for a manufacturer, try entering each code in the order given.
- Remove and replace the remote control’s batteries (complete this step within 2 minutes) and then perform the procedure. While replacing the batteries, be sure not to press any button on the remote control. Doing so may erase the manufacturer code which has been set for other remote control selector buttons.

To reset the manufacturer code to the factory-set code

Follow steps 1 to 2 for the procedure “Setting the manufacturer code”, and enter the device code for the component and “99” while pressing **CODE SET** in step 2. (It is not necessary to follow step 3.)

■ Table of control buttons

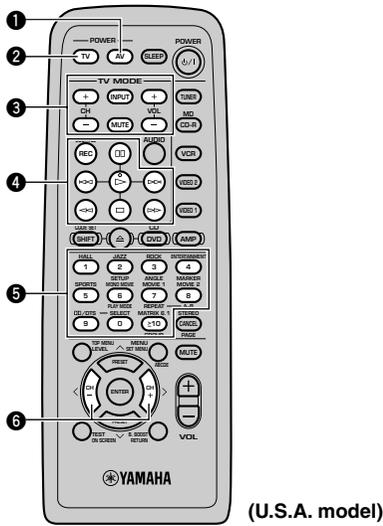

When you press the input selector button for which a manufacturer code has been set, many buttons on the remote control function differently to operate each component as shown in the table below.

When you press the TV button, the TV is automatically turned on. The AV components such as VCR are turned on when you press the AV button after pressing the corresponding input selector buttons.

Component Control button	VCR	TV	CD/MD recorder
1 AV	*1Power	*3VCR power	*1Power
2 TV	*2TV power	TV power	*2TV power
3 TV CH +	*2TV channel up	TV channel up	*2TV channel up
TV CH -	*2TV channel down	TV channel down	*2TV channel down
TV VOL +	*2TV volume up	TV volume up	*2TV volume up
TV VOL -	*2TV volume down	TV volume down	*2TV volume down
TV MUTE	*2TV mute	TV mute	*2TV mute
TV INPUT	*2TV input	TV input	*2TV input
4 *4REC	Rec	*3VCR rec	Rec (MD)
▷	Play	*3VCR play	Play
◀◀	Search backward	*3VCR search backward	Search backward
▶▶	Search forward	*3VCR search forward	Search forward
⏸	Pause	*3VCR pause	Pause
◀◀◀	-	-	Skip backward
▶▶▶	-	-	Skip forward
◻	Stop	*3VCR stop	Stop
5 1-9, 0, ≥10	-	-	Numeric buttons
6 CH +	VCR channel up	-	-
CH -	VCR channel down	-	-

*1 This button functions only when the original remote control of the component has POWER button.

*2 These buttons can operate your TV without switching the input if the manufacturer code is set in TV.

*3 These buttons can operate your VCR without switching the input to VCR if the manufacturer code is set in input selector buttons (except TV).

*4 Only when pressing this button twice in quick succession within one second, the button functions.



- If the manufacturer code of TV has been set for the TV button, the control buttons **2** and **3** can also operate your TV even if any input selector button is pressed.

SET MENU

The SET MENU consists of 9 items including the speaker mode setting. Choose the appropriate item and adjust or select the values as necessary.



- You can adjust the items on the SET MENU while playing a source.

List of SET MENU items

Items	Initial settings
1 SPEAKER SET	
A CENTER	SML (small)
B FRONT	SMALL
C REAR LR	SML (small)
D BASS	SWFR
E F. Level	Nrm (Normal)
2 LFE LEVEL	
SP LFE	0 dB
HP LFE	0 dB
3 SP DLY TIME	0 ms
4 D. RANGE	
SP D.R	MAX
HP D.R	MAX
5 L/R BALANCE	0 dB for L/R
6 HP TONE CTRL	
HP BASS	0 dB
HP TRBL	0 dB
7 I/O ASSIGN	
[A] OPTICAL INPUT	VIDEO 1
[B] COAXIAL INPUT	MD/CD-R
8 INPUT MODE	AUTO
9 SP/PRE OUT	SP

In the descriptions for each item from the following page, the default setting is indicated in bold.

Adjusting the items on the SET MENU

Adjustment should be made with the remote control.

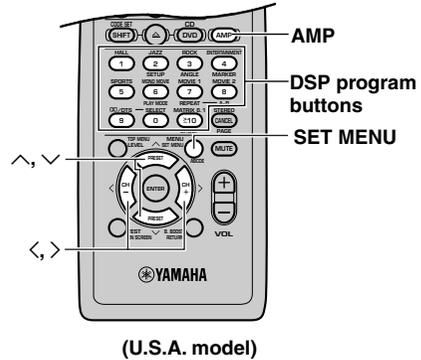

Note

- Some items require extra steps.

- 1 Press AMP.**
- 2 Press SET MENU to enter the SET MENU.**
- 3 Press \wedge/\vee repeatedly to select the item you want to adjust (1 to 9).**



- By pressing SET MENU repeatedly, you can select items in the same order as when pressing \wedge/\vee .

- 4 Press \langle / \rangle once to enter the setup mode of the selected item.**
The last setting you adjusted appears on the front panel display.
Depending on the item, press \wedge/\vee to select a sub item.
- 5 Press \langle / \rangle repeatedly to change the setting of the item.**
- 6 Press \wedge/\vee repeatedly until the menu disappears or simply press one of the DSP program buttons to exit SET MENU.**

1 SPEAKER SET (speaker mode settings)

Use this feature to select suitable output modes for your speaker configuration.

If you do not use one or any of the included speakers, or if you use other speakers instead of the included speakers, set the following.

Note

- When 96-kHz sampling digital signals are input to this unit, some items are not affected.

■ 1A CENTER (center speaker mode)

By adding a center speaker to your speaker configuration, this unit can provide better dialog localization for several listeners and superior synchronization of sound and images.

Choices: LRG (large), **SML** (small), NON (none)

LRG

Select this if you have a large center speaker. The entire range of the center channel signal is directed to the center speaker.

SML

Select this if you have a small center speaker. The low-frequency signals (90 Hz and below) of the center channel are directed to the speakers selected with "1D BASS".

NON

Select this if you do not have a center speaker. All of the center channel signals are directed to the front left and right speakers.

■ 1B FRONT (front speaker mode)

Choices: LARGE, **SMALL**

LARGE

Select this if you have large front speakers. The entire range of the front left and right channel signal is directed to the front left and right speakers.

SMALL

Select this if you have small front speakers. The low-frequency signals (90 Hz and below) of the front channel are directed to the speakers selected with "1D BASS".

Note

- When you select FRONT for "1D BASS", the low-frequency signals (90 Hz and below) of the front channel are directed to the front speakers even if you select SMALL for the front speaker mode.

■ 1C REAR LR (rear speaker mode)

Choices: LRG (large), **SML** (small), NON (none)

LRG

Select this if you have large rear left and right speakers or if a rear subwoofer is connected to the rear speakers. The entire range of the rear channel signal is directed to the rear left and right speakers.

SML

Select this if you have small rear left and right speakers. The low-frequency signals (90 Hz and below) of the rear channel are directed to the speakers selected with "1D BASS".

NON

Select this if you do not have rear speakers.



- This unit is set in the virtual CINEMA DSP mode when you select NON for "1C REAR LR".

■ 1D BASS (LFE/bass out mode)

LFE signals carry low-frequency effects when this unit decodes a Dolby Digital or DTS signal. Low-frequency signals are defined as 90 Hz and below. The Low-frequency signals can be directed to both front left and right speakers, and the subwoofer (subwoofer can be used for both stereo reproduction and the DSP program).

Choices: **SWFR** (subwoofer), **FRONT**, **BOTH**

SWFR

Select this if you use a subwoofer. The LFE signals are directed to the subwoofer.

FRONT

Select this if you do not use a subwoofer. The LFE signals are directed to the front speakers.

BOTH

The LFE signals are directed to the subwoofer. Low-frequency signals designated to the front channels in accordance with other speaker mode settings are directed to both front speakers and a subwoofer.

■ 1E F. Level (front level mode)

Change this setting if you cannot match the output level of the center and rear (L/R) speakers with that of the front speakers because of unusually high-efficiency performance from the front speakers.

Choices: **Nrm** (Normal), **-10 dB**

Nrm

Select this if you can match the output level of the center and rear speakers with that of the front speakers when using the test tone.

-10 dB

Select this if you cannot match the output level of the effect speakers with that of the front speakers when using the test tone.

2 LFE LEVEL

Use this feature to adjust the output level of the LFE (low-frequency effect) channel when playing back a Dolby Digital or DTS signal. Adjust the LFE level according to the capacity of your subwoofer or headphones.

Control range:

SPEAKER

(SP LFE) -20 to 0 dB

HEADPHONE

(HP LFE) -20 to 0 dB

Initial setting: 0 dB

1 Press ∇/\wedge to select the item to be adjusted.

2 Press \leftarrow to adjust the LFE level.

3 SP DLY TIME (speaker delay time)

Use this feature to adjust the delay of the center channel sounds. This feature works when there is sound output from the center speaker, with a source like Dolby Digital or DTS, etc. Ideally, the center speaker should be the same distance from the main listening position as the left and right speakers.

However, in most home situations, the center speaker is placed in line with the front speakers. By delaying the sound from the center speaker, the apparent distance from the center speaker to the main listening position can be adjusted to make it seem the same as the distance between the front left and right speaker to the listening position. Adjusting the delay time for the center speaker is especially important for giving depth to the dialogue.

Control range:

CENTER 0 to 5 ms

Initial setting:

CENTER 0 ms

Press </> to increase or decrease the delay of the center channel sounds.

Center speaker image

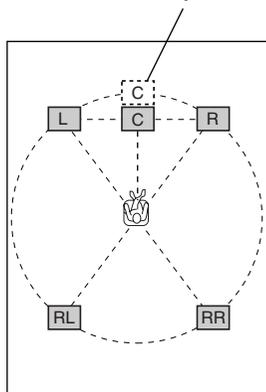

- Increasing the delay by 1 ms simulates moving the speakers about 30 cm (one foot) farther away from the listening position.

4 D. RANGE (dynamic range)

Use this feature to adjust the dynamic range. This setting is effective only when this unit is decoding Dolby Digital signals.

Choices: **MAX**, STD (standard), MIN (minimum)

MAX

Select the "MAX" for feature films.

STD

Select the "STD" for general use.

MIN

Select the "MIN" for listening to sources at low volume levels.

Note

- Some types of the Dolby Digital software do not support "MIN" for the dynamic range. If "MIN" is selected to play this type of software, the volume may be extremely lowered fall greatly, sharply. If this happens, select "MAX" or "STD".

5 L/R BALANCE (balance of the front left and right speakers)

Use this feature to adjust the balance of the output level from the front left and right speakers.

Control range: 20 steps each for L/R

Initial setting: 0 dB for L/R

Press > to decrease the output level for the front left speaker. Press < for the front right speaker.

6 HP TONE CTRL (headphone tone control)

Use this feature to adjust the level of the bass and treble when you use your headphones.

Control range (dB):

BASS -6 to +3

TRBL (treble) -6 to +3

Initial setting:

BASS 0 dB

TRBL 0 dB

Press > to increase the level of the bass and treble, and press < to decrease the level.

7 I/O ASSIGN (input assignment)

It is possible to assign jacks according to the component to be used if this unit's DIGITAL INPUT jack settings (component names for jacks) differ from that component. This makes it possible to change the jack assignment and effectively connect more components.

Once you assign, you can select that component with INPUT ▲ / ▼ on the front panel (or the input selector buttons on the remote control).

■ [A] OPTICAL INPUT jack

Choices: VIDEO 1, VIDEO 2, VCR, MD/CD-R

■ [B] COAXIAL INPUT jack

Choices: VIDEO 1, VIDEO 2, VCR, MD/CD-R

Note

- When you connect a component to both the COAXIAL and OPTICAL jacks, priority is given to the input signals from the COAXIAL jack.

8 INPUT MODE (initial input mode)

Use this feature to designate the input mode for sources connected to the DIGITAL INPUT jacks when you turn on this unit.

Choices: **AUTO**, LAST

AUTO

Select this to allow this unit to automatically detect the type of input signal and select the appropriate input mode.

LAST

Select this to set this unit to automatically select the last input mode used for the respective source.

9 SP/PRE OUT (output source settings)

Choices: **SP**, PRE

SP

Select this to direct signals to the speakers connected to the subwoofer (SW-S100). (No sound is output from 6CH PREOUT jacks.)

PRE

Select this to direct signals to 6CH PREOUT jacks or if you connect your external amplifier to 6CH PREOUT jacks on this unit. (No sound is output from the speakers connected to the subwoofer (SW-S100).)

ADJUSTING THE LEVEL OF THE EFFECT SPEAKERS

You can adjust the output level of each effect speaker (center, rear left and right, and subwoofer) while listening to a source.

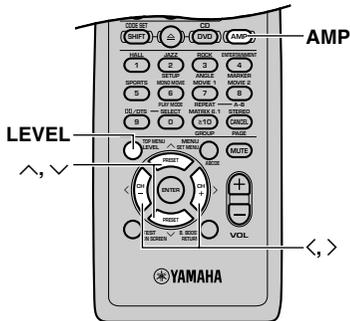

(U.S.A. model)

(While playing a source)

- 1** Press AMP.
- 2** Press LEVEL repeatedly to select the speaker(s) you want to adjust.

Each time you press LEVEL, the selected speaker changes and appears on the front panel display as follows: center, rear right, rear left and subwoofer.

CENTER (Center speaker) → R SUR. (Rear right speaker) → L SUR. (Rear left speaker) → SWFR (Subwoofer) → CENTER (Center speaker)...



- Once you press LEVEL, you can also select the speaker(s) to be adjusted by pressing \vee / \wedge .

- 3** Press \langle / \rangle to adjust the speaker output level.
 - The control range for the center or rear left and right speakers is from +10 dB to -10 dB.
 - The control range for the subwoofer is from +10 dB to -10 dB.

Notes

- When the speaker output modes for “1A CENTER” and “1C REAR LR” are set to NON, and “1D BASS” to FRONT, the output level of those speakers cannot be adjusted because there is no sound coming from these speakers.
- When you adjust the output level with LEVEL, the settings you made with the test tone will be changed.
- We recommend adjusting the speakers by following the steps described in “Using the test tone” on page 20.

For 5ch Stereo

You can adjust the volume level for each channel in 5-channel stereo mode.

Control range: 0 to 100%

Initial Setting: 100%

- **CT level** (Center level)
- **RL level** (Rear left level)
- **RR level** (Rear right level)

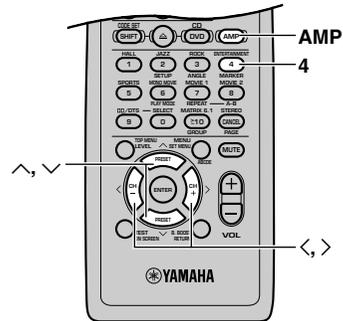

(U.S.A. model)

(While playing a source)

- 1** Press AMP.
- 2** Press “4” button to select 5ch Stereo.
- 3** Press \wedge / \vee repeatedly to select the speaker(s) you want to adjust.
- 4** Press \langle / \rangle to adjust the speaker output level.

Notes

- During the 5ch Stereo mode, the output level adjusted with the test tone or LEVEL is replaced with the level adjusted in the 5-channel stereo mode.
- When the speaker output modes for “1A CENTER” and “1C REAR LR” are set to NON, the output level of those speakers cannot be adjusted because there is no sound coming from these speakers.

CHANGING THE PARAMETER SETTINGS FOR DSP PROGRAMS

Adjusting the delay time

You can adjust the time difference between the beginning of the sound from the front speakers and the beginning of the sound effect from the rear speakers. The larger the value, the later the sound effect is generated. The delay time can be individually adjusted to all DSP programs.

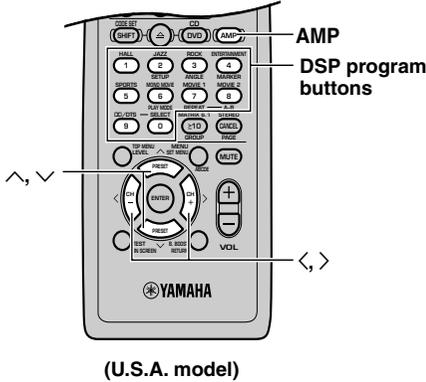

(While playing a source)

- 1** Press AMP.
- 2** Select a DSP program you want to adjust the delay time.
- 3** Press ^ / v so that "DELAY" appears on the front panel display.
- 4** Press < / > to adjust the delay time.

Notes

- Adding too much delay will cause an unnatural effect with some sources.
- The sound is momentarily interrupted while adjusting the delay time.

The following table shows factory-set delay time.

	Program	Preset value (ms)
1	CONCERT HALL	45
2	JAZZ CLUB	30
3	ROCK CONCERT	15
4	DISCO	26
	GAME	36
	CONCERT VIDEO	21
5	TV SPORTS	10
6	MONO MOVIE	69
7	70 mm SPECTACLE	23
	DGTL SPECTACLE	15
	DTS SPECTACLE	15
	Spectacle 6.1	15
	70 mm SCI-FI	20
	Sci-Fi 6.1	15
	DGTL SCI-FI	15
	DTS SCI-FI	15
	8	70 mm ADVENTURE
DGTL ADVENTURE		15
DTS ADVENTURE		15
Adventure 6.1		15
70 mm GENERAL		20
DGTL GENERAL		15
DTS GENERAL		15
General 6.1		15
9		PRO LOGIC/NORMAL
	DOLBY DIGITAL/NORMAL	5
	DTS DIGITAL SUR./NORMAL	5
	Matrix 6.1	5
	PRO LOGIC/ENHANCED	20
	DOLBY DIGITAL/ENHANCED	5
	DTS DIGITAL SUR./ENHANCED	5
	Enhanced 6.1	5
	PRO LOGIC II Movie	15
PRO LOGIC II Music	5	

Adjusting the parameter settings for PRO LOGIC II Music

■ Changing parameter settings

You can adjust the values of PRO LOGIC II Music parameters so the sound fields are recreated accurately in your listening room.

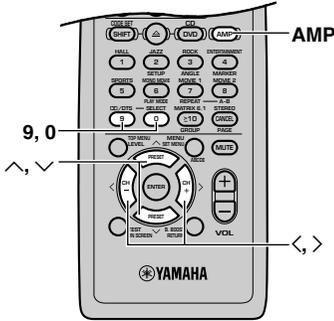

(U.S.A. model)

- 1** Press AMP.
- 2** Press the numeric buttons 9 and 0 repeatedly to select PRO LOGIC II Music.
- 3** Press ^ / v to select the parameter.
- 4** Press < / > to change the parameter value.
- 5** Repeat steps 3 and 4 above as necessary to change other parameters.

■ PRO LOGIC II Music parameter descriptions

PANORAMA

Function: Turning the function on extends the front stereo image to include the surround speakers for wraparound effect.

Choices: OFF/ON, initial setting is OFF.

DIMENSION

Function: Gradually adjusts the soundfield either towards the front or towards the rear.

Control range: -3 (towards the rear) to +3 (towards the front), initial setting is STD (standard).

CT WIDTH (Center width)

Function: Adjusts the center image from the center and front speakers to varying degrees. The larger the value, adjusts the center image towards the front left and right speakers.

Control range: 0 (center channel sound is output only from center speaker) to 7 (center channel sound is output only from front left and right speakers), initial setting is 3.

TROUBLESHOOTING

Refer to the chart below when this unit does not function properly. If the problem you are having is not listed below or if the instruction below does not help, set this unit to the standby mode, disconnect the power cord, and contact the nearest authorized YAMAHA dealer or service center.

■ General

Problem	Cause	Remedy	Refer to page
This unit fails to turn on when STANDBY/ON (or POWER (⏻/⏻)) is pressed, or enters in the standby mode soon after the power has been turned on.	The power cord is not connected or the plug is not completely inserted.	Firmly connect the power cord.	—
	This unit has been exposed to a strong external electric shock (such as lightning and strong static electricity).	Set this unit in the standby mode, disconnect the power cord, plug it back in after 30 seconds, then start operating.	—
No sound.	Incorrect input or output cable connections.	Connect the cables properly. If the problem persists, the cables may be defective.	14 – 19
	An appropriate input source has not been selected.	Select an appropriate input source with the input selector buttons.	21
	The speaker connections are not secure.	Secure the connections.	17 – 18
	The volume is turned down.	Turn up the volume.	21
	The sound is muted.	Press MUTE or any operation buttons of this unit to cancel a mute and adjust the volume.	21
	The source that this unit cannot reproduce, such as a CD-ROM, is being played.	Play a source whose signals this unit can reproduce.	—
The picture does not appear.	The output and input for the picture are connected to different types of video jacks.	Make connections using the same type of video jacks (S VIDEO or VIDEO (composite)) for both the input and output.	14
The sound suddenly goes off.	The sleep timer has functioned.	Turn on the power, and play the source again.	22
Only the speaker on one side can be heard.	Incorrect cable connections.	Connect the cables properly. If the problem persists, the cables may be defective.	17 – 18
Sound can be heard only from the front speakers.	The sound effect is off.	Press STEREO to turn it on.	27
	A Dolby Surround, Dolby Digital or DTS decoding DSP program is being used with material not encoded with Dolby Surround, Dolby Digital or DTS.	Select another DSP program.	23 – 24
	A 96-kHz sampling digital signal is being input to this unit.	When a 96-kHz sampling digital signal is being input to this unit, sound is output from the front speakers only.	27

Problem	Cause	Remedy	Refer to page
No sound from the center speaker.	The output level of the center speaker is set to minimum.	Raise the level of the center speaker.	64
	“1A CENTER” on the SET MENU is set to NON.	Select the appropriate mode for your center speaker.	60
	One of the Hi-Fi DSP programs (1 to 4) has been selected (except for 5ch Stereo).	Select another DSP program.	23 – 24
	The source encoded with a Dolby Digital or DTS signal does not have a center channel signal.		—
No sound from the rear speakers.	The output level of the rear speakers is set to minimum.	Raise the output level of the rear speakers.	64
	A monaural source is being played with program 9.	Select another DSP program.	23 – 24
No sound from the subwoofer.	“1D BASS” on the SET MENU is set to FRONT when a Dolby Digital or DTS signal is being played.	Select SWFR or BOTH.	61
	“1D BASS” on the SET MENU is set to SWFR or FRONT when a 2-channel source is being played.	Select BOTH.	61
	The source does not contain low bass signals (90 Hz and below).		—
Poor bass reproduction.	The speaker mode settings (front, center, or rear) on the SET MENU do not match your speaker configuration.	Select the appropriate position for each speaker based on the size of the speakers in your configuration.	60 – 61
A “humming” sound can be heard.	Incorrect cable connections.	Firmly connect the audio plugs. If the problem persists, the cables may be defective.	14 – 15
The volume level cannot be increased, or the sound is distorted.	The component connected to the OUT (Rec) jacks of this unit is turned off.	Turn on the power to the component.	—
The sound effect cannot be recorded.	It is not possible to record the sound effect by a recording component.		—
A source cannot be recorded by a digital recording component connected to the DIGITAL OUTPUT jack of this unit.	A source component is not connected to the DIGITAL INPUT jacks of this unit.	Connect the source component to the DIGITAL INPUT jacks of this unit.	14 – 15
This unit does not operate properly.	The internal microcomputer has been frozen by an external electric shock (such as lightning or excessive static electricity) or by a power supply with low voltage.	Disconnect the AC power cord from the outlet and then plug it in again after about 30 seconds.	—
There is noise interference from digital or high-frequency equipment, or this unit.	This unit is too close to the digital or high-frequency equipment.	Move this unit further away from such equipment.	—

■ Disc playback

Problem	Cause	Remedy	Refer to page
No response when buttons pressed.	Some operations may be prohibited by the disc.		—
Playback does not start.	The disc is damaged.	Check the disc carefully; replace it if necessary.	—
	There is moisture on the laser pickup.	Wait 1 to 2 hours after switching the unit on before trying to play a disc.	—
	The disc has been loaded upside down.	Reload the disc with the label side facing up.	—
	The disc is dirty.	Clean the disc.	30
Alternative languages fail to be selected.	An alternative language is not selected with discs which do not contain more than one language.		—
	In the case of some discs, the alternative language cannot be selected with [AUDIO] or [SUBTITLE]. Try selecting it from the disc's menu if one is available.		—
No subtitles.	The disc does not have subtitles.		—
	Subtitle is turned off.	Show subtitles by pressing SUBTITLE or using on-screen menu.	35
Angle cannot be changed.	The disc or the scene being played does not support multi-angle.		—
No sound. Distorted sound.	If the "D.MIX" indicator on the front panel display goes out while playing a multi-channel DVD-Audio disc, sound will only be output from speakers specified by the disc.		—
Sound "skips".	The disc is dirty.	Clean the disc.	30
Noise from inside of the unit.	The disc may be warped.	Replace the disc.	—
Picture distorted during SEARCH.	Some distortion is normal during SEARCH.		—
No picture.	(U.S.A and Canada models) If you play PAL system DVD-Audio, "This disc is PAL system. The output is sound only" may appear on the monitor. Picture is not available because the disc's video signal system is different.		—
Picture appears incorrectly.	Incorrect "TV aspect" setting.	Select the right position. However, it may be difficult to adjust many DVD-Videos' widescreen format to fit perfectly in your 4:3 video monitor.	48
	(U.S.A and Canada models) PROGRESSIVE is turned on even though the connected monitor cannot receive the progressive signals.	Turn off the PROGRESSIVE feature.	38 – 39
	(U.S.A and Canada models) Due to the editing method or material used on a DVD, ghosting may occur with progressive output.	Turn off the PROGRESSIVE feature.	38 – 39

Problem	Cause	Remedy	Refer to page
No on-screen display.		Go to Display on the SETUP menu, and select "On" for "On-Screen Messages".	49
On-Screen Menu Icons not displayed or only partially displayed on the television.		Press the cursor buttons [^,∨] while the rightmost icon is highlighted to change the menu bar position.	34
There is a lot of ghosting.		Use the on-screen menu icons to adjust the picture quality.	37
"No Play" appears on the unit's display.	The disc that this unit cannot play is loaded.		—
This unit does not recognize disc ("No disc" appears on the display, or the display shows the status when no disc is loaded).	The disc is not placed properly.	Place the disc properly.	—

■ Tuner

Problem		Cause	Remedy	Refer to page
FM/AM	Previously preset stations cannot be tuned in.	The preset stations are cleared.	Pre-set the stations once again.	55
FM	FM stereo reception is noisy.	The characteristics of FM stereo broadcasts may cause this problem when the transmitter is too far away or the antenna input is poor.	Check the antenna connections. Try using a high-quality directional FM antenna. Use the manual tuning method.	16 54
	There is distortion, and clear reception cannot be obtained even with a good FM antenna.	There is multipath interference.	Adjust the antenna position to eliminate multipath interference.	16
	The desired station cannot be tuned in with the automatic tuning method.	The station is too weak.	Use a high-quality directional FM antenna. Use the manual tuning method.	16 54
AM	The desired station cannot be tuned in with the automatic tuning method.	The signal is weak or the antenna connections are loose.	Tighten the AM loop antenna connections and orient it for best reception. Use the manual tuning method.	16 54
	There are continuous crackling and hissing noises.	Noises result from lightning, fluorescent lamps, motors, thermostats and other electrical equipment.	Use an outdoor antenna and a ground wire. This will help somewhat, but it is difficult to eliminate all noise.	16
	There are buzzing and whining noises (especially in the evening).	A TV set is being used nearby.	Move this unit away from the TV.	—

■ Remote control

Problem		Cause	Remedy	Refer to page
The remote control does not work nor function properly.	Wrong distance or angle.		The remote control will function within a maximum range of 6 m (20 feet) and no more than 30 degrees off-axis from the front panel.	7
	Direct sunlight or lighting (from an inverter type of fluorescent lamp, etc.) is striking the remote control sensor of this unit.		Reposition this unit.	—
	The batteries are weak.		Replace all batteries with new ones.	3
	The manufacture code is not correctly set.		Set the code correctly.	57
			Try setting another code of the same manufacturer.	57
Even if the manufacturer code is correctly set, there are some models that do not respond to the remote control.		Operate the component using its remote control.	—	

GLOSSARY

Bitstream

This is the digital form of multiple channel audio data (eg., 5.1 channel) before it is decoded into its various channels.

CINEMA DSP

Since the Dolby Surround and DTS systems were originally designed for use in movie theaters, their effect is best felt in a theater having many speakers and designed for acoustic effects. Since home conditions, such as room size, wall material, number of speakers, and so on, can differ so widely, it's inevitable that there are differences in the sound heard as well. Based on a wealth of actually measured data, YAMAHA CINEMA DSP uses YAMAHA original sound field technology to combine Dolby Pro Logic, Dolby Digital and DTS systems to provide the visual and audio experience of movie theater in the listening room of your own home.

Component video signal

With the component video signal system, the video signal is separated into the Y signal for the luminance and the P_B/C_B and P_R/C_R signals for the chrominance. Color can be reproduced more faithfully with this system because each of these signals is independent. The component signal is also called the "color difference signal" because the luminance signal is subtracted from the color signal. A monitor with component input jacks is required in order to use the component signal for output.

Decoder

A decoder restores the coded signals on DVDs to normal. This is called decoding.

Dolby Digital

This is a method of coding digital signals developed by Dolby Laboratories. Apart from stereo (2-channel) audio, these signals can also be 5.1-channel audio. A large amount of audio information can be recorded on one disc using this method.

Dolby Pro Logic

A surround system where a 4-channel audio track is recorded as 2 channels and then is restored to 4 channels for play. The surround channel is monaural and can reproduce up to 7 kHz.

Dolby Pro Logic II

Dolby Pro Logic II is an improved technique used to decode vast numbers of existing Dolby Surround software. This new technology enables a discrete 5-channel playback with 2 front channels, 1 center channel, and 2 rear channels (instead of only 1 rear channel for conventional Pro Logic technology). A music mode is also available for 2-channel sources in addition to the movie mode.

DTS (Digital Theater Systems)

This surround system is used in many movie theaters around the world. There is good separation between the channels, so realistic sound effects are possible.

Dynamic range

Dynamic range is the difference between the lowest level of sound that can be heard above the noise of the equipment and the highest level of sound before distortion occurs.

Film and video

DVDs are recorded using either film or video. Film is recorded at 24 frames per second, the rate movies are filmed at, although some recent progressive material is recorded at 30 frames per second.

Video is recorded at 30 frames per second.

Frame still and field still

A still is shown when you pause a moving picture. A frame still is made up of two alternating fields, so the picture may appear blurred, but overall quality is high. A field still is not blurred, but it has only half the information of a frame still so picture quality is lower. Frames are the still pictures that go together to make a moving picture.

There are about 30 frames shown each second.

One frame is made up of two fields. A regular television shows these fields one after the other to create frames.

Group

A DVD audio disc is divided into large sections called "groups" and smaller sections called "tracks". The numbers allocated to these sections are called "group numbers" and "track numbers".

Interlace and progressive output

NTSC, the video signal standard, has 525 interlaced (i) scan lines, whereas progressive scanning uses twice the number of scan lines.

This is called 525p. The 525i video signals output from this unit's COMPONENT VIDEO OUT terminals (Y, P_B / C_B, P_R/C_R) allow you to enjoy higher quality pictures than if the signals were output from the video output terminal or S VIDEO OUT terminal. The COMPONENT VIDEO OUT terminals are also able to handle 525p (progressive) video signals which are of even greater resolution.

I/P/B

MPEG, the video compression standard adopted for use with DVD-Video, codes frames using these 3 picture types.

I: Intra coded picture (I-picture)

This is the standard picture and is a complete picture in itself.

This means it has the best picture quality and is the best to use when adjusting the picture.

P: Predictive coded picture (P-picture)

This picture is calculated based on past I or P-pictures.

B: Bidirectionally-predictive coded picture (B-picture)

This picture is calculated by comparing past and future I and P-pictures so it has the lowest volume of information.

LFE 0.1 channel

This channel is for the reproduction of low bass signals. The frequency range for this channel is 20 Hz to 120 Hz. This channel is counted as 0.1 because it only enforces a low frequency range compared to the full-range reproduced by the other 5 channels in a Dolby Digital or DTS 5.1 channel systems.

Linear PCM (pulse code modulation)

PCM is the usual digital method used for music CDs. DVDs have a greater volume so they use linear PCM, which has a higher sampling rate. Compressed PCM signals are called packed PCM (PPCM).

Matrix 6.1

The unit incorporates Matrix 6.1 decoder for Dolby Digital and DTS multi-channel software that enables 6.1-channel reproduction by adding the rear center channel to existing 5.1-channel format. (The rear center channel is created from rear left and right channels, and outputted from virtual rear center speaker.) With this additional channel, you can experience more dynamic and realistic moving sound especially with scenes with "fly-over" and "fly-around" effects.

Pan&Scan/Letterbox

In general, DVD-Video are produced with the intention that they are viewed on a widescreen television with an aspect ratio of 16:9. This means you can view most material with the intended aspect ratio on a widescreen television.

Material with this ratio will not fit onto a standard television with an aspect ratio of 4:3. Two styles of picture, "Pan&Scan" and "Letterbox", deal with this problem.

Pan&Scan: The sides are cut off so the picture fills the screen.

Letterbox: Black bands appear at the top and bottom of the picture so the picture itself appears in an aspect ratio of 16:9.

Playback control (PBC)

If a Video CD has "playback control" written on it or its jacket, it means that particular scenes or information can be selected for viewing interactively with the television using the menu screen. This unit can play Video CDs with playback control.

Using menus to control play of a Video CD is called "menu play" in these operating instructions.

Sampling frequency and number of quantized bits

When digitizing an analog audio signal, the number of times the signal is sampled per second is called the sampling frequency, while the degree of fineness when converting the sound level into a numeric value is called the number of quantized bits.

SILENT CINEMA

YAMAHA has developed a natural, realistic sound effect DSP algorithm for headphones.

Parameters for headphones have been set for each sound field so that accurate representations of all the sound field programs can be enjoyed using headphones.

S video signal

With the S video signal system, the video signal normally transmitted using a pin cable is separated and transmitted as the Y signal for the luminance and the C signal for the chrominance through the S video cable. Using the S VIDEO jack eliminates video signal transmission loss and allows recording and playback of even more beautiful images.

Title/Chapter

DVD-Video are divided up into large sections, titles, and smaller sections, chapters. The numbers allocated to these sections are called title numbers and chapter numbers.

Track

This is the smallest division on DVD-Audio, CD, and Video CD, and usually equates to a single song.

Virtual CINEMA DSP

YAMAHA has developed a virtual CINEMA DSP algorithm that allows you to enjoy DSP sound field surround effects even without center or rear speakers by using virtual rear speakers.

SPECIFICATIONS

AUDIO SECTION

- **Minimum RMS Output Power**
FRONT L/R, CENTER, REAR L/R
1 kHz, 0.9% THD, 6 Ω 33 W
[U.S.A. and Canada models]
20 Hz to 20 kHz, 0.9% THD, 6 Ω 25 W
SUBWOOFER
100 Hz, 0.9% THD, 5 Ω 40 W
- **Maximum Power (EIAJ)**
FRONT L/R, CENTER, REAR L/R (1 kHz, 10% THD, 6 Ω) 40 W
SUBWOOFER (100 Hz, 10% THD, 5 Ω) 50 W
- **Total Harmonic Distortion**
FRONT L/R (20 W, 1 kHz) 0.05 %
- **Signal to Noise Ratio (IHF-A Network, shorted)** 95 dB
- **Input Sensitivity**
VIDEO 1, VIDEO 2, VCR, MD/CD-R 200 mV/47 kΩ
- **Output Level (when 200 mV is input.)**
PRE OUT (FRONT L/R, CENTER, REAR L/R) max. 1 V
PRE OUT (SUBWOOFER) max. 4 V
REC OUT 200 mV/1.2 kΩ
Headphones 165 mV/100 Ω

VIDEO SECTION

- **Video Signal Level**
Video 1 Vp-p/75 Ω
S Video (Y/C)
[U.S.A., Canada and General models] 1 Vp-p/0.286 Vp-p/75 Ω
[Australia, U.K. and Europe models] 1 Vp-p/0.3 Vp-p/75 Ω
Component (Y/P_B, P_R)
[U.S.A, Canada, General and Australia models]
..... 1 Vp-p/0.7 Vp-p/75 Ω
Signal to Noise Ratio 50 dB

TUNER SECTION

- **FM Tuning Range**
[U.S.A. and Canada models] 87.5 to 107.9 MHz
[Other models] 87.5 to 108.0 MHz
- **AM Tuning Range**
[U.S.A. and Canada models] 530 to 1710 kHz
[U.K., Europe and Australia models] 531 to 1611 kHz
[General model] 530/531 to 1710/1611 kHz

SPEAKER SECTION

- **Front and Rear Speakers**
Model Name NX-S100S
Type 2-way Bass reflex
Speakers
..... 10 cm (4 inch) cone, 1.9 cm (3/4 inch) balanced dome,
magnetically shielded
Impedance 6 Ω
- **Center Speaker**
Model Name NX-S100C
Type 2-way Bass reflex
Speakers 7 cm (3 inch) cone x 3, 1.5 cm (5/8 inch) piezo,
magnetically shielded
Impedance 6 Ω
- **Subwoofer**
Model Name SW-S100
Type Advanced YAMAHA Active Servo Technology system
Speaker 16 cm (6-1/2 inch) woofer, magnetically shielded

GENERAL

- **Power Supply**
[U.S.A. and Canada models] AC 120 V/60 Hz
[Australia model] AC 240 V/50 Hz
[U.K. and Europe models] AC 230 V/50 Hz
[General model] AC 220/240 V, 50 Hz
- **Power Consumption**
DVR-S100 40 W
SW-S100 160 W
- **Standby Power Consumption**
DVR-S100
[General model] 0.5 W
[Other models] 0.4 W
- **Laser pickup**
Wave length 665 nm
Laser power CLASS II
Laser output Max. 1.0 mW (Continuous)
Output value determined by 21 CFR CHAPTER 1,
SUBCHAPTER J
- **Dimensions (W x H x D)**
DVR-S100 435 x 84 x 360 mm
(17-1/8" x 3-3/8" x 14-3/16")
SW-S100 200 x 395 x 416 mm
(7-7/8" x 15-1/2" x 16-3/8")
NX-S100C 440 x 85 x 122 mm
(17-3/8" x 3-3/8" x 4-7/16")
NX-S100S 120 x 250 x 92 mm
(4-3/4" x 9-7/8" x 3-5/8")
- **Weight**
DVR-S100 6.0kg
(13 lbs 4 oz)
SW-S100 10.7kg
(23 lbs 9 oz)
NX-S100C 1.7kg
(3 lbs 12 oz)
NX-S100S 1.1kg
(2 lbs 6 oz)
- **Usable temperature range** 5°C to 35°C
- **Usable humidity range**
..... 5% to 90% (There should be no condensation.)
- **Accessories** Refer to page 3.

LIST OF MANUFACTURER'S CODES

TV

(Device Code: 2)

Yamaha	99	92
Admiral	92	93
Aiwa	94	76
Akai	95	96
Alba	96	
AOC	97	
Bell&iHowell	92	
Bestar	98	
Blaupunkt	29	22
Blue sky	98	
Brandt	23	
Brocsonic	97	
Bush	96	
Clatronic	98	
Craig	24	
Croslex	25	
Curtis Mathis	97	26
Daewoo	97	98 24 27 28
Daytron	39	
Dual	98	
Emerson	97	24 39 32
Ferguson	23	65 66
First line	98	
Funai	77	78
Fisher	95	33
Fraba	98	
GE	93	97 34 35 36
Goodmans	96	98 23
Grundig	29	38 49
Hitachi	97	39 42 43
ICE	96	
Irradio	96	
Itt/Nokia	44	45
JC Penny	93	97 34 37
JVC	96	46 47
Kendo	98	
KTV	97	39
LG (Goldstar)	97	98 39 37
Loewe	98	48
LXI	93	97 25 26 33
Magnavox	97	25 39
Matsui	95	
Mitsubishi	99	97 59
NEC	97	52 82
Nokia	44	45
Nokia Oceanic	45	
Nordmende	65	66
Onwa	96	
Panasonic	34	35 36 53
Philco	97	25 39
Philips	25	
Pioneer	26	35 54 55 68
Portland	97	56
Quasar	34	35
Radio Shack	99	93 97
RCA	93	97 34 56 57 58
SABA	23	69 65 66
Samsung	97	39 48 62 75
Sanyo	95	33 79 72 73 74
Schneider	96	
Scott	97	
Sharp	92	39 32
Siemens	29	
Signature	92	

Sony	63
Sylvania	97 25
Telefunken	69 64 65 66
Thomson	23 66
Toshiba	92 26 67
Videch	97 42
Wards	97 39 32

VCR

(Device Code: 3)

Yamaha	99	92	93	94
Admiral	95			
Aiwa	96	97	98	29
Akai	22	23	24	
Audio Dynamic	92	94		
Bell&iHowell	93			
Blaupunkt	25	26		
Brocsonic	27			
Bush	22			
Canon	25	28		
CGM	96	32		
Citizen	96			
Craig	96			
Curtis Mathis	97	28	33	
Daewoo	28	34	35	
DBX	92	94		
Dimensia	33			
Emerson	27	34		
Fisher	93	36		
Funai	97	88		
GE	28	33		
Goodmans	34	37		
Grundig	32	38		
Hitachi	25	33	49	42 43
Instant Replay	25	28		
Itt/Nokia	93			
JC Penny	92	93	94	28 33 49
JVC	92	94	44	45 46 47
Kendo	96			
Kenwood	92	94	96	
LG (Goldstar)	96			
Loewe	96	37		
Luxor	95			
LXI	93	96	97	36 49
Magnavox	25	26	28	
Marantz	92	94		
Marta	96			
Matsui	96			
Memorex	28	36		
Minolta	33	49		
Mitsubishi	99	44	48	59 52 53
Multitech	97	48	54	
NEC	92	94	44	83
Nokia	93	95		
Nokia Oceanic	95			
Okano	23			
Olympic	25	28		
Orion	27			
Panasonic	25	28	39	55 78 84 85
Pentax	33	49		
Philco	25	28		
Philips	25	26	28	37 56 57
Phonola	37			
Pioneer	25			
Quasar	25	28		
RCA/PROSCAN	25	26	28	33 35 49 58 69

Realistic	93	97	28	36	59	62
Samsung	54	58	63	64	65	66
Sansui	94					
Sanyo	93	36	67			
Schneider	37					
Scott	99	35	36	48	59	52 54 58
Seleco	22					
Sharp	95	62	82			
Siemens	93					
Signature 2000	95	97				
Sony	68	79	72	73	74	75
Sylvania	97	25	26	28		
Symphonic	97					
Tandberg	34					
Tashiro	96					
Tatung	92	94				
Teac	92	94	97			
Technics	25	28				
Telefunken	76	77				
Thorn	93	96				
Toshiba	35	69	89			
Universum	96	27	76			
W.WHouse	96					
Wards	95	96	36	62		

CDR

(Device Code: 4)

Yamaha	99		
Sony	27		
DENON	22	23	
JVC	25		
Kenwood	22		
Pioneer	26		
Marantz	22		
Philips	22		
Hitachi	24		

MD

(Device Code: 5)

Yamaha	99	98	22
Sony	22		
Denon	23	24	
JVC	25		
Kenwood	26		
Pioneer	27		
Sharp	28		



YAMAHA ELECTRONICS CORPORATION, USA 6660 ORANGETHORPE AVE., BUENA PARK, CALIF. 90620, U.S.A.
YAMAHA CANADA MUSIC LTD. 135 MILNER AVE., SCARBOROUGH, ONTARIO M1S 3R1, CANADA
YAMAHA ELECTRONIK EUROPA G.m.b.H. SIEMENSSTR. 22-34, 25462 RELLINGEN BEI HAMBURG, F.R. OF GERMANY
YAMAHA ELECTRONIQUE FRANCE S.A. RUE AMBROISE CROIZAT BP70 CROISSY-BEAUBOURG 77312 MARNE-LA-VALLÉE CEDEX02, FRANCE
YAMAHA ELECTRONICS (UK) LTD. YAMAHA HOUSE, 200 RICKMANSWORTH ROAD WATFORD, HERTS WD1 7JS, ENGLAND
YAMAHA SCANDINAVIA A.B. J A WETTERGRENS GATA 1, BOX 30053, 400 43 VÄSTRA FRÖLUNDA, SWEDEN
YAMAHA MUSIC AUSTRALIA PTY, LTD. 17-33 MARKET ST., SOUTH MELBOURNE, 3205 VIC., AUSTRALIA

YAMAHA CORPORATION
Printed in Malaysia **UP** VIDEO V883340